

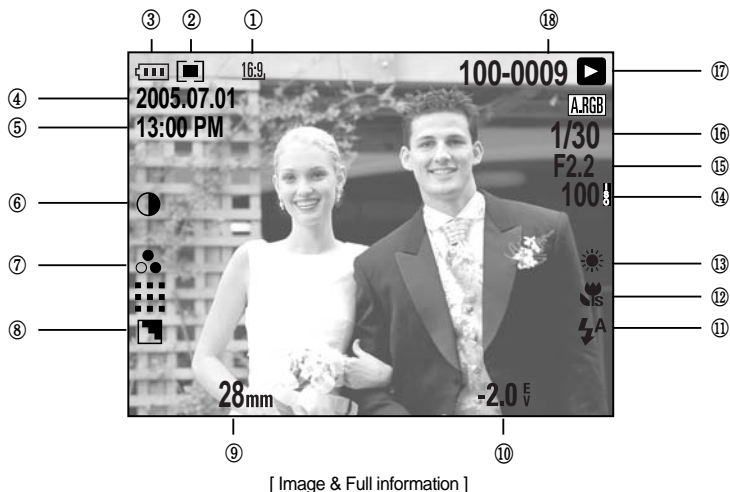















LCD monitor indicator

Rear LCD/ Finder LCD

- The LCD displays shooting information about the displayed image.
- Refer to page 00 for more information about selecting an LCD.



| No. | Description | Icon | Page |
|-----|-----------------------|---|---------|
| 1 | Image size | <u>L</u> , 3:2, 16:9, M1, M2, S1, S2, 640, 320, 160, | p.16 |
| 2 | Metering |    | |
| 3 | Battery status |     | p.11~12 |
| 4 | Date | 2005.07.01 | p.52 |
| 5 | Time | 13:00PM | p.34 |
| 6 | Contrast |  | |
| 7 | Saturation |  | |
| 8 | Quality | RAW TIFF    | |
| 9 | Sharpness |    | p.37 |
| 10 | F No. | 28mmx4.0 | p.32 |
| 11 | Exposure compensation | -2.0  | p.33 |

LCD monitor indicator

| | | | |
|----|-------------------------------------|-------------------------|------|
| 12 | Flash | | p.51 |
| 13 | Super Macro | | p.43 |
| 14 | White balance | AUTO | p.51 |
| 15 | ISO | AUTO 50 100 200 400 800 | |
| 16 | Aperture value | F2.2 | |
| 17 | Shutter speed | 1/30 | |
| 18 | Colour space | | |
| 19 | Play mode | | |
| 20 | Folder name and Stored image number | 100-0009 | |

Top LCD

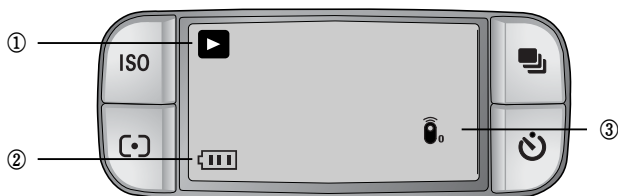

| No. | Description | Icon | Page |
|-----|----------------|------|------|
| 1 | Play mode | | p.51 |
| 2 | Battery status | | p.00 |
| 3 | Remote control | | |

Thumbnail button/ Enlarge button

- In Play mode, you can use the buttons and the jog dial on the camera to conveniently set up the Play mode functions.
- You can view multiple pictures, enlarge a selected picture, and crop and save a selected area of an image.
- Thumbnail display
 1. While an image is displayed full screen, press the Thumbnail button().
 2. The thumbnail display will highlight the image that had been showing at the time the thumbnail mode was selected.

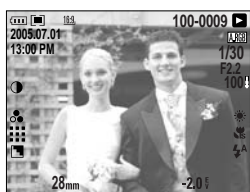

[Normal display mode]

Pressing the Thumbnail button ()

Pressing the Enlargement button ()

Highlighted image



[Thumbnail display mode]

3. Change the number of thumbnail by rotating the Front jog dial (JOG1). You can select 4, 9, 16, 25 thumbnail.
 - Rotating the Front jog dial to left will reduce the number of thumbnail.
 - Rotating the Front jog dial to right will increase the number of thumbnail.
4. Rotate the Rear jog dial (JOG2) or press the Up/ Down/ Left/ Right button to move to a desired image.

● Image enlargement

1. Select an image that you want to enlarge and press the Enlargement button(). Enlarge the image by rotating the Rear jog dial (JOG2).
2. You can change the enlargement rate by rotating the Rear jog dial (JOG2).
 - Rotating the Rear jog dial to right will increase the enlargement rate.
 - Rotating the Rear jog dial to left will reduce the enlargement rate.
3. Different parts of the image can be viewed by pressing the Up/ Down/ Left/ Right button.



Thumbnail button/ Enlarge button

- The maximum enlargement rate in proportion to the image size.

| Image size | <u>L</u> | <u>3:2</u> | <u>16:9</u> | <u>M1</u> | <u>M2</u> | <u>S1</u> | <u>S2</u> |
|--------------------------|----------|------------|-------------|-----------|-----------|-----------|-----------|
| Maximum enlargement rate | × 10.20 | × 10.20 | × 10.20 | × 6.82 | × 4.64 | × 4.00 | × 3.33 |

INFORMATION

- You can tell whether the image displayed is an enlarged view by checking the image enlargement indicator shown at the bottom left of the LCD. (If the image is not an enlarged view, the indicator will not be displayed.) You can also check the area of enlargement.
 - RAW, TIFF and Movie clip files can't be enlarged.
 - If an image is enlarged, a loss of quality may occur.
 - During the image enlargement, you can delete the image by pressing the delete button.
-
- Trimming : You can extract part of the image that you want and save it separately.
 1. Enlarge an image by rotating the Rear jog dial (JOG2) and press the Menu button.
 2. Press the Menu button and a message will display to crop the image.
 3. Select a desired sub menu by pressing the Up/Down button and press the OK button.
 - [Yes] : The trimmed image will save as a new file name, and display on the LCD.
 - [No] : The trimming menu will disappear.

※ If there is little memory space to save the trimmed image, the image can't be trimmed.

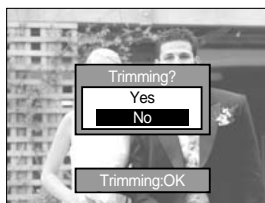



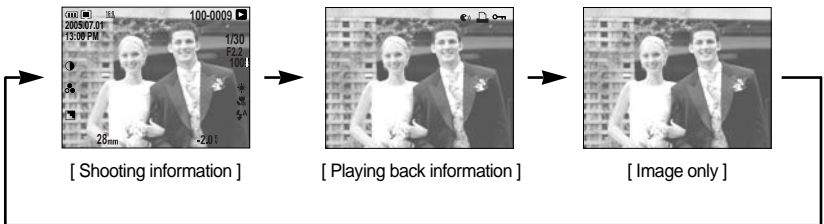
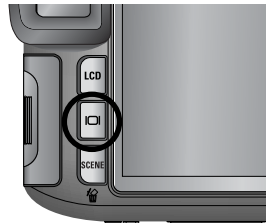

Display/ Information button ()

- The shooting and playing back information will be displayed on the LCD. The last image stored in the memory is displayed on the LCD by pressing the play mode button.
- Pressing the Display/ Information button() in the PLAY mode will change the display as shown below.

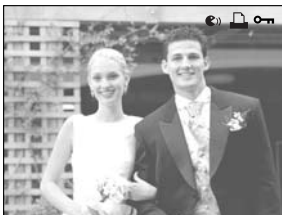

- Refer to page 00 for more information about the shooting information.
- The followings are playing back information.



- [] : Voice memo
- [] : DPOF indicator
- [] : Protect indicator

Album mode

- You can organise the captured still images into albums.
- This camera has 8 albums and each album can take up to 100 images.
- The album menu loading time depends on the memory card type.

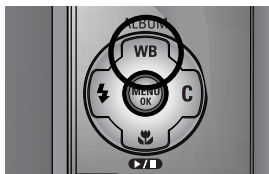

■ How to use the album

● Selecting the album

1. In the play mode, press the Album (Up) button.
2. Select the [] menu by pressing the Up/ Down button and press the Right button.
3. Select a desired album by pressing the Up/ Down/ Left/ Right buttons and press the OK button.

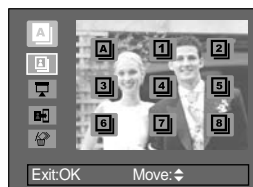

● Inserting still images into the album

1. Select an album.
2. Select the [] menu by pressing the Up/ Down button and press the Right button.



Album mode

3. Select the still images you wish to add by pressing the Up/Down/Left/Right buttons and rotate the Front jog dial (JOG1).

V marks are displayed on the selected images.

- * To cancel the selection, rotate the Front jog dial (JOG1) again.

4. Press the OK button and a confirmation window will display. Select a desired sub menu by pressing the Up/ Down button and press the OK button.

[Yes] : Inserts the selected images into the album.

[No] : Cancels the inserting images.

● Removing still images from the album

1. Select an album.

2. Select the [] menu by pressing the Up/ Down button and press the Right button.

3. Select a desired sub menu and press the OK button.

- [Select] : Specific still images in the album can be removed.

- [All] : All of the still images in the album will be removed.

※ If [Select] is selected :

- Select images that you want to remove by pressing the Left/ Right buttons and rotate the Front jog dial (JOG1). V marks are displayed on the selected images.

4. Press the OK button and a confirmation window will display. Select a desired sub menu by pressing the Up/ Down button and press the OK button.

[Yes] : Removes the selected images from the album.

[No] : Cancels the removing images.

* The removed images are not deleted from the memory, but just removed from the album.



Album mode

- Playing back the albums

- Playing back all of the albums

1. Select [**A**] menu and press the OK button.

All of the albums will be selected.

2. Select the [] menu by pressing the Up/ Down button and press the Right button.

※ You can select [Start], [Interval], [Repeat] and [Effect] menus.

- [Start] : Start the slide show

- [Interval] : Set the slide show play interval

- [Repeat] : Choose to repeat the slide show after finishing the first cycle.

- [Effect] : Unique screen effects can be used for the slide show.

3. Select the [Start] menu by pressing the Up/ Down button and press the OK button to start the slide show.

4. To stop the slide show, Press the Play & Pause button and MENU/OK button.

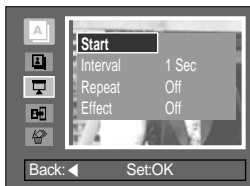
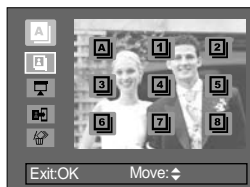

- Playing a desired album

1. Select a desired album and press the OK button.

2. Select the [] menu by pressing the Up/ Down button and press the Right button.

※ You can Select the [Start], [Interval], [Repeat] and [Effect] menu.

3. Select the [Start] menu and press the OK button to start the slide show.

4. To stop the slide show, press the Play & Pause button and MENU/ OK button.



확인 요

INFORMATION

- If an image is deleted from the memory, the image doesn't display on an album.
- An image can't be added twice into the same album.
- An image can be added into the different albums.

5-function button

- 5-function button activate the following.
 - Up button : While the menu is showing, press the Up button to move up the menu cursor. When the menu is not displayed on the LCD, the Up button operates as the Album button.
 - Down button : While the menu is showing, press the Down button to move down the menu cursor. If a still image with a voice memo or a movie clip is playing, pressing the Down button make the files play back or pause.
 - Left button : While the menu is showing, press the Left button to select the menu tab to the left of the cursor. When the menu is not displayed, press the Left button to select the previous image.
 - RIGHT button : While the menu is showing, press the Right button to select the menu tab to the right of the cursor. When the menu is not displayed, press the Right button to select the next image.
 - Menu/OK button : When the menu is displayed on the LCD, the Menu/ OK button is used for confirming data that is changed by using the 5 function button. When you press the MENU button, the play mode menu will be displayed on the LCD monitor. Pressing it again will return the LCD to the initial display.

Remote control

- After connecting the camera with a external monitor or computer, you can see the captured image by using the remote control.

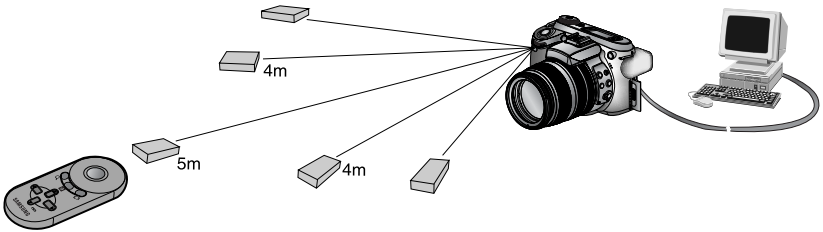

- In play mode, you can use the remote control to set up the play mode functions.

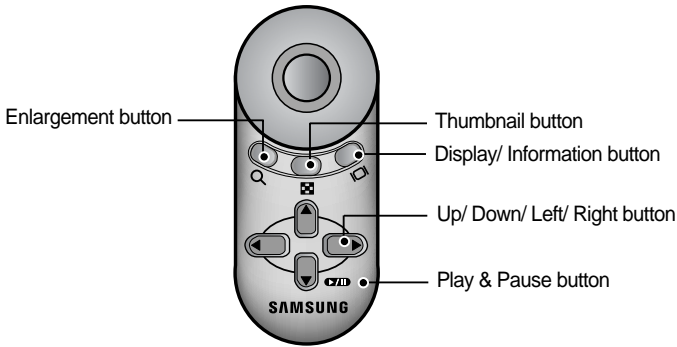

- See below for operation of buttons

- Enlargement button : In play mode, this button enlarges the selected image.
In the thumbnail mode, the number of thumbnails are increased by pressing this button (Selectable number of thumbnail : 4, 9, 16, 25).
- Thumbnail button : If an image is enlarged, pressing this button will reduce the enlargement rate. In play mode, you can view multiple pictures by pressing this button. In the thumbnail mode, the number of thumbnails are reduced by pressing this button (Selectable number of thumbnail : 4, 9, 16, 25).
- Display/ Information button : In play mode, you can view the information of the selected image by pressing this button.

Remote control

- Up/ Down/ Left/ Right button : In play mode, different parts of the enlarged image can be viewed by pressing these buttons. In the thumbnail mode, you can move to a desired image by pressing these buttons.
- Play & Pause button : If a still image with a voice memo or a movie clip is playing, pressing this button make the files play back or pause.

Delete button ()

- This deletes images stored on the memory.
- Deleting Images in Play Mode
 1. Select an image that you want to delete by pressing the Left/ Right button and press the Delete () button.
 2. A message will display as shown alongside on the LCD.
 3. Select the [Delete] menu and press the OK button to delete the selected image.



INFORMATION

- Before deleting images from the camera, you should protect (p.77) or download images (p.121) to your computer that you wish to keep.

Setting up the play back function using the LCD monitor

- PLAY mode functions can be changed by using the LCD monitor.

Press the Menu button and select the [▶] menu tab. The play back menu will display.

The menus you can set up in Play mode are as follows. To capture an image after setting up the play menu, press the Play mode button or shutter button.

| Menu tab | Main menu | Sub menu | Secondary menu | Page | |
|----------------|--------------------------|------------|-----------------|-------|--------------|
| ▶ | Slide Show | Interval | 1, 3, 5, 10 sec | p. 76 | |
| | | Repeat | Off, On | | |
| | | Effect | Cancel | | Effect 1,2,3 |
| | | | Effect 1,2,3 | | |
| | | Start | - | | |
| | Protect | Select | Unlock/ Lock | p. 77 | |
| | | All Pics | | | |
| | Delete | Select | - | p. 78 | |
| | | All Pics | - | | |
| | Voice Memo | Off | | | |
| | | On | | | |
| | Resize | 7M | - | p. 79 | |
| | | 6M | - | | |
| | | 5M | | | |
| | | 4M | - | | |
| | | 3M | - | | |
| | | 2M | | | |
| | | 1M | | | |
| | | 640X480 | | | |
| | | User Image | - | | |
| | Rotate | Right 90° | - | p. 80 | |
| Left 90° | | - | | | |
| 180° | | - | | | |
| DPOF/ Standard | Select/ All Pics/ Cancel | - | p. 81 | | |
| DPOF/ Index | No/ Yes | | | | |
| DPOF/ Size | Select/ All Pics/ Cancel | | | | |

Setting up the play back function using the LCD monitor

- This menu is available while the camera is connected to a PictBridge supporting printer (direct connection to the camera, sold separately) with a USB cable.

| Menu tab | Main menu | Sub menu | Secondary menu | Page |
|---|------------|------------|----------------|-------|
|  | Images | One Pic | - | p. 84 |
| | | All Pics | - | |
| | Auto Set | No | - | p. 85 |
| | | Yes | - | |
| | Custom Set | Paper Size | Auto | p. 85 |
| | | | Postcard | |
| | | | Card | |
| | | | 4X6 | |
| | | | L | |
| | | | 2L | |
| | | | Letter | |
| | | | A4 | |
| | | A3 | | |
| | | Layout | Auto | |
| | | | Full | |
| | | | 1 | |
| | | | 2 | |
| 4 | | | | |
| 8 | | | | |
| Paper Type | 9 | | | |
| | 16 | | | |
| | Auto | | | |
| | Plain | | | |
| Photo | | | | |
| Fastphoto | | | | |

Setting up the play back function using the LCD monitor

| Menu tab | Main menu | Sub menu | Secondary menu | Page |
|---|------------|------------|----------------|-------|
|  | Custom Set | Quality | Auto | p. 85 |
| | | | Draft | |
| | | | Normal | |
| | | | Fine | |
| | | Date Print | Auto | |
| | | | Off | |
| | | | On | |
| | | File Name | Auto | |
| | | | Off | |
| | On | | | |
| | Print | Standard | - | p. 86 |
| | | Index | - | |
| | DPOF Print | No | - | p. 86 |
| | | Yes | - | |
| Reset | No | - | p. 87 | |
| | Yes | - | | |

※ Menus are subject to change without prior notice.

Starting the slide show

- Images can be displayed continuously at pre-set intervals. You can view the slide show by connecting the camera to an external monitor.

1. In play mode, press the Menu button and select the [▶] menu tab.
2. Press the Right button and select the [Slide Show] menu by pressing the Up/ Down button.
3. Press the Right button and select a desired sub menu by pressing the Up/ Down button.



- Setting play interval : Set the slide show play interval.

1. Select the [Interval] menu by pressing the Up/ Down button and press the Right button.
2. Press the Up/ Down button to select the desired interval.
3. Press the OK button to set the setting.

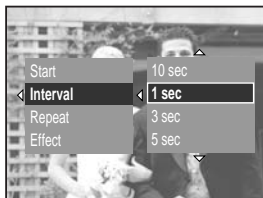

- Repeat setting : setting the slide show to repeat after the first cycle.

1. Select the [Repeat] menu by pressing the Up/ Down button and press the Right button.
2. Select a desired sub menu by pressing the Up/ Down button.
[On] selected : The slide show is repeated until cancelled.
[Off] Selected : The slide show is closed after one cycle.
3. Press the OK button to set the setting.



INFORMATION

- The loading time depends on the image size and quality.
- While the slide show is playing, only the first frame of a movie clip file is displayed.

Starting the slide show

- Configure slide show effects : Unique screen effects can be used for the slide show.
 1. Select the [Effect] sub menu by pressing the Up/ Down button and press the Right button.
 2. Use the Up/ Down button to select the type of effect.

[Off] : Normal display.

[Effect 1] : Image moves from the top left.

[Effect 2] : The image slides diagonally from top left to bottom right.

[Effect 3] : Image is displayed slowly from the centre outwards.
 3. Press the OK button to set the setting.

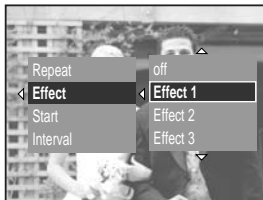

- Start the slide show : The slide show can start only in the [Start] menu.
 1. Select the [Start] menu by pressing the Up/ Down button.
 2. Press the OK button to start the slide show.
 - Press the Play & Pause button to pause the slide show.
 - Press the Play & Pause button () again to resume the slide show.
 - To stop the slide show, press the Play & Pause button, and then press the Left or Right button.



Protecting images

- This is used to protect specific shots from being accidentally erased (Lock). It also unprotects images that have been previously protected (Unlock).

● How to protect images

1. In play mode, press the Menu button.
2. Select the [▶] menu tab and press the Right button.
3. Select the [Protect] menu by pressing the Up/ Down button and press the Right button.
4. Select a desired sub menu by pressing the Up/ Down button and press the Right button.

[Select] : Selection window for an image to be protected/ released is displayed.

- Rear jog dial (JOG2) : Select an image
- Front jog dial (JOG1) : Protect/ release the image
- OK Button : Your changes will be saved and the menu will disappear.

[All Pics] : Protect/ release all saved images

- [Lock] : Protect all saved images
- [Unlock] : Unprotect all save images
- [Cancel] : The confirmation window will disappear.
- OK button : The changed settings are saved and menu will disappear.

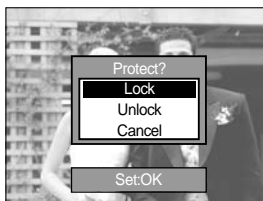

- If you protect an image, the protect icon will be displayed by pressing the Display/ Information button on the LCD. (An unprotected image has no indicator)

- An image in LOCK mode will be protected from the delete function, but will NOT be protected from the Format function.



Deleting images

- Of all the files stored in the memory card, the unprotected files in the DCIM subfolder will be deleted. Remember that this will permanently delete unprotected images. Important shots should be stored on a computer before deletion takes place.

The startup image is stored in the camera's internal memory (i.e., not on the memory card) and it will not be deleted even if you delete all files on the memory card.

● How to delete images

- In play mode, press the Menu button.
- Select the [▶] menu tab and press the Right button.
- Select the [Delete] menu and press the Right button.
- Select a desired sub menu by pressing the Up/ Down button and press the Right button.

[Select] : Selection window for an image to delete is displayed.

- Rear jog dial (JOG2) : Select an image.
- Front jog dial (JOG1) : Select the image for deletion.
- OK button : Press the OK Button to display the confirmation message. Select the [Yes] menu and press the OK Button again to delete [🗑️] marked images.

[All Pics] : Displays confirmation window. Select the [Yes] menu and press the OK button to delete all unprotected images. If there are no protected images, a [No Image!] message will display.

- After deletion, the screen will be changed to the play mode screen.

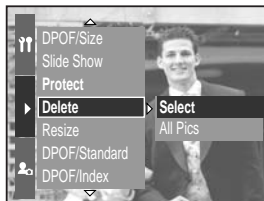

Voice memo

- You can add your voice to a stored still image.
- How to add a voice to a still image
 1. Select an image that you wish to add sound to by pressing the Left/ Right button.
 2. Select the [▶] menu by pressing the Menu button and press the Right button.
 3. Select the [Voice Memo] menu by pressing the Up/ Down button and press the Right button.
 4. Select the [On] menu by pressing the Up/ Down button and press the OK button.
- 5. The camera is now ready to record a voice memo.



6. Press the shutter button to start recording and voice will be recorded to the still image for 10 seconds. While the voice is recording, the recording status window will be displayed as shown alongside.
7. The recording can be stopped by pressing the shutter button again.

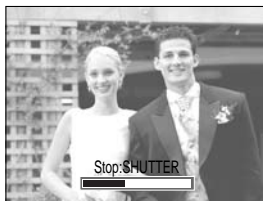
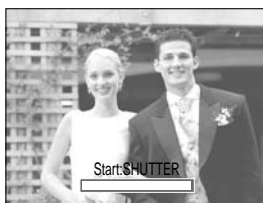

8. The (📷) icon will be displayed on the LCD by pressing the Display/ Information button after voice memo recording has finished.
 - Voice memos can't be recorded onto movie clip files.
 - A distance of 40cm between you and the camera (microphone) is the best distance to record sound.
 - The voice memo will be saved in *.wav format, but has the same file name as the still image to which it corresponds.
 - If you add a new voice memo to the still image that already has a voice memo, the existing voice memo will be erased.



Resize

- Change the resolution (size) of pictures taken. Select the [User Image] to save an image to be the start-up image. The resized image will have a new file name.
 1. In play mode, press the Menu button and select the [▶] menu tab.
 2. Press the Right button and select the [Resize] menu by pressing the Up/ Down button.
 3. Press the Right button and select a desired sub menu by pressing the Up/ Down button.
 4. Press the OK button and a confirmation window will display.
 5. Select the [Yes] menu and press OK button to save the resized image.

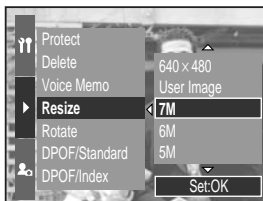

● Image Resize Types

| Size | 7M | 6M | 5M | 4M | 3M | 2M | 1M | 640 X480 | 사용자 이미지 |
|-----------|----|----|----|----|----|----|----|----------|---------|
| 3264X2448 | O | O | O | O | O | O | O | O | O |
| 3264X2176 | X | X | X | X | X | X | X | X | X |
| 3264X1840 | X | X | X | X | X | X | X | X | X |
| 2400X1800 | X | X | X | O | O | O | O | O | O |
| 1632X1224 | X | X | X | X | X | O | O | O | O |
| 1024X768 | X | X | X | X | X | X | X | O | O |
| 640X480 | X | X | X | X | X | X | X | X | O |

INFORMATION

- A large sized image can be resized to a smaller sized image, but not vice versa.
- 3264X2176(3:2) and 3264X1840(16:9) image size files, TIFF, Movie clip (AVI) files can't be resized.
- You can change the resolution of only those files compressed in the JPEG 4:2:2 format.
- The resized image will have a new file name. The [User Image] image is stored not on the memory card but on the internal memory.
- If the memory capacity is insufficient to store the resized image, a [Card Full!] message will display on the LCD and the resized image will not be stored.

Rotating an image

- You can rotate the stored images by various degrees.

1. In play mode, press the Menu button and select the [▶] menu.
2. Press the Right button and select the [Rotate] menu by pressing the Up/ Down button.
3. Press the Right button and select a desired sub menu by pressing the Up/ Down button.

[Right 90°] : Rotate picture in a clockwise direction

[Left 90°] : Rotate picture in a counter clock-wise direction

[180°] : Rotate picture 180 degrees

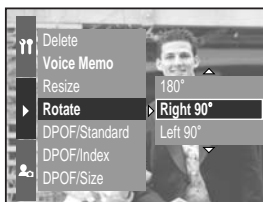

[Right 90°]



[Left 90°]



[180°]

4. Press the OK button and a confirmation window will display.
5. Select the [Yes] menu and press the OK button. A rotated image will display on the LCD and the menu will disappear. There will be empty space to the left and right of the rotated image.

INFORMATION

- The rotated image can't be enlarged or trimmed.
- RAW, TIFF and movie clip can't be rotated.

DPOF

- DPOF(Digital Print Order Format) allows you to embed printing information on your memory card's MISC folder. Select the pictures to be printed and how many prints to make.
- The DPOF indicator will display on the LCD when an image that has DPOF information plays back. Images can then be printed on DPOF printers, or at an increasing number of photo labs.
- This function is not available for Movie clips and Voice recording files.

DPOF : STANDARD

- This function allows you to embed print quantity information on a stored image.

1. In play mode, press the Menu button.
2. Select [▶] menu tab and press the Right button.
3. Select the [DPOF/Standard] menu by pressing the Up/Down button and press the Right button.
4. Select a desired sub menu by pressing the Up/Down button and press the Right button.

[Select] : Selection window for an image to print is displayed.

- Rear jog dial (JOG2) : Select an image to print.
- Front jog dial (JOG1) : Select the number of prints.

[All Pics] : Configure number of prints for all pictures except movie and voice files.

- Front jog dial (JOG1) : Select the number of prints.

[Cancel] : Cancel the print setup.

5. Press the OK button to confirm the setting. If an image carries DPOF instructions, the DPOF indicator () will show.



DPOF : INDEX

- Images (except for movie clips and voice file) are printed as index type.
 1. In play mode, press the Menu button and select the [▶] menu tab.
 2. Press the Right button and select the [DPOF/Index] menu by pressing the Up/ Down button.
 3. Press the Right button and select a desired sub menu by pressing the Up/Down button.
 - If [No] is selected : Cancel the index print setting.
 - If [Yes] is selected : The image will be printed in index format.
 4. Press the OK button to set the setting.



DPOF : PRINT SIZE

- You can specify the print size when printing images stored on the memory card. The [DPOF/Size] menu is available only for DPOF 1.1 compatible printers.

● Setting the Print Size

1. In play mode, press the Menu button.
2. Select [▶] menu tab and press the Right button.
3. Select the [DPOF/Size] menu by pressing the Up/ Down button and press the Right button.
4. Select a desired sub menu by pressing the Up/ Down button and press the Right button.

[Select] : Selection window for an image to be changed printed size is displayed.

- Rear jog dial (JOG2) : Select an image.
- Front jog dial (JOG1) : Change the print size.
- OK button : Your changes will be saved and the menu will disappear.

[All Pics] : Change print size of all saved images

- Select a desired print size by pressing the Up/ Down button.

* DPOF Size secondary menu : Cancel, 3X5, 4X6, 5X7, 8X10

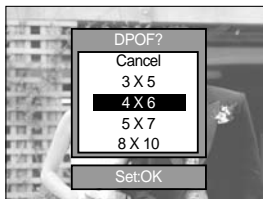

PictBridge

- You can use the USB cable to connect this camera to a printer that supports PictBridge (sold separately) and print the stored images directly. RAW, TIFF and Movie clip files cannot be printed. You can set up the following settings from the PictBridge menu.

| | |
|---------------------|---|
| Images | : Select the pictures to be printed. |
| Auto Set/Custom Set | : Setting up printing |
| Print | : Printing pictures |
| DPOF Print | : Printing the DPOF files |
| Reset | : Initialising the PictBridge functions |

Connecting the Camera to a Printer

● Connecting the Camera to a Printer

1. Press the POWER button to turn on the camera.
2. Press the Menu button and select the set up menu tab ().
3. Press the Right button and select the [USB] menu by pressing the Up/ Down button.
4. Press the Right button and select the [Printer] menu by pressing the Up/ Down button.
5. Press the OK button to set the setting.
6. Use the supplied USB cable to connect the camera to the printer as shown below.
7. Turn on the printer and the camera will be connected to the printer.

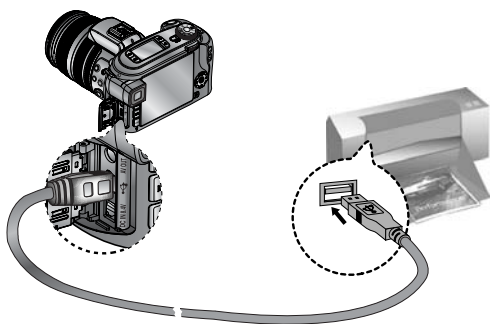
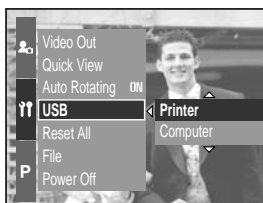

※ If you selected [Computer] in Step 4, when you connect the camera to your printer, the [Connecting...] message will display and the connection will not be established. In this case, disconnect the USB cable, and then follow the procedure from Step 2 and onward.

PictBridge : Picture Selection

■ Easy printing

When you connect the camera to printer in the Play back mode, you can print a picture easily.

- Pressing the shutter button : Currently displayed image will be printed with the printer's default setting.
- Pressing the Left/ Right button : Selects a previous/ next image.



■ Select pictures to print

1. Connect the camera to your printer. The USB menu must be set to [Printer] before you connect the camera to the printer. (See p.83)
2. Press the Menu button and select the [] menu tab by pressing the Up/ Down button.
3. Press the Right button and select the [Images] menu by pressing the Up/ Down button.
4. Press the Right button and select a desired sub menu by pressing the Up/ Down button.

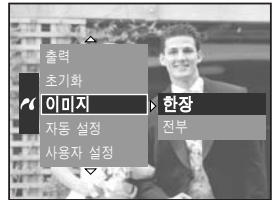

When [One Pic] is selected : The PictBridge function will be applied only to the picture currently displayed.

When [All Pics] is selected : The PictBridge function will be applied to all pictures, excluding RAW, TIFF and movie clips files.

● Setting the Number of Copies to Print

- Select [One Pic] or [All Pics]. A screen where you can set the number of copies to print will appear as shown below.



[When [One Pic] is selected]

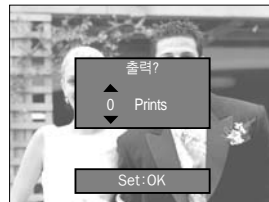

[When [All Pics] is selected]

- Press the Up/ Down button to select the number of prints.
- When you select [One Pic] menu, use the Left/ Right button to select another picture and select the number of prints for another picture.
- After setting the number of prints, press the OK button to save.

PictBridge : Print Setting

■ AUTO SET

1. Connect the camera to your printer. The USB menu must be set to [Printer] before you connect the camera to the printer. (See p.83)
2. Select the [Auto Set] menu by pressing the Left/ Right button.
3. Press the Right button and select a desired sub menu by pressing the Up/ Down button.



[No] : [Custom Set] values are kept.

[Yes] : Press the OK button and a confirmation window will display. Press the OK button again and all values in the [Custom Set] are automatically changed.

■ Custom Set : You can select the Paper Size, Print Format, Paper Type, Print Quality, Date, Print, and File Name Print menus for printed pictures.

1. Connect the camera to your printer. The USB menu must be set to [Printer] before you connect the camera to the printer. (See p.83)
2. Select the [Auto Set] menu by pressing the Left/ Right button.
3. Press the Right button and select a desired sub menu by pressing the Up/ Down button.
4. Select a desired sub menu and press the OK button.



The menus you can set up are as follows :

| Menu | Function | Sub menu |
|------------|--|--|
| Paper Size | Setting the size of the printing paper | Auto, Postcard, Card, 4X6, L, 2L, Letter, A4, A3 |
| Layout | Setting the number of pictures to be printed on a sheet of paper | Auto, Full, 1, 2, 4, 8, 9, 16 |
| Paper Type | Setting the quality of the printing paper | Auto, Plain, Photo, Fastphoto |
| 출력 화질 | Setting the quality of the picture to be printed | Auto, Draft, Normal, Fine |
| Date Print | Setting whether to print the date | Auto, Off, On |
| File Name | Setting whether to print the file name | Auto, Off, On |

※ Some menu options are not supported in all manufacturer and printer models.

※ If the setting values are not changed in the automatic/manual setting, the setting values are automatically kept.

PictBridge : Printing

■ Printing Pictures

1. Connect the camera to your printer. The USB menu must be set to [Printer] before you connect the camera to the printer. (See p.83)
2. Select the [Print] menu by pressing the Left/ Right button.
3. Press the Right button and select a desired sub menu by pressing the Up/ Down button.

[Standard] : Print the pictures stored in the memory card in set numbers. One picture is printed on one piece of paper.

[Index] : Print multiple images on one sheet of paper.



4. The screen shown on the right will appear and the picture will be printed. If no picture is selected, the [No image!] message will be displayed. Press the Menu/ OK button while printing to cancel the printing and the [Print] menu is displayed.

※ Depending on the manufacturer and printer model, some menus may not be available.

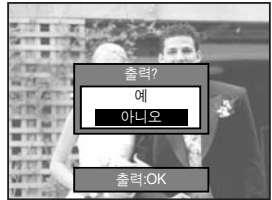

■ DPOF Print : This allows you to directly print the files with DPOF information.

1. Connect the camera to your printer. The USB menu must be set to [Printer] before you connect the camera to the printer. (See p.83)
2. Select the [DPOF Print] menu by pressing the Left/ Right button.
3. Select a desired sub menu by pressing the Up/Down button and press the OK button.

[No] : Cancel the printing

[Yes] : Directly print the file with the DPOF information

※ With a printer without supporting the DPOF, the menu is still displayed but not available.



PictBridge : RESET

- Initialises user-changed configurations.

1. Connect the camera to your printer. The USB menu must be set to [Printer] before you connect the camera to the printer. (See p.83)
2. Select the [Reset] menu by pressing the Left/ Right button.
3. Press the Right button and select a desired sub menu by pressing the Up/ Down button.

If [No] is selected : Settings will not be reset.

If [Yes] is selected : Press the OK button and a confirmation window will display.

Press the OK button again and all print and image settings will be reset.



※ Default print setting varies depending on the printer manufacturer.

For your printer's default setting, refer to the user's guide that came with your printer.

Setup menu

- In this mode, you can set up basic settings.
The items indicated by default settings.

| Menu tab | Main menu | Sub menu | Secondary menu | Page | |
|---|-------------|-------------------------|----------------|---------------------|------|
|  | File | Series | - | p.89 | |
| | | Reset | - | | |
| | Power Off | Off, 1, 3, 5 10 min | - | p.90 | |
| | LCD Off | Off, 10, 20, 30, 60 sec | - | p.90 | |
| | Language | ENGLISH | 한국어 | FRANÇAIS | p.91 |
| | | DEUTSCH | ESPAÑOL | ITALIANO | |
| | | 简体中文 | 繁體中文 | 日本語 | |
| | | П'СCK»... | PORTUGUÊS | DUTCH | |
| | | DANSK | SVENSKA | SUOMI | |
| | | Type A | | | |
| | | ไทย | BAHASA | عربي | |
| | | Type B | | | |
| | Čeština | POLSKI | Magyar | | |
| | Format | No | | - | p.91 |
| | | Yes | | - | |
| | Date & Time | 00/00/00 00:00 | | - | p.92 |
| | Date Type | yy/mm/dd | | - | |
| | | mm/dd/yy | | - | |
| | | dd/mm/yy | | - | |
| | World Time | Cape Verde | | Tashkent | p.92 |
| | | London | | Almaty | |
| | | Rome, Paris, Berlin | | Bangkok, Jakarta | |
| | | Athens, Helsinki | | Beijing , Hong Kong | |
| | | Moscow | | Seoul, Tokyo | |
| | | Abu Dhabi | | Guam, Sydney | |

Setup menu

| Menu tab | Main menu | Sub menu | Secondary menu | Page |
|---|---------------|-----------------------|----------------------|------|
|  | World Time | Okhotsk | Denver, Phoenix | p.93 |
| | | Wellington, Auckland | Chicago, Dallas | |
| | | Samoa, Midway | New York, Miami | |
| | | Honolulu, Hawaii | Caracas, La Paz | |
| | | Alaska | Buenos Aires | |
| | | LA, San Francisco | Mid-Atlantic | |
| | Imprint | Off | - | p.93 |
| | | Date | | |
| | | Date & Time | | |
| | Sound | Off | Low | p.94 |
| | | Medium | High | |
| | Brightness | Main LCD | Bright, Normal, Dark | p.94 |
| | | EVF | | |
| | | Top LCD | | |
| | Video Out | NTSC | - | p.94 |
| | | PAL | | |
| | Quick View | Off, 0.5, 1, 3, 5 sec | - | p.95 |
| | Auto Rotating | Off | - | p.96 |
| | | On | | |
| | USB | Computer | - | p.96 |
| Printer | | | | |
| Reset | No | - | p.96 | |
| | Yes | | | |

* Menus are subject to change without prior notice.

File name

- This function allows the user to select the file naming format.

- How to set the file names

1. Press the Menu button and select the [] menu tab by pressing the Up/ Down button.
2. Press the Right button and select the [File] menu by pressing the Up/ Down button.
3. Press the Right button and select a desired sub menu by pressing the Up/ Down button.

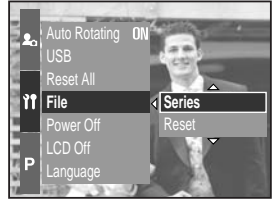

[Series] : New files are named using numbers that follow the previous sequence, even when a new memory card is used, or after formatting, or after deleting all pictures.

[Reset] : After using the reset function, the next file name will be set from 0001 even after formatting, deleting all or inserting a new memory card.

4. Press the OK button to set the setting.

INFORMATION

- The first stored folder name is 100SSCAM, and the first file name is SH100001.
- File names are assigned sequentially from SH100001 → SH100002 → ~ → SH100099. But, files that was saved as the Adobe RGB type are assigned as _H1xxxx.
- The folder number is assigned sequentially from 100 to 999 as follows : 100SSCAM → 101SSCAM → ~ → 999SSCAM.
- The files used with the memory card conform to the DCF(Design rule for Camera File systems) format.

Auto power off

- This function switches the camera off after a set amount of time in order to prevent unnecessary battery drainage.

- How to set the Auto power Off

1. Press the Menu button and select the [] menu tab by pressing the Up/ Down button.
2. Press the Right button and select the [Power Off] menu by pressing the Up/ Down button.
3. Press the Right button and select a desired sub menu by pressing the Up/ Down button.

[Off] : The power off function will not operate.

[1, 3, 5, 10 min] : The power will turn off automatically if not used for the period of time specified.

4. Press the OK button to set the setting.

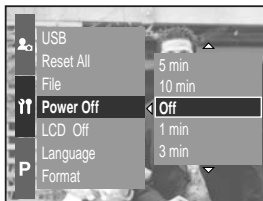

INFORMATION

- Even if the battery or AC adapter are removed and inserted again, the power off setting will be preserved.
- Note that the automatic power off function will not operate if the camera is in PC mode, slide show, playing back a movie clip.

Auto turning off the LCD

- This function switches the LCD off after a set amount of time in order to prevent unnecessary battery drainage.

- How to set the auto turning off time

1. Press the Menu button and select the [] menu tab by pressing the Up/ Down button.
2. Press the Right button and select the [LCD Off] menu by pressing the Up/ Down button.
3. Press the Right button and select a desired sub menu by pressing the Up/ button.

[Off] : The LCD will not turn off.

[10, 20, 30, 60 sec] : The LCD will turn off automatically if not used for the period of time specified.

4. Press the OK button to set the setting.

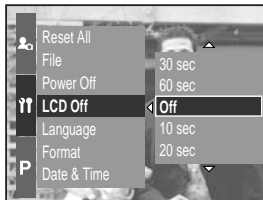

INFORMATION

- Even if the battery or AC adapter are removed and inserted again, the auto LCD turning off setting will be preserved.
- Note that the automatic power off function will not operate if the camera is in PC mode, slide show, playing back a movie clip.

Language

- There is a choice of languages that can be displayed on the LCD. Even if the battery or AC adapter are removed and inserted again, the language setting will be preserved.

- How to set the language

1. Press the Menu button and select the [] menu tab by pressing the Up/ Down button.
2. Press the Right button and select the [Language] menu by pressing the Up/ Down button.
3. Press the Right button and select a desired sub menu by pressing the Up/ Down button.

LANGUAGE sub menu : English, Korean, French, German, Spanish, Italian, S. Chinese, T. Chinese, Japanese, Russian, Portuguese, Dutch, Danish, Swedish, Finnish.



- ※ The following languages are inserted depending on sales region.
 - Type A : Thai, BAHASA(MALAY/ INDONESIAN), Arabic.
 - Type B : Czech, Polish, Hungarian.

4. Press the OK button to set the setting.

INFORMATION

- type A or B language can be inserted depending on sales region
 - Type A : Thai, Bahasa, Arabic
 - Type B : Hungarian, Polish, Czech

Formatting a memory card

- This is used for formatting the memory card. If you run [Format] on the memory card, all images, including the protected images, will be deleted. Be sure to download important images to your PC before formatting the memory card.

- How to format the memory card

1. Press the Menu button and select the [] menu tab by pressing the Up/ Down button.
2. Press the Right button and select the [Format] menu by pressing the Up/ Down button.
3. Press the Right button and select a desired sub menu by pressing the Up/ Down button.

If [No] is selected : The memory card will not be formatted.

If [Yes] is selected : A [Processing!] message appears and the memory card will be formatted. If you ran FORMAT in Play mode, a [No Image!] message will appear.



INFORMATION

- Be sure to run [Format] on the following types of memory card.
 - A new memory card, or an unformatted memory card.
 - A memory card that has a file this camera can't recognise or one that has been taken from another camera.
- Always format the memory card using this camera. If you insert a memory card that has been formatted using other cameras, memory card readers, or PCs, you will get a [Card Error!] message.

Setting up the Date & Time

- You can change the date and time that will be displayed on the captured images.

- How to set the Date & Time

1. Press the Menu button and select the [] menu tab by pressing the Up/ Down button.
2. Press the Right button and select the [Date & Time] menu by pressing the Up/ Down button.
3. Press the Right button and select a desired sub menu by pressing the Up/ Down button.
 - Left/ Right button : Selects the year/ month/ day/ hour/ minute item.
 - Up/ Down button : Changes the setting value
4. Press the OK button to set the setting.



Setting up the date type

- You can change the date type that will be displayed on the captured images.

- How to set the date type

1. Press the Menu button and select the [] menu tab by pressing the Up/ Down button.
2. Press the Right button and select the [Date Type] menu by pressing the Up/ Down button.
3. Press the Right button and select a desired sub menu by pressing the Up/ Down button.
 - Up/ Down : Changes the date type
4. Press the OK button to set the setting.



World time

- You can check the time of cities of various nations.

- How to check the time

1. Press the Menu button and select the [] menu tab by pressing the Up/ Down button.
2. Press the Right button and select the [World Time] menu by pressing the Up/ Down button.



3. Press the Right button and a world map will display as shown alongside.

- Left/ Right or Rear jog dial (JOG2) : moves the red line to check the time of various cities.

4. Press the OK button to set the setting.



Imprinting the recording date

- There is an option to include Date/Time on still images.
- How to imprint the date & time
 1. Press the Menu button and select the [] menu tab by pressing the Up/ Down button.
 2. Press the Right button and select the [Imprint] menu by pressing the Up/ Down button.
 3. Press the Right button and select a desired sub menu.

[Off] : The DATE & TIME will not be imprinted on the image file.

[Date] : Only the DATE will be imprinted on the image file.

[Date&Time] : The DATE & TIME will be imprinted on the image file.
 4. Press the OK button to set the setting.

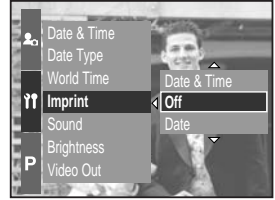

INFORMATION

- The Date & Time are imprinted at the bottom right side of the still image.
- The date will be imprinted as a DATE TYPE setting.
- TIME is imprinted in the following way : [Hour : Minute] and hours are shown using the 24 hour clock.
- The imprint function is applied only to still images except for the images taken in the [Text] scene mode.

Sound

- If you set the operation sound to ON, various sounds will be activated for camera startup, when button are pressed, and if there is a card error, so that you can be aware of the camera operation status.

- How to set the sound

1. Press the Menu button and select the [] menu tab by pressing the Up/ Down button.
2. Press the Right button and select the [Sound] menu by pressing the Up/ Down button.
3. Press the Right button and select a desired sub menu.
[Sound] sub menu : Off/ Low/ Medium/ High
4. Press the OK button to set the setting.

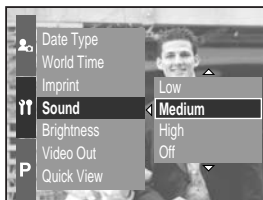

LCD brightness

- You can adjust the Rear, Finder and Top LCD brightness.

- How to set the brightness

1. Press the Menu button and select the [] menu tab by pressing the Up/ Down button.
2. Press the Right button and select the [Brightness] menu by pressing the Up/ Down button.
3. Press the Right button and select a desired LCD by pressing the Up/ Down button.
4. Press the Right button and select a desired sub menu.
- [Brightness] sub menu : Dark, Normal, Bright
5. Press the OK button to set the setting.

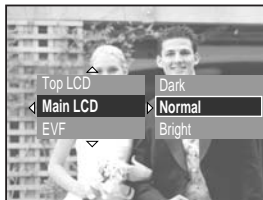
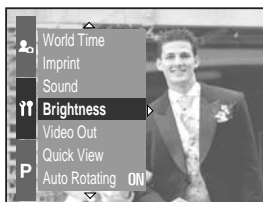

Selecting Video out type

- The Movie output signal from the camera can be NTSC or PAL.
Your choice of output will be governed by the type of device (monitor or TV, etc.) to which the camera is connected. PAL mode can support only BDGHI.

- How to set the video out type

1. Press the Menu button and select the [] menu tab by pressing the Up/ Down button.
2. Press the Right button and select the [Video Out] menu by pressing the Up/ Down button.
3. Press the Right button and select a desired LCD by pressing the Up/ Down button.
- [Video Out] sub menu : NTSC, PAL
4. Press the OK button to set the setting.



- Connecting to an external monitor

In RECORDING/ PLAY mode, you can view the stored still images or movie clips by connecting the camera to an external monitor via the AV cable. When the camera is connected to an external monitor, the LCD monitor will be turned off automatically.

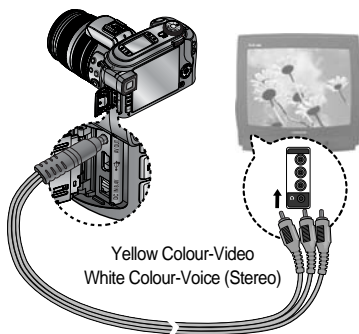

INFORMATION

- NTSC : U.S.A, Canada, Japan, South Korea, Taiwan, Mexico.
- PAL : Australia, Austria, Belgium, China, Denmark, Finland, Germany, U.K., Holland, Italy, Kuwait, Malaysia, New Zealand, Singapore, Spain, Sweden, Switzerland, Thailand, Norway.
- When using a TV as an external monitor, you will need to select the external or AV channel of the TV.
- There will be a digital noise on the external monitor, but it is not a malfunction.
- If the image is not in the centre of the screen, use the TV controls to centre it.
- When the camera is connected to an external monitor, the menu will be visible on the external monitor and the menu functions are the same as those indicated on the LCD

Quick view

- If you enable Quick View before capturing an image, you can view the image you just captured on the LCD for the duration set in the [Quick View] setup. Quick view is possible only with still images.

- How to set the quick view

1. Press the Menu button and select the [] menu tab by pressing the Up/ Down button.
2. Press the Right button and select the [Quick View] menu by pressing the Up/ Down button.
3. Press the Right button and select a desired sub menu by pressing the Up/ Down button.

[Off] : The quick view function can't be activated.

[0.5, 1, 3 sec] : The captured image is briefly displayed during the selected time.

4. Press the OK button to set the setting.

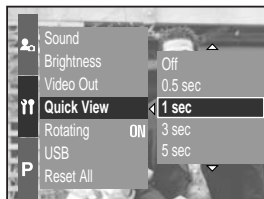

Auto rotating sensor

- When an image taking vertically plays back, the auto rotating sensor will rotate the image correctly.
- You can view the reversed image correctly without rotating the image.

● How to set the auto rotating sensor

1. Press the Menu button and select the [] menu tab by pressing the Up/ Down button.
2. Press the Right button and select the [Auto Rotating] menu by pressing the Up/ Down button.
3. Press the Right button and select a desired sub menu by pressing the Up/ Down button.
 - [Off] : The image will not be rotated automatically.
 - [On] : The image will be rotated automatically.
4. Press the OK button to set the setting.

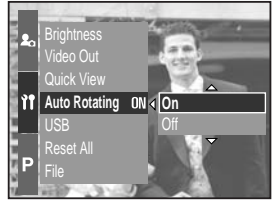

※ Selecting the [On] sub menu



[Taking an image]



[Playing back the image]

Connecting an External Device (USB)

- You can select an external device to which you want to connect the camera using the USB cable.
- How to set the external device
 1. Press the Menu button and select the [] menu tab by pressing the Up/ Down button.
 2. Press the Right button and select the [USB] menu by pressing the Up/ Down button.
 3. Press the Right button and select a desired sub menu by pressing the Up/ Down button.
 - [Computer] : Select this if you want to connect the camera to your PC.
Refer to page 120 for instructions on how to connect the camera to your PC.
 - [Printer] : Select this if you want to connect the camera to your printer.
Refer to page 83 for instructions on how to connect the camera to your printer.
 4. Press the OK button to set the setting.

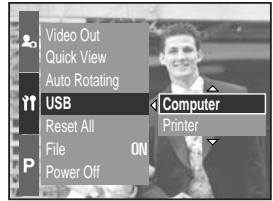



Initialisation

- All camera menu and function settings will be restored to their default values. However, values for DATE/ TIME, LANGUAGE, and VIDEO OUT will not be changed.
- How to set the initialisation
 1. Press the Menu button and select the [] menu tab by pressing the Up/ Down button.
 2. Press the Right button and select the [Reset All] menu by pressing the Up/ Down button.
 3. Press the Right button and select a desired sub menu by pressing the Up/ Down button.
 - If [No] is selected : Settings will not be restored to their defaults.
 - If [Yes] is selected : A confirmation window will display. Select the [Yes] menu by pressing the Up/ Down button. All settings will be restored to their defaults.



Setting up the MYCAM menu

- You can set up a start up image, start up sound, shutter sound and sound effect. The items indicated by  are default settings.

| Menu tab | Main menu | Sub menu | | Page |
|---|---------------|------------|-----------|------|
|  | Start Image | Off | Logo | p.97 |
| | | User Image | - | |
| | Start Sound | Off | Sound 1 | p.98 |
| | | Sound 2 | Sound 3 | |
| | Shutter Sound | Off | Shutter 1 | p.98 |
| | | Shutter 2 | Shutter 3 | |
| | Sound Effect | Off | Effect 1 | p.98 |
| | | Effect 2 | Effect 3 | |

* Menus are subject to change without prior notice.

Start up image

- You can select the image that is first displayed on the LCD whenever the camera is turned on.
- How to set the start up image
 1. Press the Menu button and select the [] menu tab by pressing the Up/ Down button.
 2. Press the Right button and select the [Start Image] menu by pressing the Up/ Down button.
 3. Press the Right button and select a desired sub menu by pressing the Up/ Down button.
 4. Press the OK button to set the setting.



INFORMATION

- Use a saved image for the start-up image with the [User Image] in the [Resize] menu in the play mode.
- The start-up image will not be deleted by deleting all images or Format function.
- The User images will be deleted by [Reset] menu.

Start up sound

- You can select the sound that is activated whenever the camera is turned on.
- How to set the start up sound
 1. Press the Menu button and select the [] menu tab by pressing the Up/ Down button.
 2. Press the Right button and select the [Start Sound] menu by pressing the Up/ Down button.
 3. Press the Right button and select a desired sub menu by pressing the Up/ Down button.
 4. Press the OK button to set the setting.



Shutter sound

- You can select the shutter sound.
- How to select the shutter sound
 1. Press the Menu button and select the [] menu tab by pressing the Up/ Down button.
 2. Press the Right button and select the [Shutter Sound] menu by pressing the Up/ Down button.
 3. Press the Right button and select a desired sub menu by pressing the Up/ Down button.
 4. Press the OK button to set the setting.



Sound type

- You can select a type of sound when the sound is activated.
- How to set the type of sound
 1. Press the Menu button and select the [] menu tab by pressing the Up/ Down button.
 2. Press the Right button and select the [Shutter Sound] menu by pressing the Up/ Down button.
 3. Press the Right button and select a desired sub menu by pressing the Up/ Down button.
 4. Press the OK button to set the setting.



Important notes

Be sure to observe the following precautions!

- This unit contains precision electronic components. Do not use or store this unit in the following locations.
 - Areas exposed to severe changes in temperature and humidity.
 - Areas exposed to dust and dirt.
 - Areas exposed to direct sunlight or the inside of a vehicle in hot weather.
 - Environments where there is high magnetism or excessive vibration.
 - Areas with high explosives or highly flammable materials.

- Do not let the unit come into contact with dust, vinyl goods, or chemicals, such as insecticides, for an extended period of time.

- Sand can be particularly troublesome to cameras.
 - Do not let sand get inside the unit when using it on beaches, coastal dunes, or other areas where there is lots of sand.
 - Doing so may result in failure or may permanently render the unit unusable.

- Handling the camera
 - Never drop the camera or subject it to severe shocks or vibrations.
 - This camera is not waterproof. To avoid dangerous electrical shocks, never hold or operate the camera with wet hands.
 - If you use this camera in wet places, such as beach or pool, do not let water or sand get inside the camera.

- Extremes in temperature may cause problems.
 - If the camera is transferred from a cold to a warm and humid environment, condensation can form on the delicate electronic circuitry. If this occurs, turn the camera off and wait for at least 1 hour until all moisture is dispersed. Moisture build up can also occur in the memory card. If this happens, turn off the camera and remove the memory card. Wait until the moisture has dispersed.

Important notes

- **Caution on Using the Lens**
 - If the lens is subjected to direct sunlight, it could result in discoloration and deterioration of the image sensor.
 - Pay attention not to get fingerprints or foreign substances on the surface of the lens.

- If the digital camera is not used for a long period, an electric discharge can occur. It is a good idea to remove the batteries and the memory card if you do not intend using the camera for an extended period of time.

- If the camera is exposed to an electronic interference, it will turn itself off to protect the memory card.

- **Camera Maintenance**
 - Use a soft brush (available from photo stores) to gently clean the lens and LCD assemblies. If this does not work, lens-cleaning paper with lens cleaning fluid can be used. Clean the camera body with a soft cloth. Do not allow this camera to come into contact with solvent materials such as benzol, insecticide, thinners etc. This may damage the body shell of the camera and also affect its performance. Rough handling can damage the LCD monitor. Take care to avoid damage and keep the camera in its protective carry case at all times when not in use.

- Do not attempt to disassemble or modify the camera.

- Under certain conditions, static electricity can cause the flash unit to fire. This is not harmful to the camera and is not a malfunction.

- When images are uploaded or downloaded, the data transfer may be affected by static electricity. In this case, disconnect and re-connect the USB cable before trying the transfer again.

- Before an important event or going on a trip, you should check the camera condition.
 - Take a picture for testing the camera condition and prepare extra batteries.
 - Samsung cannot be held responsible for camera malfunctions.

Warning indicator

- There are several warnings that may appear on the LCD display.

Card Error !

- Memory card error
 - Turn off the camera power and turn it on again
 - Insert the memory card again
 - Insert the memory card and format the memory card (p.91)

No Card !

- A memory card is not inserted
 - Insert a memory card
- The camera can't recognise the memory card
 - Insert the memory card again
 - Turn off the camera power and turn it on again

Card Full !

- There is insufficient memory capacity to take an image
 - Insert a new memory card
 - Delete unnecessary image files to free up some memory

No Image !

- There are no images stored on the memory card
 - Take images
 - Insert a memory card that is holding some images

File Error !

- File error
 - Format the memory card
- Memory card error
 - Contact a camera service centre

Low Battery !

- There is low battery capacity
 - Insert charged battery

Warning indicator

Set USB

- [USB] sub menu and connected device are not matched.
→ Reconfigure [USB] in the [Setup] menu.

Out Of Number

- When selecting too many printing pages in the PictBridge menu.
→ Select printing page within the limitation.

Before contacting a service centre

- Please check the following

The camera doesn't switch on

- There is low battery capacity.
→ Insert charged battery.
- Batteries are inserted incorrectly with the reverse polarities.
→ Insert the batteries according to the polarity marks (+, -).

The camera power ceases while in use.

- The batteries are exhausted.
→ Insert charged battery.
- The Camera is turned off automatically.
→ Turn off the camera power and turn it on again.

Batteries drain quickly

- The Camera is being used in low temperatures.
→ Keep the camera in warm conditions (i.e. inside a coat or jacket) and only remove it in order to take images.

Before contacting a service centre

Camera does not take images when pressing the Shutter button

- There is insufficient memory capacity.
 - Delete unnecessary image files
- The memory card has not been formatted
 - Format the memory card (p.91)
- The memory card is exhausted
 - Insert a new memory card
- The memory card is locked
 - Refer to [Card Locked !] error message (p.101)
- The camera's power is off
 - Turn the camera power on
- The batteries are exhausted
 - Insert charged battery.
- Batteries are inserted incorrectly with the reverse polarities.
 - Insert the batteries according to the polarity marks (+, -).

The camera suddenly stops working while in use

- The camera was stopped due to a malfunction
 - Remove/ re-insert batteries and switch the camera on

The images are unclear

- A picture was taken within 0.8 m from the subject without setting an appropriate macro mode
 - If the subject is closer than 0.8m, select macro shot mode
- Taking a picture beyond the flash range
 - Take a picture within the flash range
- The lens is smudged or dirty
 - Clean the lens

The flash does not fire

- Flash off mode has been selected
 - Dis-engage flash off mode
- The camera mode can't use the flash
 - Refer to the FLASH instruction (p.34)

Incorrect date and time is displayed

- The date and time have been set incorrectly or the camera has adopted the default settings
 - Reset the date and time correctly

Before contacting a service centre

The images don't play back

- Incorrect file name (Violation of DCF format)
 - Do not change the image file name

Colour of image is different to the original scene

- White balance setting is incorrect
 - Select appropriate White balance

Images are too bright

- Exposure is excessive
 - Reset exposure compensation

No image on external monitor

- The external monitor has not been connected properly with the camera
 - Check the connection cables
- There are incorrect files in the memory card
 - Insert a memory card that has correct files

When using the PC's explorer, the [Removable Disk] file does not show

- Cable connection is incorrect
 - Check the connection
- The camera is off
 - Turn the camera on
- The operating system is not Windows 98, 98SE, 2000, ME, XP/ Mac OS 9.2 ~ 10.3.
Alternatively the PC does not support USB
 - Install Windows 98, 98SE, 2000, ME, XP/ Mac OS 9.2 ~ 10.3 to PC that supports USB
- The camera driver is not installed
 - Install a [USB Storage Driver]

Specifications

| | | |
|-----------------|---------------------------|---|
| Image Sensor | Type | 2/3" CCD |
| | Effective Pixel | Approx. 8.0 Mega-pixel |
| | Total Pixel | Approx. 8.3 Mega-pixel |
| Lens | Focal Length | Schneider Lens f = 7.2 ~ 108.0mm (35mm film equivalent : 28~420 mm) |
| | F No. | F2.2 ~ F4.6 |
| | Digital Zoom | Still Image mode : 1.0X ~ 4.0X Play mode : 1.0X ~ 10.0X (depends on image size) |
| Viewfinder | Electronic Viewfinder | 0.44" color TFT LCD (235,000 dot) |
| | LCD Monitor | Main : 3.5" color TFT LCD (235,000 dot) Top : 1.44" Wide color TFT LCD (115,000 dot, Status or Preview selectable) |
| Focusing | Type | TTL auto focus (9 points multi-focusing) |
| | Modes | Single AF, Continuous AF, Manual focus AF lock, AF area select, Direct manual focus available |
| | Range | Normal : 50cm ~ infinity (Wide), 3.5m ~ infinity (Tele) Macro : 10 ~ 70cm (Wide), 1.5 ~ 3.7m (Tele) Super Macro : 3 ~ 70cm (focal length 50~100mm) |
| Shutter | Type | Mechanical and Electronic shutter |
| | Speed | 1 ~ 1/4,000 sec. (Manual mode : 30 ~ 1/4,000 sec.) |
| Exposure | Control | Program AE, Shutter Priority AE, Aperture Priority AE or Manual Exposure Metering : Multi, Center-weighted, Spot AE lock available |
| | Compensation | ± 2EV (1/3EV steps) |
| | ISO Equivalent | Auto, 50, 100, 200, 400, 800 |
| High Speed Mode | | Up to max ISO 800 automatically |
| Flash | Modes | Auto, Auto & Red-eye reduction, Fill-in, Slow sync, Slow sync & Red-eye reduction, Flash off Flash compensation : ±2EV (1/3EV steps) |
| | Range | Wide : 0.7 ~ 7.0m (ISO Auto), Tele : 1.5 ~ 4.0m (ISO Auto) |
| | Recharging Time | Approx. 5 sec. |
| | External Flash (optional) | SEF-42A : DC 6V, 4 x AA Alkaline |
| Sharpness | | Soft, Normal, Vivid |
| Effect | | Normal, B&W, Sepia, Negative Contrast adjust, Saturation adjust |
| Color Space | | sRGB, Adobe RGB |
| White Balance | | Auto, Daylight, Cloudy, Fluorescent_H, Fluorescent_L, Tungsten, Custom 1, Custom 2, Color temperature adjust |
| Voice Recording | | Voice Memo in Still Image (max. 10 sec.) |
| Date Imprinting | | Date&Time, Date, Off (user selectable) |
| Shooting | Still Image | Modes : Auto, Program, A,S,M, Myset, Movie, Scene * Scene : Night, Portrait, Children, Landscape, Close-up, Text, Sunset, Dawn, Backlight, Fireworks, Beach & Snow Continuous : Single, Continuous (1.0fps), Continuous HS (2.5fps), Continuous UHS (10fps with 1 Mega-pixel quality), Interval (1~60 mins up to 99 frames) Self-timer : 2 sec., 10 sec., Double, Remote control 0 sec., Remote control 2 sec. Bracketing : Exposure, Focusing, White Balance (3 frames or 5 frames selectable) |

Specifications

| | | |
|-----------------------|--------------------|---|
| | Movie Clip | With stereo audio (recording time : memory capacity dependent) Size : 640x480, 320x240, 160x120 Frame rate : 25 fps, 15 fps |
| Storage | Media | CompactFlash Card Type I or Type II (Up to 4GB guaranteed) |
| | File Format | Still Image : RAW(DNG), TIFF, JPEG (DCF), EXIF 2.2, DPOF 1.1, PictBridge 1.0 Movie Clip : AVI (MJPEG) Audio : WAV |
| | Image Size | L : 3264x2448, 3:2 : 3264x2176, 16:9 : 3264x1840 M1 : 2400x1800 M2 : 1632x1224, S1 : 1024x768, S2 : 640x480 |
| | Capacity (64MB) | L : 3:2 : 16:9 : M1 : M2 : S1 : S2 : * These figures are measured under Samsung's standard conditions and may vary depending on shooting conditions and camera settings. |
| Image Play | Type | Single image, Thumbnails, Slide show, Movie Clip, Album Organization |
| | Editing | Trimming, Resizing, Rotating |
| Interface | | Digital output connector : USB 2.0 Audio : Stereo Video output : NTSC, PAL (user selectable) DC power input connector : 7.4V |
| Power Source | | Rechargeable battery : 7.4V Li-ion battery(SLB-1974), Charger : SBC-L4 AC Adaptor : DC 8.4V, 1.5A (optional) * Included battery may vary depending on sales region. |
| Dimensions (WxHxD) | | 135.5x87x78.6mm (144.6mm, including lens protrusion) |
| Weight | | 약 850g(전지 및 카드 제외) |
| Operating Temperature | | 0 ~ 40 °C |
| Operating Humidity | | 5 ~ 85% |
| Software | Camera Driver | Storage Driver (Windows98/98SE/2000/ME/XP Mac OS 10.0 higher) |
| | Application | Digimax Master, Digimax Reader |
| Special Features | | The world's longest built in 15X zoom - 28mm wide-angle and 15X ultra high zoom capability The world's largest digital camera LCD - 3.5" TFT with 230K Pixels The world's largest-capacity lithium-ion battery - 7.4V 1900mAh The world's first top TFT LCD for waist level shooting - 1.44" wide type High Speed mode suppressing camera shaking |

* Specifications are subject to change without prior notice.

* All trademarks are the property of their respective owners.