

SAMSUNG
WISENET

BrightVIEW

User Manual



BrightVIEW

User Manual

Copyright

©2016 Hanuwa Techwin Co., Ltd. All rights reserved.

Trademark

Each of trademarks herein is registered. The name of this product and other trademarks mentioned in this manual are the registered trademark of their respective company.

Restriction

Copyright of this document is reserved. Under no circumstances, this document shall be reproduced, distributed or changed, partially or wholly, without formal authorization.

Disclaimer

Hanuwa Techwin makes the best to verify the integrity and correctness of the contents in this document, but no formal guarantee shall be provided. Use of this document and the subsequent results shall be entirely on the user's own responsibility. Hanuwa Techwin reserves the right to change the contents of this document without prior notice.

IMPORTANT SAFETY INSTRUCTIONS

1. Read these instructions.
2. Keep these instructions.
3. Heed all warnings.
4. Follow all instructions.
5. Do not use this apparatus near water.
6. Clean only with dry cloth.
7. Do not block any ventilation openings. Install in accordance with the manufacturer's instructions.
8. Do not install near any heat sources such as radiators, heat registers, stoves, or other apparatus (including amplifiers) that produce heat.
9. Do not defeat the safety purpose of the polarized or grounding-type plug. A polarized plug has two blades with one wider than the other. A grounding type plug has two blades and a third grounding prong. The wide blade or the third prong are provided for your safety. If the provided plug does not fit into your outlet, consult an electrician for replacement of the obsolete outlet.
10. Protect the power cord from being walked on or pinched particularly at plugs, convenience receptacles, and the point where they exit from the apparatus.
11. Only use attachments/ accessories specified by the manufacturer.
12. Use only with the cart, stand, tripod, bracket, or table specified by the manufacturer, or sold with the apparatus. When a cart is used, use caution when moving the cart/apparatus combination to avoid injury from tip-over.
13. Unplug this apparatus during lighting storms or when unused for long periods of time.
14. Refer all servicing to qualified service personnel. Servicing is required when the apparatus has been damaged in any way, such as power-supply cord or plug is damaged, liquid has been spilled or objects have fallen into the apparatus, the apparatus has been exposed to rain or moisture, does not operate normally, or has been dropped.





SPECIFY SERVICE INSTRUCTIONS AND WARRANTY TERMS

FCC Caution :

Any Changes or modifications not expressly approved by the party responsible for compliance could void the user's authority to operate the equipment.

This device complies with part 15 of the FCC Rules. Operation is subject to the following two conditions :

(1) This device may not cause harmful interference, and (2) this device must accept any interference received, including interference that may cause undesired operation.

Note :

This equipment has been tested and found to comply with the limits for a Class B digital device, pursuant to part 15 of the FCC Rules. These limits are designed to provide reasonable protection against harmful interference in a residential installation. This equipment generates, uses and can radiate radio frequency energy and, if not installed and used in accordance with the instructions, may cause harmful interference to radio communications. However, there is no guarantee that interference will not occur in a particular installation. If this equipment does cause harmful interference to radio or television reception, which can be determined by turning the equipment off and on, the user is encouraged to try to correct the interference by one or more of the following measures:

- Reorient or relocate the receiving antenna.
- Increase the separation between the equipment and monitor.
- Connect the equipment into an outlet on a circuit different from that to which the monitor is connected.
- Consult the dealer or an experienced radio/TV technician for help.

WARNING

- STRANGULATION HAZARD - Keep cord out of child's reach. NEVER place camera or cords within 3 feet of crib or playpen. Never use extension cords with AC Adapters. Only use the AC Adapters provided.
- Some adult assembly or installation required.
- This product contains small parts that may cause choking. Keep small parts away from children.
- This product is NOT intended to replace proper supervision of children. You MUST check your child's activity regularly, as this product will not alert parents to silent activities of a child.
- Before using this product, read and follow all instructions contained in this booklet, and read and follow all instructions and warnings on the product.

- NEVER use the transmitter or monitor near water, including near a bathtub, sink, laundry tub, wet basement, etc.
- This product is intended for indoor use only.
- This product is not intended for use as a medical monitor and its use should not replace adult supervision.
- The transmitter detects normal sound levels within a range of 2 to 3 meters (6 to 10 feet) from a child. If the child moves outside of this range, it may not be able to detect sounds from him or her.
- It is essential that you check the operating range and condition of the transmitter monitor on initial installation, and on a regular basis after that.
- Check reception regularly. Test monitor before use and after changing camera location.

The wireless signal transfer range may be shortened if an obstacle such as a concrete wall is in between the camera and monitor.

- To prevent overheating, keep the product and AC power adapters away from any direct sunlight and heat sources such as radiators, heat registers, cooking devices (e.g., stoves and ovens) and other appliances that produce heat (e.g., amplifiers, televisions and stereos).
- Ensure that the product is well ventilated during use. Avoid contact with pillows and furniture that may block ventilation.
- Use only the AC adapters provided with the product, as other adapters may damage the product. Plug the adapters only into standard household current (100~240 volts AC). Place the AC adapters avoiding pinch points otherwise you can damage the adapters.
- When an AC adapter is plugged into a power source, DO NOT touch the exposed end of the AC adapter's cord.
- Do not use extension cords with the AC power adapters to avoid entanglement.
- This product should only be serviced by qualified and authorized Hanwha Techwin service centers.
- Images and sounds are transmitted by the product over public airwaves and transmissions may be picked up by other units. (Although the transmission distance is 100m or longer, it may vary depending on whether there are obstacles between the camera and the monitor.)
- Caution if you use the system to watch a young child, do not place the camera where the child can reach.
- When using the system with only battery power and the charge is low, then the picture and or sound may be affected.
- If this occurs then please connect the AC power adapter.

CAUTION

Risk of explosion if battery is replaced by an incorrect type.
Dispose of used batteries according to the instructions.

FCC Radiation Exposure Statement

This equipment complies with FCC radiation exposure limits set forth for an uncontrolled environment. This equipment should be installed and operated with minimum distance 20 cm between the radiator and your body. This transmitter must not be co-located or operating in conjunction with any other antenna or transmitter.

Contents

WHAT'S INCLUDED

Package Contents	5
-------------------------------	----------

GETTING STARTED

Functional Description	6
Powering your monitor	6
Operating the System	6

VIEWING MODE DISPLAY

Indicator Description	8
How to use the indicator	8
Menu Operation	10
How to use the function tools	10
How to use the setup icon	11

OVERVIEW

Getting to know your Monitoring system	12
Wireless Monitor	12
Wireless Camera	14
Wireless Wrist Band	15
Sensor	15

INSTALLATION

How to Install	15
Wireless Monitor	15
Wireless Camera	15

REMOTE VIEW

Remote	16
---------------------	-----------

APPENDIX

Specifications	18
Troubleshooting	19

WHAT'S INCLUDED

Package Contents

The system comes with the following components:



Wireless camera



Wireless monitor

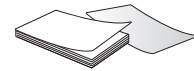

User Manual & Warranty Card

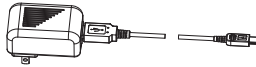

Camera Adapter

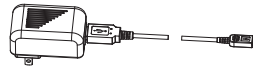

Monitor Adapter



Plastic anchor (1EA) & Screw (1EA)



Wireless wrist band

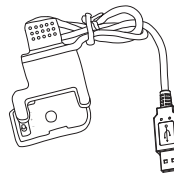

Wrist band Adapter

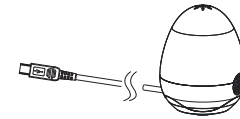

Sensor

Check your package to confirm that you have received the complete system, including all components shown above.

GETTING STARTED

Functional Description

Powering your monitor

After opening the box, fully charge the monitor before use. After initial charge, recharge as needed.

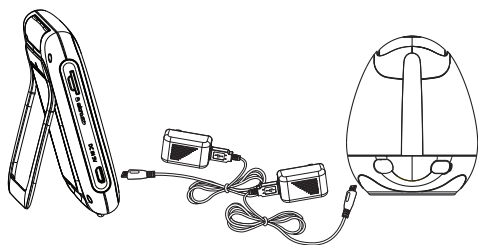

Wireless Monitor

You can use the device while charging with connected adapter, and the device is portable if charged.

Wireless Camera

The Wireless Camera must be plugged in at all times in order to view.

Wireless wrist band

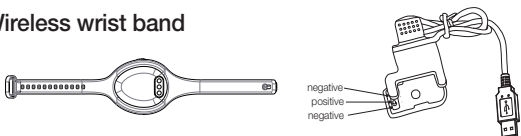

The wireless wrist band must be charging with adapter and the device is portable if charged.



Operating the System

The basic operation is as follows:





Camera and Monitor pairing

The units already come paired for your convenience. This button is used to add an additional camera. User can select camera number to assign. Up to 4 Cameras may be paired.



1. Power on wireless monitor and wireless camera.
2. Touch the live view screen on the monitor, and then the settings icon will appear.
3. Press the [] button on the monitor.
4. Select [] icon.
5. Select camera number.
The monitor search a camera which sets to pairing mode.
A count down clock appears at the middle of screen which starts counting from 30 to 0.
6. Press the [PAIR] button on the camera bottom.
7. Within 30 seconds, if the monitor successfully pairs with the camera, the monitor will automatically switch to the camera's current view.

Monitor and wrist band pairing

1. Make sure the monitor should be power.
2. Touch the view screen on the monitor, and then the setting icon will appear.
3. Press the [] button on the monitor, come into "Menu" interface.
4. Select [] icon, mark sure the Bluetooth should be show [] .
5. The monitor will search the Bluetooth device. Choose the Bluetooth and if pairing success, the monitor will show Paired and the Bluetooth will show " [] " icon in the wrist band.

Voice activated (VOX)



Select to monitor significant sound with reduced ambient noise. The screen goes off in "VOX" mode if there is no significant sound louder than a certain level about 30 seconds. Meanwhile, the monitor screen turns on as soon as detecting sound around the camera. In "VOX" mode, you can set the sensitivity.



- Low Sound Level Detection : Sets to higher sensitivity.
- High Sound Level Detection : Sets to lower sensitivity.

Remark:VOX on, and once VOX trigger, the Bluetooth will alert and shake for Dozens of seconds. You can stop the alert by press the Bluetooth button at the side of Bluetooth. Once the wristband go beyond of the limit distant of Bluetooth, it will alert for several seconds, then you can stop alert by pressing the Bluetooth button.

Multi camera mode

Press [ / ] switch the split mode. According to the paired camera, screen split mode is different. When two cameras are paired, it displays as 2-split mode. When there are more than 2 cameras are paired, it displays as 4 split mode. Up to 4 cameras can be paired.

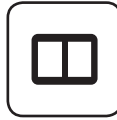

Out of Range

If the monitor is outside of transmission range with the paired camera, the "Out of Range" message appears with warning beeps at regular intervals.



Two-way talk

Press the [] icon while talking.



Sound level

The louder the sound around the camera, the more LEDs turn on.



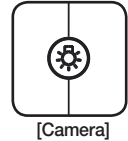

Night Light

Touch the [] button on the camera to remotely activate or deactivate the night light on the camera.



Remote PTZ and Zoom

You can remotely control the camera to pan, tilt and digital zoom. Use [] icons on the wireless monitor to control the camera. Use [ ] icon to zoom in and out.

Sequence View

Press the "Sequence View"button, it switches to cam1 viewing.After 10 seconds, it automatically switches to cam2 for another 10 second. Util largest cam number is viewed for 10 seconds, then it loops back to view cam1 again.



VIEWING MODE DISPLAY

Indicator Description

How to use the indicator

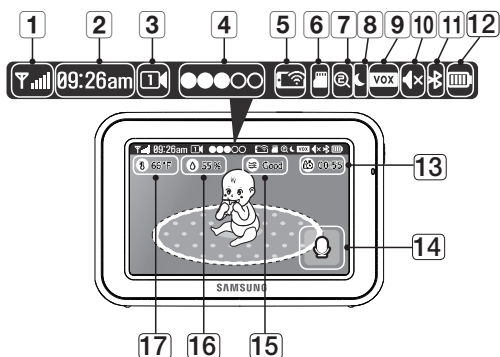

1 Signal Indicator

The signal indicator shows the strength of the signal being received from the camera. The number of bars in the signal indicator shows the strength of the signal – One or no bars indicate the signal is poor, and 5 bars indicate a strong signal.



2 Digital Clock

Displays the time that is set on the monitor. It only provides AM / PM time format and no 24hour format.



3 Camera Number

Indicates which camera is being displayed on the current screen. When scan mode is selected, this icon will flash.



4 Sound level Indicator

Indicate the sound level of the Active Camera.



5 Remote View

Remote access with free Apps for smartphone.



6 SD card status

 No SD card  Unsupported SD card  SD card



7 x1/x1.5/x2 Zoom mode

Indicates that current screen is Zoomed in. Press [] icon on the monitor to zoom back out.



8 Night Vision Indicator

Indicates camera night vision mode is turned on. The screen will appear in Black/White in this mode.



9 VOX On

Indicates remaining battery charge. Indicated in 4 levels, and one discharge warning.



10 Monitor Speaker Mute

Indicates the monitor speaker is muted. Once the monitor's speaker is muted, no sound from the camera is produced.



11 Bluetooth

Indicated the Bluetooth turn on or off.



12 Battery Capacity Level

Indicates remaining battery charge. Indicated in 4 levels, and one discharge warning.  **Charging:** Indicates the battery is charging by DC input power. If battery nearly empty, it will flash to alert user to charge up the unit.



13 Feed time

A remind for Feed time counter.



14 Two-way talk

Press the [] icon while talking.



15 Air quality display

Indicates air quality display good or normal or bad according to the sensor.

**16 Humidity Display**

Indicates the percent of air humidity according to the sensor.

Humidity Alert range : below 45% above 65%

**17 Temperature Display**

Indicates the temperature value according to the sensor.

No Signal Warnings

The "**Out of Range**" message means the monitor cannot access the camera.
Please reposition the camera, or check the camera power.

Menu Operation

How to use the function tools

Press the screen of the monitor to display the menu screen.

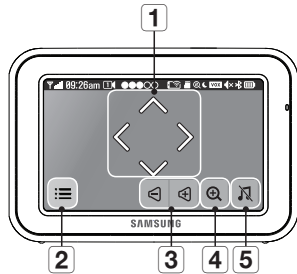

1 Navigation Controls

Using the navigation [] icons, you can control camera angle.



2 Menu Setting

Menu setting mode is including monitor and camera settings.

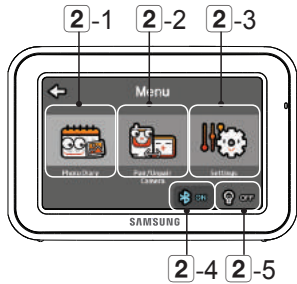

2 -1 Photo Diary

If you choose date, it will show the baby's photo.



2 -2 Pair / Unpair Camera

The LCD support up to 4 cameras, you can choose the camera to pair with the monitor or unpair.



2 -3 Settings

You can setting Vox, date & time, feed timer, photo diary setting and brightness.

Detail please refer to page 11



2 -4 Bluetooth

you can see the bluetooth connected on or not.



2 -5 Night Light On/Off

You can remote the night light. it show the night light on or off.



3 Monitor Volume

Using the [] / [] icons, you can adjust the monitor volume.



4 Zoom IN / Zoom Out

When x1/x1.5 Zoom mode, the magnifier icon is [] inside, means press this icon will zoom in video image. When x2 Zoom mode, the magnifier icon is [] inside, means press this icon will zoom out video image.



5 Lullaby

Press the icon to turn on and turn off lullabies.

How to use the setup icon

Press the [↩] icon to save the changes and return to previous menus.

To return to the Live screen, press the [🏠] icon.

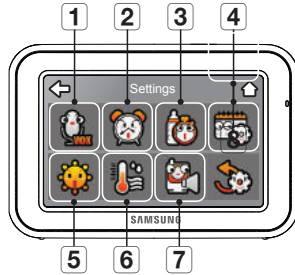

1 Vox

Setting low or high sound level detection. Detail please refer to page7.



2 Date & Time Setting

Set the date & time shown on the monitor. Use the [↗] or [↘] icon to change the numbers in the selected field.



3 Feed Timer

Set the feed time shown on the monitor. Use the [↗] or [↘] icon to change the numbers in the selected field.



4 Photo Diary Setting

You can set your baby's birthday and capture time. Use the [↗] or [↘] icon to change the numbers in the selected field.

If you set the capture time, the camera will take photo only one a day, and if you do not satisfied with the photo of the day, you can reset the capture time, the intraday photo will automatically overwrite.



5 Brightness

Adjusts the brightness of the image shown. If you are using multiple camera, you can adjust the brightness of each individual camera..



6 Environment Sensor

Show the temperature, humidity and air quality, once out of the limit, it will alert.

Sensor Alert range (can't change by users)

Humidity range : below 45% above 65%

Air quality : above 200µg.



7 Set Camera Speaker Volume

Adjust the volume of the speaker on the camera in this menu. The volume can be adjusted from 0 to 5, with 5 being the loudest setting and 0 is mute.



8 Reset

Choose <YES> to reset the monitor to factory defaults.

All settings except for time and date information will be reset to the factory defaults.

OVERVIEW

Getting to know your Monitoring system

Wireless Monitor





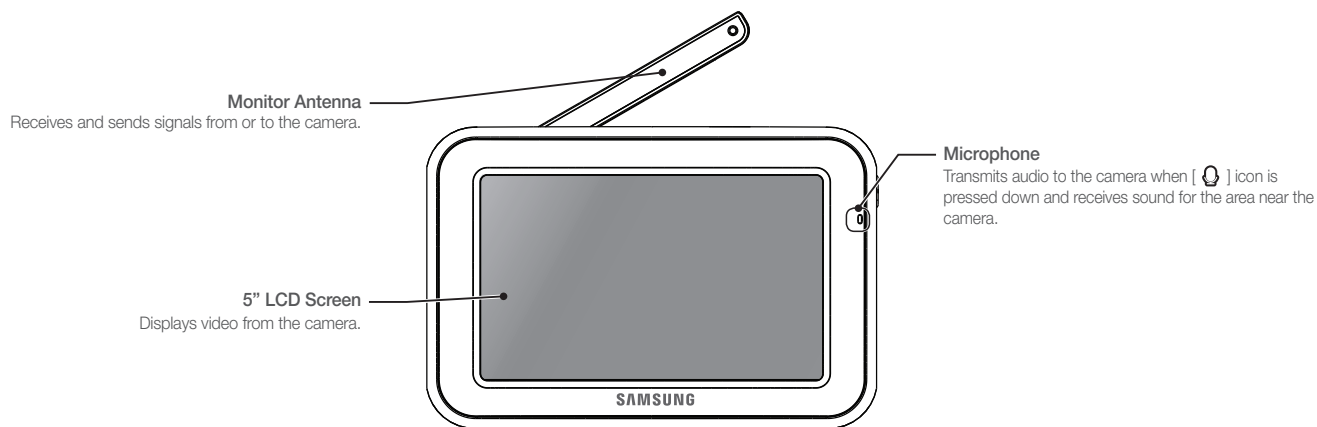

After opening the box, fully charge the monitor before use. After initial charge, recharge as needed.

Front Controls



Navigation Controls

Viewing Mode: The following controls are used while watching live video from the camera:

- Press the [] or [] icon to adjust camera's framing upwards or downwards.
- Press the [] or [] icon to adjust camera's framing to the left or right.
- Press [] [] icon to zoom in/out the screen.
While in zooming, use [] icon to move the screen around.

Menu Mode: Press the [] icon to confirm the menu selection.

Back Controls

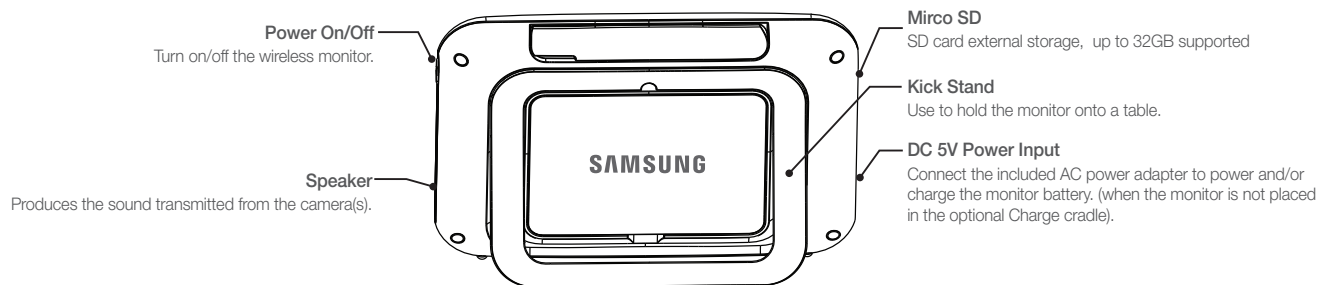

Side Controls

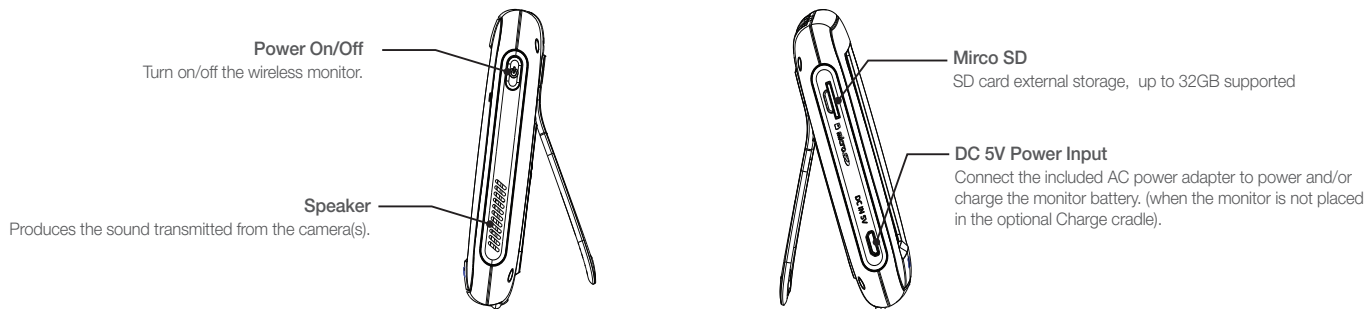

■ You must have more than one camera configured on the system when using the functions that requires more than one camera.

Wireless Camera

Front & Back Controls

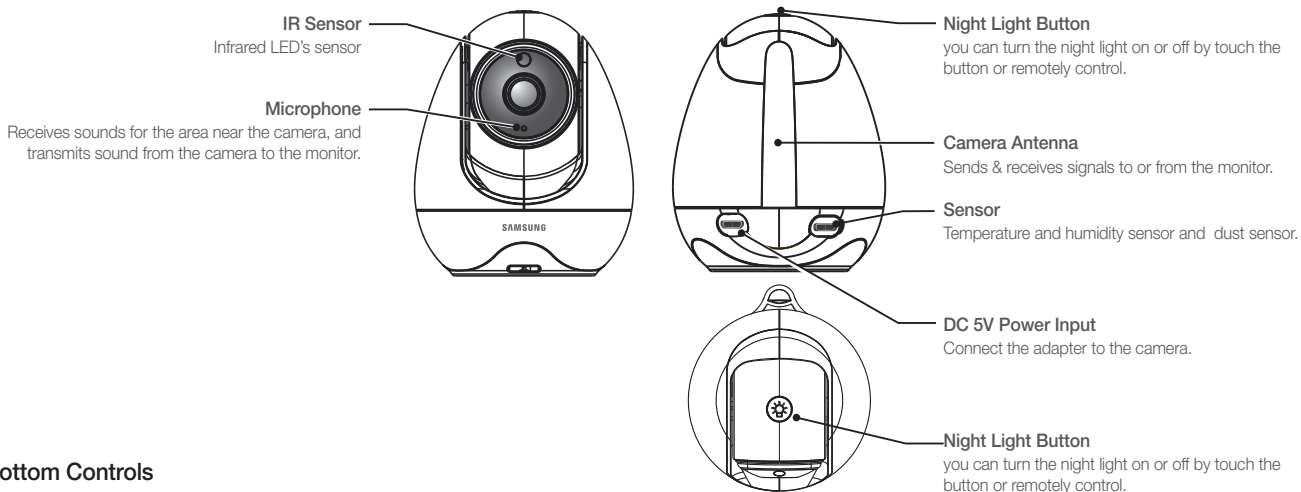

Bottom Controls

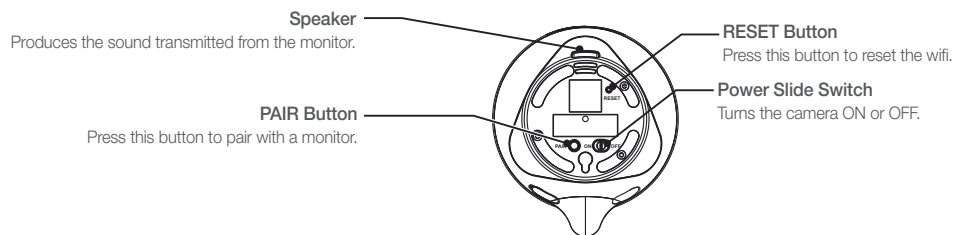

- Remotely control Night Light ON or OFF is available only when the camera is paired to the monitor.

Wireless wrist band

The button of the Wireless wrist band function:

- 1) press the button when the wireless wrist band black screen, it will shin last for 6 seconds.
- 2) When wireless wrist band shake, by pressing the button can stop it shake.

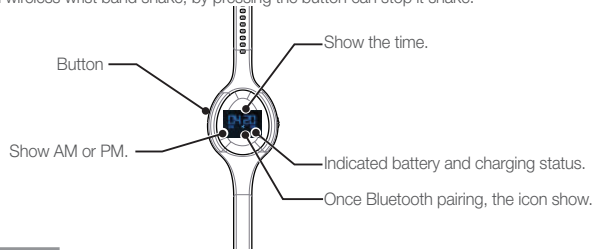

Sensor

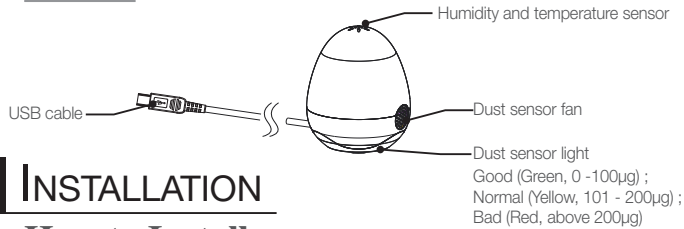

INSTALLATION

How to Install

CAUTION: If you use the system to watch a young child, do not place the camera in the child's reach.

Wireless Monitor

1. Place the monitor in a place that will have clear reception with your camera(s).
2. Pull out the stand.



- Do not pull up the stand lever with an excessive force.

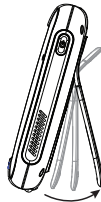

Wireless Camera

Before you install the camera, carefully plan where and how it will be positioned, and where you will route the cable that connects the camera to the power adapter. Before starting permanent installation, verify its performance by observing the image on the monitor when camera is positioned in the same location/position where it will be permanently installed and the monitor is placed in the location where it will be used most of the time.

Installation Warnings

Aim the camera(s) to best optimize the viewing area: Select a location for the camera that provides a clear view of the area you want to monitor, which is free from dust, and is not in line-of-sight to a strong light source or direct sunlight.

Avoid installing the camera where there are thick walls or obstructions between the camera and the monitor.

STRANGULATION HAZARD - Keep cord out of child's reach. NEVER place camera or cords within 3 feet of crib or playpen. Never use extension cords with AC Adapters. Only use the AC Adapters provided.

1. Carefully unpack the camera.

If you are installing cameras that did not come with the system, please see the pairing camera section of this manual for details on installation.

2. Mount the camera to the wall.

Mark the position of the screw hole on the wall, and drill hole and insert 1 screw, then firmly attach the camera to the wall by placing the stand over the installed screw and pushing the base downwards.



- To install on a concrete wall, drill a hole and use plastic anchor to fix.
- Use the drilling template to drill holes on the wall for camera installation. (Page 21)
- The camera can also be placed on a flat surface, such as a table or shelf, and no mounting hardware is required.

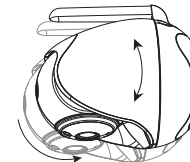
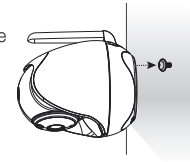

3. Adjust the viewing angle of the camera.

Use the Pan, tilt control from the monitor to adjust the viewing angle of the camera.

REMOTE VIEW

1. Go to App store to download and install "Baby View" into your Mobile phone and install .(picture1)
2. Power the camera.
3. Press the "reset" button on the camera.
4. Press "setting button" of your cell-phone to search the camera Wi-Fi, touch the camera Wi-Fi to connect. (picture2,3)
5. Click the APP, then click "tap here to add device" (picture4).
6. Scan the QR code of the bottom camera, default password "000000",click "OK" (picture5,6).

The monitor will show "remote" icon when remote connect with baby unit via APP "Baby View". And there is another way to connect for remote:

7. Research and now you can see your camera and UID, and you could reset the WLAN network by click the icon "🔧" (picture7)
8. Touch WLAN Networks and select the local network, input your local Wi-Fi password. Press "OK" to complete setting. (picture8-11)
9. You can use WLAN network to choose a local router for the camera, and change the camera to internet mode. (picture12,13)

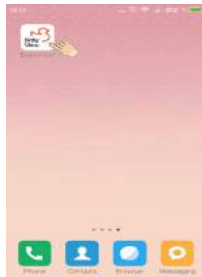

picture1

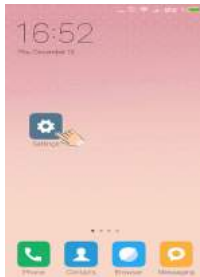

picture2



picture3



picture4



picture5



picture6



picture7



picture8



picture9



picture10



picture11



picture12



picture13

APPENDIX

Specifications

Wireless Camera	
Image Sensor Type	1/4" Color CMOS Image Sensor
Effective Pixel	H: 1280, V: 1024
Resolution	High : 2.5 Mbps(1280x720@~15fps), Middle : 1.5Mbps(704x480 @~20fps), Low : 700Kbps(704X480@~ 10 fps)
Image Compression	MPEG4
Max.Framerate	20fps @704x480
Streaming Capability	Uni
IP	IPv4
Protocol	UDP, RTSP, NTP, DHCP, HTTP
Streaming Method	Unicast
Max. User Access	4 Users simultaneously
White Balance	Auto

Item	Details
Lens	EFL=3.95mm, F=2.2
Viewing Angle (Diagonal)	55 degree
IR LED Type/ Night Vision	IR LED – 940nm /5m
Lullabies	4 songs (Monitor Remote On / Off)
Night Light	Yes (Manual & Remote On/Off) (Amber color, 3000-3500K)
Loud Speaker Output	0.5W, 90dB spl
Power Requirement	DC 5V ± 10%
Power Consumption	4.5Watt (Normal) 6.0Watt(IR On)
VOX level detection	Low: 50dBA / High: 60dBA
Operating Temperature Range	0°C--+40°C
Operating Humidity Range	85% RH
Environment Rating	Indoor use only
Pan Angle	300°
Panning/tilt Speed	12 degree per sec.
Tilt Angle	110°
Regulation Compliance	FCC/CE/IC (Canada certification)
RoHS Compliance	Yes for CE version only
Audio	Built in Microphone/ Speaker
Weight	256g

Wireless Monitor	
Display Type/Size	Color TFT 5"
Resolution	800X480
Touchscreen	Resistive touch type
SD card slot	Yes (Micro SD / not included)
Digital Zoom	X1.5, x2
Real Time Clock (RTC)	+/- 4sec / day

Item	Details
Feed Timer Alert	Yes (beep sound)
sensor temperature alert range (User range)	0°C ~ 40°C
Sensor Alert range (can't change by users)	Humidity range : below 45% above 65% Air quality : above 200
Wrist band alert	Bluetooth connection
Number of Camera Support	Up to 4 cameras
Power Requirement	Adapter : DC 5V ± 10%, Battery : 3.8 Li-ion
Loud Speaker Output	1W, 85dB spl
Power Consumption	5.5Watt (max)
Operating Temperature Range	0°C~+40°C
Operating Humidity Range	85% RH
Environment Rating	Indoor use only
Regulation Compliance	FCC/CE/IC (Canada certification)
RoHS Compliance	Yes for CE version only
Audio	Built in Microphone/ Speaker
Other Special Feature	Bluetooth Sensor connection, Volume control, Pairing
Battery Type	Li-ion
Battery Capacity	2500mAh Rechargeable battery pack, Replaceable
Battery time duration	Min 4 hours (Video on)
Weight	224g
Wireless wrist band	
Material for band	Soft Silicon
Alert Method	Vibration
Battery Type	Li-ion (38mAh Rechargeable battery)

Item	Details
Display	Digital watch / Battery check / connection check
Control part	push toggle
Transmission range	10 meters
Weight / Strip length	9g/150 - 220mm (adjustable range for length)
Sensor	
Temperature sensor	Yes (+/-2 degree),
Humidity sensor	Yes (+/-3%)
Air quality sensor (Dust)	Yes (Dust)
Sensor light	Good (Green, 0 - 100) ; Normal (Yellow, 101 - 200) ; Bad (Red, above 200)
Weight	69g

Troubleshooting

Problem	Solution
No picture from a camera	<ol style="list-style-type: none"> 1. Check all connections to the camera. Make sure the adapter is plugged in. 2. Make sure that the cameras and monitor are both ON. 3. Make sure that the camera is in range of the monitor. 4. Make sure the camera and monitor are paired. 5. Adjust the monitor antenna to vertical position.
The picture is or has become choppy	<p>The picture may become choppy when experiencing a lower frame rate (i.e. 10 frames per second vs. a higher 20 frames per second).</p> <ol style="list-style-type: none"> 1. Try moving the camera closer to the monitor. 2. Remove obstructions between the monitor and camera. 3. Adjust the monitor antenna to vertical position.
No sounds (even with both units turned on)	<ol style="list-style-type: none"> 1. Make sure that the power adapter is connected to the camera. 2. The battery on the monitor may be dead, be sure to charge it using the adapter included. 3. The monitor may be out of range of the camera; be sure to check if the Range LED is on continuously.

Problem	Solution
Your BrightVIEW is emitting an high pitched noise/ feedback.	This sound is normal feedback which occurs if the monitor and camera are too close together. Move them further apart.



- Low batteries will cause the supply current to become unstable and will affect the quality of the video/audio. Please charge the battery fully for use for superior video.



Hanwha Techwin cares for the environment at all product manufacturing stages, and is taking measures to provide customers with more environmentally friendly products. The Eco mark represents Hanwha Techwin's devotion to creating environmentally friendly products, and indicates that the product satisfies the EU RoHS Directive.



Correct disposal of batteries in this product

(Applicable in the European Union and other European countries with separate battery return systems.)

This marking on the battery, manual or packaging indicates that the batteries in this product should not be disposed of with other household waste at the end of their working life. Where marked, the chemical symbols Hg, Cd or Pb indicate that the battery contains mercury, cadmium or lead above the reference levels in EC Directive 2006/66. If batteries are not properly disposed of, these substances can cause harm to human health or the environment.

To protect natural resources and to promote material reuse, please separate batteries from other types of waste and recycle them through your local, free battery return system.



Correct Disposal of This Product

(Waste Electrical & Electronic Equipment)

(Applicable in the European Union and other European countries with separate collection systems)

This marking on the product, accessories or literature indicates that the product and its electronic accessories (e.g. charger, headset, USB cable) should not be disposed of with other household waste at the end of their working life. To prevent possible harm to the environment or human health from uncontrolled waste disposal, please separate these items from other types of waste and recycle them responsibly to promote the sustainable reuse of material resources.

Household users should contact either the retailer where they purchased this product, or their local government office, for details of where and how they can take these items for environmentally safe recycling.

Business users should contact their supplier and check the terms and conditions of the purchase contract. This product and its electronic accessories should not be mixed with other commercial wastes for disposal.

TEMPLATE

This template is used to install the camera on the wall.

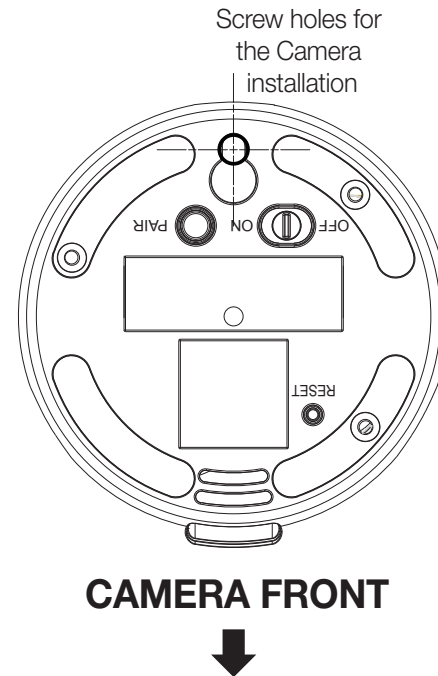

Head Office

86 Cheonggyecheon-ro Jung-gu Seoul 04541 Korea
Tel +82.2.729.5277, 5254 Fax +82.2.729.5489
www.hanwha-security.com

Hanwha Techwin America

500 Frank W. Burr Blvd. Suite 43 Teaneck, NJ 07666
Toll Free +1.877.213.1222 Direct +1.201.325.6920
Fax +1.201.373.0124

Hanwha Techwin Europe

Heriot House, Heriot Road, Chertsey, Surrey, KT16 9DT, United Kingdom
Tel +44.1932.57.8100 Fax +44.1932.57.8101

