SAMSUNG TECHWIN

WIRELESS MONITORING SYSTEM

User Manual

SEW-3034WN , SEB-1017RW



CE



Wireless Monitoring System User Manual

Copyright

©2011 Samsung Techwin Co., Ltd. All rights reserved.

Trademark

 **SAMSUNG TECHWIN** is the registered logo of Samsung Techwin Co., Ltd. The name of this product is the registered trademark of Samsung Techwin Co., Ltd. Other trademarks mentioned in this manual are the registered trademark of their respective company.

Restriction

Samsung Techwin Co., Ltd shall reserve the copyright of this document. Under no circumstances, this document shall be reproduced, distributed or changed, partially or wholly, without formal authorization of Samsung Techwin.

Disclaimer

Samsung Techwin makes the best to verify the integrity and correctness of the contents in this document, but no formal guarantee shall be provided. Use of this document and the subsequent results shall be entirely on the user's own responsibility. Samsung Techwin reserves the right to change the contents of this document without prior notice.

SPECIFY SERVICE INSTRUCTIONS AND WARRANTY TERMS

This device complies with part 15 of the FCC Rules. Operation is subject to the following two conditions: (1) this device may not cause harmful interference; and (2) this device must accept any interference received, including interference that may cause undesired operation.

This equipment has been tested and found to comply with the limits for a Class B digital device, pursuant to Part 15 of FCC Rules. These limits are designed to provide reasonable protection against harmful interference in a residential installation. This equipment generates, uses, and can radiate radio frequency energy. If not installed and used in accordance with the instructions, it may cause harmful interference to radio communications. However, there is no guarantee that interference will not occur in a particular installation. If this equipment does cause harmful interference to radio or television reception, which can be determined by turning the equipment off and on, the user is encouraged to try and correct the interference by one or more of the following measures:

- Reorient or relocate the receiving antenna.
- Increase the distance between the equipment and the receiver.
- Connect the equipment to outlet on a circuit different from that to which the receiver is connected.
- Consult the dealer or an experienced radio/TV technician for help.

Any changes or modifications not expressly approved by the party responsible for compliance could void the user's authority to operate the equipment.

FCC NOTE:

THE MANUFACTURER IS NOT RESPONSIBLE FOR ANY RADIO OR TV INTERFERENCE CAUSED BY UNAUTHORIZED MODIFICATIONS TO THIS EQUIPMENT. SUCH MODIFICATIONS COULD VOID THE USER'S AUTHORITY TO OPERATE THE EQUIPMENT.

WARNING

- Some adult assembly or installation required.
- This product contains small parts that may cause choking. Keep small parts away from children.
- This product is NOT intended to replace proper supervision of children. You MUST check your child's activity regularly, as this product will not alert parents to silent activities of a child.
- Before using this product, read and follow all instructions contained in this booklet, and read and follow all instructions and warnings on the product.
- To prevent entanglement with adapter cords, NEVER PLACE THE CORD IN OR NEAR A CRIB OR PLAYPEN. DO NOT place the product or its AC adapter cords within reach of children.
- ALWAYS KEEP THE TRANSMITTER, RECEIVER AND AC ADAPTERS OUT OF REACH OF CHILDREN.
- NEVER use the transmitter or receiver near water, including near a bathtub, sink, laundry tub, wet basement, etc.
- This product is intended for indoor use only.
- This product is not intended for use as a medical monitor and its use should not replace adult supervision.
- Check reception regularly. Test monitor before use and after changing camera location.
- Always unplug AC adapters from wall outlets and power sources during periods of non-use.

The wireless signal transfer range may be shortened if there exists an obstacle such as a concrete wall between.

“ This appliance and its antenna must not be collocated or operation in conjunction with any other antenna or transmitter. A minimum separation distance of 20 cm must be maintained between the antenna and the person for this appliance to satisfy the RF exposure requirements.”

- To prevent overheating, keep the product and AC power adapters away from any direct sunlight and heat sources such as radiators, heat registers, cooking devices (e.g., stoves and ovens) and other appliances that produce heat (e.g., amplifiers, televisions and stereos).
- Ensure that the product is well ventilated during use. Avoid contact with pillows and furniture that may block ventilation.
- Use only the AC adapters provided with the product, as other adapters may damage the product. Plug the adapters only into standard household current (120 volts AC). Place the AC adapters avoiding pinch points otherwise you can damage the adapters.
- When an AC adapter is plugged into a power source, DO NOT touch the exposed end of the AC adapter's cord.
- Do not use extension cords with the AC power adapters to avoid entanglement.
- This product should only be serviced by qualified and authorized Samsung service centers.
- Images and sounds are transmitted by the product over public airwaves and transmissions may be picked up by other units.
- Caution if you use the system to watch a young child, do not place the camera where the child can reach.
- When using the system with only battery power and the charge is low, then the picture and or sound may be affected.
- If this occurs then please connect the AC power adapter and/or replace with new batteries.
- If you are using the optional rechargeable battery then plug in the AC power adapter to recharge.

BATTERY WARNING

When using the product in portable mode, check batteries regularly.

DO NOT use the monitor in portable mode when batteries are low.

- DISPOSE OF OR RECYCLE BATTERIES PROPERLY IN ACCORDANCE WITH APPLICABLE LAWS, which may vary by location.
- Insert batteries with the correct polarity.
- Do not mix new and used batteries.
- Remove exhausted batteries from the product.
- Keep all batteries away from children.
- THERE IS A RISK OF EXPLOSION IF INCORRECT BATTERIES ARE USED.
- Do not disassemble or modify the battery pack.
- Do not use batteries if there is any evidence of leakage or deformity.

Contents

GETTING STARTED

Features	4
Getting to know your Monitoring system	5

INSTALLATION

How to Install	9
Viewing Mode Display.....	10

MENU OPERATION

Menu Operation	11
----------------------	----

APPENDIX

Hardware and CD driver installation	13
Specifications	13
Troubleshooting	14

GETTING STARTED

Features

- Samsung's digital wireless technology provides excellent image quality and clarity.
- Virtually eliminates interference using a secure and private signal
- Up to 100m/330ft wireless open space transmission range.
The actual range may vary depending on the use environment.
- Listen in with exceptional sound clarity
- Safety warning feature on monitor notifies you when the camera is out of range of the transmitter.
- System is expandable up to 4 cameras (additional cameras sold separately).
- Two-way audio communication.
- Camera temperature display on monitor.
- Built-in music player with 4 different tunes.

Camera Features

- VGA resolution camera.
- Night vision allows for low-light viewing up to 3.0m/10ft .
Performance varies depending on environmental conditions.
- Built-in microphone and speaker.
- Camera can be battery operated for true portable wireless operation.
- Plays up to 4 different tunes activated from monitor.
- Nightlight

Receiver Features

- 3.5" color LCD monitor/receiver with superior image quality.
- Video/Audio output for viewing on TV/Monitor or recording on VCR/DVD recorder.
- Rechargeable lithium polymer battery for true portability.
- Audio level indicator and alarm.
- Room temperature display.

What's Included

The system comes with the following components:



Adapter (2EA)

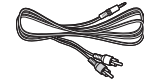

RCA Cable

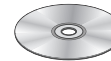

CD

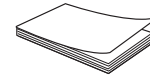

User Manual

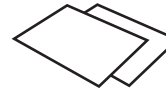

Warranty Card & Quick Guide



Screws (2EA) & Plastic anchor (2EA)



Wire Clips (6EA)

Check your package to confirm that you have received the complete system, including all components shown above.

Getting to know your Monitoring system

Wireless Receiver

After opening the box, fully charge the monitor before use. After initial charge, recharge as needed.

Front Controls

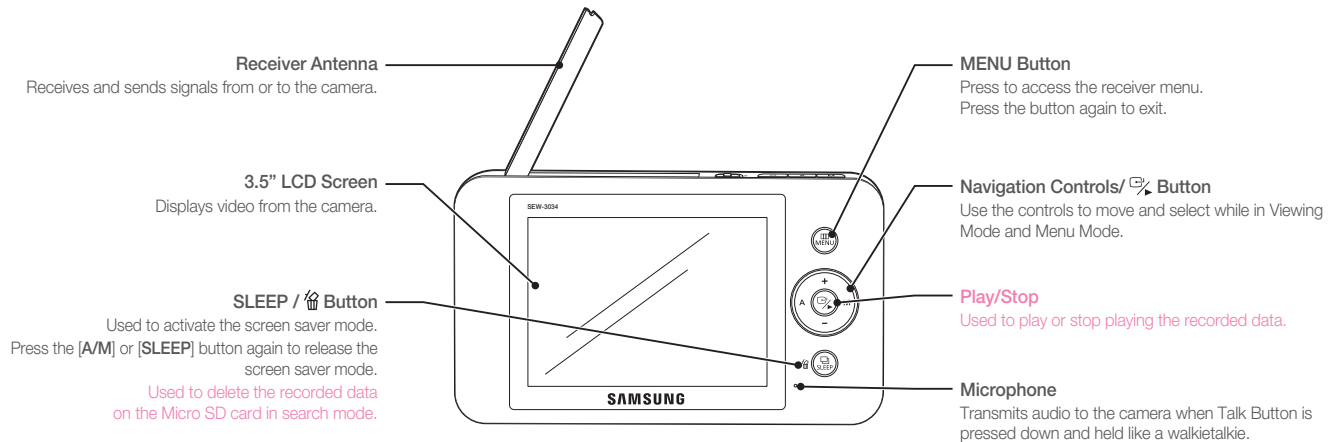

◇ Navigation Controls / Button

Viewing Mode: The following controls are used while watching live video from the camera:

- Press the [+] or [-] keys to increase or decrease the volume.
- Press the [A] key to view cameras in automatic switching mode.
- Press the [M] key to manually switch between cameras.

Menu Mode: Use the [+/-/A/M] key arrows to navigate in Menu Mode.
Press the [] button to confirm the menu selection.

Back Controls

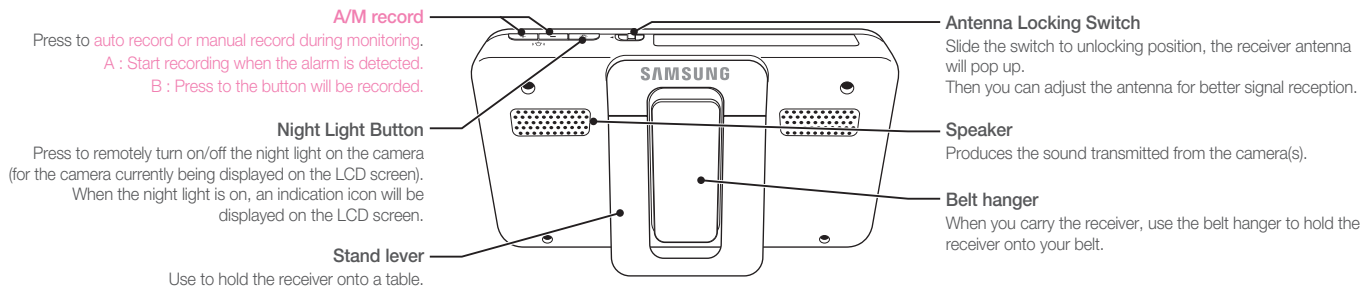

- You must have more than one camera configured on the system when using the functions that requires more than one camera.

Side Controls

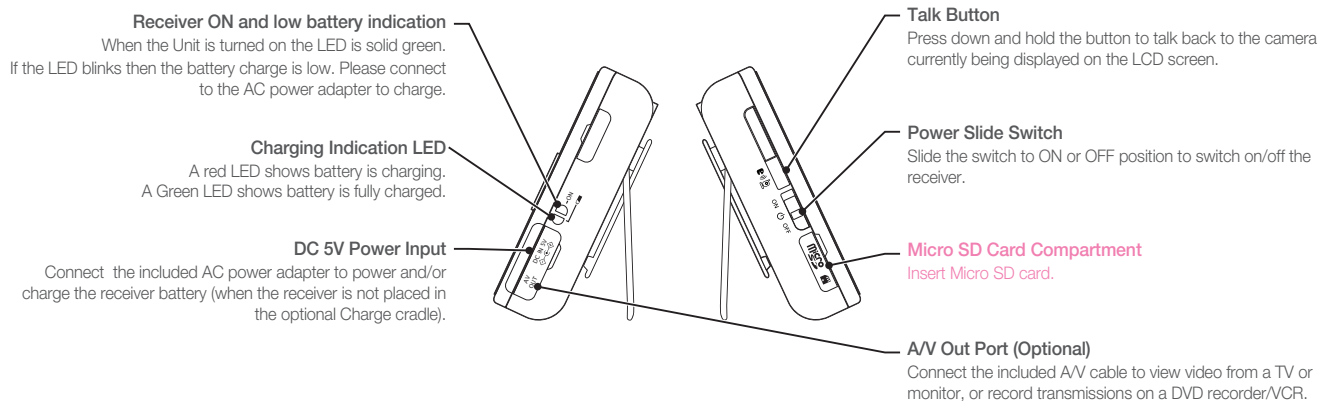

- Using this feature will disable the LCD screen. The LCD screen will turn back on when the A/V cable is disconnected.

Wireless Camera

Front & Back Controls

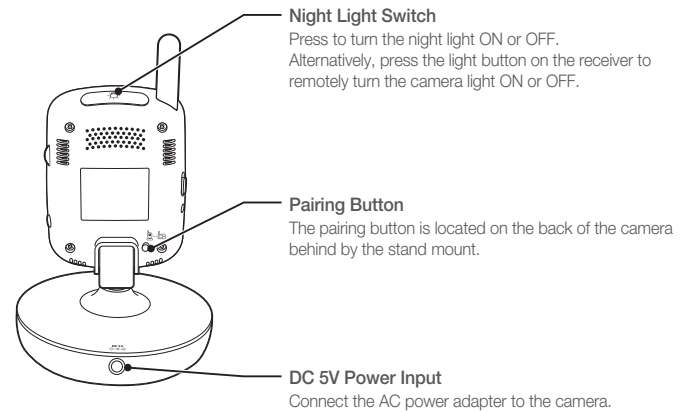
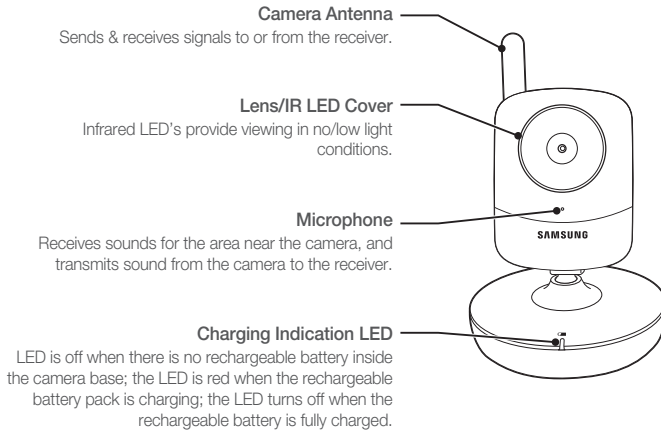

- The camera can also be powered using 3 AA batteries (not included) installed in the base. If the camera is plugged in with the AC adapter, the batteries will not be used. The batteries are intended for short term, portable camera use.
- Night Light is available only when the camera is paired to the receiver.

Side Controls

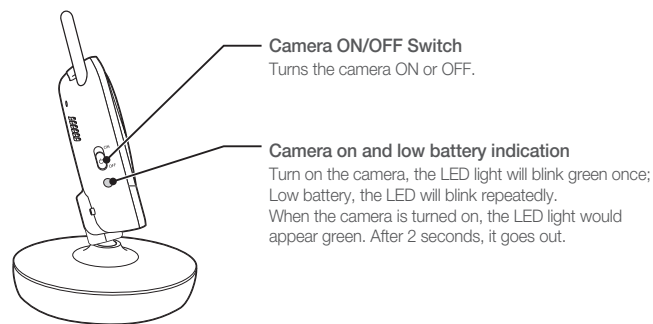
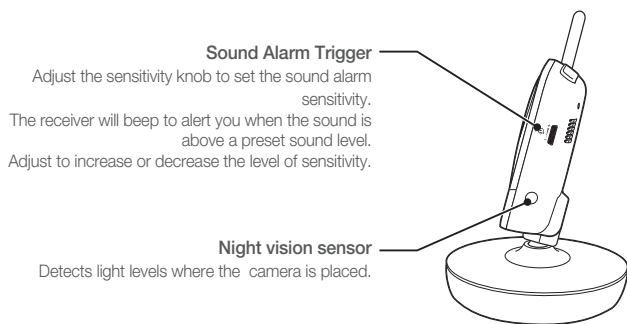

To Use The Battery Mode

You can use the battery to power the camera if it's distant from the power source or if you want to carry the camera.



- This camera has built-in IR LED's, which provides the camera with the ability to view images in no/low light conditions. It is important to use the provided power adapter (and not the batteries) when using the camera for prolonged periods in low light conditions, as the built-in IR LED's will deplete the battery more quickly than regular daytime use.

1. Remove the battery cover from the base of the camera.
2. Insert 3 AA batteries (not included) into the Battery Pack. Make sure to correctly line up the Positive (+) and negative (-) terminals of the batteries.
3. Replace the battery pack cover.
When the battery level is low and requires recharging, the LED light will blink intermittently.

When using the system with only battery power and the charge is low, then the picture and or sound may be affected.

If this occurs then please connect the AC power adapter and/or replace with new batteries.

If you want to use the product for a longer time than using the default AA battery without the AC adapter, purchase the optional charging battery (SEA-B100).

If you are using the optional rechargeable battery then plug in the AC power adapter to recharge

BATTERY WARNING

When using the product in portable mode, check batteries regularly.

DO NOT use the monitor in portable mode when batteries are low.

- DISPOSE OF OR RECYCLE BATTERIES PROPERLY IN ACCORDANCE WITH APPLICABLE LAWS, which may vary by location.
- Insert batteries with the correct polarity.
- Do not mix new and used batteries.
- Remove exhausted batteries from the product.
- Keep all batteries away from children.
- THERE IS A RISK OF EXPLOSION IF INCORRECT BATTERIES ARE USED.
- Do not disassemble or modify the battery pack.
- Do not use batteries if there is any evidence of leakage or deformity.

INSTALLATION

How to Install

Caution if you use the system to watch a young child, do not place the camera where the child can reach.

Wireless Receiver

1. Place the receiver in a place that will have clear reception with your camera(s).
2. Pull out the stand.



- Do not pull up the stand lever with an excessive force. Otherwise, it may be broken.

Wireless Camera

Before you install the camera, carefully plan where and how it will be positioned, and where you will route the cable that connects the camera to the power adapter. Before starting permanent installation, verify its performance by observing the image on the receiver when camera is positioned in the same location/position where it will be permanently installed and the receiver is placed in the location where it will be used most of the time.

Installation Warnings

Aim the camera(s) to best optimize the viewing area: Select a location for the camera that provides a clear view of the area you want to monitor, which is free from dust, and is not in line-of-sight to a strong light source or direct sunlight.

Avoid installing the camera where there are thick walls or obstructions between the camera and the receiver.

1. Carefully unpack the camera.

If you are installing cameras that did not come with the system, please see the pairing camera section of this manual for details on installation.

2. Mount the camera to the wall.

Mark the position of the screw holes on the wall, and drill holes and insert 2 screws, then firmly attach the camera to the wall by placing the stand over the installed screws and pushing the base downwards.



- The camera can also be placed on a flat surface, such as a table or shelf, and no mounting hardware is required.

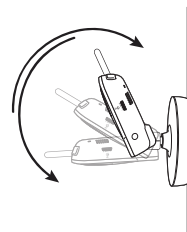

3. Adjust the viewing angle of the camera



- You can install additional cameras (maximum of 4 cameras). When adding cameras that were not included in the original box, you will need to pair up the cameras with the receiver. For pairing to add a camera, refer to **"Pairing"**. (Page 12)

How it works in viewing mode

If you want to view the child's scene (on the camera display) on a larger screen such as TV or computer monitor, use the provided AV cable to connect the wireless receiver with the TV.



- When using with a TV or computer monitor, the picture may appear to be grainy as the camera limits video resolution to VGA. This is not a product defect. For best performance, use with the TV/Monitor PIP (Picture in Picture) function. Check your TV/Monitor product manual to see if this feature is available on your TV/Monitor.
- When connected to the TV or monitor, the receiver will display the message of **"AV monitoring"**.

Viewing Mode Display

Wireless Receiver

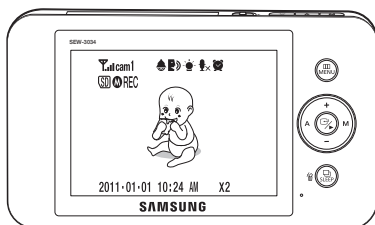

Signal Indicator

The signal indicator shows the strength of the signal being received from the camera. The number of bars in the signal indicator shows the strength of the signal – One or no bars indicate the signal is poor, and 4 bars indicate a strong signal.



Camera Number

Indicates the number of camera that is displayed on the current screen. Press the [M] key on the receiver to switch between available cameras.



- To automatically switch between channels, press the [A] key (AUTO).
- For pairing to add a camera, refer to “Pairing”. (Page 12)



Trigger Alert

Indicates the type of alert when audio is detected on the camera.

The Trigger Alert volume will be adjusted with the applicable message on the screen.

Press the [-] key to decrease the volume, and press the [+] key to increase the volume.



Talk

It displays if you press and hold [M] in the left corner.

Indicates that it is on talking mode.



Night light

If you press [NIGHT] in the wireless receiver or wireless camera, the night light of the wireless camera turns on with the applicable message.



Auto Mute

If you set Auto Mute to <YES>, the applicable message appears on the screen.



Micro SD card status

Indicates when a Micro SD card is inserted.

It displays the recording type if you press record button.



A/M record

Press to auto record or manual record during monitoring.

REC A : Auto Recording - Start recording when the alarm is detected.

REC M : Manual Recording - Press to the button will be recorded.



Volume adjustment

The receiver volume can be adjusted by using the [+], [-] keys when viewing a camera.

Press the [-] key to decrease the volume, and press the [+] key to increase the volume. When the volume is set to one bar (lowest setting), the volume will be muted and no sound will be emitted by the device.

The volume adjustment icon will be displayed during volume changes, and will disappear after 10 seconds of inactivity.



Alarm

Indicates if the alarm set to <ON>.

Time/ZOOM

Displays the time that is set in the current receiver.

Displays zoom size if it sets x2.

No Signal Warnings

You will see the following warning message when the camera is out of range of the receiver.

The “OUT OF RANGE” message means the receiver cannot access the camera.

Please reposition the camera, or check the camera power.

MENU OPERATION

Menu Operation

How to use the buttons to setup

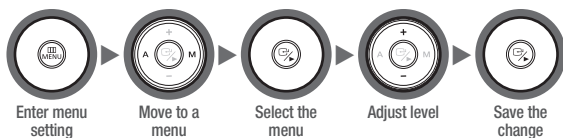

1. Press **[MENU]** button to enter the menu setting or exit the menu setting.
2. Move to other menu by press **[A]** or **[M]** key.
3. Press the **[OK]** button for option selection mode.
4. Adjust option level by **[+]** or **[-]** key.
5. Press the **[OK]** button to complete.

Buttons used in setup icon



Brightness

Adjusts the brightness of the image.



Zoom

Zoom in 1x or 2x of the video image.

In double size mode, press the navigation control buttons to pan up/down and left/right while viewing live image.



Power Saving

Enables receiver power save mode (when no activity on the camera is detected).

The Power Saving Menu is used to turn off the screen at a predetermined time, to conserve battery power.

After selected time, the monitor will go to a select screen saver or black screen if blank is selected as the screen saver.

Power Saving mode will be deactivated by pushing any key on the front panel of monitor or by higher sound detected by cameras.

If Power Saving mode is deactivated by pushing **[A]**, **[M]** and **[SLEEP]**, the monitor will go back to black screen after the time you set if there is no sound trigger during that time.

If Power Saving mode is deactivated by a sound trigger, the device will go back to black screen approximately 8 seconds after the last trigger.



Screen Saver

After selected time, the monitor will go to a select screen saver or black screen if blank is selected as the screen saver.



Auto Mute

Automatically cuts off the audio when there is only slight environmental noise on the camera side.

Choose **<YES>** to enable this function.

If auto mute is enabled, the receiver will automatically mute if there is no audio detected from the camera. If the audio is detected on the camera, the receiver will automatically unmute.



Alert Setting

Select the type of alert when audio is detected on the camera.

You may select the Vibration or Beep as the trigger alert manner while something has been detected by camera side.



Alarm Setting

Sets the time value with HH, MM and select the ON or OFF to decide alarm or not.



Date Setting

Sets the year, month, date value to show in the monitor screen.



Date Format

Sets the date format to show in the monitor screen.



Time Setting

Sets the time value with hour, minute to show in the monitor screen.



A/V Out Format

Choose the TV system when outputting the video/audio to TV, DVR/VCR or other viewing/recording devices.



Pairing

You can register a wireless camera with the receiver using the registration menu where you can view the video of the selected wireless camera.

Pairing The system comes with a camera that has already been paired with the receiver unit.

The pairing function assigns the camera to a channel on the wireless receiver.

Up to 4 Cameras (each additional camera sold separately) may be paired, which each optional camera on its own channel.

If additional cameras are paired, they must each be configured separately.



- It is highly recommended to pair the cameras to the receiver before permanently mounting the cameras. See the pairing section on this manual for details.



Reset

Choose <YES> to reset the receiver to factory defaults.

All menu settings will be reset.



- Camera pairing settings will NOT be affected by a reset. The camera will remain paired with the receiver.



Memory-format

Delete recorded data Choose <YES> to delete all data.

Pairing Camera

- Power on and turn the switch to ON.
The power LED for the camera and receiver should be ON.
- Press the [MENU] button on the receiver.
- Select Pairing menu by pressing [A] or [M] key.
Press the [%] button to go into the Pairing menu.
- Select a channel by pressing the [+] or [-] key.
The receiver will count down from 30~0 sec as showing a message you must press the pairing button on the camera during this time to successfully pair the camera.
- Press the [E] button on the back of the camera.
If not, the receiver will return to the view screen, and no pairing will take place.
Once the camera has been paired, it will be immediately viewable on the receiver monitor.

USA-Federal Communications Commission (FCC)

This device complies with part 15 of the FCC Rules. Operation is subject to the following two conditions: (1) this device may not cause harmful interference; and (2) this device must accept any interference received, including interference that may cause undesired operation.

This equipment has been tested and found to comply with the limits for a Class B digital device, pursuant to Part 15 of FCC Rules. These limits are designed to provide reasonable protection against harmful interference in a residential installation. This equipment generates, uses, and can radiate radio frequency energy. If not installed and used in accordance with the instructions, it may cause harmful interference to radio communications. However, there is no guarantee that interference will not occur in a particular installation. If this equipment does cause harmful interference to radio or television reception, which can be determined by turning the equipment off and on, the user is encouraged to try and correct the interference by one or more of the following measures:

- Reorient or relocate the receiving antenna.
- Increase the distance between the equipment and the receiver.
- Connect the equipment to outlet on a circuit different from that to which the receiver is connected.
- Consult the dealer or an experienced radio/TV technician for help.

Any changes or modifications not expressly approved by the party responsible for compliance could void the user's authority to operate the equipment.

Hardware and CD driver installation

- Put CD into CD ROM on computer and click the icon of Install USB Driver to run installation program.
- Click the <Next> button to continue
- Select "I accept the terms of the license agreement" and then press <Next> button.
- Click the <Browse...> button, select the destination folder and then press <Next> button.
- Press the <Finish> button to complete the driver program.
- After installation is finished, you can find "Wireless Monitoring System" in the Device Manager



- It can also work as a wireless webcam for MSN Messenger and SKYPE after installation is complete.

Specifications

Item	Details	Item	Details
Camera		Operating Humidity	85% RH
Transmit Frequency Range	2.400GHz~2.4835GHz	Weight	143.5 g
Data Rate	2.0 Mbps	Size(WXHXD)	94 X 148 X 94 mm
Transmitting Power	16dBm (MAX)	Receiver	
Modulation Type	GFSK	Receiving Frequency Range	2.400GHz~2.4835GHz
Transmitting Distance	100m (Line of Sight)	Monitor	3.5" Color LCD
Image Sensor Type	1/4" Color CMOS Image Sensor	Data Rate	2.0 Mbps
Effective Pixels	H: 640 V: 480	Receiving Sensitivity	-81dBm
Image Processing	Motion JPEG	Demodulation Type	GFSK with FHSS
Image Resolution / Frame Rate	H: 640 V: 480 / 15FPS Max (H: 320, V:240 / 30 fps)	Resolution	320 x 240 (RGB)
White Balance	Auto	Viewing Angle	H: 120° V: 100°
Lens	4.9mm / F2.8	A/V Output / Resolution	VGA /QVGA Optional
Viewing Angle (Diagonal)	50°	Power Requirement	5V DC \pm 10%
Minimum Illumination	2 LUX (without IR LED illumination)	Power Consumption	450mA Max without charging
IR LED Type / Night Vision Range	940nm / 3m	Operating Temperature	-10°C ~ 50°C (14°F ~ 122°F)
Power Requirement	5V DC \pm 10%	Operating Humidity	85% RH
Power Consumption	500mA MAX (IR LED) 340mA (IR LED)	Weight	170 g
Operating Temperature	-10°C ~ 50°C (14°F ~ 122°F)	Size(WXHXD)	75 X 128 X 24.8 mm
		No. of cameras supported	Max. 4

Troubleshooting

If you have problems with the system, there is often a quick and simple solution. Please try the following:

Problem	Solution
No picture from a camera	<ol style="list-style-type: none"> 1. Check all connections to the camera. Make sure the adapter is plugged in. 2. Make sure that the cameras and receiver are both ON. 3. Make sure that the camera is in range of the receiver. 4. If using the battery adapter, try replacing the batteries. 5. Make sure the camera and monitor are paired.
The picture is dropping	<ol style="list-style-type: none"> 1. Move the camera closer to the receiver. 2. Try repositioning the camera, receiver or both to improve the reception. 3. Adjust the monitor antenna to vertical position.
Audio problems	<ol style="list-style-type: none"> 1. Ensure that the volume on the TV is on. 2. Make sure that there is sound within range of the camera microphone. 3. If the unit emits a loud screeching noise (feedback), move the camera or receiver farther apart.
The picture is or has become choppy	<p>The picture may become choppy when experiencing a lower frame rate (i.e. 10 frames per second vs. a higher 20 frames per second).</p> <ol style="list-style-type: none"> 1. Try moving the camera closer to the receiver. 2. Remove obstructions between the receiver and camera. 3. Adjust the monitor antenna to vertical position.
The Picture appears to be grainy when using AV out function to view on a large screen TV/Monitor	<p>The purpose of the AV output is for convenience only. When using with large screen TV/Monitor, the picture might be grainy as the camera limits video resolution to VGA.</p> <p>This is not a product defect.</p> <ol style="list-style-type: none"> 1. For best performance use with TV/Monitor PIP (Picture in Picture) function. Check your TV/Monitor product manual to see if this feature is available on your TV/Monitor. 2. View video on a smaller screen TV/Monitor.



- Low batteries will cause the supply current to become unstable and will affect the quality of the video/audio. Please charge the battery fully or replace the batteries for use for superior video.



Samsung Techwin cares for the environment at all product manufacturing stages, and is taking measures to provide customers with more environmentally friendly products. The Eco mark represents Samsung Techwin's devotion to creating environmentally friendly products, and indicates that the product satisfies the EU RoHS Directive.



Correct disposal of batteries in this product

(Applicable in the European Union and other European countries with separate battery return systems.)

This marking on the battery, manual or packaging indicates that the batteries in this product should not be disposed of with other household waste at the end of their working life. Where marked, the chemical symbols Hg, Cd or Pb indicate that the battery contains mercury, cadmium or lead above the reference levels in EC Directive 2006/66. If batteries are not properly disposed of, these substances can cause harm to human health or the environment.

To protect natural resources and to promote material reuse, please separate batteries from other types of waste and recycle them through your local, free battery return system.



Correct Disposal of This Product

(Waste Electrical & Electronic Equipment)

(Applicable in the European Union and other European countries with separate collection systems)

This marking on the product, accessories or literature indicates that the product and its electronic accessories (e.g. charger, headset, USB cable) should not be disposed of with other household waste at the end of their working life. To prevent possible harm to the environment or human health from uncontrolled waste disposal, please separate these items from other types of waste and recycle them responsibly to promote the sustainable reuse of material resources.

Household users should contact either the retailer where they purchased this product, or their local government office, for details of where and how they can take these items for environmentally safe recycling.

Business users should contact their supplier and check the terms and conditions of the purchase contract. This product and its electronic accessories should not be mixed with other commercial wastes for disposal.

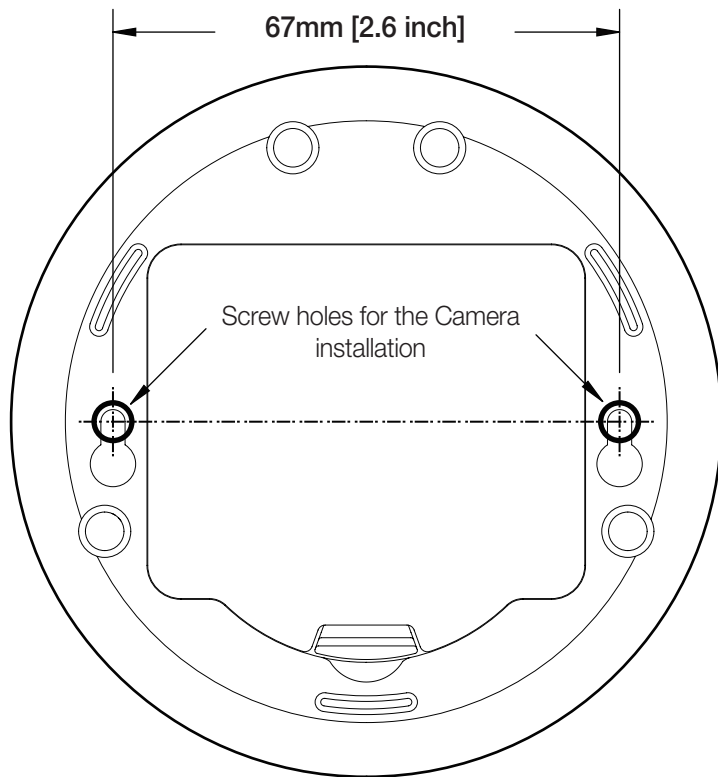

CAMERA FRONT



TEMPLATE

This template is used to install the camera on the wall.





SALES NETWORK

SAMSUNG TECHWIN CO., LTD.

Samsungtechwin R&D Center, 701, Sampyeong-dong, Bundang-gu, Seongnam-si, Gyeonggi-do, Korea, 463-400

TEL : +82-70-7147-8740~60 FAX : +82-31-8018-3745

SAMSUNG TECHWIN AMERICA Inc.

1480 Charles Willard St, Carson, CA 90746, UNITED STATES

Tol Free : +1-877-213-1222 FAX : +1-310-632-2195

www.samsungcctvusa.com

SAMSUNG TECHWIN EUROPE LTD.

Samsung House, 1000 Hillswood Drive, Hillswood Business Park Chertsey,
Surrey, UNITED KINGDOM KT16 OPS

TEL : +44-1932-45-5300 FAX : +44-1932-45-5325
