

Owner's Manual & Safety Instructions

Save This Manual Keep this manual for the safety warnings and precautions, assembly, operating, inspection, maintenance and cleaning procedures. Write the product's serial number in the back of the manual near the assembly diagram (or month and year of purchase if product has no number). Keep this manual and the receipt in a safe and dry place for future reference.

CHICAGO  **ELECTRIC**
POWER TOOLS

ITEM 69946

9.6 VOLT CORDLESS VARIABLE SPEED ROTARY TOOL KIT



Visit our website at: <http://www.harborfreight.com>
Email our technical support at: tech@harborfreight.com

When unpacking, make sure that the product is intact and undamaged. If any parts are missing or broken, please call 1-800-444-3353 as soon as possible.

WARNING





**Read this material before using this product.
Failure to do so can result in serious injury.
SAVE THIS MANUAL.**

Copyright © 2012 by Harbor Freight Tools®. All rights reserved.
No portion of this manual or any artwork contained herein may be reproduced in any shape or form without the express written consent of Harbor Freight Tools. Diagrams within this manual may not be drawn proportionally. Due to continuing improvements, actual product may differ slightly from the product described herein. Tools required for assembly and service may not be included.

Table of Contents

Safety	2	Maintenance	13
Specifications	8	Parts List and Diagram	15
Setup	8	Warranty	16
Operation	9		

WARNING SYMBOLS AND DEFINITIONS

	This is the safety alert symbol. It is used to alert you to potential personal injury hazards. Obey all safety messages that follow this symbol to avoid possible injury or death.
	Indicates a hazardous situation which, if not avoided, will result in death or serious injury.
	Indicates a hazardous situation which, if not avoided, could result in death or serious injury.
	Indicates a hazardous situation which, if not avoided, could result in minor or moderate injury.
	Addresses practices not related to personal injury.

IMPORTANT SAFETY INFORMATION

General Power Tool Safety Warnings

WARNING

Read all safety warnings and instructions.

Failure to follow the warnings and instructions may result in electric shock, fire and/or serious injury.

Save all warnings and instructions for future reference.

The term "power tool" in the warnings refers to your battery-operated (cordless) power tool.

Work area safety

- 1. Keep work area clean and well lit.**
Cluttered or dark areas invite accidents.
- 2. Do not operate power tools in explosive atmospheres, such as in the presence of flammable liquids, gases or dust.** *Power tools create sparks which may ignite the dust or fumes.*
- 3. Keep children and bystanders away while operating a power tool.**
Distractions can cause you to lose control.

Electrical safety

Do not expose power tools to rain or wet conditions.

Water entering a power tool will increase the risk of electric shock.

Personal safety

- 1. Stay alert, watch what you are doing and use common sense when operating a power tool. Do not use a power tool while you are tired or under the influence of drugs, alcohol or medication.**
A moment of inattention while operating power tools may result in serious personal injury.
- 2. Use personal protective equipment. Always wear eye protection.**
Safety equipment such as dust mask, non-skid safety shoes, hard hat, or hearing protection used for appropriate conditions will reduce personal injuries.
- 3. Prevent unintentional starting. Ensure the Switch is in the off-position before connecting to power source, picking up or carrying the tool.**
Carrying power tools with your finger on the Switch or energizing power tools that have the Switch on invites accidents.
- 4. Do not overreach. Keep proper footing and balance at all times.**
This enables better control of the power tool in unexpected situations.
- 5. Dress properly. Do not wear loose clothing or jewelry. Keep your hair, clothing and gloves away from moving parts.**
Loose clothes, jewelry or long hair can be caught in moving parts.
- 6. If devices are provided for the connection of dust extraction and collection facilities, ensure these are connected and properly used. Use of these devices can reduce dust-related hazards.**
- 7. Only use safety equipment that has been approved by an appropriate standards agency.**
Unapproved safety equipment may not provide adequate protection. Eye protection must be ANSI-approved and breathing protection must be NIOSH-approved for the specific hazards in the work area.

Power tool use and care

- 1. Do not force the power tool. Use the correct power tool for your application.**
The correct power tool will do the job better and safer at the rate for which it was designed.
- 2. Do not use the power tool if the Switch does not turn it on and off.**
Any power tool that cannot be controlled with the Switch is dangerous and must be repaired.
- 3. Disconnect the battery pack from the power tool before making any adjustments, changing accessories, or storing power tools. Such preventive safety measures reduce the risk of starting the power tool accidentally.**
- 4. Store idle power tools out of the reach of children and do not allow persons unfamiliar with the power tool or these instructions to operate the power tool. Power tools are dangerous in the hands of untrained users.**
- 5. Maintain power tools. Check for misalignment or binding of moving parts, breakage of parts and any other condition that may affect the power tool's operation. If damaged, have the power tool repaired before use. Many accidents are caused by poorly maintained power tools.**
- 6. Keep cutting tools sharp and clean. Properly maintained cutting tools with sharp cutting edges are less likely to bind and are easier to control.**
- 7. Use the power tool, accessories and tool bits etc. in accordance with these instructions, taking into account the working conditions and the work to be performed. Use of the power tool for operations different from those intended could result in a hazardous situation.**

Battery tool use and care

1. **Recharge only with the charger specified by the manufacturer.** A charger that is suitable for one type of battery pack may create a risk of fire when used with another battery pack.
2. **Use power tools only with specifically designated battery packs.** Use of any other battery packs may create a risk of injury and fire.
3. **When battery pack is not in use, keep it away from other metal objects, like paper clips, coins, keys, nails, screws or other small metal objects, that can make a connection from one terminal to another.** Shorting the battery terminals together may cause burns or a fire.
4. **Under abusive conditions, liquid may be ejected from the battery; avoid contact. If contact accidentally occurs, flush with water. If liquid contacts eyes, additionally seek medical help.** Liquid ejected from the battery may cause irritation or burns.

Service

Have your power tool serviced by a qualified repair person using only identical replacement parts. This will ensure that the safety of the power tool is maintained.

Safety Warnings Common for Grinding, Sanding, Wire Brushing, or Polishing Operations

1. **This power tool is intended to function as a grinder, sander, wire brush, or polisher. Read all safety warnings, instructions, illustrations and specifications provided with this power tool.** Failure to follow all instructions listed below may result in electric shock, fire and/or serious injury.
2. **Use as intended only.** Operations for which the power tool was not designed may create a hazard and cause personal injury.
3. **Do not use accessories which are not specifically designed and recommended by the tool manufacturer.** Just because the accessory can be attached to your power tool, it does not assure safe operation.
4. **The rated speed of the accessory must be at least equal to the maximum speed marked on the power tool.** Accessories running faster than their RATED SPEED can break and fly apart.
5. **The outside diameter and the thickness of your accessory must be within the capacity rating of your power tool.** Incorrectly sized accessories cannot be adequately guarded or controlled.
6. **The arbor size of wheels, flanges, backing pads or any other accessory must properly fit the collet of the power tool.** Accessories with arbor holes that do not match the mounting hardware of the power tool will run out of balance, vibrate excessively and may cause loss of control.
7. **Do not use a damaged accessory. Before each use inspect the accessory such as abrasive wheels for chips and cracks, backing pad for cracks, tear or excess wear, wire brush for loose or cracked wires. If power tool or accessory is dropped, inspect for damage or install an undamaged accessory. After inspecting and installing an accessory, position yourself and bystanders away from the plane of the rotating accessory and run the power tool at maximum no-load speed for one minute.** Damaged accessories will normally break apart during this test time.
8. **Wear personal protective equipment. Depending on application, use face shield, safety goggles or safety glasses. As appropriate, wear dust mask, hearing protectors, gloves and workshop apron capable of stopping small abrasive or**

- workpiece fragments. The eye protection must be capable of stopping flying debris generated by various operations.**
The eye protection must be capable of stopping flying debris generated by various operations. The dust mask or respirator must be capable of filtering out particles generated by your operation. Prolonged exposure to high intensity noise may cause hearing loss.
9. **Keep bystanders a safe distance away from work area. Anyone entering the work area must wear personal protective equipment.** Fragments of workpiece or of a broken accessory may fly away and cause injury beyond immediate area of operation.
 10. **Hold power tool by insulated gripping surfaces only, when performing an operation where the accessory may contact hidden wiring or its own cord.**
An accessory contacting a "live" wire may make exposed metal parts of the power tool "live" and shock the operator.
 11. **Never lay the power tool down until the accessory has come to a complete stop.**
The spinning accessory may grab the surface and pull the power tool out of your control.
 12. **Do not run the power tool while carrying it at your side.** *Accidental contact with the spinning accessory could snag your clothing, pulling the accessory into your body.*
 13. **Regularly clean the power tool's air vents.**
The motor's fan will draw the dust inside the housing and excessive accumulation of powdered metal may cause electrical hazards.
 14. **Do not operate the power tool near flammable materials.**
Sparks could ignite these materials.
 15. **Do not use accessories that require liquid coolants.** *Using water or other liquid coolants may result in electrocution or shock.*
 16. Maintain labels and nameplates on the tool. These carry important safety information. If unreadable or missing, contact Harbor Freight Tools for a replacement.
 17. Avoid unintentional starting.
Prepare to begin work before turning on the tool.
 18. Do not depress the spindle lock when starting or during operation.
 19. Do not leave the tool unattended when the Battery Pack is connected. Turn off the tool, and remove the Battery Pack before leaving.
 20.  The battery Charger gets hot during use. The Charger's heat can build up to unsafe levels and create a fire hazard if it does not receive adequate ventilation, due to an electrical fault, or if it is used in a hot environment.
Do not place the Charger on a flammable surface. Do not obstruct any vents on the Charger. **Especially avoid placing the Charger on carpets and rugs; they are not only flammable, but they also obstruct vents under the Charger.**
Place the Charger on a stable, solid, nonflammable surface (such as a stable metal workbench or concrete floor) at least 1 foot away from all flammable objects, such as drapes or walls. Keep a fire extinguisher and a smoke detector in the area. Frequently monitor the Charger and Battery Pack while charging.
 21. This product is not a toy.
Keep it out of reach of children.
 22. People with pacemakers should consult their physician(s) before use. Electromagnetic fields in close proximity to heart pacemaker could cause pacemaker interference or pacemaker failure.
 23. **WARNING:** Handling the cord on this product's Charger will expose you to lead, a chemical known to the State of California to cause cancer, and birth defects or other reproductive harm. Wash hands after handling. (California Health & Safety Code § 25249.5, et seq.)
 24. The warnings, precautions, and instructions discussed in this instruction manual cannot cover all possible conditions and situations that may occur.
It must be understood by the operator that common sense and caution are factors which cannot be built into this product, but must be supplied by the operator.

Safety Warnings Specific for Grinding and Abrasive Cutting-off Operations

1. **Use only wheel types that are recommended for your power tool and the specific guard designed for the selected wheel.** *Wheels for which the power tool was not designed cannot be adequately guarded and are unsafe.*
2. **Wheels must be used only for recommended applications. For example: do not grind with the side of cut-off wheel.** *Abrasive cut-off wheels are intended for peripheral grinding, side forces applied to these wheels may cause them to shatter.*
3. **Always use undamaged wheel flanges that are of correct size and shape for your selected wheel.** *Proper wheel flanges support the wheel thus reducing the possibility of wheel breakage. Flanges for cut-off wheels may be different from grinding wheel flanges.*
4. **Do not use worn down wheels from larger power tools.** *Wheel intended for larger power tool is not suitable for the higher speed of a smaller tool and may burst.*
5. **Dress appropriately.** *Do not wear pants with cuffs, shirts with open pockets, or any clothing that can catch and hold molten metal or sparks.*

Safety Warnings Specific for Wire Brushing Operations

Be aware that wire bristles are thrown by the brush even during ordinary operation. Do not overstress the wires by applying excessive load to the brush.
The wire bristles can easily penetrate light clothing and/or skin.

Vibration Safety

This tool vibrates during use. Repeated or long-term exposure to vibration may cause temporary or permanent physical injury, particularly to the hands, arms and shoulders. To reduce the risk of vibration-related injury:

1. Anyone using vibrating tools regularly or for an extended period should first be examined by a doctor and then have regular medical check-ups to ensure medical problems are not being caused or worsened from use. Pregnant women or people who have impaired blood circulation to the hand, past hand injuries, nervous system disorders, diabetes, or Raynaud's Disease should not use this tool. If you feel any medical or physical symptoms related to vibration (such as tingling, numbness, and white or blue fingers), seek medical advice as soon as possible.
2. Do not smoke during use. Nicotine reduces the blood supply to the hands and fingers, increasing the risk of vibration-related injury.
3. Wear suitable gloves to reduce the vibration effects on the user.
4. Use tools with the lowest vibration when there is a choice between different processes.
5. Include vibration-free periods each day of work.
6. Grip tool as lightly as possible (while still keeping safe control of it). Let the tool do the work.
7. To reduce vibration, maintain the tool as explained in this manual. If any abnormal vibration occurs, stop use immediately.



SAVE THESE INSTRUCTIONS.

Grounding

⚠️ WARNING



TO PREVENT ELECTRIC SHOCK AND DEATH FROM INCORRECT GROUNDING WIRE CONNECTION:

Check with a qualified electrician if you are in doubt as to whether the outlet is properly grounded. Do not modify the power cord plug provided with the tool.

Never remove the grounding prong from the plug. Do not use the tool if the power cord or plug is damaged. If damaged, have it repaired by a service facility before use. If the plug will not fit the outlet, have a proper outlet installed by a qualified electrician.

Double Insulated Tools: Tools with Two Prong Plugs

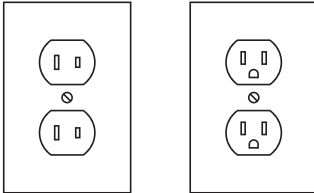

Figure A: Outlets for 2-Prong Plug

1. Tools marked “Double Insulated” do not require grounding. They have a special double insulation system which satisfies OSHA requirements and complies with the applicable standards of Underwriters Laboratories, Inc., the Canadian Standard Association, and the National Electrical Code.
2. Double insulated tools may be used in either of the 120 volt outlets shown in the preceding illustration. (See Figure A.)

Extension Cords

Note: Extension cords must not be used with this item’s Charger.

Symbology

	Double Insulated		Read the manual before set-up and/or use.
	Canadian Standards Association		WARNING marking concerning Risk of Fire. Do not cover ventilation ducts. Charge on fireproof surface only.
	Underwriters Laboratories, Inc.		WARNING marking concerning Risk of Electric Shock. Properly connect Charger’s power cord to appropriate outlet.
V~	Volts Alternating Current		WARNING marking concerning Risk of Explosion. Do not puncture, short, or open battery packs and do not charge damaged battery packs.
A	Amperes		
n ₀ xxxx/min.	No Load Revolutions per Minute (RPM)		
	WARNING marking concerning Risk of Eye Injury. Wear ANSI-approved safety goggles with side shields.		

Specifications

Battery Pack	9.6V NiCd
Charge Adapter	120 V~ to 12 VDC
Tool Speed	5,000 - 25,000 RPM
LED Source	(2) CR927 3V batteries

Setup - Before Use:



Read the **ENTIRE IMPORTANT SAFETY INFORMATION** section at the beginning of this manual including all text under subheadings therein before set up or use of this product.

Functions



Operating Instructions



Read the **ENTIRE IMPORTANT SAFETY INFORMATION** section at the beginning of this manual including all text under subheadings therein before set up or use of this product.

TOOL SET UP

Battery Charging

Charging the Battery Pack

Battery packs are normally shipped with low or no charge to prevent potential problems during shipment. Charge the battery pack before use.

Note: Batteries will not reach full charge the first time they are charged. Allow several cycles (operation followed by recharging) before the battery will become fully charged.

WARNING! Battery explosion may cause serious personal or property injury including death. Charge the battery only within a 50° to 100° F room temperature. Lower temperatures may inhibit charging. Higher temperatures increase chance of battery failure.



1. Charge the battery pack only with the included Charger Base (25). Use of other chargers may cause battery failure including explosion.

2. Ensure that the Charger Base (25) is connected to a circuit breaker protected 120 V~, 60 Hz power supply only.
3. Connect the Charger Base to the Transformer (24), by plugging it in as shown. Plug the Transformer (24) into a 120 V~ wall outlet.
4. Insert the battery pack into the Charger Base (25) by aligning the ribs on the Charger Base with the grooves in the battery pack. Press the battery pack into place.
5. Press down on the battery pack to make sure that the contacts on the battery pack are fully engaged with the contacts in the charger unit.
6. While being charged, the green LED will be lit, indicating that the charger is in operation. During recharging, the battery pack will become slightly warm to the touch. This is normal and not a cause for concern.
7. Do not place the battery and charger in an environment of extreme heat or cold. They will work best at room temperature.

Note: The Charger Base (25) will not shut off automatically. When the battery is fully charged (after 3 to 5 hours), unplug the battery charger and remove the battery pack. Do not leave the battery in the Charger Base (25) indefinitely.

Installing the Battery Pack

1. Place the battery pack in the tool, aligning the arrows on the battery pack with the arrows on the tool.
2. Press the battery pack into the tool. Make sure that the battery pack snaps into place, and that the battery pack is secure in the tool before beginning use.

Removing the Battery Pack

1. Press the Release Tabs (19) on both sides of the battery pack to release the battery from the tool.
2. Remove the battery pack from the tool by pulling straight out.

Inserting a Bit in the Tool

⚠ WARNING

TO PREVENT SERIOUS INJURY FROM ACCIDENTAL OPERATION:

Turn the Power Switch of the tool off, wait for the motor to stop, and remove the battery pack before adjusting tool or installing accessories.

TO PREVENT SERIOUS INJURY FROM ACCESSORY FAILURE:

Only use accessories that are rated at or above the RPM rating of the Cordless Rotary Tool.

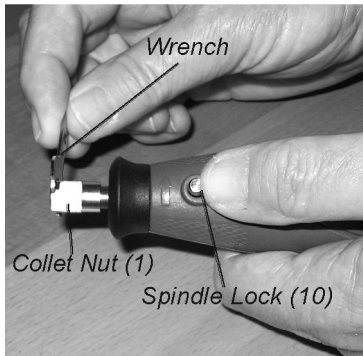

1. Depress the Spindle Lock (10). Rotate collet until shaft is engaged by the lock.
2. Loosen the Collet Nut (1) by turning it counterclockwise, using the Wrench provided.

WARNING! If you are changing a bit immediately after use, be careful not to touch the bit. It may be very hot from use, possibly causing injury. Allow the bit time to cool before handling it.

3. **To remove a bit:** Pull the bit straight out of the Collet once the Collet Nut is loose. **To insert a bit:** Insert the shank end of the bit into the Collet once the Collet Nut is loose.

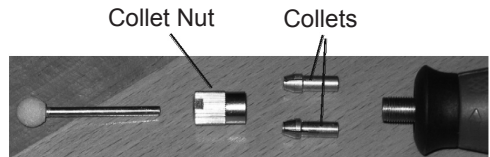

NOTE: Your tool is provided with two collets, 1/8" and 3/32" diameter. These are precision manufactured to fit comparably sized bits. Do not force a bit into the wrong sized collet, and do not modify a mismatched collet or bit.

Severe personal or property damage may result from using mismatched collets or bits.

4. Tighten Collet Nut securely using the provided wrench. Ensure that the spindle lock is released before turning on the tool.

Installing the Flexible Shaft

1. Turn the Rotary Tool OFF (the "O" position), and remove the Battery from the Handle before attaching the Flexible Shaft Attachment (26).
2. Remove any bits that might be installed. Remove the Collet Lock Nut and the Collet.
3. Remove the Collar or LED Collar from the tool Body by turning it counterclockwise.
4. Pass the end of the Flexible Shaft Core through the Collet Nut, and into the 1/8" Collet. Depress the Spindle Lock (10), and hold it down while tightening the Collet Nut with the Wrench.
5. When the Collet Nut is tight, release the Spindle Lock (10) and turn the Flexible Shaft Attaching Nut clockwise onto the tool body until hand tight.



Installing a Bit in the Flexible Shaft

1. Use the Round "L" Tool to prevent the Flexible Shaft Core from turning by inserting it into the hole in the side of the Flexible Shaft Handle.
2. Once "L" tool is in place, remove the Collet locking nut by turning it counterclockwise with the Wrench.
3. Place the bit into the appropriate sized collet.
4. Place the collet into the end of the Flexible Shaft Handle.
5. Place the Collet Locking Nut over the bit, and tighten it by turning clockwise.
6. Tighten in place using the Wrench and the Round "L" Tool.

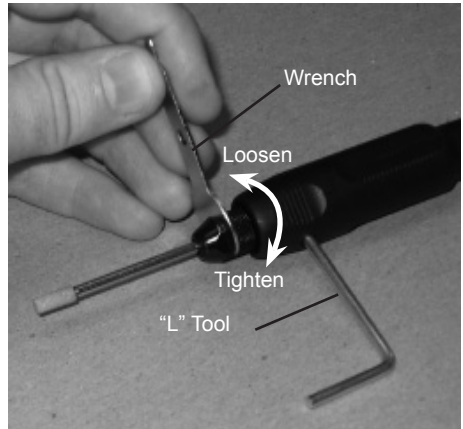

Installing or Removing Collars

The Front Collar (3) is interchangeable with the LED Collar (23).

1. Remove the previous collar by turning counterclockwise.
2. Install the LED Collar or standard collar by turning clockwise.

Note: When installing or removing, use only hand pressure and tighten firmly by hand. Do not overtighten, as this may damage the part.

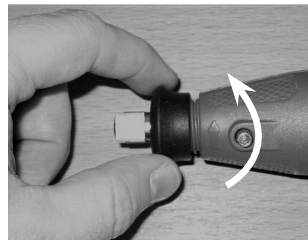

WORKPIECE AND WORK AREA SET UP

1. Designate a work area that is clean and well-lit. The work area must not allow access by children or pets to prevent distraction and injury.
2. Route the power cord along a safe route to reach the work area without creating a tripping hazard or exposing the power cord to possible damage. The power cord must reach the work area with enough extra length to allow free movement while working.
3. Secure loose workpieces using a vise or clamps (not included) to prevent movement while working.
4. There must not be objects, such as utility lines, nearby that will present a hazard while working.

GENERAL OPERATING INSTRUCTIONS

1. Charge the Battery Pack (18) and insert it in the tool, as described in the previous section.
2. Select an appropriate bit or attachment for the job. Insert the bit or attachment as described in the previous section.
3. The LED Collar may be turned on by moving the switch on the collar.
5. Apply the tool bit to the work material as needed.
6. When the task has been completed, stop the tool by rotating the Switch (8) to the OFF ("O") position. If the LED Collar is ON, switch it OFF. Unplug the rechargeable battery. Remove the bit or attachment as discussed in the previous section.
7. Store the tool, its battery, and its bits and attachments in their case in a safe location.

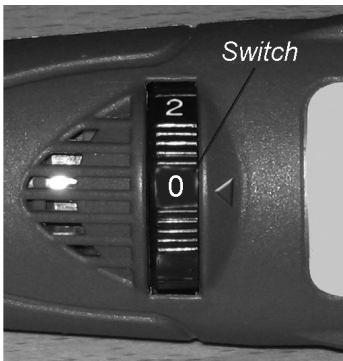

4. Rotate the Switch (8) to the ON position. This is a variable speed switch. The tool bit speed is dependent on the position of the Switch. Use a speed appropriate to the bit and the material being worked on. In general, harder materials require faster speeds and softer materials require slower speeds. Relative speeds are indicated by the numbers on the Switch.

Maintenance and Servicing



Procedures not specifically explained in this manual must be performed only by a qualified technician.

!WARNING

TO PREVENT SERIOUS INJURY FROM ACCIDENTAL OPERATION:
Turn the Power Switch of the tool off and remove the battery pack before performing any inspection, maintenance, or cleaning procedures.

TO PREVENT SERIOUS INJURY FROM TOOL FAILURE:
Do not use damaged equipment. If abnormal noise or vibration occurs, have the problem corrected before further use.

Cleaning, Maintenance, and Lubrication

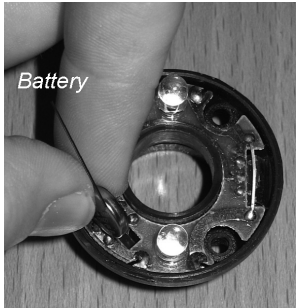
- BEFORE EACH USE**, inspect the general condition of the tool. Check for:
 - loose hardware,
 - misalignment or binding of moving parts,
 - cracked or broken parts,
 - damaged electrical wiring, and
 - any other condition that may affect its safe operation.
- AFTER USE**, wipe external surfaces of the tool with clean cloth.
- Protect the tool and its parts and accessories from moisture and humidity.
- Some of the bits provided are “grinding bits” using stone abrasives. During use, these may clog up with removed material or lose their shape. To clean and reshape these bits, run them against the provided Dressing Stone. The Dressing Stone will abrade away the clogging materials and will reshape the Grinding Bits as appropriate.
- NiCd BATTERY MUST BE RECYCLED OR DISPOSED OF PROPERLY.**
Do not short, incinerate or open battery.
- Dispose of used batteries properly. Consult your local hazardous waste authority for disposal guidelines.
- To change the batteries in the LED Collar:
 - Remove it from the Rotary Tool.A black, cylindrical LED collar with a lens on top and a battery compartment on the side.
 - Using a cross head screwdriver, open the battery compartment.A close-up view of a hand using a cross-head screwdriver to pry open the battery compartment cover of the LED collar. The word 'Battery' is written in white text above the compartment.
 - Replace the batteries with the same type as originally installed (Two CR-927, 3V batteries). Be sure to match the polarity marking in the battery compartment.

Troubleshooting

Problem	Possible Causes	Likely Solutions
Tool will not start.	<ol style="list-style-type: none"> 1. Cord not connected. 2. No power at outlet. 3. Internal damage or wear. (Carbon brushes or switch, for example.) 	<ol style="list-style-type: none"> 1. Check that cord is plugged in. 2. Check power at outlet. If outlet is unpowered, turn off tool and check circuit breaker. If breaker is tripped, make sure circuit is right capacity for tool and circuit has no other loads. 3. Have technician service tool.
Performance decreases over time.	<ol style="list-style-type: none"> 1. Accessory dull or damaged. 2. Carbon brushes worn or damaged. 	<ol style="list-style-type: none"> 1. Keep cutting accessories sharp. Replace as needed. 2. Have qualified technician replace brushes.
Excessive noise or rattling.	Internal damage or wear. (Carbon brushes or bearings, for example.)	Have technician service tool.
Overheating.	<ol style="list-style-type: none"> 1. Forcing tool to work too fast. 2. Accessory dull or damaged. 3. Blocked motor housing vents. 	<ol style="list-style-type: none"> 1. Allow tool to work at its own rate. 2. Keep cutting accessories sharp. Replace as needed. 3. Wear ANSI-approved safety goggles and NIOSH-approved dust mask/respirator while blowing dust out of motor using compressed air.
 <p>Follow all safety precautions whenever diagnosing or servicing the tool. Disconnect power supply before service.</p>		

PLEASE READ THE FOLLOWING CAREFULLY

THE MANUFACTURER AND/OR DISTRIBUTOR HAS PROVIDED THE PARTS LIST AND ASSEMBLY DIAGRAM IN THIS MANUAL AS A REFERENCE TOOL ONLY. NEITHER THE MANUFACTURER OR DISTRIBUTOR MAKES ANY REPRESENTATION OR WARRANTY OF ANY KIND TO THE BUYER THAT HE OR SHE IS QUALIFIED TO MAKE ANY REPAIRS TO THE PRODUCT, OR THAT HE OR SHE IS QUALIFIED TO REPLACE ANY PARTS OF THE PRODUCT. IN FACT, THE MANUFACTURER AND/OR DISTRIBUTOR EXPRESSLY STATES THAT ALL REPAIRS AND PARTS REPLACEMENTS SHOULD BE UNDERTAKEN BY CERTIFIED AND LICENSED TECHNICIANS, AND NOT BY THE BUYER. THE BUYER ASSUMES ALL RISK AND LIABILITY ARISING OUT OF HIS OR HER REPAIRS TO THE ORIGINAL PRODUCT OR REPLACEMENT PARTS THERETO, OR ARISING OUT OF HIS OR HER INSTALLATION OF REPLACEMENT PARTS THERETO.

Parts List and Diagram

Part	Description
1	Collet nut
2	Collet
3	Front end nut
4	Driver shaft
5	Bearing
6	Sleeve
7	Motor
8	Switch
9	Shaft lock spring

Part	Description
10	Shaft lock Button
11	Left cover
12	Left mark
13	Rubber buffer
14	Right cover
15	Screw
16	Right mark
17	Battery cover
18	Battery

Part	Description
19	Release tab
20	Back moving spring
21	End cover
22	Hanger
23	LED Collar*
24	Transformer*
25	Charger Base*
26	Flexible Shaft*

*Not shown.

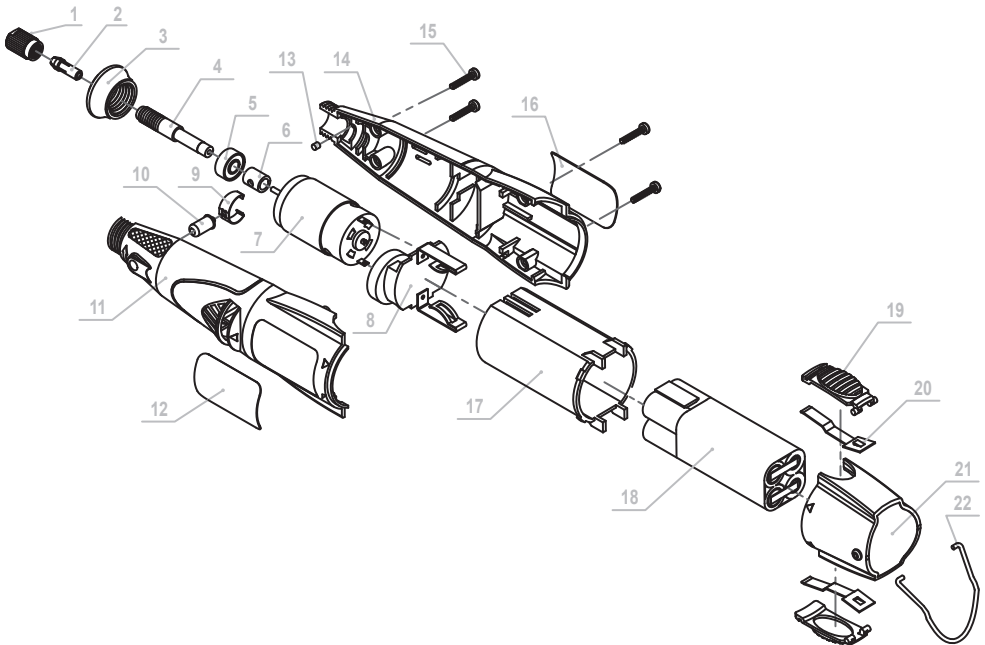

Record Product's Serial Number Here: _____

Note: If product has no serial number, record month and year of purchase instead.

Note: Some parts are listed and shown for illustration purposes only, and are not available individually as replacement parts.

Limited 90 Day Warranty

Harbor Freight Tools Co. makes every effort to assure that its products meet high quality and durability standards, and warrants to the original purchaser that this product is free from defects in materials and workmanship for the period of 90 days from the date of purchase. This warranty does not apply to damage due directly or indirectly, to misuse, abuse, negligence or accidents, repairs or alterations outside our facilities, criminal activity, improper installation, normal wear and tear, or to lack of maintenance. We shall in no event be liable for death, injuries to persons or property, or for incidental, contingent, special or consequential damages arising from the use of our product. Some states do not allow the exclusion or limitation of incidental or consequential damages, so the above limitation of exclusion may not apply to you. THIS WARRANTY IS EXPRESSLY IN LIEU OF ALL OTHER WARRANTIES, EXPRESS OR IMPLIED, INCLUDING THE WARRANTIES OF MERCHANTABILITY AND FITNESS.

To take advantage of this warranty, the product or part must be returned to us with transportation charges prepaid. Proof of purchase date and an explanation of the complaint must accompany the merchandise. If our inspection verifies the defect, we will either repair or replace the product at our election or we may elect to refund the purchase price if we cannot readily and quickly provide you with a replacement. We will return repaired products at our expense, but if we determine there is no defect, or that the defect resulted from causes not within the scope of our warranty, then you must bear the cost of returning the product.

This warranty gives you specific legal rights and you may also have other rights which vary from state to state.

CHICAGO  ELECTRIC®
POWER TOOLS

3491 Mission Oaks Blvd. • PO Box 6009 • Camarillo, CA 93011 • (800) 444-3353