

Owner's Manual & Safety Instructions

Save This Manual Keep this manual for the safety warnings and precautions, assembly, operating, inspection, maintenance and cleaning procedures. Write the product's serial number in the back of the manual near the assembly diagram (or month and year of purchase if product has no number). Keep this manual and the receipt in a safe and dry place for future reference.

ITEM 95541

900 LB. CAPACITY

HaulMaster®

20 FT - HAND STRAP TRAILER WINCH



REV 14g

Visit our website at: <http://www.harborfreight.com>
Email our technical support at: productsupport@harborfreight.com

When unpacking, make sure that the product is intact and undamaged. If any parts are missing or broken, please call 1-888-866-5797 as soon as possible.

Copyright© 2006 by Harbor Freight Tools®. All rights reserved.
No portion of this manual or any artwork contained herein may be reproduced in any shape or form without the express written consent of Harbor Freight Tools. Diagrams within this manual may not be drawn proportionally. Due to continuing improvements, actual product may differ slightly from the product described herein. Tools required for assembly and service may not be included.

⚠WARNING

**Read this material before using this product.
Failure to do so can result in serious injury.
SAVE THIS MANUAL.**

PRODUCT SPECIFICATIONS

Maximum Rated Load Capacity	900 Pounds
Operation	Manual
Safety Brake Type	Flip Lever Gear Lock
Base Dimensions	3-1/2" Wide x 4-1/4" Long
Mounting Holes	3/8" Diameter Hole (Qty. 1) 3/8" Side x 5/8" Long Slots (Qty. 3) 3/8" Wide x 1-1/16" Long Slot (Qty. 1)
Strap Type	Nylon Webbing
Strap Size	1-7/8" Wide x .042" Thick x 20' Long
Mounting Strap	2" Wide x 9-1/2" Long
Hook Type	"J" Hook / 1-3/4" Wide x 4" Long x 3/8" Thick
Crank Handle	9-1/2" Long (Removable)
Unit Weight	6.5 Pounds

SAVE THIS MANUAL

You will need this manual for the safety warnings and precautions, assembly, operating, inspection, maintenance and cleaning procedures, parts list and assembly diagram. Keep your invoice with this manual. Write the invoice number on the inside of the front cover. Keep this manual and invoice in a safe and dry place for future reference.

GENERAL SAFETY RULES



IMPORTANT SAFETY INSTRUCTIONS



WARNING!
READ AND UNDERSTAND ALL INSTRUCTIONS
Failure to follow all instructions detailed in this manual
may result in serious personal injury.
SAVE THESE INSTRUCTIONS

1. **Keep your work area clean and well lit.** Cluttered and dark work areas invite accidents.
2. **Stay alert.** Watch what you are doing, and use common sense when operating tools and equipment. Do not assemble or use this product while tired or under the influence of drugs, alcohol, or medication. A moment of inattention while operating tools and equipment may result in serious personal injury.
3.  **Wear eye protection.** Wear ANSI-approved safety impact goggles when assembling and using this product. Also, wear heavy duty work gloves.

4. **Do not force the Hand Winch.** Use the correct product for your application. The correct product will do the job better and safer at the rate for which it is designed. **NEVER attempt to exceed the maximum load capacity of the Hand Winch (900 pounds).**
5. **Check for any condition that may negatively affect the Hand Winch's operation.** If damaged, have the Winch repaired or replaced before using. Do not use damaged products. Tag damaged products **"Do not use"** until repaired.
6. **Prior to using the Hand Winch, make sure to read and understand all instructions and safety warnings as outlined in the service manual(s) for the object(s) being winched.** Make sure the Hand Winch is capable of safely winching the object. Make sure the point (vehicle bumper, etc.) at which the Winch is attached is capable of withstanding the weight of the object.
7. **Industrial applications must follow OSHA requirements.**
8. **Maintain labels and nameplates on the Hand Winch.** These carry important information. If unreadable or missing, contact Harbor Freight Tools for a replacement.
9. **Use the right product for the job.** There are certain applications for which this product was designed. Do not use small products to do the work of larger industrial products. Do not use this product for a purpose for which it was not intended.
10. **Product service must be performed only by qualified service technician.** Service or maintenance performed by unqualified personnel could result in a risk of injury.
11. **When servicing the Hand Winch, use only identical replacement parts.** Follow instructions in the *"Inspection, Maintenance, And Cleaning"* section of this manual. Use of unauthorized parts or failure to follow maintenance instructions may create a risk of personal injury.
12. **Do not allow children to play with this product.** Children should not be allowed in the work area. This product must always be located out of reach of children.
13. **Do not lift objects vertically.** This Hand Winch is designed for horizontal use only.
14. **Do not use inappropriate attachments to extend the length of the Winch's Strap.**
15. **Never lift people or hoist loads over people.**
16. **Do not apply a load to the Hand Winch when its Strap is fully extended.** Keep at least **four full turns** of the Strap on the Drum assembly.

17. **After moving an object with the Hand Winch, secure the object.** Do not rely on the Hand Winch to hold an object for an extended period of time.
18. **Never operate the Hand Winch if its Strap shows any signs of weakening, is knotted, or kinked.**
19. **If loading a boat onto a trailer without keel or side hull rollers, make sure the trailer is submerged in the water when the boat is loaded by the Hand Winch.** Attempting to drag the boat onto the trailer while on land can cause Winch failure, boat damage, and possible injury.
20. **Always examine the internal components of the Hand Winch, its Strap and Hook before each use.** Parts of the Winch may be affected by exposure to chemicals, salts, rust, or excessive wear.
21.  **WARNING!** Keep hands away from a load bearing Strap and the Winch's internal mechanism when operating.
22.  **WARNING!** If the Hand Winch fails to move a load after exerting pressure on the Handle, the load may be too heavy for the Winch. If this occurs, release pressure and immediately discontinue using the Winch.
23.  **WARNING!** The warnings and cautions discussed in this manual cannot cover all possible conditions and situations that may occur. It must be understood by the operator that common sense and caution are factors which cannot be built into this product, but must be supplied by the operator.

SAVE THESE INSTRUCTIONS

UNPACKING

When unpacking, check to make sure all the parts shown in the **Parts List on page 7** are included. If any parts are missing or broken, please call Harbor Freight Tools at the number shown on the front cover of this manual as soon as possible.

ASSEMBLY INSTRUCTIONS



To Attach The Handle:

Insert the Handle Assembly (11) onto the Shaft of the Gear Pinion (10). Then secure the Handle to the Shaft, using the Lock Nut (12). **(See Assy. Diagram.)**

To Attach The Hook Plate:

Align the two 3/8" diameter mounting holes in the Hook Plate (18) with the two mounting holes in the Base (14). Then secure the Hook Plate to the Base using two Bolts (20), two Washers (19) and two Nuts (17). **(See Assy. Diagram.)**

OPERATING INSTRUCTIONS

-  **Wear eye protection.** Wear ANSI-approved safety impact goggles when using this product. Also, wear heavy duty work gloves.
-  **WARNING! NEVER attempt to exceed the maximum load capacity of the Hand Winch (900 pounds).** Do not use this Hand Winch if there is any doubt as to the actual weight of the load being moved.
- To pull out the Strap (21), raise the Lever on the Handle Assembly (11). Then, disengage the Pawl (6) on the Hand Winch by pushing the Pawl down to its horizontal position. **(See Figures A and B.)**
- Hook the curved portion of the Hook Plate (18) onto a vehicle bumper or other *stable, stationary* object capable of supporting the weight of the load to be winched. **(See Figure B.)**
- Pull out the length of Strap (21) needed to attach the Hook of the Strap to the load being winched. **IMPORTANT:** Always leave at least four turns of Strap on the Drum Assembly (16) of the Hand Winch to prevent pulling the Strap completely out of the Winch.
- Attach the Hook of the Strap (21) securely to the load being winched.

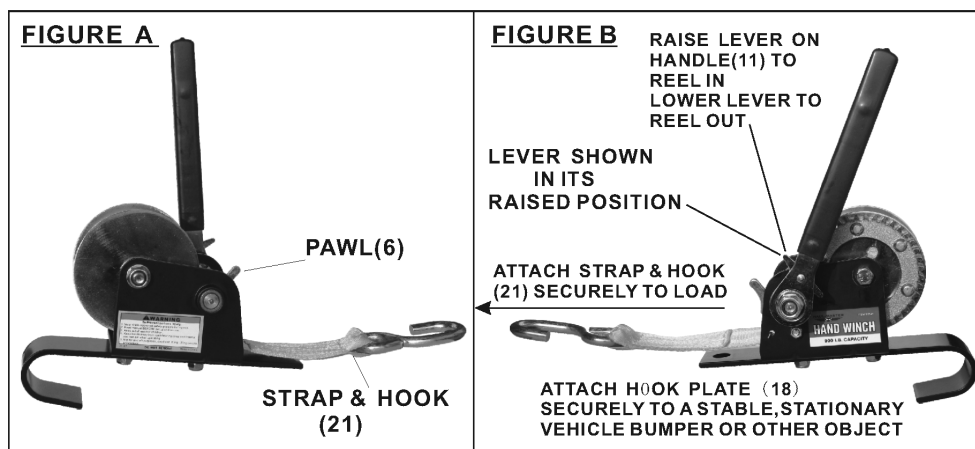



7. Lower the Lever on the Handle Assembly (11). Then, engage the Pawl (16) on the Hand Winch by pulling the Pawl up to its vertical position.
8. Pull the Handle Assembly (11) clockwise to pull the load to the desired location.

 **WARNING!** NEVER attempt to exceed the maximum load capacity of the Hand Winch (900 pounds). Do not use this Hand Winch if there is any doubt as to the actual weight of the load being moved.

9. After moving the object with the Hand Winch, secure the object. Raise the Lever on the Handle Assembly (11) and disengage the Pawl (6) on the Hand Winch by pushing the Pawl down to its horizontal position. Then disconnect the Strap & Hook (21) from the load. **Do not rely on the Hand Winch to hold an object for an extended period of time.**
10. When finished, always store the Hand Winch in a clean, dry, safe location out of reach of children and other unauthorized people.

INSPECTION, MAINTENANCE, AND CLEANING

1.  **CAUTION!** Always release a load from the Hand Winch before performing any inspection, maintenance, or cleaning.
2. **Before each use:** Inspect the general condition of the Hand Winch. Check for damaged or loose parts, and any other condition that may affect this product's safe operation. If a problem occurs, have the problem corrected before further use. **Do not use damaged equipment.**
3. **The internal Gears of the Hand Winch should be greased at all times.**
4. **Periodically, apply an oil lubricant to the Pawl Lever.** The Pawl Lever must be free of grease, dirt, paint, rust, etc., as these conditions will prevent the Lever from operating properly.
5. **If the Hand Winch has been used in salt water rinse the entire unit thoroughly with fresh water.** Then lubricate all moving parts.
6.  **CAUTION!** All maintenance, service, and repairs not discussed in this manual should only be performed by a qualified service technician.

PLEASE READ THE FOLLOWING CAREFULLY

THE MANUFACTURER AND/OR DISTRIBUTOR HAS PROVIDED THE PARTS LIST AND ASSEMBLY DIAGRAM IN THIS MANUAL AS A REFERENCE TOOL ONLY. NEITHER THE MANUFACTURER OR DISTRIBUTOR MAKES ANY REPRESENTATION OR WARRANTY OF ANY KIND TO THE BUYER THAT HE OR SHE IS QUALIFIED TO REPLACE ANY PARTS OF THE PRODUCT. IN FACT, THE MANUFACTURER AND/OR DISTRIBUTOR EXPRESSLY STATES THAT ALL REPAIRS AND PARTS REPLACEMENTS SHOULD BE UNDERTAKEN BY CERTIFIED AND LICENSED TECHNICIANS, AND NOT BY THE BUYER. THE BUYER ASSUMES ALL RISKS AND LIABILITY ARISING OUT OF HIS OR HER REPAIRS TO THE ORIGINAL PRODUCT OR REPLACEMENT PARTS THERETO, OR ARISING OUT OF HIS OR HER INSTALLATION OF REPLACEMENT PARTS THERETO.

PARTS LIST AND ASSEMBLY DIAGRAM

Item	Qty	Description	Item	Qty	Description
1	1	Locking Nut M10	11	1	Handle Assembly
2	1	Flat Washer Ø10	12	1	Locking Nut M12
3	1	Bolt M6x20	13	1	Bolt M12x110
4	2	Bush	14	1	Base
5	1	Circlip	15	1	Retaining Sleeve
6	1	Pawl	16	1	Drum Assembly
7	1	Torsion Spring	17	2	Lock Nut M8
8	1	Positioning Sleeve	18	1	Hook Plate
9	1	Locking Nut M6	19	2	Flat Washer Ø8
10	1	Gear Pinion	20	2	Bolt M8x18
			21	1	Strap & Hook

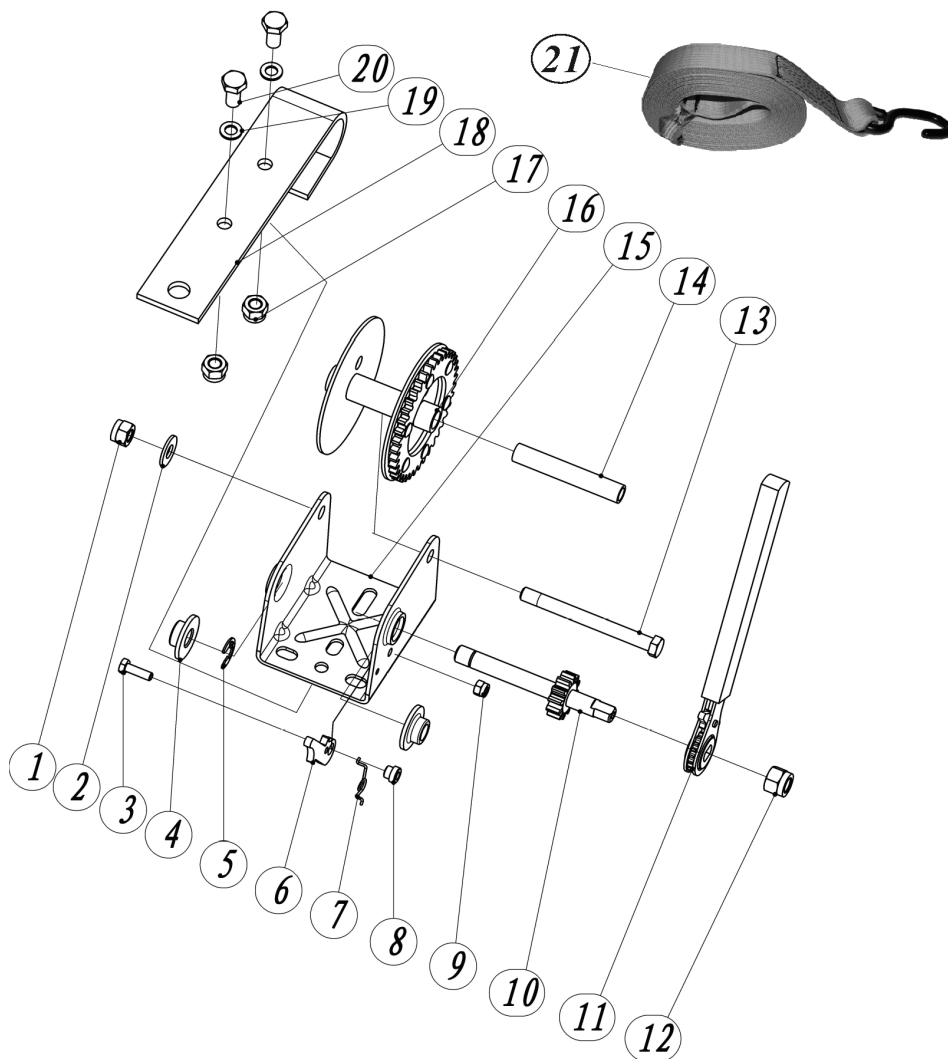

NOTE:

Some parts are listed and shown for illustration purposes only, and are not available individually as replacement parts.

Limited 90 Day Warranty

Harbor Freight Tools Co. makes every effort to assure that its products meet high quality and durability standards, and warrants to the original purchaser that this product is free from defects in materials and workmanship for the period of 90 days from the date of purchase. This warranty does not apply to damage due directly or indirectly, to misuse, abuse, negligence or accidents, repairs or alterations outside our facilities, criminal activity, improper installation, normal wear and tear, or to lack of maintenance. We shall in no event be liable for death, injuries to persons or property, or for incidental, contingent, special or consequential damages arising from the use of our product. Some states do not allow the exclusion or limitation of incidental or consequential damages, so the above limitation of exclusion may not apply to you. THIS WARRANTY IS EXPRESSLY IN LIEU OF ALL OTHER WARRANTIES, EXPRESS OR IMPLIED, INCLUDING THE WARRANTIES OF MERCHANTABILITY AND FITNESS.

To take advantage of this warranty, the product or part must be returned to us with transportation charges prepaid. Proof of purchase date and an explanation of the complaint must accompany the merchandise. If our inspection verifies the defect, we will either repair or replace the product at our election or we may elect to refund the purchase price if we cannot readily and quickly provide you with a replacement. We will return repaired products at our expense, but if we determine there is no defect, or that the defect resulted from causes not within the scope of our warranty, then you must bear the cost of returning the product.

This warranty gives you specific legal rights and you may also have other rights which vary from state to state.