

# JBL<sup>®</sup> ON AIR WIRELESS

speaker with iPod/iPhone dock



**OWNER'S MANUAL**

## TABLE OF CONTENTS

Introduction	2
Connections	3
Controls and Display	4
Setup Wizard	6
Using Your JBL® On Air Wireless	8
Troubleshooting Your JBL On Air Wireless	16
Appendix: Manual Network Setup	17
Specifications	19

## INTRODUCTION

2	The JBL On Air Wireless speaker with iPod/iPhone dock will revolutionize the way you listen to music. Imagine being able to play all the iTunes music files in your computer anywhere within range of your wireless network via AirPlay, waking up to music on your favorite Internet FM radio station (or to your favorite song from your iPod/iPhone), with no more buzzers or bad radio reception. When connected to your iPod/iPhone device, MP3 player or other music source, the JBL On Air Wireless produces clean, powerful sound while providing time-keeping, alarm and radio features. And the multiple-alarm option lets you set different alarms for “his” and “hers” at whatever day or frequency you need.
---	---

**IMPORTANT NOTE FOR ALL ELECTRONIC PRODUCTS:** Turn off the unit before inserting or unplugging audio cables from a source device's headphones or line-level output jacks. Doing so will prolong the life of your unit, help protect your device from static electricity and prevent potential damage.

## CONNECTIONS

1. Carefully unpack your JBL On Air Wireless and confirm that all the items shown here are included:

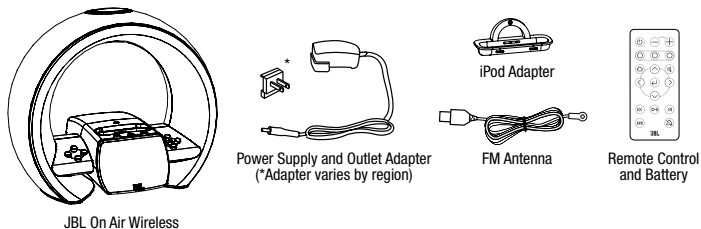

2. Connect the included FM antenna to the JBL On Air Wireless's FM Antenna connector.

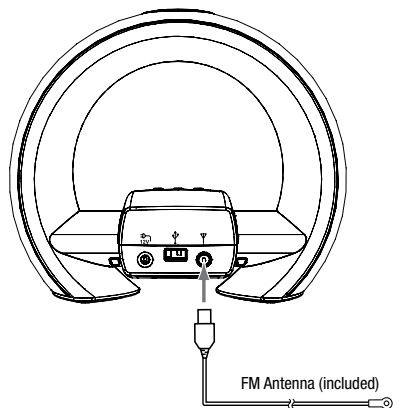

3. If you are going to use your JBL On Air Wireless with another audio source, plug one end of a 3.5mm stereo cable (not included) into the JBL On Air Wireless's Aux Input connector, and plug the other end into the audio source's headphone-out or line-out connector.

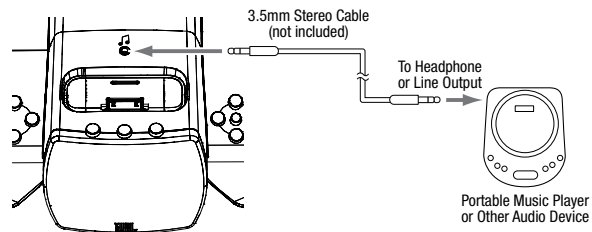

4. Slide the supplied power outlet adapter all the way into the JBL On Air Wireless's power supply, plug the power supply into the JBL On Air Wireless's 12V connection, and plug the power supply into a wall outlet.

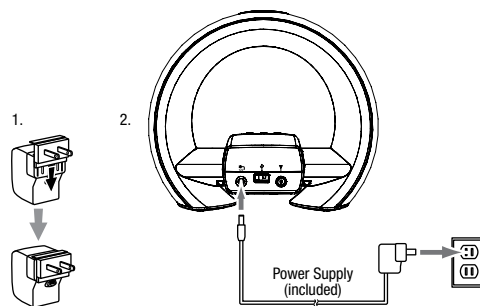

**IMPORTANT:** Use the JBL On Air Wireless's USB port *only* to perform system updates. Do NOT connect it to a computer or any other type of USB host/controller. You could damage the JBL On Air Wireless or the host/controller device. See *System Update*, on page 14.

## CONTROLS AND DISPLAY

### CONTROLS

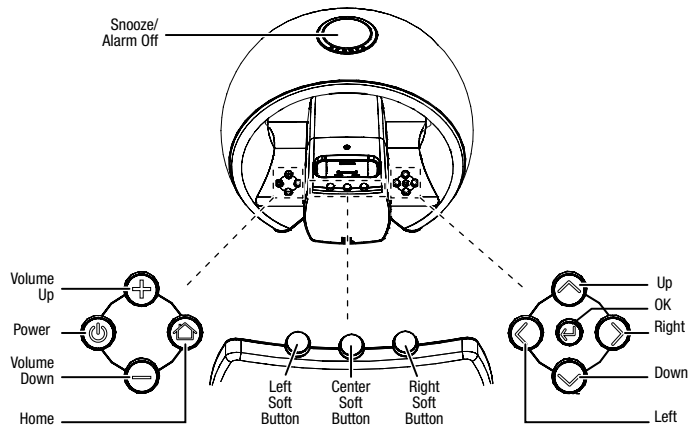

- **Snooze/Alarm Off button:** Press this button momentarily to shut the alarm sound off for nine minutes. The alarm will then sound again. Press and hold this button for three seconds to shut off the alarm sound until the next time the alarm is scheduled to ring.
- **Power button:** Press this button to turn the JBL On Air Wireless on or to put it into the Standby mode. (NOTE: The alarms will still function when the JBL On Air Wireless is in the Standby mode.)

- **Volume Up/Down buttons:** Press these buttons to raise or lower the volume. Press both buttons simultaneously to mute the sound. When the sound is muted, press either the Volume Up or the Volume Down button to restore the sound. (NOTE: On the remote control, the mute function has its own button. See *Remote Control Buttons*, on page 5.)
- **Home button:** Press this button to display the Home/Clock screen (see *Main Display*, on page 6). If you press the button when the Home/Clock screen is displayed, the JBL On Air Wireless will display the Main Menu screen. See *Listening to a Source*, on page 8.
- **Left/Center/Right Soft buttons:** The functions of these buttons will vary according to the screen that is active when the buttons are pushed. See *Using Your JBL On Air Wireless*, on page 8, for more information.
- **Up/Down buttons:** Press these buttons to scroll up or down the menu screens and to highlight items.
- **OK button:** On most menu screens, press this button to select a highlighted menu item. See *Using Your JBL On Air Wireless*, on page 8, for more information.
- **Left and Right buttons:** Press the Left button to return to the previous menu screen. The function of the Right button depends on the screen that is active when you press the button. On many menu screens, pressing the Right button performs the same function as pressing the OK button. See *Using Your JBL On Air Wireless*, on page 8, for more information.

### REMOTE CONTROL BUTTONS

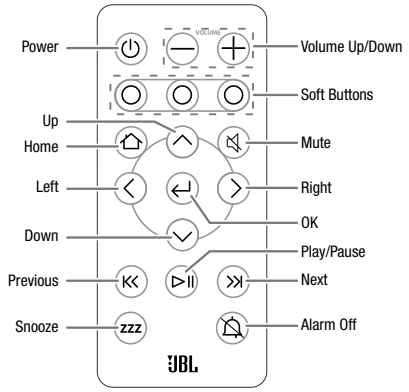

- **Previous, Play/Pause and Next buttons:** When listening to AirPlay or an iPod device, press these buttons to skip to the previous song, play/pause the current song, or skip to the next song.
- **Mute button:** Press this button to mute the sound; press it again to restore the sound.
- **Alarm Off button:** Press this button to shut off the alarm sound until the next time the alarm is scheduled to ring.

The remaining remote control buttons perform the same functions as their counterparts on the JBL On Air Wireless unit.

Before using the remote control, remove the battery contact-protection strip by pulling on the tab.

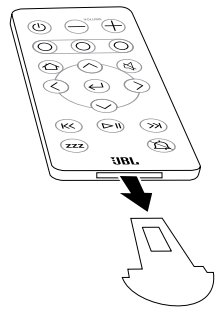

### Changing the remote control's battery:

1. Press the tab on the side of the battery tray and pull the tray out of the remote.
2. Place a model CR2025 battery into the tray with the positive (+) terminal facing as shown in the illustration, and replace the battery tray in the remote.

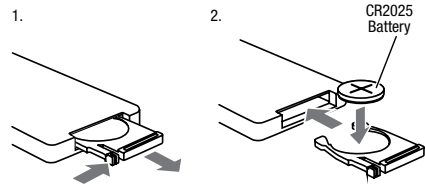

## MAIN DISPLAY

NOTE: The display screens shown throughout this manual are for illustrative purposes and may differ somewhat from the actual display screens.

The Home/Clock screen is the JBL On Air Wireless's main screen and is the base for all navigation.



Other menu screens are shown in the *Setup Wizard* section (this page), and the *Using Your JBL On Air Wireless* section (page 8).

## SETUP WIZARD

When you turn your JBL On Air Wireless on for the first time, the Setup Wizard requires that you set the language, region, time zone, time, day and network before you can play music or use the clock functions.

To return to the previous menu screen at any time, press the Left button.

## LANGUAGE

1. Use the Up and Down buttons to highlight your choice of language for the JBL On Air Wireless's display.



2. Press the OK button to select your choice. The display will immediately change to the selected language, and the Region screen will appear.

## REGION

This screen automatically sets the JBL On Air Wireless's FM-radio frequency band and tuning increments to match the FM-radio broadcasts in your region.

1. Use the Up and Down buttons to highlight the region you live in.

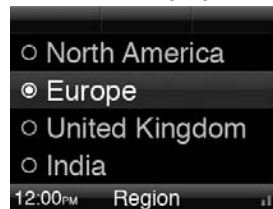

2. Press the OK button to select the highlighted region. The Time Zone screen will appear.

## TIME ZONE

This screen sets the JBL On Air Wireless's clock to match the time zone in your area.

1. Use the Up and Down buttons to highlight the time zone you live in.

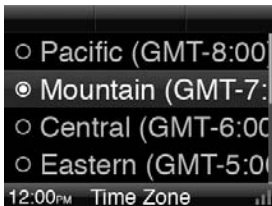

2. Press the OK button to select the highlighted time zone. The Time screen will appear.

## TIME

1. Use the Center Soft button to set the clock to the 12-hour or 24-hour mode. The active mode is displayed directly below the button, and the hours are highlighted.



2. Use the Up and Down buttons to set the current hour, and press the OK button. The minutes are highlighted.

3. Use the Up and Down buttons to set the current minute, and press the OK button.

- If the clock is in the 24-hour mode, the Day screen will appear.
- If the clock is in the 12-hour mode, AM/PM will be highlighted. Use the Up and Down buttons to set AM or PM, and press the OK button. The Day screen will appear.

## DAY

1. Use the Up and Down buttons to highlight the current day of the week.

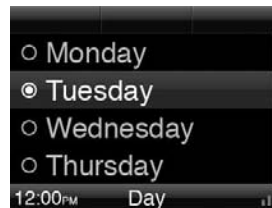

2. Press the OK button to select the highlighted day. The Network screen will appear.

## NETWORK

You can connect your JBL On Air Wireless to your Wi-Fi® network. Connecting to your network will enable your JBL On Air Wireless to play music files and Internet radio broadcasts that your computer streams to it.

1. When the Network screen appears, the JBL On Air Wireless will automatically search for any available Wi-Fi networks.



2. When the search is completed, the screen will display a list of up to four available networks.
3. Use the Up and Down buttons to highlight the network you want to use, and press the OK button to select it.
4. Press the Home button to exit the Setup Wizard. The Home/Clock screen will appear.

NOTE: If the JBL On Air Wireless cannot connect to your Wi-Fi network, it will display a “Wi-Fi connection not functioning” message. To connect to a network manually, see *Settings: Network*, on page 13.

## USING YOUR JBL ON AIR WIRELESS

### LISTENING TO A SOURCE

When the Home/Clock screen is displayed, press the Home button to display the Main Menu.



The Main Menu lets you scroll through and select the following items: FM, iPod, AirPlay, Aux and Settings.

Use the Up, Down and OK buttons to highlight and select an item.

NOTE: “AirPlay” will appear in the Main Menu list only if iTunes AirPlay streaming has already been initiated from a networked computer. See *Listening to Streaming Audio from Your Computer*, on page 10, for more information.

### LISTENING TO FM RADIO

Selecting “FM” on the Main Menu displays the FM-radio screen.



NOTE: If the station is broadcasting RDS data, the station’s call letters will appear below the broadcast frequency.

#### To tune to the next higher or lower receivable station:

1. Press the Left Soft button to put the radio in the scan mode. The display will show “Scan” under the button.
2. Press the Up or Down buttons to scan up or down to the next receivable station.

#### To tune up or down by one tuning increment:

1. Press the Left Soft button to put the radio in the tune mode. The display will show “Tune” under the button.



2. Press the Up or Down button to tune up or down by one tuning increment. Hold down the button to tune up or down continually until you release the button.

**To save the currently tuned station as a preset:**

Press the Right Soft button. You can store up to 10 stations as presets.

**To listen to a preset station:**

Press the Center Soft button to display the FM Presets screen.



Use the Up or Down button to scroll through the list and highlight each station. Press the OK button to listen to a highlighted station.

**Deleting a preset station:**

Use the Up or Down button to highlight the station. Press the Right Soft (Delete) button to delete the station.

**LISTENING TO YOUR iPod/iPhone DEVICE**

Selecting "iPod" on the Main Menu displays the iPod playback screen.



NOTE: Be sure to install the supplied adapter into the JBL On Air Wireless before docking your iPod/iPhone device (see illustration). Do not place an iPod or iPhone device in the JBL On Air Wireless unless the dock adapter is installed. Otherwise, the iPod or iPhone device will not connect properly, and both it and the JBL On Air Wireless may sustain damage that is not covered by the warranty.

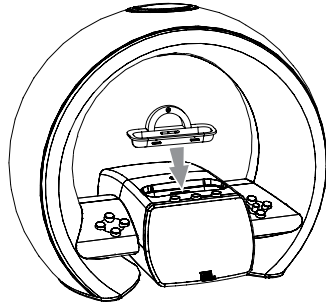

Use the JBL On Air Wireless's Soft buttons (or the remote control) to control playback of your iPod/iPhone device:

- Press the Left Soft (Previous) button to skip back.
- Press the Right Soft (Next) button to skip ahead.
- Press the Center Soft (Play/Pause) button to play/pause.

The JBL On Air Wireless will charge your iPod/iPhone device while it is docked.

NOTE: We recommend that you pause playback before undocking your iPod or iPhone device from the JBL On Air Wireless.

## LISTENING TO STREAMING AUDIO FROM YOUR COMPUTER

Selecting “AirPlay” on the JBL On Air Wireless’s Main Menu lets you play audio files or an Internet radio station that is streaming from a networked computer.

NOTE: The computer must have the Apple iTunes application installed. To download the application, go to [www.apple.com/iTunes](http://www.apple.com/iTunes).

You must initiate the AirPlay streaming operation from the networked computer *before* selecting “AirPlay” in the JBL On Air Wireless’s Main Menu. Once streaming has been established, selecting “AirPlay” in the Main Menu plays the streaming audio and displays the AirPlay screen.



While the JBL On Air Wireless is playing an audio file or Internet radio station, the display will show any embedded art (if available) and will scroll song title, artist’s name and album title ID3 data, or will scroll data embedded by the Internet radio station. If the data is unavailable, the display will show the song’s file name or the Internet radio station’s name.

Use the JBL On Air Wireless’s Soft buttons (or the remote control) for basic playback control of the streaming audio file:

- Press the Left Soft (Previous) button to skip back.
- Press the Right Soft (Next) button to skip ahead.
- Press the Center Soft (Play/Pause) button to play/pause.

The JBL On Air Wireless may display error messages that the computer passes to it while streaming content to it.

Switching to any of the JBL On Air Wireless’s other audio sources will break the streaming signal from the computer. You must re-establish the streaming signal from the computer before switching the JBL On Air Wireless back to the AirPlay source.

For complete information about streaming audio files and Internet radio stations, consult the documentation for your computer’s iTunes software application.

## LISTENING TO AN AUXILIARY AUDIO SOURCE

Selecting “Aux” on the Main Menu plays audio from a source connected to the JBL On Air Wireless’s Aux Input connector. The JBL On Air Wireless will display the Aux playback screen.



Use the JBL On Air Wireless’s Volume Up/Down buttons to change the volume. The audio source connected to the JBL On Air Wireless’s Aux input controls the playback.

## SETTINGS

Selecting “Settings” on the Main Menu screen displays the Settings Menu screen:



This screen lets you configure your JBL On Air Wireless to operate the way you want it to.

### Alarms

Selecting “Alarms” displays the main Alarms screen:

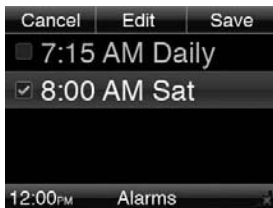

This screen shows your current alarm settings and lets you change the alarm settings. Active alarms are indicated by a check mark.

To set an alarm, press the Center Soft (Edit) button. The JBL On Air Wireless will display the Alarm Settings menu screen. When you’re finished setting the alarms, press the Right Soft (Save) button to save the settings.

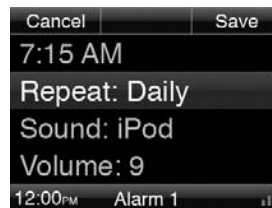

Use the Up, Down, Left, Right and OK buttons to adjust the following items:

- **Alarm Time:** Set the time you want the alarm to sound.
- **Repeat:** Set the alarm to repeat every day, weekdays only or weekends only, or turn the alarm off.
- **Sound:** Set the alarm to wake you with a buzzer, FM radio or your iPod/iPhone device. NOTE: If you select “iPod” and your iPod device is not docked at the time the alarm is set to ring, the buzzer will sound.
- **Volume:** Set how loud you want the alarm to sound.
- **Volume Ramp:** Selecting “Off” ramps the alarm from silence up to your pre-determined alarm volume over a period of three seconds. Selecting “On” ramps the alarm from silence up to your pre-determined alarm volume over a period of three minutes.

### Turning the alarm sound off:

- Press the Snooze button momentarily to shut the alarm sound off. After nine minutes, the alarm will sound again.
- On the unit, press and hold the Snooze button for three seconds (on the remote control, press the Alarm Off button) to shut the alarm sound off until the next time the alarm is scheduled to ring.

## Time/Day

Selecting “Time” displays the Main Time menu screen:

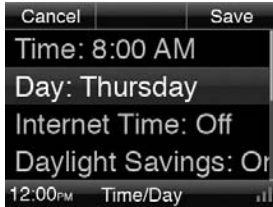

Use the Up, Down, Left, Right and OK buttons to adjust the following items:

- **Time:** Set the current time of day. You can also set the clock to operate in the 12-hour or 24-hour mode.
- **Day:** Set the current day of the week.
- **Internet Time:** If you select “On,” the JBL On Air Wireless will automatically set its clock according to an Internet-based time service. It will automatically maintain the correct time, including an appropriate Daylight Saving Time offset. If you select “Off,” the clock will maintain the time settings that you selected using the Main Time menu screen.
- **Daylight Savings Time:** Select “On” if Daylight Saving Time is observed where you live.
- **Time Zone:** Select your time zone.

When you’re finished making your settings, press the Right Soft (Save) button to save your settings.

## Brightness

Selecting “Brightness” displays the Brightness Setting screen:



Use the Up, Down and OK buttons to highlight and select a display and button brightness level.

**Auto:** The JBL On Air Wireless will automatically adjust its display and button brightness according to the room’s ambient light conditions.

**1 – 6:** Selecting one of these options manually sets the display and button brightness to the selected level. The brightness will not vary according to ambient light conditions.

## Language

Selecting “Language” displays the Language Setting screen:



Use the Up, Down and OK buttons to select a language for the JBL On Air Wireless's display. The JBL On Air Wireless's interface will immediately change to the selected language.

### Regional Settings

Selecting "Regional Settings" displays the Region screen:

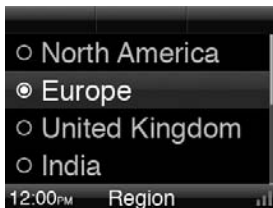

This menu sets the JBL On Air Wireless's FM radio-frequency band and tuning increments to match the FM broadcasts in your region. Use the Up, Down and OK buttons to select the region you live in.

### Network

Selecting "Network" displays the Network Setup screen:



This menu provides access to all of the JBL On Air Wireless's network settings.

Use the Up and Down buttons to scroll through the list. Use the OK button to select items, and use the Left button to return to the previous menu screen.

- Refresh (Left Soft) button:** Press this button to search for all available networks or refresh the list of available networks. The JBL On Air Wireless will automatically connect to the network that was used most recently. If that network is unavailable, it will connect to the next most recently used network and so forth.
- Info (Center Soft) button:** Press this button to display the IP information for the system's current network settings.
- Edit (Right Soft) button:** Press this button to make changes in an existing network's setup or to enter information for a new network manually. See *Appendix: Manual Network Setup*, on page 17, for complete instructions.
- Wi-Fi:** Select this option to turn the Wi-Fi function on and off. When you turn the Wi-Fi function on, the JBL On Air Wireless will automatically search for available Wi-Fi networks.
- [Network Name 1 – 4]:** The display screen lists each available network. The currently-selected network is indicated by a check mark. The bars indicate the strength of the Wi-Fi network connection.

To select a network, use the Up, Down and OK buttons. If the network that you select has no security, then the JBL On Air Wireless will attempt to connect to the network. If the network has saved settings (e.g., password, IP settings), then the JBL On Air Wireless will attempt to connect to the network using these settings. If the network requires a password and the JBL On Air Wireless has not saved a password, it will display the Settings – Network Password screen so you can enter the password. See *Appendix: Manual Network Setup*, on page 17, for more information.

- **Wi-Fi Protected Setup™ (WPS):** If your network router is WPS-compatible, select this option to set up and configure the JBL On Air Wireless to work with your network automatically.
- **Add Network:** Select this option to add a network manually. See *Appendix: Manual Network Setup*, on page 17, for more information. NOTE: If the JBL On Air Wireless is searching for available Wi-Fi networks when you select Add Network, the search will immediately stop.
- **Name [Device]:** Select this option to change your JBL On Air Wireless's default device name to one of your own choosing. The Name screen will appear.



Use the Up, Down, Left, Right and OK buttons to select letters on the keypad to enter the new name. Press the Center Soft (Delete) button to backspace a character, press the Right Soft (Save) button to save the new name or use the Left Soft (Back) button to return to the previous menu screen without changing the device name.

### System Update

This menu allows you to update your JBL On Air Wireless's firmware to the latest version.



- **Internet Update:** Select this option to search for and download the latest firmware from the server. If a new firmware version is available, the JBL On Air Wireless will automatically download and install it. During downloading and installation, the JBL On Air Wireless will display a progress bar.

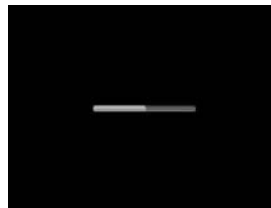

If the download and installation are successful, the progress bar will turn *green*. If the download and installation fail, the progress bar will turn *red*, and you will have to repeat the procedure from the System Update screen.

NOTE: The JBL On Air Wireless will automatically attempt to contact the Internet server once a day in the evening and determine if a new firmware version is available. If so, it will automatically download and install the new firmware as described above.

- **USB Update:** You can search for and download new firmware on your computer and transfer it to a USB memory device. Insert the USB device into the JBL On Air Wireless's USB port. Select USB Update.

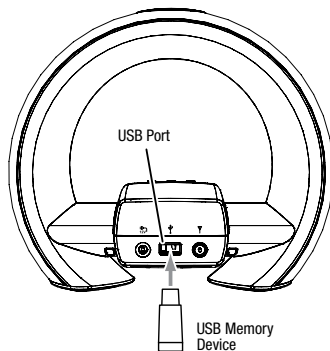

The JBL On Air Wireless will display the Install Software screen.

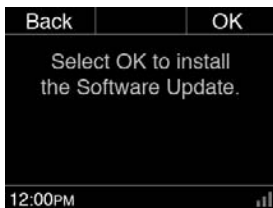

Press the Right Soft (OK) button to install the software; press the Left Soft (Cancel) button to cancel the upgrade and return to the previous menu screen.

**IMPORTANT:** Use the JBL On Air Wireless's USB port only to perform system updates. Do NOT connect it to a computer or any other type of USB host/controller. You could damage the JBL On Air Wireless or the host/controller device.

- **Current Version:** Select this option to display the version number of the currently installed firmware. Press the Left Soft (Back) button to return to the System Update screen.

### System Reset

This menu lets you return your JBL On Air Wireless to its out-of-the-box factory-default condition and erase all of your clock and alarm settings, network settings, menu settings and FM radio preset stations. When the JBL On Air Wireless completes the System Reset, it will return to the Setup Wizard screen (see page 6).



Select Reset or the Right Soft (OK) button to reset the system; select Cancel or the Left Soft (Back) button to cancel the system reset and return to the previous menu screen.

## TROUBLESHOOTING YOUR JBL ON AIR WIRELESS

PROBLEM	SOLUTION
<b>No sound (display is not illuminated):</b>	<ul style="list-style-type: none"><li>• Make sure that the power supply is properly connected to the JBL On Air Wireless and to a working AC outlet.</li></ul>
<b>No sound (display is illuminated):</b>	<ul style="list-style-type: none"><li>• Touch the Volume Up (+) button to increase the system volume.</li><li>• If you're using FM radio, make sure that the included FM antenna is properly connected and that the JBL On Air Wireless is tuned to an active FM frequency.</li><li>• If you're using a docked iPod/iPhone device, make sure that it is properly docked in the JBL On Air Wireless.</li><li>• If you're using an auxiliary audio source, make sure that the audio cable is properly connected to the JBL On Air Wireless's Aux Input connector and to the source component's audio output.</li><li>• If you're using AirPlay, make sure that the computer has initiated streaming before you select AirPlay as the source in the JBL On Air Wireless's Main Menu.</li><li>• If you're using AirPlay, make sure that you have selected the correct network in the JBL On Air Wireless's Network Setup screen. (See <i>Settings: Network</i>, on page 13.)</li><li>• Make sure that the iPod device, AirPlay source or auxiliary source component is not in the Pause mode and that its volume control is not turned all the way down.</li></ul>
<b>Sound crackles, hisses or is distorted:</b>	<ul style="list-style-type: none"><li>• Turn the iPod device or other source component's volume down.</li><li>• Make sure that the iPod device's EQ setting is set to "Off."</li></ul>
<b>Loud hum or buzzing:</b>	<ul style="list-style-type: none"><li>• Make sure that the audio cable is plugged all the way into the JBL On Air Wireless's Aux Input jack.</li><li>• Replace the audio cable.</li><li>• Unplug the power supply and connect it to a different AC outlet.</li></ul>



**PROBLEM**

**Sound comes from only one speaker:**

**SOLUTION**

- Make sure that the iPod/iPhone device is properly seated all the way into the docking connector.
  - Make sure that the audio cable is plugged all the way into the Aux Input jack.
  - Make sure that the audio cable is a stereo cable.
- 
- The JBL On Air Wireless does not respond to any button presses:**
- Press and hold the Snooze and Power buttons on the unit together for seven seconds to reset the unit's microprocessor. NOTE: Resetting the microprocessor will erase all of your clock and alarm settings, network settings, menu settings and FM-radio preset stations. When the microprocessor reset is completed, the JBL On Air Wireless will return to the *Setup Wizard* screen (see on page 6).

**APPENDIX: MANUAL NETWORK SETUP**

Selecting "Edit" or "Add Network" on the Network screen (see *Network*, on page 13) displays the Network edit screen, which allows you to make changes in an existing network's settings or enter settings for a new network manually.

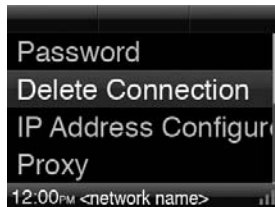

- **Password:** Select this option to enter the password for the active network. The Password Entry screen appears:



Use the Up, Down, Left and Right buttons to highlight characters. To select a highlighted character, press the OK button. When you have completed selecting the password, press the Right Soft (Next) button to enter the password.

- **Delete Connection:** Select this option to delete a network from the system. Deleting a network stops the JBL On Air Wireless from automatically connecting to the network's server and deletes all saved information related to the network.

- **IP Address Configuration:** Select this to option configure the network's IP address. The IP Address screen will appear:



Select "DHCP" to configure the network from the server automatically. Select "Static IP" to configure the network manually. The Static IP screen will appear:



Select and manually enter the network's IP, Subnet, Router and DNS addresses. A data-entry screen will appear for each one. Select the Right Soft (Save) button when you have finished entering each address.

- **Proxy:** Select this option to configure the network for a proxy server. The Proxy screen will appear:

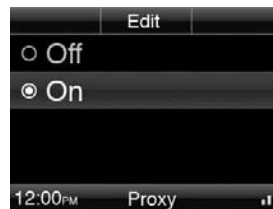

Select "Off" if the network does not have a proxy server. Select "On" if the network does have a proxy server. Select the Center Soft (Edit) button to enter the proxy server settings manually. The Proxy Settings screen will appear:



Select and manually enter the proxy server's server address and port address, the proxy user name and the proxy password. A data-entry screen will appear for each one. Select the Right Soft (Save) button when you have finished entering each item.

When you have finished entering all the information, select the Center Soft (Test) button to test the proxy settings. The JBL On Air Wireless will attempt to connect to the proxy server using the settings you entered. If it is successful, it will save the settings and display the previous menu screen. If it is unsuccessful, it will display the error message returned by the proxy server and you will need to correct the information you entered.

## SPECIFICATIONS

iPod/iPhone compatibility:	<p>Made for iPod nano 5th generation, iPod touch 2nd generation, iPod classic, iPod nano 4th generation, iPod touch 1st generation, iPod nano 3rd generation, iPod with video</p> <p>Made for iPhone 4, iPhone 3GS, iPhone 3G and iPhone</p> <p>Not compatible with iPod/iPhone video and photo playback</p> <p>The above information is correct as of the printing of this manual. Please check <a href="http://www.jbl.com">www.jbl.com</a> for the latest compatibility information.</p>
Wi-Fi network compatibility:	XXXX
Transducers:	X x JBL XXXX transducers
Amplifier power:	XX watts x 2
Frequency response:	XXHz – XXkHz
Signal-to-noise ratio:	>XXdB
Aux Input sensitivity/impedance:	XXV/XX ohms
Input connections:	Main connection – iPod and iPhone docking connector; Aux Input connection – 3.5mm (1/8") stereo mini jack
Power requirement:	12V DC
Power consumption:	XXW (standby); XXW (maximum)
Dimensions (H x W x D):	XX" x XX" x XX" (XXmm x XXmm x XXmm)
Weight:	XX lb (XXkg)
Available finishes:	XXXX



**HARMAN** HARMAN Consumer, Inc.  
8500 Balboa Boulevard, Northridge, CA 91329 USA

[www.jbl.com](http://www.jbl.com)

© 2010 HARMAN International Industries, Incorporated. All rights reserved.

Features, specifications and appearance are subject to change without notice.

JBL is a trademark of HARMAN International Industries, Incorporated, registered in the United States and/or other countries.

Apple, iPhone, iPod, iPod nano, iPod classic, iTunes and iPod touch are trademarks of Apple Inc., registered in the U.S. and other countries. iPod/iPhone not included. “Made for iPod” and “Made for iPhone” mean that an electronic accessory has been designed to connect specifically to iPod and iPhone, respectively, and has been certified by the developer to meet Apple performance standards. Apple is not responsible for the operation of this device or its compliance with safety and regulatory standards.

Wi-Fi is a registered trademark of the Wi-Fi Alliance. Wi-Fi Protected Setup is a trademark of the Wi-Fi Alliance.



Part No.: 950-0309-001 Rev.: A