



DELL™ Documents

Harman/Kardon HK695 User's Guide

[Safety Instructions](#)

[Introduction](#)

[Setup](#)

[Using the speaker system](#)

[Diagnostics](#)

[Troubleshooting](#)

[Specifications](#)

[Regulatory](#)

Information in this document is subject to change without notice.

© 2000 Harman Multimedia. All rights reserved.

Trademarks used in this text: *harman/kardon* is a registered trademark of Harman Multimedia; *Dell* and the *DELL* logo are trademarks of Dell Computer Corporation.

Other trademarks and trade names may be used in this document to refer to either the entities claiming the marks and names or their products. Harman Multimedia disclaims any proprietary interest in trademarks and trade names other than its own.

Initial release: 30 Sept 2000

[Back to Contents Page](#)

Safety Instructions: harman/kardon HK695 Audio System



WARNING: Use of controls, adjustments, or procedures other than those specified in this documentation may result in exposure to shock, electrical hazards, and/or mechanical hazards.

- Read instructions --- All the safety and operating instructions should be read thoroughly before attempting to operate this audio system.
- Retain instructions for future reference.
- Heed warnings --- All warnings on this audio system and in the operating instructions should be adhered to.
- Follow instructions --- All operating and use instructions should be followed.
- TO PREVENT THE RISK OF ELECTRIC SHOCK, DO NOT REMOVE THE COVER (OR BACK). There are no user serviceable parts inside this unit, please refer servicing to qualified Dell™ Computer Corporation service personnel.
- Do not expose the speakers to liquid or solvent.
- Never remove grille covers in order to service the product. The speaker system does not contain any user serviceable parts. Refer all servicing to the Dell™ Computer Technical Support Group.
- Do not expose the speaker system to temperature or humidity extremes, direct sunlight, excessive dust, or vibrations.
- Place the speaker system on a stable, level surface. Do not drop, apply excessive force to the controls, or put heavy objects on top of the speaker.
- If cleaning is required, use a soft dry cloth. If necessary, use a damp cloth without any solvents.
- In order to protect the speaker system, avoid microphone feedback, continuous output from electronic musical instruments, or distorted output from any signal source.
- Do not place the speakers close to fluorescent light sources, or neon light fixtures.
- Although the speakers are magnetically shielded, keep magnetic storage media (disks and tapes) at least four inches from the product in order to avoid data loss.
- **WARNING:** To reduce the risk of fire or electric shock, do not expose this speaker system to rain or moisture.

[Back to Contents Page](#)

[Back to Contents Page](#)

Introduction:

harman/kardon HK695 Audio System System

The HK695 Audio System is the latest innovation from harman/kardon, a long time leader in the manufacture of high-end component and computer audio systems. harman/kardon's audio heritage combined with continual research has provided the unique technologies included in the HK695 Audio System.

These technologies include Vmax, a Harman International audio image-processing algorithm that seamlessly supports both two and four channel sound cards. This audio hologram creates a four speaker sound field from two speakers through the use of a head related transfer function when used with a four channel sound card. In addition, the algorithm provides enhanced stereo when used with a two channel sound card.

The Harman Multimedia Odyssey I transducer is another technology critical to the HK695 Audio System. This unique full range transducer was designed specifically for extremely small speaker enclosures while providing significant mid bass. In addition to the bass, the small, rigid and light inverted aluminum cone provides performance that will rival any tweeter used in multimedia speakers today. The result is a small and elegant satellite speaker that perfectly integrates with the subwoofer while providing superior midrange and highs.

The Magnum series subwoofer transducer provides deep bass. This Magnum series of woofers are designed specifically to match with the Harman Multimedia Odyssey I transducers. The same approach of providing solid bass from a small enclosure guided the development of these Magnum transducers.

As described in the [Using the speaker system](#) section of the user's guide, the top of the control/right speaker features - and + buttons. Briefly pressing the appropriate button will cause a small step increase or decrease in the system volume. Holding down the appropriate button for more than 0.5 seconds will cause the volume to decrease or decrease rapidly while that button is held down.

Treble, Bass and surround level adjust knobs are located on top of the subwoofer unit. A system on/off switch is also provided on the rear of the subwoofer unit.

The system includes two desktop speakers and a subwoofer that can be placed either on the floor or on your desk. Both satellite speakers and the subwoofer are magnetically shielded to provide the greatest protection against computer monitor image distortion.

[Back to Contents Page](#)

[Back to Contents Page](#)

Setup: harman/kardon HK695 Audio System

[Unpacking the speakers](#) • [Connecting the speakers to your sound card](#) • [Placement of speakers](#)

Unpacking the speakers

Carefully unpack your speaker system and identify all components:

- Control/Right Satellite speaker
- Auxiliary/Left Satellite speaker
- Subwoofer with attached power and audio input cables

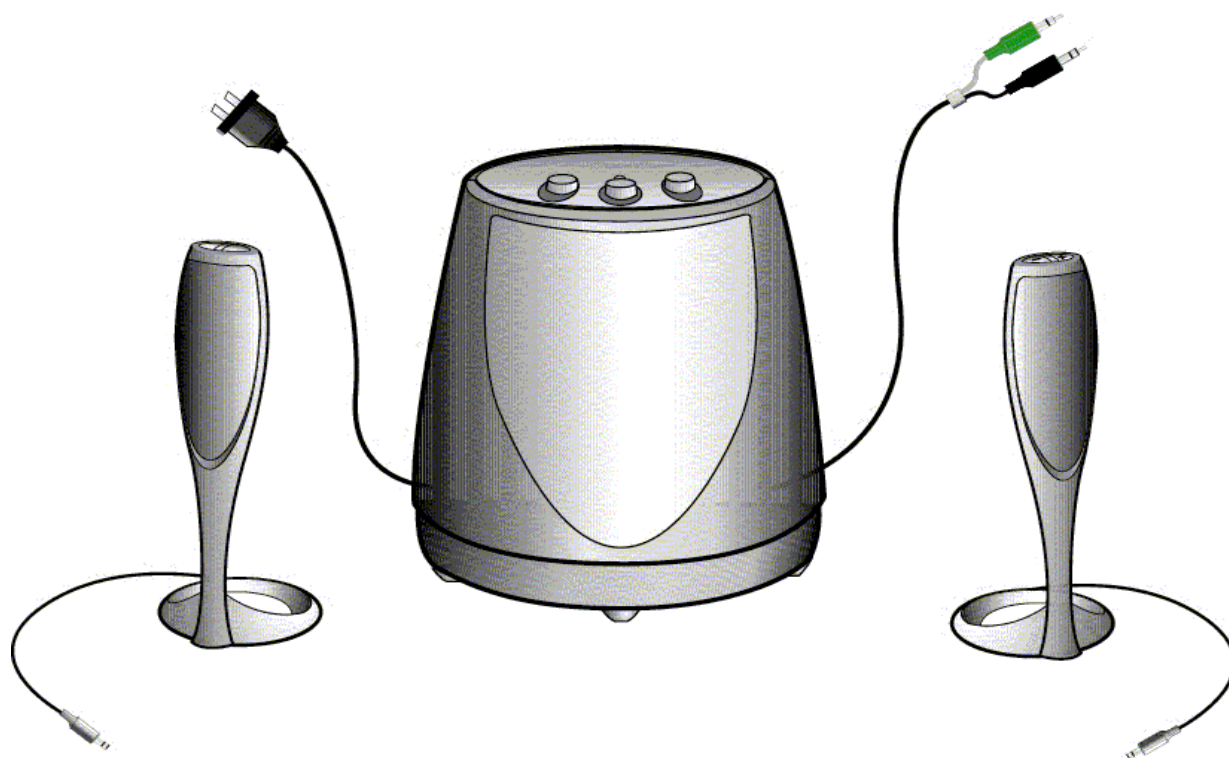

Connect the speaker system as shown in the **Connecting the speaker system to sound card** illustrations. Once the speaker system is properly connected, turn on the power switch located on the rear of the subwoofer.

[Back to top](#)

Connecting the speaker system to the computer.

Step 1 If you have an [integrated sound solution](#); or a [stereo sound card](#), connect the green connector from the subwoofer into the green jack on the computer, the black connector is not used, leave the rubber cap on the black connector to prevent static from the pin grounding on the system. If you have a [multi-channel sound card](#); connect the green connector from the subwoofer into the green jack on the computer and connect the black connector from the speaker into the black jack on the computer. If you have a [portable computer](#); connect the green connector from the subwoofer into the headphone jack on the computer, the black connector is not used, leave the rubber cap on the black connector to prevent static from the pin grounding on the system.

Step 2 Plug the orange connector from the right/control satellite into the orange jack on the subwoofer.

Step 3 Plug the brown connector from the left satellite into the brown jack on the subwoofer.

Step 4 Plug the AC plug into the wall outlet.

Step 5 Turn on the speaker set and adjust the volume accordingly.

Connecting the Speaker System to Integrated Stereo Sound

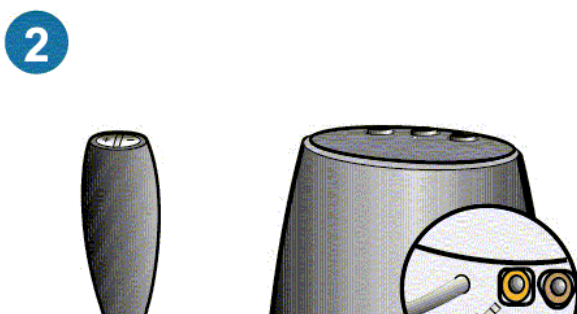
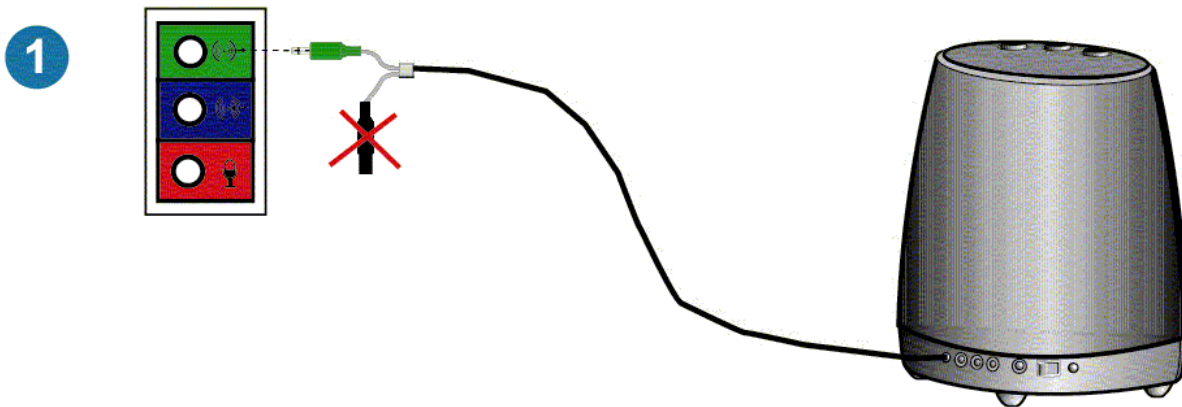
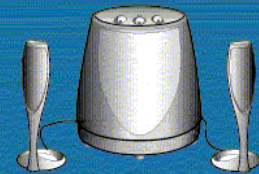

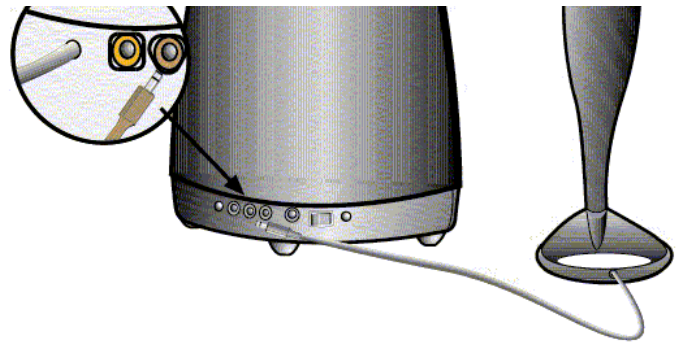
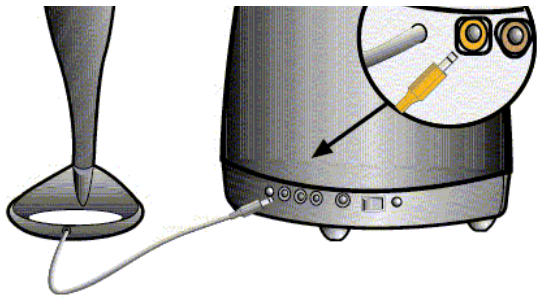

4

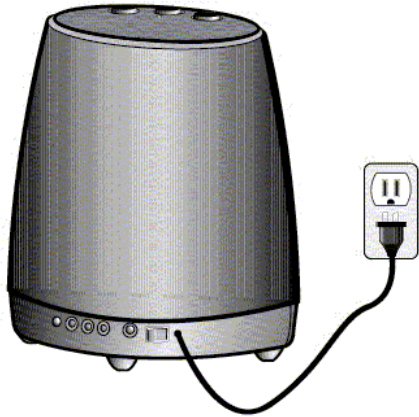

5

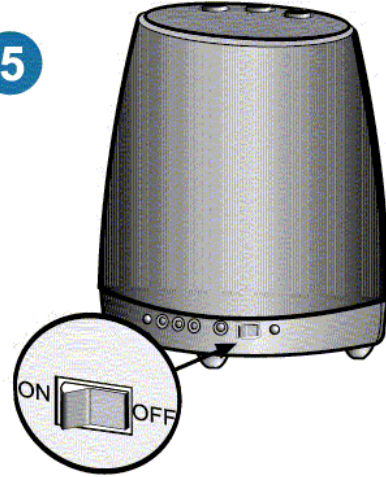

Connecting the Speaker System to a STEREO Sound Card

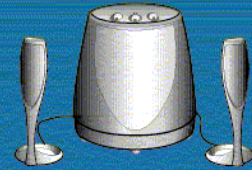

1

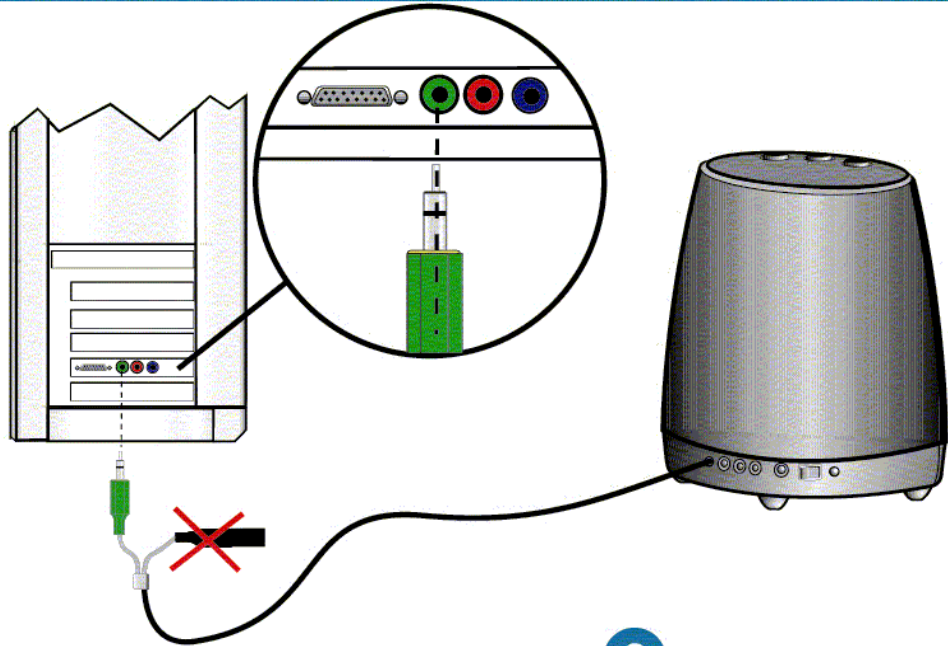

2

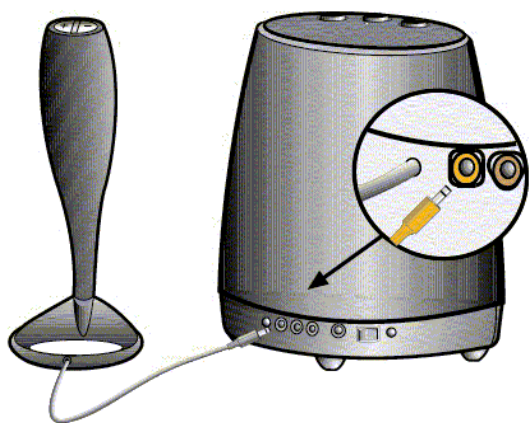

3

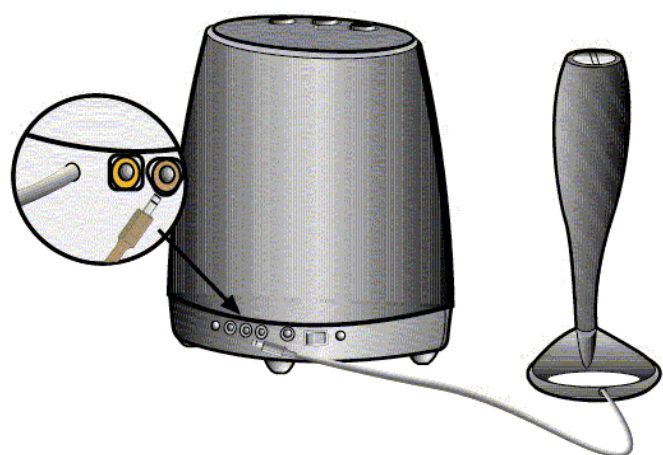

4

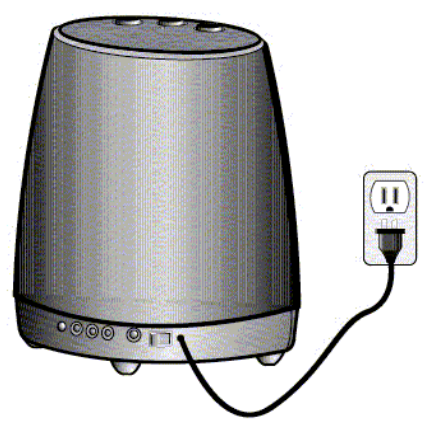

5

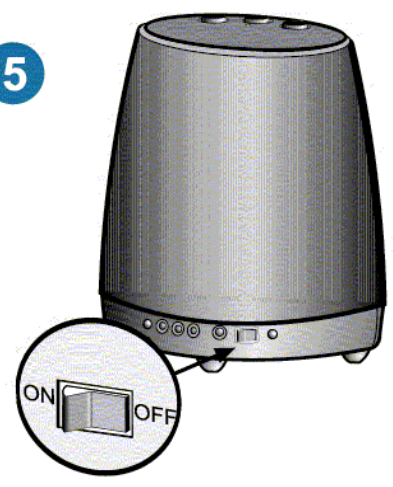

Connecting the Speaker System to a MULTI-CHANNEL Sound Card

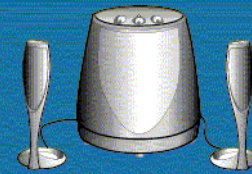

1

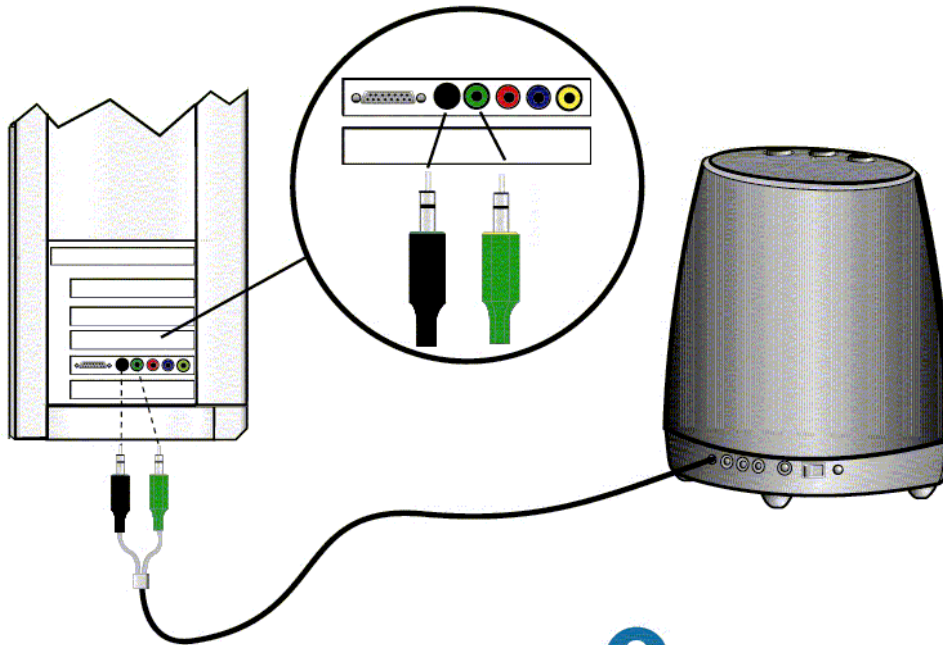

2

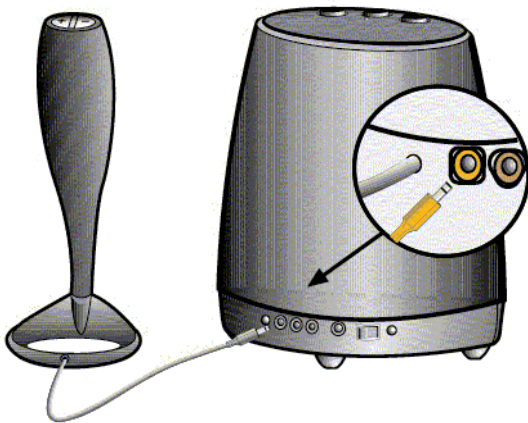

3

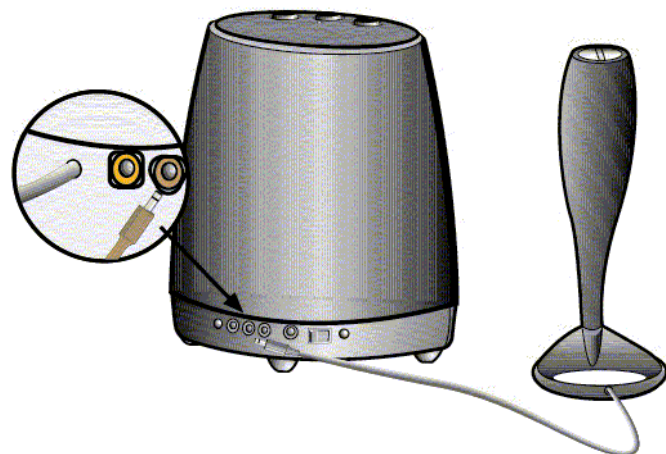

4

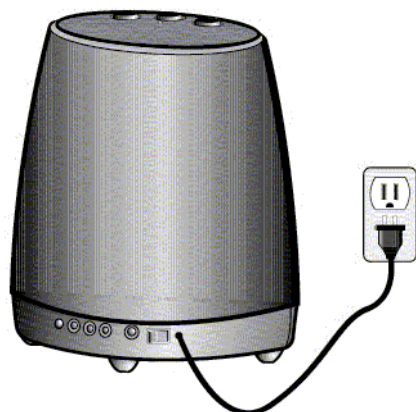

5

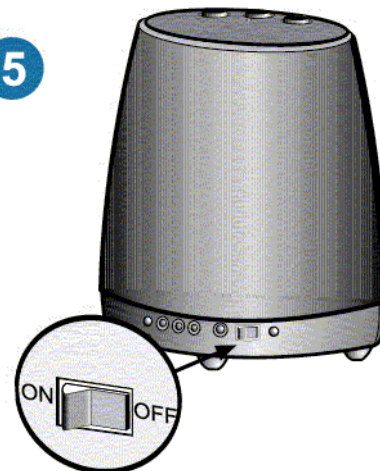

Connecting the Speaker System to Notebook STEREO Sound

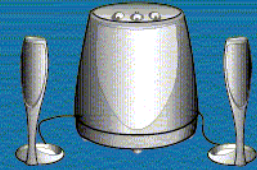

1

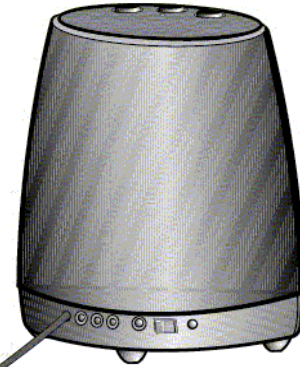
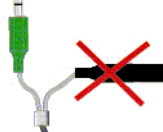
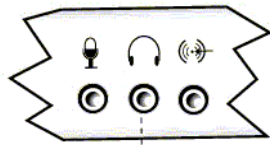

2

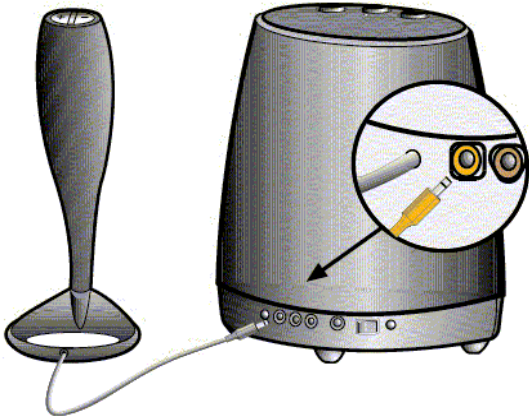

3

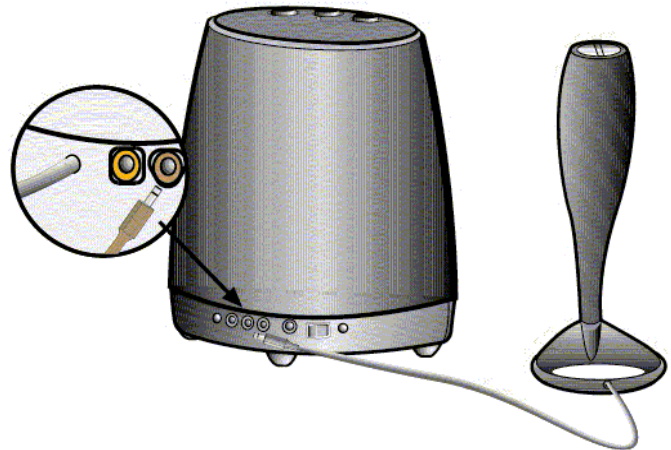

4

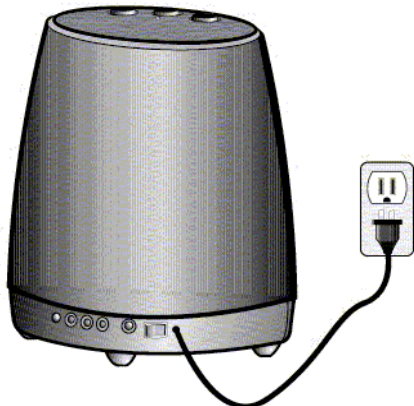

5

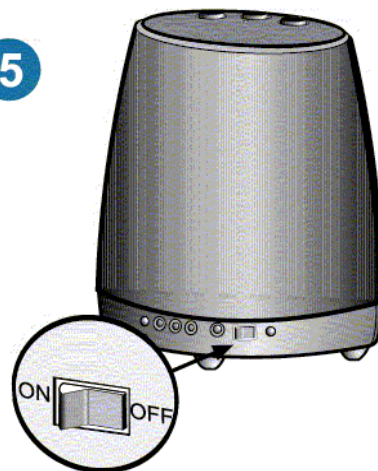



[Back to top](#)

Placement of speakers

The speakers are magnetically shielded and can be placed close to a computer monitor without distorting the image. For optimal stereo imaging, separate the speakers from each other by a distance equal to your distance from the speakers.

The subwoofer's sound is non-directional; therefore, does not have to be placed in any particular relationship to the satellites. The subwoofer is magnetically shielded and can be placed on the desktop, if desired. If the subwoofer is placed too close to a computer monitor it can cause vibration on the monitor screen.

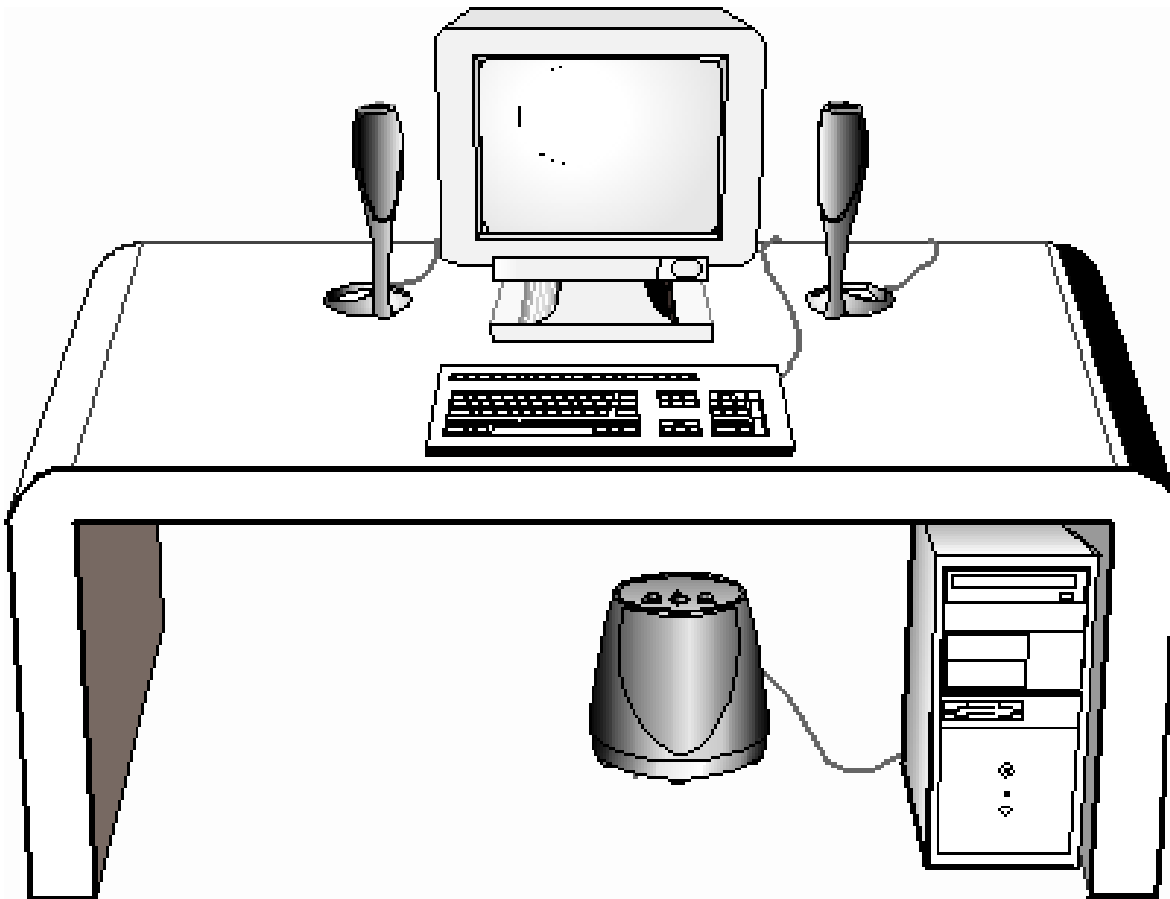

[Back to Contents Page](#)

[Back to Contents Page](#)

Using the speaker system: harman/kardon HK695 Audio System

[On/Off Switch](#) • [Volume Control](#) • [Muting](#) • [Controls on the subwoofer](#) • [Diagnostics](#)

Using the speaker system

On Off Switch

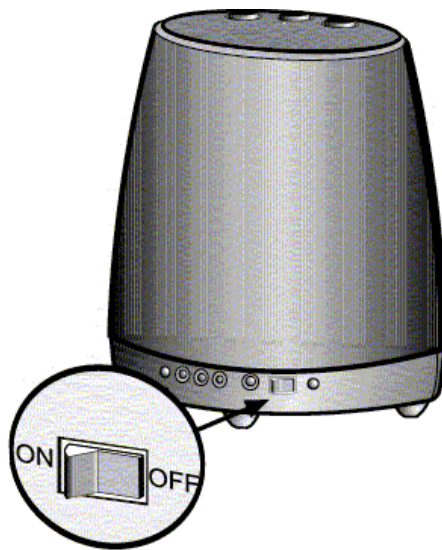

An on/off switch is located on the rear of the subwoofer. There is a green LED located on top of each of the two satellite speakers. There is also a green LED located on the top of the subwoofer. All three LEDs should illuminate when the system is connected correctly and receiving power.

Turn the speaker off if it will not be used for a long period.

[Back to top](#)

Volume control

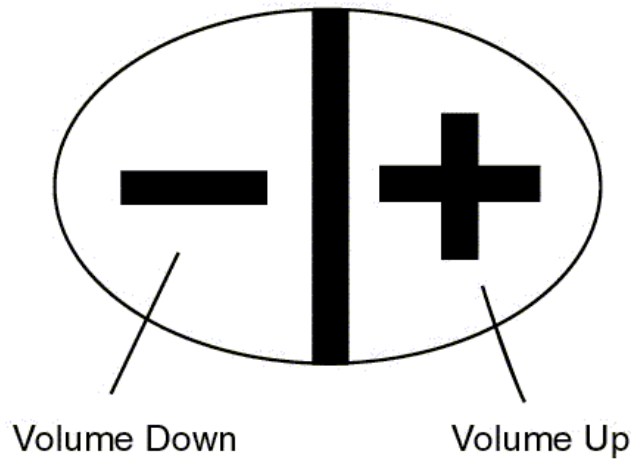

The volume control can be found on the top of the control/right satellite speaker. Pushing the right + button on the top of this speaker will turn up the volume setting in increments of 2.0 dB per step. If the button is continuously depressed, after 0.5 seconds the volume level will constantly increase at a rate of 20 dB per second. Pushing the left - button on the top of the right speaker will turn down the volume setting in increments of 2.0 dB per step. If the button is continuously depressed, after 0.5 seconds the volume level will constantly decrease at a rate of 20 dB per second until the system is muted. The harman/kardon HK695 Audio System will retain the volume setting when mute is turned off. The system will store the setting so that when the speaker is turned back on, the system will restore the last volume setting.

Muting

Pushing the left and right buttons simultaneously on the top of the right speaker will mute the audio. Power will remain on (both speakers' LEDs remain illuminated). When muted, pushing either the left button or the right button, or both buttons simultaneously will restore volume to the level prior to the activation of the mute function.

[Back to top](#)

Controls on the subwoofer

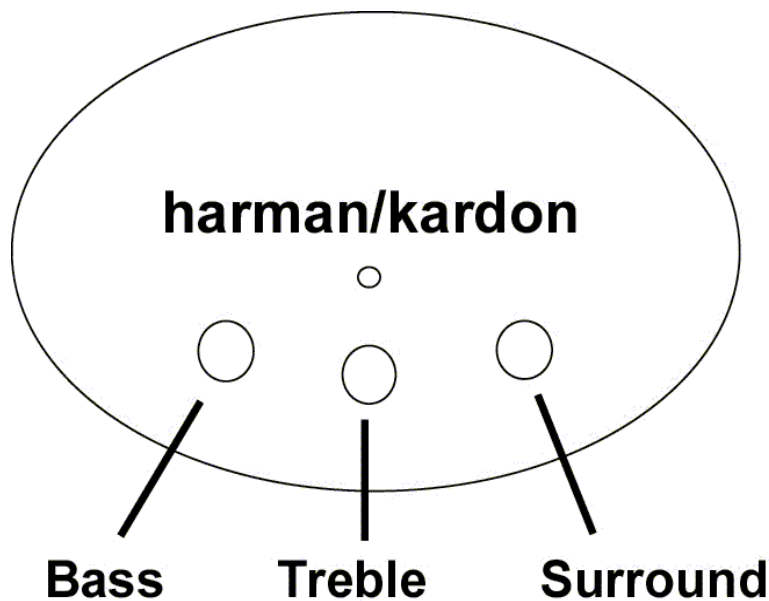

There are three tone and effects level knobs located on the top of the subwoofer. They control Bass, Treble and Surround.

Bass - Turn the knob marked Bass clockwise to increase the subwoofer level or counterclockwise to decrease the subwoofer level.

Treble – Turn the knob marked Treble clockwise to increase the treble level or counterclockwise to decrease the treble level.

Surround - Turn the knob marked Surround clockwise to increase the surround level or counterclockwise to decrease the surround level. Turning this knob all the way counterclockwise will defeat the surround mode.

[Back to top](#)

Diagnostics

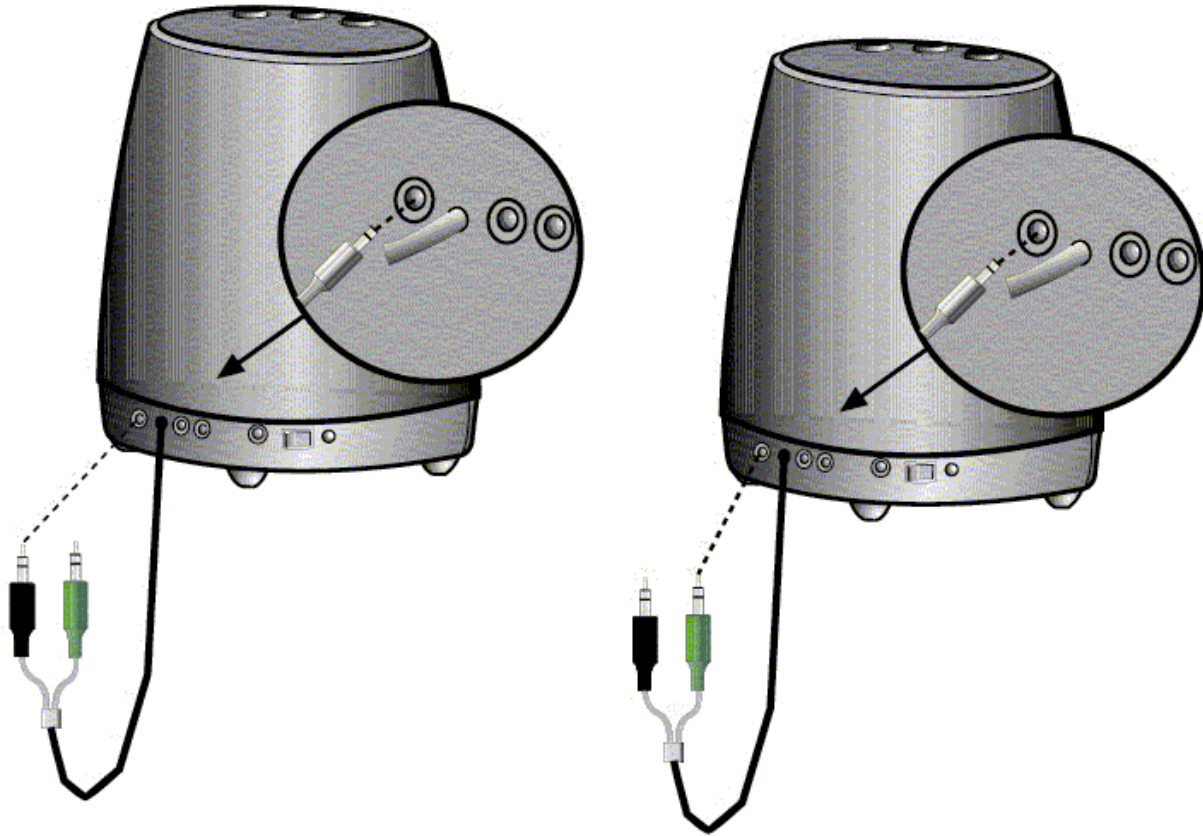

In order to facilitate optimal system setup, a diagnostic system has been built in to the harman/kardon HK695 Audio System. If you are having trouble getting sound out of your system, or are not confident that your setup is optimal, use these system diagnostics to configure your harman/kardon HK695 Audio system.

Disconnect all speaker cables from the sound card. To test the front speaker channel, plug the green connector into the diagnostic jack on the rear of the subwoofer. This will generate a test tone. This tone will alternate from the Subwoofer to the satellites and back again.

The diagnostic test can also be used to test the rear speaker channel input by plugging in the black connector into the diagnostic jack on the rear of the subwoofer. (Test tone may sound different due to the surround characteristics of speaker system).

When you have finished the test, unplug the cable from the 'DIAG' jack and plug the audio cable back into the correct soundcard output jack. Review the user setup if necessary.

While the speaker system is in the diagnostic mode, the **-/+** controls will control the volume of the diagnostic tone.

If the test tone was heard from all speakers, your HK695 Audio System is working correctly. If not, see the troubleshooting section for detailed troubleshooting techniques.

[Back to top](#)

[Back to Contents Page](#)

[Back to Contents Page](#)

Diagnostics: harman/kardon HK695 Audio System

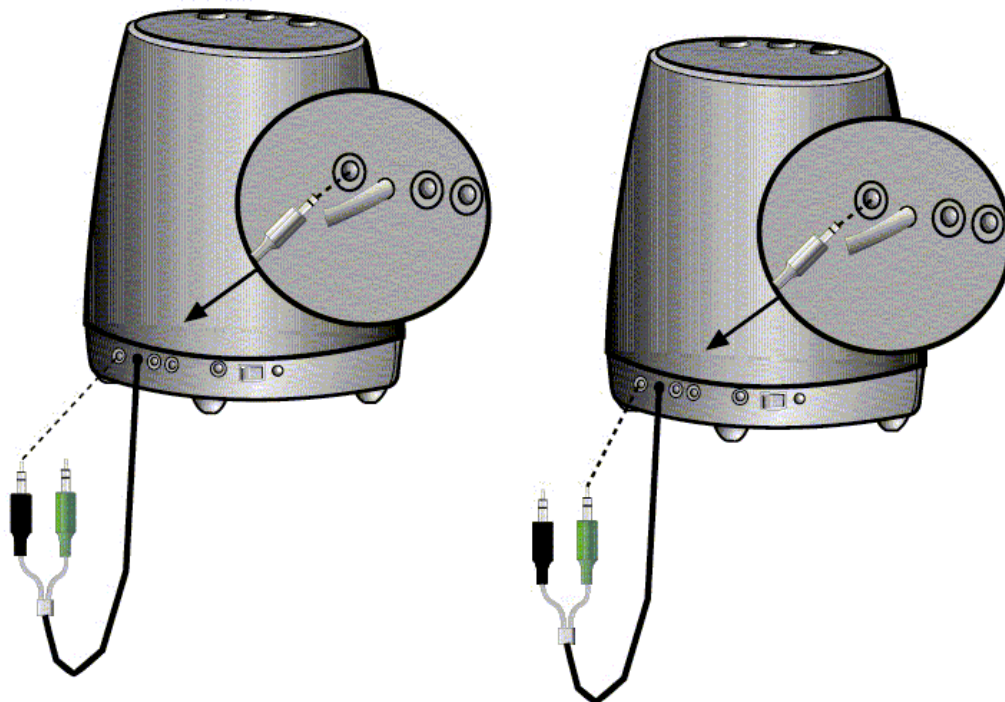

In order to facilitate optimal system setup, a diagnostic system has been built in to the harman/kardon HK695 Audio System. If you are having trouble getting sound out of your system, or are not confident that your setup is optimal, use these system diagnostics to configure your harman/kardon HK695 Audio system.

Disconnect all speaker cables from the sound card. To test the front speaker channel, plug the green cable into the diagnostic jack on the rear of the subwoofer. This will generate a test tone. This tone will sweep from 40Hz to 400Hz through both the subwoofer and both satellites.

The diagnostic test can also be used to test the rear speaker channel input by plugging in the black cable into the diagnostic jack on the rear of the subwoofer. (Test tone may sound different due to the surround characteristics of speaker system).

When you have finished the test, unplug the cable from the 'DIAG' jack and plug the audio cable back into the correct soundcard output jack. Review the user setup if necessary.

While the speaker system is in the diagnostic mode, the **-/+** controls will control the volume of

the diagnostics tone.

If the test tone was heard from all speakers, your HK695 Audio System is working correctly. If not, see the troubleshooting section for detailed troubleshooting techniques.

[Back to Contents Page](#)

[Back to Contents Page](#)

Troubleshooting: harman/kardon HK695 Audio System

[Troubleshooting](#) • [Getting Help](#)

Troubleshooting

SYMPTOM	POSSIBLE PROBLEM	SOLUTION	NOTE
No sound from Speakers	No power to unit.	<p>Make sure wall power outlet or power strip has power. Make sure all switches for outlet/power strip are on and that all switches for speaker system are on.</p> <p>Toggle the power switch.</p> <p>Replace the fuse. The fuse holder is on the back of the subwoofer between the power cord connector and the power switch. Use a screwdriver to turn a quarter turn in the direction indicated by the arrow. A spare fuse was supplied with the product, attached to the AC cord. See the specification section for a description of the fuse</p>	<p>Check green power LED on the sub. If the sub's LED is not on, power is not getting to your speaker system. Try the solutions shown.</p> <p>WARNING!</p> <p>Unplug the speaker system from the electrical outlet before replacing the fuse.</p>
	Is the control/right satellite of your HK695 Audio system plugged in correctly?	<p>Ensure that the control speaker connector is pushed in properly.</p> <p>Remove the control/right speaker connector from the subwoofer, then re-connect this cable ensuring that the connector is pushed in properly.</p>	There is an LED located in the top of each of the two satellite speakers. These should both be lit. If they are, your speakers are both plugged in correctly.

	Volume level may be set low or muted.	Increase volume level on control/right speaker. Check volume level and mute setting in Windows Volume Control.	Assuming power has been verified, engage the self-test by removing the audio connector(s) from the sound source output (s) and connecting it to the "DIAG" jack.
Distortion (static, crackling or hissing sounds)	Noise may be caused by interference from the monitor.	Turn monitor off to see if noise is eliminated. Move speaker cables farther away from monitor.	
	Speaker is being overdriven by an amplified audio source.	Ensure that speaker is connected to the appropriate receptacle. Check color-coding on connectors when making connections. Make sure that all signal cables are inserted snugly into receptacles.	
	Volume level on sound card may be too high.	Check volume of sound card via Windows Volume Control.	
	Sound card or audio source material may be cause of problem.	Check speakers with another audio source, such as a portable CD player.	Disconnect speaker input cable (green connector) from sound card and plug into CD ROM headphone jack. If static is eliminated, troubleshoot the soundcard.
	Are the speaker mode settings optimized?	Set each of the three knobs (treble, bass, surround) on top of the subwoofer to their center/nominal positions.	
Too much bass or treble.	Bass/Treble level is set too high.	Turn Bass/Treble down or return their settings to the nominal position.	
Subwoofer emits a loud hum or buzzing noise.	Input cables not plugged in properly.	Check input cable connection	

<p>Speaker System emits a loud hum or buzzing noise when used with a stereo only (not multichannel) soundcard.</p>	<p>The redundant rear (black) audio connector is not protected by the rubber cover and is touching the computer system</p>	<p>Replace the rubber cover or otherwise insulate the rear audio connector so it cannot contact any metallic surfaces</p>	
<p>Speaker system experiences radio frequency interference or picks up a radio station.</p>	<p>Input cable may be picking up interference.</p>	<p>Wrap up excess input cable in order to make as short as possible.</p>	
		<p>Purchase a ferrite clamp and attach over input cable. A clamp can be purchased at your local electronics store.</p>	

Getting Help

If the troubleshooting procedures in this document do not resolve the problem, please contact Dell™ Computer Corporation for technical assistance (refer to the "Getting Help" section in your system documentation). For information about your Dell™ warranty, see your Dell™ system documentation.

[Back to Contents Page](#)

[Back to Contents Page](#)

Specifications: harman/kardon HK695 Audio System

[Dimensions](#) • [Power](#)

Manufacturer	Harman International
Model Number	harman/kardon HK695 Audio System
Drivers (satellite)	Two Odyssey
Drivers (subwoofer)	One 5.25 inch woofer
Power (satellite)	6 Watts per satellite @ 1% THD +N
Power (subwoofer)	28 Watts @ 1% THD+N
Crossover Frequency (subwoofer)	180 Hz
Dimensions	
Width: Satellite	3.5 inches
Subwoofer	11.75 inches
Depth: Satellite	5.75 inches
Subwoofer	11.75 inches
Height: Satellite	11.5 inches
Subwoofer	13 inches
Input Impedance	5k- 10k Ohm
Signal-to-Noise ratio	>70 dB

Frequency Response	35 – 20 kHz
Input Sensitivity	300-400 mV rms. for rated power output
USA/Canada Power	120 volts, 60Hz AC
Maximum Power Consumption	120 watts
UL/CUL/CE Approved	

[Back to Contents Page](#)

[Back to Contents Page](#)

Regulatory: harman/kardon HK695 Audio System

FCC Statement and Warning

This equipment has been tested and found to comply with the limits for a Class B digital device, pursuant to Part 15 of the FCC rules. These limits are designed to provide reasonable protection against harmful interference in a residential installation. This equipment generates, uses and can radiate radio frequency energy and, if not installed and used in accordance with the instructions, may cause harmful interference to radio communications. However, there is no guarantee that interference will not occur in a particular installation. If this equipment does cause harmful interference to radio or television reception, which can be determined by turning the equipment off and on, the user is encouraged to try to correct the interference by on or more of the following measures:

- Re-orient or relocate the receiving antenna.
- Increase the separation between the equipment and receiver.
- Connect the equipment to an outlet on a circuit different from that to which the receiver is connected.
- Consult the dealer or an experienced radio/TV technician for help.
- **MODIFICATIONS NOT EXPRESSLY APPROVED BY THE MANUFACTURER COULD VOID THE USER AUTHORITY TO OPERATE THE EQUIPMENT UNDER FCC RULES.**

[Back to Contents Page](#)