

## **INTRODUCTION**

The symbols described below are found in this instruction manual as well as on the unit itself to insure its proper and safe usage and to prevent injury or damage to property. Make sure you understand the meaning of these symbols before reading the rest of this manual.

### **READ FIRST**

We recommend that you wait until the positioning stabilizes before starting to drive.

If you start to drive while the positioning is not complete, the indicated position may differ from the actual vehicle position.

The screens shown in this manual may differ from the actual screens depending on the data type or when the map data was created.

When maps are created, land surveys are conducted and information on road improvements and reopening is collected to provide the most accurate information possible. However, modifications to roads, place names and facilities may be carried out at any time. Consequently, we cannot guarantee that map data contains no errors in road positions, configuration and names, or in facility names.

Information in this manual that must be observed for the unit, and information that is useful to know is indicated as follows.

**⚠ WARNING**

- This sign indicates a situation in which incorrect handling through disregard of written information might result in death or serious personal injury.

**⚠ CAUTION**

- This sign indicates a situation in which incorrect handling through disregard of written information might result in personal injury or damage to property.

**NOTE**

- Useful information for the user is described.
- Be sure to read all materials such as manuals and warranties that come with the product. SUBARU CORPORATION is not responsible for problems that arise due to failure to follow these instructions.
- Changes to product specifications may result in differences between the content of the manual and the features of the unit.

**SYMBOLS USED IN ILLUSTRATIONS**

**Safety symbol**



The symbol of a circle with a slash through it means "Do not", "Do not do this" or "Do not let this happen".

**Arrows indicating operations**

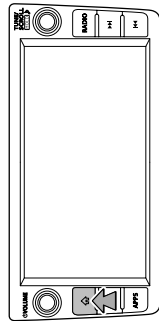

↑ Indicates the action (pushing, turning, etc.) used to operate switches and other devices.

**INTRODUCTION**

## PRECAUTIONS FOR USE

### WARNING

- The main unit requires a 12 V DC power supply. The main unit should not be installed in any vehicle which does not have a 12 V power system with a ground-connected negative side. An installation other than the one intended may cause severe damage to the main unit, and electric shock or serious injury to the users.
- Even when using the route guidance of the navigation system, be sure to drive by following the actual traffic regulations. If you drive by following only the route guidance of the navigation system, you may violate the actual traffic regulations and cause a traffic accident.
- To ensure safety, the driver should not operate the navigation system while driving. Operating the navigation system while driving may result in an accidental steering wheel operation or otherwise cause an accident. Stop the vehicle before operating the navigation system. Also, do not watch the screen while driving because doing so may be dangerous (ETC). Inattention to road conditions ahead may result in an accident.
- The driver should not perform operations such as volume adjustment while driving. Inattention to road conditions ahead may result in an accident, so be sure to stop the vehicle in a safe place before performing the operation.

- The driver should not perform operations such as adding a location or setting the memory while driving. Inattention to road conditions ahead may result in an accident, so be sure to stop the vehicle in a safe place before performing the operation.
- Before viewing a video, be sure to stop the vehicle in a safe place and apply the parking brake. To ensure safety, videos are not displayed during driving.
- To ensure safety, never operate a cell phone while driving.
- Do not disassemble or modify the unit. Doing so may result in an accident, fire or electric shock.
- Do not let water or foreign objects enter the internal parts of the unit. Doing so may result in smoke, fire or an electric shock.
- Do not use the unit when it is malfunctioning, such as when the screen is not lit or no sound comes out. Doing so may result in an accident, fire or electric shock.

- Always replace fuses with fuses of the same specified capacity (amperage). Using a fuse with a higher capacity than the specification may result in a fire.
- If a foreign object or water enters the unit, smoke or a strange odor may be emitted. If such an abnormality occurs, stop using the unit immediately and contact your SUBARU dealer. An accident, fire or electric shock may result if you continue to use the unit under these conditions.
- In a thunderstorm, do not touch the antenna line or the unit. Lightning may cause an electric shock.
- Do not park or stop in prohibited areas to use the unit.
- If direct sunlight shines into the vehicle, light may reflect off the product. Be very careful while driving.
- Never use headphones or earphones while driving. Driving while not being able to hear sounds from outside the vehicle may result in a traffic accident.



### CAUTION

- Although the unit can be used when the ignition switch is set to either "ACC" or "ON" position, to protect the battery, start the engine before using the unit.
- Do not use the unit anywhere other than in a vehicle. Doing so may result in an electric shock or other injury.

## INTRODUCTION

- While driving, keep the volume low enough for you to hear outside sounds. Driving while not being able to hear sounds from outside the vehicle may result in an accident.
- Be careful of the volume when turning on the power. If a loud noise is emitted suddenly when you turn on the power, it may damage your hearing.
- Do not apply a strong force to the display. Doing so may result in a malfunction.
- Do not touch the hot parts of the unit. The hot parts may burn you.
- Do not use while there is an abnormality such as sound breakup or distortion. Doing so may result in a fire.
- Using the unit during extremely high or low temperature may result in mistaken operation or a malfunction. In particular, the temperature inside the vehicle can often rise to a high level during the summer. Cool the vehicle, for example by opening a window, before using the unit.
- Be careful if metal or water enters the unit, or the unit is exposed to a strong impact, because it may result in a malfunction.
- The touch buttons on the display screen may not operate correctly if condensation forms inside them. If this happens, do not attempt to operate the switches until the condensation has disappeared.

## INTRODUCTION

- If juice or similar liquid is spilled on the display, wipe off immediately. Failure to do so may result in product malfunction.
- The screen is easily marked by fingerprints and tends to attract dust, and should therefore be cleaned occasionally. When cleaning, turn off the power, and wipe lightly with a soft, dry cloth. To remove dirt, soak a soft cloth in neutral detergent and squeeze well before wiping. Do not use a wet floor-cloth, organic solvents (benzene, ethanol, thinner, etc.), acids, or alkalis. Using such agents will result in screen deterioration. Furthermore, do not hit the screen or rub it with hard objects.

## NOTE

- SUBARU CORPORATION is not responsible for any damages to the purchaser or third parties that occur from using the map data.
- We do not provide any replacements or refunds for any mistakes there may be in the map data displays or contents, such as misspelling, omissions or misaligned positions.
- SUBARU CORPORATION makes no guarantee that the functions included in the map data will be appropriate for the specific objectives of the purchaser.
- Functions that cannot be operated while driving have their colors toned down when the vehicle is being driven, and their operation is disabled. Touching a disabled switch may result in the display of an operation prohibited message on the screen.

## NOTE

- When using the unit for the first time after purchase, or after the battery was removed for a long time, the current position may not be displayed correctly. Wait a short time until the GPS positioning corrects the displayed position.
- This device is precision-engineered equipment and the recorded data can be lost as a result of static electricity, electrical noise, vibration, or other influences. To protect the device against data loss, we recommend keeping a separate record of the data that you record after purchase.
- The screen may be adversely affected or disturbed by noise if electrical equipment that generates powerful electrical noise is used near the system. In such cases, keep the electrical equipment at a distance, or refrain from use.

## SAFETY INSTRUCTION

### NOTE

- The display may appear brighter when the temperature is low, or immediately after starting the engine, however, this is a characteristic of the LED elements, and does not indicate a fault. The display will return to its original brightness when the vehicle cabin has warmed up.
- When you look at the screen through polarized material such as polarized sunglasses, the screen may be dark and hard to see. If so, look at the screen from different angles, adjust the screen settings on the general settings screen or take off your sunglasses.
- It may be difficult to view the screen if the display is exposed to sunlight from an awkward angle.
- The LCD screen may not function normally if covered with a protective film. Do not affix a protective film.
- The touch panel may function incorrectly or fail to respond if operated with objects other than fingers (nails, operation when wearing gloves, pens, etc.)
- If the system functions unexpectedly such as an area other than the one touched being selected, or failure to respond when touched, there is a possibility that another finger or part of the hand is in contact with display.
- Scratches on the system panel surface are easily noticeable, and it should therefore be handled with care.

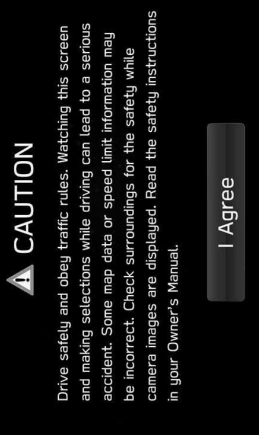

To use this system in the safest possible manner, follow all the safety tips shown below.

This system is intended to assist in reaching the destination and, if used properly, can do so. The driver is solely responsible for the safe operation of your vehicle and the safety of your passengers.

## INTRODUCTION

Do not use any feature of this system to the extent it becomes a distraction and prevents safe driving. The first priority while driving should always be the safe operation of the vehicle. While driving, be sure to observe all traffic regulations.

Prior to the actual use of this system, learn how to use it and become thoroughly familiar with it. Read the entire manual to make sure you understand the system. Do not allow other people to use this system until they have read and understood the instructions in this manual.

For your safety, some functions may become inoperable when driving. Unavailable screen buttons are dimmed. Only when the vehicle is not moving, can the destination and route selection be done.

### **WARNING**

- For safety, the driver should not operate the system while he/she is driving. Insufficient attention to the road and traffic may cause an accident.
- While driving, be sure to obey the traffic regulations and maintain awareness of the road conditions. If a traffic sign on the road has been changed, route guidance may not have the updated information such as the direction of a one way street.

While driving, listen to the voice instructions as much as possible and glance at the screen briefly and only when it is safe. However, do not totally rely on voice guidance. Use it just for reference. If the system cannot determine the current position correctly, there is a possibility of incorrect, late, or non-voice guidance.

The data in the system may occasionally be incomplete. Road conditions, including driving restrictions (no left turns, street closures, etc.) frequently change. Therefore, before following any instructions from the system, look to see whether the instruction can be done safely and legally.

This system cannot warn about such things as the safety of an area, condition of streets, and availability of emergency services. If unsure about the safety of an area, do not drive into it. Under no circumstances is this system a substitute for the driver's personal judgement.

Use this system only in locations where it is legal to do so. Some states/provinces may have laws prohibiting the use of video and navigation screens next to the driver.

# HOW TO READ THIS MANUAL

## Bluetooth® SETTINGS

- ▶ When setting the Bluetooth phone/device
- 4. Select the desired Bluetooth phone/device.
- 5. Select the item to be set.



No.	Function	Page
1	Connecting or disconnecting Bluetooth phones/devices	46
2	Deleting Bluetooth phones/devices	48
3	Setting phonebook download	48
4	Setting the automatic connection priority	49

### NOTE

- The phone settings screen can also be displayed by selecting **Change Device** (Change Device) on the phone overview screen (→P.76) or Bluetooth audio operation screen (→P.57).

## REGISTERING A Bluetooth PHONE/DEVICE

Up to 5 Bluetooth phones/devices can be registered. Bluetooth compatible phones (HFP) and devices (AVP) can be registered simultaneously. This operation cannot be performed while driving.

1. Display the phone settings screen. (→P.43)
2. Select **Add Device** (Add Device).



- If a message appears, follow the guidance on the screen.

No.	Name	Description
1	Operational Outlines	An outline of the operation is explained.
2	Main Operations	The steps of an operation are explained.
3	Supplemental information	Describes supplemental information relating to main operation.

- When a panel button should be selected, button names are shown as **000**.
- When a touch button on the screen should be selected, button names are shown as **000**.



# Quick Guide



<b>System Types</b>	14
<b>Main Product Features</b>	16
<b>Basic Function</b>	18
Overview Buttons .....	18
Home Screen .....	19
“Phone (Phone)” Screen .....	20
“Map (Map)” Screen .....	22
“Radio (Radio)” Screen .....	24
“Media (Media)” Screen .....	25
“Apps (Apps)” Screen .....	26
“Settings (Settings)” Screen .....	28
<b>Steering Wheel Controls</b>	30
Steering Wheel Controls .....	30

SYSTEM TYPES

**SYSTEM TYPES**

This manual describes the operation method for the 7-inch with Navigation system.

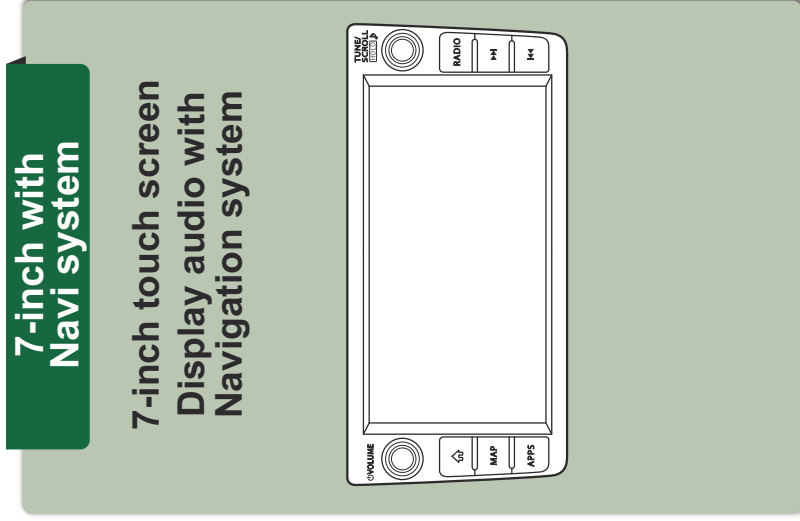

» MAIN FUNCTIONS

Function	Page
Pairing (Bluetooth 3.0)	22
Navigation system	24
Apps	28
Apple CarPlay	109
Android Auto	111
AM/FM radio	26
HD Radio receiver	124
SiriusXM® satellite radio	128
Media operation	USB:139 iPod:141 Bluetooth audio:144
Phone	22
Voice recognition system	195
Steering wheel controls	32
Rear view camera	44

**7-inch with Navi system**  
 Features: - 7-inch touch screen  
 - **MAP** button

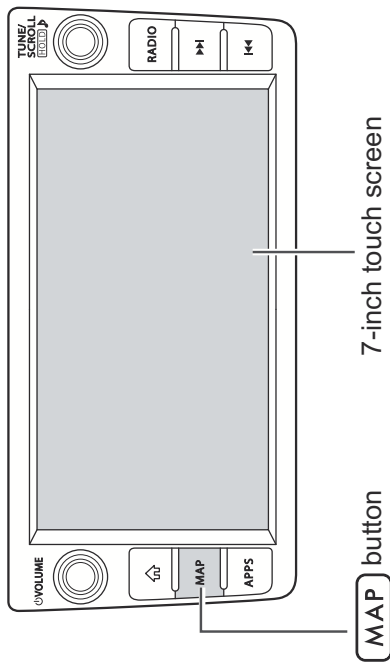

## MAIN PRODUCT FEATURES

### MAIN PRODUCT FEATURES

**Adoption of intuitive and easy-to-use smartphone-like graphical user interface**



### STANDARDIZED OPERATION SCREEN LAYOUT FOR ALL FUNCTIONS

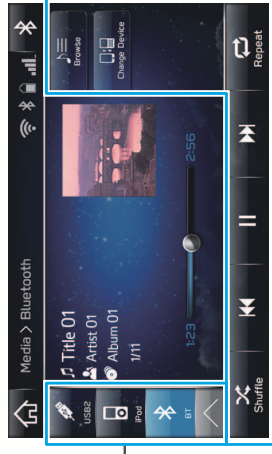

Mode switching buttons, etc. Operation buttons, etc.

**Mode switching buttons on the left and operation buttons on the right and at the bottom prevents users becoming lost in operation no matter which functions are used.**

### USE OF POP-UP SCREENS

Close pop-up screen to return to original screen



**Pop-up screens are used instead of screen switching, preventing users from losing the current screen.**

**Easy-to-view map screen display** P.161

Maps appear wider by minimizing constantly displayed buttons.



Touch screen to display automatically hidden buttons.

**Rough destination search function** P.171

Start a search with a variety of words such as addresses, facility names, intersection names, or latitude/longitude.

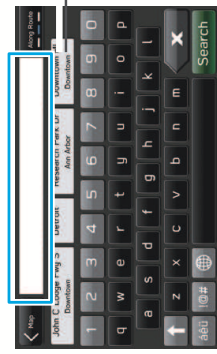

Displays search prediction

- Search results are predicted and candidates displayed even if only partial words are known
- Searches can even be performed with multiple keywords.

**Customized home screen layout** P.42

Frequently used functions and operations can be added to the home screen.



Example: For calling specific phone numbers, listening to specific radio stations, etc.

Button positions can be changed freely.

**System and Bluetooth phone / device pairing** P.22

Functions such as hands-free and applications can be used by connecting the system with Bluetooth phones / devices wirelessly.



**Apple CarPlay / Android Auto**

Support for Apple CarPlay and Android Auto allows access to functions such as maps, phone calls, and music.

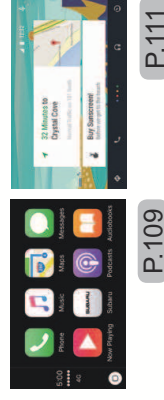

## BASIC FUNCTION

### OVERVIEW BUTTONS

#### TOUCH SCREEN

Operations are performed by touching the touch screen directly with your finger. P.36

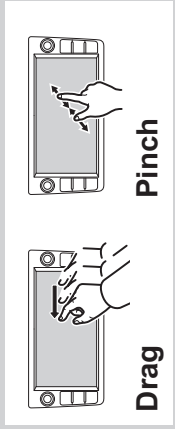

- Turn the knob** to adjust the volume.
- Press the knob** to turn the volume mute on/off.
- Press and hold** to turn the audio system on/off.

**Press button** to seek up or down for a radio station or to access a desired track/file.

**Press and hold button** to continuously seek for a radio station, or to fast forward/rewind files or tracks.

Displays the home screen

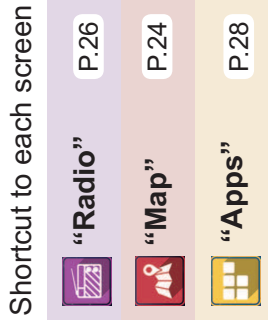

#### Audio operation screen:

- Turn the knob** to select a radio station or skip to the next or previous track/file.
- Press and hold the knob** to display the sound settings screen. P.71
- List display screen:**
  - Turn the knob** to move the cursor.
  - Press the knob** to select the item selected with the cursor.

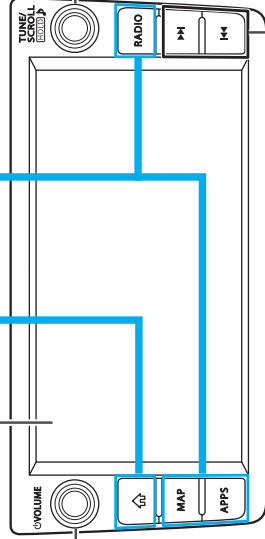

Radio P.122, 128  
 USB P.139 iPod P.141  
 Bluetooth audio P.144

# HOME SCREEN

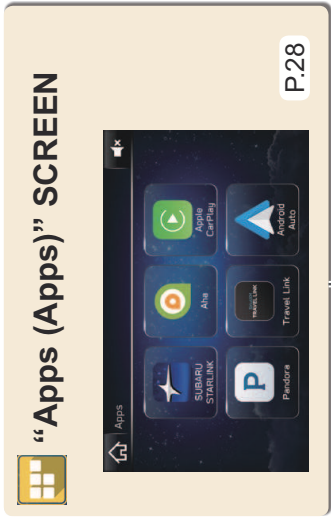
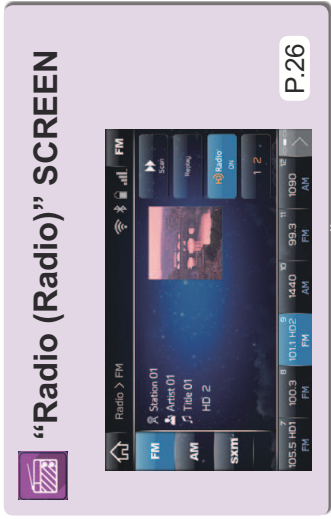

Frequently used functions and operations can be added to the home screen. P.42  
 Button positions can be changed freely. P.43  
 By connecting an iPhone or Android device to the USB port, a CarPlay or Android Auto icon will display.

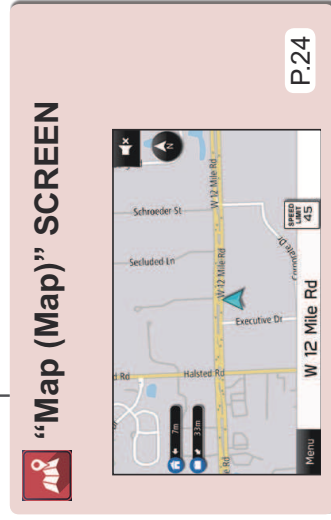



## “Phone (Phone)” SCREEN



Call or send a text message to a contact in the phonebook on the Bluetooth connected phone **P.83,90**

Call or send a text message to a registered favorite **P.82,90**

Check or reply to messages/place calls from received message list **P.89,91**

Call or send a text message to a recent contact **P.82,90**

Directly input a number to place a call **P.83**

## - Operation Flow: Pairing the System with a Bluetooth Phone/Device -

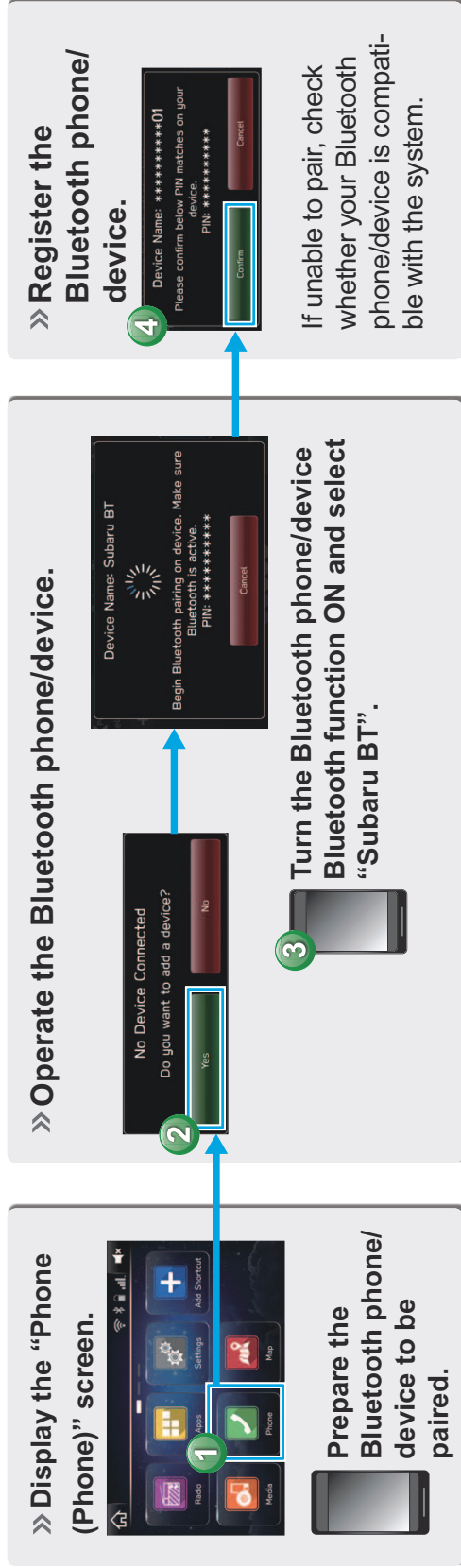



## - Operation Flow: Placing Calls/Sending Messages from the Phonebook -

» Select call recipient from phonebook.



If unable to select the button, the setting for downloading the phonebook for the Bluetooth phone may be OFF. P.60

» Select number for making call/sending message.

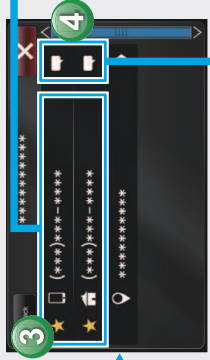

Place call

Send message

» Select message.



» Send message.

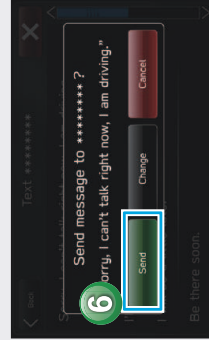

» In-call screen is displayed.



Hold call

Start three-way call

In-call screen display and operation may differ, or may not be possible depending on the Bluetooth phone used.

# “Map (Map)” SCREEN

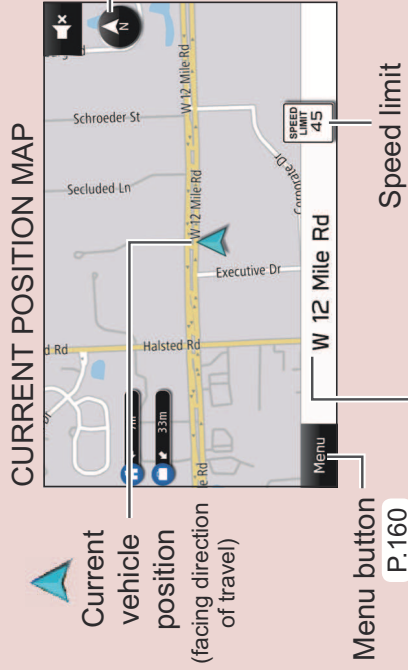

**Current street**  
 Touch the current street name to display details of the current location, allowing that location to be registered.



The orientation of the map can be changed between 2D north-up, 2D heading-up and 3D. P.163



2D North-up screen



2D Heading-up screen 3D screen

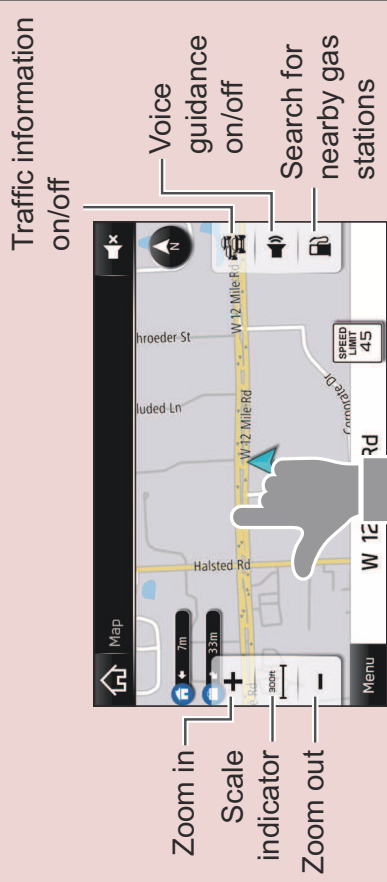

Touch screen to display automatically hidden buttons. P.161

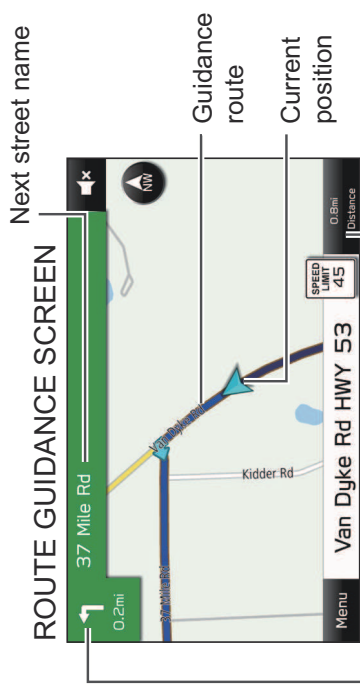

Distance to the next turn and an arrow indicating the turning direction

Remaining time/remaining distance/estimated arrival time

Destination search P.170  
 Route guidance P.178

# - Operation Flow: Route Guidance -

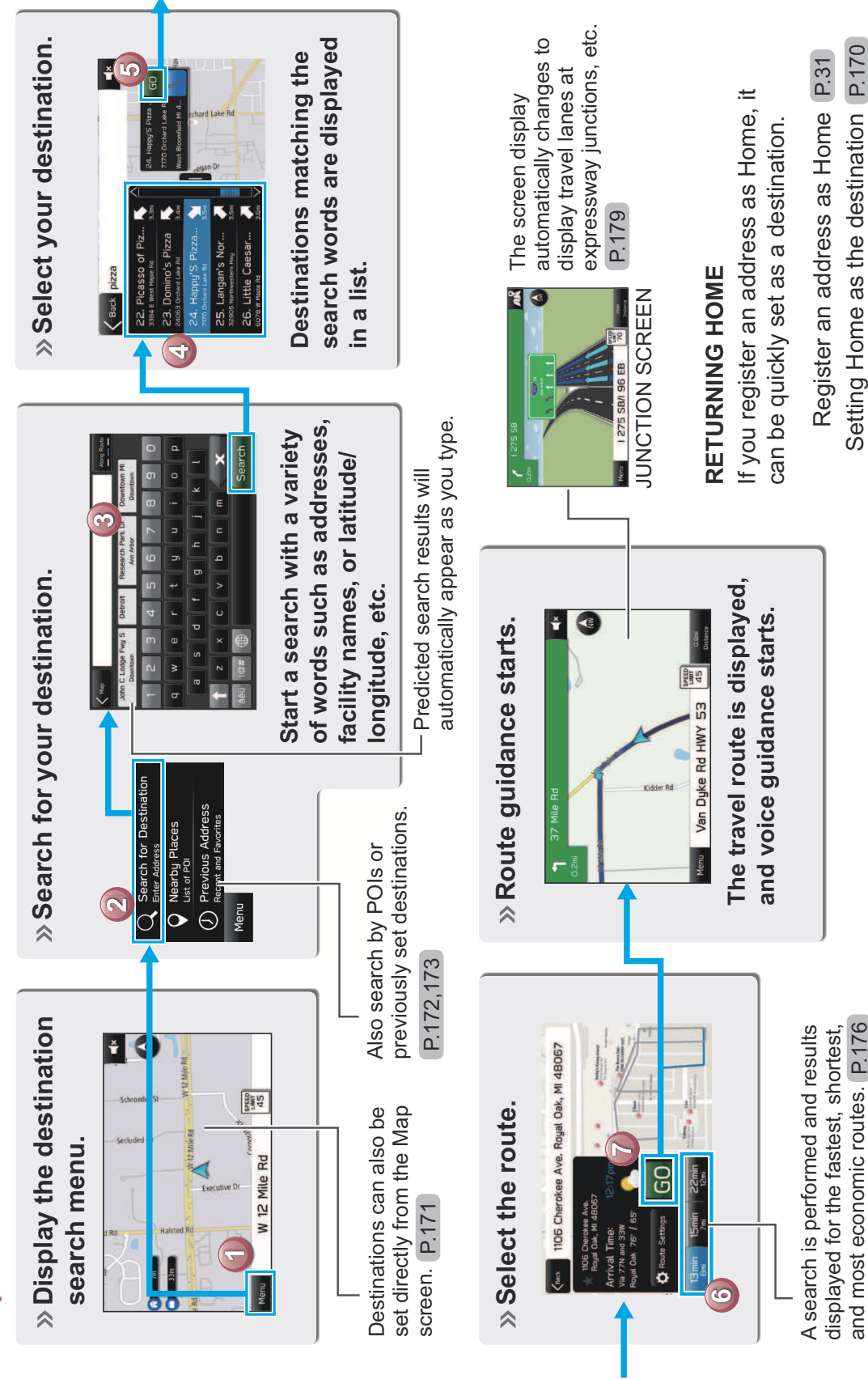

## “Radio (Radio)” SCREEN

Change radio mode

Select to scan for receivable stations/channels.

Select to turn HD Radio mode on/off (AM/FM). P.124

Preset stations/channels

Previous

Next

Pause/play

Current program

Radio programs can be temporarily saved and played back later. P.126

PAUSE AND PLAYBACK LIVE RADIO

### - Operation Flow: Presetting a Radio Station -

» Select the radio band.



A valid subscription to SiriusXM® Satellite Radio is required to receive satellite radio service.

» Select the radio station.

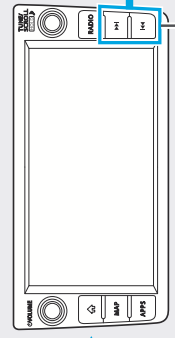
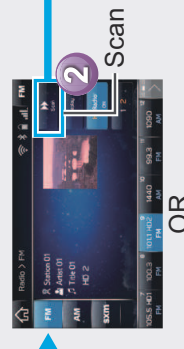

Select to seek for a station/channel.

» Register the radio station.



Mix preset function  
Multiple stations can be registered as presets. (AM, FM or SiriusXM® Satellite Radio) P.123

Select and hold one of the screen buttons.

## “Media (Media)” SCREEN

Change media source

Random playback on/off

Change tracks  
Select and hold to fast rewind

Pause/play

Change tracks  
Select and hold to fast forward

Repeat/do not repeat track currently playing

Playback tracks and programs, etc. in a variety of playback modes

Change to other Bluetooth audio device/register new device

### SUPPORTED MEDIA

USB/iPod P.156

Bluetooth audio P.53

1

## - Operation Flow: Using Playback Modes -

1 Display the playback mode list.

2 Select the playback mode.

3 Play a track.

4 Play the selected track.

Depending on the audio source, several items from these categories are displayed in a list.



## “Apps (Apps)” SCREEN

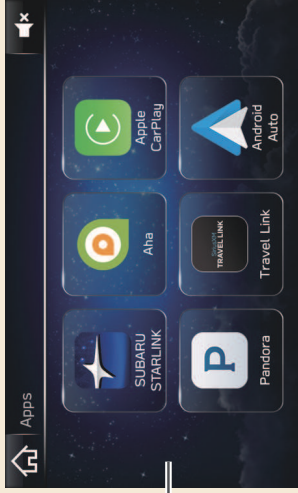

List of usable applications

### ABOUT USING APPLICATIONS

In order to use an application on this system, the corresponding application must be installed on your smartphone. **P.94**

Apple CarPlay does not require an application to be installed.

### Pandora\*

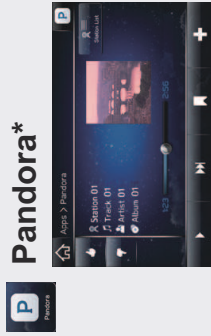

Pandora is free personalized radio that offers effortless and endless music enjoyment and discovery. **P.106**

\*: Pandora is only available in certain countries. Please visit [pandora.com/legal](http://pandora.com/legal) for more information.

### SUBARU STARLINK

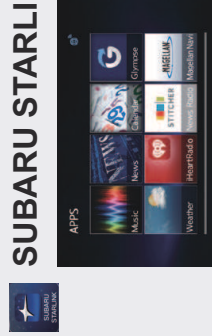

The SUBARU STARLINK function allows the system to link with a smartphone. **P.97**

### aha™



aha™ is a cloud-based application that connects to the system and gives you access to your favorite web content safely and easily. **P.102**

### Apple CarPlay

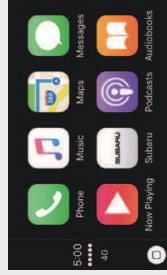

CarPlay can be used to view iPhone maps, play music, and place calls by connecting your iPhone to the system. Supported applications can also be run.

P.109

### Android Auto

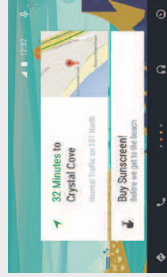

Android Auto can be used to view Android maps, play music, and place calls by connecting your Android device to the system. Supported applications can also be run.

P.111

### SiriusXM Travel Link



SiriusXM Travel Link is a service provided by SiriusXM® Satellite Radio, and can be used to view information on fuel information, sports, stocks, and weather.

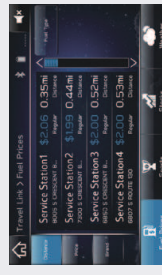

Fuel information

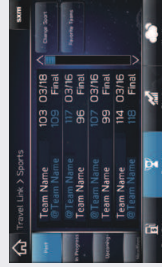

Sports

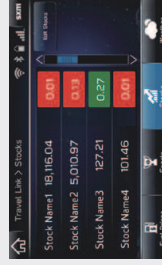

Stocks

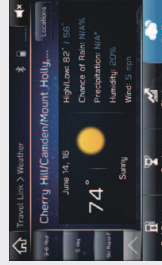

Weather

P.113

Weather information can be viewed by linking with the navigation function.

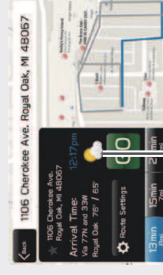

Current weather information for your destination can be viewed at the route calculation screen.

P.176

Weather information

Weather information broadcast by weather stations en route to your destination can be viewed during route guidance.

P.184

SiriusXM Travel Link subscription is required.

# “Settings (Settings)” SCREEN

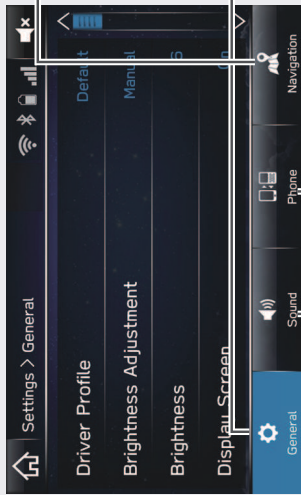

## Phone

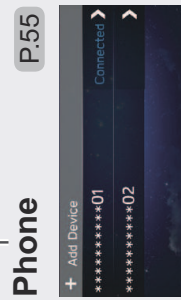

P.55

## Sound



P.71

## General

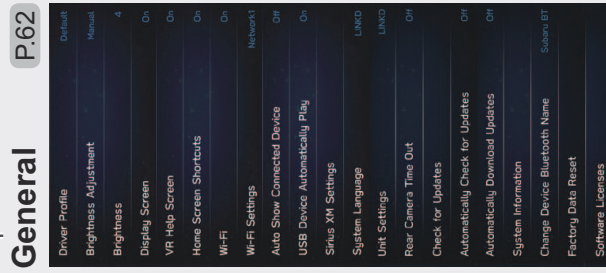

P.62

## Navigation



P.185



## - Operation Flow: Create a driver profile -

### CREATE A DRIVER PROFILE

Create a driver profile and register your cellular phone, address, etc. You can store and call registered information at any time.

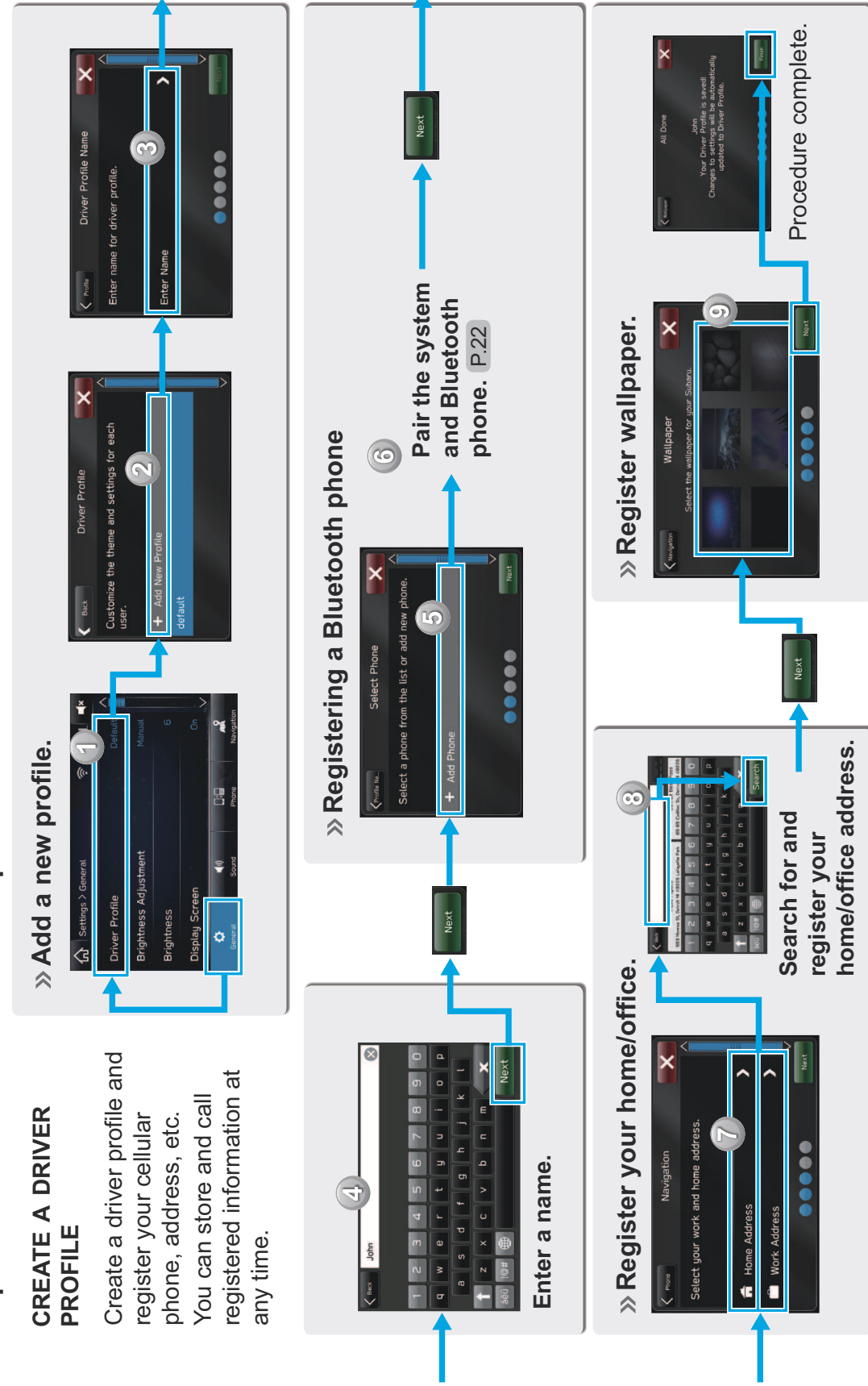

## STEERING WHEEL CONTROLS

### STEERING WHEEL CONTROLS

Some parts of the audio system can be controlled using the steering wheel controls. [P.149](#)

#### RADIO

**Press:** Preset station/channel up/down

**Press and hold:** Seek up/down continuously

#### MEDIA

**Press:** Select a track/file

**Press and hold:** Fast forward/rewind

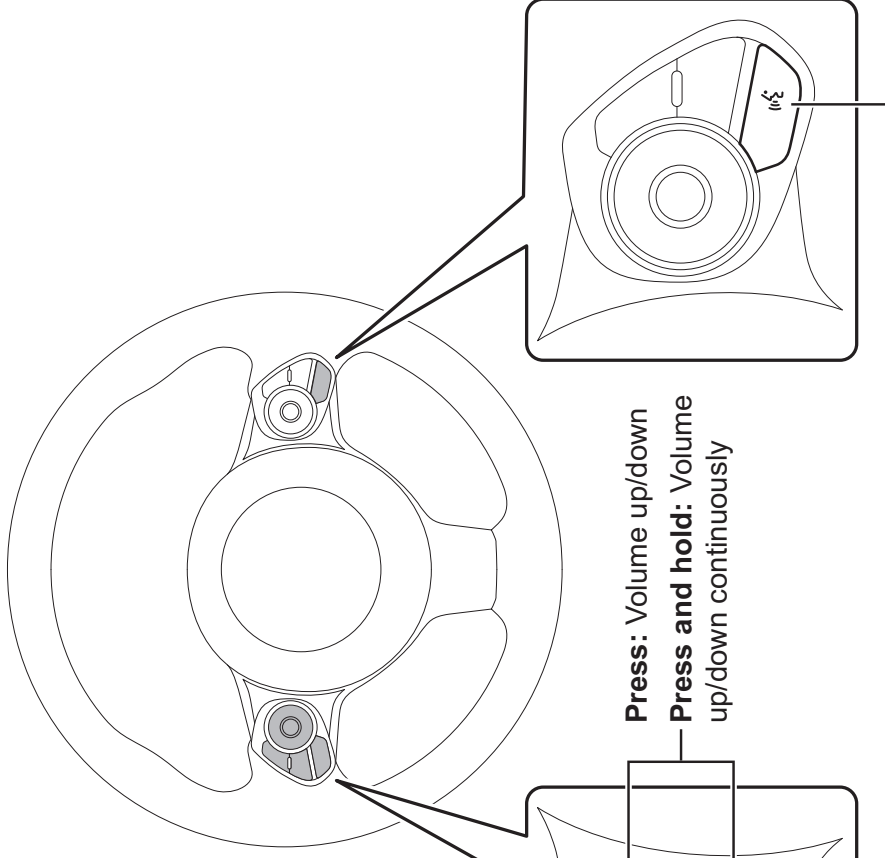

Change audio modes

Press the phone button to receive/end a call without taking your hands off the steering wheel. [P.78](#)

**Press:** Volume up/down  
**Press and hold:** Volume up/down continuously

**Press the switch** to start the voice recognition system / Siri [P.195](#) [P.192](#)



## BASIC INFORMATION BEFORE OPERATION

## INITIAL SCREEN

## INITIAL SCREEN

**⚠ WARNING**

- When the vehicle is stopped with the engine running, always apply the parking brake for safety.

1. When the ignition switch is in the “ACC” or “ON” position, the initial screen will be displayed and the system will begin operating.



- After a few seconds, the “CAUTION (CAUTION)” screen will be displayed.

2. Select **I Agree** (I Agree).

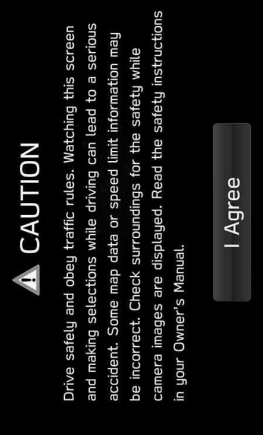

## CONNECTING AND DISCONNECTING A USB MEMORY DEVICE/PORTABLE DEVICE

### CONNECTING A DEVICE

1. Connect a device.

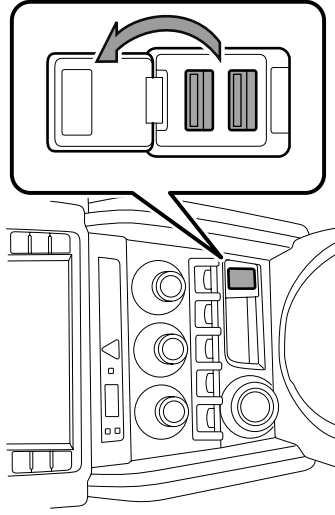

- Turn on the power of the device if it is not turned on.

#### NOTE

- Compatible USB memory device: →P.65
- Compatible iPod: →P.65
- This unit does not support commercially available USB hubs.
- By connecting a device such as a cellular phone, charging starts depending on the device.

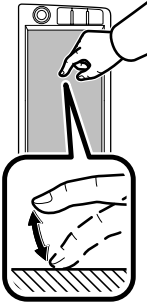
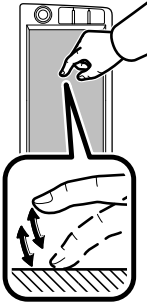
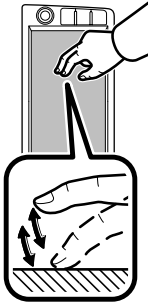

## TOUCH SCREEN GESTURES

Operations are performed by touching the touch screen directly with your finger.

Operation method	Outline	Main use
	<b>Touch</b> Quickly touch and release once.	Changing and selecting various settings
	<b>Double Touch with one finger</b> Quickly touch and release twice with one finger.	Enlarging the scale of the map screen
	<b>Double Touch with two fingers</b> Quickly touch and release twice with two fingers.	Reducing the scale of the map screen

**NOTE**

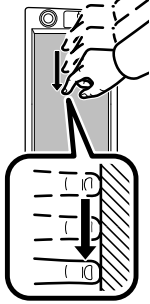
- Swipe operations may not be performed smoothly in high altitudes.

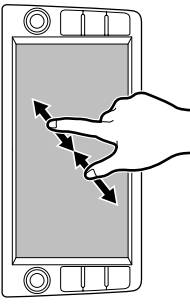
Operation method	Outline	Main use
	<p><b>Drag*</b> Touch the screen with your finger, and move the screen to the desired position.</p>	<ul style="list-style-type: none"> <li>• Scrolling the lists</li> <li>• Scrolling the map screen</li> </ul>
	<p><b>Swipe*</b> Quickly move the screen by swiping with your finger.</p>	<ul style="list-style-type: none"> <li>• Scrolling the lists</li> <li>• Scrolling the map screen</li> </ul>
	<p><b>Pinch</b> Move your two fingers further apart (pinch-out) to zoom in the map. Move your two fingers closer together (pinch-in) to zoom out the map.</p>	<p>Changing the scale of the map screen</p>

\*: The above operations may not be performed on all screens.

## TOUCH SCREEN OPERATION

This system is operated mainly by the buttons on the screen. (Referred to as screen buttons in this manual.)

- When a screen button is touched, a beep sounds. The beep sound can be turned on/off. (→P.71)

### CAUTION

- To prevent damaging the screen, lightly touch the screen buttons with your finger.
- Do not use objects other than your finger to touch the screen.
- Wipe off fingerprints using a glass cleaning cloth. Do not use chemical cleaners to clean the screen, as they may damage the touch screen.

### NOTE

- If the system does not respond to touching a screen button, move your finger away from the screen and then touch it again.
- Dimmed screen buttons cannot be operated.
- The displayed image may become darker and moving images may be slightly distorted when the screen is cold.
- In extremely cold conditions, the map may not be displayed and the data input by a user may be deleted. Also, the screen buttons may be harder than usual to depress.

### NOTE

- When  is displayed on the screen, select  to close a pop-up screen.

## ENTERING LETTERS AND NUMBERS/LIST SCREEN OPERATION

### ENTERING LETTERS AND NUMBERS

When searching by an address, name, etc., or entering data, letters and numbers can be entered via the screen.

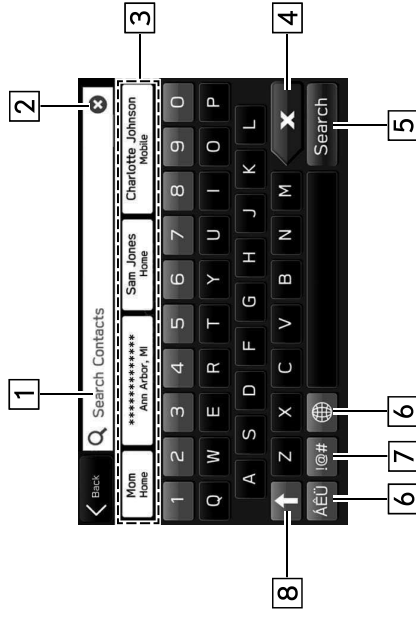

No.	Information/Function
1	Input field <ul style="list-style-type: none"> <li>The input field contains text to assist the user in completing tasks.</li> <li>The position of the cursor can be moved by selecting the desired location in the input field.</li> </ul>
2	Select to clear the input field.
3	Displays candidate items based on the input letters. The desired item can be selected.
4	Select to erase one character.
5	Select to enter the item.
6	Select to change keyboard types.
7	Select to enter symbols.
8	Select to enter characters in lower case or in upper case.

#### NOTE

- The appearance of the keyboard may change or the input method may be limited depending on the circumstances where the software keyboard is displayed.



BASIC INFORMATION BEFORE OPERATION

**LIST SCREEN OPERATION**

The list screen can be scrolled by a swipe gesture.

For details on the operation: →P. 32

The list screen can also be scrolled by the “**TUNE/SCROLL**” knob and pressing the knob will enter it.

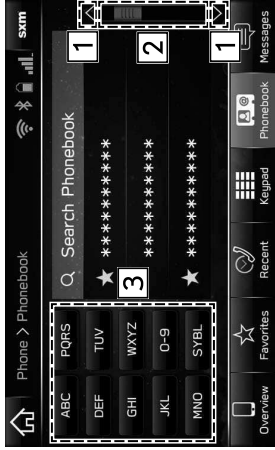

No.	Information/Function
1	Select to skip to the next or previous page.
2	This indicates the displayed screen's position. Faster scrolling is possible by dragging the position indicator.

No.	Information/Function
3	Some lists contain character screen buttons which allow users to jump directly to list entries that begin with the same letter as the character screen button. Every time the same character screen button is selected, the list starting with the subsequent character is displayed.

## SCREEN ADJUSTMENT

### ADJUSTING BRIGHTNESS

The brightness of the screen can be adjusted. (→P.62)

### CHANGING BETWEEN DAY AND NIGHT MODE

Depending on the ambient brightness and/or position of the headlight switch, the screen changes to day or night mode.

## STATUS DISPLAY

The status of the Bluetooth connection, etc. is displayed on the screen.

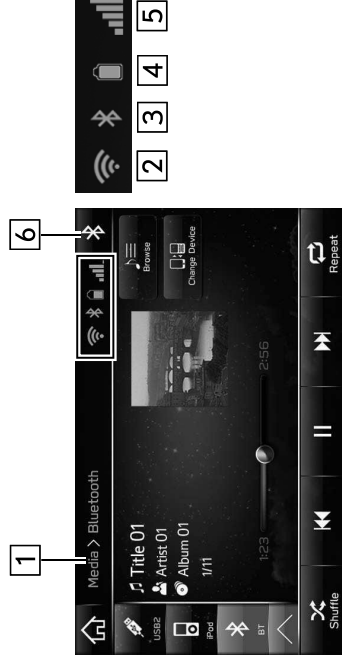

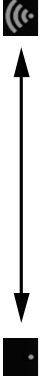
No.	Name	Conditions
1	Screen hierarchy	Displays the screen context.
2	The level of Wi-Fi® reception	 <p>When Wi-Fi® function is off, no item is displayed.</p>

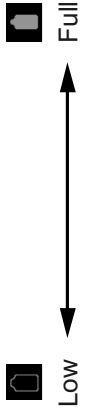
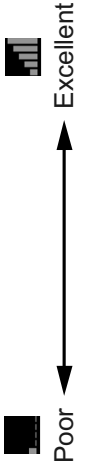
No.	Name	Conditions
3	The Bluetooth connection indicator	This icon is displayed when the Bluetooth connection is established.
4	Remaining battery charge	 <p>The amount displayed does not always correspond with the amount displayed on the Bluetooth device.</p>
5	Reception level	 <p>The level of reception does not always correspond with the level displayed on the cellular phone. The level of reception may not be displayed depending on the phone you have.</p>
6	Active audio source	Select to display the active audio source information, radio frequency, and name of the artist and track currently playing, etc.

## HOME SCREEN OPERATION

### ADDING SHORTCUT ICONS TO THE HOME SCREEN

Shortcut icons for various functions can be added to the home screen when the home screen shortcut function is turned on. (→P.62)

1. Press .
2. Select **Add Shortcut** (Add Shortcut).



3. Select the desired function.

