

» MAIN FUNCTIONS

Function	Page
Pairing (Bluetooth 3.0)	22
Navigation system	24
Apps	28
Apple CarPlay	109
Android Auto	111
AM/FM radio	26
HD Radio receiver	124
SiriusXM® satellite radio	128
Media operation	CD:137 USB:139 iPod:141 Bluetooth audio:144 AUX:147
Phone	22
Voice recognition system	195
NFC	56
Steering wheel controls	32
Rear view camera	44

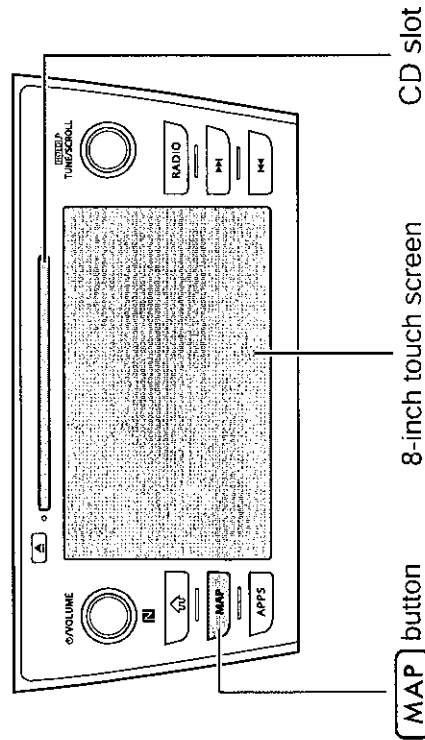
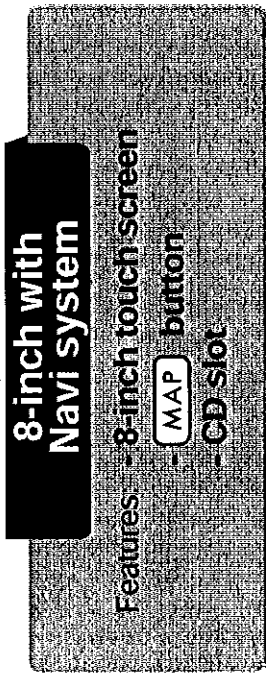

MAIN PRODUCT FEATURES

MAIN PRODUCT FEATURES

Adoption of intuitive and easy-to-use smartphone-like graphical user interface

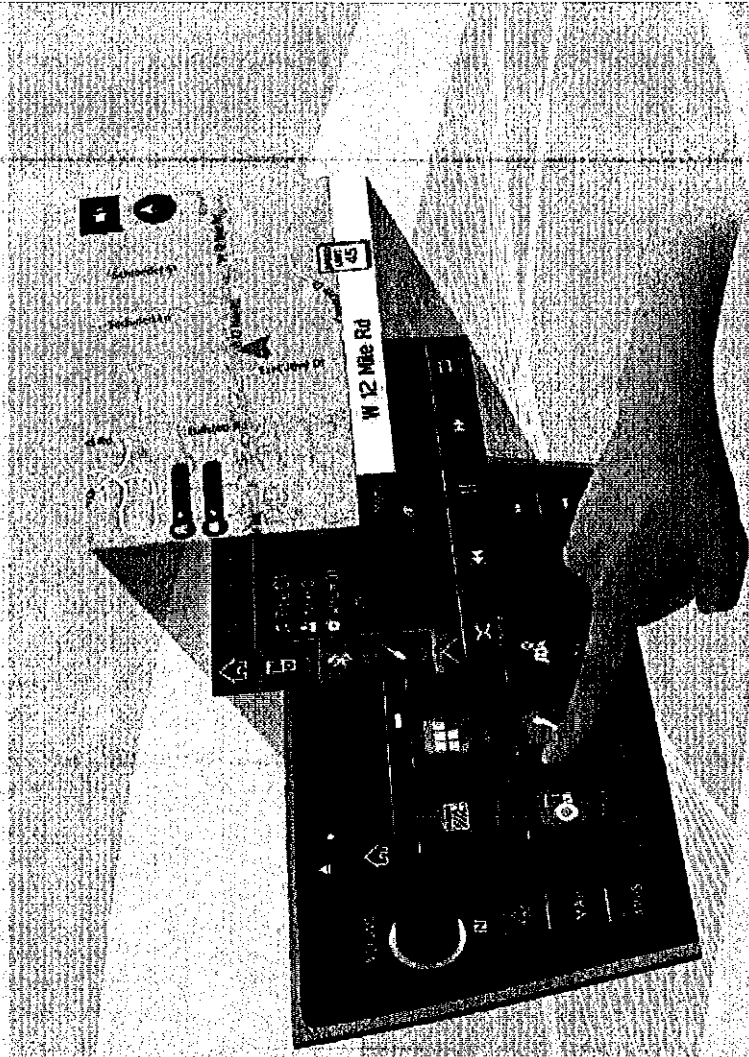

STANDARDIZED OPERATION SCREEN LAYOUT FOR ALL FUNCTIONS

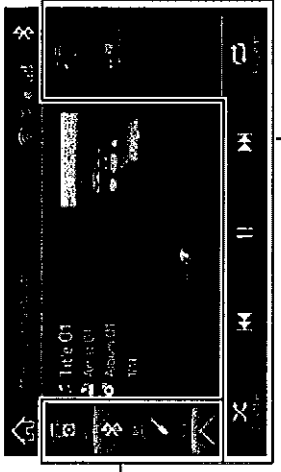

Mode switching buttons, etc. Operation buttons, etc.

Mode switching buttons on the left and operation buttons on the right and at the bottom prevents users becoming lost in operation no matter which functions are used.

USE OF POP-UP SCREENS

Close pop-up screen to return to original screen

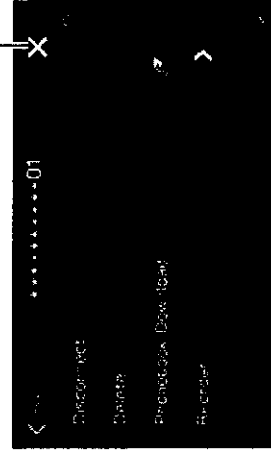

Pop-up screens are used instead of screen switching, preventing users from losing the current screen.

Easy-to-view map screen display* (P.161)

Maps appear wider by minimizing constantly displayed buttons.

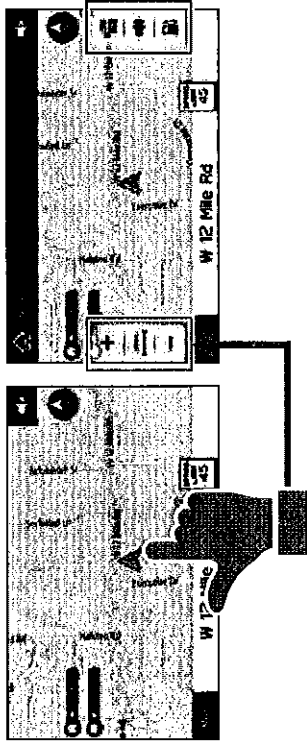

Touch screen to display automatically hidden buttons.

Rough destination search function* (P.177)

Start a search with a variety of words such as addresses, facility names, intersection names.

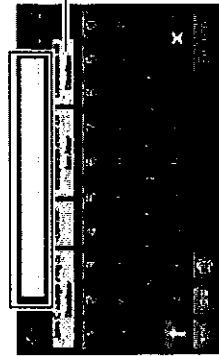

Displays search prediction

- Search results are predicted and candidates displayed even if only partial words are known
- Searches can even be performed with multiple keywords.

*: 8-inch with Navi system only

Customized home screen layout (P.42)

Frequently used functions and operations can be added to the home screen.

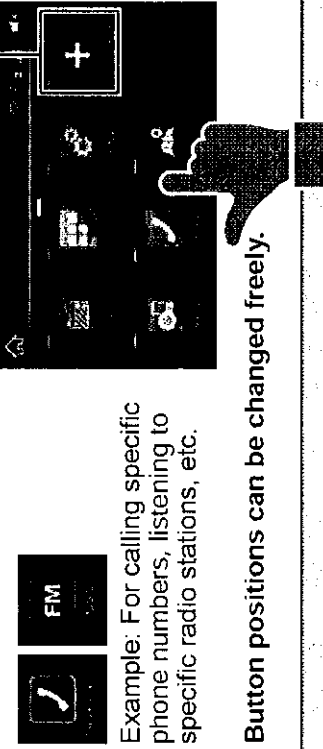

Example: For calling specific phone numbers, listening to specific radio stations, etc.

Button positions can be changed freely.

System and Bluetooth phone / device pairing (P.22)

Functions such as hands-free and applications can be used by connecting the system with Bluetooth phones / devices wirelessly.



Apple CarPlay / Android Auto

Support for Apple CarPlay and Android Auto allows access to functions such as maps, phone calls, and music.

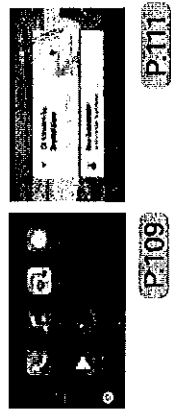

BASIC FUNCTION

BASIC FUNCTION

OVERVIEW BUTTONS

TOUCH SCREEN
Operations are performed by touching the touch screen directly with your finger. P.36

Drag Pinch

Insert a disc into this slot. The CD player turns on immediately.*1 P.35

Press to eject a disc.*1 P.35

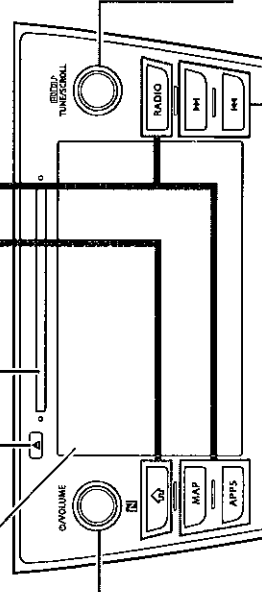

- Turn the knob to adjust the volume.
- Press the knob to turn the volume mute on/off.
- Press and hold to turn the audio system on/off.

Press button to seek up or down for a radio station or to access a desired track/file.
 Press and hold button to continuously seek for a radio station, or to fast forward/rewind files or tracks.

- Radio P.122, P.128
- CD*1 P.137
- USB P.139 iPod P.141
- Bluetooth audio P.144

Displays the home screen

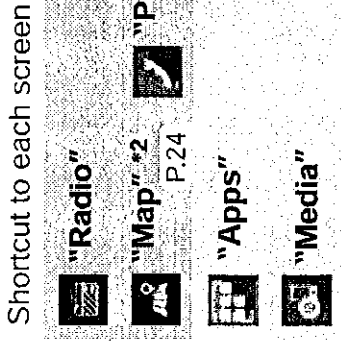

Audio operation screen:

- Turn the knob to select a radio station or skip to the next or previous track/file.
- Press and hold the knob to display the sound settings screen. P.71
- List display screen:
 - Turn the knob to move the cursor.
 - Press the knob to select the item selected with the cursor.

*1: 8-inch with Navi system/8-inch system only
 *2: 8-inch with Navi system only
 *3: 8-inch system/6.5-inch system only

HOME SCREEN

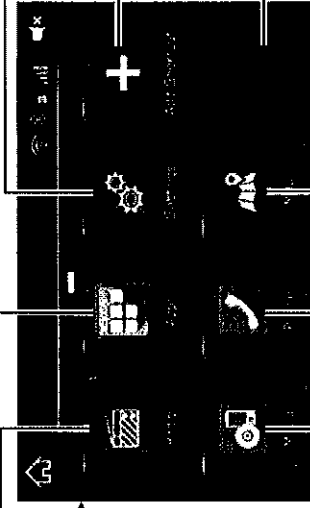
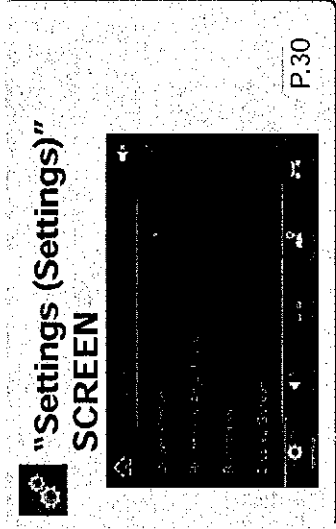
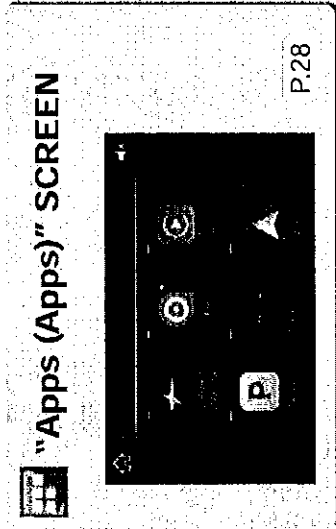

Frequently used functions and operations can be added to the home screen. **P.42**
 Button positions can be changed freely. **P.43**

By connecting an iPhone or Android device to the USB port, a CarPlay or Android Auto icon will display.

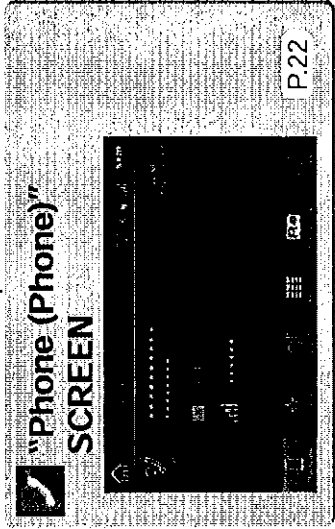
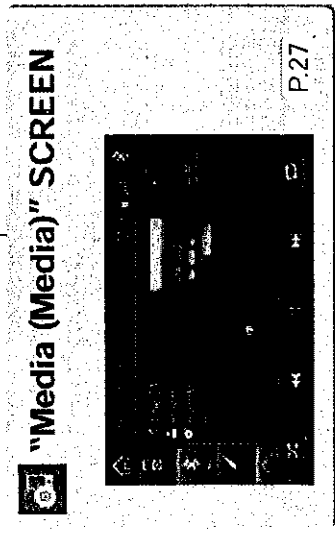

"Phone (Phone)" SCREEN

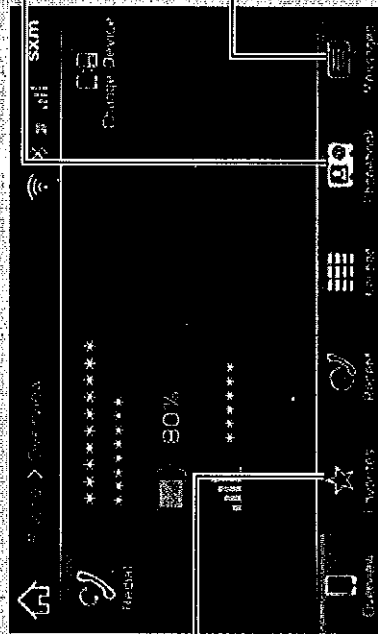

Call or send a text message to a contact in the phonebook on the Bluetooth-connected phone P.83,90

Check or reply to messages/place calls from received message list P.89,91

Directly input a number to place a call P.83

Call or send a text message to a registered favorite P.82,90

Call or send a text message to a recent contact P.82,90

Operation Flow: Pairing the System with a Bluetooth Phone/Device

» Display the "Phone (Phone)" screen.

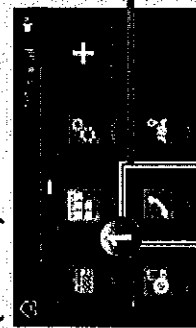

Prepare the Bluetooth phone/device to be paired.

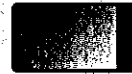

» Operate the Bluetooth phone/device.

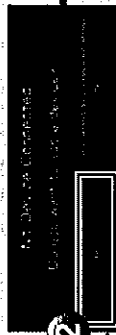

Turn the Bluetooth phone/device Bluetooth function ON and select "Subaru BT". Hold NFC* compatible devices near the audio system.

*: 8-inch with Navi system/8-inch system only

» Register the Bluetooth phone/device.

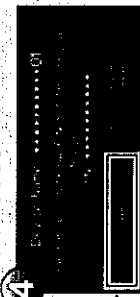

If unable to pair, check whether your Bluetooth phone/device is compatible with the system.

- Operation Flow: Placing Calls/Sending Messages from the Phonebook -

» Select call recipient from phonebook.

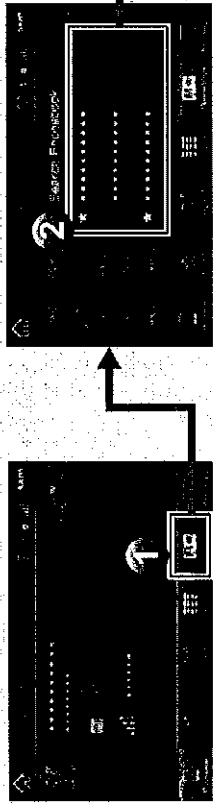

If unable to select the button, the setting for downloading the phonebook for the Bluetooth phone may be OFF. P.60

» Select number for making call/sending message.

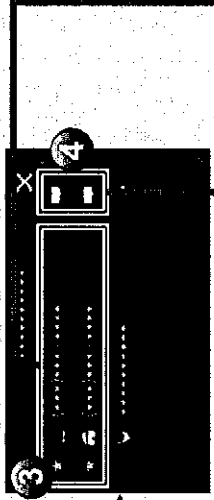

Send message

Place call

» Select message.

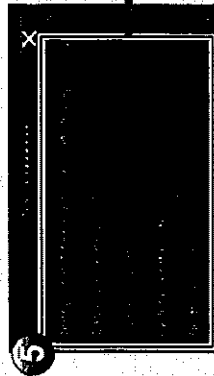

» Send message.

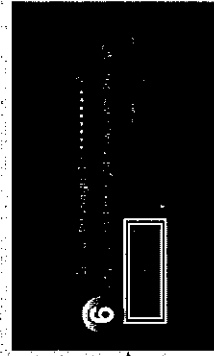

» In-call screen is displayed.



End call

Mute the connected smartphone's voice

Hold call

Transfer call to Bluetooth phone

Switch to call with other party

Start three-way call

In-call screen display and operation may differ, or may not be possible depending on the Bluetooth phone used.

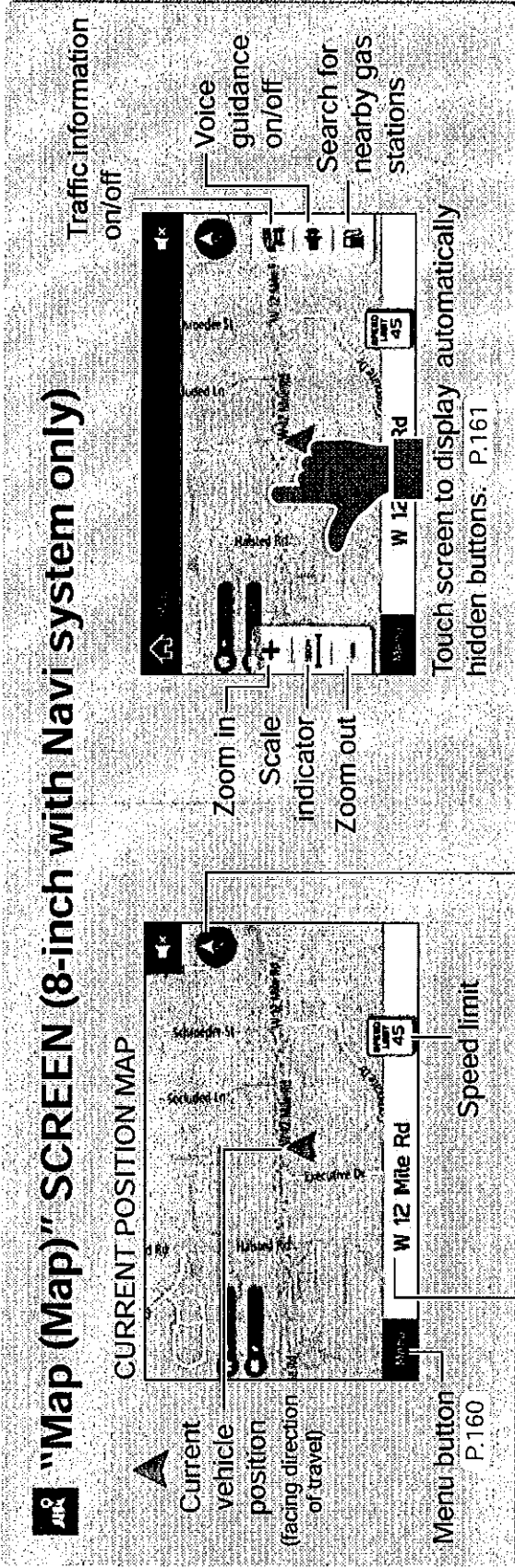

Current street
 Touch the current street name to display details of the current location, allowing that location to be registered.



The orientation of the map can be changed between 2D north-up, 2D heading-up and 3D.



2D North-up screen
 2D Heading-up screen
 3D screen

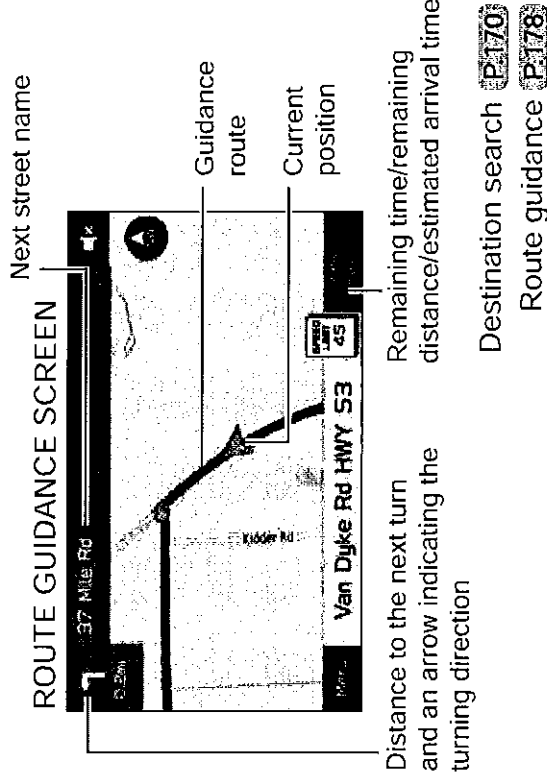

- Operation Flow: Route Guidance -

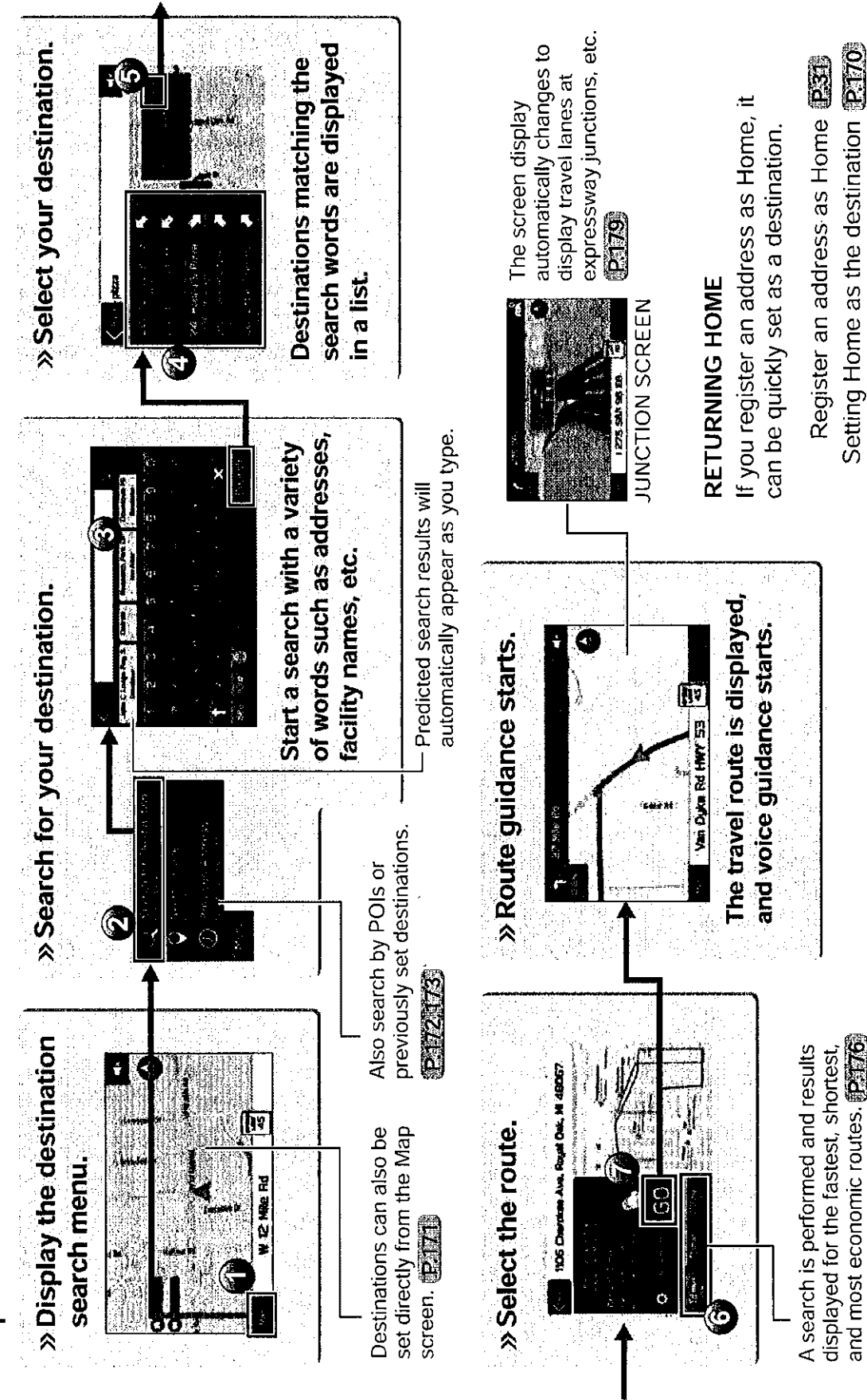

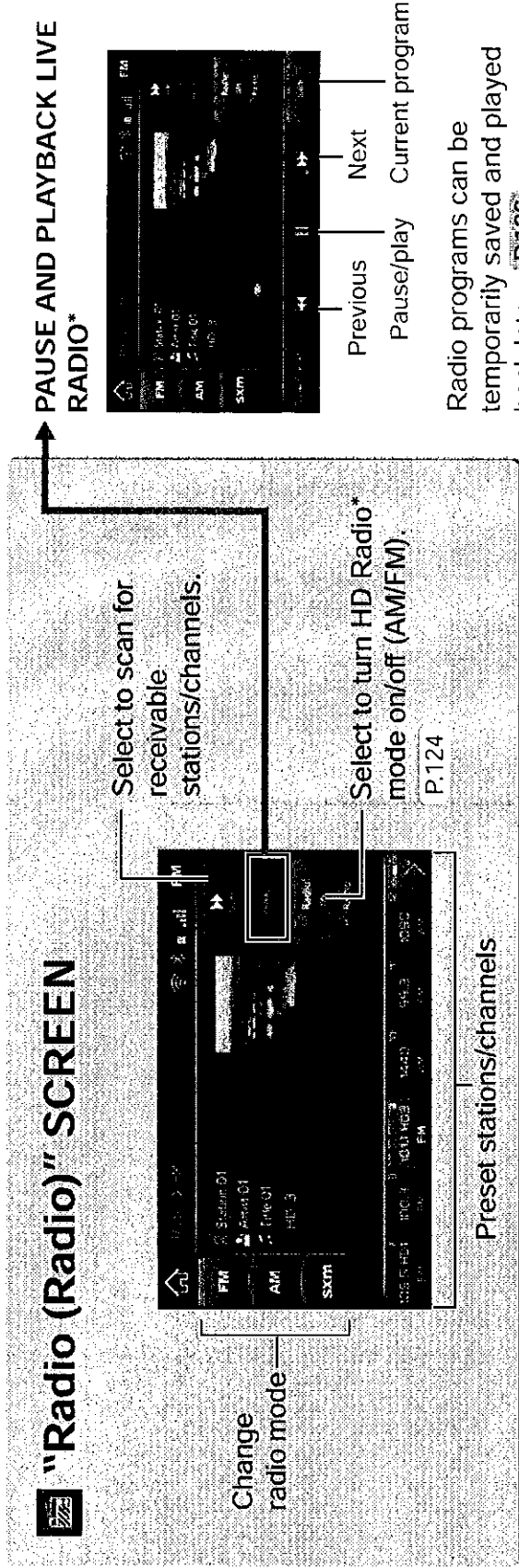

Previous
Pause/play
Next
Current program

Radio programs can be temporarily saved and played back later. P.126

- Operation Flow: Presetting a Radio Station -

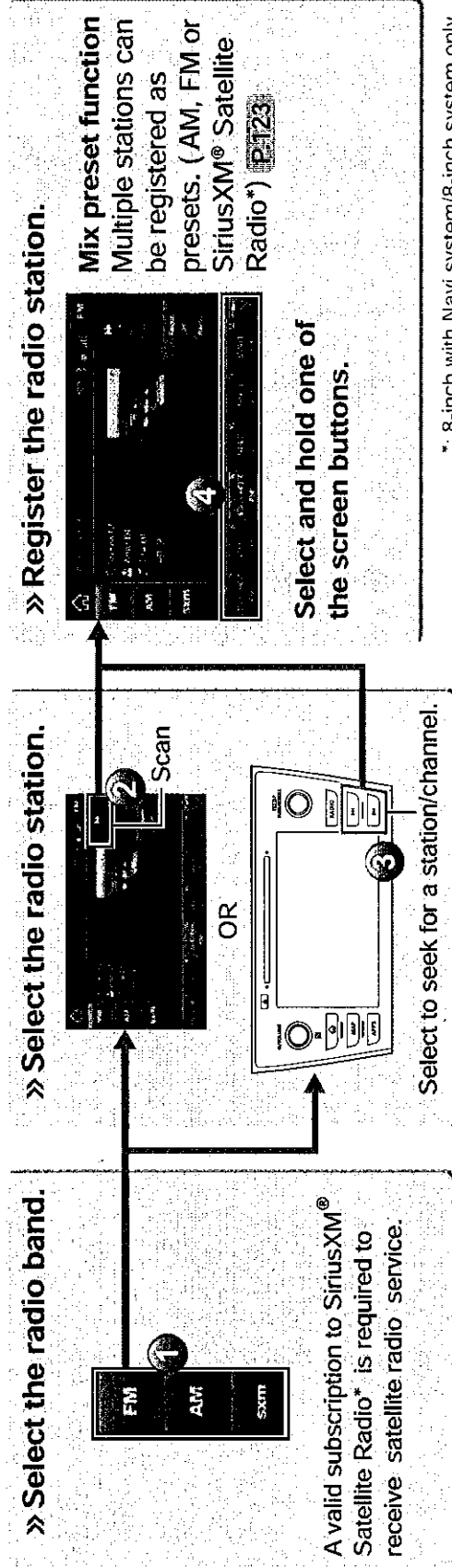

A valid subscription to SiriusXM® Satellite Radio* is required to receive satellite radio service.

*: 8-inch with Navi system/8-inch system only

"Media (Media)" SCREEN

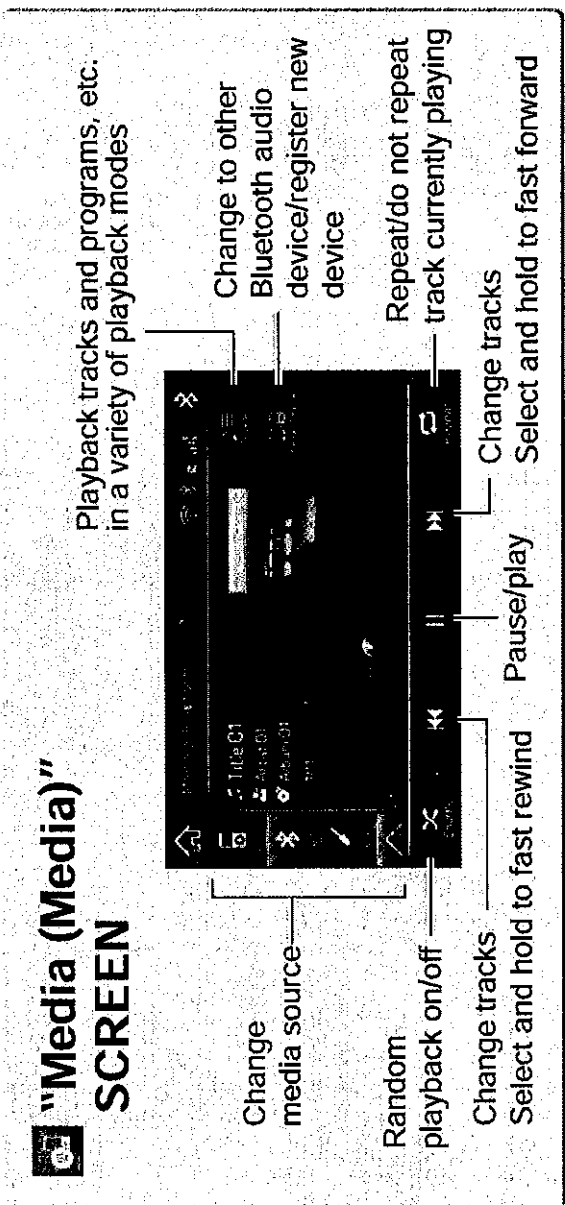

SUPPORTED MEDIA

- CD* P.153
- USB/iPod P.156
- Bluetooth audio P.53

- Operation Flow: Using Playback Modes -

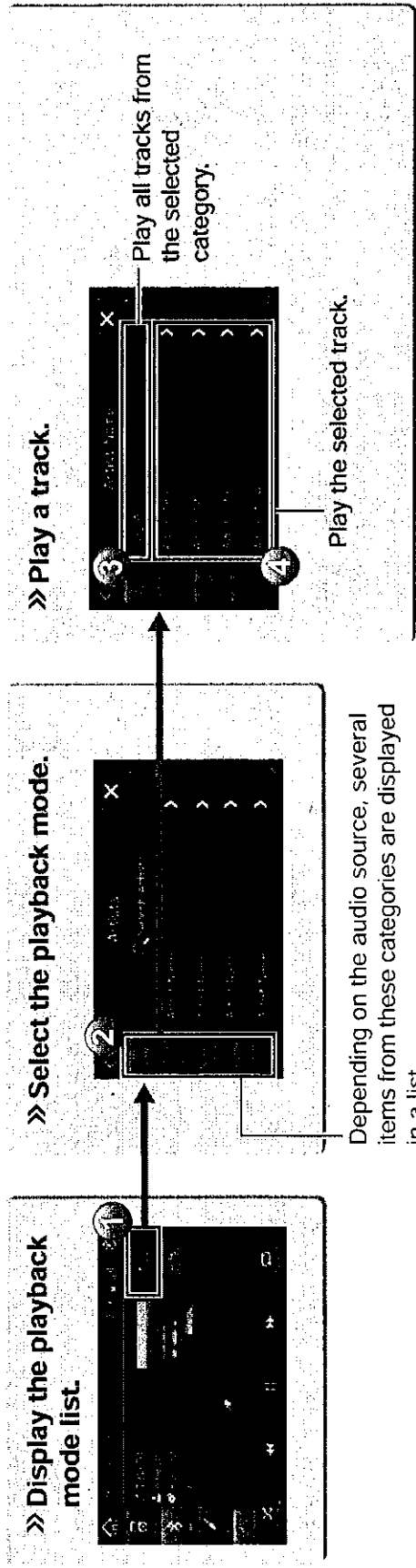

*: 8-inch with Navi system/8-inch system only



"Apps (Apps)" SCREEN

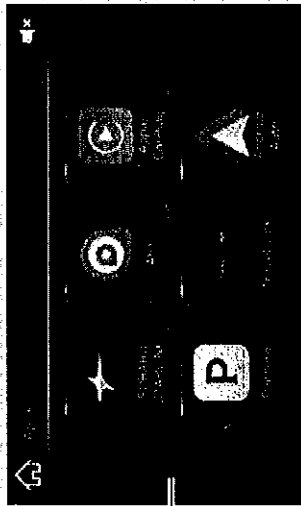

List of usable applications

ABOUT USING APPLICATIONS

In order to use an application on this system, the corresponding application must be installed on your smartphone. [P94](#)

Apple CarPlay does not require an application to be installed.



Pandora*1

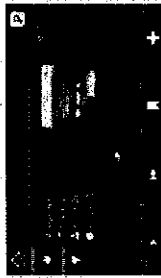

Pandora is free personalized radio that offers effortless and endless music enjoyment and discovery. [P106](#)

*1: Pandora is only available in certain countries. Please visit pandora.com/legal for more information.



aha™



aha™ is a cloud-based application that connects to the system and gives you access to your favorite web content safely and easily. [P102](#)



SUBARU STARLINK*2

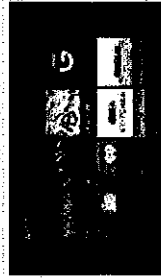

The SUBARU STARLINK function allows the system to link with a smartphone. [P97](#)

*2: 8-inch with Navi system/8-inch system only

Apple CarPlay

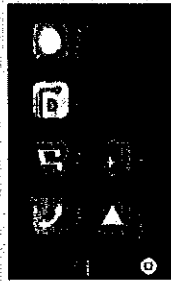

CarPlay can be used to view iPhone maps, play music, and place calls by connecting your iPhone to the system. Supported applications can also be run. **P.109**

Android Auto

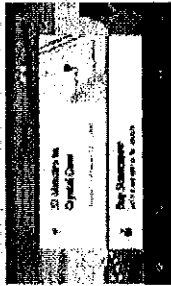

Android Auto can be used to view Android maps, play music, and place calls by connecting your Android device to the system. Supported applications can also be run. **P.111**

SiriusXM Travel Link*

SiriusXM Travel Link is a service provided by SiriusXM® Satellite Radio, and can be used to view information on fuel information, sports, stocks, and weather.



Fuel information



Sports

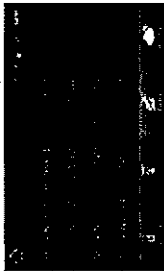

Stocks



Weather

8-inch with Navi system: Weather information can be viewed by linking with the navigation function.

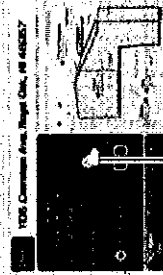

Weather information

Current weather information for your destination can be viewed at the route calculation screen. **P.176**

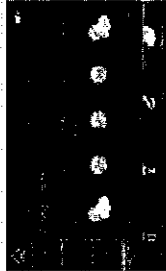

Weather information broadcast by weather stations en route to your destination can be viewed during route guidance. **P.184**

SiriusXM Travel Link subscription is required.

*: 8-inch with Navi system/8-inch system only

Settings (Settings) SCREEN

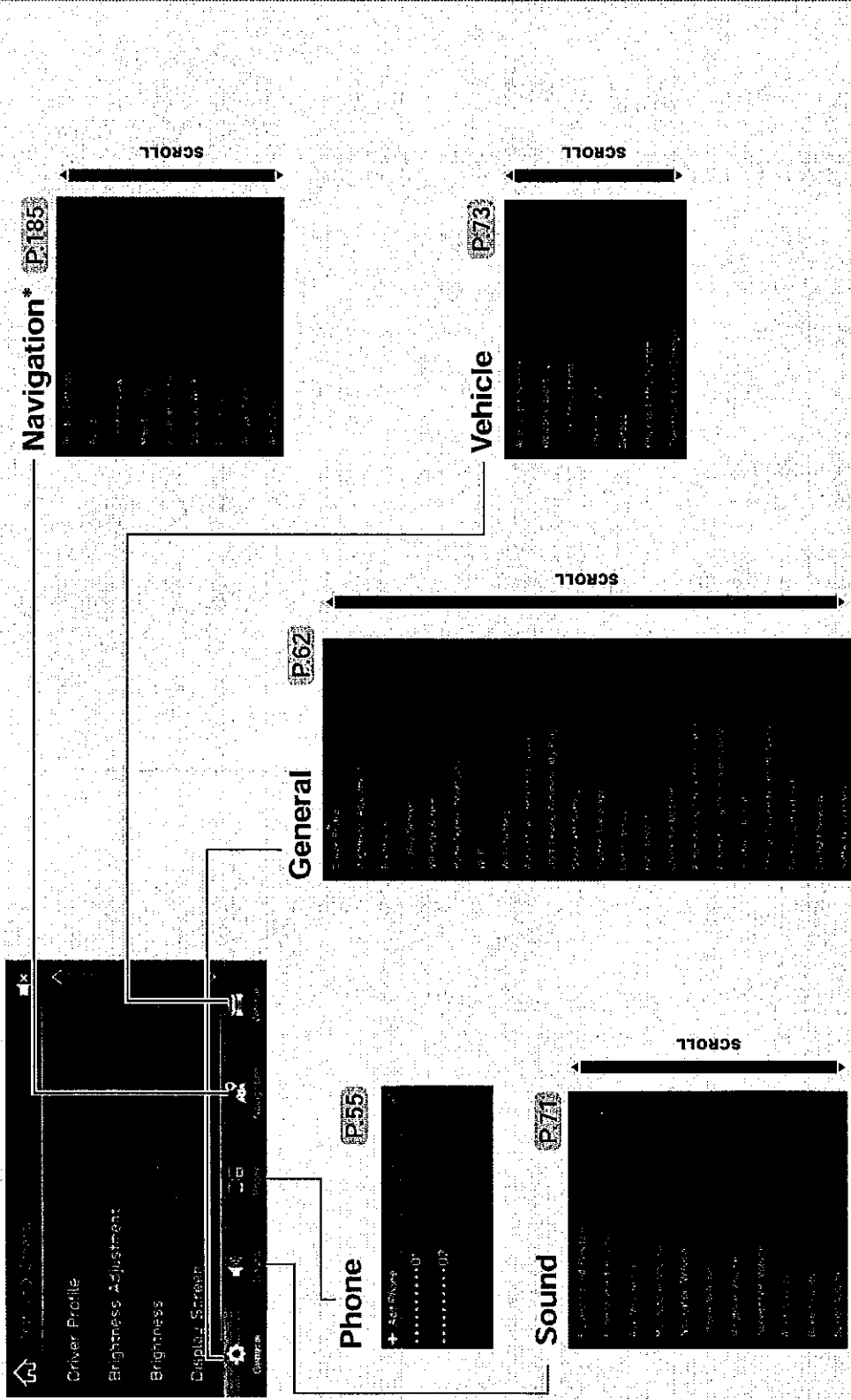

*: 8-inch with Navi system only

- Operation Flow: Create a driver profile -

CREATE A DRIVER PROFILE

Create a driver profile and register your cellular phone, address, etc. You can store and call registered information at any time.

» Add a new profile.

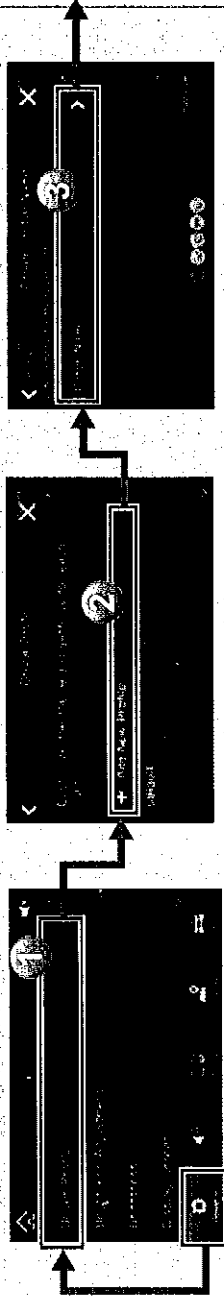

4 Enter a name.

» Registering a Bluetooth phone

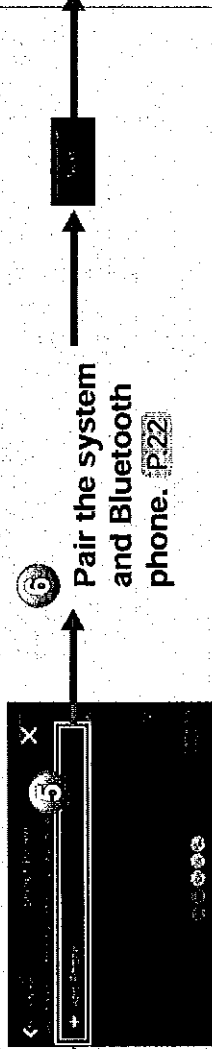

» Register your home/office.*

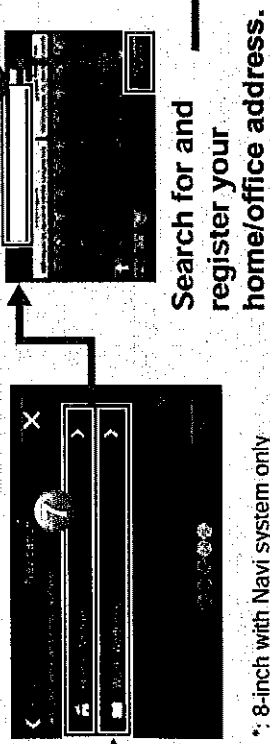

*: 8-inch with Navi system only

STEERING WHEEL CONTROLS

STEERING WHEEL CONTROLS

STEERING WHEEL CONTROLS

Some parts of the audio system can be controlled using the steering wheel controls.

P149

RADIO

Press: Preset channel up/down

Press and hold: Seek up/down continuously

MEDIA

Press: Select a track/file

Press and hold: Fast forward/rewind

Press: Volume up/down

Press and hold: Volume up/down continuously

Change audio modes

Press the switch to start the voice recognition system / Siri **P195** **P192**

Press the phone button to receive/end a call without taking your hands off the steering wheel. **P78**

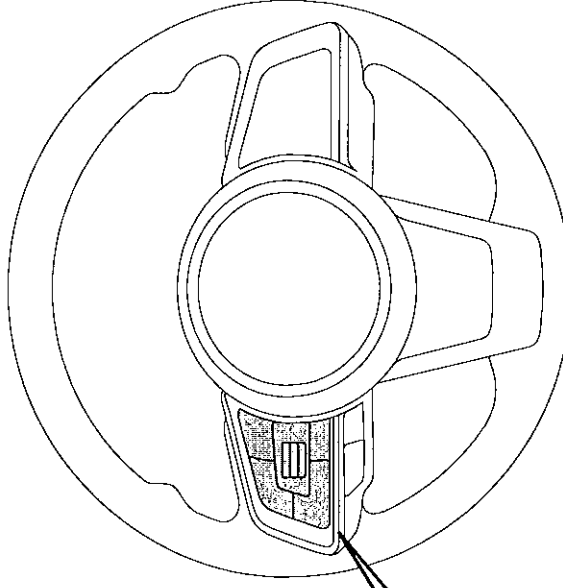

Operate the combination meter display.
See vehicle Owner's Manual.

BASIC INFORMATION BEFORE OPERATION

INITIAL SCREEN

INITIAL SCREEN

! WARNING

- When the vehicle is stopped with the engine running, always apply the parking brake for safety.

1. When the ignition switch is in the "ACC" or "ON" position, the initial screen will be displayed and the system will begin operating.

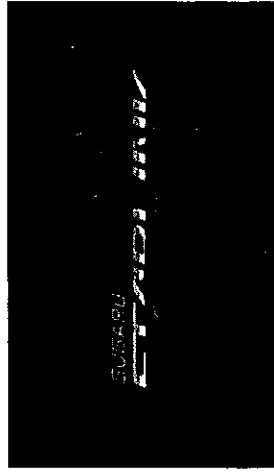

- After a few seconds, the "CAUTION (CAUTION)" screen will be displayed.

2. Select **I Agree (I Agree)**.

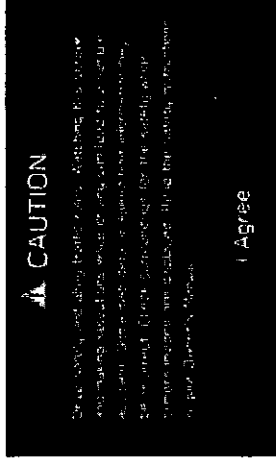

LOADING AND UNLOADING A DISC (8-inch with Navi system/8-inch system only)

LOADING A DISC



● Never try to disassemble or oil any part of the CD player. Do not insert anything other than a disc into the slot.

1. Insert a disc into the disc slot.

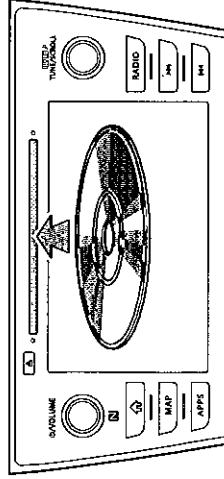

- After insertion, the disc is automatically loaded.

NOTE

- Compatible Disc: →P.153
- When inserting a disc, gently insert the disc with the label facing up.

UNLOADING A DISC

1. Press  and remove the disc.

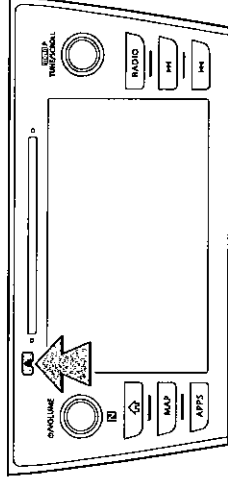

NOTE

- Discs can be unloaded even when the ignition switch is turned off.

CONNECTING AND DISCONNECTING A USB MEMORY DEVICE/PORTABLE DEVICE

CONNECTING A DEVICE

1. Connect a device.

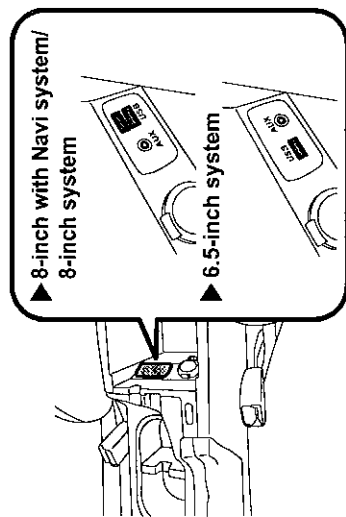



- Turn on the power of the device if it is not turned on.

NOTE

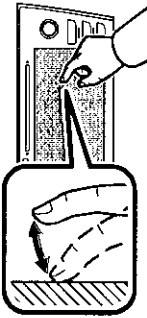
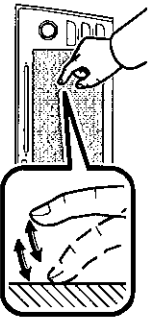

- Compatible USB memory device: →P.156
- Compatible iPod: →P.156
- This unit does not support commercially available USB hubs.
- By connecting a device such as a cellular phone, charging starts depending on the device.

TOUCH SCREEN GESTURES

Operations are performed by touching the touch screen directly with your finger.

	Touch Quickly touch and release once.	Changing and selecting various settings
	Double Touch with one finger**1 Quickly touch and release twice with one finger.	Enlarging the scale of the map screen
	Double Touch with two fingers**1 Quickly touch and release twice with two fingers.	Reducing the scale of the map screen

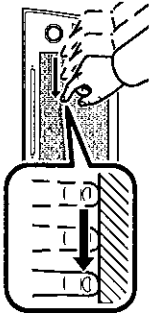
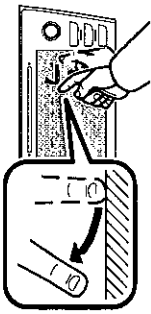
BASIC INFORMATION BEFORE OPERATION

	<p>Drag^{*2} Touch the screen with your finger, and move the screen to the desired position.</p>	<ul style="list-style-type: none"> • Scrolling the lists • Scrolling the map screen^{*1}
	<p>Swipe^{*2} Quickly move the screen by swiping with your finger.</p>	<ul style="list-style-type: none"> • Scrolling the lists • Scrolling the map screen^{*1}
	<p>Pinch^{*1} Move your two fingers further apart (pinch-out) to zoom in the map. Move your two fingers closer together (pinch-in) to zoom out the map.</p>	<p>Changing the scale of the map screen</p>

NOTE

- Swipe operations may not be performed smoothly in high altitudes.

*1: 8-inch with Navi system only

*2: The above operations may not be performed on all screens.

TOUCH SCREEN OPERATION

This system is operated mainly by the buttons on the screen. (Referred to as screen buttons in this manual.)

- When a screen button is touched, a beep sounds. The beep sound can be turned on/off. (→P.71)

CAUTION

- To prevent damaging the screen, lightly touch the screen buttons with your finger.
- Do not use objects other than your finger to touch the screen.
- Wipe off fingerprints using a glass cleaning cloth. Do not use chemical cleaners to clean the screen, as they may damage the touch screen.

NOTE

- If the system does not respond to touching a screen button, move your finger away from the screen and then touch it again.
- Dimmed screen buttons cannot be operated.
- The displayed image may become darker and moving images may be slightly distorted when the screen is cold.
- In extremely cold conditions, the map may not be displayed and the data input by a user may be deleted. Also, the screen buttons may be harder than usual to depress.

NOTE

- When **X** is displayed on the screen, select **X** to close a pop-up screen.