

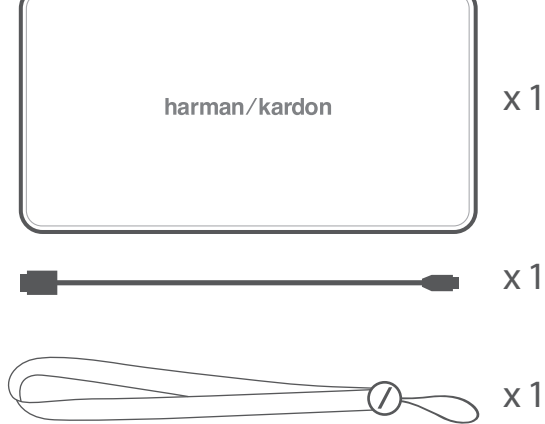

# ESQUIRE MINI

What's in the box

Quick Start Guide  
Guide de démarrage rapide



Buttons



Connections

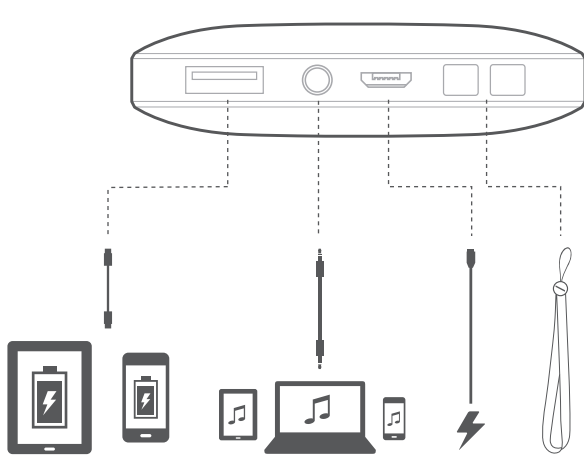

Bluetooth®

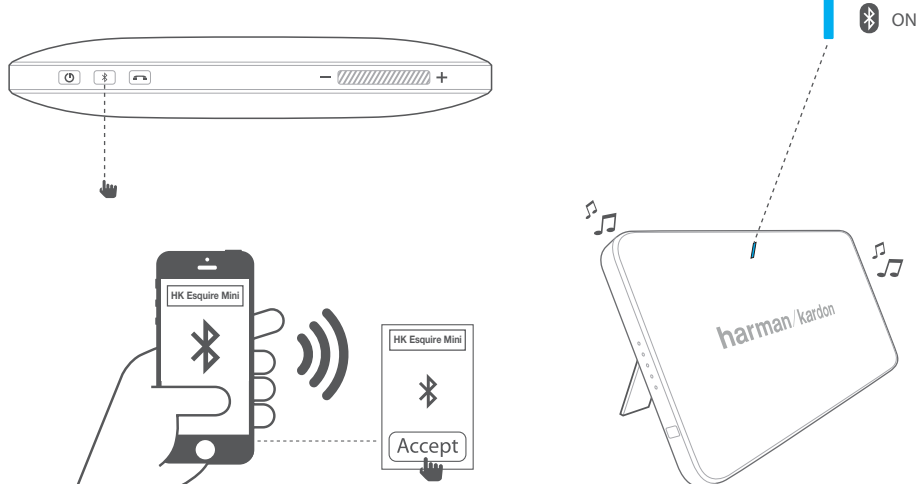

Stand

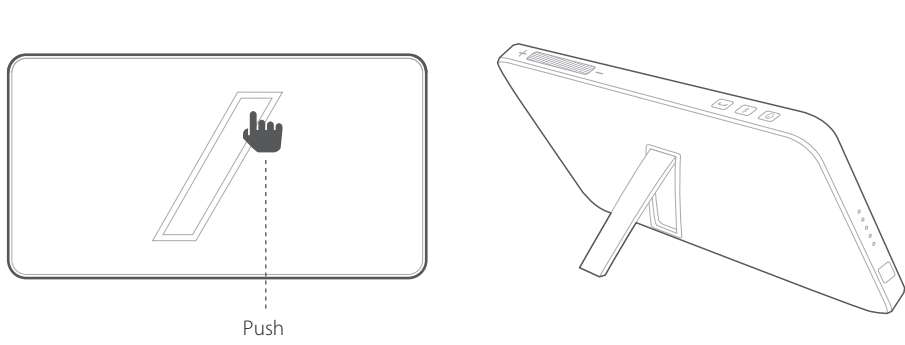

Hands-free

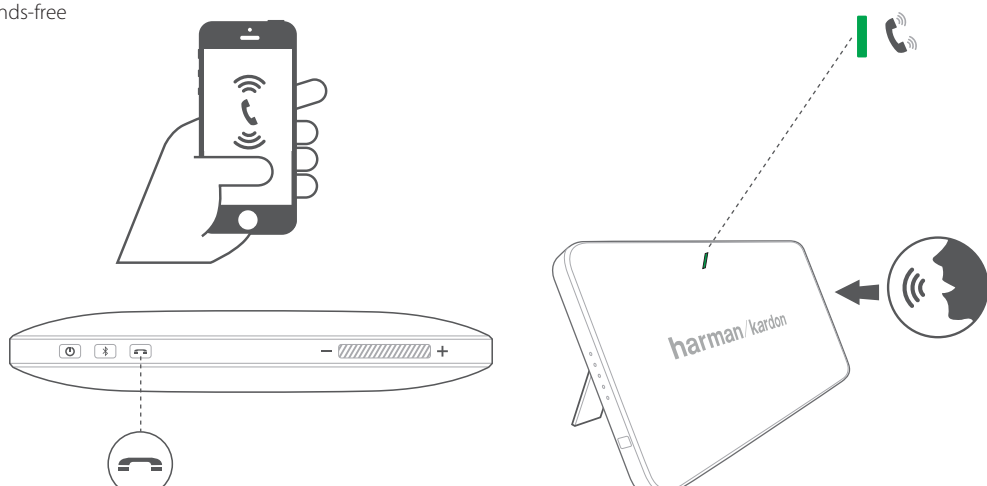

Mute

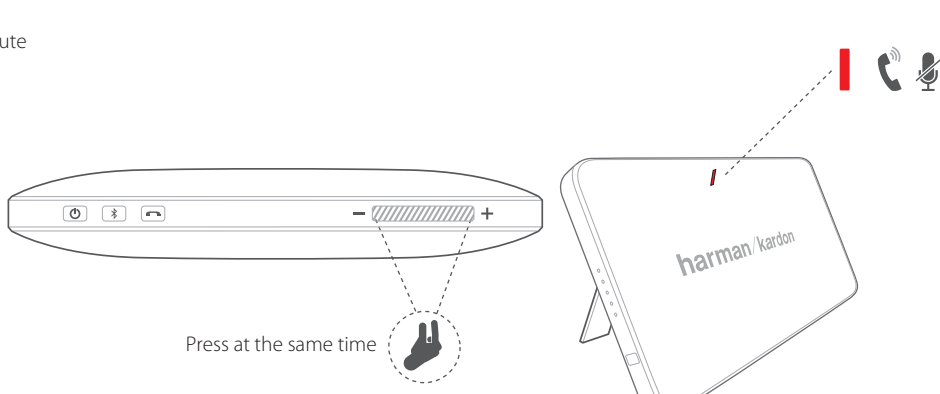

Press at the same time  
Press at the same time  
Press at the same time  
Press at the same time

Press at the same time  
Press at the same time  
Press at the same time  
Press at the same time

Press at the same time  
Press at the same time  
Press at the same time  
Press at the same time

Press at the same time  
Press at the same time  
Press at the same time  
Press at the same time

Charging

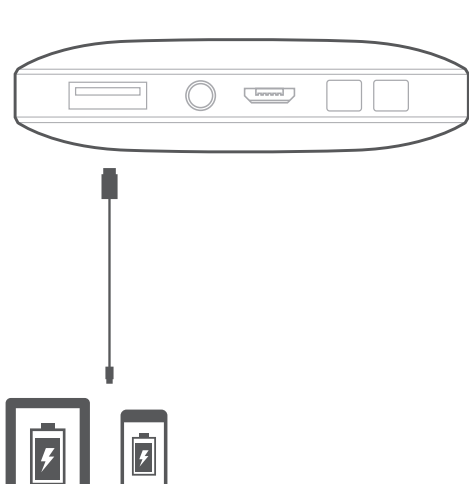

Battery charging indication

