

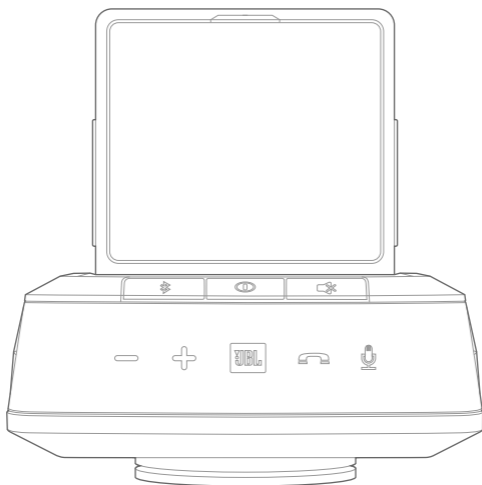

SMARTBASE



SMARTBASE

Quick Start Guide

Guide de démarrage rapide

1 What's in the box



x 1



x 1

2 Buttons

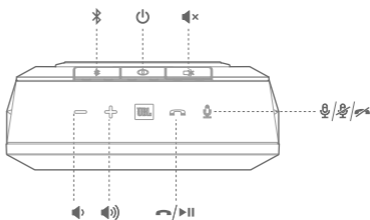

3 Connections

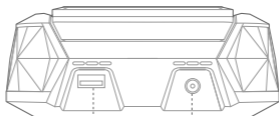

For wired version only

SMARTBASE

Quick Start Guide

Guide de démarrage rapide

4 Bluetooth

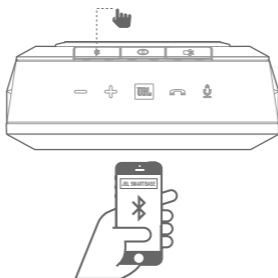

5 Hands-free

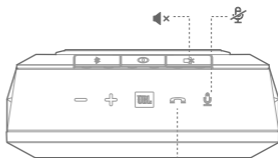

Short press to receive or end the call
Press and hold to ignore incoming call



Support user defined voice command.
Download Apps JBL Smartbase to define the voice command

SMARTBASE

Quick Start Guide

Guide de démarrage rapide

6 Siri function on iPhone

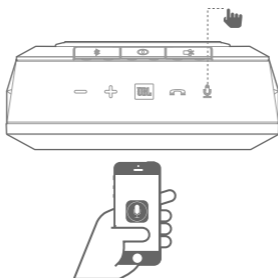

7 Installation

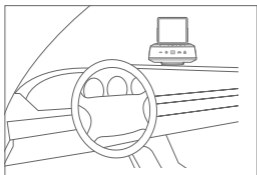
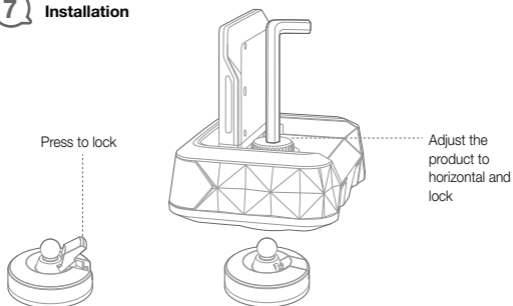

SMARTBASE

Quick Start Guide

Guide de démarrage rapide

8 Charging Phone

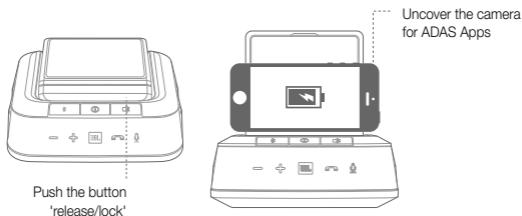

If buyers buy another wired variant, use USB for charge

9 LED indication

EN

Status	LED indication
Any BT device connected	On
BT pairing	Blinking
No BT device connected	Slow Blinking
Power on mode	On
Power off mode	No Light
Over voltage and under voltage	Blinking
Microphone is on	On
Microphone is muted	Blinking
Only for Wireless Charger version	
Wireless charge mode	On
Protect mode	Blinking
Idle mode	No Light

FR

Status	LED indication
Any BT device connected	On
BT pairing	Blinking
No BT device connected	Slow Blinking
Power on mode	On
Power off mode	No Light
Over voltage and under voltage	Blinking
Microphone is on	On
Microphone is muted	Blinking
Only for Wireless Charger version	
Wireless charge mode	On
Protect mode	Blinking
Idle mode	No Light

SMARTBASE

Quick Start Guide

Guide de démarrage rapide

ES

Status	LED indication
Any BT device connected	On
BT pairing	Blinking
No BT device connected	Slow Blinking
Power on mode	On
Power off mode	No Light
Over voltage and under voltage	Blinking
Microphone is on	On
Microphone is muted	Blinking
Only for Wireless Charger version	
Wireless charge mode	On
Protect mode	Blinking
Idle mode	No Light

DE

Status	LED indication
Any BT device connected	On
BT pairing	Blinking
No BT device connected	Slow Blinking
Power on mode	On
Power off mode	No Light
Over voltage and under voltage	Blinking
Microphone is on	On
Microphone is muted	Blinking
Only for Wireless Charger version	
Wireless charge mode	On
Protect mode	Blinking
Idle mode	No Light

NL

Status	LED indication
Any BT device connected	On
BT pairing	Blinking
No BT device connected	Slow Blinking
Power on mode	On
Power off mode	No Light
Over voltage and under voltage	Blinking
Microphone is on	On
Microphone is muted	Blinking
Only for Wireless Charger version	
Wireless charge mode	On
Protect mode	Blinking
Idle mode	No Light

PT

Status	LED indication
Any BT device connected	On
BT pairing	Blinking
No BT device connected	Slow Blinking
Power on mode	On
Power off mode	No Light
Over voltage and under voltage	Blinking
Microphone is on	On
Microphone is muted	Blinking
Only for Wireless Charger version	
Wireless charge mode	On
Protect mode	Blinking
Idle mode	No Light

IT

Status	LED indication
Any BT device connected	On
BT pairing	Blinking
No BT device connected	Slow Blinking
Power on mode	On
Power off mode	No Light
Over voltage and under voltage	Blinking
Microphone is on	On
Microphone is muted	Blinking
Only for Wireless Charger version	
Wireless charge mode	On
Protect mode	Blinking
Idle mode	No Light

NO

Status	LED indication
Any BT device connected	On
BT pairing	Blinking
No BT device connected	Slow Blinking
Power on mode	On
Power off mode	No Light
Over voltage and under voltage	Blinking
Microphone is on	On
Microphone is muted	Blinking
Only for Wireless Charger version	
Wireless charge mode	On
Protect mode	Blinking
Idle mode	No Light

SMARTBASE

Quick Start Guide

Guide de démarrage rapide

FI

Status	LED indication
Any BT device connected	● On
BT pairing	● Blinking
No BT device connected	● Slow Blinking
Power on mode	● On
Power off mode	No Light
Over voltage and under voltage	● Blinking
Microphone is on	● On
Microphone is muted	● Blinking
Only for Wireless Charger version	
Wireless charge mode	● On
Protect mode	● Blinking
Idle mode	No Light

SV

Status	LED indication
Any BT device connected	● On
BT pairing	● Blinking
No BT device connected	● Slow Blinking
Power on mode	● On
Power off mode	No Light
Over voltage and under voltage	● Blinking
Microphone is on	● On
Microphone is muted	● Blinking
Only for Wireless Charger version	
Wireless charge mode	● On
Protect mode	● Blinking
Idle mode	No Light

JP

Status	LED indication
Any BT device connected	● On
BT pairing	● Blinking
No BT device connected	● Slow Blinking
Power on mode	● On
Power off mode	No Light
Over voltage and under voltage	● Blinking
Microphone is on	● On
Microphone is muted	● Blinking
Only for Wireless Charger version	
Wireless charge mode	● On
Protect mode	● Blinking
Idle mode	No Light

RU

Status	LED indication
Any BT device connected	● On
BT pairing	● Blinking
No BT device connected	● Slow Blinking
Power on mode	● On
Power off mode	No Light
Over voltage and under voltage	● Blinking
Microphone is on	● On
Microphone is muted	● Blinking
Only for Wireless Charger version	
Wireless charge mode	● On
Protect mode	● Blinking
Idle mode	No Light

DA

Status	LED indication
Any BT device connected	● On
BT pairing	● Blinking
No BT device connected	● Slow Blinking
Power on mode	● On
Power off mode	No Light
Over voltage and under voltage	● Blinking
Microphone is on	● On
Microphone is muted	● Blinking
Only for Wireless Charger version	
Wireless charge mode	● On
Protect mode	● Blinking
Idle mode	No Light

PL





















Status	LED indication
Any BT device connected	● On
BT pairing	● Blinking
No BT device connected	● Slow Blinking
Power on mode	● On
Power off mode	No Light
Over voltage and under voltage	● Blinking
Microphone is on	● On
Microphone is muted	● Blinking
Only for Wireless Charger version	
Wireless charge mode	● On
Protect mode	● Blinking
Idle mode	No Light

SMARTBASE





















Quick Start Guide

Guide de démarrage rapide





















KO

Status	LED indication
 Any BT device connected	 On
 BT pairing	 Blinking
 No BT device connected	 Slow Blinking
 Power on mode	 On
 Power off mode	No Light
 Over voltage and under voltage	 Blinking
 Microphone is on	 On
 Microphone is muted	 Blinking
Only for Wireless Charger version	
 Wireless charge mode	 On
 Protect mode	 Blinking
 Idle mode	No Light





















CHS

Status	LED indication
 Any BT device connected	 On
 BT pairing	 Blinking
 No BT device connected	 Slow Blinking
 Power on mode	 On
 Power off mode	No Light
 Over voltage and under voltage	 Blinking
 Microphone is on	 On
 Microphone is muted	 Blinking
Only for Wireless Charger version	
 Wireless charge mode	 On
 Protect mode	 Blinking
 Idle mode	No Light

CHT

Status	LED indication
 Any BT device connected	 On
 BT pairing	 Blinking
 No BT device connected	 Slow Blinking
 Power on mode	 On
 Power off mode	No Light
 Over voltage and under voltage	 Blinking
 Microphone is on	 On
 Microphone is muted	 Blinking
Only for Wireless Charger version	
 Wireless charge mode	 On
 Protect mode	 Blinking
 Idle mode	No Light

ID

Status	LED indication
 Any BT device connected	 On
 BT pairing	 Blinking
 No BT device connected	 Slow Blinking
 Power on mode	 On
 Power off mode	No Light
 Over voltage and under voltage	 Blinking
 Microphone is on	 On
 Microphone is muted	 Blinking
Only for Wireless Charger version	
 Wireless charge mode	 On
 Protect mode	 Blinking
 Idle mode	No Light

SMARTBASE

Quick Start Guide

Guide de démarrage rapide

EN

- Model No: JBL SMARTBASEWL
(For wireless charger version)
- Model No: JBL SMARTBASEWR
(For non-wireless charger version)
- Transducer: 2 x 33mm
- Rated Power: 2x5W
- Frequency Response: 140Hz to 20kHz
- Signal-to-Noise Ratio: >80dB
- Connectors: DC and USB
- Bluetooth® Version: 4.1

- Bluetooth® transmitter frequency range:
2.402 – 2.480GHz
- Support: A2DP V1.3, AVRCP V1.5,
HFP V1.6
- Dimensions (H x W x D):
67mm x 144mm x 131mm
- Weight: 580g

ES

- Model No: JBL SMARTBASEWL
(For wireless charger version)
- Model No: JBL SMARTBASEWR
(For non-wireless charger version)
- Transductor: 2 x 33 mm
- Potencia nominal: 2x5W
- Respuesta en frecuencias:
De 140 Hz a 20 kHz
- Relación señal-ruido: > 80 dB
- Conectores: DC and USB
- Versión Bluetooth®: 4.1

- Intervalo de frecuencias del transmisor
Bluetooth®: 2,402 – 2,480 GHz
- Compatibilidad: A2DP V1.3, AVRCP V1.5,
HFP V1.6
- Dimensiones (ancho x alto x prof.):
67 mm x 144 mm x 131 mm
- Peso: 580 g

DE

- Model No: JBL SMARTBASEWL
(For wireless charger version)
- Model No: JBL SMARTBASEWR
(For non-wireless charger version)
- Schallgeber: 2 x 33mm
- Nennleistung: 2x5W
- Frequenzgang: 140Hz bis 20kHz
- Rauschabstand: > 80 dB
- Anschlüsse: DC and USB
- Bluetooth®-Version: 4,1

- Frequenzbereich für die Bluetooth®-
Übertragung: 2,402 – 2,480 GHz
- Unterstützt: A2DP V1.3, AVRCP V1.5,
HFP V1.6
- Abmessungen (H x B x T):
67mm x 144mm x 131mm
- Gewicht: 580g

FR

- Model No: JBL SMARTBASEWL
(For wireless charger version)
- Model No: JBL SMARTBASEWR
(For non-wireless charger version)
- Transducteur: 2 x 33 mm
- Puissance nominale: 2x5W
- Réponse en fréquence: 140 Hz à 20 kHz
- Rapport signal sur bruit: > 80 dB
- Connecteurs: DC and USB
- Version Bluetooth®: 4,1

- Plage de fréquences de l'émetteur
Bluetooth®: 2,402 à 2,480 GHz
- Support: A2DP V1.3, AVRCP V1.5,
HFP V1.6
- Dimensions (H x L x P):
67 mm x 144 mm x 131 mm
- Poids: 580 g

PT

- Model No: JBL SMARTBASEWL
(For wireless charger version)
- Model No: JBL SMARTBASEWR
(For non-wireless charger version)
- Transdutor: 2 x 33 mm
- Potência nominal: 2x5W
- Resposta de frequência: 140 Hz a 20 kHz
- Relação sinal-ruido: > 80 dB
- Conectores: DC and USB
- Versão Bluetooth®: 4.1

- Frequência do transmissor Bluetooth®:
2,402 – 2,480 GHz
- Padrões suportados: A2DP V1.3,
AVRCP V1.5, HFP V1.6
- Dimensões (A x L x P):
67 mm x 144 mm x 131 mm
- Peso: 580 g

IT

- Model No: JBL SMARTBASEWL
(For wireless charger version)
- Model No: JBL SMARTBASEWR
(For non-wireless charger version)
- Trasduttore: 2 x 33mm
- Potenza nominale: 2x5W
- Risposta in frequenza: da 140Hz a 20kHz
- Rapporto Segnale-Rumore: > 80 dB
- Connessioni Cavo DC and USB
- Versione Bluetooth®: 4.1

- Intervallo di frequenza del trasmettitore
Bluetooth®: 2.402 – 2.480 GHz
- Supporta: A2DP V1.3, AVRCP V1.5,
HFP V1.6
- Dimensioni (alt. x largh. x prof.):
67mm x 144mm x 131mm
- Peso: 580g

SMARTBASE

Quick Start Guide

Guide de démarrage rapide

NL

- Model No: JBL SMARTBASEWL (For wireless charger version)
- Model No: JBL SMARTBASEWR (For non-wireless charger version)
- Transducer: 2 x 33mm
- Nominiaal vermogen: 2x5W
- Frequentiebereik: 140Hz tot 20kHz
- Signaal-ruisverhouding: > 80 dB
- Aansluitingen: DC and USB
- Bluetooth® versie: 4.1

- Bluetooth® transmitter frequentiebereik: 2,402 – 2,480 GHz
- Ondersteuning: A2DP V1.3, AVRCP V1.5, HFP V1.6
- Afmetingen (B x H x L): 67mm x 144mm x 131mm
- Gewicht: 580g

FI

- Model No: JBL SMARTBASEWL (For wireless charger version)
- Model No: JBL SMARTBASEWR (For non-wireless charger version)
- Kaiutinelementti: 2 x 33mm
- Nimellisteho: 2x5W
- Taajuusvaste: 140Hz – 20kHz
- Signaali-kohinasuhde: > 80 dB
- Liitännät: DC and USB
- Bluetooth® versio: 4.1

- Bluetooth®-lähettimen taajuusväli: 2,402 – 2,480 GHz
- Tuki: A2DP V1.3, AVRCP V1.5, HFP V1.6
- Mitat (K x L x S): 67mm x 144mm x 131mm
- Paino: 580g

SV

- Model No: JBL SMARTBASEWL (For wireless charger version)
- Model No: JBL SMARTBASEWR (For non-wireless charger version)
- Element: 2 x 33 mm
- Klassad effekt: 2x5W
- Frekvensomfång: 140 Hz till 20 kHz
- Signal-brus-förhållande: > 80 dB
- Anslutningar: DC and USB
- Bluetooth®-version: 4,1

- Bluetooth®-sändarens frekvensomfång: 2,402 – 2,480 GHz
- Stöd för: A2DP V1.3, AVRCP V1.5, HFP V1.6
- Mått (H x B x D): 67 x 144 x 131 mm
- Vikt: 580 g

NO

- Model No: JBL SMARTBASEWL (For wireless charger version)
- Model No: JBL SMARTBASEWR (For non-wireless charger version)
- Transducer: 2 x 33mm
- Nominell effekt: 2x5W
- Frekvensrespons: 140 Hz til 20 kHz
- Signal-til-støy-forhold: > 80 dB
- Kontakter: DC and USB
- Bluetooth®-versjon: 4.1

- Frekvensområde for Bluetooth®-sender: 2,402 – 2,480 GHz
- Støtter: A2DP V1.3, AVRCP V1.5, HFP V1.6
- Dimensjoner (H x B x D): 67mm x 144mm x 131mm
- Vekt: 580g

RU

- Model No: JBL SMARTBASEWL (For wireless charger version)
- Model No: JBL SMARTBASEWR (For non-wireless charger version)
- Преобразователь: 2 x 33 мм
- Номинальная мощность: 2x5 Вт
- Частотная характеристика: от 140 Гц до 20 КГц
- Коэффициент «сигнал-шум»: > 80 дБ
- Разъемы: DC and USB
- Версия Bluetooth®: 4.1

- Частотный диапазон передатчика Bluetooth®: 2,402 – 2,480 ГГц
- Поддерживаемые протоколы: A2DP V1.3, AVRCP V1.5, HFP V1.6
- Габариты (В x Ш x Г): 67 мм x 144 мм x 131 мм
- Вес: 580 г

DA

- Model No: JBL SMARTBASEWL (For wireless charger version)
- Model No: JBL SMARTBASEWR (For non-wireless charger version)
- Transducer: 2 x 33 mm
- Nomineret effekt: 2x5W
- Frekvensområde: 140 Hz – 20 kHz
- Signal til støj-forhold: > 80 dB
- Tilslutning: DC and USB
- Bluetooth®-version: 4.1

- Bluetooth®-sendefrekvensområde: 2,402-2,480 GHz
- understøttelse: A2DP V1.3, AVRCP V1.5, HFP V1.6
- Mål (H x B x D): 67 mm x 144 mm x 131 mm
- Vægt: 580 g

SMARTBASE

Quick Start Guide

Guide de démarrage rapide

JP

- Model No: JBL SMARTBASEWL (For wireless charger version)
 - Model No: JBL SMARTBASEWR (For non-wireless charger version)
 - トランスデューサー: 2x33mm
 - 定格出力: 2x5W
 - 周波数特性: 140Hz~20KHz
 - S/N比 80dB以上
 - コネクタ: マイクロUSB
 - Bluetooth®バージョン: 4.1
-
- Bluetooth®トランスミッター周波数帯域: 2.402~2.480 GHz
 - サポート: A2DP 1.3V, AVRCP 1.5V, HFP 1.6V
 - 寸法(高さx幅x奥行): 67mm x 144mm x 131mm
 - 重量: 580g

KO

- Model No: JBL SMARTBASEWL (For wireless charger version)
 - Model No: JBL SMARTBASEWR (For non-wireless charger version)
 - 변환기: 2 x 33mm
 - 정격 전력: 2x5W
 - 주파수 응답: 140Hz ~ 20KHz
 - 신호 대 잡음비: 80dB 미만
 - 커넥터: 마이크로 USB
 - Bluetooth® 버전: 4.1
-
- Bluetooth® 송신기 주파수 범위: 2.402 ~ 2.480 GHz
 - 지원: A2DP V1.3, AVRCP V1.5, HFP V1.6
 - 치수(높이 x 너비 x 깊이): 67mm x 144mm x 131mm
 - 중량: 580g

CHT

- Model No: JBL SMARTBASEWL (For wireless charger version)
 - Model No: JBL SMARTBASEWR (For non-wireless charger version)
 - 轉換器: 2 x 33mm
 - 額定功率: 2x5W
 - 頻率回應: 140Hz - 20kHz
 - 雜訊比: > 80 dB
 - 接口: DC and USB
 - Bluetooth® 版本: 4.1
-
- Bluetooth® 發射機頻率範圍: 2.402 - 2.480 GHz
 - 支援: A2DP V1.3, AVRCP V1.5, HFP V1.6
 - 尺寸(高 x 寬 x 深): 67mm x 144mm x 131mm
 - 重量: 580g

PL

- Model No: JBL SMARTBASEWL (For wireless charger version)
 - Model No: JBL SMARTBASEWR (For non-wireless charger version)
 - Przetwornik: 2 x 33 mm
 - Moc znamionowa: 2x5W
 - Pasmo przenoszenia: 140 Hz - 20 kHz
 - Stosunek sygnału do szumu: > 80 dB
 - Złącza: DC and USB
 - Wersja Bluetooth®: 4.1
-
- Zakres częstotliwości nadajnika Bluetooth®: 2,402 - 2,480 GHz
 - Wsparcie dla: A2DP V1.3, AVRCP V1.5, HFP V1.6
 - Wymiary (wysokość x szerokość x głębokość): 67 mm x 144 mm x 131 mm
 - Masa: 580 g

CHS

- Model No: JBL SMARTBASEWL (For wireless charger version)
 - Model No: JBL SMARTBASEWR (For non-wireless charger version)
 - 換能器: 2 个, 33mm
 - 額定功率: 2x5W
 - 頻率响应: 140Hz 至 20kHz
 - 信噪比: >80 dB
 - 连接器: DC and USB
 - 蓝牙版本: 4.1
-
- Bluetooth® 发射器频率范围: 2.402 - 2.480 GHz
 - 支持: A2DP V1.3, AVRCP V1.5, HFP V1.6
 - 尺寸(高 x 宽 x 长): 67mm x 144mm x 131mm
 - 重量: 580g

ID

- Model No: JBL SMARTBASEWL (For wireless charger version)
 - Model No: JBL SMARTBASEWR (For non-wireless charger version)
 - Transduser: 2 x 33 mm
 - Peringkat Daya: 2x5W
 - Respons Frekuensi: 140 Hz hingga 20 kHz
 - Rasio Signal-to-Noise (Sinyal-dibanding-Derau): > 80 dB
 - Konektor: DC and USB
 - Versi Bluetooth®: 4.1
-
- Rentang frekuensi transmiter Bluetooth®: 2,402 - 2,480 GHz
 - Dukungan: A2DP V1.3, AVRCP V1.5, HFP V1.6
 - Dimensi (T x P x L): 67 mm x 144 mm x 131 mm
 - Berat: 580 g

SMARTBASE

Quick Start Guide

Guide de démarrage rapide

Торговая марка	: JBL
Назначение товара	: Автомобильное зарядное устройство
Изготовитель	: Харман Интернешнл Индастриз Инкорпорейтед, США, 06901 Коннектикут, г.Стэмфорд, Атлантик Стрит 400, офис 1500
Страна происхождения	: Китай
Импортер в Россию	: ООО "ХАРМАН РУС СиАйЭс", Россия, 127018, г.Москва, ул. Двинцев, д.12, к 1
Гарантийный период	: 1 год
Информация о сервисных центрах	: www.harman.com/ru тел. +7-800-700-0467
Срок службы	: 5 лет
Товар сертифицирован	
Дата производства	: Дата изготовления устройства определяется по двум буквенным обозначениям из второй группы символов серийного номера изделия, следующих после разделительного знака «-». Кодировка соответствует порядку букв латинского алфавита, начиная с января 2010 года: 000000-MY0000000, где «М» - месяц производства (А - январь, В - февраль, С - март и т.д.) и «Y» - год производства (А - 2010, В - 2011, С - 2012 и т.д.).



Este equipamento opera em caráter secundário, isto é, não tem direito a proteção contra interferência prejudicial, mesmo de estações do mesmo tipo, e não pode causar interferência a sistemas operando em caráter primário"

Este produto está homologado pela ANATEL, de acordo com os procedimentos regulamentados pela Resolução 242/2000, e atende aos requisitos técnicos aplicados.

Para maiores informações, consulte o site da ANATEL – www.anatel.gov.br



XXXX-XX-XXXX



The Bluetooth® word mark and logos are registered trademarks owned by Bluetooth SIG, Inc. and any use of such marks by HARMAN International Industries, Incorporated is under license. Other trademarks and trade names are those of their respective owners.

