

## **JBL PowerUp Wireless Charging Speaker for Nokia MD-100W**

### **Contents**

**About your speaker 3**

**About Qi 3**

**About Bluetooth connectivity 4**

**Keys and parts 5**

**Switch the speaker on 6**

**Pair your device 7**

Pair and connect 7

Pair the speaker using NFC 7

Pair the speaker manually 8

Clear the pairings 8

**Play music 8**

**Charge another device wirelessly 10**

**Connect to another device on the go 10**

**Support 11**

**Product and safety information 11**

## About your speaker

With the Nokia MD-100W wireless speaker, you can listen to music in high audio quality from your phone or other compatible device, such as a music player. You can connect to another device without stopping the music. You can also use a standard audio cable (3.5 mm) to connect your device to the audio connector in the speaker. The product comes with an audio cable.

The Nokia MD-100W wireless speaker can also be used as a wireless charger. To charge a Qi compatible device, place it on the wireless charging area, on top of the speaker.

**Warning:**  
This product may contain small parts. Keep them out of the reach of small children.

Parts of the product are magnetic. Metallic materials may be attracted to the product. Do not place credit cards or other magnetic storage media near the product, because info stored on them may be erased.

The surface of this product is nickel-free.

## About Qi

Qi is a global standard that makes wireless charging possible for your device. With a Qi-compatible device, you don't need to connect any cables. You just place your device on the charging surface.

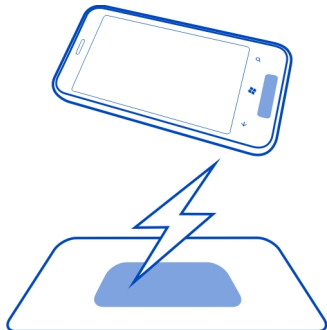

Qi works using magnetic induction, and is currently designed for devices that use 5 watts of power or less, such as mobile phones. Qi chargers and devices use the same frequency, so as long as their active areas are touching, all Qi products are compatible, regardless of manufacturer or brand. For more details, see the user guides of both devices.

### About Bluetooth connectivity

You can use Bluetooth to make a wireless connection to other compatible devices, such as mobile phones.

Devices do not need to be in direct line-of-sight, but they must be within 10 metres (33 feet) of each other. The connection may be affected by obstructions such as walls or other electronic devices.

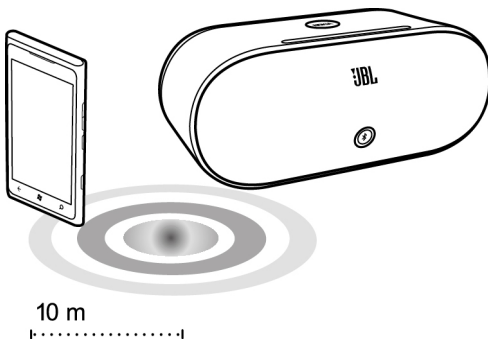

This device is compliant with Bluetooth Specification 2.1 + EDR supporting the following profiles: A2DP and AVRCP. Check with the manufacturers of other devices to determine their compatibility with this device.

## Keys and parts

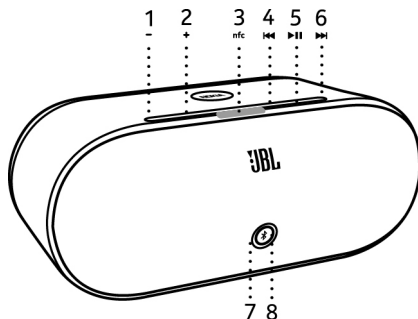

- 1 Volume down key
- 2 Volume up key
- 3 NFC area
- 4 Skip to previous track
- 5 Play or pause key
- 6 Skip to next track
- 7 Power and Bluetooth status indicator
- 8 Bluetooth key

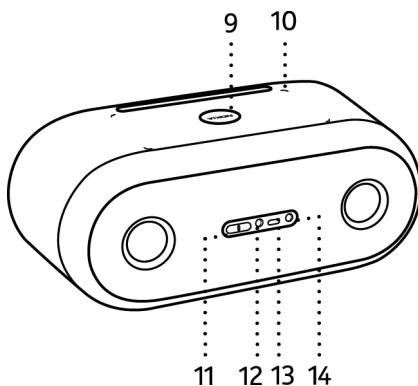

- 9 Wireless charging area
- 10 Wireless charging status indicators
- 11 Power key
- 12 Connector for power supply
- 13 Service connector
- 14 Audio connector (3.5 mm)

## Switch the speaker on

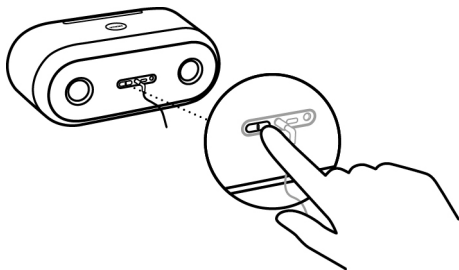

- 1 Connect the power supply cable to the connector on the speaker.
- 2 Connect a suitable plug to the AC-adaptor of the power supply.
- 3 Plug the power supply into a wall outlet.
- 4 Press the power key.

If you've never paired your speaker with a device, or you've cleared the pairings, the speaker goes into pairing mode automatically when it is switched on, and the Bluetooth indicator light starts to flash slowly.

If you've already paired the speaker with one or more devices, the speaker connects to the last device it was used with.

If the speaker is not connected to another device, or has no audio connection or other activity for 30 minutes, it switches to standby mode, and all the indicator lights switch off.

## Pair your device

### Pair and connect

Before using your speaker with a phone or other compatible device for the first time, you must pair and connect it to the device.

You can only connect the speaker to one device at a time, but you can connect to another device on the go.

When the speaker is paired, the Bluetooth status indicator light is blue.

If the connected device goes out of Bluetooth range, the speaker tries to reconnect for 3 minutes. When the device comes back into range, the speaker reconnects automatically.

You can also use a standard audio cable (3.5 mm) to connect your device to the audio connector in the speaker. When you connect your speaker and device using a wired connection, Bluetooth is switched off automatically, and the Bluetooth indicator light turns white.

### Pair the speaker using NFC

With Near Field Communication (NFC), you can easily pair and connect your speaker to your compatible device.

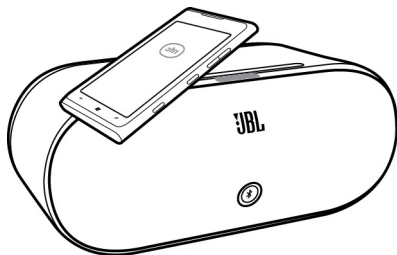

If your device supports NFC, switch NFC on, and touch the NFC area of the speaker with the NFC area of your device. The speaker connects to your device automatically. Some devices may ask for confirmation on connection. For details on NFC, see your device user guide.

Tapping the NFC area with an already connected NFC-capable phone disconnects the Bluetooth connection.

If your device doesn't support NFC, pair the speaker manually.

### Pair the speaker manually

You can pair your speaker manually with Bluetooth.

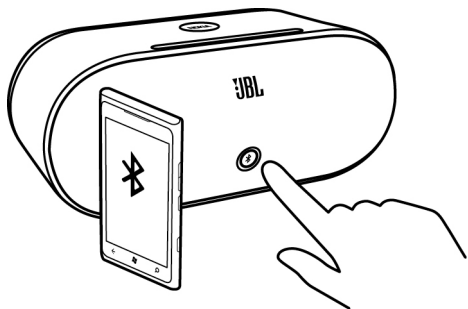

- 1 Switch on your speaker and phone or other compatible device.
- 2 If you've previously paired your speaker with another device, press and hold  for 2 seconds to switch Bluetooth on.
- 3 Within 3 minutes, switch Bluetooth on in your phone, and search for Bluetooth devices. For details, see your phone user guide.
- 4 On your phone, select the speaker from the list of found devices.
- 5 If asked, type in the passcode **0000**.

### Clear the pairings

You can clear the paired devices list on your speaker.

Switch the speaker off, then press and hold  and the power key for 5 seconds. The white and red indicator lights alternate.

After you've cleared the pairings, you must pair the speaker before you can use it again. When you switch on the speaker, pairing mode goes on automatically.

### Play music

While playing music on your phone, you can control the music with your speaker as well.



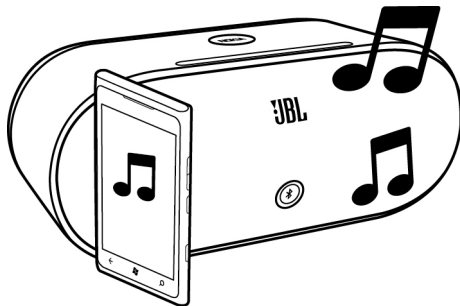

### Play a song

Select a song in the music player list, and press **▶▶** to play, pause, or resume playing.

If you receive or make a call while listening to music, the music is paused.

### Play the next song

Press **▶▶▶**.

### Play the previous song

Press **◀◀**.

### Adjust the volume

Press **+** or **-**.

### Mute the music

Press **+** and **-** at the same time.

### Unmute the music

Press either **+** or **-**, or both at the same time.

**Warning:**  
Continuous exposure to high volume may damage your hearing. Listen to music at a moderate level.

## Charge another device wirelessly

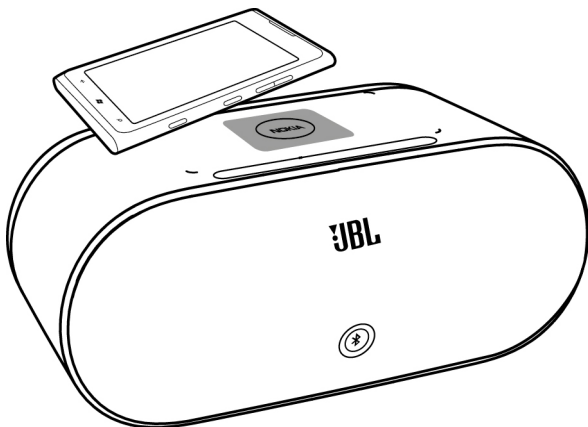

Place your phone or other compatible device on the wireless charging area on top of the speaker. The charging indicator lights turn white and flash on and off while charging. Adjust the position of your phone if the charging indicator lights blink quickly. When your phone is fully charged, the charging indicator lights go off immediately.

**Tip:** If you've already paired your phone with the speaker, the speaker automatically connects to it when you place your phone on the speaker to charge.

It's normal for your speaker and phone to get warm, and they may get even warmer if you use your phone to, for example, stream music while charging. The speaker switches off automatically if it gets too warm. Wait for 5 minutes and try again.

Keep the speaker free of clutter. If there is something besides your phone on the speaker, the speaker doesn't charge, and the charging indicator lights blink quickly.

## Connect to another device on the go

Take turns with your friends in playing your music. You can change the connected device on the go, without pausing the music.

- 1 While playing music from your connected device, press and hold  $\times$  for 2 seconds.
- 2 Pair and connect to another device. The music continues playing until pairing is complete.
- 3 Play music on the device just connected.

## Support

When you want to learn more about how to use your device, or if you're unsure how your device should work, read the user guide thoroughly.

If you have an issue, restore the original factory settings.

If your issue remains unsolved, contact Nokia for repair options.

## Product and safety information

### Take care of your device

Handle your device, charger and accessories with care. The following suggestions help you protect your warranty coverage.

- Keep the device dry. Precipitation, humidity, and all types of liquids or moisture can contain minerals that corrode electronic circuits. If your device gets wet, allow the device to dry.
- Use the charger for intended purposes only. Improper use, or use of incompatible chargers may present a risk of fire, explosion, or other hazard. Never use a damaged charger. Only use the charger indoors.
- Do not attempt to charge a device having a damaged, cracked or open battery case or a device that is not compatible with Qi.
- Do not store the device in high temperatures. High temperatures can shorten the life of the device, and warp or melt plastics.
- Do not attempt to open the device.
- Unauthorised modifications may damage the device and violate regulations governing radio devices.
- Do not drop, knock, or shake the device.
- Only use a soft, clean, dry cloth to clean the surface of the device.

### Recycle

Always return your used electronic products, batteries, and packaging materials to dedicated collection points. This way you help prevent uncontrolled waste disposal and promote the recycling of materials.

### Crossed-out wheeled-bin symbol



The crossed-out wheeled-bin symbol on your product, battery, literature, or packaging reminds you that all electrical and electronic products, batteries, and accumulators must be taken to separate collection at the end of their working life. This requirement applies in the European Union. Do not dispose of these products as unsorted municipal waste. For more environmental information, see the product Eco profile at [www.nokia.com/ecoprofile](http://www.nokia.com/ecoprofile).

## 12 Product and safety information

---

### Additional safety information

#### Implanted medical devices

Manufacturers of medical devices recommend a minimum separation of 15.3 centimetres (6 inches) between a wireless device and an implanted medical device, such as a pacemaker or implanted cardioverter defibrillator, to avoid potential interference with the medical device. Persons who have such devices should:

- Always keep the wireless device more than 15.3 centimetres (6 inches) from the medical device.
- Not carry the wireless device in a breast pocket.
- Switch the wireless device off if there is any reason to suspect that interference is taking place.
- Follow the manufacturer directions for the implanted medical device.

If you have any questions about using your wireless device with an implanted medical device, consult your health care provider.

## DECLARATION OF CONFORMITY

**CE 0434**   

Hereby, NOKIA CORPORATION declares that this RM-303 product is in compliance with the essential requirements and other relevant provisions of Directive 1999/5/EC. A copy of the Declaration of Conformity can be found at <http://www.nokia.com/global/declaration/declaration-of-conformity>.

© 2012 Nokia. All rights reserved.

Nokia, Nokia Connecting People, and the Nokia Original Accessories logo are trademarks or registered trademarks of Nokia Corporation.

Reproduction, transfer, distribution, or storage of part or all of the contents in this document in any form without the prior written permission of Nokia is prohibited. Nokia operates a policy of continuous development. Nokia reserves the right to make changes and improvements to any of the products described in this document without prior notice.

The 'Qi' symbol is a trademark of the Wireless Power Consortium

The Bluetooth word mark and logos are owned by the Bluetooth SIG, Inc. and any use of such marks by Nokia is under license.

To the maximum extent permitted by applicable law, under no circumstances shall Nokia or any of its licensors be responsible for any loss of data or income or any special, incidental, consequential or indirect damages howsoever caused.

The contents of this document are provided "as is". Except as required by applicable law, no warranties of any kind, either express or implied, including, but not limited to, the implied warranties of merchantability and fitness for a particular purpose, are made in relation to the accuracy, reliability or contents of this document. Nokia reserves the right to revise this document or withdraw it at any time without prior notice.

The availability of products may vary by region. For more info, contact your Nokia dealer. This device may contain commodities, technology or software subject to export laws and regulations from the US and other countries. Diversion contrary to law is prohibited.

## FCC/INDUSTRY CANADA NOTICE

This device complies with part 15 of the FCC rules and Industry Canada licence-exempt RSS standard(s). Operation is subject to the following two conditions: (1) This device may not cause harmful interference, and (2) this device must accept any interference received, including interference that may cause undesired operation. Your device may cause TV or radio interference (for example, when using a device in close proximity to receiving equipment). If you require assistance, contact your local service facility. Any changes or modifications not expressly approved by Nokia could void the user's authority to operate this equipment.

NOTE: FCC Radiation Exposure Statement: This equipment complies with FCC radiation exposure limits set forth for an uncontrolled environment. This transmitter must not be co-located or operating in conjunction with any other antenna or transmitter.

/Issue 1 EN