

Wii™

THE BEATLES™ ROCKBAND™

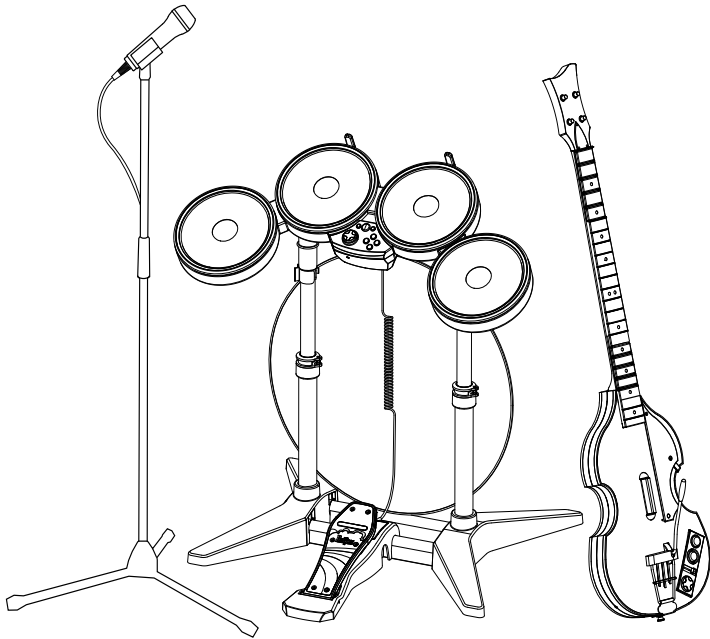

Contents...
for Wii™

THE BEATLES

ROCKBAND

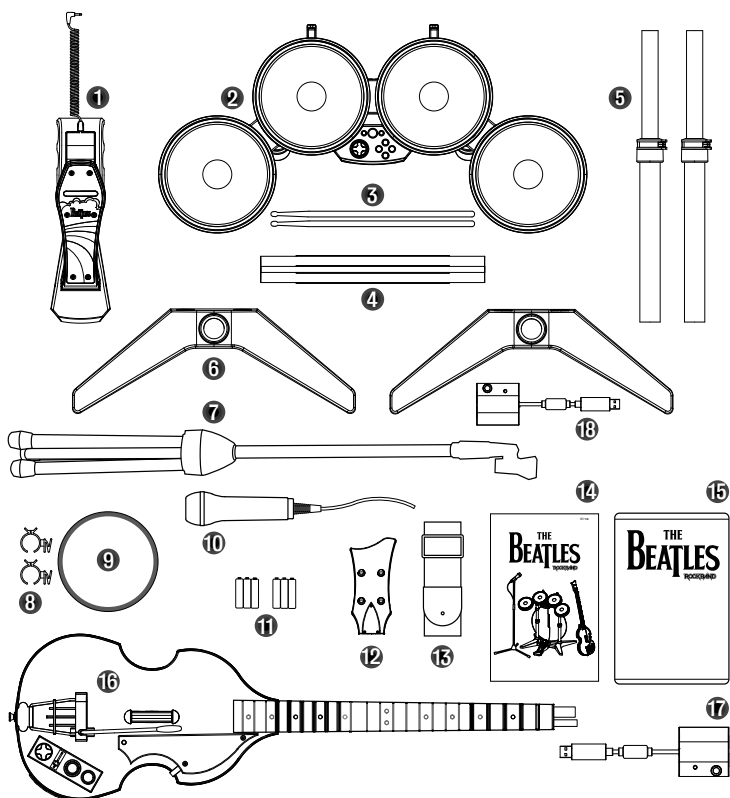

- | | |
|------------------------|-------------------------------|
| ① Kick Pedal | ⑩ Microphone |
| ② Drum Array | ⑪ 2 x 3 AA batteries |
| ③ 2 x Drum Sticks | ⑫ Headstock |
| ④ 2 x Cross Bars | ⑬ Guitar Controller Strap |
| ⑤ 2 x Legs | ⑭ Hardware Manual |
| ⑥ 2 x Base parts | ⑮ The Beatles: Rock Band Game |
| ⑦ Microphone Stand | ⑯ Wireless Guitar Controller |
| ⑧ 2 x Kick Shade Clips | ⑰ Wireless Guitar Dongle |
| ⑨ Kick Shade | ⑱ Wireless Drum Dongle |

Using your...

Hofner Beatles Bass WIRELESS GUITAR CONTROLLER

for Wii™

THE BEATLES ROCKBAND

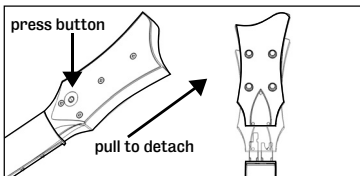
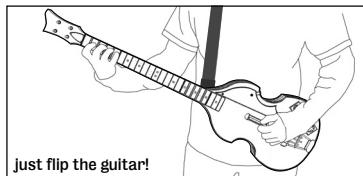
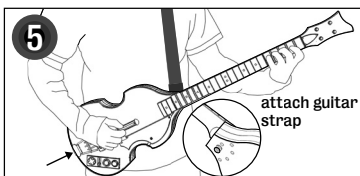
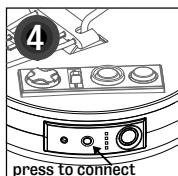
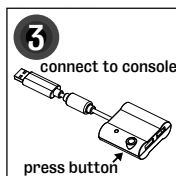
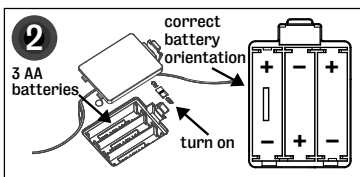
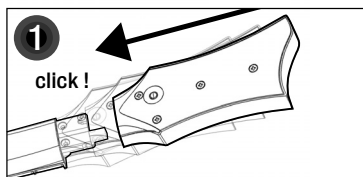
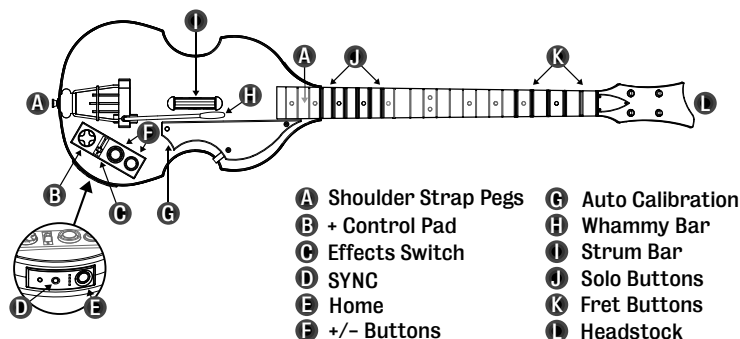

FOR LEFTIES...

TO REMOVE THE HEADSTOCK...

Important USB information: The wireless USB dongle must be plugged directly into the Wii console. The additional USB port on the guitar's wireless USB dongle can only be used for wired peripherals and wireless drum peripherals.

Using your...

Beatles

WIRELESS DRUM CONTROLLER

for Wii™

THE BEATLES

ROCKBAND

- M** Base
- N** Drum Array
- O** Sticks
- P** Cross Bars
- Q** Kick ShadeClips
- R** Kick Shade
- S** Kick Pedal
- T** Legs
- U** SYNC
- V** Home
- W** Expansion Port
- X** Cymbal Ports
- Y** Drum Dongle

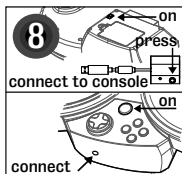
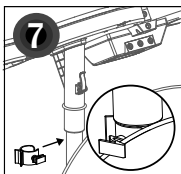
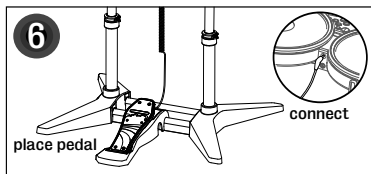
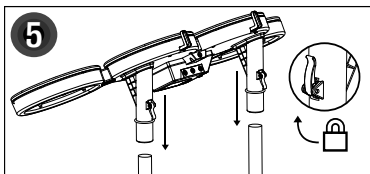
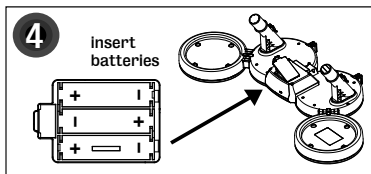
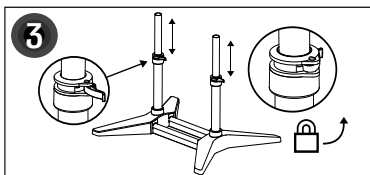
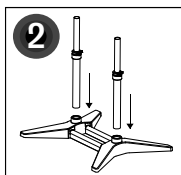
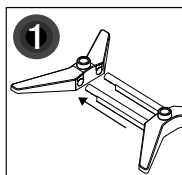
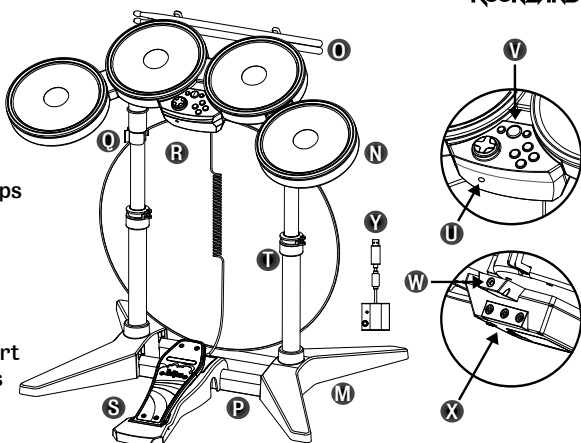

GENERAL

Problem: My Guitar or Drum Controller keeps disconnecting.

Solution 1: Ensure there are no 2.4 GHz wireless devices around that could potentially interfere with The Beatles: Rock Band Controllers. Common offending devices include cordless phones, Wi-Fi routers, and microwaves.

Solution 2: Make sure that the batteries are not jarring loose during play. A thin layer of duct tape, cardboard, or weather stripping foam on the inside of the battery door can help secure the batteries during insane solos/drum fills.

DRUMS

Problem: My Drum Controller pads aren't sensitive enough.

Solution: If you want to maximize hit recognition, aim for the center of the pads marked by the glossy black circle, where the drums are most sensitive.

Problem: I can't plug a second Kick Drum pedal directly into the Drum Controller.

Solution: Nope, you can't. The yellow, blue, and green colored jacks are expansion ports for cymbals, the orange jack is for the Kick Drum pedal, and the black jack (under the orange kick pedal jack) is reserved for future use and does not function as a second Kick Drum pedal jack.

Problem: I don't want to break my Kick Drum pedal.

Solution: Don't stomp too hard: keep the ball of your foot on the orange line and your heel planted. While keeping your foot in that position, use your ankle to push the pedal down.

GUITARS

Problem: The auto-calibration feature on my Guitar Controller isn't working.

Solution 1: Please ensure you have fresh batteries in your Guitar Controller.

Solution 2: Calibration works best in a dark, silent room. If you have a surround sound setup, please ensure you are holding the Guitar Controller up to your center speaker during audio calibration, as the calibration tone will only be played by the center speaker.

Solution 3: Ensure that vibration is enabled on your profile:

Step 1: Plug the dongle into the console USB port.

Step 2: Put in batteries and flip the on/off switch to the "on" position.

Step 3: Turn on the console and load the game.

Step 4: Press the sync button on the Guitar or Drum Controller.

The Controller should now sync up with the already-searching dongle. The dongle and the LEDs on both Controllers will remain solid and the Controller will be able to navigate the main menu. If the Controller does not sync up initially, press the sync button on the dongle to reset the search sequence and then the sync button on the Controller to bind.

Problem: My Guitar Controller doesn't always engage Beatlemania when I want it to.

Solution: As an alternative to tilting the guitar, you can engage Beatlemania with any Rock Band, Rock Band 2 or The Beatles: Rock Band kick pedal. Just plug the pedal into the 3.5 mm jack on the bottom of your guitar controller and depress the pedal. This will engage Beatlemania without the need for you to tilt the guitar. Keep in mind that the pedal works in addition to the tilt sensor in your Guitar Controller and does not disable it.

Problem: I can't plug all my USB peripherals into the console.

Solution: Your Drum Controller dongle can be plugged into the pass-through USB port on the Guitar and Bass dongles. Note: you cannot plug a Guitar or Bass dongle into another Guitar or Bass dongle.

MICROPHONES

Problem: I can't make selections because there are no buttons on the Microphone.

Solution: In order to play the game, you need to use a Wii Remote in addition to your Microphone.

Problem: I am using multiple Microphones – how many Wii Remotes do I need?

Solution: If you want to sing with friends, you only need to use one Wii Remote for up to three Microphones.

The Beatles: Rock Band

IMPORTANT: Before using The Beatles: Rock Band (the "software") or the drum, guitar and/or microphone intended for use with the game (each, a "controller") with the Wii™ Console, please read the Wii Console operations manual for safety, health, and all other information and instructions regarding the proper use of the Wii Console.

All questions regarding the Wii Console should be directed to the manufacturer. For ease of reference, the term "game" shall refer collectively to the software and any and all controllers intended for use with the game.

WARNING: NO CHILD UNDER 36 MONTHS OF AGE SHOULD USE OR PLAY WITH THE GAME. Controllers should be kept out of reach of young children at all times. Controllers are suitable and intended only for use by adults and, if they are under strict adult supervision, for children who are at least 12 years of age.

CAUTION: Controllers must be handled and used with care to avoid injury. Controllers are to be used only where sufficient space is available to prevent injury (by contact with any controller or other player) or damage (including to personal property). There is a potential risk of epileptic attacks that may be caused by video games.

CAUTION: Please comply with ALL safety warnings and instructions. Any changes or modifications to the game or controllers that are not expressly approved by the manufacturer could void the user's authority to operate the game and/or the controllers and will void all game and hardware warranties.

Neither Electronic Arts nor its licensors will be liable for any injuries or damage resulting from the improper or unauthorized use of this game.

Important Information about Safety and the Proper Care and operations of controllers:

- Do not modify, disassemble or attempt to open any controller.
- Do not expose any controller to extreme conditions, including direct sunlight and excessive humidity.
- Do not expose any controller to liquids.
- If cleaning is necessary, use a dry cloth to clean the affected area. Never use chemicals.
- If a controller causes interference to radio or television reception, (you can determine this by turning the controller off and on), the user is encouraged to try to correct the interference by one or more of the following measures:

- (1) reorient or relocate the controller's receiving antenna, if applicable and/or
- (2) increase the separation between the controller and the game console.

Limited Controller Hardware Warranty:

Electronic Arts and its licensors warrant to the original purchaser of any controller that the controller has been designed and manufactured according to very stringent quality standards and is warranted to be free from defects in materials and workmanship beginning from the date of purchase for the minimum warranty period legally required where you, the original purchaser reside, but in any event not less than 60 days. If you are a resident of a Member country of the European Union, the minimum warranty period applicable to a controller from Electronic Arts and its licensors is two years. Under the warranty, if and as applicable to you, if the controller is found to be defective and you return it to us within the warranty period that applies to you, Electronic Arts will repair or replace the defective controller (or any defective component within the controller) at no charge to you. Other statutory rights you may have remain unaffected. This warranty is applicable to the original purchaser for the controller's normal intended use in accordance with the instructions provided. Any damage or defect resulting from abuse, improper use, neglect, accident, modification or misuse of the controller is not covered under and shall void the terms of this warranty. For more information please contact Electronic Arts at <http://rockbandservice.ea.com>

For service under the warranty, DO NOT return the game or any portion of the game (including guitars, drums, and microphones) to any retail store, even if that is where you originally purchased it. Retailers are NOT part of our authorized warranty support program. In the unlikely event you encounter a problem with any part of the game, please visit <http://rockbandservice.ea.com>. This website contains detailed instructions on how to take advantage of our warranty support program.

You understand that your rights as a consumer may vary depending on where you reside and the local laws and regulations that apply, and that some or all of your rights may be different or some rights or portions of the warranty may not apply to you. If you are unsure or have any questions about your rights, you should consult your own advisors or local consumer groups to determine the laws and regulations that may apply to you.

If you are a resident of Australia or New Zealand, certain exclusions from this warranty apply, including exclusions of terms, conditions, warranties and terms set forth herein or implied by statute, general law or custom of trade or usage, except for any "Non-excludable Condition" as that term is defined below and construed under the Australian Trade Practices Act 1974 ("TPA") or, in the case of consumers in New Zealand, the New Zealand Consumer Guarantees Act 1993 ("CGA"). Except for liability required by law or regulation in connection with any Non-excludable Condition, our liability to you for any act or omission, whether arising in contract or tort, including negligence, or otherwise in connection with the controller or our agreement is hereby disclaimed and excluded. For these purposes, "Non-excludable Condition" means any implied warranty, condition or guarantee the exclusion of which would contravene, in the case of Australian consumers, the TPA or, in the case of consumers in New Zealand, the CGA or in either case, that would cause all or any part of any exclusion or limitation of liability or remedy to be void. For any breach of a Non-excludable Condition (other than one implied by Section 69 of the TPA in Australia), your remedies are limited and, at our option, our liability is limited to either resupplying, replacing or repairing the controller or, at our option, paying the cost of doing any of these.

You may have certain rights as a consumer with respect to the merchant or retail establishment where you purchased this controller. The exclusions, restrictions, terms and conditions set forth herein do not affect or change the rights you may have under the laws that apply to your transaction(s) with such merchants or retail establishments.

Disclaimer of Other Warranties/Remedies:

If the game or any part thereof are damaged through modification, abuse, improper use, mistreatment, neglect or accident, any applicable warranty is rendered null and void and you will need to follow the instructions that apply for returns after the warranty period.

EXCEPT FOR THE EXPRESS LIMITED WARRANTIES SET FORTH ABOVE AND/OR TO THE EXTENT ANY PARTICULAR WARRANTIES OR RIGHTS MAY NOT BE DISCLAIMED OR LIMITED DUE TO THE LAWS AND REGULATIONS WHERE YOU RESIDE, ELECTRONIC ARTS AND ITS LICENSORS HEREBY DISCLAIM ALL WARRANTIES, WHETHER ORAL OR WRITTEN, EXPRESS OR IMPLIED, INCLUDING ANY WARRANTY OF MERCHANTABILITY OR FITNESS FOR A PARTICULAR PURPOSE. NO OTHER REPRESENTATION OR WARRANTY OF ANY NATURE OR KIND SHALL APPLY OR SHALL BE BINDING UPON OR OBLIGATE ELECTRONIC ARTS OR ITS LICENSORS.

If any warranties herein are incapable of being disclaimed because of the particular laws that apply to you, then such warranties applicable to this game are limited to the warranty period described above that applies to you. In no event will Electronic Arts or its licensors be liable for any special, incidental, or consequential damages resulting from possession, use or malfunction of the game, including, without limitation, any controller, game software or other part of the game, including damage to property, and to the extent permitted by law, damages for personal injury, even if Electronic Arts or its licensors have been advised of the possibility of such damages.

SOME JURISDICTIONS DO NOT ALLOW CERTAIN LIMITATIONS OF EXCLUSIONS, SO THE ABOVE LIMITATIONS AND/OR EXCLUSIONS MAY NOT APPLY TO YOU. IN EACH AND EVERY JURISDICTION, ELECTRONIC ARTS' AND/OR ITS LICENSORS' LIABILITY SHALL BE LIMITED AND THE EXCLUSIONS SHALL BE CONSTRUED TO APPLY TO THE FULLEST EXTENT PERMITTED BY LAW.

EU Declaration of Conformity: As required, certain of these controllers have been tested and conform to the requirements of the European Union Directives 1999/5/EC and 2004/108/EC. Authorized signatory of the manufacturer is Harmonix Music Systems, Inc., 625 Massachusetts Ave. Cambridge, Massachusetts 02139.

United States and Canada: As required, certain of these class B digital devices (the controllers) have been tested by Harmonix Music Systems, Inc., 625 Massachusetts Ave., Cambridge, Massachusetts 02139, 1-617-491-6144, and found to comply with part 15 of the FCC rules and the Canadian RSS-210 which sets forth limits designed to provide reasonable protection against harmful interference in a residential installation. These device(s) use, generate and can radiate radio frequency energy and, if not assembled, installed and used in accordance with the instructions, may cause harmful interference to radio communications. There is no guarantee that interference will not occur in any particular location or use. Operation is subject to the following two conditions: (1) this device may not cause harmful interference and (2) this device must accept any interference received, including interference that may cause undesired operation.

Exposure to Radio Frequency Radiation:

The radiated output power of the controller is well within FCC radio frequency exposure limits for this type of device when unaltered and used as described in our instructions and the controller operates within guidelines found in radio frequency safety standards, which reflect the consensus of the scientific community and therefore, the manufacturer believes the device's internal wireless radio is safe for use by consumers. The level of energy emitted is far less than the electromagnetic energy emitted by wireless devices such as mobile phones. However, the use of wireless radios may be restricted in some situations (e.g., on airplanes). If you are unsure of restrictions that may apply in any situation, you must ask for authorization before turning on, connecting or using the controller.

Important Battery Information for Wireless Controllers:

- Use only fresh AA standard alkaline batteries.
- Replace all used batteries at the same time and with the same type of batteries.
- Be sure to replace the batteries correctly by matching the + and - as shown in the instruction manual and the controller's battery compartment. Never insert batteries backwards.
- If you know that you will not be using the controller for an extended period of time, we recommend that you remove the batteries.
- If you use rechargeable batteries that are permitted, use and recharge them only under adult supervision and only in accordance with the manufacturer's instructions.
- Never try to re-charge non-rechargeable batteries.
- Rechargeable batteries are to be removed from the controller before charging.
- Do not mix alkaline, standards (carbon-zinc), or rechargeable batteries.
- Do not mix old and new or different types of batteries.
- Remove exhausted batteries from the controller.
- Supply terminals are not to be short circuited.

Store and Dispose of Batteries and Electrical/Electronic Materials Properly

- Batteries may explode or leak or cause burn injury if recharged, disposed of in fire, mixed with a different battery type, inserted backwards or disassembled.
- Never store, put or throw batteries into a flame or in a heated place.
- Do not carry batteries in your pocket or purse.
- Do not remove the battery label.



● Check your local laws, contact the proper government authorities or look under the Government listings of your local area directory to see if there are any special battery disposal instructions or requirements that apply where you live. For rechargeable or other types of batteries, the manufacturer should provide proper disposal instructions and you should always read and follow the manufacturer's directions to avoid injury and damage and to comply with the laws and regulations protecting health, safety and the environment.

There have been some studies which are considered by some to raise questions about the potential health effects of electrical and electronic equipment and some of the hazardous substances they may contain. Always consult your own health care professionals who can advise you regarding your own health care needs in relation to use of the controller, batteries or other parts of the game.

- Consumers have a role to play in recycling. The waste bin symbol with a strike mark through it indicates you should not dispose of waste electrical/electronic equipment, including batteries, as municipal or routine waste. Handle their disposal or recycling separately and properly.
- If you are not sure how to properly dispose of or recycle any of these items, you may contact Electronic Arts at <http://rockbandservice.ea.com> or contact your local government officials for information in your area.

© 2009 Harmonix Music Systems, Inc. All Rights Reserved. The Beatles: Rock Band developed by Harmonix Music Systems, Inc. Harmonix, Rock Band and all related titles and logos are trademarks of Harmonix Music Systems, Inc., an MTV Networks company. MTV: Music Television, MTV Games and all related titles and logos are trademarks of MTV Networks, a division of Viacom International Inc. The Beatles and all related titles and logos are trademarks of Apple Corps Ltd. EA and the EA logo are trademarks or registered trademarks of Electronic Arts Inc. in the U.S. and/or other countries. 'Hofner' and the design of the Hofner bass guitar are the trademarks of KARL HÖFNER GmbH & Co. KG, Germany. All rights reserved. LUDWIG is a registered trademark of Conn-Selmer, Inc., and is used under license. All other marks are the property of their respective owners.

Trademarks are property of their respective owners. Wii is a trademark of Nintendo

This product and its use may be covered by U.S. Patent Number 7,320,643 and patent applications pending.

Controllers manufactured by:
Harmonix Music Systems Inc.
625 Massachusetts Avenue
Cambridge, MA 02139
United States of America

Controllers imported by:
(North America)
Electronic Arts Inc.
209 Redwood Shores Parkway
Redwood City, California 94065
United States of America

(other territories)
EA Swiss Sàrl
Place du Molard 8
1204 Geneva
Switzerland