

QUICK REFERENCE TABLE

Maximum shift at f/16, image format 55 x 55 mm and no tilt

Maximale Shift-Verstellung bei f/16, Bildformat 55 x 55 mm und ohne Schwenk-Verstellung

Deslizamiento máximo en f/16, formato de imagen 55 x 55 mm, sin inclinación

Decentrament maximum a f/16, format d'imatge 55 x 55 mm et sans bascule

Massimo decentramento a f/16, formato d'immagine 55 x 55 mm, senza basculaggio

Maximum shift bij f/16, beeldformaat 55 x 55 mm en geen tilt

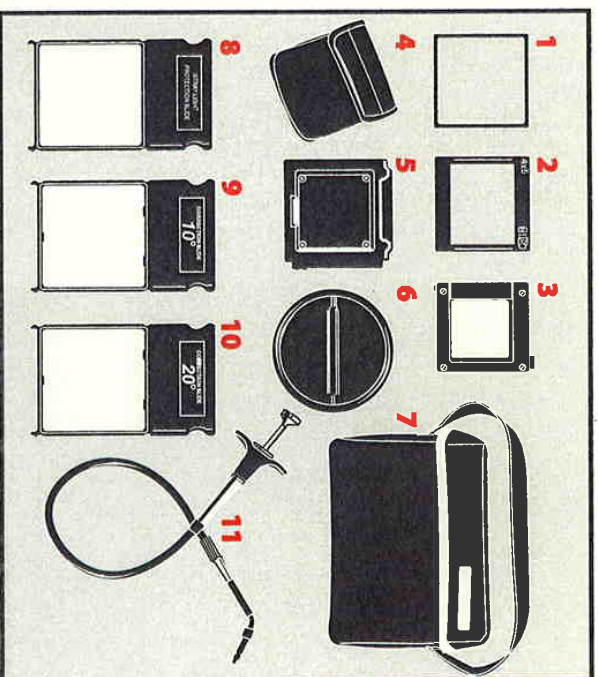
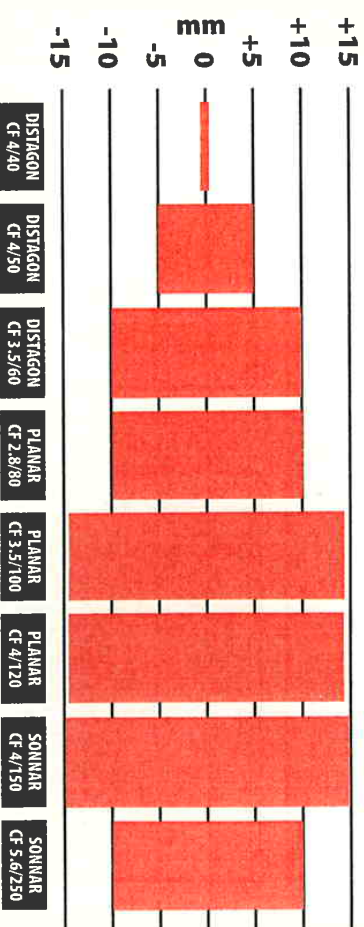

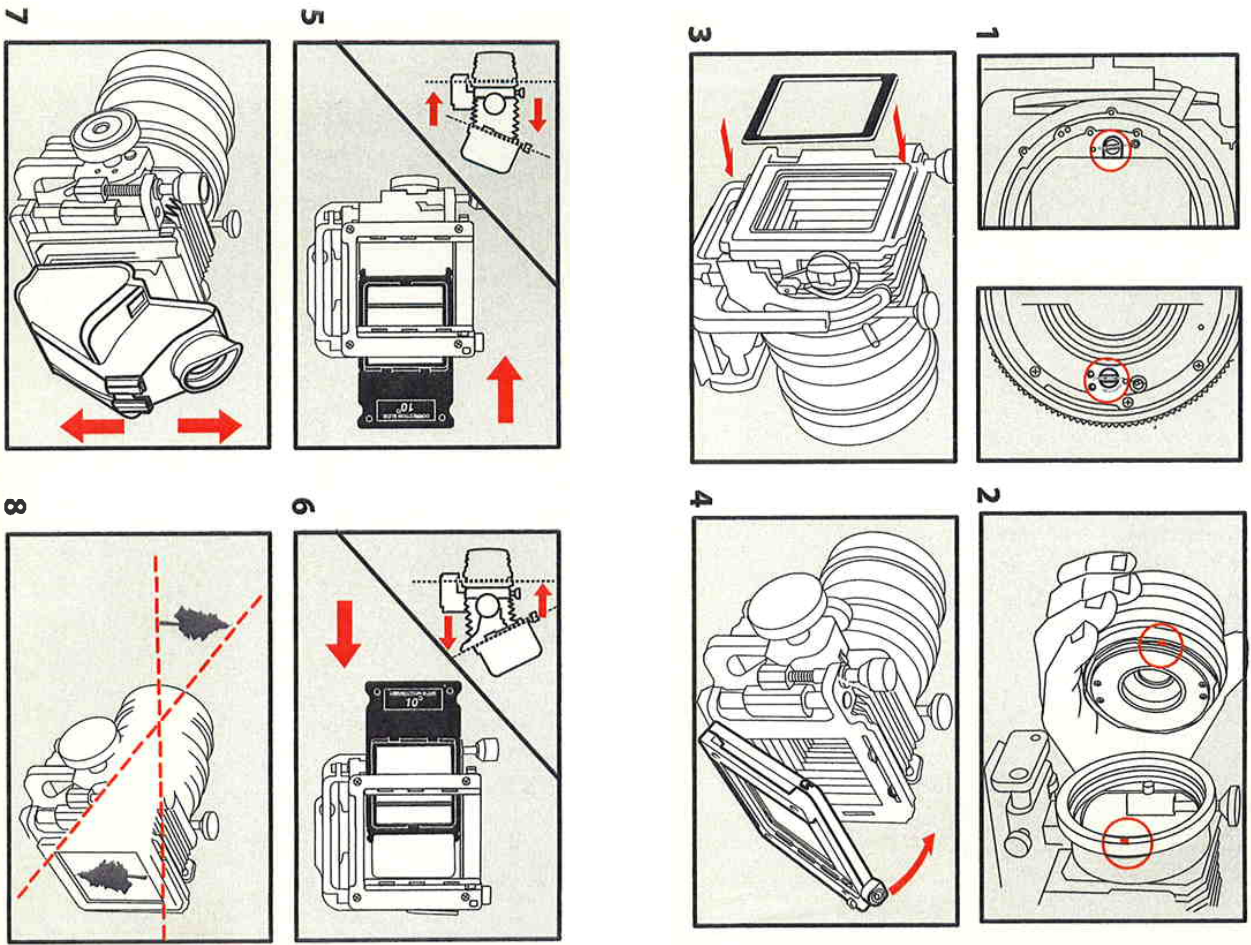

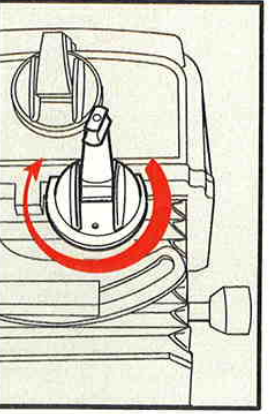
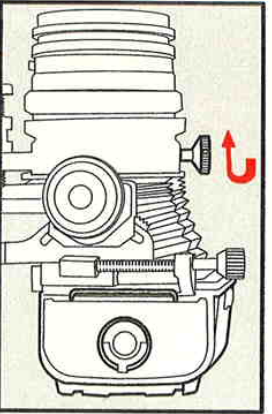
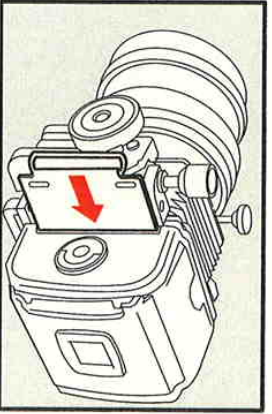
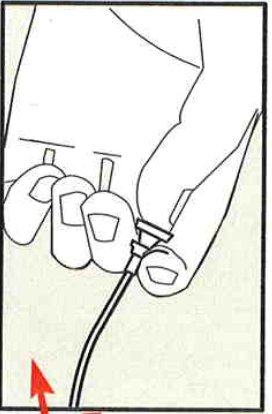
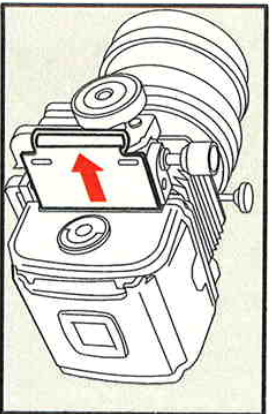
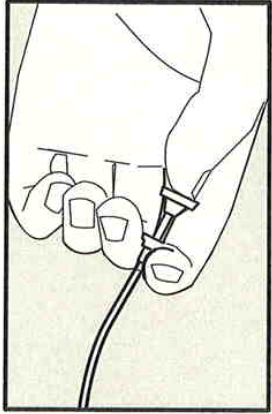

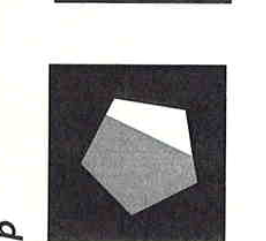
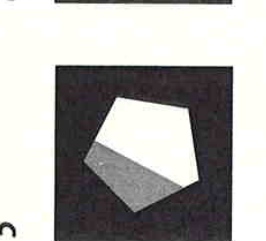
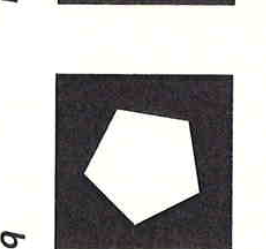
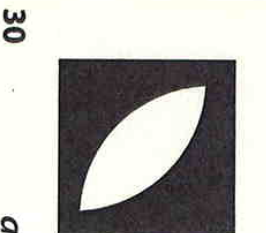
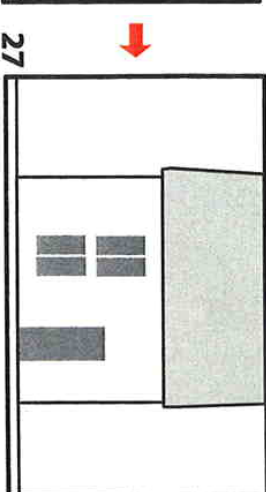
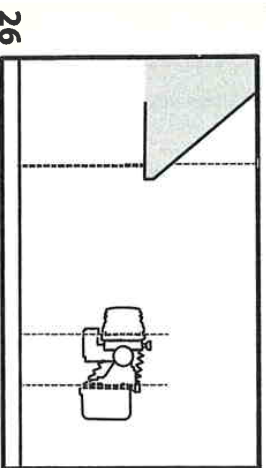
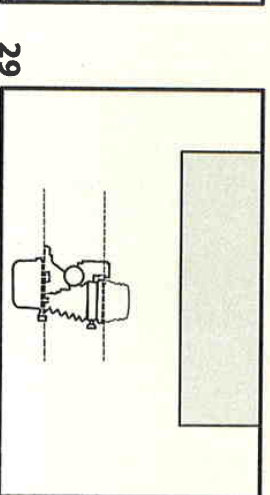
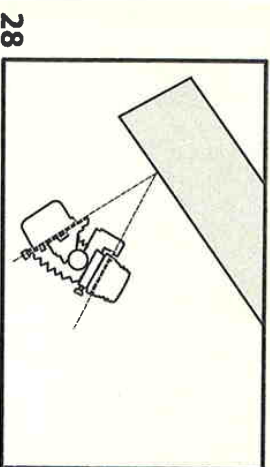
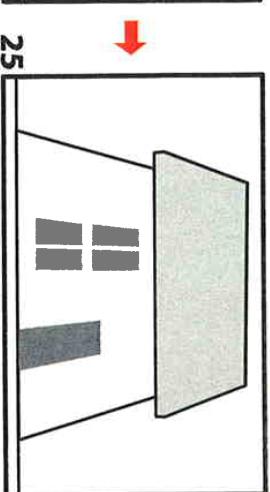
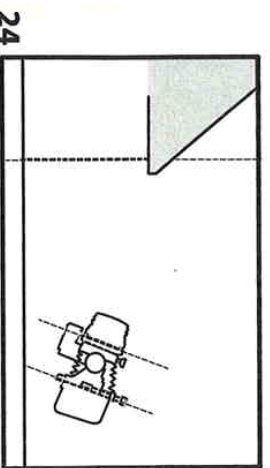
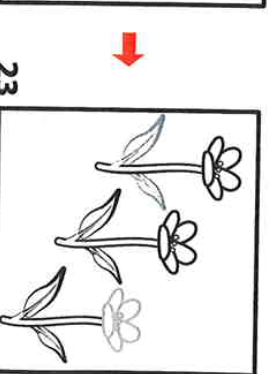
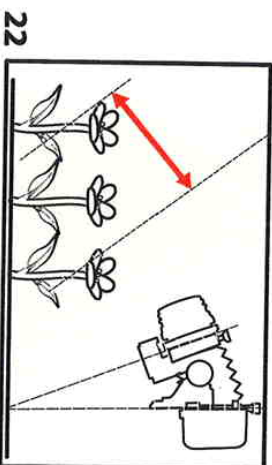
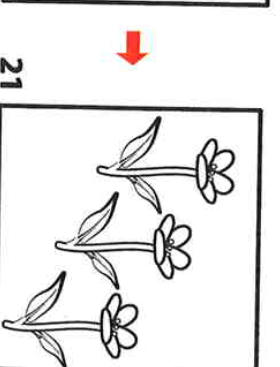
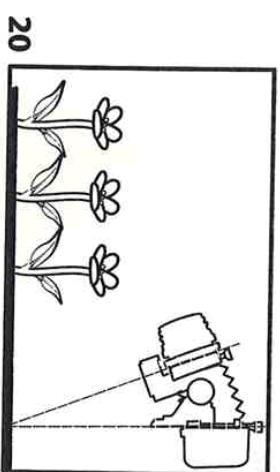
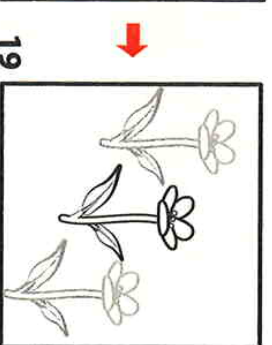
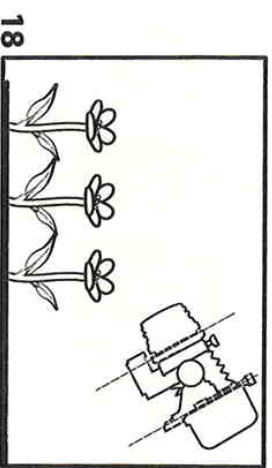
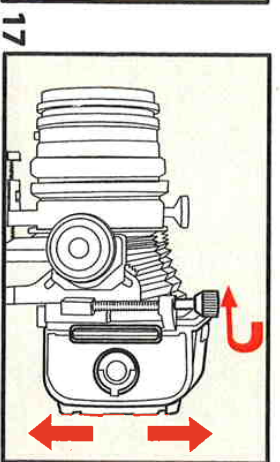
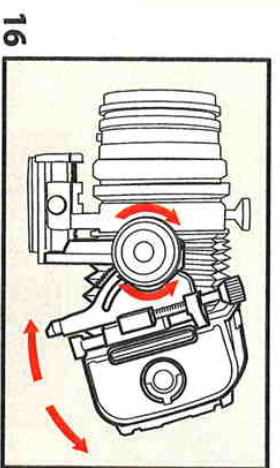



H A S S E L B L A D

FlexBody

Instruction Manual, Gebrauchsanweisung, Manual de Instrucciones, Manual d'Instructions, Manuale d'Istruzioni, Gebruiksaanwijzing, Bruksanvisning

Hasselblad FlexBody

The Hasselblad FlexBody bridges the gap between two photographic systems. It combines the compactness, ease-of-use and economy of the medium format with some of the versatility and controls that normally only view camera users enjoy.

Significant image adjustments can easily be made, not only for image corrections but also creative effects. The FlexBody therefore appeals to a wide variety of photographers involved in advertising, architectural, scientific, nature photography and beyond. Most types of work can benefit from what the FlexBody offers in terms of image control by broadening the photographer's scope for both technically challenging photography and creative expression.

The FlexBody was conceived around two basic photographic concepts familiar to view camera users, namely, 'tilt' and 'shift'.

The tilt facility allows a change in the angle of the film plane in regard to the lens. The result of this action causes an apparent change in the depth of field without having to resort to a change in the lens aperture.

The shift facility allows a change in position of the film plane with regard to the projected image while maintaining the same angle. The result of this action can be that converging verticals, for example, in an image can to a certain extent be corrected.

The FlexBody also boasts an integral continuously variable bellows extension providing a valuable close-up facility without the need for additional equipment. Digital photography is also catered for with a variety of different models on the market that simply replace the conventional film magazine.

Altogether, the FlexBody offers a combined versatility that many photographers will greatly appreciate.

Needless to say, the FlexBody follows on in the tradition of the Hasselblad philosophy by ensuring complete compatibility within the system. All Zeiss CF and C lenses, Hasselblad film magazines and viewfinders are compatible and attach to the FlexBody without any need for adapters.

The FlexBody is light and compact, making it a very useful addition to your outfit, both in the studio and out on location.

This instruction manual describes in detail how to operate your FlexBody and covers most questions that should arise about its use. Please read it carefully and keep it with FlexBody at all times for reference. It has been designed to fit the FlexBody carrying case and features fold-out illustrations to facilitate the

explanation of features and sequences. There is also a pocket-sized folder supplied which outlines basic procedures.

The manual assumes a certain familiarity with the Hasselblad system regarding the fitting and removal of items common to both Hasselblad cameras and the FlexBody such as film magazines, viewfinders, protective covers, etc. Where any such operation differs from the normal Hasselblad routine, it is pointed out.

Each section begins with a sketch of the placing of the illustrations that are relevant to that particular section.

The knowledge gained from this manual will give you full access to the Hasselblad FlexBody potential. Exploiting the potential is left to your imagination!

Index

- i. Introduction
- iii. FlexBody components
 - 1. Accessories
 - 2. Getting Started
 - 3. The Focusing Screen Adapter & Correction Screens
 - 5. Basic Operation
 - 6. Exposure Sequence
 - 8. FlexBody Movements
 - 10. Camera Movements in Practice
 - 12. The Rear cover MultiControl
 - 13. Digital Photography
 - 14. Troubleshooting
 - 15. Service & Guarantee
 - 16. Technical Specifications

The focusing screen system and accessories that are supplied with the FlexBody consist of:

1. **Stray light protection mask.** Used to prevent stray light from dulling the image when large amounts of shift and/or tilt are put into effect. (Supplied already fitted to rear standard).
2. **Format mask 4x5 cm.** Used both as a compositional aid and as a film mask to avoid vignetting. It is advisable to ensure that the mask has been inserted when the shift facility is to be used and especially when using lenses of focal lengths from 40mm – 60mm, inclusive.
3. **Focusing screen adapter.** This device not only provides the viewing system for the FlexBody but also serves as a holder for the correction screens and viewfinders.
4. **Case for Focusing screen adapter and correction screens.**
5. **Rear cover MultiControl.** With integral vignetting control facility.

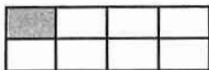

Getting Started

The FlexBody is supplied with a front protective cover and a Rear cover MultiControl. They are attached and removed in the same manner as with a conventional Hasselblad camera. When storing the FlexBody without lens or focusing screen it is advisable to keep the covers in place for protection.

Attaching a lens

When attaching a lens, make sure that it is fully wound. Fig. 1 shows the correct relationship between the drive shaft, the lens drive coupling and their indexes.

If the lens is not wound, you can insert a coin in the coupling slot and rotate it clockwise until it locks (about 4/5 of a turn). When you have aligned the red index on the lens with the red index on the FlexBody as shown in fig 2, the lens will drop easily into the bayonet fitting. You can then rotate it clockwise until it stops with a faint click as the lens catch locks it in place.

FlexBody Components

- | | |
|--------------------------|----------------------------------|
| 1. Rear standard | 13. Shutter winding knob |
| 2. Winding crank lock | 14. Cable release port |
| 3. Shift index | 15. Shift control knob |
| 4. Winding crank | 16. Lens extension locking screw |
| 5. Tilt index | 17. Quick-coupling plate |
| 6. Front standard | 18. Tripod thread 1/4 in. |
| 7. Drive shaft | 19. Tripod thread 3/8 in. |
| 8. Lens release lever | 20. Magazine supports |
| 9. Lens extension wheel | 21. Stray light protection mask |
| 10. Lens alignment index | 22. Support hooks |
| 11. Tilt control lock | |
| 12. Tilt control knob | |

Accessories

6. **Front protective cover.**
7. **Carrying case.**
8. **Stray light protection slide.** Used to prevent stray light from dulling the image on the focusing screen when no correction screen has been inserted.
9. **Correction screen 10°.** Used to improve screen image brightness when tilt adjustment is between 10° and 20°.
10. **Correction screen 20°.** Used to improve screen image brightness when tilt exceeds 20°.
11. **Cable release.** There is no release button on the FlexBody. The cable release provides a smooth and vibration free action when making an exposure. It is supplied with an open L-connector to facilitate use.

1

Removing a lens

Depress the lens release button and rotate the lens counter-clockwise until it stops and lift it out of the mount.

Fitting the format mask

First remove the stray light mask from the recess in the rear standard. Then fit the format mask into the same recess with the smooth, inscription side facing you (in other words, so that it can be read) as in fig. 3. It can be aligned in either direction and is simply pressed into the recess provided until it is level with the rear standard. Replace the stray light mask after removing the format mask. Again, ensure that the smooth side is facing you.

- ! Note the orientation of the lens in relation to the FlexBody in fig. 2. This orientation differs from the conventional lens / camera body attachment positions (for vignetting reasons).
- ! You can only remove the lens when the shutter is fully wound.
- ! When fitting the format mask, focusing screen adapter and correction screens, ensure that you would be able to read the inscriptions on them when viewed from behind the camera.
If you see no inscription, then you are fitting the accessory incorrectly!
- ! The straylight mask should be fitted at all times when the format mask is not fitted.

The Focusing Screen Adapter & Correction Screens

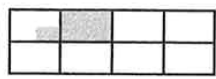

The Focusing Screen Adapter

Rest the focusing screen adapter on the FlexBody's magazine supports fig. 4, ensuring that it is properly located. Carefully swing it towards the FlexBody, checking that the upper support hooks on the camera body fit into the slots in the adapter. Push it against the hooks while depressing the focusing screen adapter release catch.

To remove, depress the focusing screen adapter release catch and swing the top of the adapter back away from the camera body while lifting it off the lower supports.

Fitting Correction Screens

When tilting the top of the back *away* from the lens as in fig. 5, the correction screens should be inserted from the **right** side of the focusing screen adapter with the inscription visible when viewed from behind the camera.

However, when tilting the top of the back *towards* the lens as in fig. 6, the correction slides should be inserted from the **left** side of the focusing screen adapter with the inscription visible when viewed from behind the camera.

In both cases the correct screen is chosen according to the amount of tilt applied:

Correction Screen 10°

For use when the angle of tilt is greater than 10° but less than 20°.

Correction Screen 20°

For use when the angle of tilt is greater than 20°.

Viewfinders

All viewfinders in the Hasselblad system will fit the focusing screen adapter. They are simply slid down into position for attachment and upwards for removal (fig. 7).

An additional -1 dioptre correction is recommended when the standard focusing hood is used.

If you are using a PME viewfinder and you want to use the metering facility you should temporarily remove any correction screen and set the tilt control to zero to improve metering accuracy.

Polaroid® Magazine

The use of a Polaroid® magazine with the FlexBody presents no problems though it is advisable to stop the lens down to f/11 or f/16 when a large amount of tilt is put into effect.

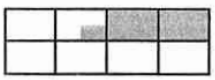

Basic Operation

With the lens and the focusing screen adapter attached to the FlexBody, the combination becomes a complete camera. It behaves in the same manner as a view camera in the sense that a direct inverted image is formed on the focusing screen, and that a film magazine has to be attached where the focusing screen is situated. The conventional Hasselblad routines regarding operation therefore do not apply though you should find certain aspects very familiar. Read through the description that follows to familiarise yourself with the basic operation before moving on to the later sections on camera movements.

1. It is advisable to adjust the camera position on the tripod or stand using the integral spirit level. This ensures that the back is vertical and simplifies the need for further adjustments when working with architectural perspective control, for example.
2. After making your lens choice, check with the table on the illustration fold-outs to see how much shift is permissible.

3. Screw the cable release into the cable release port, with or without the open L-connector.
4. Rotate the shutter winding knob clockwise one full turn, to wind and open the shutter.
5. Insert format mask, if necessary.
6. Compose the photograph, carefully observing the changes in the image on the focusing screen as you make the necessary adjustments. If appropriate (that is, when shifting the camera back or even when using lens accessories), remove the focusing screen adapter and replace with the Rear cover MultiControl to check for possible vignetting problems, see page 12. If necessary, replace the focusing screen adapter to make necessary readjustments.
7. Lock tilt control and lens extension control knobs.
8. Press cable release to first position to close shutter.
9. Remove the focusing screen adapter.
10. Ensure that the film magazine indicator is white. If the indicator is red, the magazine will have to be wound one full revolution after it has been attached to the camera unless you are going to make a multiple exposure.
11. Rest the magazine on the magazine supports, ensuring it is

properly located on them. Carefully swing the magazine toward the camera body and check that the camera's upper support hooks fit into the slots in the magazine. Push the magazine gently but firmly against the hooks while pushing the magazine catch to the right.

12. Release the catch when the magazine has made contact with the rear standard, and push it to the left to ensure that it has reached the locked position. Remove the magazine slide.
13. Make the exposure by pressing the cable release all the way in.
14. Advance the film.
15. Insert the magazine slide fully with the grip towards the front of the camera. Push the magazine catch to the right, swing the magazine back and lift it off the lower supports.



now be readable on the shutter winding knob (instead of **OPEN**).

You may want to practise this a little without a film magazine attached.

See fig. 9 for how the text on the knob denotes the camera status.

OPEN (red - stop) = The shutter and aperture are both open so that an image can be formed on the focusing screen. Do not attach a magazine and withdraw slide.

CLOSE (green - go) = The shutter is closed. A magazine may now be attached, the slide safely removed and an exposure made.

EXPOSE (black - neutral) = The shutter has fired (or is still open if a time exposure is being made and the cable release remains depressed).

OPEN/EXPOSE/CLOSE = The exposure sequence is complete. The shutter is closed and released.

The FlexBody exposure sequence is illustrated in fig. 10-15 and is as follows:

Remember:



Do not forget to reinsert the magazine slide before you rewind the shutter.



The conventional Hasselblad routines, with multi-exposure safeguards built into the mechanism, do not apply.



Do not forget to advance the film before removing the magazine.

Exposure Sequence

| | | | |
|--|--|--|--|
| | | | |
| | | | |

The exposure sequence requires that you press the cable release all the way down in order to activate the various stages of the procedure. However, this must be done in two stages in order to be able to attach the film magazine.

The text on the top of the winding knob is to be read when viewed from behind the camera. The knob automatically rotates for each stage of the exposure sequence and signifies the current lens status. All exposure controls are governed by settings on the lens.

After picture composition and exposure setting, press the cable release to its first position.

By pressing the cable release part way, but no further, the aperture closes to the required setting and the shutter closes in preparation for magazine attachment. The text **CLOSE** will

10. Depress cable release part way to close the shutter. If you unintentionally press the release all the way down and complete the sequence, you only have to rewind the shutter and depress the cable release again. As the slide has not yet been removed from the magazine you have not lost a film frame!
11. Remove slide from magazine.
12. Depress cable release again, this time to fire the shutter.
13. Reinsert the magazine slide.
14. Rewind the shutter.
15. Advance the film one frame by depressing the locking catch and winding the crank by one revolution.

While certain parts of this routine can be changed, for example you may advance the film before replacing the magazine slide, other parts may not. Rewinding the shutter before replacing the magazine slide will cause you to lose a film frame, either the one you have just exposed, or if you have already wound the film on, the one you are about to expose.

It is therefore very important to follow a correct routine that suits you.

7

FlexBody Movements

| | | | |
|--|--|--|--|
| | | | |
| | | | |

The Hasselblad FlexBody has two movement controls plus an integral bellows extension for close-up work. The two movement controls are tilt and shift and it is these two movements that the FlexBody utilises to exercise control over sharpness and image shape.

The amount of movement needed varies according to the desired effect, there is no formula and each case must be judged accordingly by what is seen on the viewing screen. Certain restrictions apply however, in particular according to which lens is being used. The table on the illustration fold-outs demonstrates the amount of movement possible before vignetting occurs.

After a description of how these movements can be made on the FlexBody in particular there is a short general description of camera movements in practice and their effect on the image.

Tilt

Mount the FlexBody on a stand or tripod and set up as previously described on page 5.

You may wish to ensure that the camera is level if photographing a building, for example, and this can be achieved by using the integral spirit level.

The camera is tilted simply by loosening the tilt control knob lock and then rotating the knob, fig 16.

A clockwise movement of the knob causes the top of the rear standard to move towards the lens and the bottom of the rear standard to move away from the lens.

Rotating the knob in a counter-clockwise manner will produce the opposite effect.

The tilt index displays how much tilt has been put into effect, approx. $\pm 28^\circ$ being possible.

Use the appropriate correction screen (see page 4), if necessary, to improve the brightness of the image.

Lens Extension Control

To extend the lens bellows for close-up photography, loosen the lens extension locking screw and rotate the lens extension wheel clockwise (when standing behind the camera).

The lens can be extended up to 22mm.

The bellows is made of natural fabric and is designed to permit a combination of tilt, shift and extension movements.

However a combination of maximum settings, such as 14 mm shift and 28° tilt together, should be avoided as this may cause the bellows to distort.

It is also advisable to keep the bellows extension retracted to the neutral (0-) position when not in use.

10

sharpness for the lens at that specific focusing position. (Remember the image is inverted!) Likewise, the distance of the lower part of the film plane to the far limit has now decreased, also allowing it to fall into the zone of acceptable sharpness.

In practice, care must be taken. When the back of the camera is moved in this manner, the plane of sharp focus is angled away from vertical objects. Fig. 22-23 illustrates this effect. While objects in the image that lie close to the camera are now sharper, the tops of taller objects may now be less sharp because they have now fallen out of the zone of acceptable sharpness.

Shift

Apart from lens effects, image shape distortion can be caused by the film plane not being parallel to the relevant plane within the image. A common occurrence is found when photographing the front of a building, for example. With the camera at ground level and close to the building, it is often necessary to angle the camera upwards so as not to miss the top of the building, fig 24-25. It then appears that the top of the building is narrower than the base.

Shift

To raise the camera back, rotate the shift control knob in a counter-clockwise manner.

To lower the back, rotate the shift control knob in a clockwise manner, fig. 17.

The back can be shifted approx. ± 14 mm.

Shifting the back is subject to the limits of the chosen lens regarding the possibility of vignetting.

Wide angle lenses are particularly susceptible to this effect and careful study both with the Rear cover MultiControl and the focusing screen is advisable.

On the fold-out illustrations, you will find a table showing the amount of shift possible with Hasselblad lenses before vignetting occurs.

9

Camera Movements in Practice

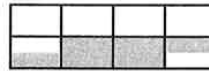

Tilt

Depth-of-field – the zone of an image that is acceptably sharp – is controlled by the aperture setting. The angle of the plane of this zone, however, can be altered to achieve greater sharpness in the image.

Fig. 18-19 illustrates a landscape photograph. When maximum depth-of-field is required, parts of the subject close to and far away from the camera (the near and far limits respectively) remain unsharp, even with the lens set at the hyperfocal distance. The problem is caused by the distances between the near and far limits and the film plane at that focus setting.

The solution to the problem is to alter these distances. In fig. 20-21 you can see that by tilting the back of the camera, the distance from the top of the film plane to the near limit has now increased, thereby allowing it to fall into the zone of acceptable

The solution to this problem would be to move the lens upwards in relation to the film plane, while ensuring that all three planes - building, lens and film plane - remain parallel to each other.

Fig. 26-27 demonstrates this idea in practice. Shifting of the camera body, and thereby the film plane, downward causes this to occur in a relative manner.

There are limitations, however. Each lens has a specific circle of coverage, that is to say, a circle of even illumination of the projected image at the film plane. Some lenses have a large circle and can therefore allow a moderate amount of film plane placement within that circle before a fall-off in light is noticed. Others have a much smaller circle and therefore provide very little in the way of movement. Both shift and tilt can be used together to provide a combined effect, bearing in mind the previously mentioned limitations.

If the camera is turned 90° onto its side, similar problems occurring in the horizontal plane may be resolved. For example, fig. 28 illustrates that while photographing the length of a building, the whole of the facade at angle to the camera may be in focus at one time without resorting to stopping the lens down excessively.

11

Likewise, fig 29, illustrates how the right hand side of a building facade could be included while remaining undistorted by shifting the back when the camera's position cannot be changed.

The photographic situations just mentioned are normally considered as faults which have to be corrected. However the very same visual changes can also be classified as creative additions and can be used to positive effect.

For instance, in the example already mentioned concerning the lack of depth-of-field in a landscape, you may wish to photograph the same scene but this time greatly reduce the depth-of-field. This can be done by tilting the camera back the opposite way, that is to say, the top of the camera back towards the camera body. The effect would be to isolate one part of the scene within a zone of sharpness, while throwing the remainder of the scene into varying degrees of softness.

Similarly, you may wish to increase the convergence of verticals in a building, for example, for dramatic effect. By shifting the back upwards, the camera would have to be pointed upwards at an even greater angle to include the top of the building, thereby exaggerating the convergence effect.

12

As a quick and efficient check against vignetting, proceed as follows:

1. Set up the camera and complete picture composition as normal with any filter or lens shade in position.
2. Remove the focusing screen adapter.
3. Replace with the Rear cover MultiControl.
4. Depress the depth-of-field button on the lens so that the lens stops down to the working aperture.
5. Look through each hole in the Rear cover MultiControl in the direction of the lens and compare what you can see with the illustrations, fig 30.
6. Experiment to find whether it is the degree of shift applied and/or an accessory that is causing the problem.

Illustrations

- a. The aperture is fully open. No vignetting will occur.
- b. The lens has been stopped down to the working aperture producing the ideal situation. No vignetting will occur.
- c. The lens has been stopped down to the working aperture but

While it is not intended that the FlexBody should have all of the possible movements that some view cameras have, you may wish to reading relevant articles about camera movements in the photographic literature. They should provide you with a deeper insight into the concepts that lay behind what takes place, and in doing so broaden your scope to be able to take on technical and creative challenges.

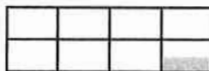

The Rear cover MultiControl

The Rear cover MultiControl has a vignetting control facility in the form of four holes, positioned at each corner of the frame.

As vignetting can not only be caused by shifting the lens but also incorrectly positioned or adjusted accessories such as lens shades, filter holders, etc, a check on the FlexBody Quick Reference table may not be sufficient.

vignetting is starting to occur. However this amount is acceptable for a vignette free result.

- d. The lens has been stopped down to the working aperture and more than 50% has been covered. Vignetting will occur and will produce a visible result.

The FlexBody and Digital Photography

The FlexBody can be used with digital imaging backs. Your Hasselblad dealer or distributor will have more information about compatibility.

Some digital backs attach directly to the FlexBody in the same manner as a film magazine while others make use of an adapter plate of some kind. Follow the manufacturer's recommendations for attachment.

13

Troubleshooting

You cannot attach the lens.

Lens or FlexBody not wound.

You cannot remove the lens.

Same as above.

There is no image on the focusing screen.

Lens cap still in place. Shutter unwound.

Tilt control knob/lens extension wheel cannot be moved.

Release appropriate locking screws.

The image is dark when the back is tilted.

Insert appropriate correction screen.

The image becomes very unsharp when a correction screen is inserted.

Correction screen inserted incorrectly.

The image is dark at the corners of the focusing screen.

Vignetting has occurred.

Shutter will not fire when cable release is pressed.

Shutter has not been wound.

Film frames have been fogged.

Magazine slide removed while shutter still open.

Shutter rewound before magazine slide replaced.

EQUIPMENT CARE

The Hasselblad FlexBody is designed to withstand the rigours of professional use in most environments. In order to avoid the possibility of damage however, it should be protected from the following.

Extremes of temperature. High temperatures can have an adverse effect on both the film and the equipment. Try to avoid frequent and severe temperature changes.

Dust and grit. You should take care to prevent dust and grit from getting into your equipment. In coastal areas take measures to protect your equipment from sand and salt water spray.

Dust on the lens glass and focusing screen can be removed with a blower brush or very soft lens brush if necessary. Smears on the lens glass should be treated with great care. In some cases they may be removed with a high quality lens cleaning solution on a tissue but be careful not to scratch the lens or touch any of the glass surfaces with your fingers. If in any doubt, do not attempt to clean lens glass surfaces yourself.

Impact. Your equipment can be damaged by severe physical shocks so practical protective precautions should be taken. The

bellows section of the FlexBody is particularly vulnerable to physical damage and care should be exercised in the vicinity of pointed or sharp objects. The FlexBody is best stored with the bellows withdrawn and the shift and tilt in the neutral position.

SERVICE

You should return your equipment to a Hasselblad service centre for occasional checking and preventive maintenance to ensure optimal reliability. If your camera is used constantly and intensively, periodic check-ups every six months are recommended at one of the "Hasselblad Authorised Service Centers." They have the expert staff and specialised equipment necessary to ensure that your FlexBody remains in perfect working order.

GUARANTEE

Provided that you bought your equipment from an Authorised Hasselblad outlet, it is covered by an international guarantee for one year. The guarantee document and a registration card are supplied with the FlexBody. Keep the guarantee document carefully, but fill in the registration card and return it to your Hasselblad distributor.

Technical Specifications – FlexBody

| | |
|----------------------------|---|
| Body type: | Technical, with a tiltable and shiftable back. |
| Design: | Mechanical, with controls for tilt and shift. |
| Film advance: | Manual advance with winding crank. |
| Tripod coupling: | 1/4" and 3/8" socket threads and base plate for quick coupling attachment. |
| External dimensions: | 110x140x140 cm (4.2x5.5x5.5") – LxWxH. |
| Weight: | 700 g (1.5 lb). |
| Focusing screen: | Acute Matte Screen with two correction screens (patent pending) |
| Back shift / tilt control: | Shift: max. \pm 14 mm (vertical) Tilt: max. \pm 28° (vertical plane tilt) |
| Lens extension: | 22 mm, built-in. |
| Shutter winding: | Manual |
| Compatibility: | All Hasselblad prism viewfinders with or without a built-in light meter or magnifying hood. 15 interchangeable CF lenses, with built-in leaf shutters providing flash synchronization at all speeds from 1 to 1/500 s. The 6x6 cm (2 1/4 x 2 1/4") and 6x4.5 cm (2 1/4 x 1 5/8") format magazines. Film types 120, 220, 70mm double perforated film, sheet, and Polaroid® film. |