

HEALTHRIDER®

S O F T S T R I D E R

S400

Model No. HRTL10980

Serial No. _____

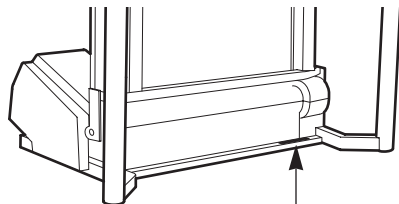

Serial Number Decal

QUESTIONS?

As a manufacturer, we are committed to providing complete customer satisfaction. If you have questions, or if there are missing or damaged parts, we will guarantee complete satisfaction through direct assistance from our factory.

TO AVOID UNNECESSARY DELAYS, PLEASE CALL DIRECT TO OUR TOLL-FREE CUSTOMER HOT LINE. The trained technicians on our customer hot line will provide immediate assistance, free of charge.

CUSTOMER HOT LINE:

1-800-999-3756

Mon.–Fri., 6 a.m.–6 p.m. MST

⚠ CAUTION

Read all precautions and instructions in this manual before using this equipment. Save this manual for future reference.



USER'S MANUAL



TABLE OF CONTENTS

IMPORTANT PRECAUTIONS	3
BEFORE YOU BEGIN	5
SETTING UP THE TREADMILL	6
GROUNDING INSTRUCTIONS	7
CONSOLE OPERATION	8
HOW TO FOLD AND MOVE THE TREADMILL	16
TROUBLE-SHOOTING AND MAINTENANCE	17
CONDITIONING GUIDELINES	19
ORDERING REPLACEMENT PARTS	Back Cover
LIMITED WARRANTY	Back Cover

Note: An EXPLODED DRAWING and a PART LIST are attached in the center of this manual. Please save them for future reference.

IMPORTANT PRECAUTIONS

⚠ WARNING: To reduce the risk of burns, fire, electric shock, or injury to persons, read the following important precautions and information before operating the treadmill.

1. It is the responsibility of the owner to ensure that all users of this treadmill are adequately informed of all warnings and precautions.
2. Use the treadmill only as described in this manual.
3. Place the treadmill on a level surface, with eight feet of clearance behind it. Do not place the treadmill on any surface that blocks air openings. To protect the floor or carpet from damage, place a mat under the treadmill.
4. Keep the treadmill indoors, away from moisture and dust. Do not put the treadmill in a garage or covered patio, or near water.
5. Do not operate the treadmill where aerosol products are used or oxygen is administered.
6. Keep children under the age of 12 and pets away from the treadmill at all times.
7. The treadmill should not be used by persons weighing more than 250 pounds. Never allow more than one person at a time on the treadmill.
8. Wear appropriate exercise clothing when using the treadmill. Do not wear loose clothing that could become caught in the treadmill. Athletic support clothes are recommended for both men and women.
9. Always wear athletic shoes when using the treadmill—never use the treadmill with bare feet, wearing only stockings, or in sandals. For maximum walking belt life, never use shoes with heavy treads.
10. When connecting the power cord (see page 7), plug the power cord into a surge protector (not included) and plug the surge protector into a grounded circuit capable of carrying 15 or more amps. No other appliance should be on the same circuit.
11. Use only a UL-listed surge protector, rated at 15 amps, with a 14-gauge cord of five feet or less in length. Do not use an extension cord.
12. Keep the power cord and the surge protector away from heated surfaces.
13. Never move the walking belt while the power is turned off. Do not operate the treadmill if the power cord or plug is damaged, or if the treadmill is not working properly. (See BEFORE YOU BEGIN on page 5 if the treadmill is not working properly.)
14. Never start the treadmill while you are standing on the walking belt.
15. Always hold the handrails when walking or running on the treadmill.
16. The treadmill is capable of high speeds; adjust the speed in small increments to avoid sudden jumps in speed.
17. To reduce the possibility of the treadmill overheating, do not operate the treadmill continuously for longer than one hour.
18. Never leave the treadmill unattended while it is running. Always remove the key and move the on/off switch to the off position when the treadmill is not in use. (See the drawing on page 5 for the location of the on/off switch.)
19. Never insert any object into any opening.
20. When operating the treadmill, keep hands and feet from underneath the treadmill.
21. You must be able to safely lift 45 pounds (20 kg) to raise, lower, or move the treadmill.
22. When folding or moving the treadmill, make sure that the storage latch is fully engaged.
23. Inspect and tighten all parts of the treadmill every three months.

24. Always unplug the power cord before performing the maintenance and adjustment procedures described in this manual. Never remove the belly pan unless instructed to do so by an authorized service representative. Servicing other than the procedures in this

manual should be performed by an authorized service representative only.

25. The treadmill is intended for in-home use only. Do not use the treadmill in any commercial, rental, or institutional setting.

⚠ WARNING: Before beginning this or any exercise program, consult your physician. This is especially important for persons over the age of 35 or persons with pre-existing health problems. Read all instructions before using. ICON assumes no responsibility for personal injury or property damage sustained by or through the use of this product.

SAVE THESE INSTRUCTIONS

The decals shown below and to the right have been placed on your treadmill. If a decal is missing, or if it is not legible, please call our Customer Service Department toll-free at 1-800-999-3756 to order a free replacement decal. Apply the decal in the location shown.

IMPORTANT:
Incline must be set at lowest level before folding treadmill into storage position.

⚠ WARNING

- Never allow children on or around treadmill.
- Storage latch must be fully engaged before treadmill is moved or stored.

⚠ WARNING

KEEP HANDS AND FEET AWAY FROM THIS AREA WHILE THE TREADMILL IS IN OPERATION.

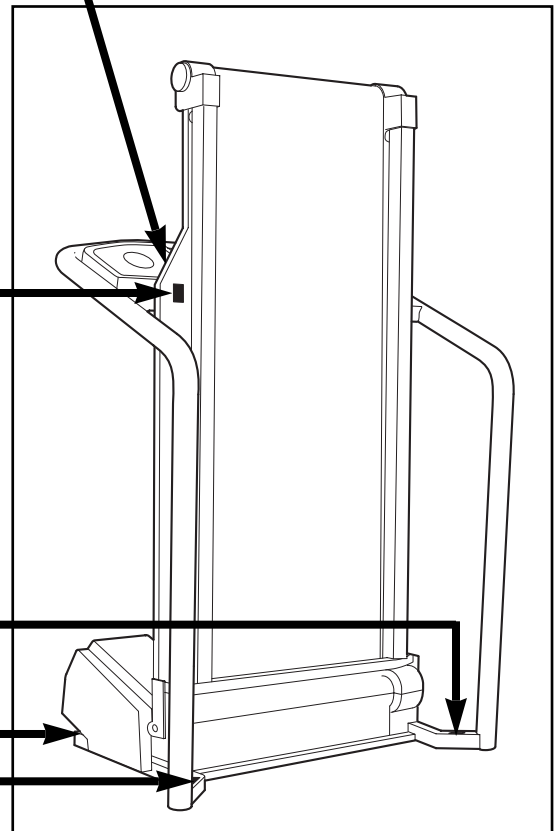

BEFORE YOU BEGIN

Congratulations for purchasing the SOFTSTRIDER S400™ treadmill by HealthRider. The SOFTSTRIDER S400 offers an impressive array of features that will help you to achieve your fitness goals in the convenience of your home. From the advanced console to the ultra-soft walking belt, the SOFTSTRIDER S400 is designed to make each workout more effective and enjoyable. And when you're not exercising, the SOFTSTRIDER S400 can be folded away, taking less than half the space of conventional treadmills.

For your benefit, read this manual carefully before using the SOFTSTRIDER S400 treadmill. If you have

additional questions, please call our Customer Service Department toll-free at 1-800-999-3756, Monday through Friday, 6 a.m. until 6 p.m. Mountain Time (excluding holidays). To help us assist you, please note the product model number and serial number before calling. The model number is HRTL10980. The serial number can be found on a decal attached to the treadmill (see the front cover of this manual for the location).

Before reading further, please familiarize yourself with the parts that are labeled in the drawing below.

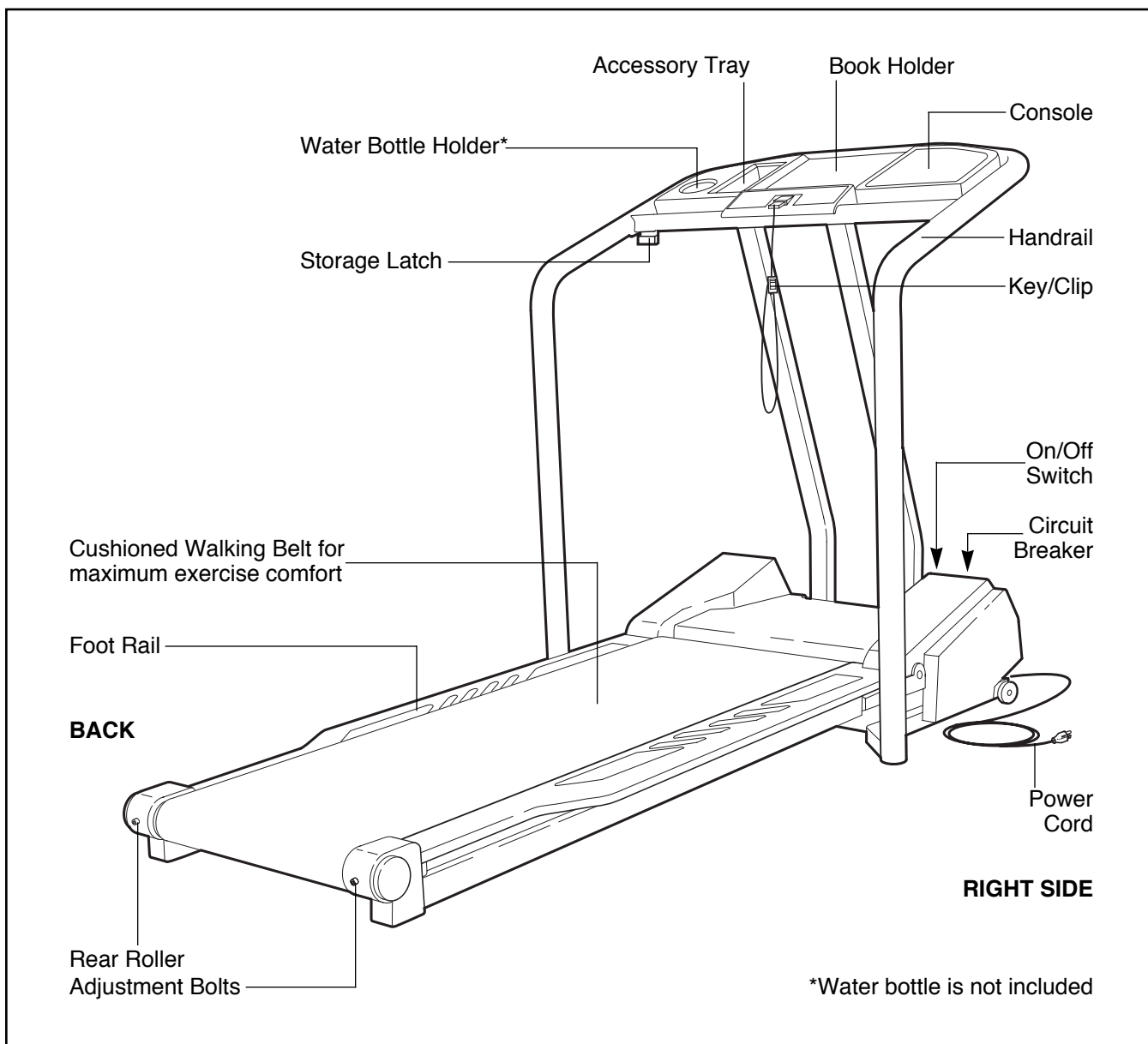

SETTING UP THE TREADMILL

Set-up requires two people. Place the treadmill in a cleared area and remove all packing materials. Do not dispose of the packing materials until the treadmill is set up. No tools are required.

1. **With the help of a second person,** carefully raise the Uprights (82) until the Front Wheels (77) are resting on the floor as shown.

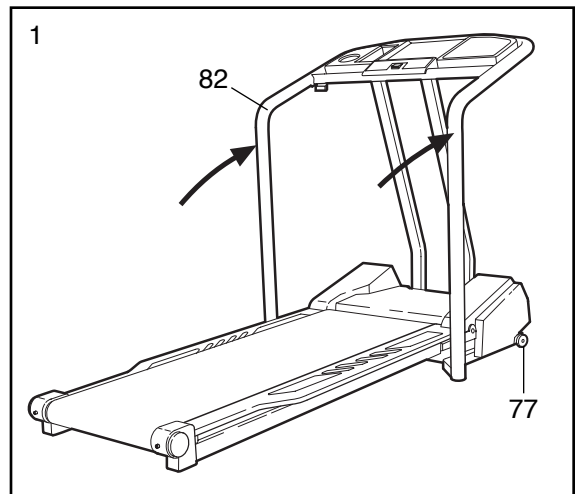

2. Remove the paper backing from the Wrench Clip (71). Press the Wrench Clip onto the Frame (92) in the indicated location. Press the Allen Wrench (72) into the Wrench Clip. Note: The use of the Allen Wrench is described on pages 17 and 18.

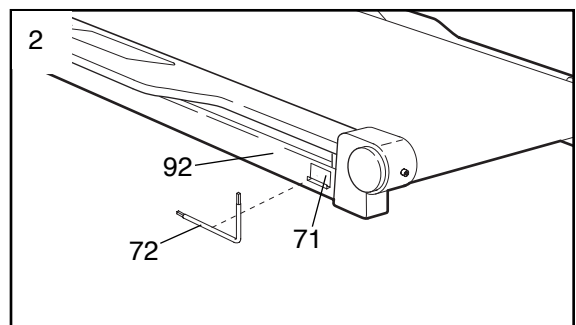

3. **Make sure that all parts are tightened before you use the treadmill. Place a mat beneath the treadmill to protect the floor or carpet.** For your benefit, we recommend that you familiarize yourself with the "TROUBLE-SHOOTING AND MAINTENANCE" section on page 17.

GROUNDING INSTRUCTIONS

THE PERFORMANT LUBE™ WALKING BELT

Your treadmill features a walking belt coated with PERFORMANT LUBE™, a high-performance lubricant. **IMPORTANT: Never apply silicone spray or other substances to the walking belt or the walking platform. Such substances will deteriorate the walking belt and cause excessive wear.**

HOW TO PLUG IN THE POWER CORD

⚠ DANGER: Improper connection of the equipment-grounding conductor can result in an increased risk of electric shock. Check with a qualified electrician or serviceman if you are in doubt as to whether the product is properly grounded. Do not modify the plug provided with the product—if it will not fit the outlet, have a proper outlet installed by a qualified electrician.

Your treadmill, like any other type of sophisticated electronic equipment, can be seriously damaged by sudden voltage changes in your home's power. Voltage surges, spikes, and noise interference can result from weather conditions or from other appliances being turned on or off.

To decrease the possibility of your treadmill being damaged, always use a surge protector (not included) with your treadmill.

Surge protectors are sold at most hardware stores and department stores. Use only a UL-listed surge protector, rated at 15 amps, with a 14-gauge cord of five feet or less in length.

This product must be grounded. If it should malfunction or break down, grounding provides a path of least resistance for electric current to reduce the risk of

electric shock. This product is equipped with a cord having an equipment-grounding conductor and a grounding plug. **Plug the power cord into a surge protector, and plug the surge protector into an appropriate outlet that is properly installed and grounded in accordance with all local codes and ordinances.**

This product is for use on a nominal 120-volt circuit, and has a grounding plug that looks like the plug illustrated in drawing 1 below. A temporary adapter that looks like the adapter illustrated in drawing 2 may be used to connect the surge protector to a 2-pole receptacle as shown in drawing 2 if a properly grounded outlet is not available.

The temporary adapter should be used only until a properly grounded outlet (drawing 1) can be installed by a qualified electrician.

The green-colored rigid ear, lug, or the like extending from the adapter must be connected to a permanent ground such as a properly grounded outlet box cover. Whenever the adapter is used it must be held in place by a metal screw. **Some 2-pole receptacle outlet box covers are not grounded. Contact a qualified electrician to determine if the outlet box cover is grounded before using an adapter.**

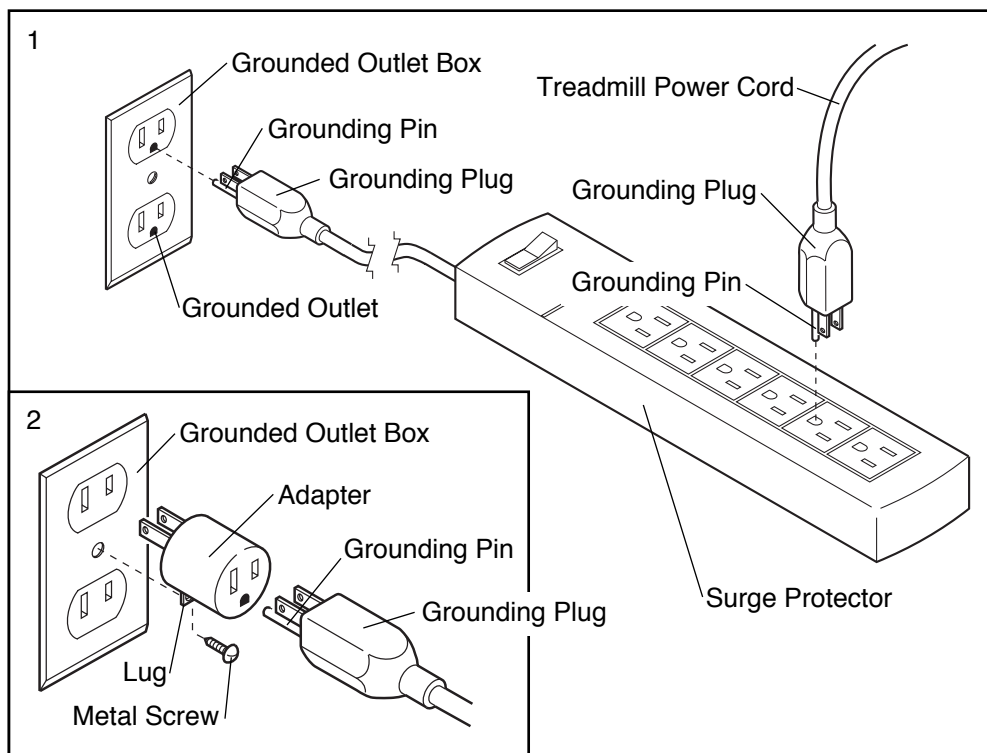

CONSOLE OPERATION

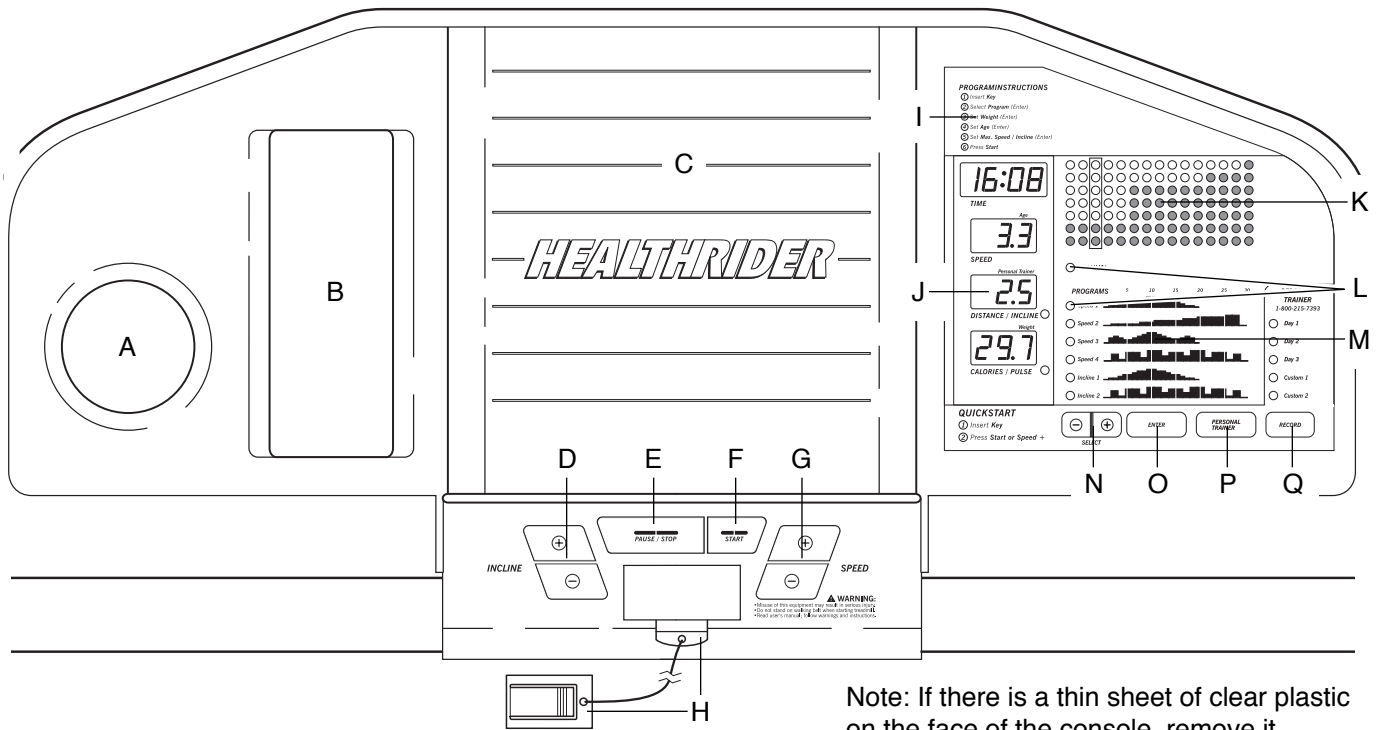

Note: If there is a thin sheet of clear plastic on the face of the console, remove it.

CAUTION: Before operating the console, read the following precautions.

- Do not stand on the walking belt when turning on the power or starting the walking belt.
- Always wear the clip (see H above) while operating the treadmill. If the key is pulled from the console, the walking belt will stop.
- The treadmill is capable of high speeds; adjust the speed in small increments.
- To reduce the risk of electric shock, keep the console dry. Avoid spilling liquid on the console and use only a sealable water bottle.

FEATURES OF THE CONSOLE

The advanced console offers a selection of features designed to make your workouts more enjoyable and effective. When the console is in the manual mode, the speed and incline of the treadmill can be changed with a touch of a button. As you exercise, the LED displays

will provide continuous exercise feedback. The console also offers six preset workout programs: four programs automatically control the speed of the treadmill and two programs automatically control the incline of the treadmill as they guide you through effective workouts. You can even create your own workout programs and store them in memory for future use.

In addition, the console features exclusive Personal Trainer programs. Simply mail the included personal profile to E-Coach®. A personal trainer will send you instructions for selecting a Personal Trainer program designed to help you reach your specific fitness goals.

Two optional pulse sensors add even more features to the console. An optional hand pulse sensor mounts to the handlebar in front of the console, allowing you to measure your heart rate at any time as you exercise. Or, an optional chest pulse sensor can be worn during your workouts, for hands-free heart rate monitoring. **To purchase one of the optional pulse sensors, refer to page 15.**

Note: The console can display speed and distance in either miles or kilometers (see page 11). For convenience, all instructions in this section refer to miles.

DIAGRAM OF THE CONSOLE

Refer to the drawing at the top of page 8.

- A. Water Bottle Holder—Keeps your water bottle handy during your workouts.
- B. Accessory Tray—Holds your personal items.
- C. Reading Rack—Allows you to enjoy your favorite magazine or read a book while you get in shape.
- D. INCLINE Buttons—These buttons control the incline of the treadmill. Each time a button is pressed, the incline will change by 0.5%. The incline range is 1.5% to 10%.
- E. PAUSE/STOP Button—This button stops the walking belt. When the button is pressed, the TIME, DISTANCE/INCLINE and CALORIES/PULSE displays will pause. If the button is held down for two seconds, the displays will be reset.
- F. START Button—This button starts the walking belt.
- G. SPEED Buttons—These buttons control the speed of the walking belt. Each time a button is pressed, the speed will change by 0.1 mph. The speed range is 0.5 mph to 10 mph.
- H. Key with Clip—The key turns the console on and off. The attached clip is designed to be worn on your waistband. If the key is pulled from the console, the power will automatically turn off.
- I. Operating Instructions—These instructions list the basic steps of console operation.
- J. LED Displays—These displays provide continuous feedback of the elapsed time, speed, distance, incline and the number of calories you have burned. The lower display also shows your heart rate when an optional pulse sensor is used.
- K. Program Display—This display shows your progress during workout programs, as well as upcoming incline or speed changes.
- L. MANUAL/Program Indicators—These indicators show when the manual mode is selected and when one of the workout programs is selected.
- M. Program Profiles—These profiles show how the incline or speed of the treadmill will change during workout programs. During the Speed 1 program, for example, the speed will gradually increase during the first half of the program, and then gradually decrease during the last half.
- N. SELECT Buttons—These buttons are used to make various selections on the console.
- O. ENTER Button—This button is used to enter selections.
- P. PERSONAL TRAINER Button—This button is used to select Personal Trainer programs. Note: Personal Trainer programs cannot be selected until you have received instructions from a personal trainer (see PERSONAL TRAINER PROGRAMS on page 15).
- Q. RECORD Button—This button is used to program the Custom 1 and Custom 2 programs.

HOW TO TURN ON THE POWER

Make sure that the on/off switch, located on the front of the treadmill, is in the on position.

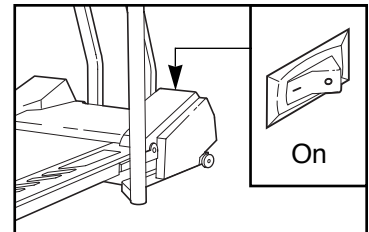

Next, make sure that the power cord is properly plugged in (see page 7). Note: If the key is in the console when the power cord is plugged in, the letters “PO” will flash in the CALORIES/PULSE display. If this occurs, remove the key.

Step onto the foot rails of the treadmill. Find the clip attached to the key, and slide the clip onto the waistband of your clothing. Next, insert the key fully into the console. The MANUAL indicator will begin to flash; all other indicators and displays will remain dark.

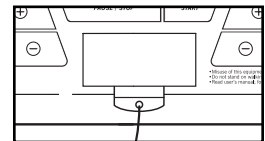

HOW TO USE THE MANUAL MODE

1 Insert the key into the console.

See HOW TO TURN ON THE POWER on page 9.

Note: When you are familiar with the console, you may go directly to step 5. While learning to use the console, please read all steps.

2 Select the MANUAL mode.

When the key is inserted, the MANUAL indicator will begin to flash. (Note: If a program has been selected, hold down the PAUSE/STOP button for two seconds until the MANUAL indicator is flashing.) To select the manual mode, press the ENTER button while the MANUAL indicator is flashing.

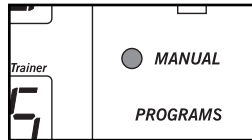

3 Enter your weight if desired.

When the manual mode is selected, the TIME display will light and a weight setting will begin to flash in the CALORIES/PULSE display. If you enter your weight into the console, the CALORIES/PULSE display will be more accurate.

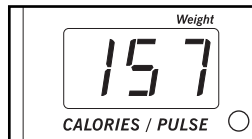

If you do not want to enter your weight, press the ENTER button. To enter your weight, press the SELECT buttons. Each time a button is pressed, the weight setting will change by 1 pound. If a button is held down, the weight setting will change in increments of 5 pounds. When the correct weight is shown, press the ENTER button. Once your weight is entered, it will be saved in memory.

4 Enter your age if desired.

After a weight setting is entered, an age setting will begin to flash in the SPEED display.

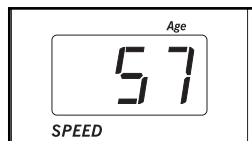

If you do not want to enter your age, press the ENTER button. If you want to enter your age, press the SELECT buttons. Each time a button is pressed, the age setting will change by 1 year. If a button is held down, the age setting will change in increments of 5 years. When the correct age is shown, press the ENTER button. Once your age is entered, it will be saved in memory.

5 Press the START button or the SPEED + button.

A moment after the button is pressed, the walking belt will begin to move at 1.0 mph. Hold the handrails and begin walking. As you exercise, change the speed of the walking belt as desired with the SPEED buttons. Each time a button is pressed, the speed will change by 0.1 mph. The speed range of the walking belt is 0.5 mph to 10.0 mph.

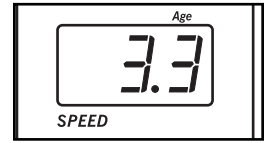

To stop the walking belt for a moment, press the PAUSE/STOP button. The displays will pause and the TIME display will begin to flash. To restart the walking belt, press the START button or the SPEED + button. Note: To stop the walking belt and reset all displays, hold down the PAUSE/STOP button for two seconds. The console will then be in the same state as if the key had just been inserted.

Note: When one of the SPEED buttons is pressed, the SPEED display will show the selected speed setting for seven seconds. The display will then show the actual speed of the walking belt.

6 Adjust the incline as desired.

To vary the intensity of your exercise, the incline of the treadmill can be changed with the INCLINE buttons. Each time a button is pressed, the incline will change by 0.5%. The incline range is 1.5% to 10%. Note: When one of the INCLINE buttons is pressed, the DISTANCE/INCLINE display will show the incline setting for seven seconds. After the INCLINE buttons are pressed, it may take a moment for the treadmill to reach the selected incline setting.

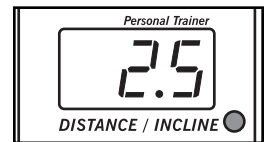

7 Follow your progress with the LED displays.

TIME display—This display shows the total time that the walking belt has been moving. Note: When a workout program is selected, this display will show the time remaining in the program.



SPEED display—This display shows the speed of the walking belt, in miles per hour or kilometers per hour.

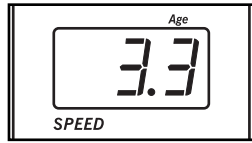

How to select miles per hour and kilometers per hour: Hold down the PAUSE/STOP button while inserting the key into the console. An “E” (for english miles) or an “M” (for metric kilometers) will appear in the SPEED display. Press the SPEED + button to change the unit of measurement. Remove and then reinsert the key.

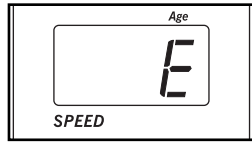

DISTANCE/INCLINE display—This display shows the distance that the walking belt has moved and the incline level of the treadmill.

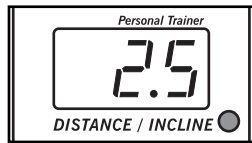

Every seven seconds, the display will change from one number to the other. The INCLINE indicator will light when the incline is shown. Note: If the speed is shown in mph, the distance will be shown in miles. If the speed is shown in kph, the distance will be shown in kilometers.

CALORIES/PULSE display—This display shows the number of calories you have burned.



Note: If an optional hand pulse sensor or chest pulse sensor is used, the CALORIES/PULSE display will show both the number of calories you have burned and your heart rate. Every seven seconds, the display will change from one number to the other. The PULSE indicator will light when your heart rate is shown.

8 When you are finished exercising, stop the walking belt and remove the key.

Step onto the foot rails and press the PAUSE/STOP button. Next, change the incline of the treadmill to 1.5%. **The incline must be at 1.5% when the treadmill is folded to the storage position or the treadmill will be damaged.** Remove the key from the console and put it in a secure place. Move the on/off switch to the off position (see page 9).

HOW TO USE THE SPEED PROGRAMS AND THE INCLINE PROGRAMS

The Speed 1, Speed 2, Speed 3 and Speed 4 programs automatically control the speed of the treadmill as they guide you through effective workouts; the Incline 1 and Incline 2 programs automatically control the incline of the treadmill.

Follow the steps below to use a Speed program or an Incline program.

1 Insert the key fully into the console.

See HOW TO TURN ON THE POWER on page 9.

2 Select the desired program.

To select a program, the **MANUAL indicator or a program indicator must be flashing.** If necessary, hold down the PAUSE/STOP button for two seconds until the MANUAL indicator is flashing. Next, **press the SELECT + or – button** repeatedly until

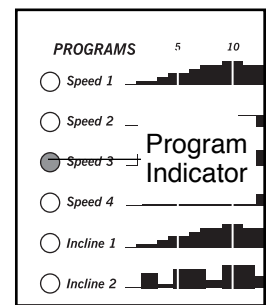

the Speed 1, Speed 2, Speed 3, Speed 4, Incline 1 or Incline 2 program indicator is flashing. Then, press the ENTER button. A profile of the program you have selected will appear in the program display.

Note: When you are familiar with the console, you may go directly to step 6. While learning to use the console, please read all steps.

3 Enter your weight if desired.

When a program is selected, a weight setting will begin to flash in the CALORIES/PULSE display. If your weight is entered into the console, the CALORIES/PULSE display will be more accurate.

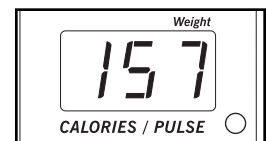

If you do not want to enter your weight, or if you have already entered your weight, press the ENTER button. If you want to enter your weight, press the SELECT buttons. When the correct weight is shown, press the ENTER button.

4 Enter your age if desired.

See step 4 on page 10.

5 Adjust the maximum incline or speed setting.

If you selected the Speed 1, Speed 2, Speed 3 or Speed 4 program: After an age setting is entered, a number will begin to flash in the SPEED display. This number shows the maximum speed that the walking belt will reach during the program. The maximum speed setting can be from 4 mph to 10 mph. If you want to change the maximum speed setting, press the SELECT buttons. Then, press the ENTER button.

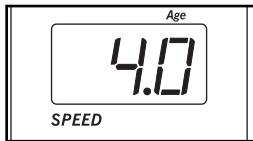

If you selected the Incline 1 or Incline 2 program: After an age setting is entered, a number will begin to flash in the DISTANCE/ INCLINE display. This number shows the maximum incline that the treadmill will reach during the program. The maximum incline setting can be from 5% to 10%. If you want to adjust the maximum incline setting, press the SELECT buttons. Then, press the ENTER button.

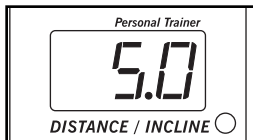

6 Press the START button or the SPEED + button

A moment after the button is pressed, the walking belt will begin to move. (If an incline program is selected, the treadmill will also adjust to the first incline setting of the program, unless it is already at the first incline setting.) Hold the handrails and begin walking.

Each program consists of twenty 60-second or 90-second segments. If an incline program is selected, one incline setting is programmed for each segment; if a speed program is selected, one speed setting is programmed for each segment. The incline or speed setting of the first segment will be shown in the flashing current segment column of the program display. The incline or speed settings of the next twelve segments will be shown in the twelve columns to the right.

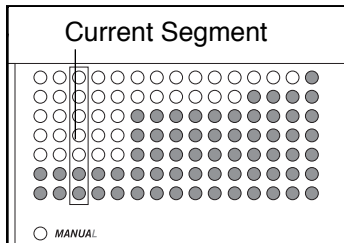

When only three seconds remain in the first segment of the program, both the current segment column and the column to the right will flash. When the first segment is completed, two tones will sound and all incline or speed settings will move one column to the left. The incline or speed setting of the second segment will then be shown in the current segment column, and the incline or speed of the treadmill will adjust to that setting. The program will continue in this way until all twenty segments are completed.

If an incline program is selected, the speed of the treadmill can be changed at any time with the SPEED buttons. If a speed program is selected, the incline of the treadmill can be changed at any time with the INCLINE buttons.

The TIME display will show the time remaining in the program. When no time remains, the walking belt will slow to a stop and the program will be completed.

Note: If the program is too easy or too difficult, the incline or speed setting of the current segment can be adjusted with the INCLINE or SPEED buttons. To stop the program for a moment, press the PAUSE/ STOP button. The displays will pause and the TIME display will begin to flash. To restart the program, press the START button or the SPEED + button. To end the program at any time, hold down the PAUSE/STOP button for two seconds. The console will then be in the same state as if the key had just been inserted.

7 Follow your progress with the LED displays.

See step 7 on page 10.

8 When you are finished exercising, remove the key.

Make sure that the incline of the treadmill is at 1.5%. **The incline must be at 1.5% when the treadmill is folded to the storage position or the treadmill will be damaged.** Remove the key from the console and put it in a secure place. In addition, move the on/off switch to the off position (see page 9).

HOW TO PROGRAM THE CUSTOM 1 AND CUSTOM 2 PROGRAMS

The Custom 1 and Custom 2 programs are workout programs that you create. The programs control both the speed and the incline of the treadmill, and can be up to 40 minutes long. The programs are stored in memory, and can be changed as many times as desired. Follow the steps below to create a program.

1 Insert the key fully into the console.

See HOW TO TURN ON THE POWER on page 9.

2 Select the Custom 1 or Custom 2 program.

To select the Custom 1 or Custom 2 program, the MANUAL indicator must be flashing. If necessary, hold down the

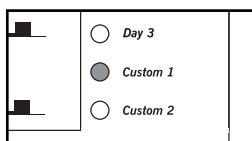

PAUSE/STOP button for two seconds until the MANUAL indicator is flashing. Next, **press the SELECT + or – button** repeatedly until the Custom 1 or Custom 2 program indicator is flashing. Then, press the ENTER button. One or more indicators will appear in the program display.

Note: When you are familiar with the console, you may go directly to step 5. While learning to use the console, please read all steps.

3 Enter your weight if desired.

When the Custom 1 or Custom 2 program is selected, a weight setting will begin to flash in the CALORIES/PULSE display. If your weight is entered into the console, the CALORIES/PULSE display will be more accurate.



If you do not want to enter your weight, or if you have already entered your weight, press the ENTER button. If you want to enter your weight, press the SELECT buttons. When the correct weight is shown, press the ENTER button.

4 Enter your age if desired.

See step 4 on page 10.

5 Press the START button or the SPEED + button.

A moment after the button is pressed, the walking

belt will begin to move. Hold the handrails and begin walking.

6 Press the RECORD button and program the desired speed and incline settings.

When the RECORD button is pressed, the Custom 1 or Custom 2 indicator will begin to flash rapidly. **Speed and incline settings can be programmed only when the indicator is flashing rapidly.**

Each program is divided into 60-second segments. One speed setting and one incline setting can be programmed for each segment. The speed setting of the first segment is shown in the flashing current segment column of the program display.

(The incline settings are not shown in the program display.) To program speed and incline settings for the first segment, simply adjust the speed and incline of the treadmill as desired with the SPEED and INCLINE buttons. Every few times the SPEED buttons are pressed, one additional indicator will light or darken in the current segment column.

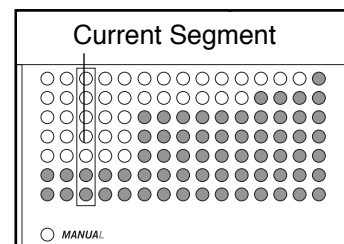

When the first segment is completed, two tones will sound and the current speed and incline settings will be stored in memory. All settings shown in the program display will then move one column to the left, and the speed setting of the second segment will be shown in the current segment column. Program speed and incline settings for the second segment as described above. Repeat this procedure until you have programmed speed and incline settings for as many segments as desired. Programs can have up to forty segments.

Note: To stop the program for a moment, press the PAUSE/STOP button. The displays will pause and the TIME display will begin to flash. To restart the program, press the START or SPEED + button.

7 Hold down the PAUSE/STOP button for two seconds.

When you have programmed speed and incline settings for as many 60-second segments as desired, hold down the PAUSE/STOP button for two seconds. The speed and incline settings that you have programmed and the length of the program will be stored in memory. To use the program again, see HOW TO USE THE CUSTOM 1 AND CUSTOM 2 PROGRAMS on page 14.

8 When the program is completed, remove the key.

Make sure that the incline of the treadmill is at 1.5%. **The incline must be at 1.5% when the treadmill is folded to the storage position or the treadmill will be damaged.** Remove the key from the console and put it in a secure place. In addition, move the on/off switch to the off position (see page 9).

HOW TO USE THE CUSTOM 1 AND CUSTOM 2 PROGRAMS

1 Insert the key fully into the console.

See HOW TO TURN ON THE POWER on page 9.

2 Select the Custom 1 or Custom 2 program.

To select the Custom 1 or Custom 2 program, the **MANUAL** indicator or a program indicator must be flashing. If necessary, hold down the

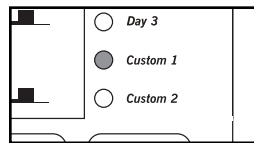

PAUSE/STOP button for two seconds until the MANUAL indicator is flashing. Next, **press the SELECT + or – button** repeatedly until the Custom 1 or Custom 2 program indicator is flashing. Then, press the ENTER button. A profile of the program you have selected will appear in the program display.

Note: When you are familiar with the console, you may go directly to step 5. While learning to use the console, please read all steps.

3 Enter your weight if desired.

See step 3 on page 13.

4 Enter your age if desired.

See step 4 on page 10.

5 Press the START button or the SPEED + button.

A moment after the button is pressed, the walking belt will begin to move. Hold the handrails and begin walking.

Each program is divided into 60-second segments. One speed setting and one incline setting are programmed for each segment. The speed setting of the first segment is shown in the flashing current segment column of the program display. (The incline setting is not shown in the program display.) When only three seconds remain in the first seg-

ment of the program, both the current segment column and the column to the right will flash.

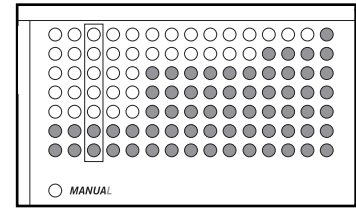

When the first segment is completed, two tones will sound and all speed settings will move one column to the left. The speed setting of the second segment will then be shown in the current segment column, and the incline and speed of the treadmill will adjust to the second settings that you programmed previously. The program will continue in this way until all segments are completed and no time remains in the TIME display. The walking belt will then slow to a stop and the program will be completed.

Note: To stop the program for a moment, press the PAUSE/STOP button. The displays will pause and the TIME display will begin to flash. To restart the program, press the START button or the SPEED + button. To end the program at any time, hold down the PAUSE/STOP button for two seconds. The console will then be in the same state as if the key had just been inserted.

Note: During the program, the speed and incline settings of the current segment can be adjusted with the SPEED and INCLINE buttons. Adjustments will not be stored in memory. To **reprogram** speed and incline settings, press the RECORD button. The Custom 1 or Custom 2 indicator will begin to flash rapidly. **Speed and incline settings can be reprogrammed only when the indicator is flashing rapidly.** Next, adjust the speed and incline of the treadmill with the SPEED and INCLINE buttons. When the current segment of the program is completed, the new speed and incline settings will be stored in memory. When you have reprogrammed speed and incline settings for as many segments as desired, press the RECORD button again.

6 Follow your progress with the five displays.

Refer to step 7 on page 10.

7 When the program is completed, remove the key.

Make sure that the incline of the treadmill is at 1.5%. **The incline must be at 1.5% when the treadmill is folded to the storage position or the treadmill will be damaged.** Remove the key from the console and put it in a secure place. In addition, move the on/off switch to the off position (see page 9).

THE INFORMATION MODE

The console features an information mode that keeps track of the total time and distance accumulated on the treadmill. The information mode also allows you to switch the console from miles per hour to kilometers per hour.

To select the information mode, hold down the PAUSE/STOP button while inserting the key into the console. When the information mode is selected, the following information will be shown:

The TIME display will show the total number of hours accumulated on the treadmill.



The SPEED display will show an "E" (for english miles) or an "M" (for metric kilometers). To change the unit of measurement, press the SPEED + button.

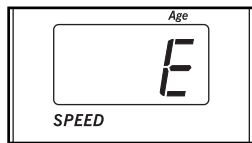

The DISTANCE/INCLINE display will show the total number of miles accumulated on the treadmill.

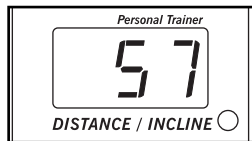

To exit the information mode, remove the key from the console.

PERSONAL TRAINER PROGRAMS

In addition to the Incline programs, the Speed programs, and the Learn programs, the console features exclusive Personal Trainer programs. Simply mail the included personal profile to E-Coach®. A personal trainer will send you instructions for selecting a Personal Trainer program designed to help you reach your specific fitness goals.

OPTIONAL PULSE SENSORS

Two optional pulse sensors add even more features to the console. **To purchase one of the pulse sensors, refer to the card accompanying the treadmill.**

An optional hand pulse sensor mounts to the handlebar in front of the console, allowing you to measure your heart rate at any time during your workouts.

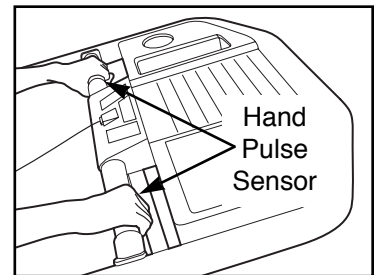

An optional chest pulse sensor can be worn during your workouts, for hands-free heart rate monitoring.

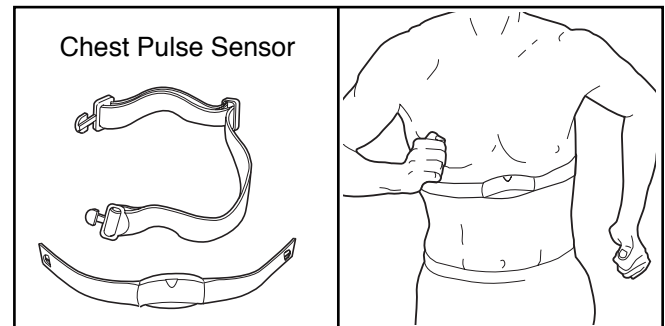

Note: The hand pulse sensor and the chest pulse sensor cannot be used simultaneously.

HOW TO FOLD AND MOVE THE TREADMILL

HOW TO FOLD THE TREADMILL FOR STORAGE

Before folding the treadmill, adjust the incline to the lowest position. If this is not done, the treadmill may be permanently damaged. Next, unplug the power cord. **Caution: You must be able to safely lift 45 pounds (20 kg) in order to raise, lower, or move the treadmill.**

1. Hold the treadmill in the locations shown at the right. **To decrease the possibility of injury, bend your legs and keep your back straight. As you raise the treadmill, make sure to lift with your legs rather than your back.** Raise the treadmill about halfway to the vertical position.

2. Move your right hand to the position shown, and hold the treadmill firmly. Using your left hand, push the storage latch to the left. Raise the treadmill until the storage latch snaps into the catch. **Make sure that the storage latch is inside of the catch.**

To protect the floor or carpet from damage, place a mat under the treadmill. Keep the treadmill out of direct sunlight. Do not leave the treadmill in the storage position in temperatures above 85° Fahrenheit.

HOW TO MOVE THE TREADMILL

Before moving the treadmill, convert the treadmill to the storage position as described above. **Make sure that the storage latch is inside of the catch.**

1. Hold the handrails and place one foot on the base.
2. Tilt the treadmill back until it rolls freely on the front wheels. Carefully move the treadmill to the desired location. **To reduce the risk of injury, use extreme caution while moving the treadmill. Do not attempt to move the treadmill over an uneven surface.**
3. Place one foot on the base, and carefully lower the treadmill until it is resting in the storage position.

HOW TO LOWER THE TREADMILL FOR USE

1. Hold the upper end of the treadmill with your right hand as shown. Using your left hand, push the storage latch to the left. Pivot the treadmill until the storage latch is past the catch.
2. See the drawing at the top of this page. Hold the treadmill firmly with both hands, and lower the treadmill to the floor. **To decrease the possibility of injury, bend your legs and keep your back straight.**

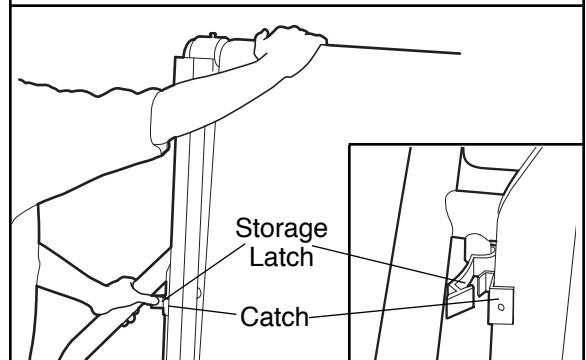
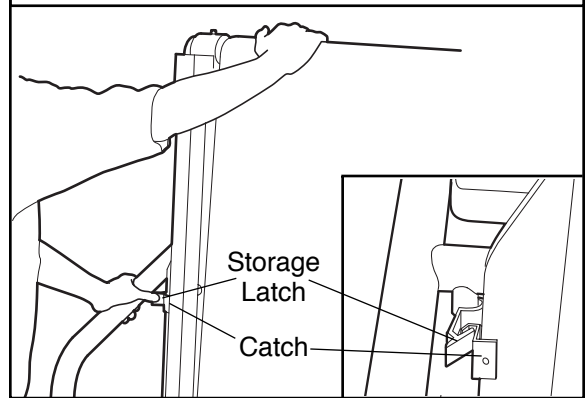
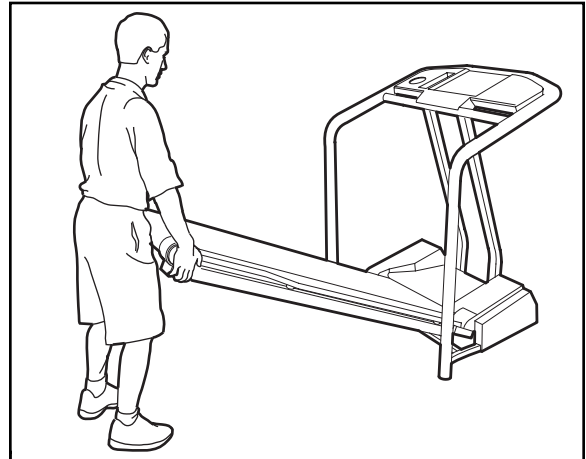

TROUBLE-SHOOTING AND MAINTENANCE

Most treadmill problems can be solved by following the instructions below. If further assistance is needed, please call our Customer Service Department toll-free at 1-800-999-3756, Monday through Friday, 6 a.m. until 6 p.m. Mountain Time (excluding holidays).

PROBLEM	SOLUTION
1. The power does not turn on	a. Make sure that the power cord is plugged into a surge protector, and that the surge protector is plugged into a properly grounded outlet. (See page 7.) Use only a UL-listed surge protector, rated at 15 amps, with a 14-gauge cord of five feet or less in length.
	b. Make sure that the key is fully inserted into the console.
	c. Check the circuit breaker located on the frame near the power cord. If the switch protrudes as shown, the circuit breaker has tripped. To reset the circuit breaker, wait for five minutes and then press the switch back in.
	d. Check the on/off switch located on the frame near the power cord. The switch must be in the on position.
2. The power turns off during use	a. Check the circuit breaker (see c. above). If the circuit breaker has tripped, wait for five minutes and then press the switch back in.
	b. Make sure that the power cord is plugged in.
	c. Remove the key from the console and then reinsert it.
	d. Make sure that the on/off switch is in the on position (see d. above).
3. The walking belt slows when walked on	a. Use only a UL-listed surge protector, rated at 15 amps, with a 14-gauge cord of five feet or less in length.
	b. If the walking belt is overtightened, treadmill performance may decrease and the walking belt may be permanently damaged. Remove the key and UNPLUG THE POWER CORD . Using the included allen wrench, turn both rear roller adjustment bolts counterclockwise 1/4 of a turn. When the walking belt is properly tightened, you should be able to lift the edges of the walking belt 3 to 4 inches off the walking platform. Be careful to keep the walking belt centered. Plug in the power cord, insert the key and run the treadmill for a few minutes. Repeat until the walking belt is properly tightened.
	c. If the walking belt still slows when walked on, call our Customer Service Department toll-free.

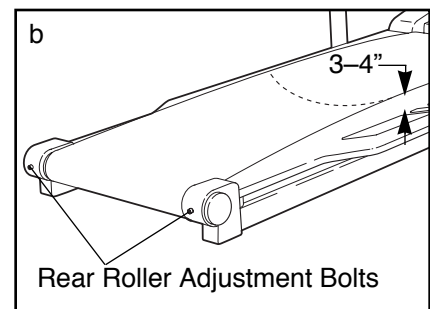
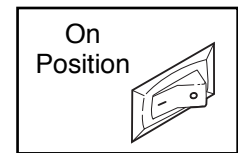
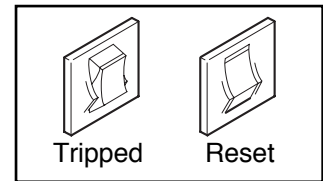

PROBLEM**SOLUTION****4. The walking belt is off-center or slips when walked on**

a. If the walking belt has shifted to the left, first remove the key and **UNPLUG THE POWER CORD**. Using the allen wrench, turn the left rear roller adjustment bolt clockwise, and the right bolt counterclockwise, 1/4 of a turn each. Be careful not to overtighten the walking belt. Plug in the power cord, insert the key and run the treadmill for a few minutes. Repeat until the walking belt is centered.

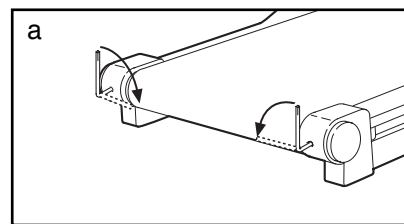

b. If the walking belt has shifted to the right, first remove the key and **UNPLUG THE POWER CORD**. Using the allen wrench, turn the left rear roller adjustment bolt counterclockwise, and the right bolt clockwise, 1/4 of a turn each. Be careful not to overtighten the walking belt. Plug in the power cord, insert the key and run the treadmill for a few minutes. Repeat until the walking belt is centered.

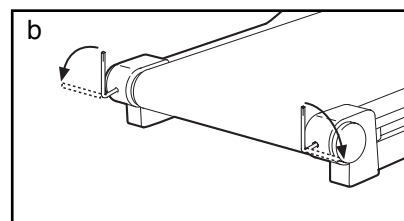

c. If the walking belt slips when walked on, first remove the key and **UNPLUG THE POWER CORD**. Using the allen wrench, turn both rear roller adjustment bolts clockwise, 1/4 of a turn. When the walking belt is correctly tightened, you should be able to lift the **edges** of the walking belt 3 to 4 inches off the walking platform. Be careful to keep the walking belt centered. Plug in the power cord, insert the key and run the treadmill for a few minutes. Repeat until the walking belt is properly tightened.

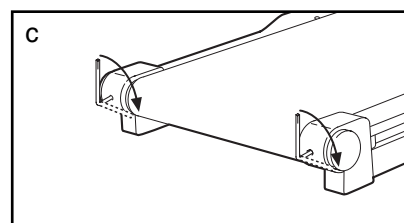
**5. An error code (“E1,” “E2,” “E3,” or “E4,”) appears in the SPEED display**

a. If error code “E1,” “E2,” or “E3” appears in the SPEED display, remove the key, wait for ten seconds, and then reinsert it. If the error code appears again, call our Customer Service Department. **Do not operate the treadmill until the problem is corrected.**

b. Error code “E4” may appear in the SPEED display if the walking belt is moving at a slow speed and there is excessive stress on the motor. If this occurs, remove the key, wait for ten seconds, and then reinsert it. If you weight over 200 pounds, it may also be helpful to increase the incline of the treadmill. If the error code appears again, call our Customer Service Department. **Do not operate the treadmill until the problem is corrected.**

6. The walking belt becomes soiled

a. Use a color-fast upholstery cleaner to clean the walking belt. Test the cleaner on a small area before cleaning the entire belt.

7. Bubbles form in the walking belt

a. Due to variations in humidity and temperature, there is a possibility that bubbles may form in the walking belt. Although the bubbles will disappear with time, you may unplug the power cord, carefully insert a needle into the bubbles, and push the air out of the bubbles.

CONDITIONING GUIDELINES

⚠ WARNING: Before beginning this or any exercise program, consult your physician. This is especially important for individuals over the age of 35 or individuals with pre-existing health problems.

The following guidelines will help you to plan your exercise program. For more information about exercise, consult your physician or obtain a reputable book.

EXERCISE INTENSITY

Whether you want to burn fat or to strengthen your cardiovascular system, you can tailor your exercise to your specific goals. The key to achieving the desired results is to exercise with the proper intensity. As you exercise, your heart rate should be kept at a level between 70% and 85% of your maximum possible heart rate. This is known as your training zone. You can find your training zone in the table below. Training zones are listed according to age and physical condition.

AGE	TRAINING ZONE (Beats/Min.)	
	Unconditioned	Conditioned
20	138-167	133-162
25	136-166	132-160
30	135-164	130-158
35	134-162	129-156
40	132-161	127-155
45	131-159	125-153
50	129-156	124-150
55	127-155	122-149
60	126-153	121-147
65	125-151	119-145
70	123-150	118-144
75	122-147	117-142
80	120-146	115-140

To measure your heart rate, stop exercising and place two fingers on your wrist as shown. Take a six-second heartbeat count, and multiply the result by ten to find your

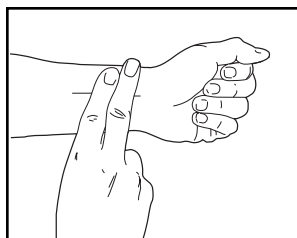

heart rate. (A six-second count is used because your heart rate drops quickly when you stop exercising.) If your heart rate is too high or too low, adjust the speed or incline of the treadmill accordingly.

Burning Fat

To burn fat effectively, you must exercise at a relatively low intensity level for a sustained period of time. During the first few minutes of exercise, your body uses easily accessible carbohydrate calories for energy. Only after the first few minutes of exercise does your body begin to use stored fat calories for energy. If your goal is to burn fat, keep your heart rate near the low end of your training zone as you exercise.

Aerobic Exercise

If your goal is to strengthen your cardiovascular system, your exercise must be “aerobic.” Aerobic exercise is activity that requires large amounts of oxygen for prolonged periods of time. This increases the demand on the heart to pump blood to the muscles, and on the lungs to oxygenate the blood. For aerobic exercise, keep your heart rate near the middle of your training zone as you exercise.

WORKOUT GUIDELINES

Each workout should include three parts: (1) a warm-up, (2) training zone exercise, and (3) a cool-down.

Warming Up—Begin each workout with five to ten minutes of stretching and light exercise to warm up. A proper warm-up increases your body temperature, heart rate, and circulation in preparation for exercise.

Training Zone Exercise—After warming up, increase the intensity of your exercise until your heart rate is in your training zone for 20 to 30 minutes. Breathe regularly and deeply as you exercise—never hold your breath.

Cooling Down—End each workout with five to ten minutes of stretching to cool down. This will develop muscle flexibility and will help to prevent post-exercise problems.

Exercise Frequency

To maintain or improve your condition, complete three workouts each week, with at least one day of rest between workouts. After a few months, you may complete up to five workouts each week if desired. The key to success is to make exercise a regular and enjoyable part of your everyday life.

PART LIST—Model No. HRTL10980

R1098A

Key No.	Qty.	Description	Key No.	Qty.	Description	Key No.	Qty.	Description
1	1	Rear Roller	51	1	Power Supply w/Clips	101	6	Wheel Washer
2	6	Isolator	52	1	Controller	102	2	Sensor Cover Screw
3	2	Front Platform Screw	53	1	Power Cord Grommet	103	2	Console Screw, Long
4	4	Hood Bracket Clip	54	1	Power Cord	104	3	Incline Warning Decal
5	1	Handrail	55	1	Pulse Sensor Housing	105	1	Right Front Grip Tape
6	1	Walking Platform	56	2	Handrail Bolt	106	1	Right Rear Grip Tape
7	2	Frame Pivot Bolt	57	2	Handrail Washer	107	1	Left Rear Grip Tape
8	38	Screw	58	1	Pulse Sensor Cap	108	1	Storage Catch Bolt
9	2	Rear Platform Screw	59	1	Console Base	109	1	Storage Catch Washer
10	2	Cable Tie Clamp	60	1	Console	110	1	Storage Catch Nut
11	6	Small Screw	61	1	Electronics Bracket	111	1	Handrail Cap (left)
12	1	Releasable Tie	62	2	Latch Screw	112	1	Handrail Cap (right)
13	5	8" Cable Tie	63	1	Choke Bracket	#	1	8" Black Wire, M/F
14	1	Belly Pan	64	1	Key/Clip	#	1	8" Black Wire, 2 Ring
15	1	Hood	65	1	Storage Latch	#	1	20" White Wire, 2 F
16	2	Frame Pivot Spacer	66	1	Rear Roller Ground Wire	#	1	4" White Wire, M/F
17	2	Console Bushing	67	1	Incline Warning Decal	#	1	14" Blue Wire, M/F
18	8	Center Grip Tape	68	1	Storage Catch	#	1	8" Blue Wire, 2 Female
19	1	Incline Leg	69	1	Incline Motor Spacer	#	1	4" Blue Wire, 2 F
20	1	Shock	70	2	Endcap Insert	#	1	8" Red Wire, M/F
21	1	Front Roller/Pulley	71	1	Wrench Clip	#	1	4" Green F/Ring
22	1	Walking Belt	72	1	Allen Wrench	#	1	12" Wire Harness
23	1	Motor Tension Nut	73	1	Wire Harness Grommet	#	1	User's Manual
24	1	Motor Star Washer	74	2	Upright Base Endcap			
25	1	Motor Tension Washer	75	2	Frame Pivot Washer			* Includes all parts shown in the box.
26	6	Motor Tension Bolt	76	2	Wheel Nut			For more information about the
27	1	Motor	77	2	Front Wheel			optional pulse kit, see page 15.
28	1	Motor Belt	78	2	Wheel Bolt			# These parts are not illustrated
29	1	Pulley/Flywheel/Fan	79	4	Base Pad			
30	6	Motor Pivot Nut	80	1	Left Front Grip Tape			Specifications are subject to change
31	1	Front Roller Adjust. Bolt	81	1	Wire Harness			without notice.
32	5	Roller Adjust. Washer	82	1	Upright/Base			
33	1	Motor Pivot Bolt	83	1	Incline Motor Plate			
34	1	Front Roller Adjust. Nut	84	1	Incline Motor Shield			
35	1	Speed Optic Disk	85	1	4" Cable Tie			
36	1	Optic Switch Bracket	86	1	Incline Optic Disk			
37	2	Optic Switch Bolt	87	1	23" Cable Tie			
38	1	Bracket Nut	88	1	Incline Motor			
39	2	Optic Switch	89	1	Incline Stop Bracket			
40	1	Optic Switch Star Washer	90	1	Pulse Sensor Cover			
41	2	Optic Switch Nut	91	2	Photo Switch Wire			
42	2	Hood Bracket, Short	92	1	Frame			
43	2	Grommet	93	1	Right Endcap			
44	4	Plastic Stand-Off	94	1	Left Endcap			
45	1	Power Cord Bracket	95	2	Endcap Pad			
46	1	On/Off Switch	96	1	Motor-Controller Wire			
47	1	Circuit Breaker	97	2	Rear Roller Adjust. Bolt			
48	2	Handrail Endcap	98	1	Latch Decal			
49*	1	Motor/Pulley/Fly./Fan	99	2	Platform Screw			
50	2	Hood Bracket (long)	100	1	Electronics Shield			

EXPLODED DRAWING—Model No. HRTL10980

R1098A

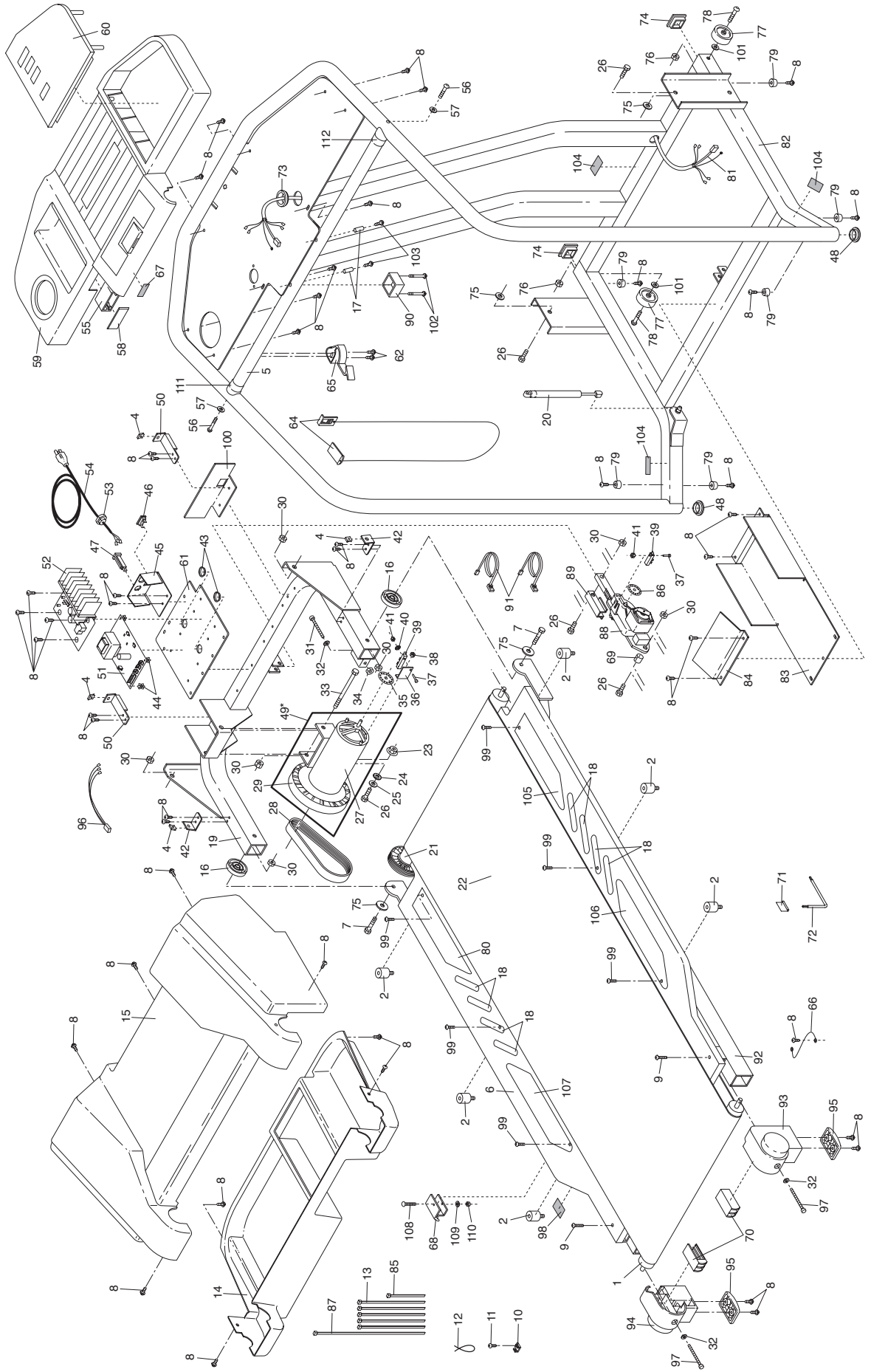

ORDERING REPLACEMENT PARTS

To order replacement parts, call our Customer Service Department toll-free at 1-800-999-3756, Monday through Friday, 6 a.m. until 6 p.m. Mountain Time (excluding holidays). Before calling, please note the following information:

- The MODEL NUMBER of the product (HRTL10980).
- The NAME of the product (HealthRider® SOFTSTRIDER S400™ treadmill).
- The SERIAL NUMBER of the product (see the front cover of this manual).
- The KEY NUMBER and DESCRIPTION of the replacement part(s) (see the EXPLODED DRAWING and PART LIST attached in the center of this manual).

HealthRider® is a registered trademark of ICON Health & Fitness, Inc.

LIMITED WARRANTY

ICON Health & Fitness, Inc. (ICON), warrants this product to be free from defects in workmanship and material, under normal use and service conditions, for a period of ninety (90) days from the date of purchase. This warranty extends only to the original purchaser. ICON's obligation under this warranty is limited to replacing or repairing, at ICON's option, the product at one of its authorized service centers. All products for which warranty claim is made must be received by ICON at one of its authorized service centers with all freight and other transportation charges prepaid, accompanied by sufficient proof of purchase. All returns must be pre-authorized by ICON. This warranty does not extend to any product or damage to a product caused by or attributable to freight damage, abuse, misuse, improper or abnormal usage or repairs not provided by an ICON authorized service center, to products used for commercial or rental purposes, or to products used as store display models. No other warranty beyond that specifically set forth above is authorized by ICON.

ICON is not responsible or liable for indirect, special or consequential damages arising out of or in connection with the use or performance of the product or damages with respect to any economic loss, loss of property, loss of revenues or profits, loss of enjoyment or use, costs of removal, installation or other consequential damages of whatsoever nature. Some states do not allow the exclusion or limitation of incidental or consequential damages. Accordingly, the above limitation may not apply to you.

The warranty extended hereunder is in lieu of any and all other warranties and any implied warranties of merchantability or fitness for a particular purpose is limited in its scope and duration to the terms set forth herein. Some states do not allow limitations on how long an implied warranty lasts. Accordingly, the above limitation may not apply to you.

This warranty gives you specific legal rights. You may also have other rights which vary from state to state.

ICON HEALTH & FITNESS, INC., 1500 S. 1000 W., LOGAN, UT 84321-9813