

# Bluetooth stereo headset user guide

## Bluetooth Introduction

The Bluetooth headset is a portable headset solution based on Bluetooth wireless technology. Bluetooth wireless technology is a short-range radio communication technology intended to replace the cables connecting electronic devices. The technology uses a globally available frequency range intended to ensure communication compatibility worldwide.

You can connect your headset to your mobile phone or any device with Bluetooth wireless technology that supports the Headset profile or the Handsfree profile. When the headset is connected to your mobile phone, you can handle incoming and outgoing calls, listen to music, and adjust the volume, using the buttons on the headset.

The inbuilt Bluetooth Headset in motorcycle helmet contain Bluetooth Cell Discreteness, Control Buttons and Earphone. The Bluetooth Cell Discreteness contain Inserted Bluetooth, Battery and Shell.

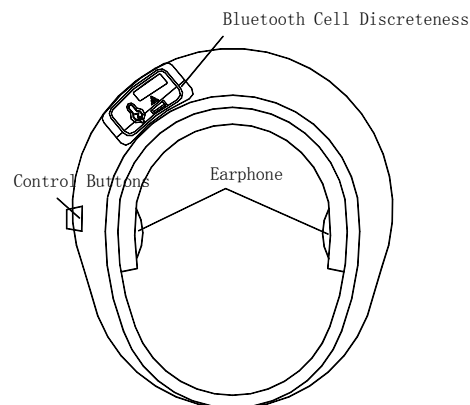

Figure 1

## Caution

Do not let your battery, charger, and headset get wet.

Listening at full volume to music or voice through a headset may damage your hearing.

## BlueToothHeadSet Control Buttons

BUTTON\_MFB Call handling Button

BUTTON\_VOL+ Volume Increase

BUTTON\_VOL- Volume Decrease

## FCC NOTICE

This equipment has been tested and found to comply with the limits for a Class B digital device, pursuant to part 15 of the FCC Rules. These limits are designed to provide reasonable protection against harmful interference in a residential installation. This equipment generates, uses and can radiate radio frequency energy and, if not installed and used in accordance with the instructions, may cause harmful interference to radio communications. However, there is no guarantee that interference will not occur in a particular installation. If this equipment does cause harmful interference to radio or television reception, which can be determined by turning the equipment off and on, the user is encouraged to try to correct the interference by one or more of the following measures:

- Reorient or relocate the receiving antenna.
- Increase the separation between the equipment and receiver.
- Connect the equipment into an outlet on a circuit different from that to which the receiver is connected.
- Consult the dealer or an experienced radio/ TV technician for help.

### CAUTION:

Any changes or modifications not expressly approved by the grantee of this device could void the user's authority to operate the equipment.

## RF exposure warning:

The equipment complies with FCC RF exposure limits set forth for an uncontrolled environment.

The equipment must not be co-located or operating in conjunction with any other antenna or transmitter.

## To use your headset, your phone or music device should

### support the following Bluetooth profiles:

| Profile                | Description  |
|------------------------|--|
| HFP (HandsfreeProfile) | <b>Providing a wireless means for both remote control of the Mobile Phone by the Hands-Free device and voice connections between the Mobile Phone and the Hands-Free device.</b> |

|   |                               |
|---|-------------------------------|
| <b>A2DP (Advanced Audio Distribution Profile)</b> | <b>Stereo music streaming</b> |
|---|-------------------------------|

## Bluetooth Interference Issues

The quality of Bluetooth transmission may also be affected by the position of your music device. Should you experience choppy or distorted audio, move the position of your music device or phone to a different location until the signal improves.

## Getting started

Before you can use your headset, you should first:

Charge the headset battery.

Pair the headset with a device, for example, a mobile phone.

## Charging

The headset comes with a built-in rechargeable battery. We recommend that you charge the battery before using the headset for the first time.

Connect the charger to the headset and to the mains.

The charging time is about 4 hours. During charging, the indicator shows a steady red light. When the battery is fully charged, the indicator red light will switch off. When you use the headset, if you hear a cadent tone, and the indicator red light flashes rhythmically, battery needs recharging.

To charge, please use the handle on Charging Port Rubber Cover gently pull out the Cover, and circumgyrate about 180 degrees. Expose the Charging Port and Plug the Charger Plug into the BlueTooth headset's Charging Port. At this time near the Control Buttons the indicator light turns red when the battery is charging. As Figure2 and Figure 3 shown.

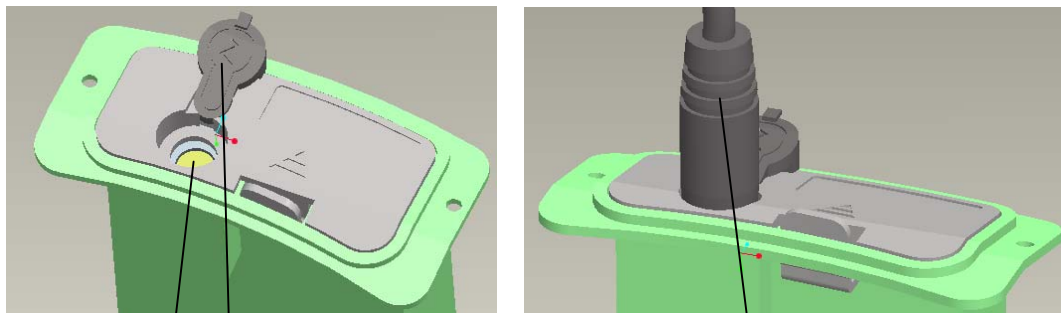

Charging Port

Charging Port Rubber Cover

Charging Plug

Figure 2

Figure3

## **To turn the headset on**

Press and hold the Call Handling Button(MFB) for approximately 2 seconds until you hear a short low tone followed by a short high tone. The headset indicator light flashes yellow.

When turned on, the headset automatically establishes handsfree phone and streaming music connections with the last connected Bluetooth devices (phone and/or music devices).

## **To turn the headset off**

Press and hold the Call Handling Button(MFB) for approximately 5 seconds until will hear a short high tone followed by a short low tone. The headset indicator light switches off.

## **To pairing the headset with a phone**

Before using the headset,you should pair the headset to a phone.

The phone enter the searching BlueDevice mode and with the headset turned off, press and hold the Call Handling Button(MFB) for approximately 5 seconds until the indicator light yellow and red on the Control Buttons flashes alternately.

Operate the phone to discover and connect the headset. The headset passkey is 8888. If pairing success the headset indicator blue light flashes slowly and indicator red light is off. Pairing, done only once. Each time you use your headphones, it will be automatically connected to your phone.

Note:Before enter pairing mode,please make sure other BlueDevices are closed.

## **Using the headset**

### **Listening to music**

Your headset allows you to listen to music from your Bluetooth streaming music source.

**Note:** When placing or receiving calls, music playing from a Bluetooth music source is automatically paused. When the call is finished, music playing is resumed.

### **To Call**

Not every phone can support voice dial function,if your phone support voice dial then you can use headset to call someone. Otherwise,you using the keys on the phone, as usual.

### **To make a call using voice dialing**

Make sure the phone and the headset are on and within range of each other. Press the Call Handling Button(MFB).

It may take a while to set up the connection between the phone and the headset. During this time, you might hear a repeated tone in the headset. After the beep, voice dial as you normally would. Press the Call Handling Button(MFB) to terminate call.

## **To answer a call using the call handling button Or answer automatically by headset**

When the headset rings, press the Call Handling Button(MFB) to answer the incoming call .Or headset will auto answer the call after 3 seconds.

## **Terminate call**

Press the Call Handling Button(MFB)to terminate call.

## **To reject a call**

When the headset rings, press and hold the Call Handling Button(MFB) until you hear a long beep.

**Note: this function valid only if your phone support Hands-Free Profile.**

## **LastNumberRedial**

If headset in idle time, press and hold the Call Handling Button(MFB) until you hear a long beep,then release.

## **Adjusting the volume**

This headset have two volume control button: VOL+ and VOL- .

You can adjust the headset speaker volume during a call, or the ring volume when you are not engaged in a call.

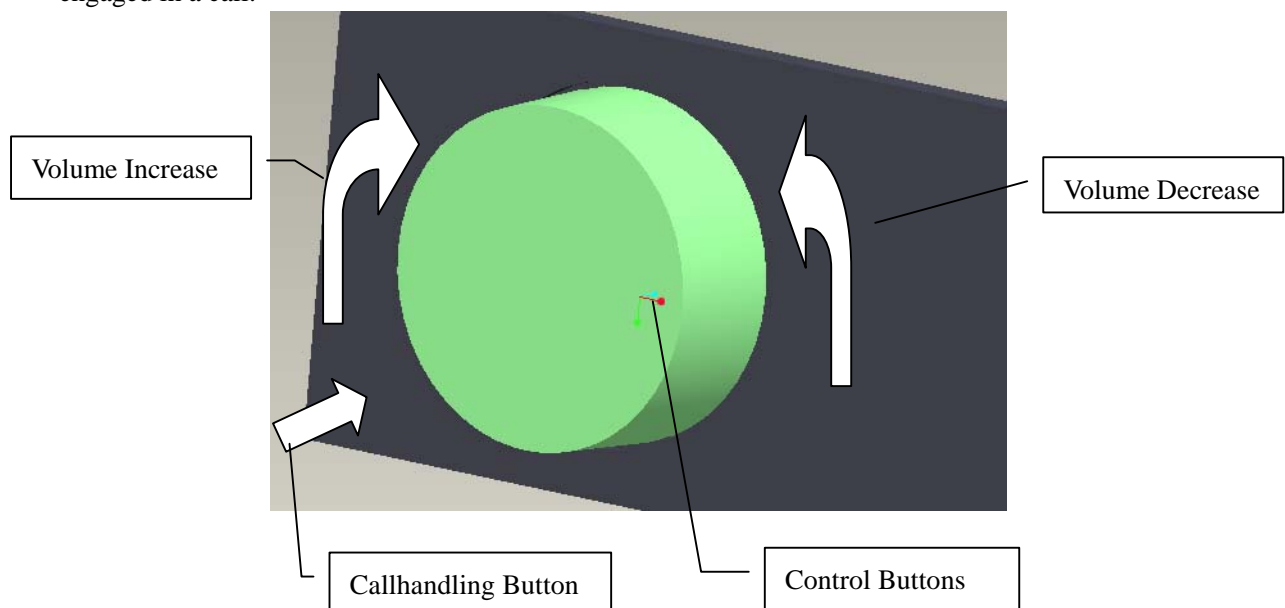

Figure 4

## **To transfer the sound to the phone**

During a call using your headset, press the Call Handling Button(MFB) for approximately 2 seconds.If your headset work with HeadSetProfile, you just need turn down your headset.

## Transferring sound from phone to headset

If you make a call using your phone, you can transfer the sound to the headset if the headset is on, press the Call Handling Button(MFB).

## Replace battery

Need to replace battery, please turn off the BlueTooth Headset first , then open the Shell's cover. As Figure 5 shown ,follow the instructions direction to push the Clasp handle, you can open the cover to expose the battery in Shell as Figure 6 shown . Hold the handle, you can take out battery as Figure 7 shown.. Put a new battery into same position will finish replacing.Then close the cover last.

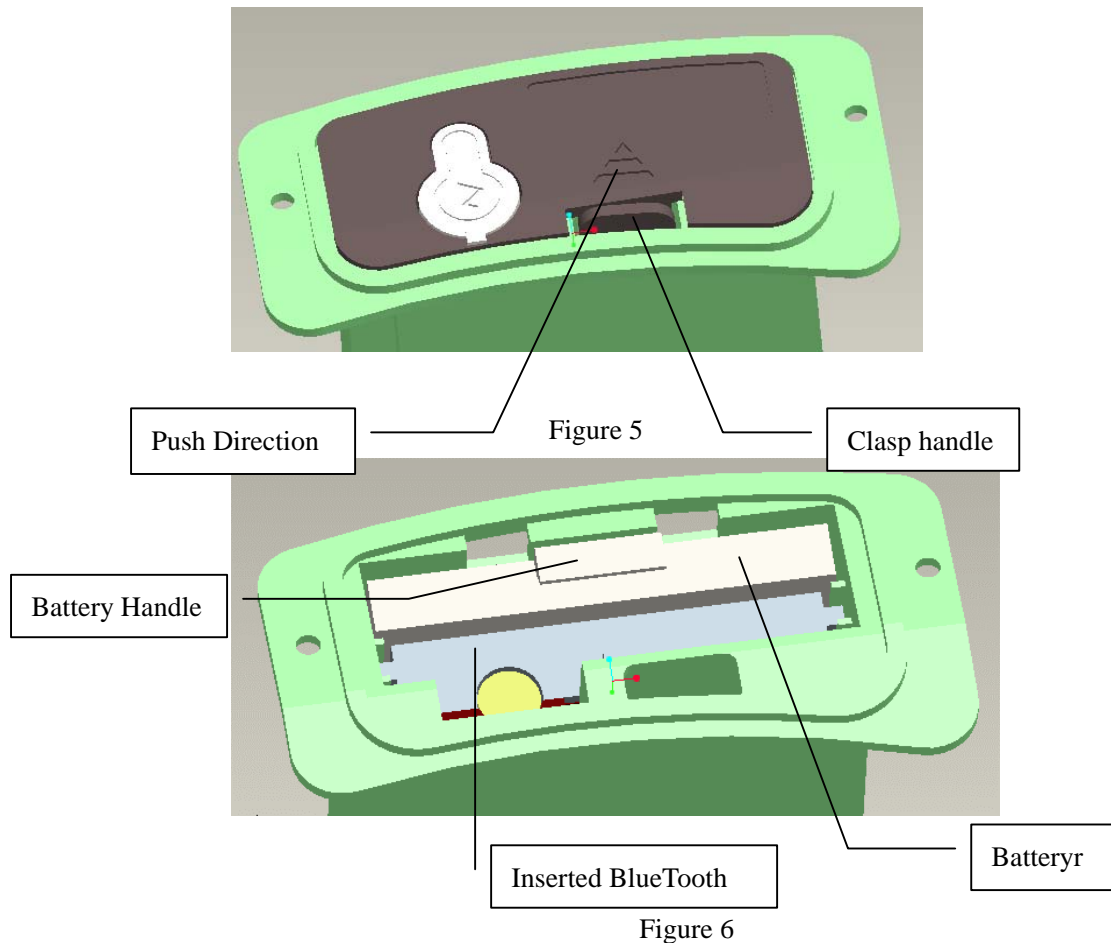

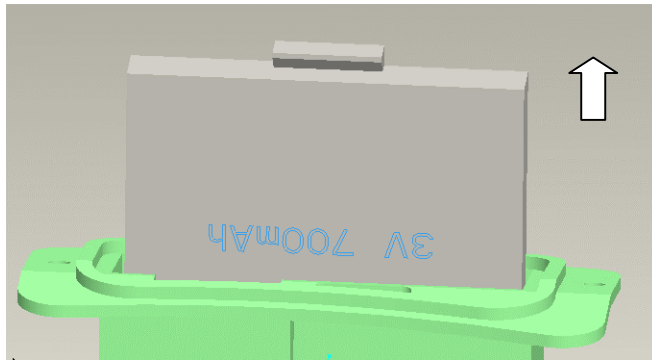

Figure 7

## Replace Inserted BlueTooth

For special requirements must be replaced Inserted BlueTooth, please follow the instruction have shown to open the Shell's cover, you will see the exposed Inserted BlueTooth, as Figure 6 shown. Use a screwdriver ,follow the instruction of the Figure 8 ,take out the Inserted BlueTooth as Figure 9 shown.

Be careful when you install the Inserted BlueTooth ,the Guideway of the Inserted BlueTooth should insert the Guideway of the Shell,and insert deeply.

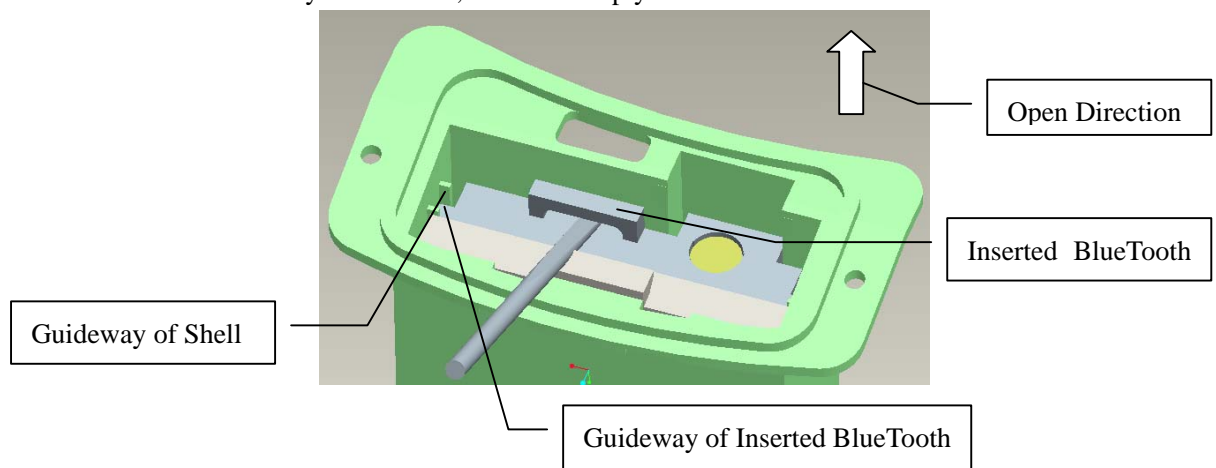

Figure 8

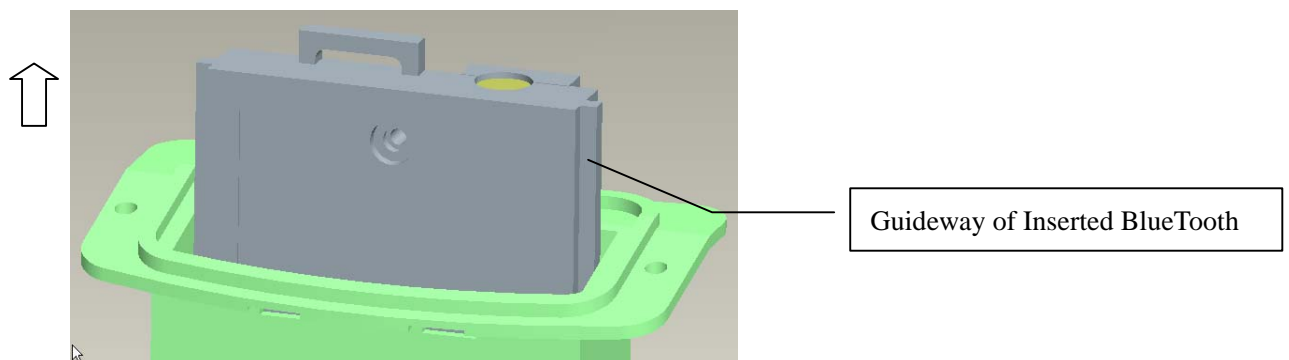

Figure 9

**Note : no special need should not take out the Inserted BlueTooth.**