



3Com

Quick Start Guide

11a/b/g Wireless Workgroup Bridge

3CRWE675075

The 3Com 11a/b/g Wireless Workgroup Bridge combines high-performance, interoperability, and ease-of-use to join isolated wired networks into a cohesive wireless local area network (WLAN). Instead of traveling over wires, data is transmitted across the WLAN using radio waves.

The 3Com 11a/b/g Wireless Workgroup Bridge includes a robust suite of standards-based security features, and supports wireless network standards including 802.11a and 802.11g. For a complete list of the Bridge's features, see the *3Com 11 a/b/g Wireless Workgroup Bridge User Guide* located on the 3Com Installation CD.

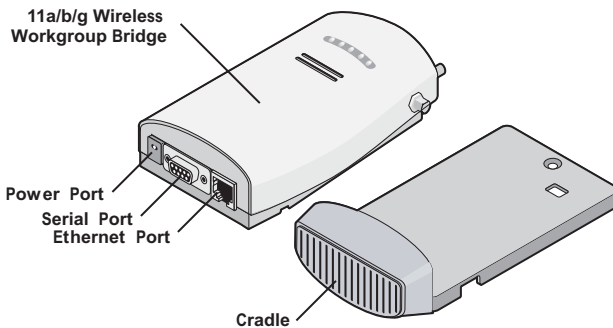

This Quick Start Guide describes the basic installation of the Bridge. It covers the following topics:

- Unpacking the Bridge
- Deciding Where to Place the Bridge
- Connecting the Bridge
- Checking the LED Indicators
- Attaching An External Antenna
- Determining if you Need to Configure the Bridge
- Using the 3Com Installation CD

For complete instructions on using the Bridge, see the *3Com 11 a/b/g Wireless Workgroup Bridge User Guide* located on the 3Com Installation CD.

Observing Safety Precautions

This equipment must be installed in compliance with local and national building codes, regulatory restrictions, and FCC rules. For the safety of people and equipment, only professional network personnel should install the Bridge.



WARNING: To comply with FCC radio frequency (RF) exposure limits, a minimum body-to-antenna distance of 20 cm (8 in.) must be maintained when the Bridge is operational.



WARNING: To avoid possible injury or damage to equipment, you must use either the provided power supply or power supply equipment that is safety certified according to UL, CSA, IEC, or other applicable national or international safety requirements for the country of use. All references to power supply in this document refer to equipment meeting these requirements.



CAUTION: The 3Com power supply (part number 61-0107-000) input relies on a 16A rated building fuse or circuit protector for short circuit protection of the line to neutral conductors.

1 Unpacking the Bridge

Make sure that you have the following items, which are included with the Bridge:

- Power adapter and power cord.
- Standard Category 5 unshielded twisted pair (UTP) Ethernet cable.
- Locking bar (used for securing a wall-mounted installation).
- Rubber feet (four; used for a flat-surface installation).
- 3Com Installation CD.

2 Deciding Where to Place the Bridge

Place the Bridge in a dry, clean location near the hub, computer, or printer that will be connected to the Bridge. The location must have a power source and be within the following distance of a Wi-Fi-compliant wireless LAN access point or ad hoc wireless station:

- For 802.11a compatibility, place the Bridge within 50 m (164 ft) of a Wi-Fi compliant wireless LAN access point.
- For 802.11b/g compatibility, place the Bridge within 100 m (300 ft) of a Wi-Fi compliant wireless LAN access point.

The location should be away from transformers, heavy-duty motors, fluorescent lights, microwave ovens, refrigerators, or other equipment that could cause radio signal interference.

Wall-mounting the Bridge

The Bridge comes equipped with a cradle for mounting on a wall. For additional security, the Bridge also comes with a locking bar, which can be used with a security lock (not provided) to lock the Bridge to the cradle after the Bridge is mounted to the wall.

To wall-mount the Bridge:

- 1 Screw the cradle to a wall.**
- 2 Route the power and Ethernet cables through the large opening in the cradle.**

The figures below show the cradle being mounted to a wall, and then a cable being routed through the large opening in the cradle.

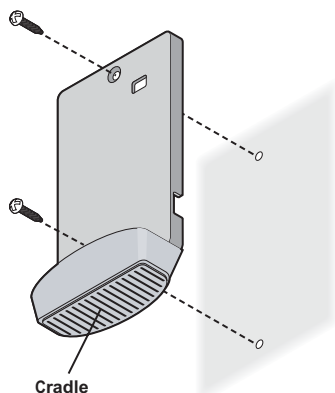

Wall-mounting the cradle

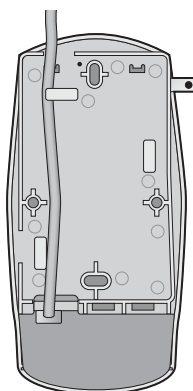

Routing a cable

- 3 Connect the power and Ethernet cables to the ports on the front of the Bridge.**
- 4 Snap the Bridge onto the cradle.**

To install the locking bar, push the locking bar through the opening in the side of the cradle until the hole on the locking bar is exposed. Insert a lock (not provided) through the hole on the locking bar, and then close the lock to secure it in place. See the user guide for detailed instructions.

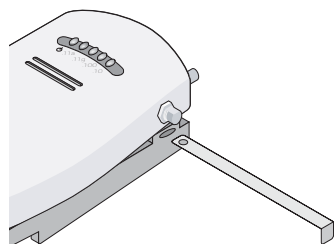

Inserting the locking bar

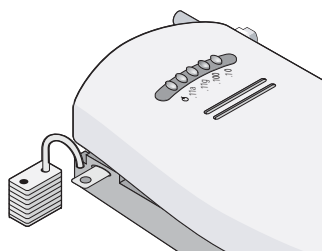

Securing the bar with a lock

Placing the Bridge on a Flat Surface

To install the Bridge on a flat surface such as a table or desktop, remove the backing from the four rubber feet and attach them on the bottom of the cradle.



CAUTION: Do not place the Bridge on any type of metal surface. Select a location that is clear of obstructions and provides good reception.

3 Connecting the Bridge

Before connecting the Bridge to an Ethernet client, connect the power supply. The figure below shows the ports for connecting the power and Ethernet cables.

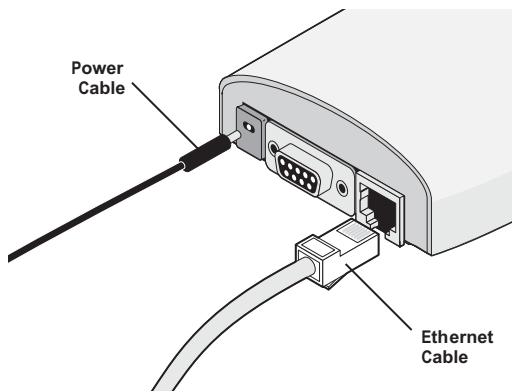

The bridge can also be connected to a serial device. Serial cables come with a variety of connector sizes. If your connector is large and prevents the cradle from being attached to the Bridge, remove the end cap on the cradle. This allows the connector to extend through the cradle.

Connecting to an Ethernet Device

The Bridge is designed to be connected to an Ethernet client device such as a hub, computer, or printer.



CAUTION: To avoid the possibility of a transmission loop situation between the Bridge and an access point, which could disrupt network operation, do not connect a Bridge that is set in Wireless Client (Infrastructure) mode directly to the LAN (for example, through a wall port or through a hub that is connected directly to the LAN).

Connecting to a Hub

You can supply network connections for up to 16 devices, such as computers and network printers, by connecting the Bridge to an Ethernet hub, as shown below.

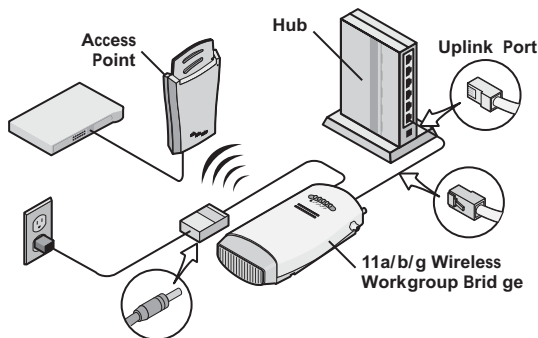



CAUTION: You can directly connect the Bridge to a hub that does not have an uplink (MDIX) port, without the need of an Ethernet crossover cable.

Connecting to a Network Printer

You can connect a network printer directly to the Bridge or to a hub that is connected to the Bridge. Used this way, the Bridge allows you to place network printers in areas that are not wired for Ethernet.

- 1** Configure the network printer as you would for connecting it to the wired LAN. For details on configuring the printer, see your printer documentation.
- 2** If necessary, configure the Bridge to associate with your access point.
- 3** Connect the Bridge to power in its permanent location.
- 4** Connect the network printer directly to the Bridge as shown in the figure below, or into a hub that is connected to the Bridge as shown in the previous section, "Connecting to a Hub."

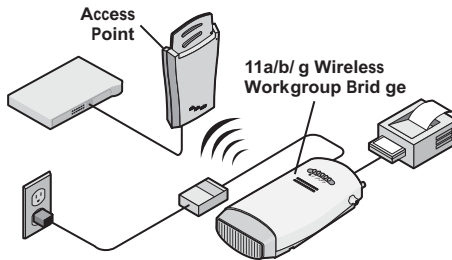

Connecting to a Computer

You can connect the Bridge directly to a computer as shown below. Used this way, the Bridge can convert a desktop computer to a wireless computer. This connection also allows you to configure a Bridge before connecting it to another device.

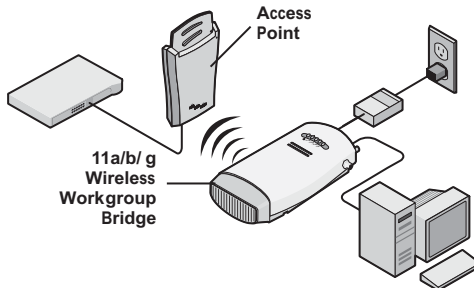

4 Checking the LED Indicators

When the Bridge is connected to power, LEDs indicate activity as follows (solid LED indicates connection; blinking LED indicates activity):

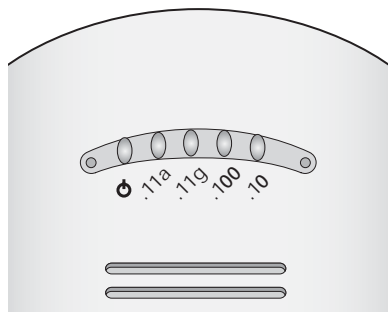

LED	Color	Indicates
Power	Green	The Bridge is powered up and operating normally.
	Off	The Bridge is not receiving power or there is a fault with the power supply.
11a	Green	The Bridge has WLAN frame transmissions over an 802.11a 5 GHz radio band.
	Off	No link is present.
11g	Green	The Bridge has WLAN frame transmissions over an 802.11g 2.4 GHz radio band.
	Off	No link is present.
100	Green	The Bridge has a 100 Mbps Fast Ethernet connection.
	Off	No link is present.
10	Green	The Bridge has a 10 Mbps Ethernet connection.
	Off	No link is present.

5 Attaching An External Antenna

The Bridge has two internal diversity dual-band antennas. If you want to increase the range of the Bridge, an external antenna can be attached to the external antenna connector on the Bridge. The 3Com-approved external antenna for this Bridge is the 3Com 2.4/5 GHz Omnidirectional Workgroup Bridge Antenna (3CWE501). For more information, go to www.3Com.com

6 Determining if you Need to Configure the Bridge

If your network has a DHCP server and no special security requirements, you can most likely use the Bridge just as it is shipped from the factory. View the Bridge's default settings on the next page to determine whether or not you need to configure the Bridge for your network.

It takes about one to two minutes for the Bridge to determine if there is a DHCP server on the network. If your network does not have a DHCP server or is more complex, you will want to configure the Bridge and organize devices so that you can manage the wireless LAN easily and keep it secure.



CAUTION: For non-U.S. versions of the Bridge, you need to set the Country mode. This is done when you first open the Bridge's Configuration Management System. Select the Country in which the Bridge is operating and then click *Apply*.

Networks with a DHCP Server

If your network has a DHCP server, an IP address is automatically assigned to the Bridge. Use the 3Com Wireless Infrastructure Device Manager (Widman) included on the 3Com Installation CD to locate the Bridge on the network and view its IP address.

After you determine the Bridge's IP address, you can enter that IP address into a web browser on a computer on the same subnet to view the Bridge's system status or change its configuration.

Networks without a DHCP Server

If your network does not have a DHCP server, the Bridge uses a default IP address (169.254.2.2) that is assigned at the factory. You can use that IP address to configure the Bridge, or you can assign a new IP address to the Bridge.

To verify that the Bridge is using the default IP address assigned at the factory:

- 1 Connect a computer directly to the Bridge using the supplied standard Category 5 UTP Ethernet cable.**
- 2 Enter the Bridge's default IP address (169.254.2.2) into the computer's web browser.**

If the Configuration Management System starts, the Bridge is using the factory assigned IP address. You can configure the Bridge with the following login information:

- Login name: admin
- Password: none (blank)

If the Configuration Management System does not start, the Bridge is on a different subnet than the computer. Install and start the 3Com Wireless Infrastructure Device Manager to discover the Bridge's IP address.

Bridge Default Settings

The table below shows the Bridge configuration factory defaults.

Property	Default Setting
Device Name	3Com WWB
Device Location	None
Country	For U.S. versions, United States and Canada For non-U.S. version, set by the user
Client Mode	Support multiple wired Ethernet clients
IP Network Setting	Obtain IP address automatically
IP Address	Obtained automatically (with a DHCP server) 169.254.2.2 (without a DHCP server)
Subnet Mask	Obtained automatically (with a DHCP server) 255.255.0.0 (without a DHCP server)
Gateway IP Address	Obtained automatically (with a DHCP server) 0.0.0.0 (without a DHCP server)
Network Mode	Wireless Client (Infrastructure)
Radio Mode	Auto Select
Wireless LAN Service Area	Attach to any WLAN Service Area (ESSID) automatically
Channel Selection	Automatic Best Channel (uses access point setting)
Transmit Power	100%

Antenna Selection	Internal
Data Preamble	Long (if Network Mode is set to Ad-Hoc) Same as access point setting (if Network Mode is set to Wireless Client [Infrastructure])
Security Setting	Open System (no security)
802.1x Authentication State	Disabled
SNMP	Enabled
Administration Login Name	admin
Administration Password	None (blank)
TFTP Server IP Address	None
FTP Server IP Address	None

7 Using the 3Com Installation CD

The 3Com Installation CD contains the following tools and utilities:

- **3Com Wireless Infrastructure Device Manager**—an administration tool that helps you select 3Com wireless LAN devices and launch their configurations in your Web browser.
- **3Com 3CDaemon Server Tool**—a firmware upgrade tool that can act as a TFTP Server, a SysLog Server, an optional TFTP Client, or an optional FTP Server.

To use the 3Com Installation CD, you need a computer running Internet Explorer (latest version is recommended) and one of the following operating systems: Windows XP, Windows 2000, Windows NT 4.0, Windows Me, or Windows 98.

To install one of the tools on your computer:

- 1 Turn on the computer.**
- 2 Insert the 3Com Installation CD in the CD-ROM drive.**
The setup menu appears. If it does not appear, you can start the setup menu from the Windows Start menu. For example: *Start > Run > d:setup.exe*.
- 3 In the menu, click *Tools and Utilities*.**
- 4 In the next screen, click the tool you want to install.**
- 5 Follow the instructions on the screens to complete the installation.**

Reboot the computer if prompted to do so.

- 6 Launch the tool from the Windows Start menu.**

For details on using the Wireless Infrastructure Device Manager, see “Using the 3Com Wireless Infrastructure Device Manager” in the 3Com *11 a/b/g Wireless Workgroup Bridge User Guide*.

For instructions on using the 3CDaemon Server Tool, see the application’s online help.



3Com 11a/b/g Wireless Workgroup Bridge User Guide

Model: WL-560
3CRWE675075



<http://www.3com.com/>

Part No. DUA6750-75AAA01
Published July 2004

3Com Corporation
350 Campus Drive
Marlborough
MA USA 01752-3064

Copyright © 2004, 3Com Corporation. All rights reserved. No part of this documentation may be reproduced in any form or by any means or used to make any derivative work (such as translation, transformation, or adaptation) without written permission from 3Com Corporation.

3Com Corporation reserves the right to revise this documentation and to make changes in content from time to time without obligation on the part of 3Com Corporation to provide notification of such revision or change.

3Com Corporation provides this documentation without warranty, term, or condition of any kind, either implied or expressed, including, but not limited to, the implied warranties, terms or conditions of merchantability, satisfactory quality, and fitness for a particular purpose. 3Com may make improvements or changes in the product(s) and/or the program(s) described in this documentation at any time.

If there is any software on removable media described in this documentation, it is furnished under a license agreement included with the product as a separate document, in the hard copy documentation, or on the removable media in a directory file named LICENSE.TXT or !LICENSE.TXT. If you are unable to locate a copy, please contact 3Com and a copy will be provided to you.

UNITED STATES GOVERNMENT LEGEND

If you are a United States government agency, then this documentation and the software described herein are provided to you subject to the following:

All technical data and computer software are commercial in nature and developed solely at private expense. Software is delivered as "Commercial Computer Software" as defined in DFARS 252.227-7014 (June 1995) or as a "commercial item" as defined in FAR 2.101(a) and as such is provided with only such rights as are provided in 3Com's standard commercial license for the Software. Technical data is provided with limited rights only as provided in DFAR 252.227-7015 (Nov 1995) or FAR 52.227-14 (June 1987), whichever is applicable. You agree not to remove or deface any portion of any legend provided on any licensed program or documentation contained in, or delivered to you in conjunction with, this User Guide.

Unless otherwise indicated, 3Com registered trademarks are registered in the United States and may or may not be registered in other countries.

3Com and the 3Com logo are registered trademarks of 3Com Corporation.

Intel and Pentium are registered trademarks of Intel Corporation. Microsoft, MS-DOS, Windows, and Windows NT are registered trademarks of Microsoft Corporation. Novell and NetWare are registered trademarks of Novell, Inc. UNIX is a registered trademark in the United States and other countries, licensed exclusively through X/Open Company, Ltd.

IEEE and 802 are registered trademarks of the Institute of Electrical and Electronics Engineers, Inc.

All other company and product names may be trademarks of the respective companies with which they are associated.

ENVIRONMENTAL STATEMENT

It is the policy of 3Com Corporation to be environmentally-friendly in all operations. To uphold our policy, we are committed to:

Establishing environmental performance standards that comply with national legislation and regulations.

Conserving energy, materials and natural resources in all operations.

Reducing the waste generated by all operations. Ensuring that all waste conforms to recognized environmental standards. Maximizing the recyclable and reusable content of all products.

Ensuring that all products can be recycled, reused and disposed of safely.

Ensuring that all products are labelled according to recognized environmental standards.

Improving our environmental record on a continual basis.

End of Life Statement

3Com processes allow for the recovery, reclamation and safe disposal of all end-of-life electronic components.

Regulated Materials Statement

3Com products do not contain any hazardous or ozone-depleting material.

Environmental Statement about the Documentation

The documentation for this product is printed on paper that comes from sustainable, managed forests; it is fully biodegradable and recyclable, and is completely chlorine-free. The varnish is environmentally-friendly, and the inks are vegetable-based with a low heavy-metal content.

CONTENTS

ABOUT THIS GUIDE

Conventions	2
Related Documentation	3
Accessing Online Documentation	3
Product Registration and Support	4

1 INTRODUCTION

Product Features	5
Security	5
Wireless Network Standards	6
Network Configuration and Planning	7
Example Configurations	8

2 INSTALLING THE BRIDGE

Unpacking the Bridge	9
Observing Safety Precautions	10
Deciding Where to Place the Bridge	11
Wall-Mounting the Bridge	11
Installing the Locking Bar	12
Placing the Bridge on a Flat Surface	13
Connecting the Bridge	14
Connecting to a Serial Device	14
Connecting to an Ethernet Device	15
About the Client List	15
Connecting to a Hub	15
Connecting to a Network Printer	16
Connecting to a Computer	16
Checking the LED Indicators	17
Attaching An External Antenna	18
Determining if you Need to Configure the Bridge	18
Using the 3Com Installation CD	21

3 CONFIGURING THE BRIDGE

- Using Secure Web Server Connection 23
- Using the 3Com Wireless Infrastructure Device Manager 24
- Using the Configuration Management System 27
 - Clearing and Applying System Configuration Settings 28
 - Changing System Properties 29
 - Setting IP Network Properties 30
 - Setting Wireless Network Properties 31
 - Setting Up an Ad-Hoc Network 33
 - Changing Wireless Security Settings 34
 - Changing RADIUS Settings 36
 - Changing SNMP Settings 37
 - Using the Access Control List 38
 - Serial Port 39
 - Resetting the Bridge 41
 - Restoring the Bridge to Factory Defaults 42
 - Upgrading the System 42
 - Changing the Administration Login Name and Password 44
 - Backing up a Configuration 44
 - Restoring a Configuration 44
 - Logging Out 45
 - Viewing Connection Status 45
 - Clearing the Ethernet Client List 45
 - Viewing System Summary 46

4 TROUBLESHOOTING

- Diagnosing Problems 47
- Disconnecting the Bridge 49
- Uninstalling Software and Documentation 49
- Upgrading Bridge Firmware 49

A COMMAND-LINE INTERFACE

- Logging In 51
- Logging Out 51
- Configuring the Bridge 52

B OBTAINING SUPPORT FOR YOUR 3COM PRODUCT

- Register Your Product to Gain Service Benefits 55
- Solve Problems Online 55
- Purchase Extended Warranty and Professional Services 56
- Access Software Downloads 56
- Contact Us 56
 - Telephone Technical Support and Repair 57

END USER LICENSE AGREEMENT

REGULATORY INFORMATION

ABOUT THIS GUIDE

This guide provides all the information you need to install and use the 3Com 11a/b/g Wireless Workgroup Bridge in its default state.

The guide is intended for use by IT managers and experienced network installation and administration professionals who have a basic knowledge of current networking concepts.



If the information in the release notes that are shipped with your product differ from the information in this guide, follow the instructions in the release notes.

Most user guides and release notes are available in Adobe Acrobat Reader Portable Document Format (PDF) or HTML on the 3Com World Wide Web site:

<http://www.3com.com/>

Conventions

Table 1 and Table 2 list conventions that are used throughout this guide.

Table 1 Notice Icons



Icon	Notice Type	Description
	Information note	Information that describes important features or instructions.
	Caution	Information that alerts you to potential loss of data or potential damage to an application, system, or device.
	Warning	Information that alerts you to potential personal injury.

Table 2 Text Conventions

Convention	Description
Screen displays	This typeface represents information as it appears on the screen.
Syntax	The word “syntax” means that you must evaluate the syntax provided and then supply the appropriate values for the placeholders that appear in angle brackets. Example: To change your password, use the following syntax: <pre>system password <password></pre> In this example, you must supply a password for <password>.
Commands	The word “command” means that you must enter the command exactly as shown and then press Return or Enter. Commands appear in bold. Example: To display IP information, enter the following command: <pre>get ipaddr</pre>
The words “enter” and “type”	When you see the word “enter” in this guide, you must type something, and then press Return or Enter. Do not press Return or Enter when an instruction simply says “type.”
Keyboard key names	If you must press two or more keys simultaneously, the key names are linked with a plus sign (+). Example: Press Ctrl+Alt+Del
Words in <i>italics</i>	Italics are used to: <ul style="list-style-type: none"> ■ Emphasize a point. ■ Denote a new term at the place where it is defined in the text. ■ Identify menu names, menu commands, and software button names. Examples: From the <i>Help</i> menu, select <i>Contents</i>. Click <i>OK</i>.

Related Documentation

In addition to this guide, each Bridge documentation set includes the following:

- Quick Start Guide—printed guide that describes basic installation.
- Online Help—product help systems that describe how to use the Configuration Management System and 3Com Wireless Infrastructure Device Manager.
- Release Note—printed note that describes important product information.
- README.TXT file—text file located on the 3Com Installation CD that describes last-minute product information.

Accessing Online Documentation

The CD supplied with your Bridge contains the following online documentation:

- 3Com 11a/b/g Wireless Workgroup Bridge User Guide
- 3Com Wireless Infrastructure Device Manager Online Help
- 3Com 11a/b/g Wireless Workgroup Bridge Configuration Management System Online Help

To access the online documentation from the CD:

- 1** Insert the 3Com Installation CD supplied with your Bridge in the CD-ROM drive.

The setup menu appears. If it does not appear, you can start the setup menu from the Windows Start menu. For example: *Start > Run > d:setup.exe*.

- 2** In the menu, click *View the Documentation* to view the Bridge User Guide.

To view the online help, install and launch the Wireless Infrastructure Device Manager or Configuration Management System. See Chapter 3 for instructions.

**Product
Registration and
Support**

To register your product with 3Com, go to the following Web page:

<http://esupport.3com.com>

For support information, see “Obtaining Support for your 3Com Product” on page 55 or log on to the 3Com Web site at

<http://www.3com.com> and navigate to the product support page.

1

INTRODUCTION

3Com wireless technology has all of the benefits of a local area network (LAN) without the constraints and expense of network wiring.

3Com 11a/b/g Wireless LAN products provide easy, affordable, flexible ways to extend wireless networks to more users. This guide shows how you can use the 3Com 11a/b/g Wireless Workgroup Bridge in your office or classroom to connect groups of wired Ethernet client devices to your wireless LAN.

Product Features

The 3Com 11a/b/g Wireless Workgroup Bridge includes a robust suite of standards-based security features, and supports wireless network standards including 802.11a and 802.11g.

Security

To protect sensitive data broadcast over the radio, 3Com supports Wireless Equivalent Privacy (WEP) RC4 64-bit, 128-bit and 152-bit shared-key encryption. 3Com strengthens this basic security mechanism with additional security features, including:

- MAC address access control lists
- IEEE 802.1x per-port user authentication with RADIUS server authentication support
- Temporal Key Integrity Protocol (TKIP)
- Advanced Encryption Standard (AES)
- WiFi Protected Access (WPA)
- Extensible Authentication Protocol (EAP) support: EAP-TTLS and PEAP

Wireless Network Standards

Understanding the characteristics of the 802.11a and 802.11g standards can help you make the best choice for your wireless implementation plans.

802.11a

Ratified in 2002, 802.11a is IEEE's more recent wireless standard. It operates at the 5 GHz band and supports data rates at up to 54 Mbps. For those organizations demanding even higher speeds, a "turbo mode" feature can boost throughput rates up to 108 Mbps. And because there are fewer devices in the 5 GHz band, there's less potential for RF interference. However, because it is at an entirely different radio spectrum, it is not compatible with 802.11g.

The higher spectrum provides about 50 m (164 ft) of coverage—about half what 802.11g offers.

Consider 802.11a when you need high throughput in a confined space and you are:

- Running high-bandwidth applications like voice, video, or multimedia over a wireless network that can benefit from a five-fold increase in data throughput.
- Transferring large files like computer-aided design files, preprint publishing documents or graphics files, such as MRI scans for medical applications, that demand additional bandwidth.
- Supporting a dense user base confined to a small coverage area. Because 802.11a has a greater number of non-overlapping channels, you can pack more wireless devices in a tighter space.

802.11g

802.11g operates in the 2.4 GHz band at up to 54 Mbps. Ratified in 2003, it supports the widest coverage—up to 100 m (328 ft). However, is subject to a greater risk of radio interference because it operates in the more popular 2.4 GHz band.

802.11b operates at up to 11 Mbps and supports coverage up to 100 m (328 ft).

Consider 802.11g when you need wider coverage and vendor compatibility and you are:

- Maintaining support for existing 802.11b users and the existing wireless investment while providing for expansion into 802.11g.
- Implementing a complete wireless LAN solution, including bridges, gateways, access points and clients; Wi-Fi certification guarantees compatibility among vendors.
- Providing access to hot spots in public spaces such as coffee shops or university cafeterias.

Network Configuration and Planning

The Bridge can operate in either *infrastructure* or *ad-hoc* mode, and can support a stand-alone wireless network configuration or an integrated configuration with 10/100 Mbps Ethernet LANs.

Operating in *infrastructure* mode and connected to an Ethernet hub, a single Bridge can combine up to 16 client devices—such as computers with network adapters and printers—into a multiclient *workgroup*. The workgroup associates with the wired network through a wireless LAN access point such as the 3Com 11a/b/g Wireless LAN Access Point. Infrastructure configurations extend your wireless LAN to devices that would otherwise have to be connected to the wired network.

Operating in *ad-hoc* mode, two or more Bridges can associate among themselves and communicate with one another at close range without an access point. You may wish to set up an ad-hoc network, for example, if a group is working away from the office, or if a group in the office needs to share files apart from the wired LAN.

Example Configurations

The following examples illustrate ways you can use the Bridge to configure Ethernet client devices into workgroups. (Details for setting up specific configurations are in “Installing the Bridge” on page 9.)

Wireless Infrastructure Network

You can connect several computers, including those with non-Windows operating systems, and network printers, as shown in Figure 1.

Figure 1 Wireless Infrastructure Network

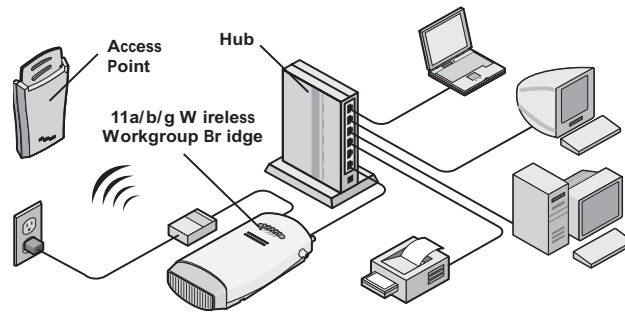

Workgroup Ad-Hoc Network

You can provide flexible wireless network association for small groups in areas that cannot be wired, as shown in Figure 2.

Figure 2 Workgroup Ad-Hoc Network

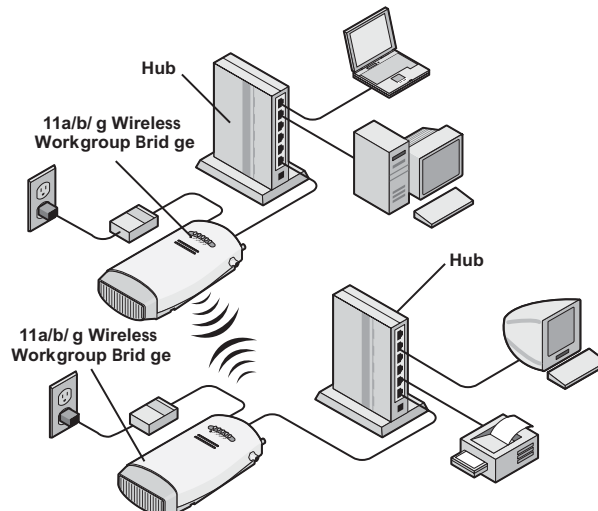

2

INSTALLING THE BRIDGE

This chapter contains the information you need to install and set up the Bridge. It covers the following topics:

- Unpacking the Bridge
- Observing Safety Precautions
- Deciding Where to Place the Bridge
- Connecting the Bridge
- Checking the LED Indicators
- Attaching An External Antenna
- Determining if you Need to Configure the Bridge
- Using the 3Com Installation CD

Unpacking the Bridge

Make sure that you have the following items, which are included with the Bridge:

- Power adapter and power cord.
- Standard Category 5 unshielded twisted pair (UTP) Ethernet cable.
- Locking bar (used for securing a wall-mounted installation).
- Rubber feet (four; used for a flat-surface installation).
- 3Com Installation CD.



You can directly connect the Bridge to a hub that does not have an uplink (MDIX) port, without the need of an Ethernet crossover cable.

For wall-mounting installations, you need the following items, which are not included with the Bridge:

- Mounting screws.
- Plastic anchors (for drywall mounting).

To secure the Bridge using the locking bar, you need a lock (not supplied).

Figure 3 shows the front view of the Bridge, including the LEDs and connecting ports. It also shows the cradle, which is used to mount the Bridge to a wall or to install the Bridge on a flat surface.

Figure 3 Bridge

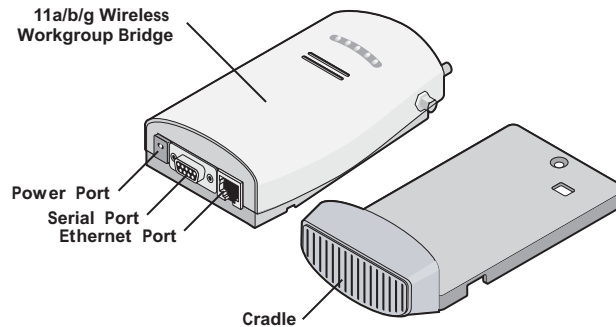

Observing Safety Precautions

This equipment must be installed in compliance with local and national building codes, regulatory restrictions, and FCC rules. For the safety of people and equipment, only professional network personnel should install the Bridge.



WARNING: To comply with FCC radio frequency (RF) exposure limits, a minimum body-to-antenna distance of 20 cm (8 in.) must be maintained when the Bridge is operational.



WARNING: To avoid possible injury or damage to equipment, you must use either the provided power supply or power supply equipment that is safety certified according to UL, CSA, IEC, or other applicable national or international safety requirements for the country of use. All references to power supply in this document refer to equipment meeting these requirements.



CAUTION: The 3Com power supply (part number 61-0107-000) input relies on a 16A rated building fuse or circuit protector for short circuit protection of the line to neutral conductors.

Deciding Where to Place the Bridge

Place the Bridge in a dry, clean location near the hub, computer, or printer that will be connected to the Bridge. The location must have a power source and be within the following distance of a Wi-Fi compliant wireless LAN access point or ad-hoc wireless station:

- For 802.11a compatibility, place the Bridge within 50 m (164 ft) of a Wi-Fi compliant wireless LAN access point.
- For 802.11b/g compatibility, place the Bridge within 100 m (328 ft) of a Wi-Fi compliant wireless LAN access point.

The location should be away from transformers, heavy-duty motors, fluorescent lights, microwave ovens, refrigerators, or other equipment that could cause radio signal interference.

Wall-Mounting the Bridge

The Bridge comes with a cradle for mounting on a wall. For additional security, the Bridge also comes with a locking bar, which can be used with a security lock (not provided) to lock the Bridge to the cradle after the Bridge is mounted to a wall.

To wall-mount the bridge:

- 1 Screw the cradle to a wall, as shown in Figure 4.

Figure 4 Wall-Mounting the Bridge

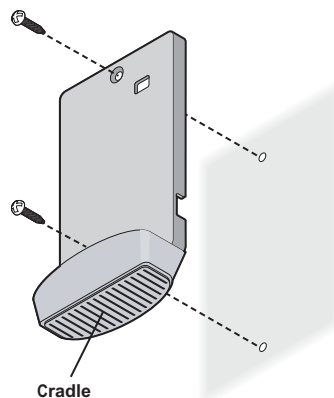

- 2 Route the power and Ethernet cables through the large opening in the cradle. Figure 5 shows a cable being routed under the cradle.

Figure 5 Routing Cable Under the Cradle

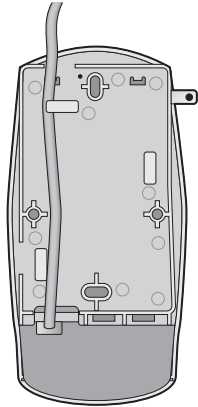

- 3 Connect the power and Ethernet cables to the ports on the Bridge.
- 4 Snap the Bridge onto the cradle.

Installing the Locking Bar

For additional security, install the locking bar in the cradle after the Bridge is mounted to the wall. Use your own lock to secure it in place.

To install the locking bar:

- 1 Insert the locking bar through the opening in the side of the cradle, as shown in Figure 6.

Figure 6 Inserting the Locking Bar

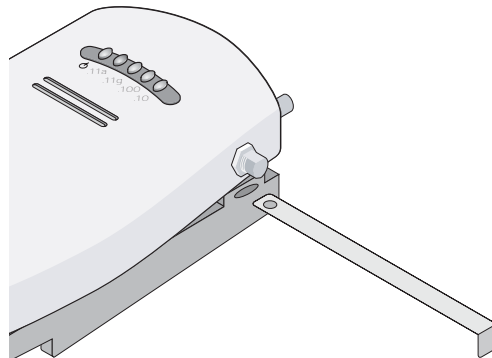

- 2 Push the locking bar through the opening until the hole on the locking bar is exposed.
- 3 Insert a lock through the hole on the locking bar, and then close the lock to secure it in place, as shown in Figure 7.

Figure 7 Securing the Locking Bar

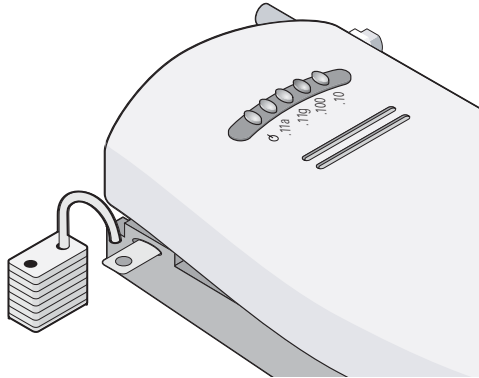

Placing the Bridge on a Flat Surface

The Bridge comes with four rubber feet that can be used to install the Bridge on a flat surface such as a table or desktop.



CAUTION: Do not place the Bridge on any type of metal surface. Select a location that is clear of obstructions and provides good reception.

Remove the backing from the rubber feet and attach them to the bottom of the cradle. After the rubber feet are installed, place the Bridge on a flat surface.

Connecting the Bridge

The Bridge has power, Ethernet, and serial ports, as shown in Figure 8. Before connecting the Bridge to an Ethernet device, connect the power.

Figure 8 Connecting the Power

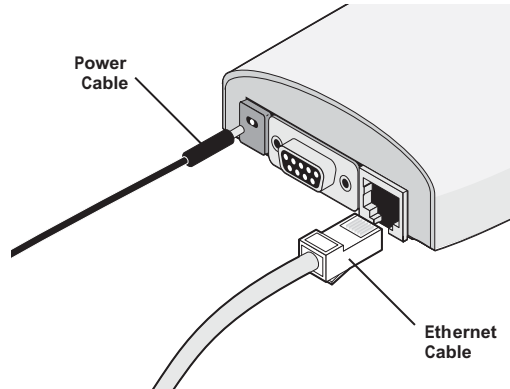

Connecting to a Serial Device

The Bridge can also be connected to a serial device, as shown in Figure 9. Serial cables come with a variety of connector sizes. If your connector is large and prevents the cradle from being attached to the Bridge, remove the end cap on the cradle. This allows the connector to extend through the cradle.

Figure 9 Connecting a Serial Cable

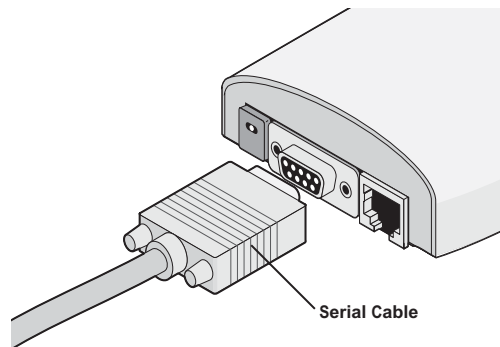

Connecting to an Ethernet Device

The Bridge is designed to be connected to an Ethernet client device such as a hub, computer, or printer.



CAUTION: To avoid the possibility of a transmission loop situation between the Bridge and an access point, which could disrupt network operation, do not connect a Bridge that is set in Wireless Client (Infrastructure) mode directly to the LAN (for example, through a wall port or through a hub that is connected directly to the LAN).

About the Client List

The Bridge supports up to 16 specific Ethernet client devices. It uses a *client list* of MAC addresses to keep track of specific devices that have been connected.

After 16 different devices have been connected, the client list is full, and you must clear it before the next new device can associate with the network through the Bridge.

To clear the list, you must access the Bridge's Configuration Management System. Details are in "Clearing the Ethernet Client List" on page 45.

Connecting to a Hub

You can supply network connections for up to 16 devices, such as computers and network printers, by connecting the Bridge to an Ethernet hub, as shown in Figure 10.

Figure 10 Connecting to a Hub

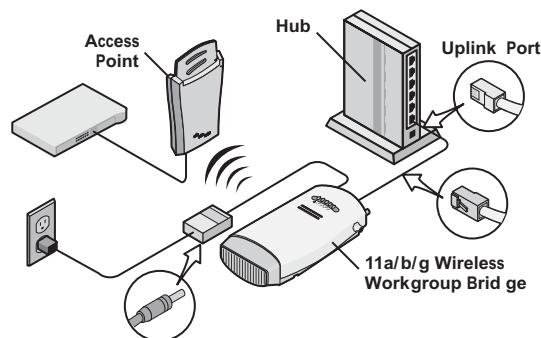

You can directly connect the Bridge to a hub that does not have an uplink (MDIX) port, without the need of an Ethernet crossover cable.

Connecting to a Network Printer

You can connect a network printer directly to the Bridge or to a hub that is connected to the Bridge. Used this way, the Bridge allows you to place network printers in areas that are not wired for Ethernet.

- 1 Configure the network printer as you would for connecting it to the wired LAN. For details on configuring the printer, see your printer documentation.
- 2 If necessary, configure the Bridge to associate with your access point.
- 3 Connect the Bridge to the power supply in its permanent location.
- 4 Connect the network printer directly to the Bridge as shown in Figure 11, or to a hub that is connected to the Bridge as shown in “Connecting to a Hub” on page 15.

Figure 11 Connecting to a Network Printer

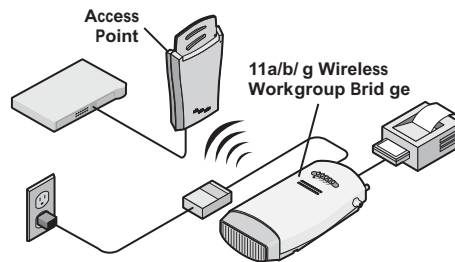

Connecting to a Computer

You can connect the Bridge directly to a computer as shown in Figure 12. Used this way, the Bridge can convert a desktop computer to a wireless computer. This connection also allows you to configure a Bridge before connecting it to another device.

Figure 12 Connecting to a Computer

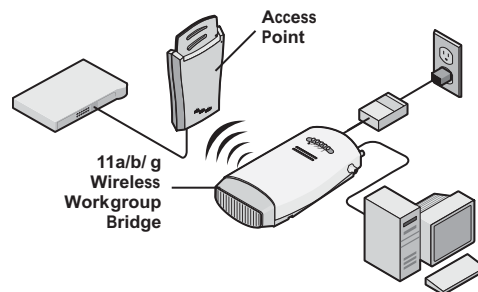

Checking the LED Indicators

When the Bridge is connected to power, LEDs indicate activity as follows:

Figure 13 LED Indicators

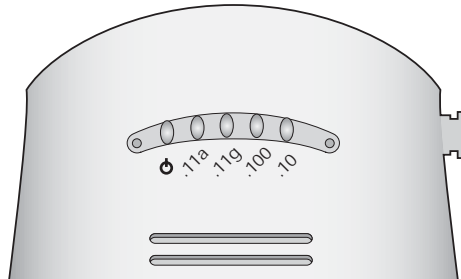

Table 3 LED Descriptions

LED	Color	Indicates
Power	Green	The Bridge is powered up and operating normally.
	Off	The Bridge is not receiving power or there is a fault with the power supply.
11a	Green (solid)	The Bridge has an 802.11a 5 GHz radio band connection.
	Green (blinking)	The Bridge is transmitting WLAN frames over an 802.11a 5 GHz radio band.
	Off	No link is present.
11g	Green (solid)	The Bridge has an 802.11g 2.4 GHz radio band connection.
	Green (blinking)	The Bridge is transmitting WLAN frames over an 802.11g 2.4 GHz radio band.
	Off	No link is present.
100	Green (solid)	The Bridge has a 100 Mbps Fast Ethernet connection.
	Green (blinking)	The Bridge has 100 Mbps Fast Ethernet activity.
	Off	No link is present.
10	Green (solid)	The Bridge has a 10 Mbps Ethernet connection.
	Green (blinking)	The Bridge has 10 Mbps Ethernet activity.
	Off	No link is present.

Attaching An External Antenna

The Bridge has two internal diversity dual-band antennas.

If you want to increase the range of the Bridge, an external antenna can be attached to the external antenna connector on the Bridge.

The 3Com-approved external antenna for this Bridge is the 3Com 2.4/5 GHz Omnidirectional Workgroup Bridge Antenna (3CWE501). For more information, go to www.3Com.com

Determining if you Need to Configure the Bridge

If your network has a DHCP server and no special security requirements, you can most likely use the Bridge just as it is shipped from the factory.



It takes approximately one to two minutes for the Bridge to determine if there is a DHCP server on the network.

View the Bridge's default settings on page 20 to determine whether or not you need to configure the Bridge for your network. If the factory defaults meet your requirements, you can connect the Bridge as described in "Connecting the Bridge" on page 14.

If your network does not have a DHCP server or is more complex, you may have to configure the Bridge and organize devices so that you can manage the wireless LAN easily and keep it secure. You can use the 3Com Wireless Infrastructure Device Manager (Widman) included on the 3Com Installation CD.



For non-U.S. versions of the Bridge, you need to set the Country mode. This is done when you first open the Bridge's Configuration Management System. See "Using the Configuration Management System" on page 27 for instructions.

Networks with a DHCP Server

If your network has a DHCP server, an IP address is automatically assigned to the Bridge. Use the 3Com Wireless Infrastructure Device Manager (Widman) included on the 3Com Installation CD to locate the Bridge on the network and view its IP address.

Alternatively, you can enter the Bridge's IP address into a web browser on a computer on the same subnet to view the Bridge's system status or change its configuration. See "Configuring the Bridge" on page 23 for instructions.

Networks without a DHCP Server

If your network does not have a DHCP server, the Bridge uses a default IP address (169.254.2.2) that is assigned at the factory. You can use that IP address to configure the Bridge, or you can assign a new IP address to the Bridge.

To verify that the Bridge is using the default IP address assigned at the factory:

- 1** Connect a computer directly to the Bridge using the supplied standard Category 5 UTP Ethernet cable.

See Figure 12 on page 16 for a connection diagram.

- 2** Enter the Bridge's default IP address (169.254.2.2) into the computer's web browser.
 - If the Configuration Management System starts, the Bridge is using the factory assigned IP address. You can configure the Bridge with the following login information:
 - Login name: admin
 - Password: none (blank)

See "Configuring the Bridge" on page 23 for detailed instructions.

- If the Configuration Management System does not start, the Bridge is on a different subnet than the computer. Install and start the 3Com Wireless Infrastructure Device Manager to discover the Bridge's IP address. See "Using the 3Com Wireless Infrastructure Device Manager" on page 24 for instructions.

Bridge Default Settings

Table 4 shows the Bridge configuration factory defaults.

Table 4 Factory Default Settings

Property	Default Setting
Device Name	3Com WWB
Device Location	None
Country	For U.S. versions, United States and Canada For non-U.S. version, set by the user
Client Mode	Support multiple wired Ethernet clients
IP Network Setting	Obtain IP address automatically
IP Address	Obtained automatically (with a DHCP server) 169.254.2.2 (without a DHCP server)
Subnet Mask	Obtained automatically (with a DHCP server) 255.255.0.0 (without a DHCP server)
Gateway IP Address	Obtained automatically (with a DHCP server) 0.0.0.0 (without a DHCP server)
Network Mode	Wireless Client (Infrastructure)
Radio Mode	Auto Select
Wireless LAN Service Area	Attach to any WLAN Service Area (ESSID) automatically
Channel Selection	Automatic Best Channel (uses access point setting)
Transmit Power	100%
Antenna Selection	Internal
Data Preamble	Long (if Network Mode is set to <i>Ad-Hoc</i>) Same as access point setting (if Network Mode is set to <i>Wireless Client [Infrastructure]</i>)
Security Setting	Open System (no security)
802.1x Authentication State	Disabled
SNMP	Enabled
Administration Login Name	admin
Administration Password	None (blank)
TFTP Server IP Address	None
FTP Server IP Address	None

Using the 3Com Installation CD

The 3Com Installation CD contains the following tools and utilities:

- **3Com Wireless Infrastructure Device Manager**—an administration tool that helps you select 3Com wireless LAN devices and launch their configurations in your Web browser.
- **3Com 3CDaemon Server Tool**—a firmware upgrade tool that can act in four different capacities:
 - As a TFTP Server, used for firmware upgrades as well as backup and restore functions.
 - As a SysLog Server, which is necessary to view SysLog messages.
 - As an optional TFTP Client.
 - As an optional FTP Server.

To use the 3Com Installation CD, you need a computer running one of the operating systems and browser listed in Table 5.

Table 5 Supported Operating Systems and Browser

Operating Systems	Windows XP Windows 2000 Windows NT 4.0 Windows Me Windows 98
Browser	Internet Explorer (latest version is recommended)

To install one of the tools on your computer:

- 1 Turn on the computer.
- 2 Insert the 3Com Installation CD in the CD-ROM drive.
The setup menu appears. If it does not appear, you can start the setup menu from the Windows Start menu. For example: *Start > Run > d:setup.exe*.
- 3 In the menu, click *Tools and Utilities*.
- 4 In the next screen, click the tool you want to install.
- 5 Follow the instructions on the screens to complete the installation.
Reboot the computer if prompted to do so.
- 6 Launch the tool from the Windows Start menu.

For details on using the Wireless Infrastructure Device Manager, see “Using the 3Com Wireless Infrastructure Device Manager” on page 24.

For instructions on using the 3CDaemon Server Tool, see the application’s online help.

3

CONFIGURING THE BRIDGE

If the Bridge configuration that was set at the factory does not meet your network requirements, or if you want to customize the settings, you can use these tools to change the configuration:

Table 6 Configuration Tools

Configuration Tool	Description
3Com Wireless Infrastructure Device Manager (Widman)	Helps you locate 3Com wireless LAN devices on the network, select a device and view its properties, and launch the device's configuration in your Web browser. See "Using the 3Com Wireless Infrastructure Device Manager" on page 24 for details.
3Com 11a/b/g Wireless Workgroup Bridge Configuration Management System	Resides on the Bridge and lets you configure the Bridge through your Web browser. See "Using the Configuration Management System" on page 27 for details.
Command-line Interface	Allows you to view and modify the Bridge configuration from a terminal or PC through a Telnet connection. See Appendix A, "Command-Line Interface" for details.

Using Secure Web Server Connection

The Bridge can be configured using Secure Socket Layer (SSL) technology, which is used to encrypt data exchanged between the computer and the Bridge during a configuration session.

Without SSL enabled, data is exchanged in the form of plain text and can be intercepted during the configuration session.

You must enable the HTTPS option to establish a secure session. See "WebUI Protocol" in Table 9 on page 30 for instructions.

Using the 3Com Wireless Infrastructure Device Manager

The 3Com Wireless Infrastructure Device Manager (Widman) helps you locate 3Com wireless LAN devices on the network, select a device and view its properties, and launch the Configuration Management System in your Web browser.

The Wireless Infrastructure Device Manager must be installed on a computer that:

- Has a working Ethernet adapter.
- Is running Internet Explorer and one of the Windows operating systems listed in “Using the 3Com Installation CD” on page 21.
- Is on the same subnet as the Bridge.



See “Using the 3Com Installation CD” on page 21 for installation instructions.

The device to be configured using the Wireless Infrastructure Device Manager must be:

- Connected to power.
- Wired to the network, associating with the wireless network, or, in some cases with the Bridge, connected directly to the computer.



If there is more than one device with the same name in the network (for example, 3Com WWB), make a note of the MAC address of the device you want to select so that you can identify it in the device manager.

If you do not have a DHCP server on your network, it can take up to one minute for a device to become discovered after it has been powered up.

To use the 3Com Wireless Infrastructure Device Manager:

- 1 Launch the device manager by selecting *Start > Programs > 3Com Wireless > Wireless Infrastructure Device Manager*.

If you have more than one network adapter installed on your computer, you may be prompted to choose a network adapter. Choose the appropriate adapter and click *OK*.

The Wireless Network Tree appears in the 3Com Wireless Infrastructure Device Manager window, as shown in Figure 14.

The tree lists all WLAN service areas on the network and expands to show the 3Com wireless LAN devices that are associated to each service area.

Devices in a different subnet than your computer are identified with exclamation points (!). You can refresh this display by clicking *Refresh*. You should refresh the display, for example, after you change a device IP address.

Figure 14 Wireless Infrastructure Device Manager Wireless Network Tree

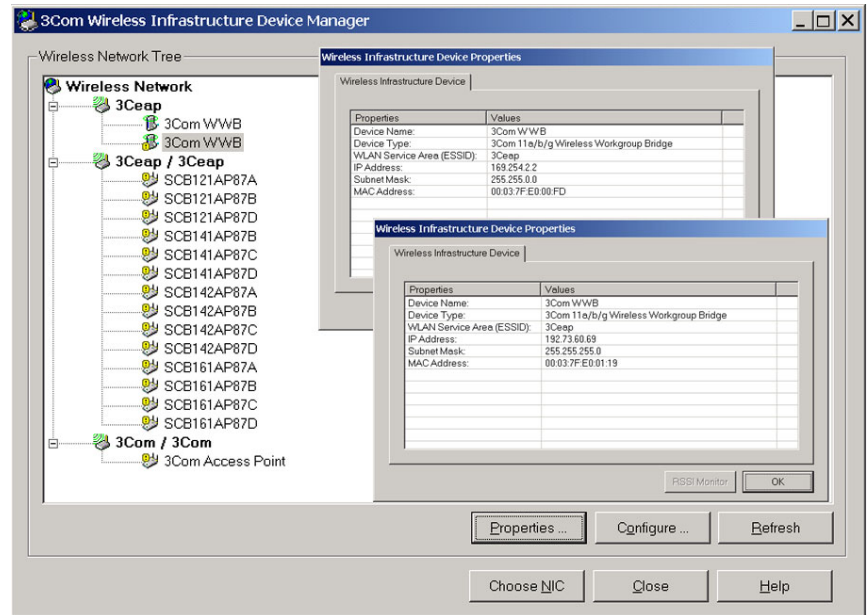

- 2 In the Wireless Network Tree, select the device you want to configure.

If more than one wireless LAN device appears in the tree and you are not sure that you have selected the right one, click *Properties* and check the MAC address to verify that it is the one you want.
- 3 Click *Configure*.
 - If the selected device is on the same subnet as your computer, the Configuration Management System main page appears in your Web browser. See “Using the Configuration Management System” on page 27, for details.
 - If the selected device is on a different subnet, the device manager helps you to assign an IP address on the same subnet as your computer, as shown in Figure 15. You may accept the address offered or enter an address and click *Next*.

Figure 15 Wireless Infrastructure Device Manager Pre-IP Configuration

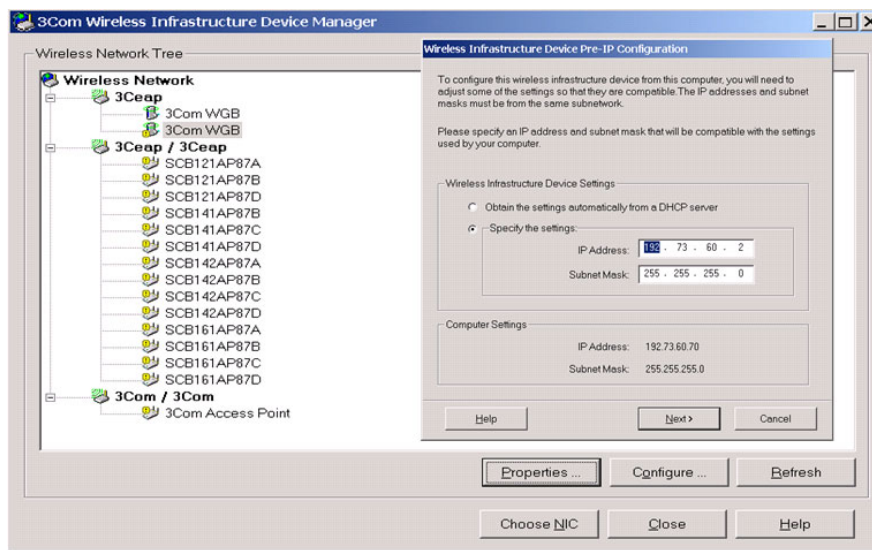

- The next window prompts for an administrative password to allow the new IP address to be set. If this is the first time the device is being configured, leave the password field blank and click *Next*.

The configuration main page appears in your Web browser. See “Using the Configuration Management System” on page 27 for details.

Table 7 describes the functions of the buttons in the 3Com Wireless Infrastructure Device Manager window.

Table 7 Infrastructure Device Manager Options

Button	Description
Properties	Displays the following properties of the selected device: Device Name, Device Type, Wireless LAN Service Area (ESSID), IP Address, Subnet Mask, and MAC Address.
Configure	Launches the Configuration Management System for the selected device. If the selected device is on a different subnet, you are prompted to assign an address on the same subnet as your computer.
Refresh	Scans the network and displays the connected 3Com 11a/b/g Wireless LAN devices.
Choose NIC	If your computer has more than one network interface card installed, allows you to choose which card to use.
Close	Closes the device manager window and ends the session.
Help	Launches the device manager help page in your browser.

Using the Configuration Management System

The 3Com11a/b/g Wireless Workgroup Bridge Configuration Management System resides on the Bridge and lets you configure the Bridge through your Web browser.

To use the Configuration Management System, the computer you are using to connect to the Bridge must be located on the same subnet as the Bridge.

There are two ways to access the Configuration Management System:

- Enter the IP address of the Bridge in your computer's web browser.
- Start the 3Com Wireless Infrastructure Device Manager, locate the Bridge, and then click *Configure*.



*For non-U.S. versions of the Bridge, when you first open the Configuration Management System you are prompted to select the country in which the Bridge is operating. Select the country in which the Bridge is installed to ensure compliance with local regulations, and then click *Apply*.*

When you first open the Configuration Management System, you are prompted for a user name and password:

- User name — admin
- Password — blank (press enter)

The Configuration Management System displays the Connection Status page, as detailed in Table 8.

Table 8 Connection Status Page

Property	Description	Default Value
Connection	The MAC address of the associated access point.	N/A
Network Type	The type of network for which the Bridge is configured: <i>Wireless Client (Infrastructure)</i> or <i>Ad-hoc (Peer-to-Peer)</i> .	Wireless Client (Infrastructure)
SSID	The Service Set ID.	Varies (Infrastructure) 3Com (Ad-Hoc)

Table 8 Connection Status Page (continued)

Radio Mode	The radio channel over which the Bridge is communicating with clients.	2.4 GHz 54 Mbps (802.11g)
Current Channel	The channel over which the Bridge is communicating with clients.	N/A
Security	The type of security for which the Bridge is configured.	Open System (no security)
Rx Data Rate (Mbps)	The rate at which the Bridge is receiving information.	N/A
Tx Data Rate (Mbps)	The rate at which the Bridge is transmitting information.	N/A
Link Quality	The normalized transmitted data rate (that is, the current data rate over the maximum data rate). Note: Link Quality is shown in Infrastructure mode only.	N/A
Signal Strength	The strength of the radio signal that the Bridge detects.	N/A
Activity (Packets Rx)	The number of packets the Bridge has received.	N/A
Activity (Packets Tx)	The number of packets the Bridge has transmitted.	N/A
IP Address	The IP address of the Bridge.	Varies

Clearing and Applying System Configuration Settings

The pages in the Configuration Management System have two buttons: *Clear* and *Apply*.

- *Clear* returns the settings to the values they were when you last clicked *Apply*.
- *Apply* stores the settings permanently in the nonvolatile flash memory. After you click *Apply*, the new settings take effect and you can see the changes on the System Summary page.



CAUTION: *Your changes are lost if you forget to click Apply before: moving to a new configuration page, resetting the device, or closing the browser.*

Changing System Properties

Under System Configuration, click *System Properties*. The System Properties page displays the properties of the selected Bridge. You can change properties by entering a value in a field (see Table 9). When you are finished, click *Apply*. Table 9 describes the properties.

Table 9 System Properties Page

Property	Description	Default Value
Device Name	This name appears in the System Summary window. You can change the default name to one of your choice.	3Com WWB
Device Location	If you use the default device name, entering the location is optional.	N/A
Client Mode	<p>This setting allows the Bridge to support single or multiple Ethernet clients attached to the Bridge.</p> <p><i>Support Single Wired Ethernet Client</i> is used only when the Bridge is used for replacement of a 3Com Ethernet Client Bridge. Select a MAC option:</p> <ul style="list-style-type: none"> ■ <i>Capture</i>: Each time the Bridge is powered on, it captures its MAC address from the first packet it receives on the Ethernet port. The Bridge detects and uses the same MAC address as the device plugged into the Ethernet port. <p>The Bridge uses the previously captured MAC address upon power-on until the first packet is received on the Ethernet port.</p> <ul style="list-style-type: none"> ■ <i>Dynamic</i>: The Bridge changes its MAC address each time the device plugged into the Ethernet port changes. <p>The Bridge detects the MAC address of the device plugged into the Ethernet port and uses that as its own. The Bridge uses the built-in MAC address upon power-on until a packet is received on the Ethernet port.</p> <ul style="list-style-type: none"> ■ <i>Built-in</i>: The Bridge uses the manufacturing radio MAC address as default. 	Support multiple wired Ethernet clients

Table 9 System Properties Page (continued)

Web GUI Protocol	This setting allows users to enable the secure data exchange scheme over SSL during a configuration session. <ul style="list-style-type: none"> ■ HTTPS — enables SSL technology. ■ HTTP — disables SSL technology. 	HTTP
------------------	---	------

Setting IP Network Properties

Under System Configuration, click *IP Network*. The IP Network Properties page appears, where you can change the settings shown in Table 10.

If you change the IP address and click *Apply*, you cannot continue to configure the device using the old IP address. Therefore, you must do the following steps after changing the IP address:

- 1 Close your browser.
- 2 Return to the 3Com Wireless Infrastructure Device Manager and click *Refresh*.
- 3 Select the device and click *Configure* to start a new configuration session.

Table 10 describes the IP Network properties.

Table 10 IP Network Properties Page

Setting	Description
IP Network Setting	This setting allows you to change the IP address of the device. To let the device get an IP address automatically from a DHCP server, select <i>Obtain an IP address automatically</i> and click <i>Apply</i> . To specify an IP address, select <i>Specify an IP address</i> , enter the IP address parameters in the spaces provided, and click <i>Apply</i> .
IP Address	When <i>Specify an IP address</i> is selected, enter the IP address in the space provided, and click <i>Apply</i> .
Subnet Mask	When <i>Specify an IP address</i> is selected, enter the Subnet Mask in the space provided, and click <i>Apply</i> .
Gateway IP Address	When <i>Specify an IP address</i> is selected, enter the Gateway IP Address in the space provided, and click <i>Apply</i> .

Setting Wireless Network Properties

Under System Configuration, click *Wireless Network*. The Wireless Network Properties page appears, where you can select different wireless settings, as described in Table 11. When you are finished, click *Apply*.

Table 11 Wireless Network Page

Setting	Description
Network Mode	<p>Select <i>Wireless Client (Infrastructure)</i> to associate with an access point.</p> <p>Select <i>Ad-hoc (Peer-to-Peer)</i> to join or form an ad-hoc network.</p>
Radio Mode	<p>See “Network Configuration and Planning” on page 7 for information on selecting the best Radio Mode for your network.</p> <p>Select <i>Auto Select</i> to have the Bridge select the best Radio Mode automatically.</p> <p>Select <i>802.11a</i> to set the Bridge to operate in 802.11a mode.</p> <p>Select <i>802.11a Turbo</i> to set the Bridge to operate using 802.11a Turbo mode. In some countries you can use Turbo Mode, allowing the Bridge to operate with a data rate of up to 108 Mbps. If Turbo Mode is not allowed in your country, this option is not available.</p> <p>Select <i>802.11b/802.11g</i> to set the Bridge to operate in 802.11b/802.11g mode.</p> <p>Select <i>802.11g Turbo</i> to set the Bridge to operate using 802.11g Turbo mode. (See <i>802.11a Turbo</i> description above.)</p>
Wireless LAN Service Area	<p>Select <i>Attach to any WLAN Service Area (ESSID) automatically</i> to allow the Bridge to associate with any access point without specifying the ESSID. In this mode, the Bridge uses the ESSID of the access point with the best signal strength. This mode is not available when the network mode is <i>Ad-hoc (Peer-to-Peer)</i>.</p> <p>Select <i>Specify the Wireless LAN Service Area</i> to allow the Bridge to associate only with access points with the same service area. You may enter the WLAN service area name or select it from the list. You must specify the WLAN service area when the network mode is <i>Ad-hoc (Peer-to-Peer)</i>.</p> <p>To maintain a wireless association, the WLAN service area on a Bridge and the access point with which it is associated must match exactly. Therefore, if the Bridge is set to <i>Specify the WLAN Service Area</i> and you change the access point WLAN service area, make sure to also change the Bridge WLAN service area.</p>

Table 11 Wireless Network Page (continued)

Channel Selection	<p>If Radio Mode is set to <i>Auto Select</i>, you do not have the following options to choose from.</p> <p>When the network mode is <i>Wireless Client (Infrastructure)</i>, a user may have the Bridge automatically select an appropriate channel by using <i>Automatic Best Channel</i> or specify the channels by using <i>Specify Channel</i>.</p> <p>When the network mode is <i>Ad-hoc (Peer-to-Peer)</i> you may specify channel selection as follows:</p> <ul style="list-style-type: none"> ■ <i>Automatic Best Channel</i>—When this option is enabled, the Bridge scans the primary channels. If the Bridge is establishing a new ad-hoc network, it chooses the channel with the least number of packets. If the Bridge is joining an existing ad-hoc network, it selects the channel in use. ■ <i>Specify Channel</i>—Click the button preceding this option and enter the Advanced Wireless Network page. On this page, you can choose channels from the Channel list.
Transmit Power	<p>This option specifies the level of transmission power. Select one of the values (100%, 50%, 25%, 12%, min) from the drop-down menu.</p> <p>Decrease the Transmit Power setting if more than one Bridge is using the same channel frequency.</p>
Antenna Selection	<p>Select an antenna for the radio signal:</p> <ul style="list-style-type: none"> ■ <i>Internal</i> — this default setting should be used in most circumstances. ■ <i>External and one internal antenna</i> — this setting automatically determines which antenna is best for sending packets to individually attached clients. Choose this setting if the Bridge is located in a place that is surrounded or hindered by metal paths or walls.
Data Preamble	<p>To increase performance, click <i>Short (Enhanced performance)</i>. When equipment that does not support short preamble is also being used, click <i>Long (Wi-Fi Interoperable)</i>.</p> <p>Note: The Data Preamble option is available in ad-hoc mode only. This option is not available for 802.11a and 802.11a Turbo modes.</p>

Setting Up an Ad-Hoc Network

Operating in ad-hoc mode, two or more Bridges can associate among themselves to form an ad-hoc network without the intervention of an access point. You may wish to set up an ad-hoc network, for example, if a group is working away from the office, or if a group in the office needs to share files apart from the wired LAN.



CAUTION: To ensure correct operation, the settings on the two Bridges must match exactly. To avoid the possibility of losing wireless association while you are configuring, 3Com recommends that you connect the Bridge directly to the computer.

- 1 Connect the first Bridge to power and use the Ethernet cable to connect it to the computer.
- 2 Use the 3Com Wireless Infrastructure Device Manager to select the Bridge and launch the Configuration Management System.
- 3 Under System Configuration, click *Wireless Network*.
- 4 In the Wireless Network page:
 - a Locate the Network Mode field and select *Ad-hoc (Peer-to-Peer)*.
 - b Specify the Wireless LAN Service Area and the Channel Selection as described in “Setting Wireless Network Properties” on page 31.
 - c Set the *Data Preamble*.
 To increase performance, select *Short (Enhanced performance)*. When equipment that does not support short preamble is also being used, select *Long (Wi-Fi Interoperable)*. When you are finished, click *Apply*.
 Security settings default to *Open System* (no security). Optionally, you can set different WEP settings as described in “Changing Wireless Security Settings” on page 34.
- 5 When you are finished, click *Apply*.
- 6 End the browser session.
- 7 Repeat steps 1–6 with the second Bridge. Make sure you configure Bridge settings to match exactly. When you are finished, click *Apply* and end the browser session.
- 8 Connect the Ethernet devices to the Bridges. If you use hubs, make sure that the Bridges are connected through the hub uplink ports.

Changing Wireless Security Settings

Under *System Configuration*, click *Wireless Security*. The Wireless Security Settings page appears, where you can select the type of security to be used on the Bridge.

The Bridge can be configured to support three types of data encryption: WEP, TKIP, and AES. After selecting a data encryption type, you can select an authentication type.

The following sections describe the settings. To maintain wireless association, the settings on clients and the access points they associate with (or other members of an ad-hoc network) must match exactly.

No Security (Open System)

No encryption is used. The network communications could be intercepted by unintended recipients.

40/64-bit Shared Key (WEP)

This option encrypts the wireless transmissions to protect data, but still allows communication among compatible wireless LAN clients and access points from third-party manufacturers that are Wi-Fi certified.

This type of security requires you to set up encryption in one of the following ways:

- **String**—For use only with other 3Com 11a/b/g wireless devices, an encryption string is a case-sensitive string of characters between 6 and 30 characters long. To enter the string, select *Enter a string to generate shared keys*. Then type any combination of letters and numbers in the space provided and select *Apply*.
- **Shared keys**—Hexadecimal keys are sequences of hexadecimal digits arranged into four keys. A hexadecimal digit may be a letter from A to F or a number from 0 to 9. This type of encryption is compatible with equipment from other manufacturers that use Wi-Fi certified 40-bit encryption. To enter the keys, select *Specify shared keys and which to use*. In the shared keys window, enter all the keys in the provided spaces, then select a radio button in the Selected Key column to specify which key to use and select *Apply*.

104/128-bit Shared Key

This option can be used with other 3Com 11a/b/g Wireless LAN devices and with equipment from certain manufacturers that also support 128-bit shared key encryption. It provides a higher level of security than the 40-bit Shared Key (Wi-Fi) option and uses a more complicated type of encryption. This type of security requires you to set up encryption using a string or shared keys as described in “40/64-bit Shared Key (WEP)” on page 34.

128/152-bit Shared Key

This option can be used with other 3Com 11a/b/g Wireless LAN devices and with equipment from certain manufacturers that also support 152-bit shared key encryption. It provides a higher level of security than the 128-bit Shared Key option and uses a more complicated type of encryption. This type of security requires you to set up encryption using a string or shared keys as described in “40/64-bit Shared Key (WEP)” on page 34.



Click the button preceding Specify Shared Keys and Which Key to Use to create or modify WEP keys.

TKIP

The Temporal Key Integrity Protocol (TKIP) option improves data encryption over WEP scheme by dynamically updating the encryption keys every 10,000 packets. TKIP provides per-packet key mixing, a message integrity check, and a re-keying mechanism.

To use TKIP:

- 1 On the Wireless Security page, select *TKIP*.
- 2 Select *WPA-PSK* for home network or *WPA* for the scenarios where RADIUS servers are employed:
 - *WPA-PSK*: Enter a pass-phrase key or hexadecimal key. The key can be generated based on a pass-phrase or a sequence of manually entered 64 hexidecimals. The 64 hexidecimals can be automatically generated by selecting *Generate a Random Key*.
 - *WPA*: Select an authentication scheme (TTLs or PEAP), a relevant authentication type, a user name, and a password. If you select TLS, enter an upload file name and password, and then select *Upload*.
- 3 Select *Apply*.

Click the button of TKIP to set TKIP relevant parameters.

AES

The Advanced Encryption Standard (AES) option uses the highest security cipher for data encryption.

To use AES:

- 1 On the Wireless Security page, select *AES*.
- 2 Select *WPA-PSK* for home network or *WPA* for the scenarios where RADIUS servers are employed:
 - *WPA-PSK*: Enter a pass-phrase key or hexadecimal key. The key can be generated based on a pass-phrase or a sequence of manually entered 64 hexidecimals. The 64 hexidecimals can be automatically generated by selecting *Generate a Random Key*.
 - *WPA*: Select an authentication scheme (TTLs or PEAP), a relevant authentication type, a user name, and a password. If you select TLS, enter an upload file name and password, and then select *Upload*.
- 3 Select *Apply*.

Click the button of AES to set or modify AES relevant parameters.

Changing RADIUS Settings

Under *System Configuration*, click *RADIUS*. The RADIUS page appears, where you can set the primary and secondary RADIUS Server settings.

This page allows for configuration of a Remote Access Dial-in User Service (RADIUS) server for authentication purposes in 802.1x networks. You can change the settings by entering values in the fields as described in Table 12. When you are finished, select *Apply*.

Table 12 RADIUS Authentication Server Settings

Setting	Description
802.1x Authenticator State	Enable or disable RADIUS authentication by selecting <i>Enable</i> or <i>Disable</i> .
Primary RADIUS Server	Enter the IP address of the primary RADIUS Authentication Server. Make sure this address matches the address set in the RADIUS Authentication software.
Primary RADIUS Port	Enter the port number of the primary RADIUS Authentication Server. Make sure this number matches the number set in the RADIUS Authentication software. The default port is 1812.
Primary RADIUS Secret	Enter the password of the primary RADIUS Authentication Server. Make sure this password matches the password set in the RADIUS Authentication software.

Table 12 RADIUS Authentication Server Settings (continued)

Secondary RADIUS Server	Enter the IP address of the secondary RADIUS Authentication Server. Make sure this address matches the address set in the RADIUS Authentication software.
Secondary RADIUS Port	Enter the port number of the secondary RADIUS Authentication Server. Make sure this number matches the number set in the RADIUS Authentication software. The default port is 1812.
Secondary RADIUS Secret	Enter the password of the secondary RADIUS Authentication Server. Make sure this password matches the password set in the RADIUS Authentication software.

Changing SNMP Settings

Under System Configuration, click *SNMP* to display and change settings for the Simple Network Management Protocol.

To communicate with the Bridge, the SNMP agent must first be enabled and the Network Management Station must submit a valid community string for authentication.

Table 13 SNMP Settings

Setting	Description
SNMP	Enables or disables SNMP.
Contact	Sets the location string that describes the system location. Maximum length: 255 characters.
Community Name (Read Only)	Specifies a community string with read-only access. Authorized management stations are able to retrieve MIB objects. Maximum length: 23 characters.
Community Name (Read/Write)	Specifies a community string with read-write access. Authorized management stations are able to both retrieve and modify MIB objects. Maximum length: 23 characters.
Trap Destination IP Address	Enter the IP address of the trap manager that will receive these messages.
Trap Destination Community Name	Enter the community name of the trap manager that will receive these messages.

Using the Access Control List You can determine which clients can access the Bridge using the Access Control List.

Follow these steps:

- 1 Launch the Configuration Management System.
- 2 Under System Configuration, click *Access Control List*.
- 3 In the Access Control List page, click *Add*.

The Access Control List New ACL page appears.

- 4 Enter the MAC address of the client you want to add to the Access Control List, and select the permission type.
- 5 Repeat steps 3 and 4 for each client.
- 6 Select the Access Control List (ACL) Type:
 - Allow—allows the client to access the Bridge.
 - Deny—prohibits the client from accessing the Bridge.



CAUTION: *Make sure that the MAC address of the computer through which you are configuring the Bridge is included in the control list if you want to set the access control type to Allow. If you want to set the access control type to Deny, make sure that the MAC address of the computer is not included in the access control list. Failure to do so results in access to the Bridge being blocked; the Bridge will no longer be configurable through the computer.*

- 7 Click *Save*.

To delete a client from the Access Control List, highlight the client and then click *Delete*.

Serial Port Under System Configuration, click *Serial Port* to set up network serial port operation.

About UART

A Universal Asynchronous Receiver/Transmitter (UART) is the fundamental hardware for serial communication, controlling the speed and method of data transfer of the serial port.

Applications utilizing a network serial port between an RS-232 interface and a wireless device use a TCP/IP socket connection. Any program that uses standard TCP/IP network sockets may be used to communicate with the serial port of the Bridge. Once a socket is established to the Bridge, any data written to the socket is sent out the serial port of the Bridge. At the same time, any data received by the serial port of the Bridge is returned via the socket connection.

The Bridge network serial port may be used in two modes:

- Server Mode — TCP Listen Port
- Client Mode — TCP Connect Port

In *Server Mode*, the Bridge waits for a TCP/IP socket connection to be made by the network program with which it will communicate. Server Mode should be used if you have a central server that expects to open a TCP/IP socket connection to the Bridge.

In *Client Mode*, the Bridge establishes a socket connection to the IP address and port number specified in the configuration. Client Mode should be used if your system expects the Bridge to open a TCP/IP socket connection to a central server.

Configuring UART Settings

For proper operation, it is imperative that these settings always match the settings of the device to which the bridge is connected via the RS-232 port. There are two groups of parameters that need to be configured to accomplish this task: UART Settings and Flow Control Settings.

Flow control is the process of adjusting the flow of data from one device to another to ensure that the receiving device can handle all of the incoming data.

To configure the UART settings:

- 1 Select the baud rate of your device.

The baud rate indicates the data transfer rate of the serial port. The baud rate ranges from 300 to 115200 bits per second (bps). Standard rates are 300, 1200, 2400, 9600, 19200, 38400, 57600, 115200.

- 2 Determine the data bits setting of the device you are connecting to the Bridge, then set the *Data Bits* setting for the bridge that matches the data bits setting of that device.

The Data Bits setting determines the number of bits used to transmit data. The possible values are 7 and 8.

- 3 Determine the stop bits setting of the device you are connecting to the Bridge, then set the *Stop Bits* setting on the Bridge that matches the stop bits setting of that device.

The *Stop Bits* setting determines the number of bits used to represent an end of a character. The value can be 1 or 2.

- 4 Determine the parity bit setting of the device you are connecting to the Bridge, then set the *Parity Bit* setting on the Bridge that matches the parity bit setting of that device.

The *Parity Bit* setting is used to check for correct data transmission. Options are: none, even, and odd.

- 5 Set the flow control setting.

Flow control becomes an important factor when one of the devices is capable of transmitting data at a rate faster than the other can receive it. There are two basic types of flow control, hardware and software.

Configuring Operation Mode

- Select *CLI Console* if you want to configure the Bridge through CLI commands.

Attach your computer to the serial port on the Bridge, and then configure the Bridge through the computer.

- Select *Network Serial Port* to establish a TCP/IP socket with a remote computer in either infrastructure or ad-hoc mode. This allows you to do data communication with the remote computer, rather than configure the Bridge.

Configuring Network Serial Port Settings

For Server Mode, click *Server Mode* and enter the port number to which the Bridge connects in the *List on port* field. The default port number is 4000.

For Client Mode, select *Client Mode* and enter the IP address and port number to which the Bridge connects. The default port number is 4000.

Applying Settings

After you set the UART settings, operation mode, and network serial port settings, select *Apply* to make the settings take effect.

The socket can be substantially established between a client and server; that is, a Bridge in server mode and the other in client mode. The Bridge with the Network Serial Port option set cannot work alone. Generally, a Bridge is set to server mode first, which listens to a designated port. The other Bridge is then set to client mode, which connects to the designated port on the IP address of the Bridge set to server mode.

Resetting the Bridge

If the Bridge stops responding correctly, you can perform a reset, which disrupts the network association temporarily, but does not affect Bridge configuration settings that have already been applied with *Apply*.

To reset the Bridge, under Tools, click *Reset Wireless Workgroup Bridge*. In the next page, click *Reset*.

The Bridge can also be reset using the Wireless Infrastructure Device Manager (Widman). Right-click the Bridge in Widman, and then select *Reset*.

Restoring the Bridge to Factory Defaults

You can restore Bridge settings to the defaults that were set at the factory either manually or through software.

To restore the settings manually, insert a pointed object (such as the end of a straightened paper clip) into the reset hole on the back of the unit near the RJ-45 connector and hold for five seconds.

To restore the settings through software:

- 1 Under Tools, click *Restore Factory Defaults*.
- 2 Click *Restore*.

If the Bridge was using an IP address setting other than the default, restoring the factory defaults will change the IP address. If you want to continue configuring the Bridge, do the following:

- 1 Close your browser.
- 2 Return to the 3Com Wireless Infrastructure Device Manager and click *Refresh*.
- 3 Select the device and click *Configure* to start a new configuration session.

Upgrading the System

You can download firmware updates or updates of the Configuration Management System from the 3Com Web site and install those updates on the Bridge.

Options for upgrading the system include using a Trivial File Transfer Protocol (TFTP) server or File Transfer Protocol (FTP) server. The Bridge acts as a TFTP or FTP client to receive the download. Alternatively, you can use the HTTP option and upload the firmware from a downloaded file placed on your computer.

Information regarding upgrade availability and procedures can be obtained from the 3Com Web site as follows:

- 1 Log on to the 3Com Web site at **<http://www.3com.com>**.
- 2 Navigate to the product support page for the 3Com 11a/b/g Wireless Bridge to access the downloads and instructions.
- 3 Follow the instructions at the 3Com Web site.

Using TFTP

The general instructions for installing the upgrade using TFTP are:

- 1 Launch the Configuration Management System.
- 2 Under Tools, click *Upgrade System*.
- 3 Select TFTP.
- 4 Enter the file name for the firmware.
- 5 Enter the IP address of the TFTP server where the upgrade files are located.
- 6 Click *Upgrade*.

Using FTP (default)

The general instructions for installing the upgrade using FTP are:

- 1 Launch the Configuration Management System.
- 2 Under Tools, click *Upgrade System*.
- 3 Select FTP.
- 4 Enter the file name for the firmware.
- 5 Enter the IP address of the FTP server where the upgrade files are located.
- 6 Enter the user name, password, and filename in the appropriate fields.
- 7 Click *Upgrade*.

Using HTTP

The general instructions for installing the upgrade using HTTP are:

- 1 Launch the Configuration Management System.
- 2 Under Tools, click *Upgrade System*.
- 3 Select HTTP.
- 4 Click *Browse* to locate the downloaded firmware file.
- 5 Click *Upgrade* to start the upgrade process.

The upgrade takes place through the HTTP protocol from the local computer.

Changing the Administration Login Name and Password

3Com recommends that you set a password to protect against unauthorized access. After you set the password, you must enter it each time you launch the configuration for the device.

Under Tools, click *Change Administration Password*. The Change Administration Password page appears, where you can change the login name and administration password for the device. Enter the current password and new password in the spaces provided and click *Save*.

Backing up a Configuration

As part of system maintenance, you should save and back up the configurations of individual Bridges in case you need to reload them in the future. The backup saves all the parameters of the selected Bridge in a file on your computer. The file can be used later to restore the configuration on this or another bridge.

- 1 Set the Bridge parameters in the System Configuration pages.
- 2 Under Tools, click *Backup Wireless Workgroup Bridge*.
- 3 In the next page, click *Backup Now*.
- 4 Specify a name and location for the backup, and click *OK*.

Restoring a Configuration

If you have stored a backup configuration on your computer, you can restore the configuration as follows:

- 1 Under Tools, click *Restore Wireless Workgroup Bridge*.
- 2 In the next page, click *Browse* and select the backup file to upload.
- 3 Click *Restore*.

The configuration is restored and activated on the Bridge. This operation may cause the Bridge to reboot.

If the Bridge was using an IP address setting other than the backup, restoring the configuration will change the IP address. If you want to continue configuring the Bridge, do the following:

- 1 Close your browser.
- 2 Return to the 3Com Wireless Infrastructure Device Manager and click *Refresh*.
- 3 Select the device and click *Configure* to start a new configuration session.

Logging Out To log out of the Configuration Management System, click *Logout* under Tools.

Viewing Connection Status Under System Summary, click *Connection Status* to view a summary of the Bridge's current connection information. See Table 8 on page 27 for details.

Clearing the Ethernet Client List The Bridge supports up to 16 specific clients (for example, computers and printers) and keeps track of the clients with a list of their MAC addresses.

After the client limit is reached, you must clear the client list to allow a new client to associate with the network. For example, in a hub configuration with 16 clients connected, if you disconnect a desktop computer and connect a new laptop in its place, you must clear the client list to establish network association for the laptop.

To clear the Ethernet Client List:

- 1** Disconnect a client by unplugging its Ethernet cable from the hub or the Bridge.
- 2** Launch the Configuration Management System.
- 3** Under System Status, click *Ethernet Client List*.
- 4** In the Ethernet Client List page, click *Clear Client List*.

The Bridge erases the client list. Clients that remain connected to the Bridge are added to the list automatically when they next interact with the network.

- 5** Connect the new client by plugging its Ethernet cable into the hub or the Bridge.

Viewing System Summary

Under System Summary, you can view the following information:

Table 14 System Summary Page

Property	Description	Default Value
Device Name	The name assigned to the Bridge. You can change the default name to one of your choice by clicking <i>System Properties</i> under System Configuration.	3Com WWB
Device Location	If you use the default device name, entering the location is optional.	N/A
Country Code	The Country Code determines the available channels and transmission power level based on regulatory restrictions in the county where the Bridge is installed.	Fixed
Transmit Power	The level of transmission power (100%, 50%, 25%, 12%, or Min). You can change this setting by clicking <i>Wireless Network</i> under System Configuration.	100%
MAC Address	The MAC address of the Bridge.	N/A
Serial Number	The serial number of the Bridge.	N/A
Firmware Version	The version of firmware the Bridge is currently using.	N/A
DHCP Client	Determines if the Bridge obtains its IP address from the DHCP server on the network.	On
IP Address	The IP address of the Bridge. You can change this address by clicking <i>IP Network</i> under System Configuration.	Varies
Subnet Mask	The subnet mask address of the Bridge. You can change this address by clicking <i>IP Network</i> under System Configuration.	Varies
Data Preamble	The data preamble setting (<i>Short [Enhanced performance]</i> or <i>Long [Wi-Fi Interoperable]</i>). To change this setting, click <i>Wireless Network</i> under System Configuration.	Long
System Up Time	The elapsed time since the Bridge booted up.	Day 0, 0:00:00
Date Manufactured	The date the Bridge was manufactured.	N/A

Click *Refresh* to update the information.

4

TROUBLESHOOTING

Diagnosing Problems

If you have difficulty with the Bridge, try the solutions in the following table.

Table 15 Troubleshooting

Symptom	Solution(s)
16 devices have been connected to the Bridge, either simultaneously or sequentially. After connecting another device, the new device cannot associate with the network.	<p>The Bridge supports up to 16 specific clients (for example, computers and printers) and keeps track of them using a client list of MAC addresses. After the client limit is reached, you must clear the client list to allow a new client to associate. For example, in a hub configuration with 16 clients connected, if you disconnect a desktop computer and connect a laptop in its place, you must clear the client list to establish network association.</p> <ol style="list-style-type: none">1 Disconnect a client by unplugging its Ethernet cable from the hub.2 Use the 3Com Wireless Infrastructure Device Manager to select the Bridge and launch its Configuration Management System.3 Under System Configuration, click <i>Ethernet Client List</i>. The Ethernet Client List page appears. Click <i>Clear Client List</i>.4 Connect the new client by plugging its Ethernet cable into the hub.

Table 15 Troubleshooting (continued)

<p>After you change the IP address, after you restore a backup configuration, or after you reset the Bridge to factory defaults, the Configuration Management System stops responding and you cannot continue configuring the Bridge.</p>	<p>If you change the IP address and click <i>Apply</i>, you cannot continue to configure the device using the old IP address. Similarly, after you restore a backup configuration or reset the Bridge to factory defaults, the IP address setting may be changed.</p> <p>To recover from this situation and continue configuring the Bridge:</p> <ol style="list-style-type: none"> 1 Close your browser. 2 Return to the 3Com Wireless Infrastructure Device Manager and click <i>Refresh</i>. 3 Select the device and click <i>Configure</i> to start a new configuration session and set its IP address.
<p>The Bridge cannot associate with an access point.</p>	<ul style="list-style-type: none"> ■ Adjust the position of the Bridge to improve reception. ■ Launch the Bridge Configuration Management System and make sure the security settings on the Bridge match those on the access point.
<p>The Wireless Network Tree does not appear in the 3Com Wireless Infrastructure Device Manager window.</p>	<p>Verify that you are using the correct network adapter. In the device manager window, click <i>Choose NIC</i>. Select the network adapter for the network you want to scan, and click <i>OK</i>.</p>
<p>The Bridge has a yellow exclamation point (!) next to it in the Wireless Infrastructure Device Manager.</p>	<p>The Bridge is on a different subnet than the computer attempting to configure it.</p> <p>To recover from this situation and continue configuring the Bridge:</p> <ol style="list-style-type: none"> 1 Close your browser. 2 Return to the 3Com Wireless Infrastructure Device Manager and click <i>Refresh</i>. 3 Select the device and click <i>Configure</i> to start a new configuration session. 4 Make sure the subnet address matches that of the computer.
<p>Two Bridges cannot communicate in ad-hoc mode.</p>	<ul style="list-style-type: none"> ■ Adjust the positions of the Bridges to improve reception. ■ To ensure correct operation in ad-hoc mode, the settings on the two Bridges must match exactly. Launch the Bridge Configuration Management System and make sure that the Wireless LAN Service Area, channel selections, Data Preamble setting, and security setting are the same on both Bridges.

Table 15 Troubleshooting (continued)

You are running Windows NT. After you connect the Bridge, your computer cannot obtain a valid IP address.	The Bridge configuration settings may not be compatible with the network. If they are not, and your Windows NT computer is set up to obtain its IP address from a DHCP server, the Bridge is unable to associate with the network to obtain the IP address.
	To work around this problem, set a static IP address on your computer. Then set the Bridge configuration to match the network. When the Bridge is able to associate, reset your computer to obtain its IP address from the DHCP server. If the Bridge should also obtain its IP settings from the DHCP server, make sure this is configured properly on the IP Network page and applied just before ending the session.

Disconnecting the Bridge

To disconnect the Bridge:



CAUTION: *Disconnecting the Bridge ends the network association. To avoid possible data loss, exit all networking applications on connected devices before you disconnect the Bridge.*

- 1 Unplug the Bridge Ethernet cable from the hub or other device.
- 2 Unplug the Bridge power cord.

Uninstalling Software and Documentation

If you want to uninstall the 3Com 11a/b/g Wireless Workgroup Bridge software and documentation, you can either use the standard operating system procedure for removing programs or use the following shortcut procedure:

- 1 From the Windows Start menu, select *Start > Programs > 3Com Wireless > Uninstall 3Com Wireless Infrastructure Device Manager*.
- 2 When prompted to confirm, click *OK*.

Upgrading Bridge Firmware

Firmware is the software that is installed on the Bridge at the factory. Some problems can be solved by installing a new version of the firmware. For details on how to download a firmware update from the 3Com customer support Web site and install it on your Bridge, see "Upgrading the System" on page 42

A

COMMAND-LINE INTERFACE

The Bridge can be configured through the command line interface (CLI). The CLI allows viewing and modification of the Bridge configuration from a terminal or PC through a Telnet connection.

Logging In

To access the CLI, use Telnet to log in to the Bridge using its IP address. The CLI prompts for a login user name and password and displays a version banner and a CLI prompt. The CLI is now ready to accept commands.

```
3Com WWB login: admin
Password: (no password)
```

```
3Com WWB
->
```



The login and password entries are case-sensitive.

Logging Out

To disconnect from the CLI, log out using the **quit** command.

```
3Com WWB ->
3Com WWB -> quit
```

After quitting the CLI, re-initiate the login sequence to log in to the CLI.

Configuring the Bridge

Using the CLI, you can configure the standard settings listed in Table 16.

All CLI commands are case-sensitive. Enter either the entire CLI command string. For example:

```
3Com WWB-> get rate
Data Rate: best
```



The configuration changes do not take effect until the Bridge is rebooted.

Table 16 CLI Settings and Commands

Setting	Default	Commands
IP Address	169.254.2.2	<code>get ipaddr</code> <code>set ipaddr</code>
IP Subnet Mask	255.255.0.0	<code>get ipmask</code> <code>set ipmask</code>
DHCP Client Mode	Enabled	<code>get dhcpc</code> <code>set dhcpc</code>
ESSID	ANY	<code>get ssid</code> <code>set ssid</code>
40/64-bit WEP Keys	None	<code>get key40</code> <code>set key40</code>
104/128-bit WEP Keys	None	<code>get key104</code> <code>set key104</code>
128/156-bit WEP Keys	None	<code>get key128</code> <code>set key128</code>
40/64-bit WEP Keys Authentication Type	None	<code>get wepauth40</code> <code>set wepauth40</code>
104/128-bit WEP Keys Authentication Type	None	<code>get wepauth104</code> <code>set wepauth104</code>
128/156-bit WEP Keys Authentication Type	None	<code>get wepauth128</code> <code>set wepauth128</code>

Table 16 CLI Settings and Commands (continued)

Security	Open System	get security set security
Network Mode	Wireless Client	get operationmode set operationmode
Connection Status	N/A	get wlanstatus
Reset to Factory Defaults	N/A	set factorydefault
Enable 802.1X Authentication	Disabled	get authenticator set authenticator
Data Rate Selection	Best	get rate set rate
TKIP WPA Selection	WPA-PEAP	get tkipwpa set tkipwpa
AES WPA Selection	WPA-PEAP	get aeswpa set aeswpa
UART Configuration	9600 bps 8-N-1, no flow control	get uart set uart

B

OBTAINING SUPPORT FOR YOUR 3COM PRODUCT

3Com offers product registration, case management, and repair services through **eSupport.3com.com**. You must have a user name and password to access these services, which are described in this appendix.

Register Your Product to Gain Service Benefits

To take advantage of warranty and other service benefits, you must first register your product at:

<http://eSupport.3com.com/>

3Com eSupport services are based on accounts that are created or that you are authorized to access.

Solve Problems Online

The 3Com Knowledgebase helps you to troubleshoot 3Com products. This query-based interactive tool is located at:

<http://knowledgebase.3com.com>

It contains thousands of technical solutions written by 3Com support engineers.

Purchase Extended Warranty and Professional Services

To enhance response times or extend your warranty benefits, you can purchase value-added services such as 24x7 telephone technical support, software upgrades, onsite assistance, or advanced hardware replacement.

Experienced engineers are available to manage your installation with minimal disruption to your network. Expert assessment and implementation services are offered to fill resource gaps and ensure the success of your networking projects. For more information on 3Com Extended Warranty and Professional Services, see:

<http://www.3com.com/>

Contact your authorized 3Com reseller or 3Com for additional product and support information. See the table of access numbers later in this appendix.

Access Software Downloads

You are entitled to *bug fix / maintenance releases* for the version of software that you initially purchased with your 3Com product. To obtain access to this software, you need to register your product and then use the Serial Number as your login. Restricted Software is available at:

<http://eSupport.3com.com/>

To obtain software releases that *follow* the software version that you originally purchased, 3Com recommends that you buy an Express or Guardian contract, a Software Upgrades contract, or an equivalent support contract from 3Com or your reseller. Support contracts that include software upgrades cover feature enhancements, incremental functionality, and bug fixes, but they do not include software that is released by 3Com as a separately ordered product. Separately orderable software releases and licenses are listed in the 3Com Price List and are available for purchase from your 3Com reseller.

Contact Us

3Com offers telephone, Internet, and e-mail access to technical support and repair services. To access these services for your region, use the appropriate telephone number, URL, or e-mail address from the table in the next section.

Telephone Technical Support and Repair

To obtain telephone support as part of your warranty and other service benefits, you must first register your product at:

<http://eSupport.3com.com/>

When you contact 3Com for assistance, please have the following information ready:

- Product model name, part number, and serial number
- A list of system hardware and software, including revision level
- Diagnostic error messages
- Details about recent configuration changes, if applicable

To send a product directly to 3Com for repair, you must first obtain a return materials authorization number (RMA). Products sent to 3Com without authorization numbers clearly marked on the outside of the package will be returned to the sender unopened, at the sender's expense. If your product is registered and under warranty, you can obtain an RMA number online at <http://eSupport.3com.com/>. First-time users must apply for a user name and password.

Telephone numbers are correct at the time of publication. Find a current directory of 3Com resources by region at:

<http://csoweb4.3com.com/contactus/>

Country	Telephone Number	Country	Telephone Number
Asia, Pacific Rim Telephone Technical Support and Repair			
Australia	1 800 678 515	Pakistan	+61 2 9937 5083
Hong Kong	800 933 486	Philippines	1235 61 266 2602 or 1800 1 888 9469
India	+61 2 9424 5179 or 000800 650 1111	P.R. of China	800 810 3033
Indonesia	001 803 61009	Singapore	800 6161 463
Japan	00531 616 439 or 03 3507 5984	S. Korea	080 333 3308
Malaysia	1800 801 777	Taiwan	00801 611 261
New Zealand	0800 446 398	Thailand	001 800 611 2000

You can also obtain support in this region at this e-mail address:

apr_technical_support@3com.com

Or request a repair authorization number (RMA) by fax using this number:

+ 61 2 9937 5048

Country	Telephone Number	Country	Telephone Number
Europe, Middle East, and Africa Telephone Technical Support and Repair			
From anywhere in these regions, call: +44 (0)1442 435529			
From the following countries, call the appropriate number:			
Austria	01 7956 7124	Luxembourg	342 0808128
Belgium	070 700 770	Netherlands	0900 777 7737
Denmark	7010 7289	Norway	815 33 047
Finland	01080 2783	Poland	00800 441 1357
France	0825 809 622	Portugal	707 200 123
Germany	01805 404 747	South Africa	0800 995 014
Hungary	06800 12813	Spain	9 021 60455
Ireland	01407 3387	Sweden	07711 14453
Israel	1800 945 3794	Switzerland	08488 50112
Italy	199 161346	U.K.	0870 909 3266
You can also obtain support in this region using this URL: http://emea.3com.com/support/email.html			

Latin America Telephone Technical Support and Repair			
Antigua	1 800 988 2112	Guatemala	AT&T +800 998 2112
Argentina	0 810 444 3COM	Haiti	57 1 657 0888
Aruba	1 800 998 2112	Honduras	AT&T +800 998 2112
Bahamas	1 800 998 2112	Jamaica	1 800 998 2112
Barbados	1 800 998 2112	Martinique	571 657 0888
Belize	52 5 201 0010	Mexico	01 800 849CARE
Bermuda	1 800 998 2112	Nicaragua	AT&T +800 998 2112
Bonaire	1 800 998 2112	Panama	AT&T +800 998 2112
Brazil	0800 13 3COM	Paraguay	54 11 4894 1888
Cayman	1 800 998 2112	Peru	AT&T +800 998 2112
Chile	AT&T +800 998 2112	Puerto Rico	1 800 998 2112
Colombia	AT&T +800 998 2112	Salvador	AT&T +800 998 2112
Costa Rica	AT&T +800 998 2112	Trinidad and Tobago	1 800 998 2112
Curacao	1 800 998 2112	Uruguay	AT&T +800 998 2112
Ecuador	AT&T +800 998 2112	Venezuela	AT&T +800 998 2112
Dominican Republic	AT&T +800 998 2112	Virgin Islands	57 1 657 0888

You can also obtain support in this region in the following ways:

- Spanish speakers, enter the URL: <http://lat.3com.com/lat/support/form.html>
- Portuguese speakers, enter the URL: <http://lat.3com.com/br/support/form.html>
- English speakers in Latin America should send e-mail to: lat_support_anc@3com.com

US and Canada — Telephone Technical Support and Repair

All locations: Network Jacks; Wired or Wireless Network Interface Cards:	1 847 262 0070
All other 3Com products	1 800 876 3266

END USER LICENSE AGREEMENT

Customer shall take all steps necessary to protect Wind River's and its licensors' proprietary rights in the Run-Time Module and to ensure that each Run-Time Module distributed by Customer will be accompanied by a localized copy of an End User License Agreement.

Such End User License Agreement shall prohibit the End User from: (i) copying the Run-Time Module, except for archive purposes consistent with the End User's archive procedures; (ii) transferring the Run-Time Module to a third party apart from the Target Application; (iii) modifying, decompiling, disassembling, reverse engineering or otherwise attempting to derive the Source Code of the Run-Time Module; (iv) exporting the Run-Time Module or underlying technology in contravention of applicable U.S. and foreign export laws and regulations; and (v) using the Run-Time Module other than in connection with operation of the Target Application.

In addition, the End User License Agreement shall: (i) state that the Run-Time Module is licensed, not sold and that Customer and its licensors retain ownership of all copies of the Run-Time Module; (ii) expressly disclaim all implied warranties, including without limitation the implied warranties of merchantability, fitness for a particular purpose, title and non-infringement; (iii) exclude liability for any special, indirect, punitive, incidental and consequential damages; and (iv) require that any further distribution of the Run-Time Module be subject to the same restrictions set forth herein.

The End User License Agreement shall also state that, with respect to the Run-Time Module, Wind River and its licensors are third party beneficiaries of the End User License Agreement and that the provisions related to the Run-Time Module are made expressly for the benefit of, and are enforceable by, Wind River and its licensors.

REGULATORY INFORMATION



The 3Com 11 a/b/g Wireless Workgroup Bridge (Model WL-560) must be installed and used in strict accordance with the manufacturer's instructions as described in the user documentation that comes with the product. This device complies with the following radio frequency and safety standards.

This product contains encryption. It is unlawful to export out of the U.S. without obtaining a U.S. Export License.

This product does not contain any user serviceable components. Any unauthorized product changes or modifications will invalidate 3Com's warranty and all applicable regulatory certifications and approvals.

CAUTION: EXPOSURE TO RADIO FREQUENCY RADIATION.

This device generates and radiates radio-frequency energy. In order to comply with FCC radio-frequency exposure guidelines for an uncontrolled environment, this equipment must be installed and operated while maintaining a minimum body to antenna distance of 20 cm (approximately 8 in.).

This device must not be co-located or operated in conjunction with any other antenna or transmitter.

The installer of this radio equipment must ensure that the antenna is located or pointed such that it does not emit RF field in excess of Health Canada limits for the general population; consult Safety Code 6, obtainable from Health Canada's website www.hc-sc.gc.ca/rpb.

USA - RADIO FREQUENCY REQUIREMENTS.

This device is for indoor use only when using channels 36, 40, 44 or 48 in the 5.15 to 5.25 GHz frequency range.

High power radars are allocated as primary users of the 5.25 to 5.35 GHz and 5.65 to 5.85 GHz bands. These radar stations can cause interference with and/or damage this device.

USA-FEDERAL COMMUNICATIONS COMMISSION (FCC)

This device complies with part 15 of the FCC Rules. Operation is subject to the following two conditions: (1) This device may not cause harmful interference, and (2) this device must accept any interference received, including interference that may cause undesired operation.

This equipment has been tested and found to comply with the limits for a Class B digital device, pursuant to Part 15 of FCC Rules. These limits are designed to provide reasonable protection against harmful interference in a residential installation. This equipment generates, uses, and can radiate radio frequency energy. If not installed and used in accordance with the instructions, it may cause harmful interference to radio communications. However, there is no guarantee that interference will not occur in a particular installation.

If this equipment does cause harmful interference to radio or television reception, which can be determined by tuning the equipment off and on, the user is encouraged to try and correct the interference by one or more of the following measures:

- Reorient or relocate the receiving antenna
- Increase the distance between the equipment and the receiver
- Connect the equipment to outlet on a circuit different from that to which the receiver is connected
- Consult the dealer or an experienced radio/TV technician for help

The user may find the following booklet prepared by the Federal Communications Commission helpful:

The Interference Handbook

This booklet is available from the U.S. Government Printing Office, Washington, D.C. 20402. Stock No. 004-000-0034504.

3Com is not responsible for any radio or television interference caused by unauthorized modification of the devices included with this 3Com 11a/b/g Wireless Workgroup Bridge (Model WL-560), or the substitution or attachment of connecting cables and equipment other than specified by 3Com.

The correction of interference caused by such unauthorized modification, substitution or attachment will be the responsibility of the user.

MANUFACTURER'S DECLARATION OF CONFORMITY

3Com Corporation
350 Campus Drive
Marlborough, MA 01752-3064, USA
(800) 527-8677

Date: June 30, 2004

Declares that the Product:

Brand Name: 3Com Corporation

Model Number: WL-560

Equipment Type: 11a/b/g Wireless Workgroup Bridge

Complies with Part 15 of the FCC rules. Operation is subject to the following two conditions: (1) this device may not cause harmful interference, and (2) this device must accept any interference received, including interference that may cause undesired operation.



IMPORTANT NOTE:

FCC Radiation Exposure Statement:

This equipment complies with FCC radiation exposure limits set forth for an uncontrolled environment. This equipment should be installed and operated with minimum distance 20cm between the radiator & your body. This transmitter must not be co-located or operating in conjunction with any other antenna or transmitter.

This device is intended only for OEM integrators under the following conditions:

- 1) The antenna must be installed such that 20 cm is maintained between the antenna and users, and
- 2) The transmitter module may not be co-located with any other transmitter or antenna, and
- 3) The antenna should be integral if the end device is intended to be operated in 5.15 ~ 5.25 GHz frequency range.

As long as 3 conditions above are met, further transmitter test will not be required. However, the OEM integrator is still responsible for testing their end-product for any additional compliance requirements required with this module installed (for example, digital device emissions, PC peripheral requirements, etc.).

IMPORTANT NOTE: In the event that these conditions can not be met, then the FCC authorization is no longer considered valid and the FCC ID can not be used on the final product. In these circumstances, the OEM integrator will be responsible for re-evaluating the end product (including the transmitter) and obtaining a separate FCC authorization.

Labeling Rule for the End Product Which Integrate this Module

This transmitter module is authorized only for use in device where the antenna may be installed such that 20 cm may be maintained between the antenna and users. The final end product must be labeled in a visible area with the following statement: "Contains TX FCC ID: D9C-WL560".

CANADA – INDUSTRY CANADA (IC)

This device complies with RSS 210 of Industry Canada.

Operation is subject to the following two conditions: (1) this device may not cause interference, and (2) this device must accept any interference, including interference that may cause undesired operation of this device.”

L' utilisation de ce dispositif est autorisée seulement aux conditions suivantes: (1) il ne doit pas produire de brouillage et (2) l' utilisateur du dispositif doit être prêt à accepter tout brouillage radioélectrique reçu, même si ce brouillage est susceptible de compromettre le fonctionnement du dispositif.

The term "IC" before the equipment certification number only signifies that the Industry Canada technical specifications were met.

To reduce potential radio interference to other users, the antenna type and its gain should be so chosen that the equivalent isotropically radiated power (EIRP) is not more than that required for successful communication. To prevent radio interference to the licensed service, this device is intended to be operated indoors and away from windows to provide maximum shielding. Equipment (or its transmit antenna) that is installed outdoors is subject to licensing.

Pour empêcher que cet appareil cause du brouillage au service faisant l'objet d'une licence, il doit être utilisé à l'intérieur et devrait être placé loin des fenêtres afin de fournir un écran de blindage maximal. Si le matériel (ou son antenne d'émission) est installé à l'extérieur, il doit faire l'objet d'une licence.

High power radars are allocated as primary users of the 5.25 to 5.35 GHz and 5.65 to 5.85 GHz bands. These radar stations can cause interference with and/or damage this device.

INDUSTRY CANADA (IC) EMISSIONS COMPLIANCE STATEMENT

This Class B digital apparatus complies with Canadian ICES-003.

AVIS DE CONFORMITÉ À LA RÉGLEMENTATION D'INDUSTRIE CANADA

Cet appareil numérique de la classe B est conforme à la norme NMB-003 du Canada.

SAFETY COMPLIANCE NOTICE

This device has been tested and certified according to the following safety standards and is intended for use only in Information Technology Equipment which has been tested to these or other equivalent standards:

- UL Standard 60950 (3rd Edition) or 60950-1
- CAN/CSA C22.2 No. 60950 or 60950-1
- IEC 60950 or 60950-1
- EN 60950 or 60950-1

Spanish	Por medio de la presente 3Com Corporation declara que el 11a/b/g Wireless Workgroup Bridge cumple con los requisitos esenciales y cualesquiera otras disposiciones aplicables o exigibles de la Directiva 1999/5/CE
Portuguese	3Com Corporation declara que este 11a/b/g Wireless Workgroup Bridge está conforme com os requisitos essenciais e outras disposições da Directiva 1999/5/CE.

EUROPE – RESTRICTIONS FOR USE OF 2.4GHZ FREQUENCIES IN EUROPEAN COMMUNITY COUNTRIES

België/ Belgique:	For private usage outside buildings across public grounds over less than 300m no special registration with IBPT/BIPT is required. Registration to IBPT/BIPT is required for private usage outside buildings across public grounds over more than 300m. For registration and license please contact IBPT/BIPT.
	Voor privé-gebruik buiten gebouw over publieke grond over afstand kleiner dan 300m geen registratie bij BIPT/BIPT nodig; voor gebruik over afstand groter dan 300m is wel registratie bij BIPT/BIPT nodig. Voor registratie of licentie kunt u contact opnemen met BIPT.
	Dans le cas d'une utilisation privée, à l'extérieur d'un bâtiment, au-dessus d'un espace public, aucun enregistrement n'est nécessaire pour une distance de moins de 300m. Pour une distance supérieure à 300m un enregistrement auprès de l'IBPT est requise. Pour les enregistrements et licences, veuillez contacter l'IBPT.
Deutschland:	License required for outdoor installations. Check with reseller for procedure to follow
	Anmeldung im Outdoor-Bereich notwendig, aber nicht genehmigungspflichtig. Bitte mit Händler die Vorgehensweise abstimmen.
France:	Restricted frequency band: only channels 1 to 7 (2400 MHz and 2454 MHz respectively) may be used outdoors in France. Please contact A.R.T. (http://www.arttelecom.fr) for applicable procedures to follow.
	Bande de fréquence restreinte: seuls les canaux 1- 7 (2400 et 2454 MHz respectivement) doivent être utilisés endroits extérieur en France. Vous pouvez contacter l'Autorité de Régulation des Télécommunications (http://www.art-telecom.fr) pour la procédure à suivre.
Italia:	License required for indoor use. Use with outdoor installations not allowed.
	E' necessaria la concessione ministeriale anche per l'uso interno. Verificare con i rivenditori la procedura da seguire.
Nederland:	License required for outdoor installations. Check with reseller for procedure to follow.
	Licentie verplicht voor gebruik met buitenantennes. Neem contact op met verkoper voor juiste procedure.

EUROPE – RESTRICTIONS FOR USE OF 5GHz FREQUENCIES IN EUROPEAN COMMUNITY COUNTRIES

European Community Countries	5150-5250 MHz Channels: 36, 40, 44, 48 Indoor Only	5250-5350 MHz Channels: 52, 56, 60, 64 Indoor Only	5470-5725MHz Channels: 100, 104, 108, 112, 116, 120, 124, 128, 132, 136, 140 Indoor/Outdoor
Austria	✓	X	X
Belgium, France, Switzerland, Liechtenstein	✓	✓	X
Denmark, Finland, Germany, Greece, Iceland, Ireland, Italy, Luxembourg, Netherlands, Norway, Portugal, Spain, Sweden, UK	✓	✓	✓

✓ allowed X not allowed

- To remain in conformance with European spectrum usage laws for Wireless LAN operation, the above 2.4GHz and 5GHz channel limitations apply. The user should check the current channel of operation. If operation is occurring outside of the allowable frequencies as listed above, the user must cease operating the 11a/b/g Wireless Workgroup Bridge at that location and consult the local technical support staff responsible for the wireless network.
- The 5GHz Turbo mode feature is not allowed for operation in any European Community country.
- This device must not be operated in ad-hoc mode using channels in the 5GHz bands in the European Community. Ad-hoc mode provides a direct communication between two client devices without a Wireless LAN Access Point.
- This device must be used with Access Points that have employed and activated a radar detection feature required for European Community operation in the 5GHz bands. This device will operate under the control of the Access Point in order to avoid operating on a channel occupied by any radar system in the area. The presence of nearby radar operation may result in temporary interruption in communications of this device. The Access Point's radar detection feature will automatically restart operation on a channel free of radar. You may consult with the local technical support staff responsible for the wireless network to ensure the Access Point device(s) are properly configured for European Community operation.