



**3Com® AirConnect 9550
11n 2.4+5GHz PoE
Access Point**

**3Com® AirConnect 9150
11n 2.4GHz PoE
Access Point**

www.3com.com

M/N: WL-605 / WL-604
Published April 2008



3Com Corporation 350 Campus Drive Marlborough, MA 01752-3064

Copyright © 2008, 3Com Corporation. All rights reserved. No part of this documentation may be reproduced in any form or by any means or used to make any derivative work (such as translation, transformation, or adaptation) without written permission from 3Com Corporation.

3Com Corporation reserves the right to revise this documentation and to make changes in content from time to time without obligation on the part of 3Com Corporation to provide notification of such revision or change.

3Com Corporation provides this documentation without warranty, term, or condition of any kind, implied or expressed, including, but not limited to, the implied warranties, terms or conditions of merchantability, satisfactory quality, and fitness for a particular purpose. 3Com may make improvements or changes in the product(s) and/or the program(s) described in this documentation at any time.

If there is any software on removable media described in this documentation, it is furnished under a license agreement included with the product as a separate document, in the hard copy documentation, or on the removable media in a directory file named LICENSE.TXT or !LICENSE.TXT. If you are unable to locate a copy, contact 3Com and a copy will be provided to you.

UNITED STATES GOVERNMENT LEGEND

If you are a United States government agency, then this documentation and the software described herein are provided to you subject to the following:

All technical data and computer software are commercial in nature and developed solely at private expense.

Software is delivered as "Commercial Computer Software" as defined in DFARS 252.227-7014 (June 1995) or as a "commercial item" as defined in FAR 2.101(a) and as such is provided with only such rights as are provided in 3Com's standard commercial license for the Software. Technical data is provided with limited rights only as provided in DFAR 252.227-7015 (Nov 1995) or FAR 52.227-14 (June 1987), whichever is applicable. You agree not to remove or deface any portion of any legend provided on any licensed program or documentation contained in, or delivered to you in conjunction with, this User Guide.

Unless otherwise indicated, 3Com registered trademarks are registered in the United States and may or may not be registered in other countries.

3Com and the 3Com logo are registered trademarks of 3Com Corporation.

Intel and Pentium are registered trademarks of Intel Corporation. Microsoft, MS-DOS, Windows, and Windows NT are registered trademarks of Microsoft Corporation. Novell and NetWare are registered trademarks of Novell, Inc. UNIX is a registered trademark in the United States and other countries, licensed exclusively through X/Open Company, Ltd.

IEEE and 802 are registered trademarks of the Institute of Electrical and Electronics Engineers, Inc.

All other company and product names may be trademarks of the respective companies with which they are associated.

ENVIRONMENTAL STATEMENT

It is the policy of 3Com Corporation to be environmentally-friendly in all operations. To uphold our policy, we are committed to:

Establishing environmental performance standards that comply with national legislation and regulations.

Conserving energy, materials and natural resources in all operations.

Reducing the waste generated by all operations. Ensuring that all waste conforms to recognized environmental standards. Maximizing the recyclable and reusable content of all products.

Ensuring that all products can be recycled, reused and disposed of safely.

Ensuring that all products are labeled according to recognized environmental standards.

Improving our environmental record on a continual basis.

End of Life Statement

3Com processes allow for the recovery, reclamation and safe disposal of all end-of-life electronic components.

Regulated Materials Statement

3Com products do not contain any hazardous or ozone-depleting material.

Environmental Statement about the Documentation

The documentation for this product is printed on paper that comes from sustainable, managed forests; it is fully biodegradable and recyclable, and is completely chlorine-free. The varnish is environmentally-friendly, and the inks are vegetable-based with a low heavy-metal content.

INTRODUCTION

Key Product Features	7
Security	8
Performance And Reliability	8
Manageability.....	8
Wireless Network Standards	9
802.11a.....	9
802.11b/g.....	10
IEEE 802.3af	11

INSTALLING YOUR 3COM WIRELESS ACCESS POINT

Unpacking the device	13
Deciding where to place your AP	16
Wall Mounting the Wireless Access Point.....	17
Checking the LED Indicators	21
Power up.....	22
Self test (POST)	22

CONFIGURING THE WIRELESS ACCESS POINT

Networks with a DHCP Server.....	23
Networks without a DHCP Server	24

Using the 3Com Installation CD	25
Launch the 3Com Wireless Infrastructure Device Manager (Widman) utility	25
Launching the 3Com Wireless Infrastructure Device Manager	25
First Time Only	28
System Status	29
System Summary.....	29
Wireless Station List	30
Event Log List.....	31
System Configuration	31
Setup Wizard	31
System Properties.....	35
Access Point mode	35
Wireless Workgroup Bridge mode (Client Bridge mode).....	35
Ad-hoc mode (peer to peer)	35
Repeater mode.....	35
Wireless Bridge mode.....	36
FAT.....	36
FIT.....	36
IP Settings.....	37
Wireless Network.....	38
Wireless Mode	38

Channel / Frequency	39
Current Profiles	40
SSID	40
BSSID	41
Suppressed SSID	41
VLAN ID	41
Station Separation	41
Security.....	41
WEP.....	42
WPA Only	43
WPA2-Only	44
WPA2-Mixed.....	44
Profile (SSID) Isolation	45
Multi-BSSID.....	45
WDS Link Settings	45
WDS Security Settings.....	47
Wireless Advanced Settings	48
Data Rate.....	48
Transmit Power	49
Beacon Interval	49
Data Beacon Rate (DTIM)	49

Fragment Length.....	49
RTS Threshold	49
802.11d support	50
Antenna Type.....	50
Service.....	51
Management VLAN.....	51
IAPP	52
802.11F (IAPP) Support - Choose either Enable or Disable	52
QoS.....	53
SNTP.....	56
Syslog function	58
System Log	58
Syslog Server.....	58
Syslog Port.....	59
Syslog Level.....	59
Management.....	60
Administration	60
SNMP	61
MAC Filtering.....	62
Rogue AP Detection.....	63
Backup/ Restore Settings.....	64

Firmware Auto Update	65
Firmware Upgrade	66
Rebooting	68
Connecting through the Com Port	69
Restoring factory settings	70

TROUBLESHOOTING

Diagnosing Problems	71
---------------------------	----

OBTAINING SUPPORT FOR YOUR 3COM PRODUCT

Register Your Product to Gain Service Benefits	77
Solve Problems Online	77
Purchase Extended Warranty and Professional Services	78
Access Software Downloads	78
Contact Us	79
Telephone Technical Support and Repair	80

END USER LICENSE AGREEMENT

APPENDIX

Antennas Used per Mode	83
------------------------------	----

Console Cable Pin-out	85
-----------------------------	----

INDEX

1

INTRODUCTION

The 3Com AirConnect 9550 11n 2.4+5GHz PoE Access Point / 3Com AirConnect 9150 11n 2.4GHz PoE Access Point is a high performance access point that allows you to join isolated wired Ethernet networks into a unified wireless local area network (WLAN). The Access Point (AP) supports Wi-Fi Protected Access security standards to provide a higher level of security for network data and communications. The 3Com AirConnect 9550 11n 2.4+5GHz PoE Access Point / 3Com AirConnect 9150 11n 2.4GHz PoE Access Point is also fully compatible with IEEE 802.11a (3Com AirConnect 9550 11n 2.4+5GHz PoE Access Point only), 802.11b, 802.11g and 802.11n.

Key Product Features

The product operates using 11a (3Com AirConnect 9550 11n 2.4+5GHz PoE Access Point only), 11b, 11g, or 11n modes. This access point creates an enterprise-class wireless LAN, supporting up to 64 simultaneous users.

Security

3Com offers one of the most robust suites of standards-based security on the market today. To protect sensitive data broadcast over the wireless LAN, 3Com supports Wireless Equivalent Privacy (WEP) and Wi-Fi Protected Access (WPA and WPA2). 3Com strengthens this basic security mechanism with additional security features, including MAC address access control lists, IEEE 802.1x per-port user authentication with RADIUS server authentication support, Temporal Key Integrity Protocol (TKIP), Advanced Encryption Standard (AES), Wireless Protected Access (WPA) and Extensible Authentication Protocol (EAP) support: EAP-MD5, EAP-TLS, EAP-TTLS, and PEAP.

Performance And Reliability

3Com wireless access point performance features ensure reliable and seamless connections for users wherever they roam. Automatic channel selection automatically finds the least loaded channel for interference-free communication. Auto network connect and dynamic rate shifting keep users connected through a wide variety of conditions by changing to the optimum connection speed as they move through the network.

Manageability

3Com offers a wide range of standards-based management support, from SNMP to 3Com Network Supervisor and HP OpenView for seamless integration with your wired network.

Wireless Infrastructure Device Manager and Wireless LAN Device Discovery tools let you configure parameters, run diagnostics, backup and restore configurations, and monitor performance from anywhere on the network using an embedded web server browser.

With Power over Ethernet (PoE) support, the same Category 5 cable that connects your access point to the data network also provides its power. A single cable installation dramatically improves your choice of mounting configurations because you no longer need to consider AC power outlet locations. PoE support makes it easier than ever to overcome installation problems with difficult-to-wire or hard-to-reach locations.

Wireless Network Standards

Understanding the characteristics of the 802.11a and 802.11g standards can help you make the best choice for your wireless implementation plans.

802.11a

Ratified in 2002, 802.11a operates at the 5GHz band and supports data rates at up to 54Mbps. Because there are fewer devices in the 5GHz band, there's less potential for RF interference. However, because it is at an entirely different radio spectrum, it is not compatible with 802.11b and 802.11g.

The higher spectrum provides about 50m (164ft) of coverage. Consider 802.11a when you need high throughput in a confined space and you are:

- Running high-bandwidth applications like voice, video, or multimedia over a wireless network that can benefit from a five-fold increase in data throughput.
- Transferring large files like computer-aided design files, preprint publishing documents or graphics files, such as MRI scans for medical applications that demand additional bandwidth.
- Supporting a dense user base confined to a small coverage area. Because 802.11a has a greater number of non-overlapping channels, you can pack more wireless devices in a tighter space.

802.11b/g

802.11b, 802.11g and 802.11n all operate in the 2.4GHz band. 802.11b can support data rate up to 11Mbps. 802.11g can support data rate up to 54Mbps. 802.11n can support data rate up to 300Mbps. They all support the widest coverage – up to 100m (328ft). It is however, subject to a greater risk of radio interference because it operates in the more popular 2.4GHz band.

Consider 802.11n when you need wider coverage and vendor compatibility and you are:

- Maintaining support for existing 802.11b and 802.11g users and the existing wireless investment while providing for expansion into 802.11n.
- Implementing a complete wireless LAN solution, including Ethernet Adapters, gateways, access points and clients; Wi-Fi certification guarantees compatibility among vendors.
- Providing access to hot spots in public spaces such as coffee shops or university cafeterias.

IEEE 802.3af

The IEEE 802.3af-2003 Power over Ethernet standard defines terminology to describe a port that acts as a power source (PSE) to a powered device (PD). The IEEE 802.3af standard states that power may be delivered by an end-point PSE, using either the active data wires of an Ethernet port or the spare wires, to a powered device. An end-point PSE, such as a Power over Ethernet capable Ethernet switch, may implement either scheme. If a mid-span PSE is used, then the mid-span PSE can only implement power delivery over the spare pairs of the copper cabling and cannot be used to deliver Power over Ethernet over 1000BASE-T connections. It should be noted that even if a device supports both methods of providing power, only one mechanism may be used to deliver power to a powered device.

The first mechanism is to use the data pairs (pins 1, 2 & 3, 6) to transmit power, which is sometimes referred to as "phantom" power. The second power delivery mechanism is to use the

unused, from a 10/100BASE-T perspective, pairs (pins 4, 5 & 7, 8) to deliver power that is supported within mid-span power delivery.

2

INSTALLING YOUR 3COM WIRELESS ACCESS POINT

This chapter contains the information you need to install and set up the Wireless Access Point. It covers the following topics:

- Unpacking the device
- Decide where to place the AP
- Connecting the Access Point
- Checking the LED indicators
- For first time use - Installing Device Manager

Unpacking the device

Make sure that you have the following items in the box:

- One 3Com AirConnect 9550 11n 2.4+5GHz PoE Access Point or one 3Com AirConnect 9150 11n 2.4GHz PoE Access Point
- Wall-mounting hardware:
 - Wall/table top bracket/stand

- Four screws
- Four wall anchors
- Eight adhesive rubber feet
- One CD-ROM containing the Setup Wizard software and a copy of the *Quick Start Guide*.
- One Warranty Flyer

The Figure below shows the the AP, including the LEDs and connecting ports.

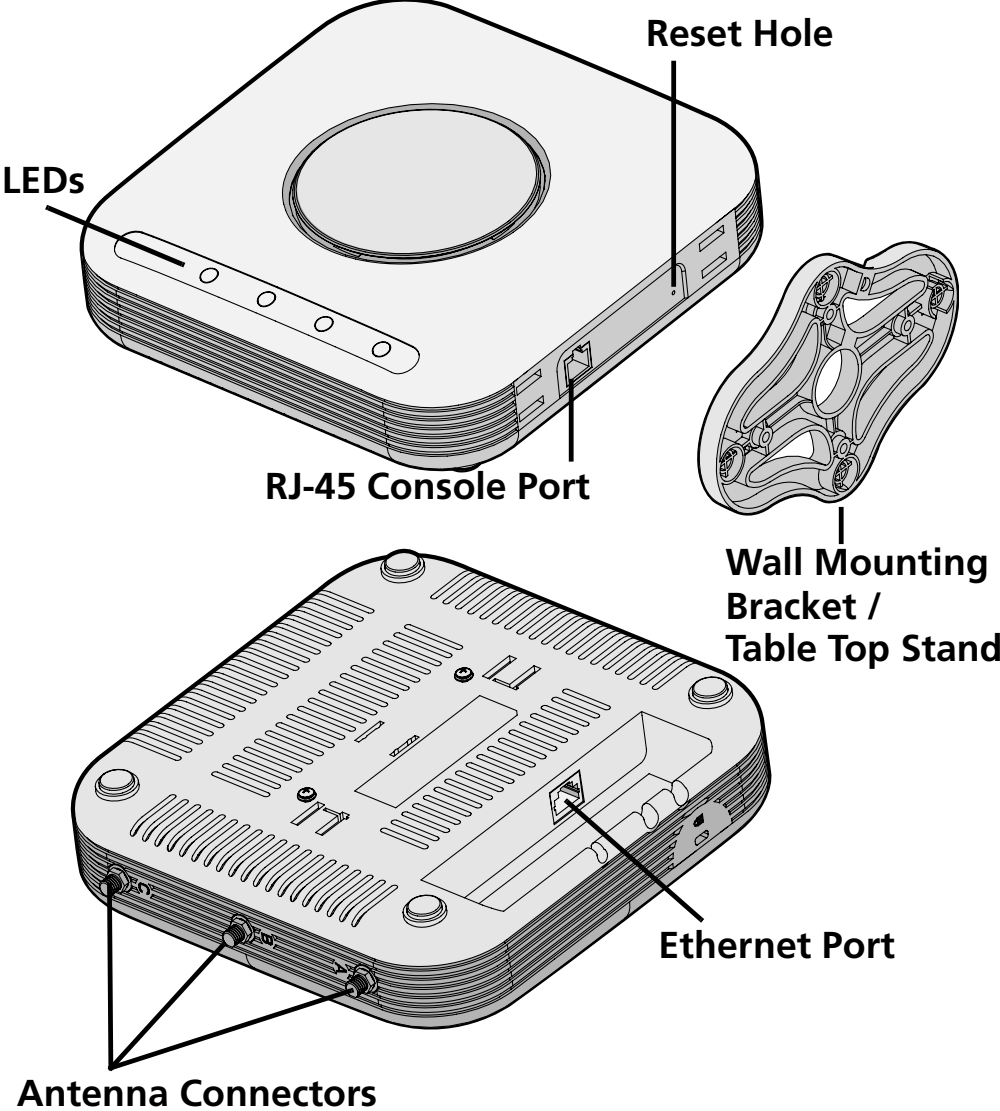

Deciding where to place your AP

Place the AP in a dry, clean location near the hub, switch, computer or printer that will be connected to the AP. The location must have a power source and be within the following distance of a Wi-Fi compliant wireless LAN access point or wireless access point.

The key to maximizing the wireless range is to follow these basic guidelines:

- Keep your product away (at least 3-6 feet or 1-2 meters) from electrical devices or appliances that generate RF noise. The location should be away from transformers, heavy-duty motors, fluorescent lights, microwave ovens, refrigerators.
- Keep the number of walls and ceilings between the AP and other network devices to a minimum - each wall or ceiling can reduce your AP's range from 3-90 feet (1-30 meters.) Position your devices so that the number of walls or ceilings is minimized.
- Be aware of the direct line between network devices. A wall that is 1.5 feet thick (0.5 meters), at a 45-degree angle appears to be almost 3 feet (1 meter) thick. At a 2-degree angle it looks over 42 feet (14 meters) thick! Position devices so that the signal will travel straight through a wall or ceiling (instead of at an angle) for better reception.
- Building materials can impede the wireless signal - a solid metal door or aluminum studs may have a negative effect on

range. Try to position wireless devices and computers with wireless adapters so that the signal passes through drywall or open doorways and not other materials.

Wall Mounting the Wireless Access Point

Use the mounting bracket that comes with your Access Point to install it on a wall or electrical box.

To wall-mount the Access Point:

- 1** Screw the mounting bracket to a wall or electrical box (NEMA enclosure):
 - If mounting to drywall, use the four screws and four wall anchors.
 - If mounting to an EU electrical box (60.3mm), use two threaded screws and insert into the holes marked "A" in the diagram shown below.

- If mounting to a US electrical box (83.3mm), use two threaded screws and insert into the holes made "B" in the diagram shown below..

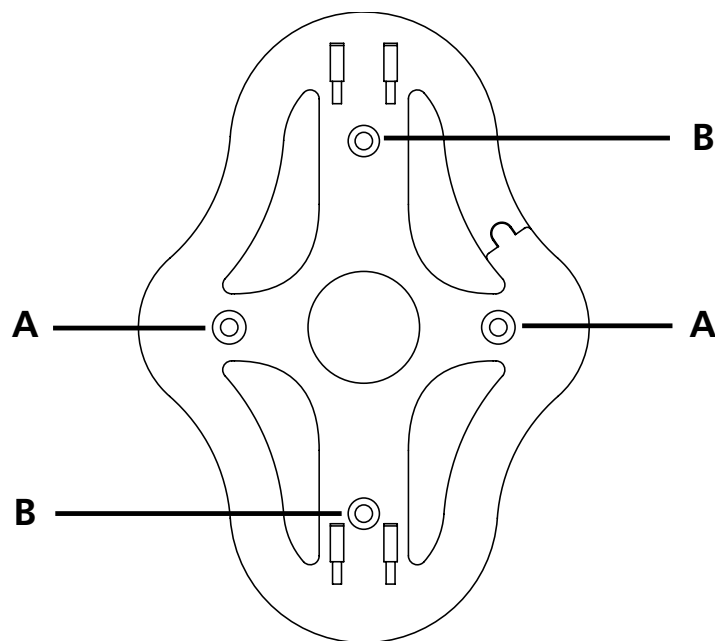

- 2 Connect the Ethernet cable (for power and network connection) to the port on the back of the Access Point.

3 Mount Access Point onto the mounting bracket.

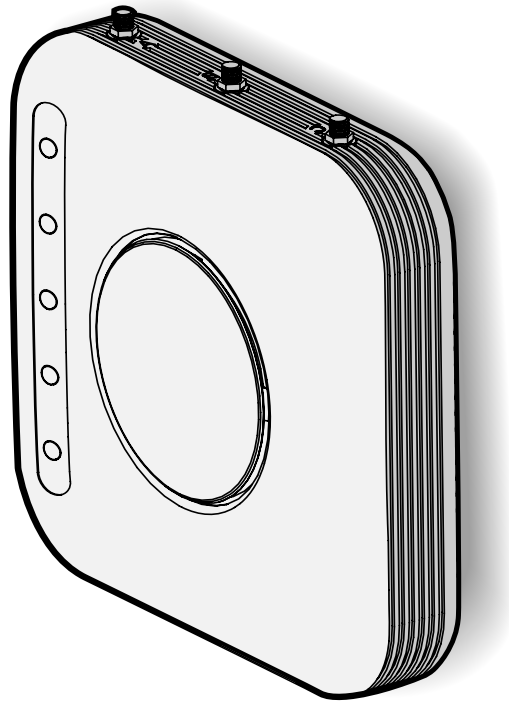

Tabletop Mounting

To install the Access Point on a flat surface such as a table or desktop:



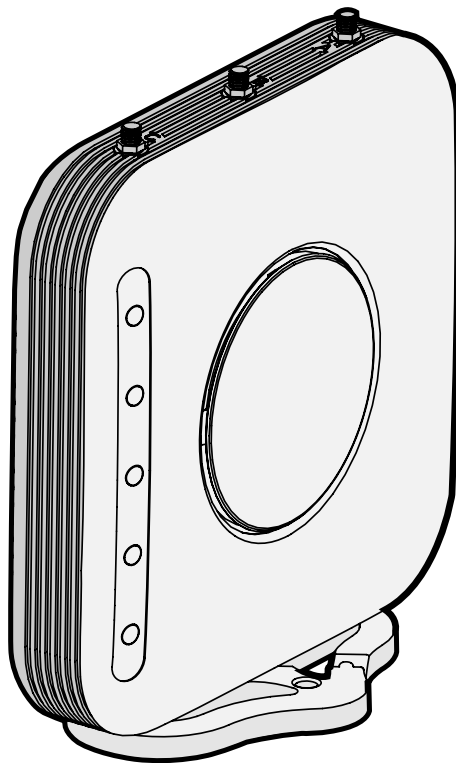

- 1 Attach the mounting bracket/table stand to the side of the Access Point.
- 2 Place the Access Point and table stand on the table.



- 3 Connect the Ethernet cable (for power and network connection) to the port on the back of the Access Point.

Checking the LED Indicators

When the AP is connected to power, LEDs indicate activity as follows:

Indicator	Color	State	Description
 LED 1 (Power/ System)		Off	No power
	Amber	On	CPU or system fail
		Blinking	System initiation or reset (software self testing and loading)
	Green	On	Powered on and ready for operation
 LED 2 (2.4G)	Green	Off	Administratively disabled
		On	Associated with network, but no activity
		Blinking	Activity
 LED 3 (5G) (3Com AirConnect 9550 11n 2.4+5GHz PoE Access Point only)	Green	Off	Administratively disabled
		On	Associated with network, but no activity
		Blinking	Activity
 LED 4 (Ethernet)		Off	No 10/100/1000 base T link detected, or administratively disabled
	Amber	On	10/100 base T link detected, but no activity
		Blinking	10/100 base T link activity
	Green	On	1000 base T link detected, but no activity
		Blinking	1000 base T link activity

Power up

Self test (POST)

At power up, the product will carry out a self-test (POST). POST will run a test on the wireless circuit to check it is functioning correctly.

When running the POST test, LED 1 (Power/System) will blink amber.

When firmware is corrupted, LED 1 (Power/System) will be solid amber.

3

CONFIGURING THE WIRELESS ACCESS POINT

If the default AP configuration does not meet your network requirements, or if you want to customize the settings for your own network, you can use these tools to change the configuration:

- 1 Launch the 3Com Wireless Infrastructure Device Manager (Widman) utility
- 2 Directly connect to the device through its Ethernet port or console port

Networks with a DHCP Server

If your network has a DHCP server, an IP address is automatically assigned to the AP. It takes between one and two minutes for the Access Point to determine if there is a DHCP server on the network. Use the 3Com Wireless Infrastructure Device Manager (Widman) included on the 3Com Installation CD to locate the Access Point on the network and view its IP address.

After you determine the AP's IP address, you can enter that IP address into a web browser on a computer on the same subnet to view the Access Point's system status or change its configuration.

Networks without a DHCP Server

If your network does not have a DHCP server, the Access Point uses a factory assigned IP address (169.254.2.2). You can use that IP address to configure the Access Point, or you can assign a new IP address to the Access Point.

To verify that the Access Point is using the default IP address assigned at the factory:

- 1 Connect a computer directly to the Access Point using the supplied standard Category 5 UTP Ethernet cable.
- 2 Enter the Access Point's default IP address (169.254.2.2) into the computer's web browser. If the Configuration Management System starts, the Access Point is using the factory assigned IP address. You can configure the Access Point with the following login information:

- Login name: **admin**
- Password: **password**

If the Configuration Management System does not start, the Access Point is on a different subnet than the computer. Install and start the 3Com Wireless Infrastructure Device Manager to discover the Access Point's IP address.

Using the 3Com Installation CD

The 3Com Installation CD contains the following tools and utilities:

3Com Wireless Infrastructure Device Manager—an administration tool that helps you select 3Com wireless LAN devices and launch their configurations in your Web browser.

Launch the 3Com Wireless Infrastructure Device Manager (Widman) utility

- 1 Turn on the computer.
- 2 Insert the 3Com Installation CD into the CD-ROM drive.
The CD will Autorun. If it does not Autorun, you can start the setup menu from the Windows Start menu. For example: **Start > Run > d:\setup.exe**.
- 3 In the menu click **Tools and Utilities**.
- 4 In the next screen, click the software you want to install.
- 5 Follow the on screen instructions to complete the installation.
Reboot the computer if prompted to do so.

Launching the 3Com Wireless Infrastructure Device Manager

To be able to configure the Access Point you need to run the Wireless Infrastructure Device Manager. Go to **Start >**

Programs > 3Com Wireless > Wireless Infrastructure Device Manager

If the device is working correctly the following screen should be seen.

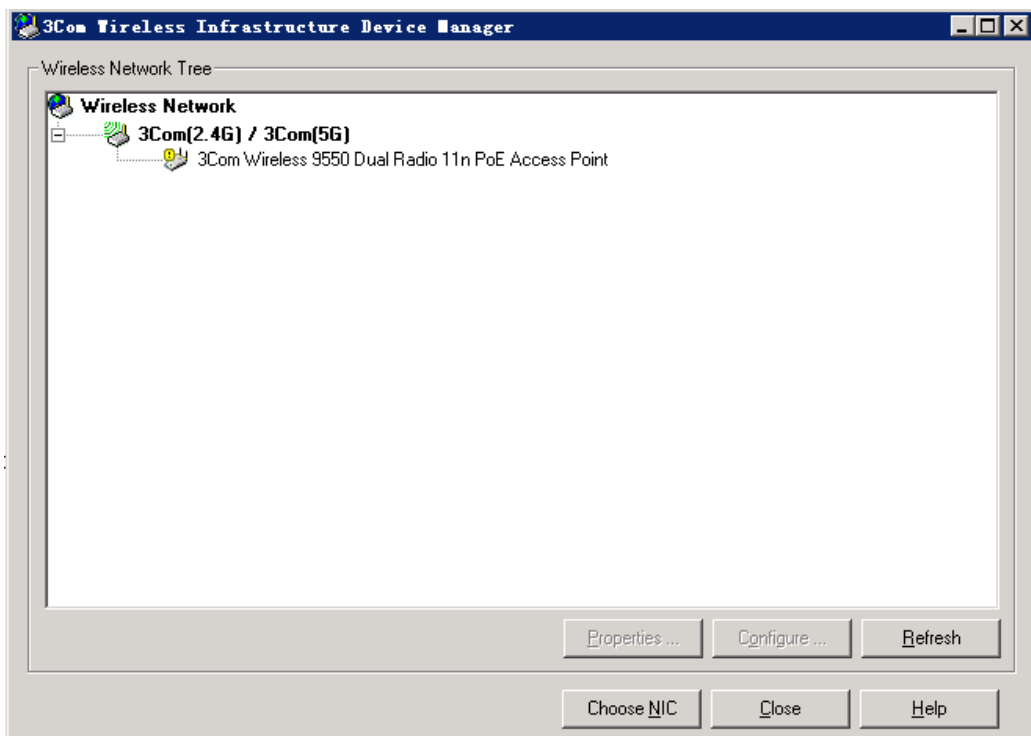

Click on the Properties button to see the following screen

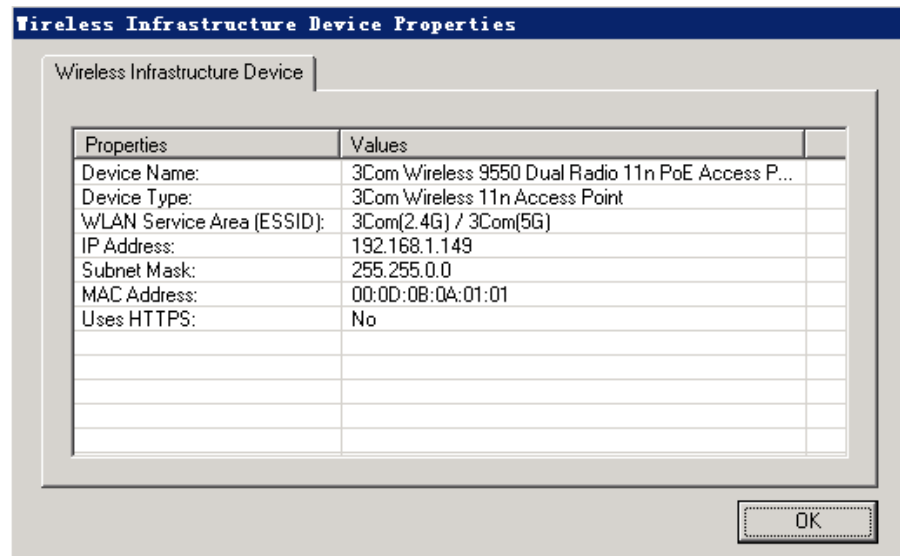

Directly connect to the device through its Ethernet port or console port.

Follow the instructions below to log into the AP Configuration screen:

- 1 Load a web browser and enter **http://169.254.2.2**

2 The Logon screen appears



To log on to the Web interface:

- 1 Username, type **admin** (case sensitive)
- 2 Password, type **password**
- 3 Click **Log On**.

First Time Only

After you have logged in for the first time you will be asked to select your country from the drop down menu.



System Status

The Web interface has been designed to enable you to easily perform advanced configuration tasks and view information about the AP.

System Summary

After you click Logon from the Log On Screen, you'll see the system status page on the screen. The System summary page is the default page that will pop up once you successfully log in. The system summary page shows all the configuration information about your AP.

3COM
Access Point

9550 Dual Radio 11n PoE Access Point

System Status -> System Summary

System Information

System Name	3Com Wireless 9550 Dual Radio 11n PoE Access Point
Operation Mode	Access Point
Ethernet MAC Address	00:18:9E:02:02:01
2.4G Wireless MAC Address	00:18:9E:02:02:01
5G Wireless MAC Address	00:18:9E:02:02:02
Country	UNITED STATES
Firmware Version	AP Software 1.3.4 built on Mar 27, 2008

Current IP Settings

IP Address	192.168.1.74
Subnet Mask	255.255.255.0
Default Gateway	192.168.1.1
DHCP Client	Disabled

2.4G Radio

Wireless Mode	2.4GHz 300Mbps (802.11bgn)
Radio Band	20MHz
Channel / Frequency	Channel 6/2437MHz
Primary Profile SSID	3Com1 2.4GHz_tony
Primary Profile Security	WPA-PSK/TKIP
WDS	Disabled

5G Radio

Wireless Mode	5GHz 300Mbps (802.11an)
Radio Band	20MHz
Channel / Frequency	Channel 128/5640MHz
Primary Profile SSID	3Com1 5GHz
Primary Profile Security	Open System
WDS	Disabled

Log Off

Wireless Station List

Through this page, you can easily identify the adjacent wireless stations. It will automatically observe the adjacent wireless station's ID (if specified), MAC address, SSID and current status.

The screenshot displays the web management interface for a 3COM 9550 Dual Radio 11n PoE Access Point. The left sidebar contains a navigation menu with categories like System Status, System Configuration, 2.4G Radio Configuration, 5G Radio Configuration, Service, and Management. The main content area is titled '9550 Dual Radio 11n PoE Access Point' and shows the 'System Status -> Wireless Station List' page. It features two tables: one for 2.4G Radio and one for 5G Radio. The 2.4G Radio table has one entry with the following details:

Station ID	MAC Address	SSID	Status	RSSI (dBm)
STA1	88:8E:5D:77:88	3Com1_2.4GHz_100y	associated	-54

The 5G Radio table is currently empty. A 'Refresh' button is located below the tables.

Event Log List

The event log list stores a record of all the events within this designated WLAN.



System Configuration

In this section, you will learn how to configure the basic functions of your wireless AP.

Setup Wizard

The setup Wizard will walk you through the setting up of the Office Connect Access Point

Screen 1 allows you to set up the following information:

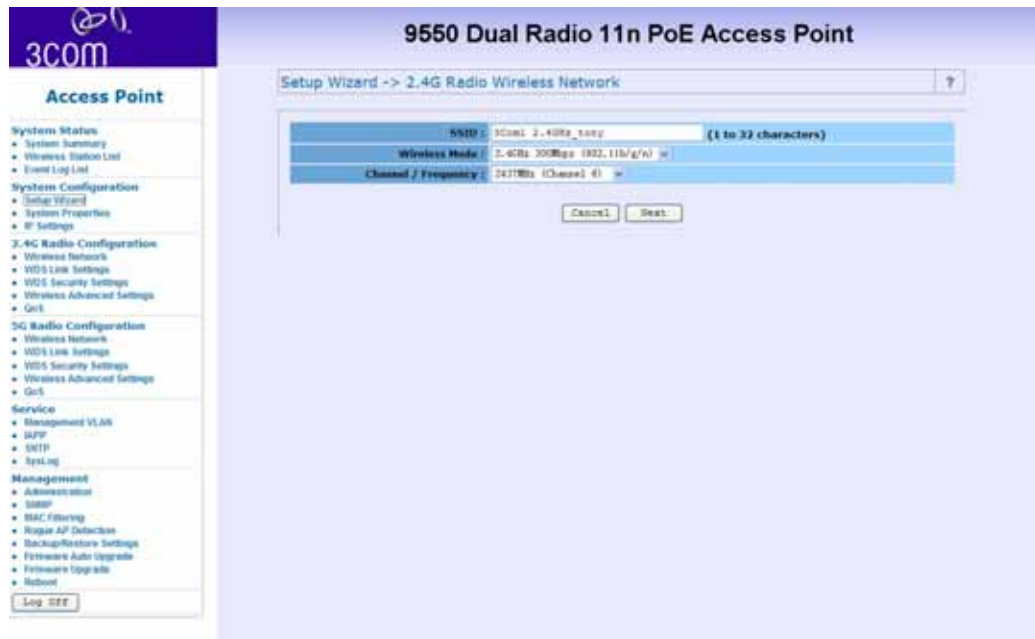

- **SSID** (Service Set Identifier) – This is the name of wireless network. Input 1-32 characters
- **Wireless Mode** – Choose the required network mode from the drop down menu.
- **Channel/Frequency** – Choose a frequency from the drop down menu or select SmartSelect (recommended) to let the device select a channel.

Click **Next** to continue the configuration or click **Clear** to start again.

Screen 2 allows you to set up the following information:

The screenshot displays the configuration interface for a 9550 Dual Radio 11n PoE Access Point. The main window is titled "Setup Wizard -> IP Settings". On the left, a sidebar lists various configuration categories: System Status, System Configuration, 2.4G Radio Configuration, 5G Radio Configuration, Service, and Management. The main area contains the following settings:

Field	Value
IP Network Setting	<input type="radio"/> Obtain an IP address automatically (DHCP) <input checked="" type="radio"/> Specify an IP address
IP Address	192.168.1.74
IP Subnet Mask	255.255.255.0
Default Gateway	192.168.1.1

Buttons for "Back", "Cancel", and "Next" are located at the bottom of the configuration area.

- **IP Network Setting** – Check the radio button for either obtaining an IP address via DHCP or specifying an IP Address manually.
- **IP Address** – Enter the IP address that you want to assign.
- **IP Subnet Mask** – Enter your networks subnet address.
- **Default Gateway** – If used, enter the gateway address that the device should go through.

Screen 3 allows you choose the security settings. Choose the following settings from the drop down menu:



- No security
- WEP
- WPA - Only
- WPA2 - Only
- WPA2 - Mixed

Click **Close** to close without saving, click **Finish** to save the settings, or click **Back** to return to screen 2.

System Properties

The System properties page allows you to define Device name, location, operation modes and Load Type.

There are 5 operation modes to choose from:

Access Point mode

A Wireless LAN data transceiver that uses radio waves to connect a wired network with wireless station.

Wireless Workgroup Bridge mode (Client Bridge mode)

It acts as a wireless client in the network. Through this mode, you can connect to an access point through this device.

Ad-hoc mode (peer to peer)

An Ad-hoc mode allows 2 wireless clients to communicate to each other. An Ad-hoc network is a wireless network composed of stations without Access Points.

Repeater mode

A repeater is placed between two access points to extend the range of your infrastructure or to overcome an obstacle that blocks radio communication.

Wireless Bridge mode

A wireless bridge connects two separate networks operating on the 802.11 standard.

Load Types are either:

FAT

Default is set to be FAT mode AP. FAP AP has complete set of AP features which can work alone as an individual AP.

FIT

FIT mode AP needs to be connected to a 3Com Wireless Switch to provide complete feature sets.



IP Settings

This setting must match the network's method of IP address assignment. Choose DHCP or Static IP. With Dynamic Host Configuration Protocol (DHCP), IP addresses are assigned for predetermined periods of time. Choose Static IP if your network does not have an automatic system for IP address assignment.



The screenshot displays the web interface for a 3COM 9550 Dual Radio 11n PoE Access Point. The left sidebar shows a navigation menu with categories: System States, System Configuration, 2.4G Radio Configuration, 5G Radio Configuration, Service, and Management. The main content area is titled "System Configuration -> IP Settings".

IP Network Setting: A radio button is selected for "Obtain an IP address automatically (DHCP)". The "Specify an IP address" option is unselected. Below this, the IP Address is set to 192.168.1.10, the IP Subnet Mask is 255.255.255.0, and the Default Gateway is 192.168.1.1.

Web GUI Protocol: A radio button is selected for "HTTP". The "HTTPS" option is unselected. The HTTP Port is set to 80, and the HTTPS Port is set to 443.

Buttons for "Apply" and "Cancel" are located below the settings. A message at the bottom states: "You must click Apply to save your settings before moving to another page."

Wireless Network

The Wireless Access Point supports Multiple SSIDs which allows it to act as multiple APs appearing in a Wireless LAN network. You can configure up to 4 SSIDs on the device.

The screenshot displays the configuration page for a 3COM 9550 Dual Radio 11n PoE Access Point, specifically the '5G Radio Configuration -> Wireless Network' section. The interface includes a navigation menu on the left and a main configuration area on the right.

3COM 9550 Dual Radio 11n PoE Access Point

5G Radio Configuration -> Wireless Network

Wireless Mode: 802.11a/n

Radio Band: Standard 20MHz Channel

Channel (Standard Channel): SmartSelect

Extensive Channel: [button]

Current Profiles

Priority	SSID	Security	VLAN	Enable	Edit
1	3Com1 5GHz	Open System	1	<input checked="" type="checkbox"/>	Edit
2	3Com2 5GHz	Open System	2	<input type="checkbox"/>	Edit
3	3Com3 5GHz	Open System	3	<input type="checkbox"/>	Edit
4	3Com4 5GHz	Open System	4	<input type="checkbox"/>	Edit

Profile (SSID) Isolation: No Isolation
 Isolate all Profiles (SSIDs) from each other
 Use VLAN (802.1Q) standard

[Apply] [Cancel]

You must click Apply to save your settings before moving to another page.

Wireless Mode

You can select your desired wireless operating mode from the drop-down manual.

The AP supports Super Dynamic and Static modes and boosts throughput up to 108 Mbps.

The Super Dynamic mode allows automatic switching between normal and turbo modes without modification by the user. The feature increases throughput when bandwidth demands are high. When bandwidth demands are low and at regular intervals, normal mode allows legacy connectivity and new associations. The Super Dynamic mode connection between the Ethernet Adapter and the access point may turn to normal mode connection if another station associates with the access point in normal mode. The Super Static mode operates by using two radio channels and does not switch to normal mode. Super Static mode must be configured by the user on both the access point and the station.

Note that in order to enable Super mode, the opposite client service needs to provide the same specification.

Channel / Frequency

Select the channel for your wireless LAN in Channel/Frequency block. The default setting is SmartSelect it selects the channel which provides the best transmission quality. The frequencies available vary depending which wireless mode you select.

Current Profiles

A maximum of 4 profiles can be configured. Check the **Enable** button to activate a profile. Click the **Edit** button to change its configuration.



SSID

Service Set Identifier. This is the assigned name for a wireless Wi-Fi network. Stations must use this unique identifier to communicate with an Access Point. The SSID can be any alphanumeric entry up to a maximum of 32 characters.

BSSID

Basic Service Set Identifier. This is the assigned MAC address of the station in the access point. This unique identifier is in Hex format and can only be edited when **Multi BSSID** is enabled in the previous screen.

Suppressed SSID

If you want to disable the broadcast of your SSID, you should check the **Suppressed SSID** box. It is also known as SSID Broadcast disable or Hide SSID.

VLAN ID

If your network uses VLANs, you can assign an SSID to a VLAN. Client devices using the SSID are grouped in that VLAN.

Station Separation

Choose either **enable** or **disable** to control the selected VAP (Virtual Access Point).

Security

There are 4 levels of security available and all have differing properties:

WEP

Wired Equivalent Privacy data encryption provides data security. WEP Share Key authentication and WEP data encryption will block all but the most determined hacker.

System Configuration -> Wireless Network -> SSID Profile Settings

SSID: 90001_90001 (1 to 32 characters)

BSSID: [0] [0] [0] [0] [0] [0]

Suppressed SSID:

VLAN ID:

- No VLAN tag
- Specified VLAN ID: [1] (must be in the range 1 - 4095.)

 Priority: [None]

Station Separation: Enable Disable

Security: WEP

WEP setting

Authentication type: Open System

Shared keys input type: HEX

Enter all four shared keys, then select a key by clicking a radio button:

Default Key	Shared Key	Key Length
#1	<input type="text"/>	[None]
#2	<input type="text"/>	[None]
#3	<input type="text"/>	[None]
#4	<input type="text"/>	[None]

[Save] [Cancel] [Close]

From the drop down list choose **open-system** or **shared key** authentication.

Select the desired input method (HEX or ASCII)

From the drop down list choose from 40/64, 104/128, 128/152 key lengths.

WPA Only

Wi-Fi Protected Access was constructed to provide improved data encryption, (which was weak in WEP), and to provide user authentication.



Only allows WPA clients to connect to the VAP.

You can choose TKIP or AES for encryption method

The Group key update interval is configurable, default value is 1800 seconds

You can choose personal mode (PSK) or enterprise mode (802.1X) authentication (default: PSK).

If you choose PSK, you will need to enter a pass phrase of 8-63 ASCII characters or 64 hexadecimal digits.

If you choose 802.1X, you will need access to a RADIUS server, port and secret

WPA2-Only

Only allows WPA 2 clients to connect to the VAP.

You can choose TKIP or AES for the encryption method

The Group key update interval is configurable, with a default value of 1800 seconds

You can choose personal mode (PSK) or enterprise mode (802.1X) authentication (default: PSK).

If you choose PSK, you will need to enter a pass phrase of 8-63 ASCII characters or 64 hexadecimal digits.

If you choose 802.1X, you will need access to a RADIUS server, port and secret.

WPA2-Mixed

Only allows both WPA and WPA2 clients to connect to the VAP.

You can choose TKIP or AES for encryption method.

The Group key update interval is configurable, with a default value of 1800 seconds.

You can choose personal mode (PSK) or enterprise mode (802.1X) authentication. The default setting is PSK.

If you choose PSK, you will need to enter a pass phrase of 8-63 ASCII characters or 64 hexadecimal digits.

If you choose 802.1X, you will need access to a RADIUS server, port and secret.

Profile (SSID) Isolation

Stations connected to different profiles cannot access each other. Choose from **No Isolation** (Full access), or to Isolate all Profiles (SSIDs) from each other, check **use VLAN (802.1Q) standard**.

Multi-BSSID

Check **enable Multiple BSSIDs** to allow each profile to send an individual beacon and station separation configuration. This can be done either manually or automatically.

WDS Link Settings

WDS (Wireless Distribution System) allows access points to communicate with one another wirelessly in a standardized way. It can also simplify the network infrastructure by reducing the amount of cabling required. Basically the access points will act as a client and an access point at the same time.

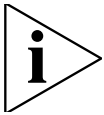

WDS is incompatible with WPA. Both features cannot be used at the same time. A WDS link is bi-directional, so the AP must know the MAC address of the other AP, and the other AP must have a WDS link back to the AP.

Dynamically assigned and rotated encryption keys are not supported in a WDS connection. This means that WPA and other dynamic key assignment technologies may not be used. Only Static WEP keys may be used in a WDS connection, including any STAs that are associated with a WDS repeating AP.

ID	MAC Address	Mode
1	00:00:00:00:00:00	Change ID
2	00:00:00:00:00:00	Change ID
3	00:00:00:00:00:00	Change ID
4	00:00:00:00:00:00	Change ID
5	00:00:00:00:00:00	Change ID
6	00:00:00:00:00:00	Change ID
7	00:00:00:00:00:00	Change ID
8	00:00:00:00:00:00	Change ID

Enter the MAC address of the other APs you want to link to and click **enable**.

Supports up to 8 point to multipoint WDS links, check **Enable WDS** and then **enable** on the MAC addresses.

Example of a WDS topology:

AP1 <-- WDS --> Master AP (our AP) <-- WDS --> AP3 <-- WDS --> AP4

WDS Security Settings

This item is only available in Access Point Mode and Wireless Bridge Mode.



Choose the required security level from: **None, WEP, WPA-PSK (TKIP), WPA-PSK (AES), WPA2-PSK (TKIP), or WPA2-PSK (AES).**

If using **WEP** security, enter the WEP key. If using **WPA**, enter the pass phrase.

Wireless Advanced Settings

To configure advanced wireless settings, click **Wireless Advanced Settings**. The tool bar and Wireless Advanced Settings menu will appear.



Data Rate

Choose between the following data rates 12, 18, 24, 36, 48, 72, 96, 108, and best. Default is Best.

Transmit Power

Choose between the following power levels Full, Half (-3dB), Quarter (-6dB), Eighth (-9dB) or Minimum. Default is Full.

Beacon Interval

The interval time between 20ms and 1000ms for each beacon transmission. The default is 100ms.

Data Beacon Rate (DTIM)

The Delivery Traffic Indication Message. Specify the data beacon rate between 1 and 255. Default is 1.

Fragment Length

The maximum packet size is used for fragmentation. Packets larger than the size programmed in this field will be fragmented. The Fragment Threshold value must be larger than the RTS Threshold value. The default is 2346.

RTS Threshold

Request To Send threshold. The packet size that is used to determine if it should use the CSMA/CA mechanism or the CSMA/CD mechanism.

802.11d support

802.11d allows the device to communicate in areas where the 802.11 standard is not allowed. It adds features and restrictions to ensure compliance.

Antenna Type

If you have added external antennas (to replace the original included 3 internal antennas), check the **External High-Gain Radio Antenna** radio button.

Service

Management VLAN

If you reconfigure the Management VLAN ID, you may lose connectivity to the access point. Verify that the switch and DHCP server can support the reconfigured VLAN ID, and then re-connect to the new IP address.

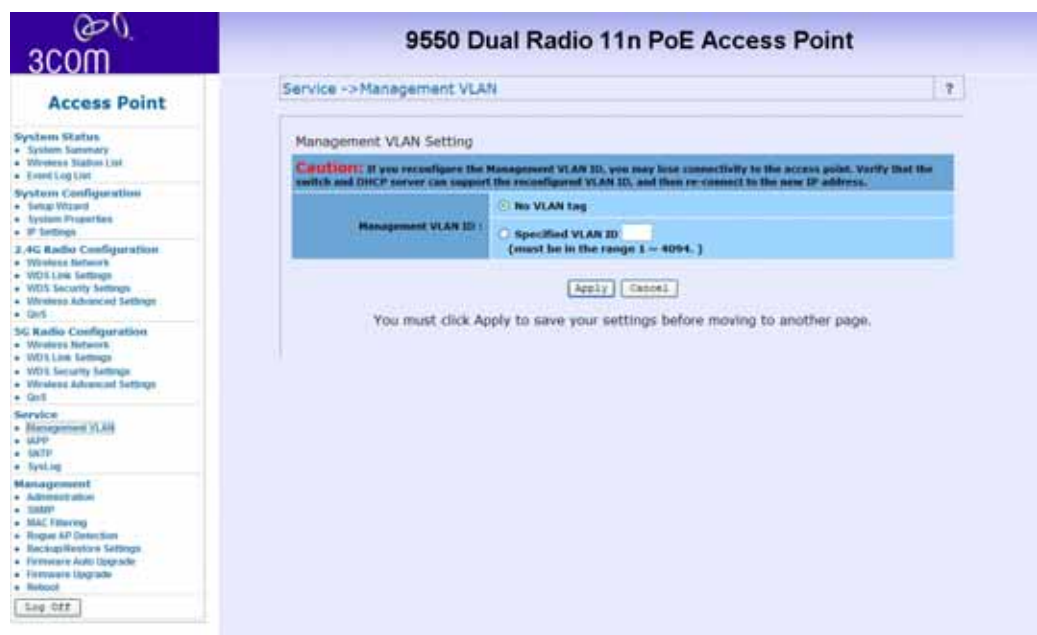

IAPP

Inter-Access Point Protocol (IAPP)

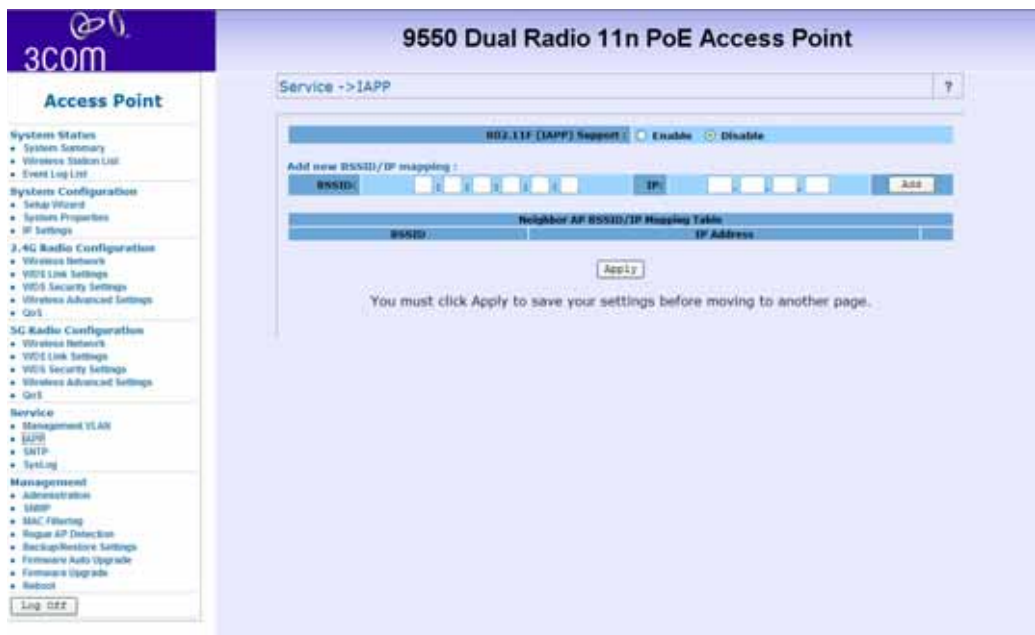

802.11F (IAPP) Support - Choose either Enable or Disable

IAPP allows multiple access points to communicate and pass location information about their associated stations. If you enable 802.11F support you should manually add BSSID/IP mapping:

- Enter the BSSID and IP addresses of the AP.
- Click **Add**

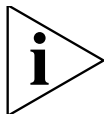

Only stations roaming from one of the listed APs to this AP are allowed to re-associate with this AP. Others will be requested to go through the full association process.

QoS

This section provides the administrator with the Quality of Service (QoS) data.

The screenshot shows the configuration page for a 3COM 9550 Dual Radio 11n PoE Access Point. The main configuration area is titled "5G Radio Configuration -> WME Parameters of Access Point". At the top, there are radio buttons for "WME (QoS)" set to "Enable" and "Disable", and a checkbox for "Ack Policy". Below this is a table with the following data:

AC Type	Min Contention Window (2 ⁿ -1, x can be 0-10)	Max Contention Window (2 ⁿ -1, x can be 0-10)	Fixed Slot Time (0-15)	Transmit Opportunity (0-65535 μs)	Admission Control
AC_BK	6	10	1	0	<input type="checkbox"/>
AC_BE	4	4	3	0	<input type="checkbox"/>
AC_VI	0	4	1	3000	<input checked="" type="checkbox"/>
AC_VO	2	3	1	1000	<input type="checkbox"/>

Below the table are "Apply" and "Cancel" buttons. A message at the bottom states: "You must click Apply to save your settings before moving to another page."

The QoS setting is only available in AP Mode and Wireless Client Mode.

The QoS Setting should be modified with caution because radio behavior is affected. These parameters can be modified when the radio for QoS service is Enabled.

Ack-Policy - when the Ack-Policy is checked. The device will not send ACK frames. The default value is disabled.

Setting	Description
Min Contention Window	For each access category, enter the minimum contention window value. Channel access is prioritized by assigning smaller contention window values to a higher priority traffic class. If a channel is busy or a transmission collides, a node chooses a random number between 0 and the current contention window minimum.
Max Contention Window	For each access category, enter the maximum contention window value. The minimum contention window value is doubled each time a collision occurs until the maximum is reached. A small contention window value decreases the access delay but increases the probability of a collision.
Fixed Slot Time	For each access category, enter the fixed slot time. Channel access can be strictly prioritized by assigning smaller contention window values to a higher priority traffic class. Traffic in the access category must wait for this fixed number of slots after each packet is received before resuming its random back-off.
Transmit Opportunity Limit	Enter the number of microseconds that qualified transmitters can transmit through the normal back-off procedure with a set of pending packets. Larger values allow a client to control the channel for longer periods of time, allowing it to achieve higher throughput in this access category at the expense of longer access times for all access categories.

Setting	Description
Admission Control	Note: In this release, clients are blocked from using an access category when they select Enable for Admission Control. The Admission Control check boxes control client use of the access categories. When you enable admission control for an access category, clients associated to the access point must complete the WMM admission control procedure before they can use that access category. However, access points do not support the admission control procedure in this release, so clients cannot use the access category when you enable Admission Control. default : disable

The default value table:

AC TYPE	Min Contention Window (2x-1; x can be 0-10)	Max Contention Window (2x-1; x can be 0-10)	Fixed Slot Time (0-15)	Transmit Opportunity (0-65535 μS)
AC_BK	4	10	7	0
AC_BE	4	6	3	0
AC_VI	3	4	1	3008 (6016 when 11b)
AC_VO (3)	2	3	1	1554 (3264 when 11b)

SNTP

Simple Network Time Protocol (SNTP) allows the administrator to configure the network time settings.

The screenshot shows the configuration page for a 9550 Dual Radio 11n PoE Access Point, specifically the SNTP service settings. The interface includes a sidebar with navigation options and a main configuration area. The SNTP Client is currently set to 'Enable'. The 'Set Time' fields are visible, showing Year: 2000, Month: 1, Day: 2, Hour: 7, and Min: 44. The Time Zone is set to GMT: Greenwich Mean Time: Dublin, Edinburgh, Lisbon, London. Daylight Saving is set to 'Disable', and the 'Set start/end dates' fields are visible. Primary and Secondary Servers and Ports are also configured.

The following settings can be configured.

SNTP client enable/disable	Click the radio button to enable. If it is disabled, the user has to input time manually. If it is enabled, the device will try to fetch time from configured SNTP servers.
Set Time	Includes Year, Month, Day, Hour and Minute. These fields are grayed out and un-configurable if SNTP is enabled.

Timezone selection	This selection will adjust the time obtained from the SNTP server. Note: This selection does not affect manual time input as they are considered to be input at the same time.
Daylight Saving	The start/end date of daylight saving will change automatically based on the time zone selection. Note: Start and End dates can be input manually, to avoid any regional policy changes.
Primary and Secondary SNTP server/port setting	If SNTP is enabled, this device will try to fetch time from the primary server first. The timeout for primary NTP server is 5 seconds. If the Primary NTP server fails after 5 seconds the Secondary NTP server will be tried for 5 seconds. In the event that the secondary server fails, the device will wait for 60 seconds before trying the Primary server again. This continues until a time is available.

To avoid using an invalid NTP server address, this device will store the fetched/configured time. After it boots up, it will use the stored time first and adjust time if time is fetched.

Syslog function

In the event of an error the device can send a message to a specified server.



System Log

Click either Enable or Disable to activate or deactivate the system log function.

Syslog Server

Enter the IP address of the server that will receive the error information. The default IP address is 0.0.0.0

Syslog Port

Enter the port number that your server can be accessed by. The default port number is 514.

Syslog Level

Choose from the following levels - in order of severity - of detail to be recorded. The default setting is Error.

- Emergency - System is unusable
- Alert - Action must be taken immediately
- Critical - Critical condition
- Error - Error condition
- Warning - Warning condition
- Notice - Normal, but significant condition
- Informational - Informational messages

Management

This section describes how to use the management and information features of your Wireless Access Point.

Administration

In this section, you can change the user administrator name and password. The default Administrator name is **admin** (case sensitive), and password is **password**. Click “Apply” to save changes.



SNMP

The screenshot shows the management interface for a 9550 Dual Radio 11n PoE Access Point. The main configuration area is titled "Management -> SNMP". It contains the following fields and options:

- SNMP:** Radio buttons for Enable and Disable.
- SNMP Version Support:** Radio buttons for SNMP v1 and SNMP v2.
- Contact:** Text input field.
- Community Name (Read Only):** Text input field.
- Community Name (Read/Write):** Text input field.
- Trap Destination IP Address:** IP address input field.
- Trap Destination Community Name:** Text input field.

At the bottom of the configuration area are "Apply" and "Cancel" buttons. Below the buttons, a message states: "You must click Apply to save your settings before moving to another page."

The SNMP administrative functions are changed through this section. The following functions can be changed:

- Enable/Disable SNMP
- Contact info
- Community names for read-only and read/write
- Trap destination IP address
- Community name

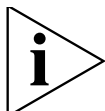

This function is not available in Wireless Bridge mode.

MAC Filtering



MAC filtering allows the administrator to filter MAC addresses of network cards that can access the access point.

- Enable/Disable filter
- Change filter rule to allow or deny
- Add/delete MAC addresses in the filter table

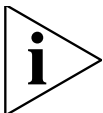

This function is only available in AP mode.

Rogue AP Detection



Unspecified Access Points may try to access the network through this device. Rogue AP detection can prevent this.

- Change Rogue AP definition.
- Legal AP list - The list of allowed access points.
- Detect rogue AP – All channels are scanned and Access Points without security, or not in legal AP, are considered rogue.

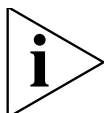

This function is only available in AP mode.

Backup/ Restore Settings

This section allows the user back up the Access Point's current settings and restore back to the factory default. Once you have the Access Point working properly you should back up the information to have it available if something goes wrong.

The screenshot displays the web management interface for a 3COM 9550 Dual Radio 11n PoE Access Point. The interface is divided into a left sidebar and a main content area.

Left Sidebar (Navigation Menu):

- Access Point**
 - System Status
 - System Summary
 - Wireless Station List
 - Event Log List
 - System Configuration
 - Setup Wizard
 - System Properties
 - IP Settings
 - 2.4G Radio Configuration
 - Wireless Network
 - WDS Link Settings
 - WDS Security Settings
 - Wireless Advanced Settings
 - QoS
 - 5G Radio Configuration
 - Wireless Network
 - WDS Link Settings
 - WDS Security Settings
 - Wireless Advanced Settings
 - QoS
 - Service
 - Management VLAN
 - SNMP
 - SMTP
 - System
 - Management
 - Administration
 - SNMP
 - MAC Filtering
 - Single AP Detection
 - Backup/Restore Settings
 - Firmware Auto Upgrade
 - Firmware Upgrade
 - Reboot
- Log Off

Main Content Area (Backup/Restore Settings):

The main content area is titled "9550 Dual Radio 11n PoE Access Point" and "Management -> Backup/Restore Settings". It contains four sections:

- Backup the current settings to a file:** A blue bar with a "Backup" button.
- Show all the configurations of this device:** A blue bar with a "Backup" button.
- Restore settings from a backup file:** A blue bar with a "File:" label, a text input field containing "218...", and a "Restore" button.
- Restore factory default settings:** A blue bar with an "Apply" button.

Firmware Auto Update

The Wireless Access Point can auto upgrade the firmware if there is a newer version available. If you enable the Auto Upgrade function, the Wireless Access Point will automatically check for an updated version of firmware in the assigned FTP server for each time interval assigned. Remember to insert the correct FTP server IP address, username, password and correct path to the FTP server.

The screenshot displays the management interface for a 9550 Dual Radio 11n PoE Access Point. The left sidebar shows a navigation menu with categories like System Status, System Configuration, 2.4G Radio Configuration, 5G Radio Configuration, Service, and Management. The main content area is titled "Management -> Firmware Auto Upgrade" and contains the following settings:

- Auto Upgrade:** Enable Disable
- Reboot:** Yes No
- Time Interval:** 0 Days
- Local Firmware File:** A red notice states: "Notice: The length of the filename (including extension) should be no more than 20 characters, or the file will be invalid! Different version found Later version found"
- FTP Server IP Address:** [. . .]
- FTP Login Name:** []
- FTP Password:** []
- Firmware Path:** []

Buttons for "Apply" and "Cancel" are located below the form. A message at the bottom reads: "You must click Apply to save your settings before moving to another page."

Firmware Upgrade

In this section, you can see the current firmware version of your AP. You can also manually upgrade your firmware by entering the path to your new firmware file.

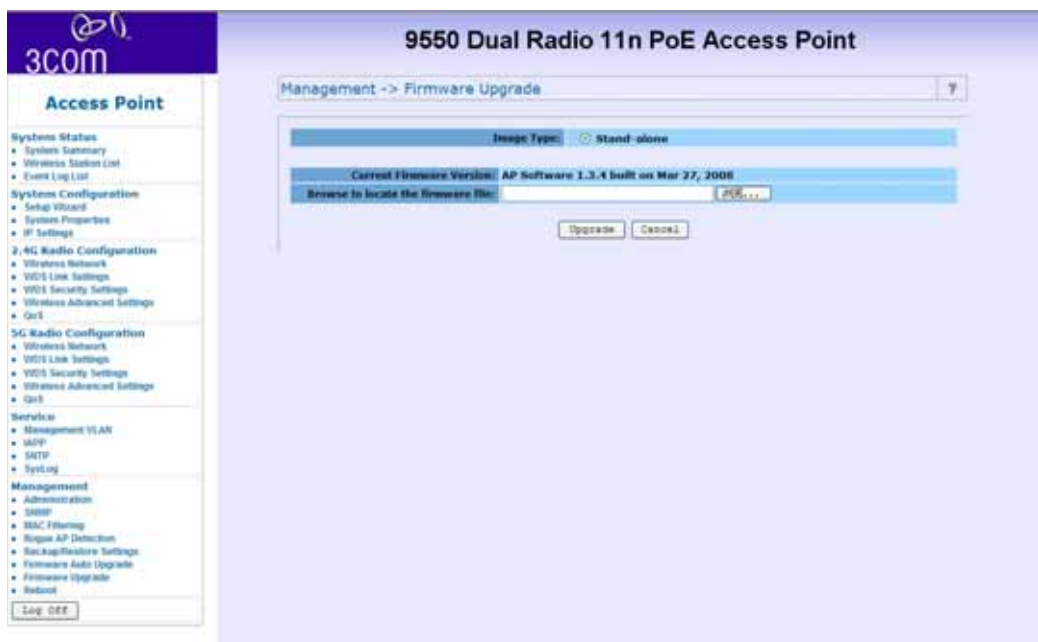

The screenshot displays the management interface for a 3COM 9550 Dual Radio 11n PoE Access Point. The left sidebar shows a navigation menu with categories: System Status, System Configuration, 2.4G Radio Configuration, 5G Radio Configuration, Services, and Management. The main content area is titled "9550 Dual Radio 11n PoE Access Point" and shows the "Management -> Firmware Upgrade" page. The interface includes a breadcrumb trail, a "Image Type" dropdown set to "Stand-alone", and a "Current Firmware Version" field displaying "AP Software 1.3.4 built on Mar 27, 2008". Below this is a "Browse to locate the firmware file:" field with a file selection button. At the bottom of the main area are "Upgrade" and "Cancel" buttons.

Once you have chosen the upgrade file click **upgrade**.

The screenshot displays the management interface for a 3COM 9550 Dual Radio 11n PoE Access Point. The left sidebar contains a navigation menu with the following sections:

- Access Point**
- System Status**
 - System Summary
 - Wireless Station List
 - Event Log List
- System Configuration**
 - Setup Wizard
 - System Properties
 - IP Settings
- 2.4G Radio Configuration**
 - Wireless Network
 - WDS Link Settings
 - WDS Security Settings
 - Wireless Advanced Settings
 - QoS
- 5G Radio Configuration**
 - Wireless Network
 - WDS Link Settings
 - WDS Security Settings
 - Wireless Advanced Settings
 - QoS
- Service**
 - Management V.LAN
 - UPnP
 - SNTP
 - SysLog
- Management**
 - Administration
 - DDNS
 - MAC Filtering
 - Rogue AP Detection
 - Recovery/Restore Settings
 - Firmware Auto Upgrade
 - Firmware Upgrade
 - Reboot

At the bottom of the sidebar is a **Log Off** button.

The main content area shows the breadcrumb path: **Management -> Firmware Update -> Result**. The central message reads:

Firmware Updated Successfully
Receive: 5767188 Bytes

A reminder message states: **Reminder: Go to the Reboot Page for changes to take effect**.

Rebooting

You can reboot the Wireless access point from the browser interface.

After you click reboot the following window will be displayed.



After rebooting, the login page will automatically be displayed.

Connecting through the Com Port

Instead of using an IP address to configure the Access Point a Null modem cable, connected to the RJ-45 Console Port, can be used.

In your terminal settings ensure that the following configuration is met:

Bits per Second – 9600

Data Bits – 8

Parity – None

Stop bits – 1

Flow Control - none

Once connected enter the user name and password. The default values are as follows:

- Username: **admin**
- Password: **password**

Once logged in, type “?” for a list of commands.

Restoring factory settings

The Access Point can be reset to the default factory settings either through the web browser (see “Backup/ Restore Settings” on page 64) or manually.

To restore the settings manually, insert a pointed object (such as the end of a straightened paper clip) into the reset hole on the side of the Access Point, and hold for five seconds.

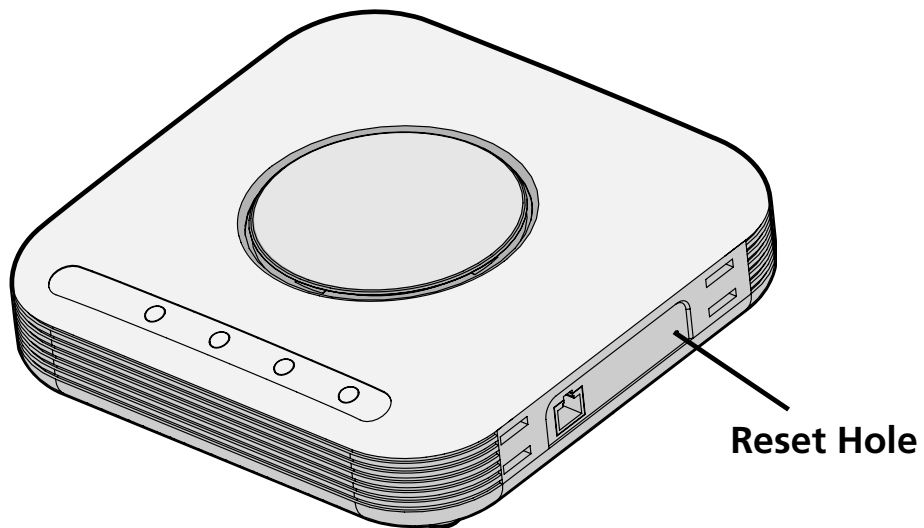

A TROUBLESHOOTING

Diagnosing Problems

If you have difficulty with the Access point, try the solutions in the following table.

Symptom

After you change the IP address, after you restore a backup configuration, or after you reset the Access point to factory defaults, the Configuration Management System stops responding and you cannot continue configuring the Access point. If you change the IP address and click Apply, you cannot continue to configure the device using the old IP address. Similarly, after you restore a backup configuration or reset the Access point to factory defaults, the IP address setting may be changed.

Solution (s)

To recover from this situation and continue configuring the Access point:

- 1** Close your browser.
- 2** Return to the 3Com Wireless Infrastructure Device Manager and click Refresh.
- 3** Select the device and click Configure to start a new configuration session and set its IP address.

Symptom

The Wireless Network Tree does not appear in the 3Com Wireless Infrastructure Device Manager window.

Solution (s)

Verify that you are using the correct network adapter. In the device manager window, click Choose NIC. Select the network adapter for the network you want to scan, and click OK.

Symptom

The Access point has a yellow exclamation point (!) next to it in the Wireless Infrastructure Device Manager.

Solution (s)

- The Access point is on a different subnet than the computer attempting to configure it.
- To recover from this situation and continue configuring the Access point:
 - a Close your browser.
 - b Return to the 3Com Wireless Infrastructure Device Manager and click Refresh.
 - c Select the device and click Configure to start a new configuration session.
 - d Make sure the subnet address matches that of the computer.

Symptom

Two Access points cannot communicate in ad-hoc mode.

Solution (s)

Adjust the positions of the Access points to improve reception.

To ensure correct operation in ad-hoc mode, the settings on the two Access points must match exactly.

Launch the Access point Configuration Management System and make sure that the Wireless LAN Service Area, channel selections, Data Preamble setting, and security setting are the same on both Access points.

Symptom

You are running Windows NT. After you connect the Access point, your computer cannot obtain a valid IP address.

Solution (s)

The Access point configuration settings may not be compatible with the network. If they are not, and your Windows NT computer is set up to obtain its IP address from a DHCP server, the Access point is unable to associate with the network to obtain the IP address.

To work around this, set a static IP address on your computer. Then set the Access point configuration to match the network. When the Access point is able to associate, reset your computer to obtain its IP address from the DHCP server. If the Access point should also obtain its IP settings from the DHCP server, make sure this is configured properly on the IP Network page and applied just before ending the session.

Symptom

Disconnecting the Access point

Solution (s)

To disconnect the Access point:

CAUTION: Disconnecting the Access point ends the network association. To avoid possible data loss, exit all networking

applications on connected devices before you disconnect the Access point.

- a** Unplug the Access point Ethernet cable from the hub or other device.
- b** Unplug the Access point power cord.

Symptom

Uninstalling Software and Documentation

Solution (s)

If you want to uninstall the 3Com 11a/b/g/n Wireless Workgroup Access point software and documentation, you can either use the standard operating system procedure for removing programs or use the following shortcut:

From the Windows Start menu, select Start > Programs > 3Com Wireless > Uninstall 3Com Wireless Infrastructure Device Manager.

When prompted to confirm, click OK.

Symptom

Upgrading Access point Firmware.

Solution (s)

Firmware is the software that is installed on the Access Point at the factory. Some problems can be solved by installing a new version of the firmware.

For details on how to download a firmware update from the 3Com customer support Web site and install it on your Access Point, see "Firmware Auto Update" on page 65 or "Firmware Upgrade" on page 66.

B OBTAINING SUPPORT FOR YOUR 3COM PRODUCT

3Com offers product registration, case management, and repair services through <http://eSupport.3Com.com>. You must have a user name and password to access the services, described in this appendix.

Register Your Product to Gain Service Benefits

To take advantage of warranty and other service benefits, you must first register your product at:

<http://eSupport.3Com.com/>

3Com eSupport services are based on accounts that are created or that you are authorized to access.

Solve Problems Online

The 3Com Knowledge base helps you to troubleshoot 3Com products. This query-based interactive tool is located at:

<http://knowledgebase.3Com.com>

It contains thousands of technical solutions written by 3Com support engineers.

Purchase Extended Warranty and Professional Services

To enhance response times or extend your warranty benefits, you can purchase value-added services such as 24x7 telephone technical support, software upgrades, onsite assistance, or advanced hardware replacement.

Experienced engineers are available to manage your installation with minimal disruption to your network. Expert assessment and implementation services are offered to fill resource gaps and ensure the success of your networking projects. For more information on 3Com Extended Warranty and Professional Services, see:

<http://www.3Com.com/>

Contact your authorized 3Com reseller or 3Com for additional product and support information. See the table of access numbers later in this appendix.

Access Software Downloads

You are entitled to bug fix / maintenance releases for the version of software that you initially purchased with your 3Com product.

To obtain access to this software, you need to register your product and then use the Serial Number as your login. Restricted Software is available at:

<http://eSupport.3Com.com/>

To obtain software releases that follow the software version that you originally purchased, 3Com recommends that you buy an Express or Guardian contract, a Software Upgrades contract, or an equivalent support contract from 3Com or your reseller. Support contracts that include software upgrades cover feature enhancements, incremental functionality, and bug fixes, but they do not include software that is released by 3Com as a separately ordered product. Separately orderable software releases and licenses are listed in the 3Com Price List and are available for purchase from your 3Com reseller.

Contact Us

3Com offers telephone, Internet, and e-mail access to technical support and repair services. To access these services for your region, use the appropriate telephone number, URL, or e-mail address from the table in the next section.

Telephone Technical Support and Repair

To obtain telephone support as part of your warranty and other service benefits, you must first register your product at:

<http://eSupport.3Com.com/>

When you contact 3Com for assistance, have the following information ready:

- Product model name, part number, and serial number
- A list of system hardware and software, including revision level
- Diagnostic error messages
- Details about recent configuration changes, if applicable

To send a product directly to 3Com for repair, you must first obtain a return materials authorization number (RMA). Products sent to 3Com without authorization numbers clearly marked on the outside of the package will be returned to the sender unopened, at the sender's expense. If your product is registered and under warranty, you can obtain an RMA number online at **<http://eSupport.3Com.com/>**. First-time users must apply for a user name and password.

Telephone numbers are correct at the time of publication. Find a current directory of 3Com resources by region at:

<http://csoweb4.3Com.com/contactus/>

C

END USER LICENSE AGREEMENT

Customer shall take all steps necessary to protect Wind River's and its licensors' proprietary rights in the Run-Time Module and to ensure that each Run-Time Module distributed by Customer will be accompanied by a localized copy of an End User License Agreement.

Such End User License Agreement shall prohibit the End User from: (i) copying the Run-Time Module, except for archive purposes consistent with the End User's archive procedures; (ii) transferring the Run-Time Module to a third party apart from the Target Application; (iii) modifying, decompiling, disassembling, reverse engineering or otherwise attempting to derive the Source Code of the Run-Time Module; (iv) exporting the Run-Time Module or underlying technology in contravention of applicable U.S. and foreign export laws and regulations; and (v) using the Run-Time Module other than in connection with operation of the Target Application.

In addition, the End User License Agreement shall: (i) state that the Run-Time Module is licensed, not sold and that Customer and its licensors retain ownership of all copies of the Run-Time Module; (ii) expressly disclaim all implied warranties, including

without limitation the implied warranties of merchantability, fitness for a particular purpose, title and non-infringement; (iii) exclude liability for any special, indirect, punitive, incidental and consequential damages; and (iv) require that any further distribution of the Run-Time Module be subject to the same restrictions set forth herein.

The End User License Agreement shall also state that, with respect to the Run-Time Module, Wind River and its licensors are third party beneficiaries of the End User License Agreement and that the provisions related to the Run-Time Module are made expressly for the benefit of, and are enforceable by, Wind River and its licensors.

D APPENDIX

Antennas Used per Mode

The AP has three external antenna connectors, labelled A, B and C, as shown below.

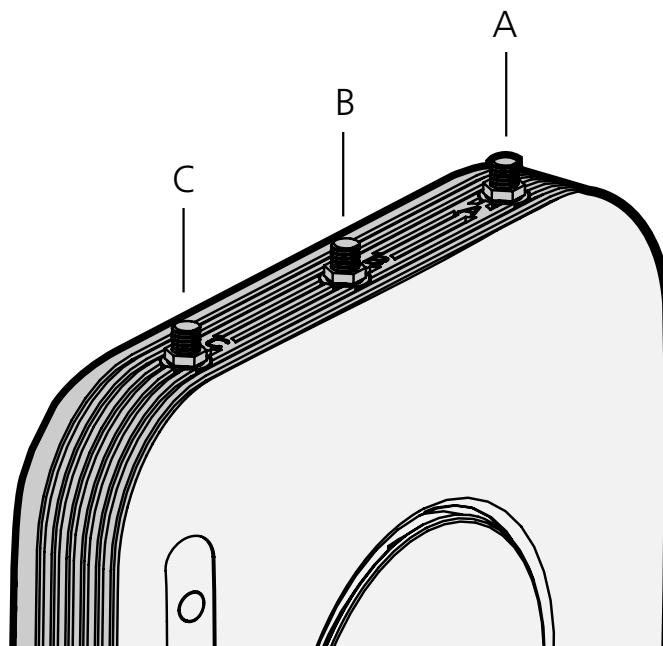

In some modes, not all of the connectors are in use.

The following table defines which external antenna connectors are used in which mode:

Mode	Antennas Used
2x3	A,B,C
2x2	A,C
1x1	A

Console Cable Pin-out

RJ45 to D-SUB 9 pin cable

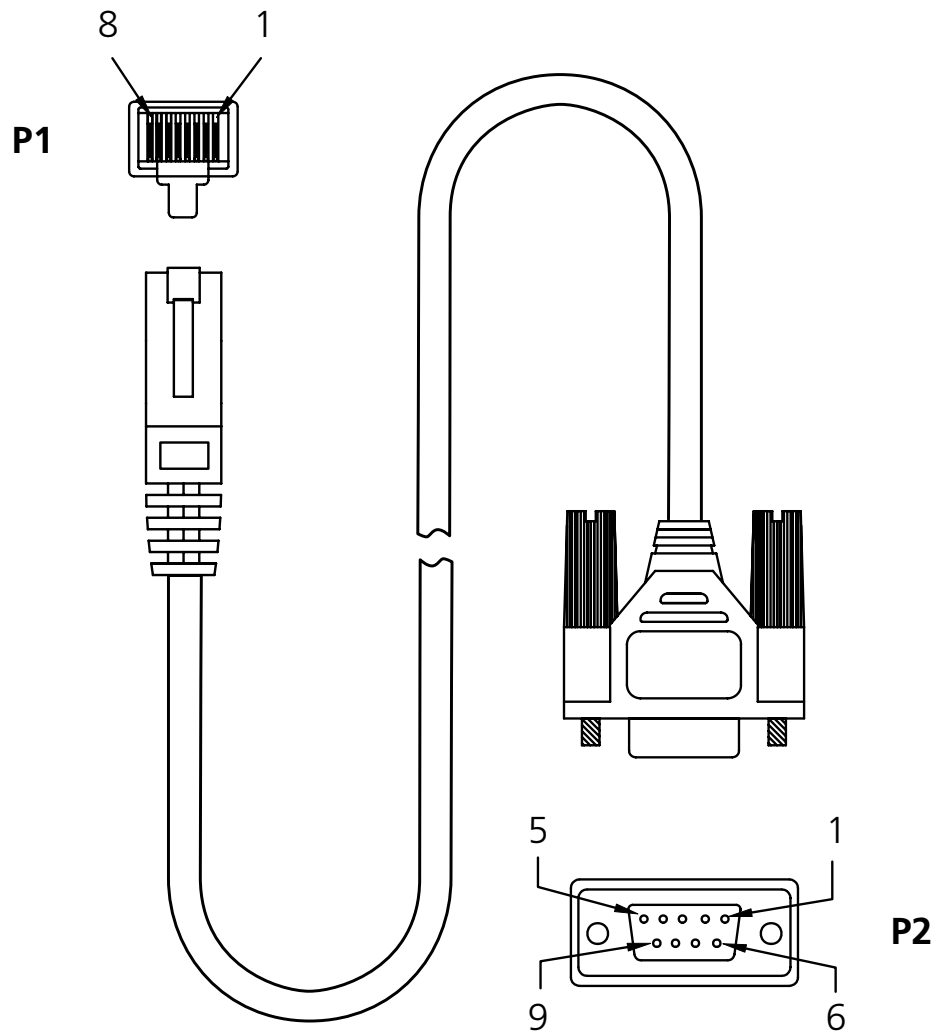

P1 Pin no.	WIRE COLOR	P2 Pin no.
8	YELLOW	1
6	BROWN	2
2	GRAY	3
1	GREEN	4
5	RED	5
3	BLUE	6
4	BLACK	7
7	WHITE	8

INDEX

Numerics

802.11a	9
802.11b/g	10
802.11d	50

A

Access Point mode	35
Ad-hoc mode	35
Administration	60
Advanced Settings	48
Antennas Used per Mode	83

B

Backup	64
Beacon Interval	49
BSSID	41

C

Com Port	69
Configuring	23
Console Cable	85

Contention	54
------------------	----

D

Data Beacon Rate	49
Data Rate	48
default IP address	24, 58
Delivery Traffic Indication Message	49
Device Manager ...	9, 23, 25, 75
DHCP Server	23
DTIM	49

F

factory settings	70
FAT	36
Firmware	76
Firmware Auto Update	65
Firmware Upgrade	66
FIT	36
Fixed Slot Time	54
Fragment Length	49

I		
IAPP	52	
IEEE 802.3af	11	
Installation	25	
Inter-Access Point Protocol	52	
IP Settings	37	
L		
LED Indicators	21	
login	24, 28	
M		
MAC Filtering	62	
Management VLAN	51	
P		
package contents	13	
Password	24, 28, 69	
password	60	
PoE	9	
Power over Ethernet	9	
Q		
QoS	53	
		Quality of Service
		53
R		
Rebooting	68	
Repeater mode	35	
Restore	64	
Rogue AP Detection	63	
RTS Threshold	49	
S		
Security	8	
Setting Up	31	
Simple Network Management Pro- tocol	61	
Simple Network Time Protocol	56	
SNMP	61	
SNTP	56	
SSID	32, 40	
Suppressed SSID	41	
System Properties	35	
System Summary	29	
T		
terminal settings	69	
Transmit Power	49	

U

Username69

V

VLAN ID41

W

Wall Mounting 17

WDS45

WDS Security47

WEP42

Wi-Fi Protected Access43

Wired Equivalent Privacy42

wireless client35

Wireless Distribution System ...45

Wireless Network Standards9

wireless range 16

WPA43

WPA244

Federal Communication Commission Interference Statement

This equipment has been tested and found to comply with the limits for a Class B digital device, pursuant to Part 15 of the FCC Rules. These limits are designed to provide reasonable protection against harmful interference in a residential installation. This equipment generates, uses and can radiate radio frequency energy and, if not installed and used in accordance with the instructions, may cause harmful interference to radio communications. However, there is no guarantee that interference will not occur in a particular installation. If this equipment does cause harmful interference to radio or television reception, which can be determined by turning the equipment off and on, the user is encouraged to try to correct the interference by one of the following measures:

- Reorient or relocate the receiving antenna.
- Increase the separation between the equipment and receiver.
- Connect the equipment into an outlet on a circuit different from that to which the receiver is connected.
- Consult the dealer or an experienced radio/TV technician for help.

This device complies with Part 15 of the FCC Rules. Operation is subject to the following two conditions: (1) This device may not cause harmful interference, and (2) this device must accept any interference received, including interference that may cause undesired operation.

FCC Caution: Any changes or modifications not expressly approved by the party responsible for compliance could void the user's authority to operate this equipment. This device and its antenna(s) must not be co-located or operating in conjunction with any other antenna or transmitter.

IMPORTANT NOTE:

FCC Radiation Exposure Statement:

This equipment complies with FCC / IC RSS-102 radiation exposure limits set forth for an uncontrolled environment. This equipment should be installed and operated with minimum distance **20cm** between the radiator & your body.

Canada C Request

"Operation is subject to the following two conditions: (1) this device may not cause interference, and (2) this device must accept any interference, including interference that may cause undesired operation of the device."

"To reduce potential radio interference to other users, the antenna type and its gain should be so chosen that the equivalent isotropically radiated power (EIRP) is not more than that required for successful communication"

"This device has been designed to operate with an antenna having a maximum gain of **18** dBi. Antenna having a higher gain is strictly prohibited per regulations of Industry Canada. The required antenna impedance is 50 ohms."

"To reduce potential radio interference to other users, the antenna type and its gain should be so chosen that the equivalent isotropically radiated power (e.i.r.p.) is not more than that permitted for successful communication."

The County Code Selection feature is disabled for products marketed in the US/Canada

This Class [B] digital apparatus complies with Canadian ICES-003.

Cet appareil numérique de la classe [B] est conforme à la norme NMB-003 du Canada.

If this device is going to be operated in 5.15 ~ 5.25GHz frequency range, then it is restricted in indoor environment only.

FCC NOTICE: To comply with FCC part 15 rules in the United States, the system must be professionally installed to ensure compliance with the Part 15 certification. It is the responsibility of the operator and professional installer to ensure that only certified systems are deployed in the United States. The use of the system in any other combination (such as co-located antennas transmitting the same information) is expressly forbidden.

Only the antennas listed below are allowed to be used with the radio.

Ant.	Antenna Type	Model Name	Product description	2.4/5 GHz Gain (dBi)	Tx/Rx mode
1	Omni Ant	3CWE591	3Com® 6/8dBi Dual-Band Omni Antenna	6/8	1T1R
2	Omni Ant	S24513BPX	CUSHCRAFT 2.4~2.5& 4.9~5.9 GHz DUAL BAND OMNI ANTENNA	6/6.5	1T1R
3	Omni Ant	SS-200-AT-AN-30	Airtight 2.4~2.5& 4.9~5.9 GHz Dual-band Omnidirectional Indoor/outdoor antenna	6/6.5	1T1R
4	Omni Ant	TGX-102XNXXX	Joymax Base Station Antenna	6/6	1T1R
5	Panel Ant	3CWE596	3Com® 18/20dBi Dual-Band Panel Antenna	18/20	2T2R
6	Panel Ant	3CWE598	3Com® 8/10dBi Dual-Band Panel Antenna	8/10	2T2R
7	Panel Ant	SL24513P12SMF	CUSHCRAFT Tri-mode, dual band 802.11b/a/g ceiling mounted Omnidirectional panel antenna	3/3	2T2R
8	Panel Ant	SS-200-AT-AN-10	Airtight dual band 802.11b/a/g Omnidirectional Indoor panel antenna	3/3	2T2R
9	Monopole Ant	3CWE590	3Com 2dBi Dual-Band Omni Antenna Kit	2/2	2T3R
10	PCB Antenna	TFF-A015MPAX-361	Integrated PCB Antenna	3/3	2T3R