

# DTU-H100

## Wi-Fi/Ethernet to RS232/RS485 Server

### User Manual

V1.1

#### Overview of Characteristic

- ◆ Embedded **UART to Wi-Fi device, hardware flow control (RTS/CTS) RS232** interface
- ◆ Support **IEEE802.11b/g/n** Wireless standards
- ◆ Support **TCP/UDP/HTTP** Network Protocols
- ◆ Support **SSL** Encryption
- ◆ Support **Telnet** Communication
- ◆ Support **RS232/RS485/Ethernet Data** Interface
- ◆ RS232 RS485 automatic switching
- ◆ Support Work As **STA/AP/AP+STA** Mode
- ◆ Support **Router/Bridge** Mode Networking
- ◆ Support **AT+ Instruction Set** for Configuration
- ◆ Support Friendly **Web Configuration** Page
- ◆ Single **5~18V DC** Power Supply
- ◆ Size: **84 x 84 x 25mm**
- ◆ **FCC/CE/TELEC/RoHs** Certificated



## TABLE OF CONTENTS

<b>1. PRODUCT OVERVIEW .....</b>	<b>10</b>
<b>1.1. General Specification .....</b>	<b>10</b>
<b>1.2. Hardware Introduction .....</b>	<b>11</b>
1.2.1. Interface Description.....	11
1.2.2. RS232 Interface .....	12
1.2.3. RS485 Interface .....	12
1.2.4. RJ45 Interface.....	12
1.2.5. Button Interface.....	13
1.2.6. Mechanical Size .....	14
1.2.7. Order Information .....	14
1.2.8. Device Difference .....	15
1.2.9. Package Information.....	15
<b>2. APPLICATION .....</b>	<b>16</b>
<b>2.1. Wireless Networking .....</b>	<b>16</b>
2.1.1. AP Application .....	16
2.1.2. STA Application.....	17
2.1.3. AP+STA Applicatioin .....	17
2.1.4. One AP One STA Applicatioin .....	19
<b>2.2. Ethernet Interface Communication .....</b>	<b>19</b>
2.2.1. Ethernet Interface Networking (As AP, N-Ver) .....	20
2.2.2. Ethernet Interface Networking (As STA, N-Ver) .....	20
2.2.3. Ethernet Interface Networking (As STA, Z-Ver) .....	21
<b>3. FUNCTION DESCRIPTION .....</b>	<b>22</b>
<b>3.1. User Configuration Process .....</b>	<b>22</b>
<b>3.2. Working Mode.....</b>	<b>22</b>
3.2.1. Transparent Transmission Mode .....	22
3.2.2. Agreement(Serial Command Mode) .....	23
3.2.3. HTTPD Client Mode .....	24
<b>3.3. Wi-Fi Parameter Setting .....</b>	<b>25</b>
3.3.1. Auto- Frequency Function .....	25
3.3.2. Security .....	25
3.3.3. Search Function for STA .....	25
3.3.4. Address Binding .....	25
<b>3.4. UART Frame Scheme .....</b>	<b>25</b>
3.4.1. UART Free-Frame.....	25
3.4.2. UART Auto-Frame.....	26
<b>3.5. Network Setting .....</b>	<b>26</b>
3.5.1. Socket A.....	26
3.5.2. Socket B.....	27
<b>3.6. TCP Password Authentication.....</b>	<b>27</b>
<b>3.7. Upload ID .....</b>	<b>28</b>
<b>3.8. Keepalive(Reserved) .....</b>	<b>28</b>
<b>3.9. Multiple STA Parameters .....</b>	<b>28</b>
<b>3.10. Websocket(Reserved).....</b>	<b>28</b>
<b>3.11. Parameters Setting .....</b>	<b>28</b>

3.12.	Palmodic Signal .....	28
3.13.	Firmware Upgrade .....	29
<b>4.</b>	<b>OPERATION GUIDELINE .....</b>	<b>30</b>
4.1.	Configuration via Web Accessing .....	30
4.1.1.	Open Web Management Interface .....	30
4.1.2.	Quick Configure .....	30
4.1.3.	Mode Selection Page .....	31
4.1.4.	AP Interface Setting Page .....	32
4.1.5.	STA Interface Setting Page .....	32
4.1.6.	Application Setting Page .....	33
4.1.7.	Ethernet Setting .....	34
4.1.8.	HTTPD Client Mode .....	34
4.1.9.	Device Management Page .....	34
4.2.	The device Usage Introduction .....	35
4.2.1.	Software Debug Tools .....	35
4.2.2.	Network Connection .....	35
4.2.3.	Device Debug .....	36
4.3.	Typical Application Examples .....	38
4.3.1.	Wireless Control Application .....	38
4.3.2.	Remote Management Application .....	39
4.3.3.	Transparent Serial Port Application .....	39
4.3.4.	Wireless Data Acquisition Card Application .....	40
<b>5.</b>	<b>AT+INSTRUCTION INTRODUCTION .....</b>	<b>42</b>
5.1.	Configuration Mode .....	42
5.1.1.	Switch to Configuration Mode .....	42
5.2.	AT+ Instruction Set Overview .....	43
5.2.1.	Instruction Syntax Format .....	43
5.2.2.	AT+ Instruction Set .....	44
5.2.2.1.	AT+E .....	45
5.2.2.2.	AT+ENTM .....	46
5.2.2.3.	AT+NETP .....	46
5.2.2.4.	AT+UART .....	46
5.2.2.5.	AT+ UARTF .....	47
5.2.2.6.	AT+ UARTFT .....	47
5.2.2.7.	AT+ UARTFL .....	47
5.2.2.8.	AT+TMODE .....	48
5.2.2.9.	AT+WMODE .....	48
5.2.2.10.	AT+WSKEY/AT+WSKEYA .....	48
5.2.2.11.	AT+WSKEYB .....	49
5.2.2.12.	AT+WSKEYC .....	49
5.2.2.13.	AT+WSSSID/AT+WSSSIDA .....	50
5.2.2.14.	AT+WSSSIDB .....	50
5.2.2.15.	AT+WSSSIDC .....	51
5.2.2.16.	AT+MSSID .....	51
5.2.2.17.	AT+WSLK .....	51
5.2.2.18.	AT+WEBU .....	52
5.2.2.19.	AT+WAP .....	52
5.2.2.20.	AT+WAKEY .....	53

5.2.2.21.	AT+HIDESSID.....	53
5.2.2.22.	AT+MSLP.....	53
5.2.2.23.	AT+WSCAN.....	54
5.2.2.24.	AT+ TCPLK.....	54
5.2.2.25.	AT + TCPDIS.....	54
5.2.2.26.	AT+ WANN.....	55
5.2.2.27.	AT+ LANN.....	55
5.2.2.28.	AT + DHCPDEN.....	55
5.2.2.29.	AT+ DHCPGW.....	56
5.2.2.30.	AT+ TCPTO.....	56
5.2.2.31.	AT+ MAXSK.....	56
5.2.2.32.	AT+TCPB.....	57
5.2.2.33.	AT+TCPPTB.....	57
5.2.2.34.	AT+TCPADDB.....	57
5.2.2.35.	AT+TCPTOB.....	58
5.2.2.36.	AT+TCPLKB.....	58
5.2.2.37.	AT+REGEN.....	58
5.2.2.38.	AT+REGTCP.....	59
5.2.2.39.	AT+REGID.....	59
5.2.2.40.	AT+EPHY.....	59
5.2.2.41.	AT+STTC.....	60
5.2.2.42.	AT+DOMAIN.....	60
5.2.2.43.	AT+FRLDEN.....	60
5.2.2.44.	AT+RELD.....	61
5.2.2.45.	AT+Z.....	61
5.2.2.46.	AT+MID.....	61
5.2.2.47.	AT+WRMID.....	61
5.2.2.48.	AT+VER.....	61
5.2.2.49.	AT+H.....	61
5.2.2.50.	AT+FVEW.....	62
5.2.2.51.	AT+FVER.....	62
5.2.2.52.	AT+WMAC.....	62
5.2.2.53.	AT+PING.....	63
5.2.2.54.	AT+HTPSV/AT+HTTPURL.....	63
5.2.2.55.	AT+HTPTP/AT+HTTPTP.....	63
5.2.2.56.	AT+HTPURL/AT+HTTTPH.....	64
5.2.2.57.	AT+HTTPCN.....	64
5.2.2.58.	AT+HTTTPUA.....	64
5.2.2.59.	AT+HTPMODE.....	64
5.2.2.60.	AT+HTPHEAD.....	65
5.2.2.61.	AT+FASWD.....	65
<b>APPENDIX A: QUESTIONS AND ANSWERS.....</b>		<b>66</b>
<b>Q1: How to configure transparent serial port application (TCP protocol) with two DTU devices? .....</b>		<b>66</b>
<b>Q2: Where to SetDTU LAN IP and WAN IP through Web Page? .....</b>		<b>66</b>
<b>Q3: How to configure transparent serial port application (UDP protocol) with two DTUs?.....</b>		<b>67</b>
<b>Q4: Where to set DTU network protocol (TCP/UDP)? .....</b>		<b>67</b>
<b>Q5: How to configure transparent serial port application: Two DTUs all configured as STA and connection through AP?.....</b>		<b>69</b>

**Q6: How to avoid IP address confliction when apply DTU? .....70**  
**Q7: PC works as server, all DTUs works as data acquisition card and connect with PC, how to configure this application?.....70**  
**Q8: DTU works in STA mode, how does the PC get the DTU IP address.....71**

**APPENDIX B:RECOMMEND TOOLS .....72**  
**B.1. UART Tools .....72**  
**B.2. TCPUDP Tools .....72**  
**B.3. APP Tools .....72**

**APPENDIX C: CONTACT INFORMATION .....73**

## LIST OF FIGURES

Figure 1.	DTU-H100 Appearance.....	11
Figure 2.	RS232 Pin Defination(Male/Needle Type) .....	12
Figure 3.	RJ45 Pin Defination .....	13
Figure 4.	DTU-H100 Mechanical Dimension .....	14
Figure 5.	DTU-HXXX Series Order Information .....	14
Figure 6.	DTU-H1XX Functional Architecture .....	16
Figure 7.	DTU AP Application .....	16
Figure 8.	DTU STA Application .....	17
Figure 9.	DTU AP+STA Application .....	18
Figure 10.	One AP and One STA Application .....	19
Figure 11.	Ethernet Interface Networking (As AP) .....	20
Figure 12.	Ethernet Interface Networking (As STA, N-Ver) .....	20
Figure 13.	Ethernet Interface Networking (As STA, Z-Ver) .....	21
Figure 14.	Search Page.....	25
Figure 15.	Multi-TCP Link Data Transmition Structure .....	27
Figure 16.	Dual Socket Working Data Flow .....	27
Figure 17.	Open Web Management page.....	30
Figure 18.	Quick Configure Page .....	31
Figure 19.	Mode Selection Page .....	31
Figure 20.	AP Interface Setting Page .....	32
Figure 21.	STA Interface Setting Page .....	33
Figure 22.	Application Setting Page.....	33
Figure 23.	Ethernet Setting Page .....	34
Figure 24.	HTTPD Client Mode Page .....	34
Figure 25.	Device Management Page .....	35
Figure 26.	STA Interface Debug Connection .....	36
Figure 27.	AP Interface Debug Connection .....	36
Figure 28.	"CommTools" Serial Debug Tools.....	36
Figure 29.	"TCPUDPDbg" Tools Create Connection.....	37
Figure 30.	"TCPUDPDbg" Tools Setting .....	37
Figure 31.	"TCPUDPDbg" Tools Connection .....	38
Figure 32.	Wireless Control Application .....	38
Figure 33.	Remote Management Application .....	39
Figure 34.	Transparent Serial Port Application .....	40
Figure 35.	Wireless Data Acquisition Card Application .....	41
Figure 36.	The device Default UART Port Parameters .....	42
Figure 37.	Switch to Configuration Mode .....	42
Figure 38.	"AT+H" Instruction for Help.....	43
Figure 39.	Configure Transparent Serial Port Connection (TCP) .....	66
Figure 40.	DTU LAN IP Setting.....	66
Figure 41.	DTU WAN IP Setting .....	67
Figure 42.	Configure Transparent Serial Port Connection (UDP) .....	67
Figure 43.	DTU Network Protocols: TCP/Server .....	68
Figure 44.	DTU Network Protocol: TCP/Client .....	68
Figure 45.	DTU Network Protocol: UDP.....	69
Figure 46.	Two DTUs Connection Through AP .....	70
Figure 47.	Wireless Data Acquisition Card Setting.....	71

Figure 48. UDP Search Function .....	71
--------------------------------------	----

## LIST OF TABLES

Table 1 DTU-H100 Technical Specifications .....	10
Table 2 DTU-H100 External Interface .....	11
Table 3 RS232 Interface .....	12
Table 4 RJ45 Interface .....	13
Table 7 Serial Command Mode .....	23
Table 5 The device Web Access Default Setting .....	30
Table 6 Error Code DescriptionThe device Web Access Default Setting .....	44
Table 7 AT+ Instruction Set List .....	44

## HISTORY

**Ed. V0.1** Created on 01-27-2016.

**Ed. V0.2** Update AT command list and add Q&A.

**Ed. V1.0** Update GPIO function.

**Ed. V1.1** Add Telnet functio(firmware version at least 1.8), add TCPB SSL function(firmware version has TLS word support this feature, AT+VER: : 4.02.11.DTU-1.8-TLS), Add DTU-H101、DTU-H102 Type.



## FCC STATEMENT :

This device complies with Part 15 of the FCC Rules. Operation is subject to the following two conditions:

- (1) This device may not cause harmful interference, and
- (2) This device must accept any interference received, including interference that may cause undesired operation.

**Warning:** Changes or modifications not expressly approved by the party responsible for compliance could void the user's authority to operate the equipment.

NOTE: This equipment has been tested and found to comply with the limits for a Class B digital device, pursuant to Part 15 of the FCC Rules. These limits are designed to provide reasonable protection against harmful interference in a residential installation. This equipment generates uses and can radiate radio frequency energy and, if not installed and used in accordance with the instructions, may cause harmful interference to radio communications. However, there is no guarantee that interference will not occur in a particular installation. If this equipment does cause harmful interference to radio or television reception, which can be determined by turning the equipment off and on, the user is encouraged to try to correct the interference by one or more of the following measures:

- Reorient or relocate the receiving antenna.
- Increase the separation between the equipment and receiver.
- Connect the equipment into an outlet on a circuit different from that to which the receiver is connected.
- Consult the dealer or an experienced radio/TV technician for help.

## FCC Radiation Exposure Statement:

This equipment complies with FCC radiation exposure limits set forth for an uncontrolled environment. This equipment should be installed and operated with minimum distance 20cm between the radiator & your body.

# 1. PRODUCT OVERVIEW

## 1.1. General Specification

Table 1 DTU-H100 Technical Specifications

Class	Item	Parameters
<b>Ethernet Port</b>	Port Number	1
	Interface	8-Pin RJ45
	PHY Rate	10/100Mbps, MDI/MDIX
	Network Protocol	IP/TCP/UDP/DHCP/DNS/HTTP/ARP/ICMP/Web socket/Http Client
<b>Wi-Fi Port</b>	Standard	802.11 b/g/n
	Network Mode	STA/AP/STA+AP
	Max Connection	32
	Transmit Power	802.11b: +20 dBm (Max.)
		802.11g: +18 dBm (Max.)
		802.11n: +15 dBm (Max.)
	Receiver Sensitivity	802.11b: -89 dBm (@11Mbps, CCK)
802.11g: -81dBm(@54Mbps, OFDM)		
802.11n: -71dBm(@HT20, MCS7)		
Antenna Option	External: 3dBi Antenna	
<b>UART Port</b>	Port Number	2(1 x RS232, 1x RS485)
	Interface Standard	RS232: DB9 Pin Type RS485: 2 wire(A+, B-)
	Data Bits	5,6,7,8
	Stop Bit	1,2
	Check Bit	None, Even, Odd, Space, Mark
	Baud Rate	300 bps ~ 460800bps
	Flow Control	RTS / CTS
<b>Hardware Parameters</b>	Input Voltage	5~18V DC Input
	Operating Current	Avg:170mA Peak:400mA
	Operating Temp.	-40°C~85°C
	Storage Temp.	-45°C- 125°C / 5 ~ 95% RH
	Dimensions	84 x 84 x25mm
	Certificate	CE/FCC/TELEC/RoHS
	Warranty	2 Years
<b>Software Parameters</b>	Network Type	STA/AP/STA+AP
	Security Type	WEP/WPAPSK/WPA2PSK
	Encryption	WEP64/WEP128/TKIP/ AES
	Network Protocol	TCP/UDP/ARP/ICMP/DHCP/DNS/HTTP
	Max. TCP Connection	32
	Configure Interface	Web Server / AT Command
	Customization	Support Software Customization

## 1.2. Hardware Introduction

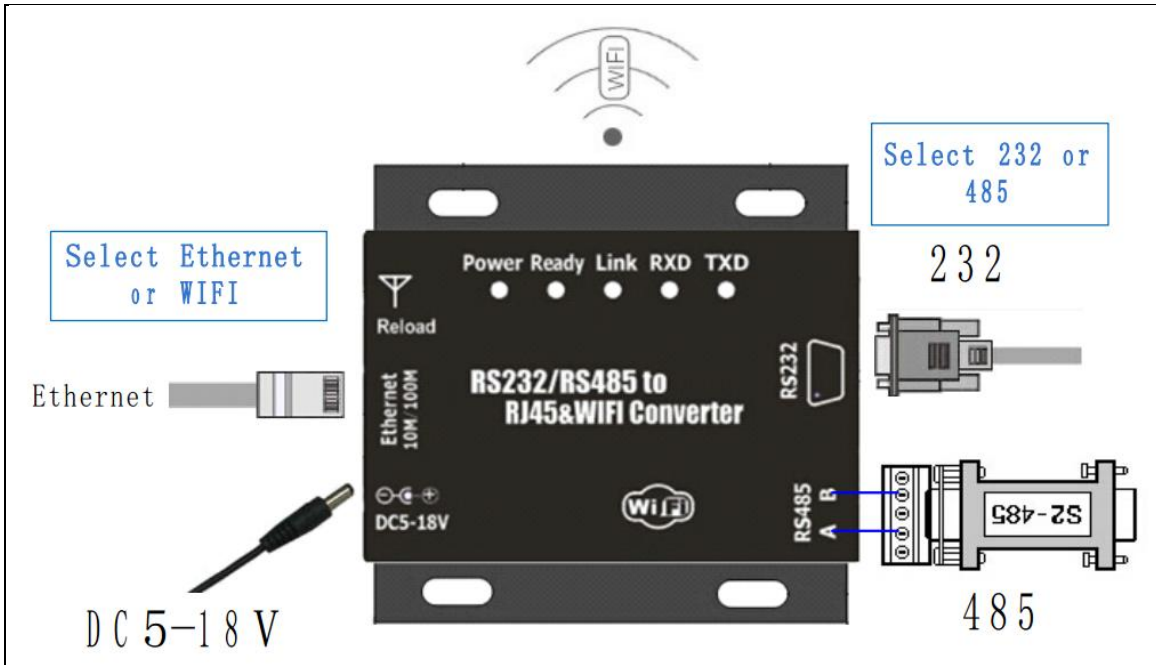

Figure 1. DTU-H100 Appearance

### 1.2.1. Interface Description

Table 2 DTU-H100 External Interface

Function	Name	Description
External Interface	RJ45 Ethernet	10/100M Ethernet
	RS232	RS232 Communication
	RS485	RS485 Communicaton
	DC5-18V	DC Power 5~18V Input
LED Indicator	Power	3.3V Internal Power Supply Indicator
	Ready	Boot Indicator On: Device boot OK. Off: Waiting For Device boot. (The device need about 7 seconds to boot)
	Link	Wi-Fli Connection Indication On : STA mode Connect to AP or AP mode other device connect to it. Off : No Wi-Fi Conectoin
	RXD	RS232/RS485 Data Receive
	TXD	RS232/RS485 Data Transfer

Function	Name	Description
Button	Reload	Restore to Factory Setting Button Long Press this button for 3 seconds and loosen, the device will restore to factory setting in 10 seconds.

### 1.2.2. RS232 Interface

Device serial port is male(needle), RS232 voltage level(can connect to PC directly), Pin Order is consistent with PC COM port. Use cross Cable connected with PC(2-3 cross, 7-8 cross, 5-5 direct, 7-8 no connection), see the following table for pin definition.



Figure 2. RS232 Pin Definition(Male/Needle Type)

Table 3 RS232 Interface

Pin Number	Name	Description
2	RXD	Receive Data
3	TXD	Send Data
5	GND	GND
7	RTS	Request to Send
8	CTS	Clear to Send
9	VCC	Default not used. May connect the jumper of the DTU main board to make this pin connected with DTU DC power supply.

### 1.2.3. RS485 Interface

RS485 use two wire links, A(DATA+), B(DATA-). Connect A(+) to A(+), B(-) to B(-) for communication.

### 1.2.4. RJ45 Interface

DTU-H100 Ethernet port is 10M/100M adaptive, support AUTO MDI/MDIX which means it support direct connecting to PC with Ethernet cable. Ethernet function is enabled by default and it can also be closed for power save via web or AT command.

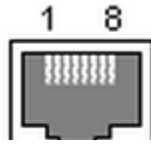

Figure 3. RJ45 Pin Definition

Table 4 RJ45 Interface

Pin Number	Name	Description
1	TX+	Transfer Data+
2	TX-	Transfer Data-
3	RX+	Receive Data+
4	PHY-VCC	Transformer Tap Voltage
5	PHY-VCC	Transformer Tap Voltage
6	RX-	Receive Data-
7	N.C.	None Connect
8	N.C.	None Connect

#### 1.2.5. Button Interface

This Button is used for restore device to factory setting. When device is working(Ready LED on), Press down this Button for more than 3 seconds and then lose, the device will reboot and restore to factory setting in 10 seconds(Ready LED will be off when reboot, then it will on for boot OK).

1.2.6. Mechanical Size

DTU-H100 device physical size as follows:

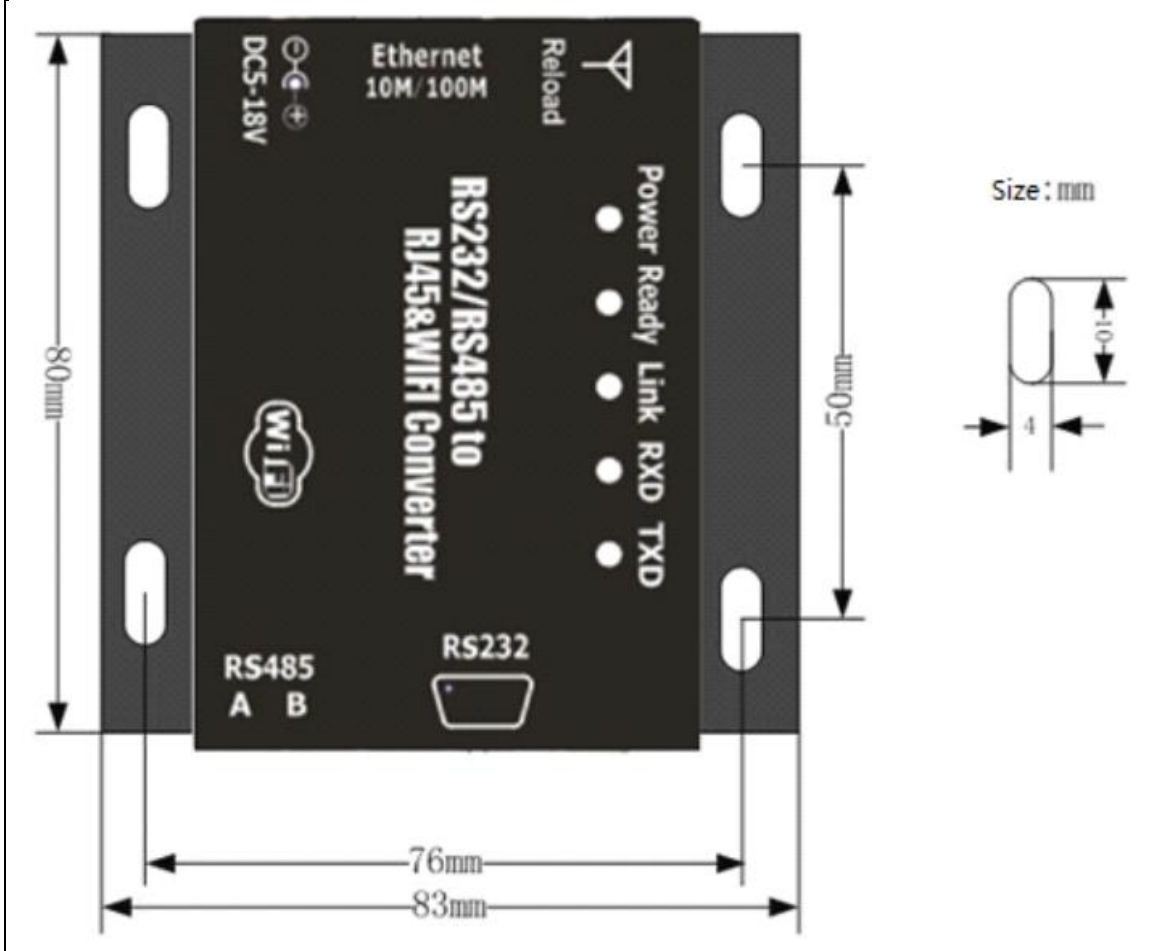

Figure 4. DTU-H100 Mechanical Dimension

1.2.7. Order Information

Base on customer detailed requirement, DTU-HXXX series product provide different variants and physical type for detailed application.

# DTU-HXXX

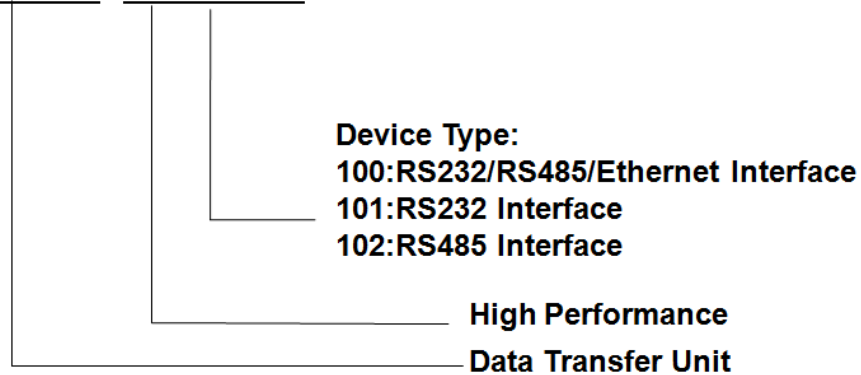

Figure 5. DTU-HXXX Series Order Information

### 1.2.8. Device Difference

Device difference is as following.

Type	RS232	RS485	Ethernet	Input Voltage	Size(mm)
DTU-H100	√	√	√	5~18V	84x84x25
DTU-H101	√			5~18V	84x84x25
DTU-H101		√		5~18V	84x84x25

### 1.2.9. Package Information

1 \* DTU-HXXX

1 \* 5V/1A Power Adapter

1 \* Serial Cable(Only for DTU-H100)

1 \* Ethernet Cable(Only for DTU-H100)

1 \* 3dBi Antenna

## 2. APPLICATION

### 2.1. Wireless Networking

The device can be configured as both wireless STA and AP base on network type. Logically there are two interfaces in the device. One is for STA, and another is for AP. When the device works as AP, other STA equipments are able to connect to wireless LAN via the device. Wireless Networking is very flexible.

Following figure shows the functional architecture:

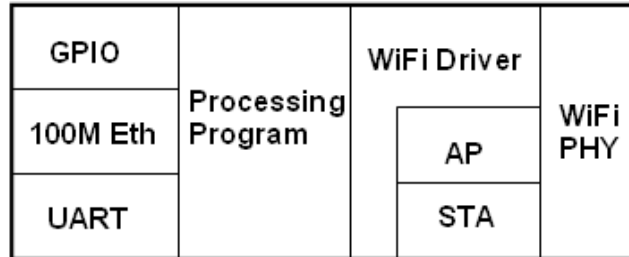

Figure 6. DTU-H1XX Functional Architecture

**Notes:**

**AP:** that is the wireless Access Point, the founder of a wireless network and the centre of the network nodes. The wireless router we use at home or in office may be an AP.

**STA:** short for Station, each terminal connects to a wireless network (such as laptops, PDA and other networking devices) can be called with a STA device.

#### 2.1.1. AP Application

Infrastructure: it's also called basic network. It built by AP and many STAs which join in. The characters of network of this type are that AP is the centre, and all communication between STAs is transmitted through the AP. The figure following shows such type of networking.

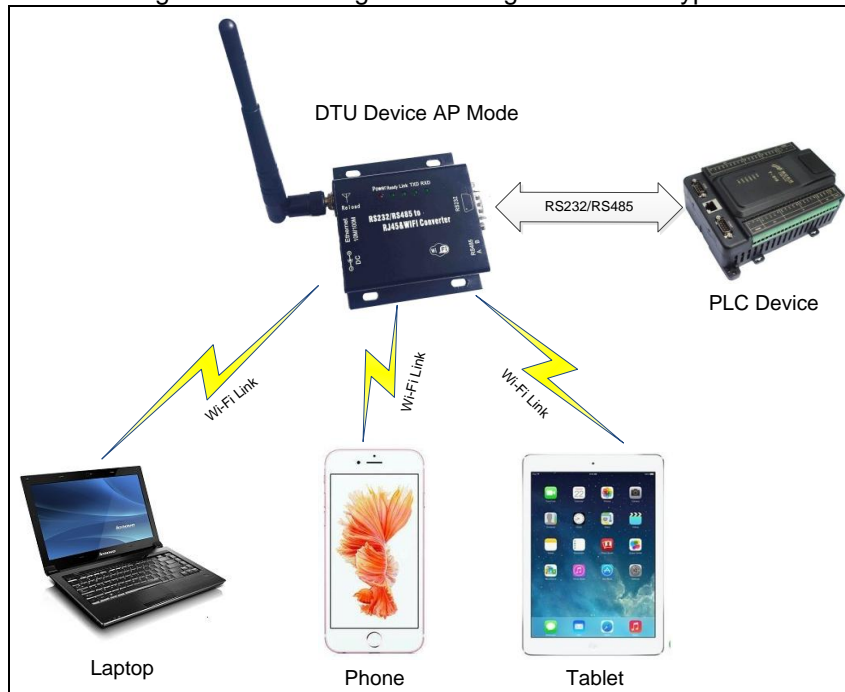

Figure 7. DTU AP Application



### 2.1.2. STA Application

As showing in the figure below, Router works as an AP, DTU and the laptop are STAs connected to AP. Meanwhile, DTU connected to user device via RS232/RS485 interface. in such AP network structure, the whole coverage of a wireless network can be extended easily.

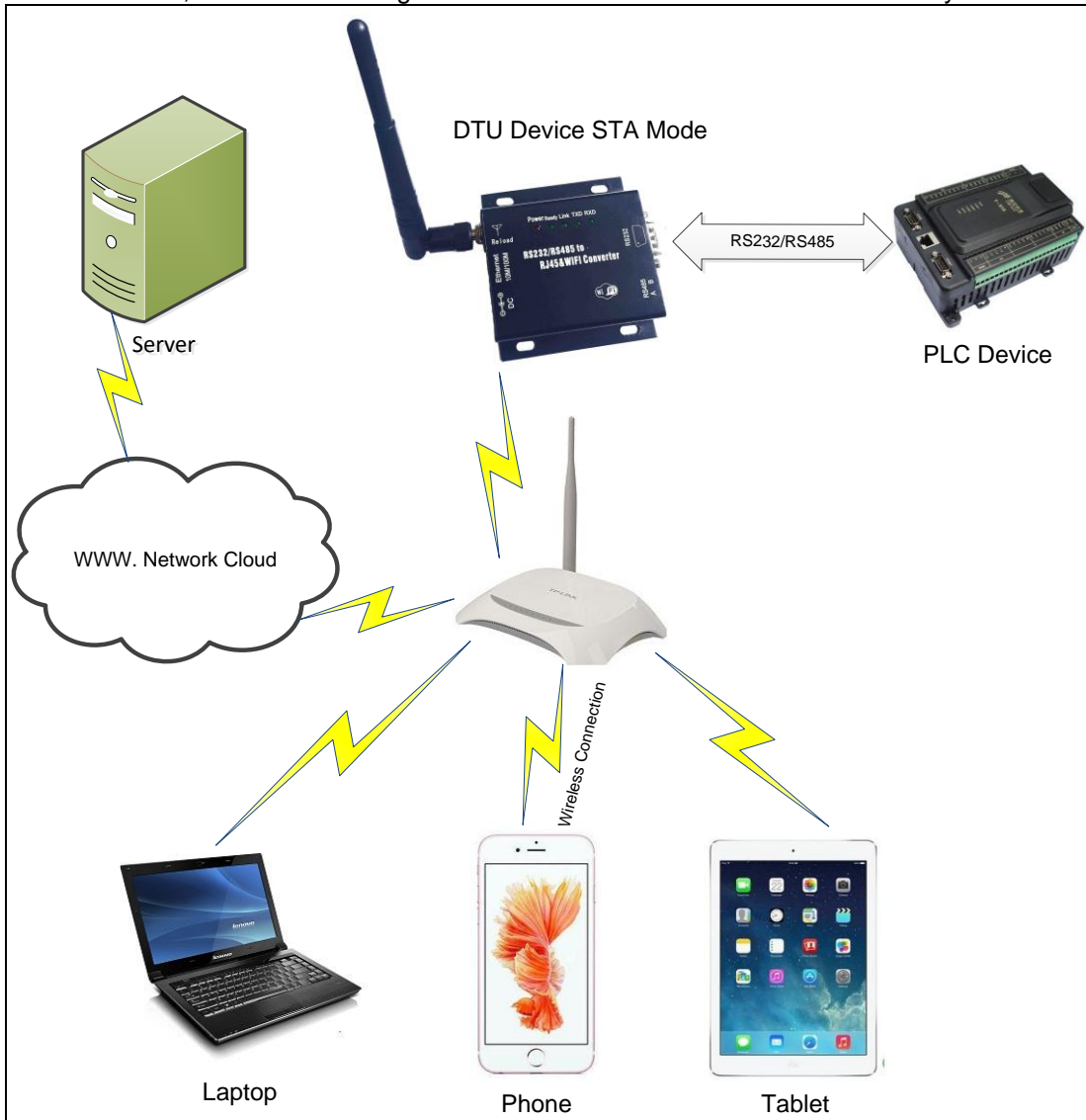

Figure 8. DTU STA Application

### 2.1.3. AP+STA Application

The DTU support AP+STA network mode, means device support one AP interface and one STA interface at the same time, as following figure.

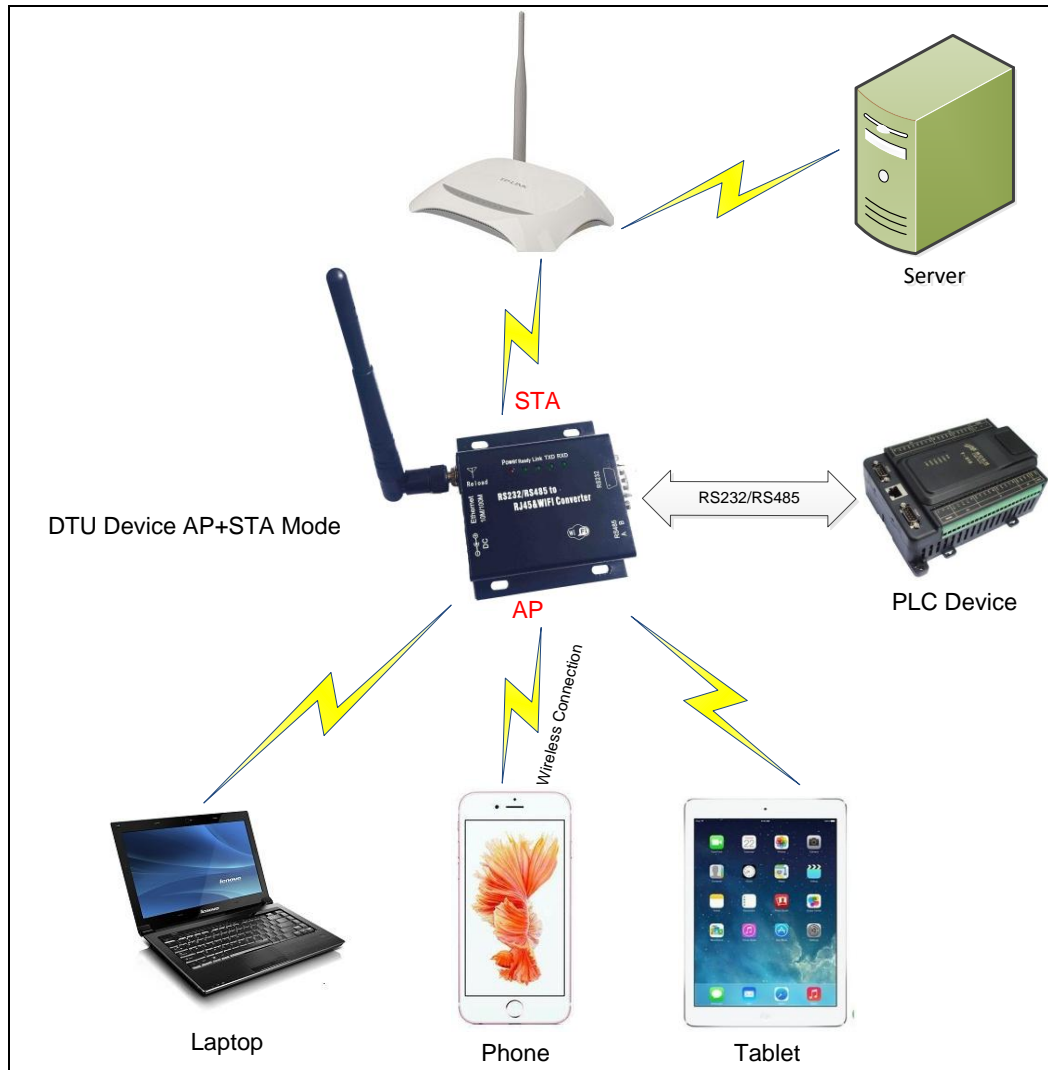

Figure 9. DTU AP+STA Application

When device enables AP+STA function, device's STA interface can connect with router and connect to TCP server in the network. At the same time, device's AP interface is also active and permit phone/PAD to connect, then phone/PAD can control user device and setting the device parameters,

The advantage of AP+STA mode is:

- Users can easily setting and track user device through Phone/PAD and not change the original network setting.
- Users can easily setting device's parameters through WiFi when device works as STA mode.

#### **AP+STA Mode Setting:**

AP+STA mode need serial AT command to enable as follows:

- **AT+FAPSTA=on**, Enable AP+STA mode;
- **AT+WMODE=STA**, when configure device works as STA mode, it's AP interface still active;

#### **AP+STA Mode Notes:**

When user enable AP+STA function, the STA port need to keep connected with other router (AP), or STA port will have to scan the AP frequently, which will affect AP port function and may cause some data loss.

#### 2.1.4. One AP One STA Application

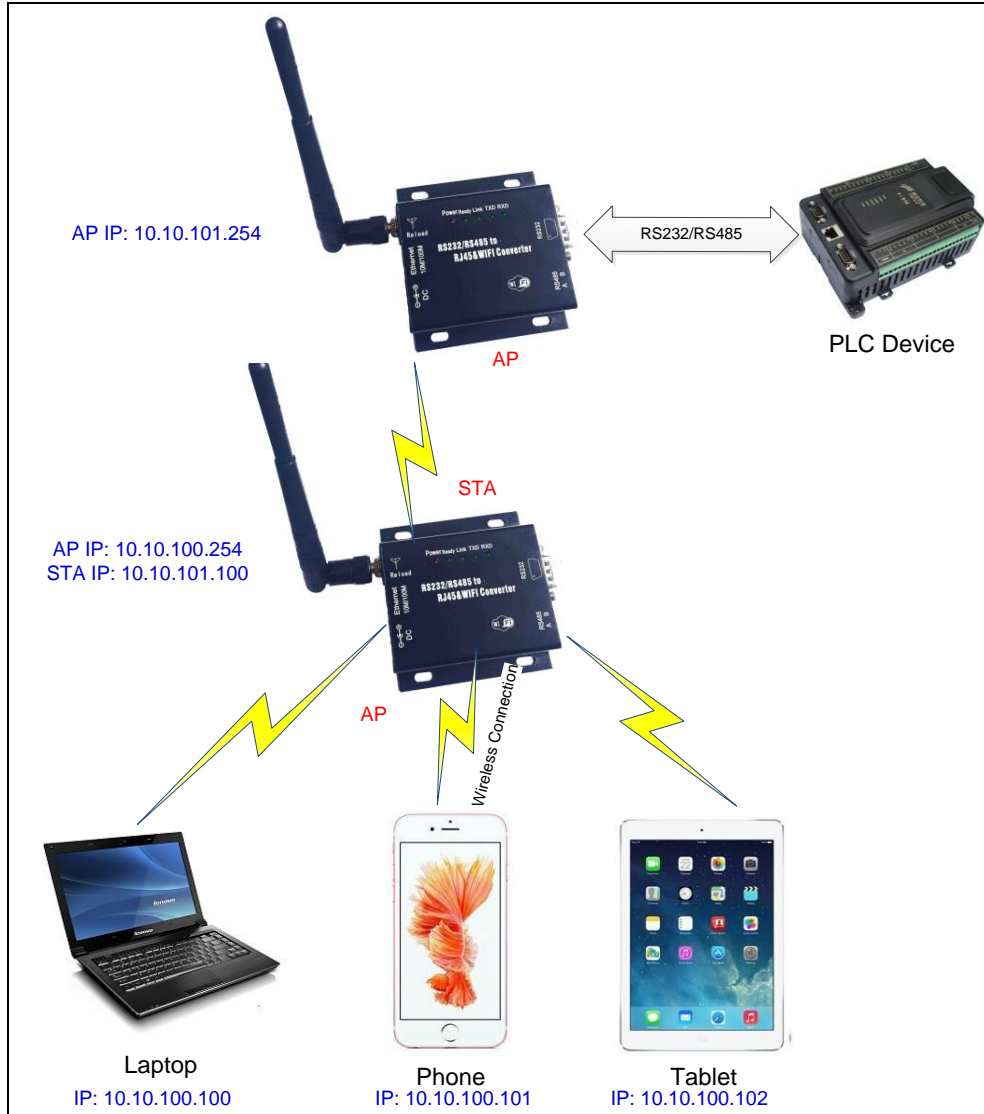

Figure 10. One AP and One STA Application

#### Notes:

The AP and STA part of device IP must be set in different subnetwork as the above picture.

## 2.2. Ethernet Interface Communication

Device provides one 10/100M Ethernet interface. With this Ethernet interface, user can easily realize the three interface (WiFi, RS232/RS485, and Ethernet) intercommunication and networking. Device can be configured as **Bridge Mode** or **Router Mode** based on different networking technology.

Notes: The Ethernet function is enabled by default. Users may input "AT+FEPHY=on/off" and

reset to enable/disable Ethernet. Device need different configuration to support different Ethernet Networking mode (Such as “N-Ver” and “Z-Ver” as following, which need AT+FVER=n to switch to N-Ver or AT+FVER=z to switch to Z-Ver).

**2.2.1. Ethernet Interface Networking (As AP, N-Ver)**

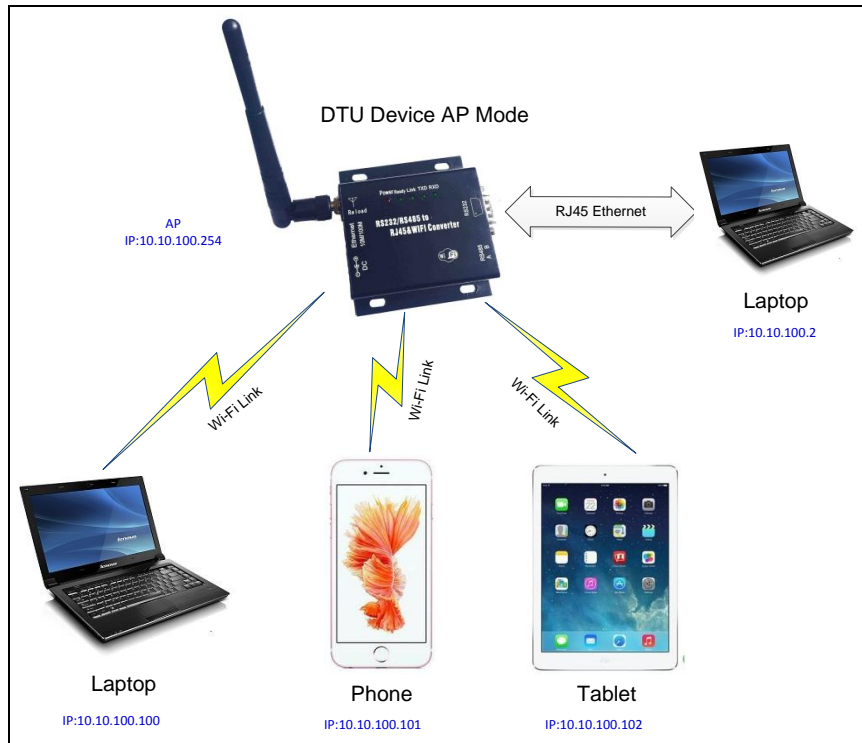

Figure 11. Ethernet Interface Networking (As AP)

For above networking, device works as AP and also the centre of this network. All devices’ IP address in this network shall use the same network segment with device and they can intercommunication with this method.

**2.2.2. Ethernet Interface Networking (As STA, N-Ver)**

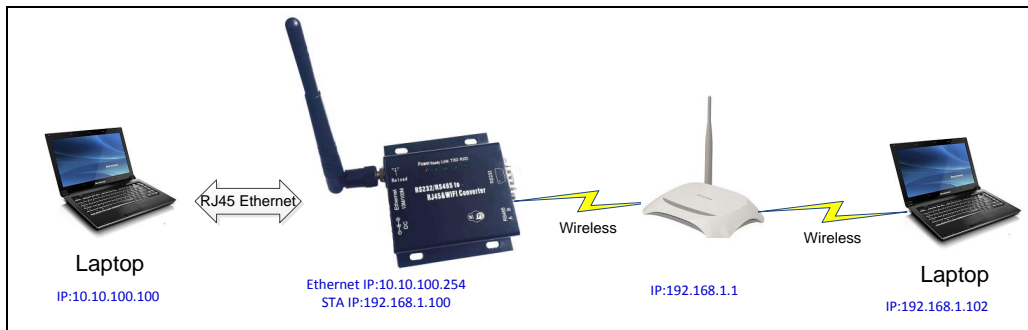

Figure 12. Ethernet Interface Networking (As STA, N-Ver)

For above networking, device works as STA (Firmware is N-Version), and device configured as router mode. When device connect to AP, it will get wireless port IP address from AP (For example: 192.168.1.100). At the same time, device also form a subnet (Default 10.10.100.254) and all devices connected to device Ethernet interface will get assigned IP address (For example:

10.10.100.100) .So for above networking, PC1(left laptop) at internal subnet can initiate a connection to PC2 , but PC2 can't active initiate a connection to PC1, they are in a different subnetwork.

### 2.2.3. Ethernet Interface Networking (As STA, Z-Ver)

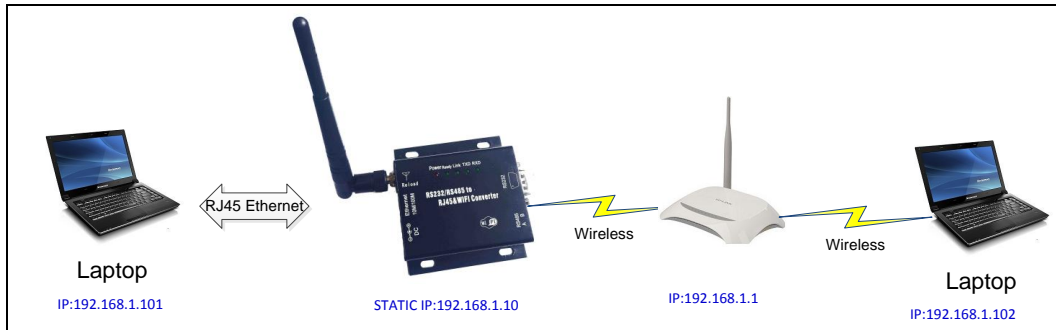

Figure 13. Ethernet Interface Networking (As STA, Z-Ver)

For above networking, device works as STA and device configured as bridge mode(AT+FVER=z). When device connect to AP, all devices connected to device Ethernet interface will get assigned IP address from AP (For example: 192.168.1.101).For device works as bridge mode, it can be treated as a transparent device and PC1, PC2 can communicate without any limit. But in this networking, device needs assign a static LAN IP address (For example: 192.168.1.10) if device also needs communication with AP or configuration through web page.

## 3. FUNCTION DESCRIPTION

### 3.1. User Configuration Process

When device power on, it will work as the previous setting parameter. If need to change the default working mode, need to configure the following example.

- **Wireless Network Parameters**
  - Wireless Network Name (SSID)
  - Security Mode
  - Encryption Key
  
- **TCP/UDP Linking Parameters**
  - Protocol Type
  - Link Type (Server or Client)
  - Target Port ID Number
  - Target Port IP Address
  
- **Serial Port Parameters**
  - Baud Rate
  - Data Bit
  - Parity (Check) Bit
  - Stop Bit
  - Hardware Flow Control
  
- **Work Mode Selection**
  - Transparent/Agreement/HTTPD Client mode(AT+TMODE to set)

The following introduce the work mode in detail.

### 3.2. Working Mode

#### 3.2.1. Transparent Transmission Mode

The device support serial interface transparent transmission mode. The benefit of this mode is to achieve a plug, play serial data port, and reduces user complexity. In this mode, user should only configure the necessary parameters. After power on, the device can automatically connect to the default wireless network and server. Use AT+NETP and AT+TCPB command to set the communication parameters.

As in this mode, the device 's serial port always work in the transparent transmission mode, so users only need to think of it as a virtual serial cable, send and receive data as using a simple serial. In other words, the serial cable of users'original serial devices are directly replaced by the DTU device, user devices can be easy for wireless data transmission without any changes.

The transparent transmission mode can fully compatible with user's original software platform and reduce the software development effort for integrate wireless data transmission.

**Notes:** Users may also enable the serial port hardware flow control(CTS/RTS) function, so that we can make the bit error rate to a minimum. If the user doesn't need hardware flow control function of the serial port, only need to make the CTS/RTS unconnected.

### 3.2.2. Agreement(Serial Command Mode)

In this mode, the user can send the serial data to a different server address, this mode can use UDP or TCP client to send data to server.

Customer MCU send packets according to the following format. The device will parse the received serial data and send only the data to their destination address. When data is received from server, the device will output it directly.

Table 7 Serial Command Mode

	Frame Header	Length	Function Byte	Backup Data Area	Destination Port	Target Address	Data	Check Sum
Bytes	2	2(5+m+n)	1	2	2	m	n	1

#### **Frame Header:**

0x55 0xAA (Constant value)

#### **Length:**

Start from the function byte to check sum(does not contain the check sum). High byte first.

Function Byte:

**Bit0:** (0-UDP, 1-TCP),

**Bit1:** (0-Short Connection, 1-Long Connection), if it is a short connection, it sends data, and then disconnected; if it is a long connection, it sends data and keep the connection until receive new data to change the target address. Valid only in TCP communication.

**Bit2:** (0-IP, 1-Domain Name), Indicate that the target address is IP or domain name. If it is IP, the target address is 4 bytes. If it is domain name, the target address length includes the entire domain name string length(the last byte address is '\0', the end of the string).

#### **Backup Data Area:**

**Byte 1:** If it is a short connection, this position is TCP waits for the timeout time (1-255), if the device do not receive a response data after the data has been sent, then it wait a few seconds and the close the connection, e.g this byte is set as 5, then the device will wait from 5 seconds to receive data. If it receive data, then the connection is closed right away. If it is a long connection, this byte should be 0.

**Byte 2:** Reserved.

#### **Destination Port:**

Little endian, low byte first, e.g the destination port is 23, then the data flow should be 【0x17 0x00】

#### **Target Address:**

If it is IP, it is 4 bytes, e.g 【192.168.0.7】 should be 【0x07 0x00 0xA8 0xC0】. If it is a domain, then the address length should include the ending character '\0'.

**Data:**

Sent data, the maximum length is 1000 bytes.

**Summary:**

The following example for reference.

UART Data: **【0x55 0xaa 0x00 0x0a 0x00 0x00 0x00 0x21 0x00 0x85 0x00 0xA8 0xC0 0x01 0x0f】**

Length: **【0x00 0x0a】**

Function Byte: **【0x00 (UDP;Short connection;IP;cut protocol)】**

Destination Port: **【0x21 0x00(33)】**

Target Address: **【0x85 0x00 0xA8 0xC0 (192.168.0.133)】**

Data: **【0x01(data:1)】**

Sum Check: **【0x0f (0x00+0x00+0x00+0x21+0x00+0x85+0x00+0xA8+0xC0+0x01=0x0f)】**

**3.2.3. HTTPD Client Mode**

This mode is used to send data to HTTP server. It can be set by AT command or Webpage(Note that AT+NETP and AT+TCPB channel is no long valid in this mode), it is long connection by default.

The following shows example to use this.

Step 1: Set HTTP Command

AT+TMODE=Httpdclient

AT+HTPMODE=new

AT+HTPSV=10.10.100.200,80

AT+HTPTP=GET

AT+HTPURL=/abcd

AT+HTPHEAD=Content-type:text/html;charset=utf-8

AT+Z

Step 2: send abcd data and the device will send the following GET request to the HTTP server.

`GET /abcdabcd HTTP/1.1`

`Content-type:text/html;charset=utf-8`



### 3.3. Wi-Fi Parameter Setting

#### 3.3.1. Auto- Frequency Function

When device works as STA, it will adjust its wireless channel to keep the same channel with associated AP and connect in.

When device works as AP and enable Auto-frequency function, then when device boot up, it will select the best wireless channel based on surrounding environment.

#### 3.3.2. Security

The device supports multiple wireless encryption mechanisms, and enables to protect the security of user's data transmission, the mechanisms include:

- ◆ WEP
- ◆ WPA-PSK/TKIP
- ◆ WPA-PSK/AES
- ◆ WPA2-PSK/TKIP
- ◆ WPA2-PSK/AES

#### 3.3.3. Search Function for STA

When using web configuration of STA interface Setting Page, user can click "Search" button to find the surrounding AP, and select a AP to connect.

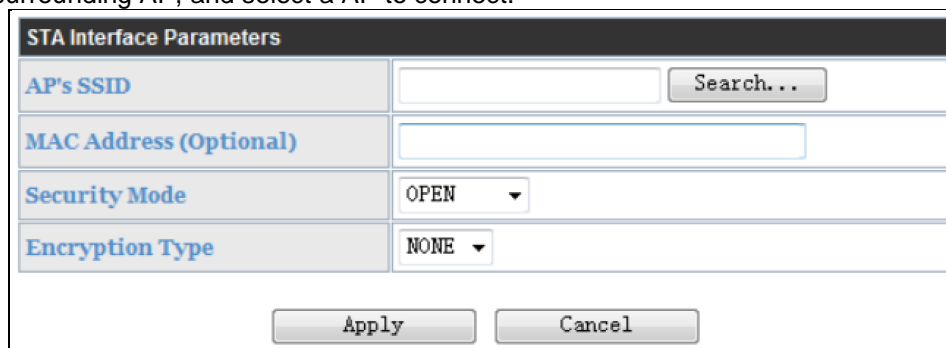

STA Interface Parameters	
AP's SSID	<input type="text"/> Search...
MAC Address (Optional)	<input type="text"/>
Security Mode	OPEN ▾
Encryption Type	NONE ▾
<input type="button" value="Apply"/> <input type="button" value="Cancel"/>	

Figure 14. Search Page

#### 3.3.4. Address Binding

The device supports the feature of binding the BSSID address of target network.

According to the provisions of 802.11 protocol, different wireless networks can have a same network name (i.e. SSID / ESSID), but must correspond to a unique BSSID address (i.e. MAC address). Illegal intruders can create a wireless network with the same SSID / ESSID, it will make STAs in the network to join to the illegal AP, thereby and then network leakage happen.

Users can prevent STA from joining to illegal network by binding the BSSID address, to improve wireless network security.

### 3.4. UART Frame Scheme

#### 3.4.1. UART Free-Frame

The device support UART free-frame function. If user select open this function, device will check the intervals between any two bytes when reciving UART data. If this interval time exceeds

defined value (50ms default), The device will think it as the end of one frame and transfer this free-frame to WiFi port, or The device will receive UART data until 4K bytes, then transfer 4KB frame to WiFi port.

The device's default interval time is 50ms. User can also set this interval to fast (10ms) through AT command. But user have to consider if user MCU can send UART data with 10ms interval ,or the UART data may be divide as fragment.

Through AT command: AT+FUARTTE=fash/normal, user can set the interval time: fast (10ms) and normal (50ms). This command is factory default setting command and AT+RELD can't change its value.

### 3.4.2. UART Auto-Frame

The device support UART auto-frame function. If user select open this function and setting auto-frame trigger length and auto-frame trigger time parameters, then device will auto framing the data which received from UART port and transmitting to the network as pre-defined data structure.

- **Auto-frame trigger length:** The fixed data length that device used to transmitting to the network.
- **Auto-frame trigger time:** After the trigger time, if UART port received data can't reach auto-frame trigger length, then device will transmitting available data to the network and bypass the auto-frame trigger length condition.

Detailed UART auto-frame function can refer to AT+ instruction set "UARTF/UARTFT/UARTFL" introduction.

## 3.5. Network Setting

The device supports TCP/UDP network protocol and the port parameters can be set via web accessing or AT+instruction set. It has two TCP/UDP Socket: Socket A and Socket B. Serial data sent to the device, it will be sent to the both Socket A and B simultaneously; TCP/UDP data that it receives from either Socket A or B, the data will be sent to the serial port. You can achieve a variety of network communication for setting the dual socket.

### 3.5.1. Socket A

Socket A has three work mode: TCP Server, TCP Client and UDP. Please refer to the AT+NETP command instruction for detailed setting. When Socket A configured as TCP Server, it supports Multi-TCP link connection, and maximum 32 TCP clients are permitted to connect to Socket A. Multi-TCP link connection will work as following structure:

Upwards data stream: All data from different TCP connection or client will be transmitted to the serial port as a sequence.

Downwards data stream: All data from serial port (user) will be duplicate and broadcast to every TCP client.

Detailed multi-TCP link data transmission structure as following figure:

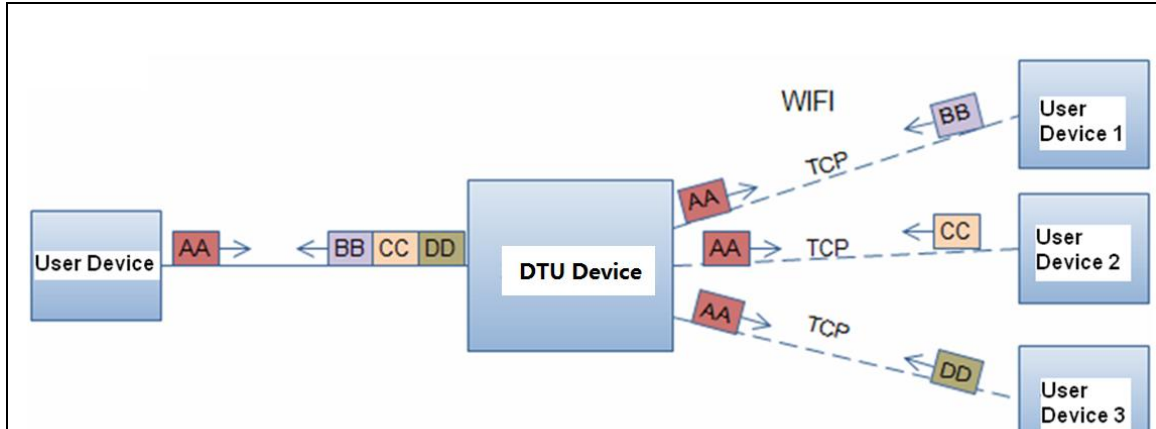

Figure 15. Multi-TCP Link Data Transmission Structure

### 3.5.2. Socket B

Socket B has one work mode: TCP Client, please refer to the AT + TCPB command instruction.

- AT+TCPB=on, Enable TCPB function;
- AT+TCPPTB=<port>, Set TCPB port number;
- AT+TCPADDB=<IP or domain>, Set TCPB's server address;
- AT+TCPTOB=<time>, Set TCPB timeout;
- AT+TCPLKB, Query TCPB link status;

With variety work mode, socket B can provide users with flexible data transfer methods. For example, SocketB can connect to a remote server in order to achieve remote control.

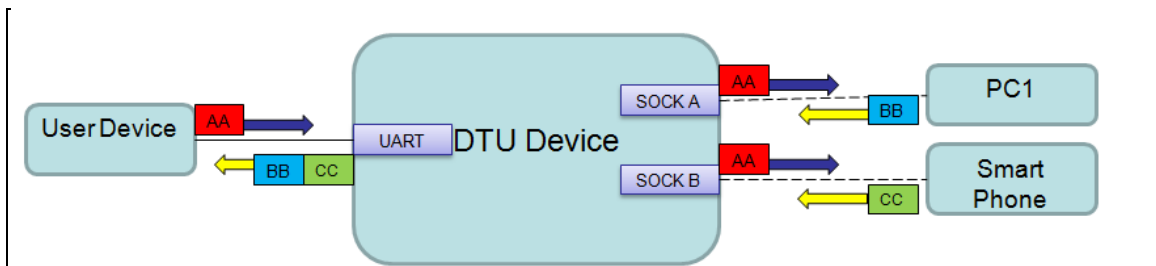

Figure 16. Dual Socket Working Data Flow

## 3.6. TCP Password Authentication

This feature is available only on Socket A TCP server mode, when the TCP client connection to the device, it will authenticate each connected tcp.

Each TCP client first data should be the "password+0x0d+0x0a" (the password is Webpage authentication password).

The default password is "admin", so the first piece of data should be "0x61 0x64 0x6D 0x69 0x6E 0x0D 0x0A"(Hex). If the password is correct, the Convert Server returns "OK", on the other hand, return to the "NO" and disconnect.

The TCP connection of this function can be Webpage in TCP connection password authentication is opened or disable. Please refer to the specific webpage section.

### 3.7. Upload ID

This function only applies to the the device as a TCP client (Socket A or Socket B), in front of the data when the device connected to the server, it will add with two bytes of ID (ID the range is 0 ~ 65535, the high byte first, and the low byte behind) plus two bytes ID radix-minus-one complement, e.g the default ID is 1111, then the "0x57 0x04 0xfb 0xa8" will be sent to the server.

There are two ways to upload their own id: one is to upload their own id for connection to the server for the first time;The other is a plus id in front of each data. ID number related parameter is set in the "serial port and other Settings" section of the web, build joint function of ID for the first time, and each data with the function of ID are opened by default.

May also use the AT command to set the related parameters. Refer to AT+REGXX command for detail.

### 3.8. Keepalive(Reserved)

When the TCP connection becomes abnormal between DTU device and server, the device will detect this abnormal status and reconnect to server if it works in TCP client. When it works in TCP server, it will release the TCP resources for next conection.

### 3.9. Multiple STA Parameters

When device is in the STA mode, if it loose network signal when the signal is too low, it will automatically switch to the other AP network (switching network automatically restart).

This function is disabled by default.

### 3.10. Websocket(Reserved)

Contact us for detailed application.

### 3.11. Parameters Setting

device supports two methods to configuration parameters: Web Accessing and AT+instruction set.

Web accessing means users can configure parameters through Web browser. When device connected to wireless network, parameters configuration can be done on a PC connected to the same wireless network. AT+instruction set configuration means user configure parameters through serial interface command. Refer to "AT+instruction set" chapter for more detail.

#### **Notes:**

We can customized the parameters setting as customer request and ship devices with these parameters as factory default configuration. It will reduce user's device configuration time for mass production. Also, if user need different parameters setting for every device, we can provide the **auto-configuration tool** to speed up the device conguration duration. Please contact our technical interface to acquire this tool if required.

### 3.12. Palmodic Signal

Base on selected factory default setting, nReady signal can have two output statuses:

- Status One: The device will output "0" after normal boot up. This signal used to judge if device finish boot up and ready for application.

- Status Two: The device will output "Palmodic Signal" after normal boot up. The palmodic signal is 0.5Hz square wave with dutyfactor 1:1. User can query this signal to judge if device is active "live" or need to re-boot. When device switches to command mode, it will output "0", which used to distinguish work mode and command mode.

**Notes:**

This function is user selected factory setting and RELD instruction will not effective for this function. If user not requires this function, the default factory setting is Status One. Contact us for more detailed support

**3.13. Firmware Upgrade**

device supports firmware upgrade online; User can upgrade firmware via web access.

## 4. OPERATION GUIDELINE

### 4.1. Configuration via Web Accessing

When first use device, user may need some configuration. User can connect to device's wireless interface with following default setting information and configure the device through laptop.

Table 5 The device Web Access Default Setting

Parameters	Default Setting
SSID	DTU-H100_XXXX
IP Address	10.10.100.254
Subnet Mask	255.255.255.0
User Name	admin
Password	admin

#### 4.1.1. Open Web Management Interface

Step 1: Connect laptop to SSID "DTU-H100\_XXXX" of the device via wireless LAN card;  
 Step 2: After wireless connection OK. Open Wen browser and access "<http://10.10.100.254>";  
 Step 3: Then input user name and password in the page as following and click "OK" button.



Figure 17. Open Web Management page

The The device web management page support English and Chinese language. User can select language environment at the top right corner and click "Apply" button.

The main menu include nine pages: "Quick Configure", "Mode Selection", "AP Interface Setting", "STA Interface Setting", "Application Setting", and so on.

#### 4.1.2. Quick Configure

This page provides users with a method of rapid configuration of device. Users according to the steps to configure the parameters and restart the device, you can let the device work rapidly, reduced the configuration steps and time. It still need to the corresponding configuration page if need to set some detailed parameters.

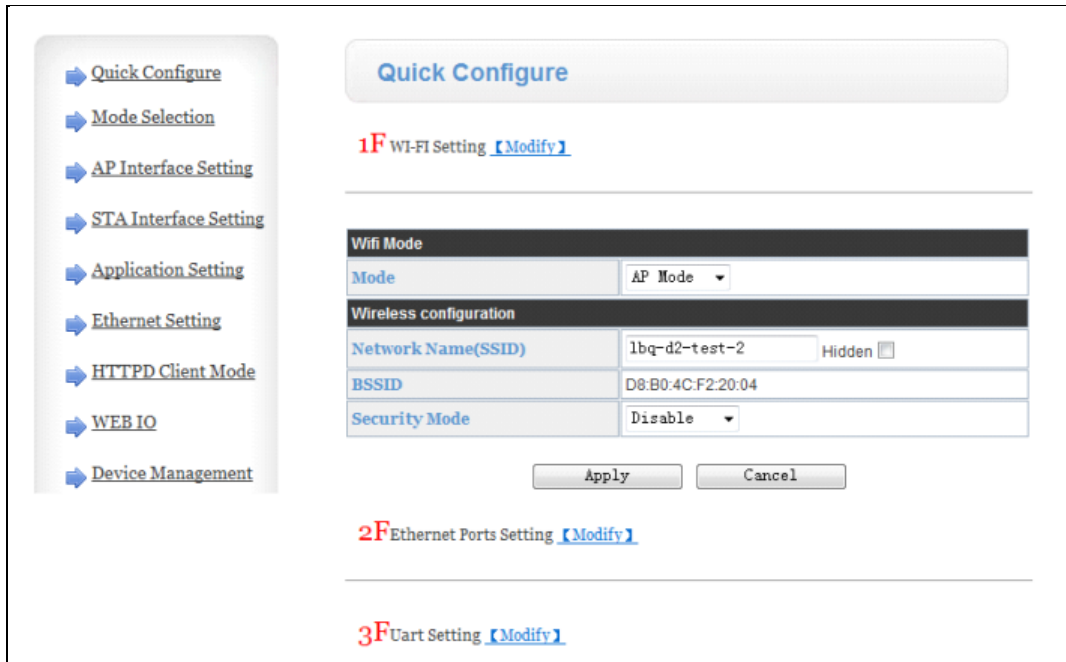

Figure 18. Quick Configure Page

This page has four configuration options and a restart, the corresponding instructions below:

- ◆ WI-FI Setting: set the working mode of wifi, AP mode or the STA.
- ◆ Ethernet Ports Setting: open/close the Ethernet ports, and set up the corresponding work mode.
- ◆ UART Setting: set serial port parameters, including baud rate, parity bit, 485 functions and so on.
- ◆ Network Setting: set network parameters, Only Socket A related parameters.
- ◆ Device Management: when after completion of the above parameters are configured, click reset.

#### 4.1.3. Mode Selection Page

This page use to setting the device working mode (Transparent Transmission or HTTPD Client mode and so on) and wireless networking mode (AP and STA mode).

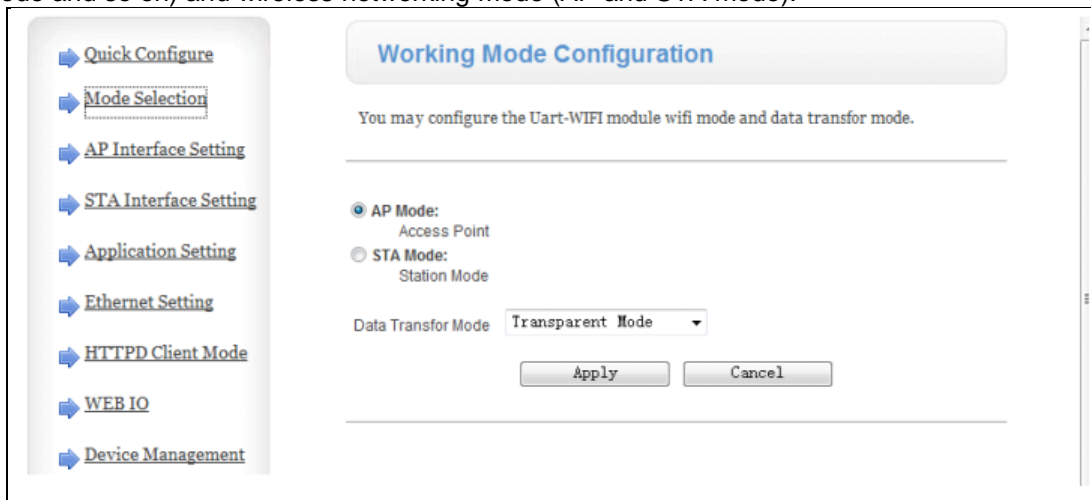
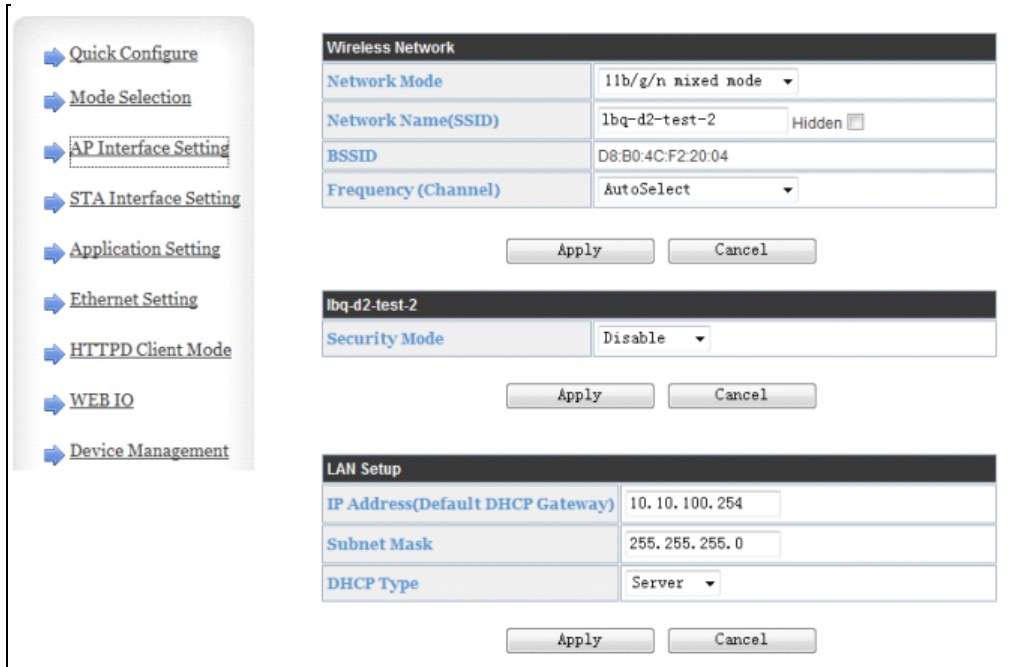

Figure 19. Mode Selection Page

#### 4.1.4. AP Interface Setting Page

This page use to setting the parameters when device works as AP.



Wireless Network	
Network Mode	11b/g/n mixed mode
Network Name(SSID)	lbq-d2-test-2 <input type="checkbox"/> Hidden
BSSID	D8:B0:4C:F2:20:04
Frequency (Channel)	AutoSelect
<input type="button" value="Apply"/> <input type="button" value="Cancel"/>	

lbq-d2-test-2	
Security Mode	Disable
<input type="button" value="Apply"/> <input type="button" value="Cancel"/>	

LAN Setup	
IP Address(Default DHCP Gateway)	10.10.100.254
Subnet Mask	255.255.255.0
DHCP Type	Server
<input type="button" value="Apply"/> <input type="button" value="Cancel"/>	

Figure 20. AP Interface Setting Page

#### 4.1.5. STA Interface Setting Page

This page use to setting the parameters when device works as STA.

Such as SSID of AP which device need to connected, and also select the networking type: DHCP or static IP address.

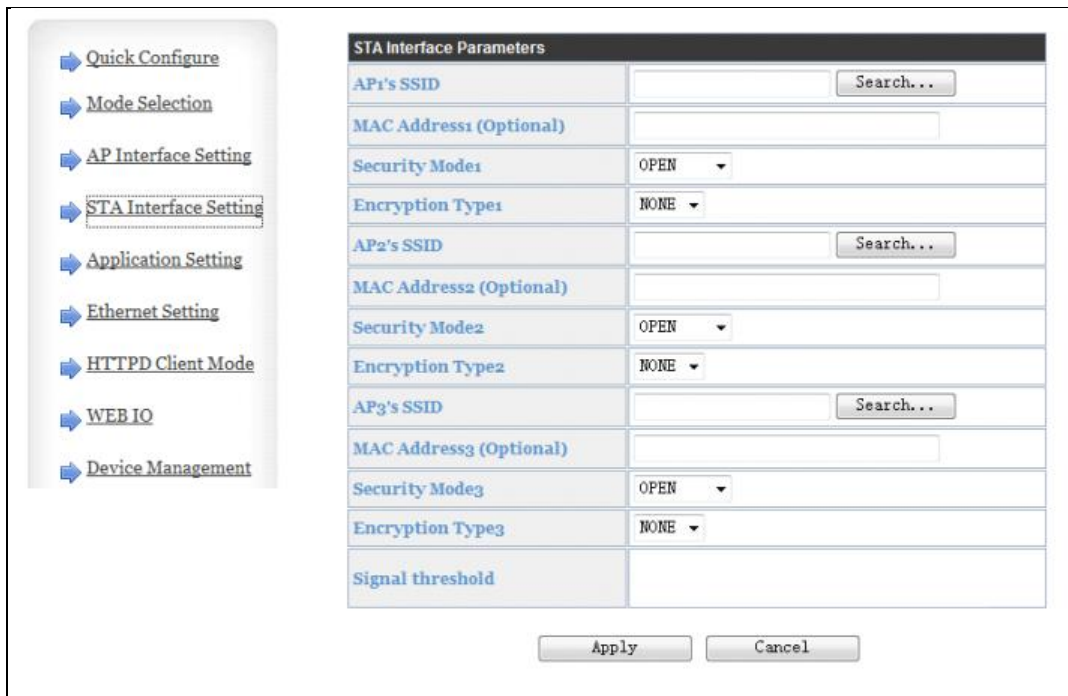

STA Interface Parameters	
AP1's SSID	<input type="text"/> Search...
MAC Address1 (Optional)	<input type="text"/>
Security Mode1	OPEN
Encryption Type1	NONE
AP2's SSID	<input type="text"/> Search...
MAC Address2 (Optional)	<input type="text"/>
Security Mode2	OPEN
Encryption Type2	NONE
AP3's SSID	<input type="text"/> Search...
MAC Address3 (Optional)	<input type="text"/>
Security Mode3	OPEN
Encryption Type3	NONE
Signal threshold	<input type="text"/>
<input type="button" value="Apply"/> <input type="button" value="Cancel"/>	



Figure 21. STA Interface Setting Page

#### 4.1.6. Application Setting Page

This page use to setting the parameters of serial port communication, such as UART setting and high layer network protocol setting which used support serial communication.

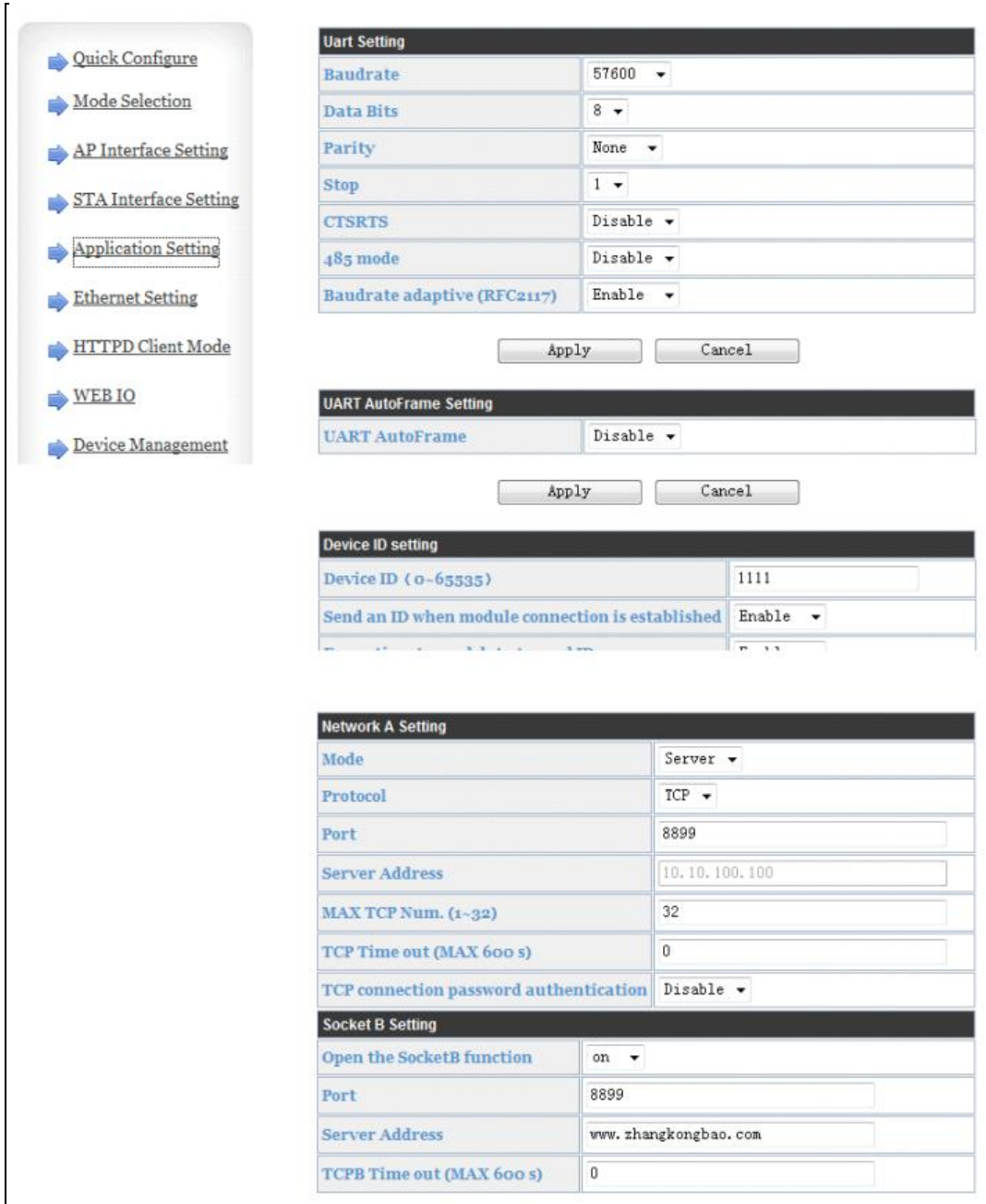

The screenshot displays the 'Application Setting' page with a sidebar menu on the left containing options like Quick Configure, Mode Selection, AP Interface Setting, STA Interface Setting, Application Setting (highlighted), Ethernet Setting, HTTPD Client Mode, WEB IO, and Device Management.

**Uart Setting**

Baudrate	57600
Data Bits	8
Parity	None
Stop	1
CTSRTS	Disable
485 mode	Disable
Baudrate adaptive (RFC2117)	Enable

Buttons: Apply, Cancel

**UART AutoFrame Setting**

UART AutoFrame	Disable
----------------	---------

Buttons: Apply, Cancel

**Device ID setting**

Device ID (0-65535)	1111
Send an ID when module connection is established	Enable

**Network A Setting**

Mode	Server
Protocol	TCP
Port	8899
Server Address	10.10.100.100
MAX TCP Num. (1-32)	32
TCP Time out (MAX 600 s)	0
TCP connection password authentication	Disable

**Socket B Setting**

Open the SocketB function	on
Port	8899
Server Address	www.zhangkongbao.com
TCPB Time out (MAX 600 s)	0

Figure 22. Application Setting Page

#### Notes:

Generally, Network protocols support three modes: **TCP Server**, **TCP Client**, **UDP Server** and **UDP Client**. UDP has no server and client requirement according to standard. But we do special

function for UDP Server mode, If set as UDP Server, the device will save the IP address and port of the latest UDP packet received. The data will be sent to the saved IP address and port. If the device hasn't saved any IP address and port when power up. The data will be sent to the IP address and port which is set by this command.

Besides device working as TCP Server (IP address not required in this mode). User must set the IP address of the device which need communicate with device.

Also the Port ID between two sides of the communication devices must keep the same.

#### 4.1.7. Ethernet Setting

This page is used to set the Ethernet Port function. If need to connect to router by Ethernet, it should be set as WANN Port, if need to connect to PC, it should be set as LAN Port.

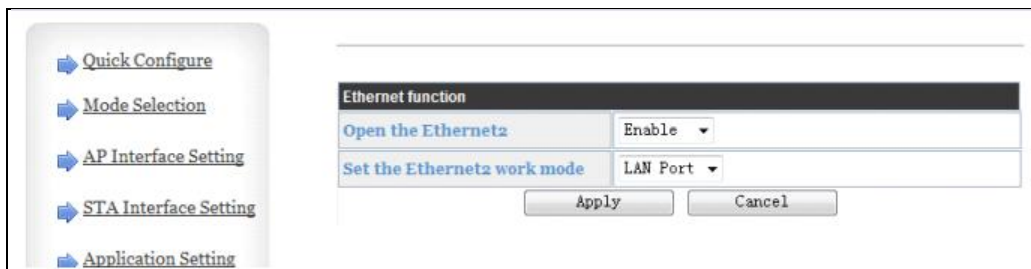

Ethernet function	
Open the Ethernetz	Enable
Set the Ethernetz work mode	LAN Port

Figure 23. Ethernet Setting Page

#### 4.1.8. HTTPD Client Mode

This page sets the HTTP header in the HTTPD Client mode. This page will be updated later.

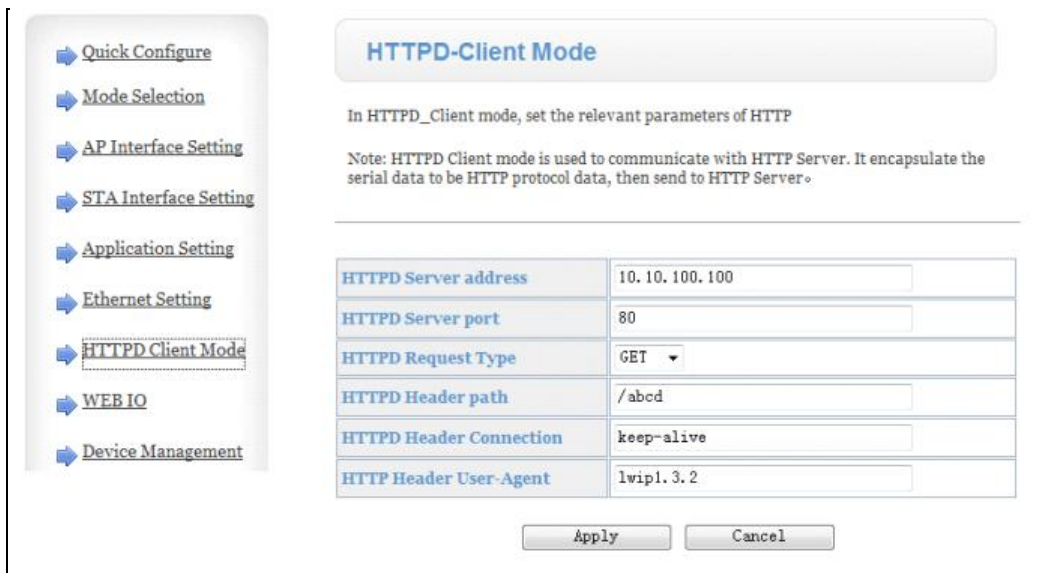

HTTPD Server address	10.10.100.100
HTTPD Server port	80
HTTPD Request Type	GET
HTTPD Header path	/abcd
HTTPD Header Connection	keep-alive
HTTP Header User-Agent	lwip1.3.2

Figure 24. HTTPD Client Mode Page

#### 4.1.9. Device Management Page

This page use to manage device general setting, such as administrator setting, restart device button, restore factory default setting button, and update firmware through webpage.



Figure 25. Device Management Page



**Notes:**

Restart device button: When you setting the parameters of different web pages, you will click "Apply" button to confirm the setting, but the setting take effect only after user click the "Restart" button here, the device will re-boot up and reflash the memory information with new changes. **WEB IO and Advances page function is reserved.**

## 4.2. The device Usage Introduction

### 4.2.1. Software Debug Tools

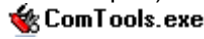
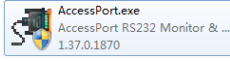
Recommend to use two common software tools debugging and applying device. (User can also select other tools used to debug serial and Ethernet port).

- Serial Debugging Software: ComTools 
- Serial Debugging Software: Accessport 
- Ethernet Debugging Software: TCPUDPDbg 

### 4.2.2. Network Connection

User can select two methods to connect device base on dedicated application.

#### ➤ Use The device STA interface

The device and debug PC2 connect to a wireless AP, another PC1 (or user device) connect to device with serial port:

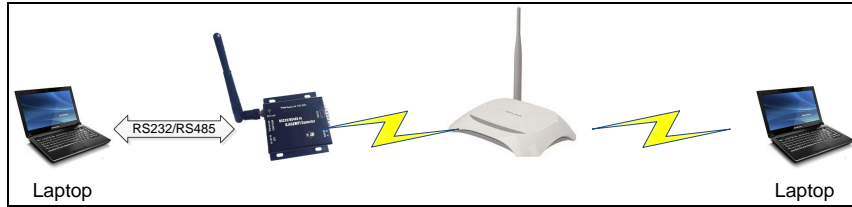

Figure 26. STA Interface Debug Connection

➤ **Use The device AP interface**

Debug PC2 connect to The device through wireless connection, another PC1 (or user device) connect to device with serial port.

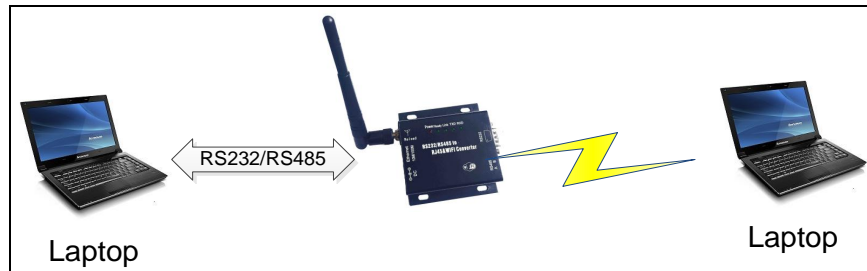

Figure 27. AP Interface Debug Connection

**4.2.3. Device Debug**

PC1 open “CommTools” program, setting the same serial port parameters with device and open serial port connection.

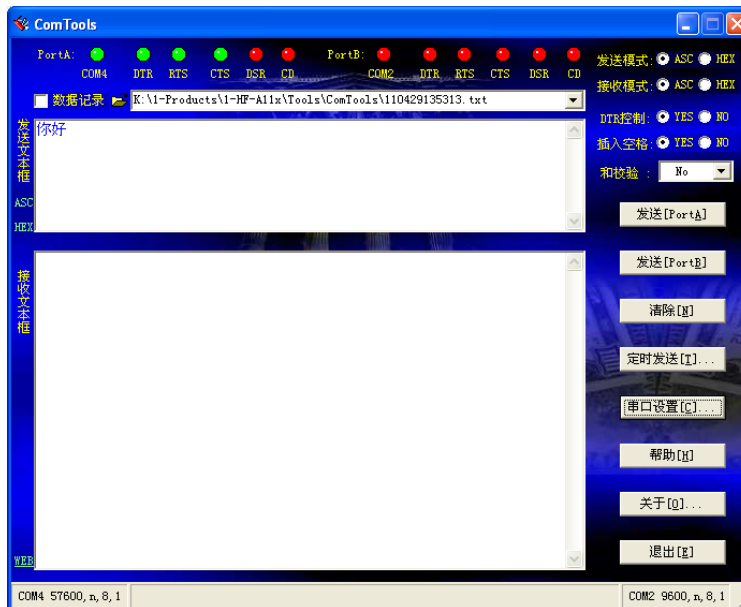

Figure 28. “CommTools” Serial Debug Tools

PC2 open “TCPUDPDbg” program, and create a new connection. If The device configured as Server mode, “TCPUDPDbg” Tools shall create “Client” mode connection. Or otherwise, create a “Server” mode connection.

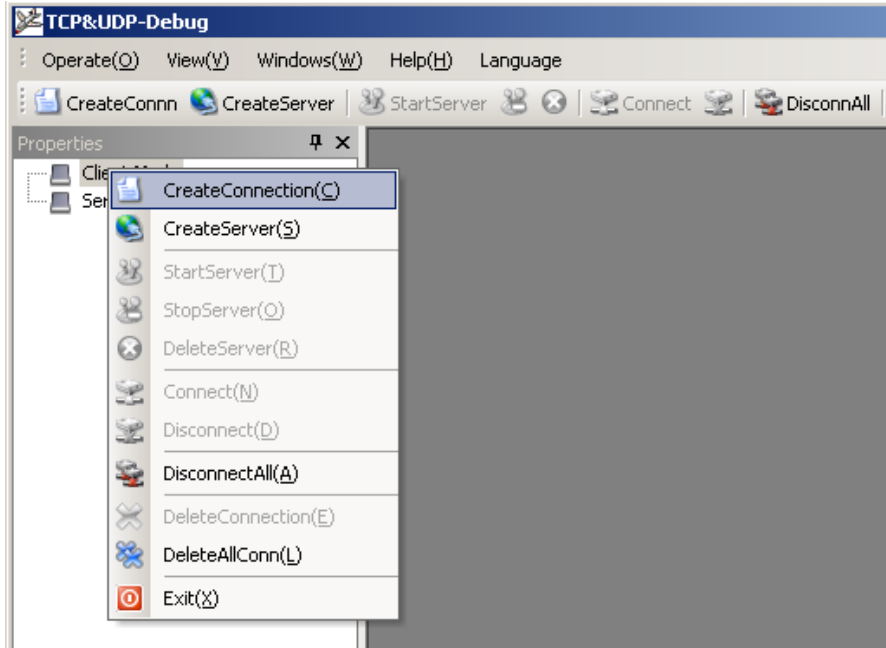

Figure 29. "TCPUDPDbg" Tools Create Connection

Then setting the TCP/UDP connection parameters. Default as following:

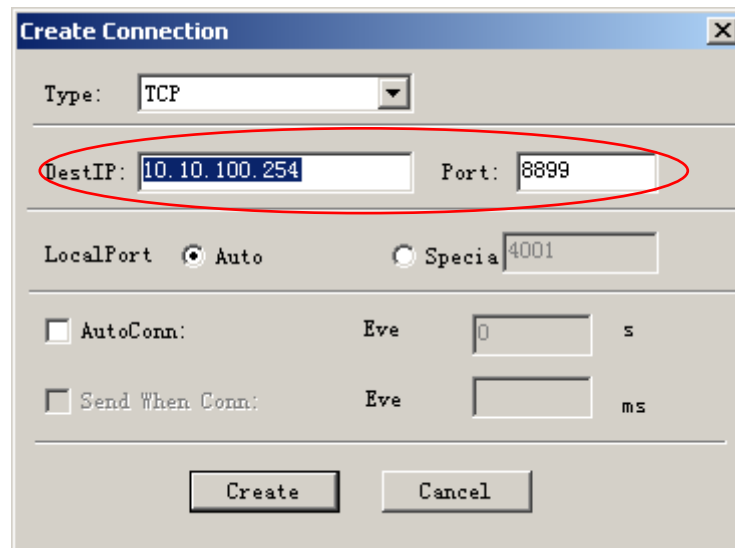

Figure 30. "TCPUDPDbg" Tools Setting

Then, click "Create" button to create a connection.

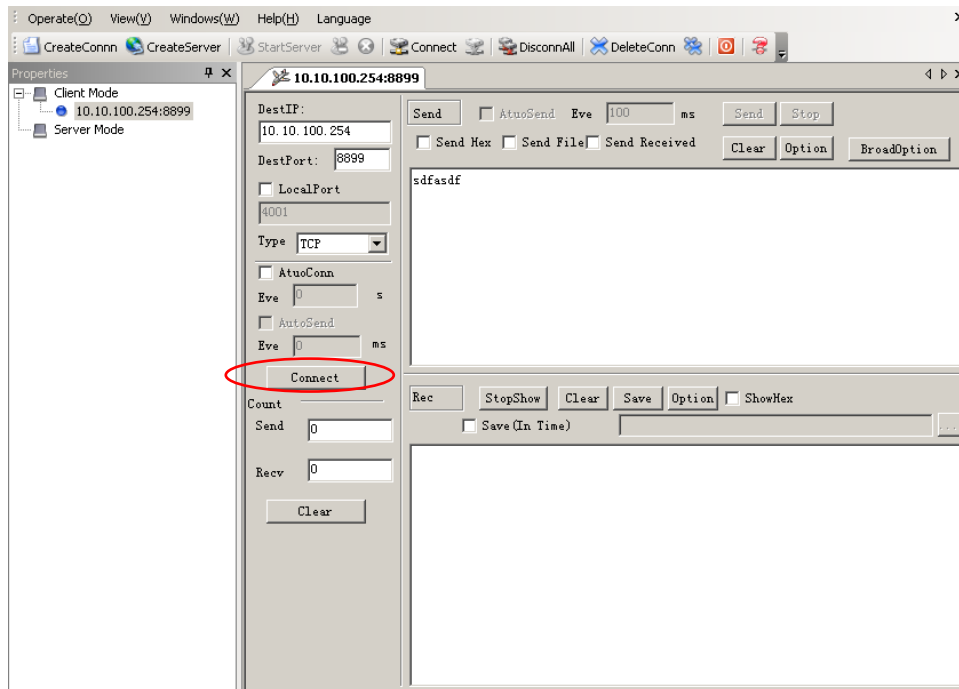

Figure 31. "TCPUDPDbg" Tools Connection

Now, in transparent transmission mode (The device default setting), data can be transferred from "CommTools" program to "TCPUDPDbg" program, or in reverse. You can see data in receiver side will keep same as in sender side.

### 4.3. Typical Application Examples

#### 4.3.1. Wireless Control Application

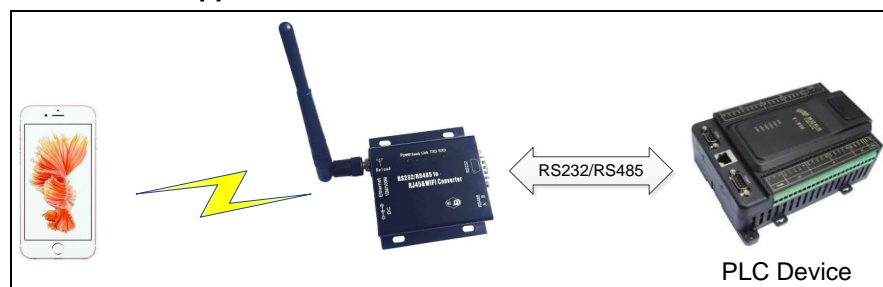

Figure 32. Wireless Control Application

For this wireless control application, The device works as AP mode. Device's serial port connects to user device. So, control agent (Smart phone for this example) can manage and control the user device through the wireless connection with device.

### 4.3.2. Remote Management Application

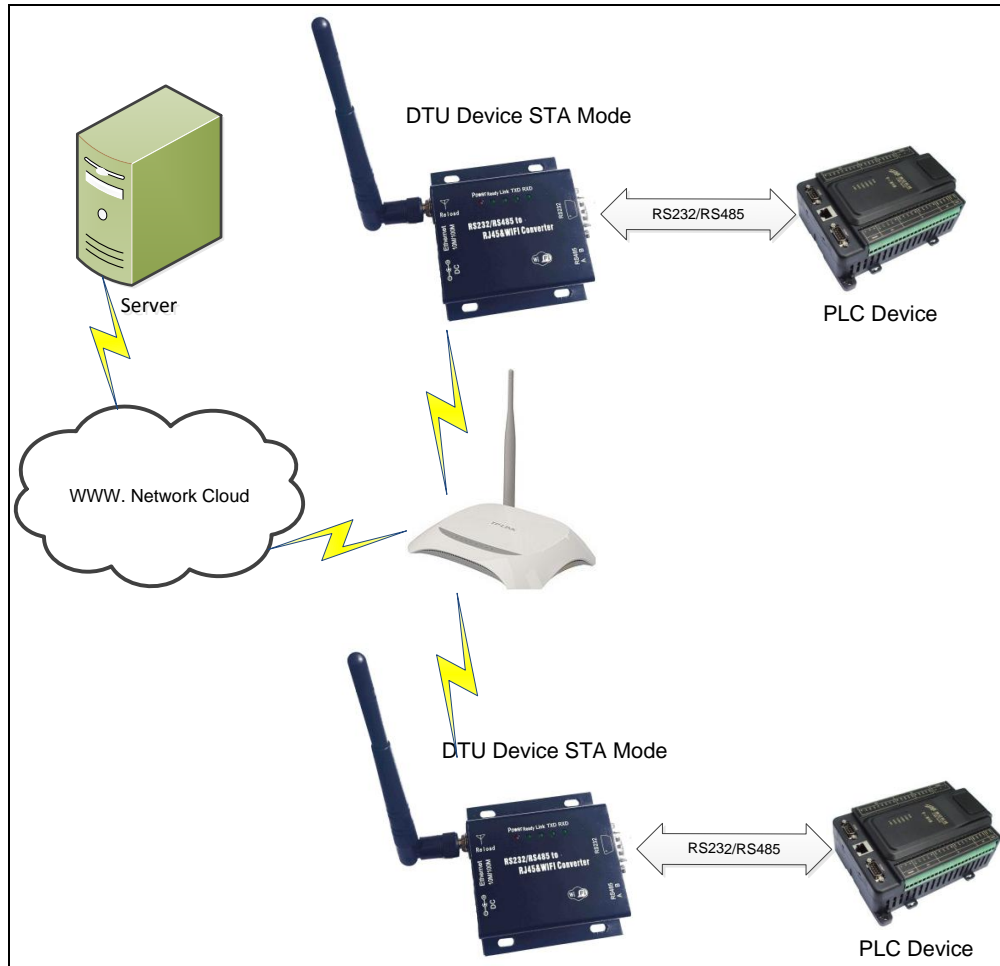

Figure 33. Remote Management Application

For this remote management application, The device works as STA mode and connects to Internet through wireless AP. Device configured as TCP Client and communicates with remote TCP server at Internet. Device's serial port connects to user device.

So, user device's data or sampling information can send to remote TCP server for storage or processing. Also remote TCP server can send command to control and manage the user device through the wireless network.

### 4.3.3. Transparent Serial Port Application

For this transparent serial port application, two device connect as below figures to build up a transparent serial port connection.

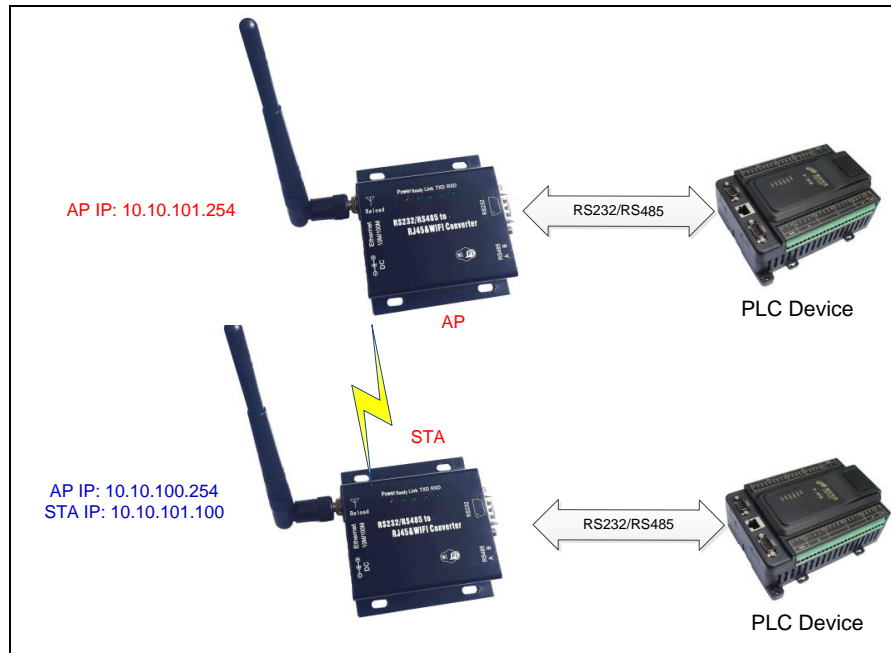

Figure 34. Transparent Serial Port Application

For up side device, configured as AP mode and use default SSID and IP address changed to 10.10.101.254, network protocol configured as TCP/Server mode, and protocol port ID: 8899.

For down side device, configured as STA mode and setting the same SSID with up side device, enable DHCP network and network protocol configured as TCP/Client mode, protocol port ID: 8899. Target IP address part setting the same IP address with up side device ("10.10.101.254" for this example).

When down side device boot up, it will find wireless AP and open TCP/Client network protocol to connect with up side device's TCP/Server. All these operation will be automatic and after finished, the two user devices connected to device through serial port can communicate each other and think the connection between them is fully transparent.

#### 4.3.4. Wireless Data Acquisition Card Application

For this wireless data acquisition card application, one PC works as data server and every data acquisition card connects with a device to support wireless connection function.



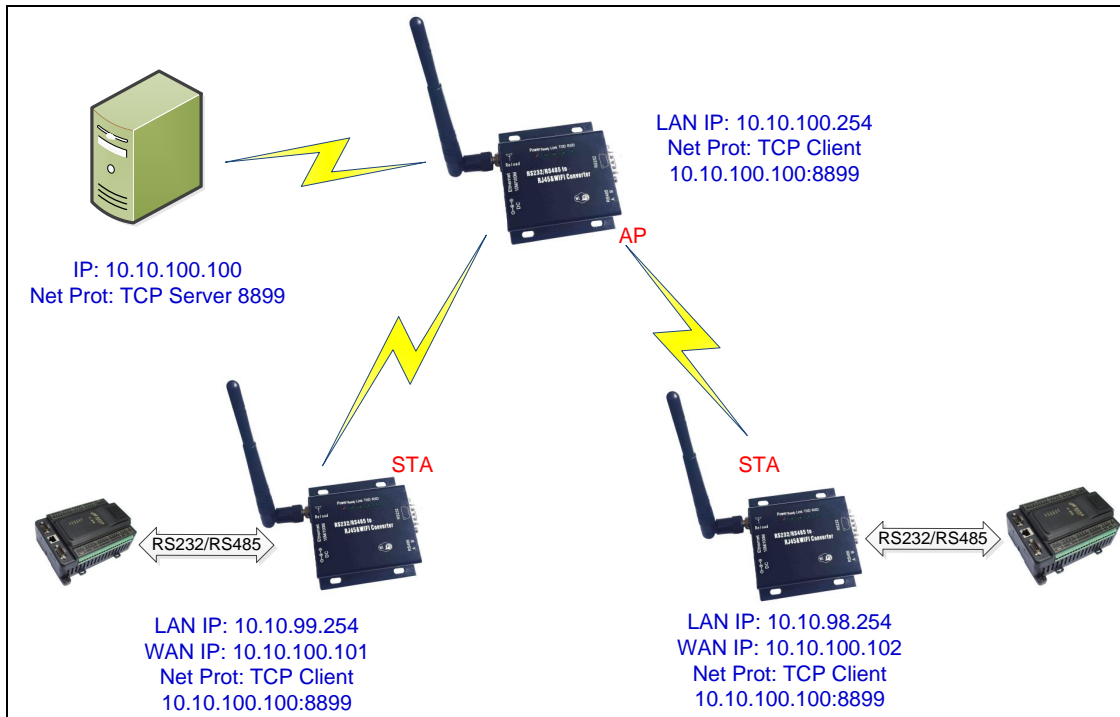

Figure 35. Wireless Data Acquisition Card Application

As above figure, one The device configured as AP mode and all others configured as STA mode. All The device which configured as STA and data server PC wireless connected to The device which configured as AP to make up a wires network.

Data server PC open TCP/Server protocol and all device open TCP/Client protocol. All data acquisition cards' data and sampling information can be transmitted to data server PC for operation.

## 5. AT+INSTRUCTION INTRODUCTION

### 5.1. Configuration Mode

When The device power up, it will default works as transparent transmission mode, then user can switch to configuration mode by serial port command. The device UART default parameters setting as below figure,

Uart Setting	
Baudrate	57600
Data Bits	8
Parity	None
Stop	1
CTSRTS	Disable

Figure 36. The device Default UART Port Parameters

In configuration mode, user can setting the device through AT+ instruction set, which cover all web page setting function.

#### 5.1.1. Switch to Configuration Mode

Two steps to finish switching from transparent transmission mode to configuration mode.

- **UART input “+++”, after device receive “+++”, and feedback “a” as confirmation.**
- **UART input “a”, after device receive “a” and feedback “+ok” to go into AT+ instruction set configuration mode.**

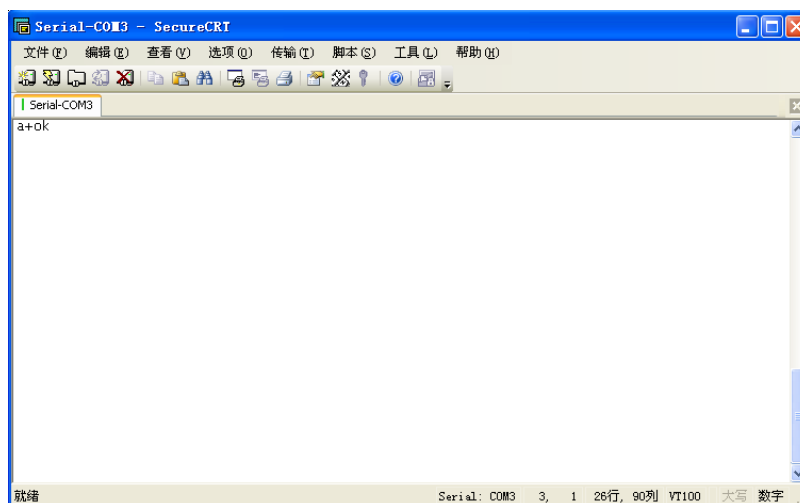

Figure 37. Switch to Configuration Mode

#### **Notes:**

1. When user input "+++" (No "Enter" key required), the UART port will display feedback information "a", and not display input information"+++" as above UART display.
2. Any other input or wrong step to UART port will cause the device still works as original mode (transparent transmission).

## 5.2. AT+ Instruction Set Overview

User can input AT+ Instruction through hyper terminal or other serial debug terminal, also can program the AT+ Instruction to script. User can also input "AT+H" to list all AT+ Instruction and description to start.

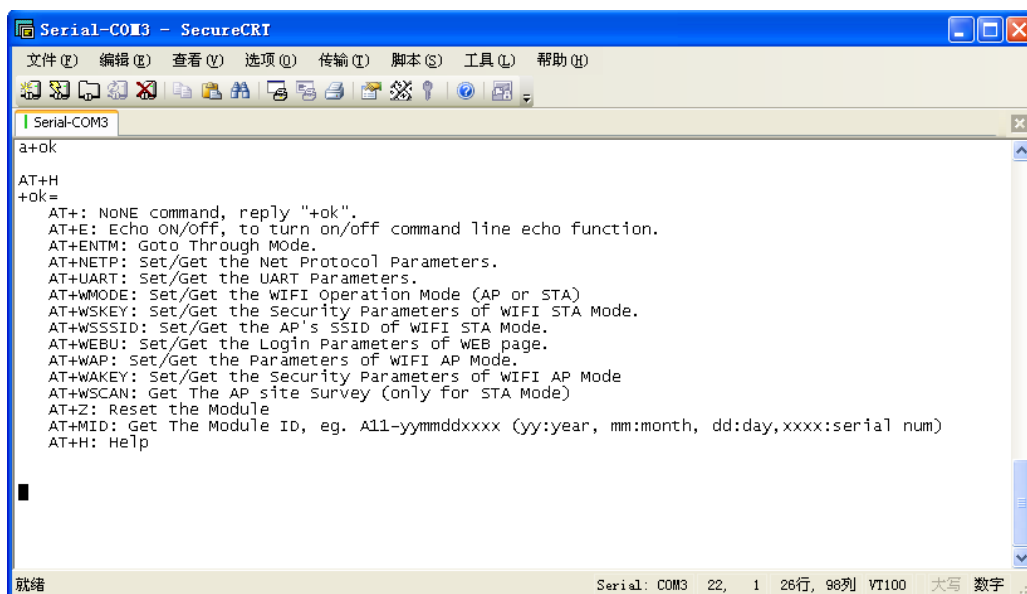

```

Serial-COM3 - SecureCRT
文件(F) 编辑(E) 查看(V) 选项(O) 传输(T) 脚本(S) 工具(L) 帮助(H)
| Serial-COM3
a+ok
AT+H
+ok=
AT+: NONE command, reply "+ok".
AT+E: Echo ON/Off, to turn on/off command line echo function.
AT+ENTM: Goto Through Mode.
AT+NETP: Set/Get the Net Protocol Parameters.
AT+UART: Set/Get the UART Parameters.
AT+WMODE: Set/Get the WIFI Operation Mode (AP or STA)
AT+WSKEY: Set/Get the Security Parameters of WIFI STA Mode.
AT+WSSSID: Set/Get the AP's SSID of WIFI STA Mode.
AT+WEBU: Set/Get the Login Parameters of WEB page.
AT+WAP: Set/Get the Parameters of WIFI AP Mode.
AT+WAKKEY: Set/Get the Security Parameters of WIFI AP Mode
AT+WSCAN: Get The AP site Survey (only for STA Mode)
AT+Z: Reset the Module
AT+MID: Get The Module ID, eg. A11-yyymmddxxxx (yy:year, mm:month, dd:day,xxxx:serial num)
AT+H: Help
就緒
Serial: COM3 22, 1 26行, 98列 VT100 大写 数字

```

Figure 38. "AT+H" Instruction for Help

### 5.2.1. Instruction Syntax Format

AT+Instruction protocol is based on the instruction of ASCII command style, the description of syntax format as follow.

- **Format Description**
  - < >: Means the parts must be included
  - [ ]: Means the optional part
- **Command Message**

**AT+<CMD>[op][para-1,para-2,para-3,para-4...]<CR>**

- AT+: Prefix of command message;
- CMD: Command string;
- [op]: Symbol of command operator,
  - ◆ "=" : The command requires parameters input;

- ◆ "NULL": Query the current command parameters setting;
- [para-n]: Parameters input for setting if required;
- <CR>: "Enter" Key, it's 0x0a or 0x0d in ASCII;

**Notes:** When input AT+Instruction, "AT+<CMD>" character will display capital letter automatic and other parts will not change as you input.

### ➤ Response Message

**+<RSP>[op] [para-1,para-2,para-3,para-4...]<CR><LF><CR><LF>**

- +: Prefix of response message;
- RSP: Response string;
  - ◆ "ok" : Success
  - ◆ "ERR": Failure
- [op] : =
- [para-n]: Parameters if query command or Error code when error happened;
- <CR>: ASCII 0x0d;
- <LF>: ASCII 0x0a;

### ➤ Error Code

Table 6 Error Code DescriptionThe device Web Access Default Setting

Error Code	Description
-1	Invalid Command Format
-2	Invalid Command
-3	Invalid Operation Symbol
-4	Invalid Parameter
-5	Operation Not Permitted

### 5.2.2. AT+ Instruction Set

Table 7 AT+ Instruction Set List

Instruction	Description
<null>	NULL
E	Open/Close show back function
ENTM	Set device into transparent transmission mode
NETP	Set/Query network protocol parameters
UART	Set/Query serial port parameters
UARTF	Open/Close UART auto-frame function
UARTFT	Set/Query UART auto-frame trigger time
UARTFL	Set/Query UART auto-frame trigger length
TMODE	Set/Query data transmission mode (transparent transmission)
WMODE	Set/Query WIFI work mode (AP or STA)
WSKEY	Set/Query WIFI security parameters as STA
WSSID	Set/Query WIFI target AP SSID parameters as STA

WSLK	Query WiFi link status as STA
WEBU	Set/Query WEB page login parameters (User Name and Password)
WAP	Set/Query WIFI parameters as AP
WAKEY	Set/Query WIFI security parameters as AP
HIDESSID	Set/Query hide AP's SSID
MSLP	Set devices into power save mode.(Turn OFF WiFi)
WSCAN	Seek AP when device works as STA mode
TCPLK	Query if TCP link already build-up
TCPDIS	Open/Close TCP (Only TCP Client available)
WANN	Set/Query WAN setting, only effective as STA mode
LANN	Set/Query LAN setting, only effective as AP mode
DHCPDEN	Enable/Disable LAN DHCP server function
DHCPGW	Set/Query DHCP gateway address
TCPTO	Set/Query TCP timeout
MAXSK	Set/Query maxima TCP connection
TCPB	Open/Close TCPB function
TCPPTB	Set/Query TCPB port number
TCPADDB	Set/Query TCPB server address
TCPTOB	Set/Query TCPB time out time
TCPLKB	Query TCPB link status
NTCPBSLEN	Set/Query TCPB SSL function
EPHY	Open/Close ETH interface
STTC	Enable/Disable STA port scan function
DOMAIN	Set/Query domain of device webpage
FRLDEN	Enable/Disable nReload pin function
RELD	Restore to factory default setting
Z	Re-start device
MID	Query device ID information
WRMID	Set device ID
VER	Query device software version information
H	Help
FVEW	Enable/Disable WANN mode
FVER	Set/Query working mode
WMAC	Set/Query AP MAC address
PING	PING command

**Notes:** device can works as AP or STA, user have to use different AT+ Instruction to set WiFi parameters when device works as AP or STA mode.

#### 5.2.2.1. AT+E

- Function: Open/Close show back function;
- Format:

**AT+E<CR>**

**+ok<CR>< LF ><CR>< LF >**

When device firstly switch from transparent transmission to configuration mode, show back status is open, input "AT+E" to close show back function, input"AT+E" again to open show back function.

## 5.2.2.2. AT+ENTM

- Function: Set device into transparent transmission mode;
- Format:

```
AT+ENTM<CR>
+ok<CR>< LF ><CR>< LF >
```

When operate this command, device switch from configuration mode to transparent transmission mode.

## 5.2.2.3. AT+NETP

- Function: Set/Query network protocol parameters;
- Format:
  - ◆ Query Operation

```
AT+NETP<CR>
+ok=<protocol,CS,port,IP><CR>< LF ><CR>< LF >
```

- ◆ Set Operation

```
AT+NETP=<protocol,CS,port,IP><CR>
+ok<CR>< LF ><CR>< LF >
```

- Parameters:
  - ◆ protocol:
    - ◇ TCP
    - ◇ UDP
  - ◆ CS: Network mode:
    - ◇ SERVER
    - ◇ CLIENT
  - ◆ Port: protocol port ID: Decimal digit and less than 65535
  - ◆ IP: Server's IP address when device set as client

After device boots up again, the setting will be effective.

## 5.2.2.4. AT+UART

- Function: Set/Query serial port parameters;
- Format:
  - ◆ Query Operation

```
AT+UART<CR>
+ok=<baudrate,data_bits,stop_bit,parity,flowctrl><CR>< LF ><CR>< LF >
```

- ◆ Set Operation

```
AT+UART=<baudrate,data_bits,stop_bit,parity><CR>
+ok<CR>< LF ><CR>< LF >
```

- Parameters:
  - ◆ baudrate:
    - ◇ 300,600,  
1200,1800,2400,4800,9600,19200,38400,57600,115200,230400,460800

- ◆ data\_bits:
  - ◇ 5,6,7,8
- ◆ stop\_bits:
  - ◇ 1,2
- ◆ parity:
  - ◇ NONE,EVEN,ODD,MARK,SPACE
- ◆ flowctrl: hardware flow control (CTSRTS)
  - ◇ NFC: No flow control
  - ◇ FC: flow control

After device boots up again, the setting will be effective.

#### 5.2.2.5. AT+ UARTF

- Function: Open/Close UART auto-frame function;
- Format:
  - ◆ Query Operation
 

```
AT+ UARTF<CR>
```

```
+ok=<para><CR>< LF ><CR>< LF >
```
  - ◆ Set Operation
 

```
AT+ UARTF=<para ><CR>
```

```
+ok<CR>< LF ><CR>< LF >
```
- Parameters:
  - ◆ para:
    - ◇ disable - Close auto-frame function;
    - ◇ enable - Open auto-frame function;

#### 5.2.2.6. AT+ UARTFT

- Function: Set/Query UART auto-frame trigger time;
- Format:
  - ◆ Query Operation
 

```
AT+ UARTFT<CR>
```

```
+ok=<time><CR>< LF ><CR>< LF >
```
  - ◆ Set Operation
 

```
AT+ UARTFT=<time ><CR>
```

```
+ok<CR>< LF ><CR>< LF >
```
- Parameters:
  - ◆ time: Range 100 ~10000; Unit: ms. Auto-frame trigger time

#### 5.2.2.7. AT+ UARTFL

- Function: Set/Query UART auto-frame trigger length;
- Format:
  - ◆ Query Operation
 

```
AT+ UARTFL<CR>
```

```
+ok=<len><CR>< LF ><CR>< LF >
```
  - ◆ Set Operation

**AT+ UARTFL=<len ><CR>**

**+ok<CR>< LF ><CR>< LF >**

- Parameters:
  - ◆ len: Range 64 ~4096; Unit: byte. Auto-frame trigger length;

#### 5.2.2.8. AT+TMODE

- Function: Set/Query data transmission mode;
- Format:
  - ◆ Query Operation

**AT+TMODE<CR>**

**+ok=<tmode><CR>< LF ><CR>< LF >**

- ◆ Set Operation

**AT+ TMODE=<tmode><CR>**

**+ok<CR>< LF ><CR>< LF >**

- Parameters:
  - ◆ tmode: Data transmission mode
    - ◇ Through: Transparent transmission
    - ◇ Agreement: Serial command mode
    - ◇ GPIO: GPIO mode(Reserved)
    - ◇ Httpdclient: HTTPD Client mode

After device boots up again, the setting will be effective.

#### 5.2.2.9. AT+WMODE

- Function: Set/Query WIFI work mode;
- Format:
  - ◆ Query Operation

**AT+WMODE<CR>**

**+ok=<mode><CR>< LF ><CR>< LF >**

- ◆ Set Operation

**AT+ WMODE=<mode><CR>**

**+ok<CR>< LF ><CR>< LF >**

- Parameters:
  - ◆ mode:WIFI work mode
    - ◇ AP
    - ◇ STA

After device boots up again, the setting will be effective.

#### 5.2.2.10. AT+WSKEY/AT+WSKEYA

- Function: Set/Query WIFI security parameters as STA for first target AP;
- Format:
  - ◆ Query Operation

**AT+WSKEY/AT+WSKEYA<CR>**

**+ok=<auth,encry,key><CR>< LF ><CR>< LF >**

- ◆ Set Operation



**AT+ WSKEY/AT+WSKEYA=< auth,encry,key><CR>**

**+ok<CR>< LF ><CR>< LF >**

- Parameters:
  - ◆ auth: Authentication mode
    - ◇ OPEN
    - ◇ SHARED
    - ◇ WPAPSK
  - ◆ encry:Encryption algorithm
    - ◇ NONE: When "auth=OPEN", effective
    - ◇ WEP-H: When "auth=OPEN" or "SHARED", effective, HEX format
    - ◇ WEP-A: When "auth=OPEN" or "SHARED", effective, ASCII format
    - ◇ TKIP: When "auth= WPAPSK", effective
    - ◇ AES: When "auth= WPAPSK", effective
  - ◆ key: password, ASCII code, shall less than 64 bit and greater than 8bit

This Instruction only effective for The device works as STA. After device boots up again, the setting will be effective. But user can set this command when device configured as AP.

#### 5.2.2.11. AT+WSKEYB

- Function: Set/Query WIFI security parameters as STA for second target AP;
- Format:
  - ◆ Query Operation

**AT+WSKEYB<CR>**

**+ok=<auth,encry,key><CR>< LF ><CR>< LF >**

- ◆ Set Operation

**AT+WSKEYB=< auth,encry,key><CR>**

**+ok<CR>< LF ><CR>< LF >**

- Parameters:
  - ◆ auth: Authentication mode
    - ◇ OPEN
    - ◇ SHARED
    - ◇ WPAPSK
  - ◆ encry:Encryption algorithm
    - ◇ NONE: When "auth=OPEN", effective
    - ◇ WEP-H: When "auth=OPEN" or "SHARED", effective, HEX format
    - ◇ WEP-A: When "auth=OPEN" or "SHARED", effective, ASCII format
    - ◇ TKIP: When "auth= WPAPSK", effective
    - ◇ AES: When "auth= WPAPSK", effective
  - ◆ key: password, ASCII code, shall less than 64 bit and greater than 8bit

This Instruction only effective for The device works as STA. After device boots up again, the setting will be effective. But user can set this command when device configured as AP.

#### 5.2.2.12. AT+WSKEYC

- Function: Set/Query WIFI security parameters as STA for third target AP;
- Format:

- ◆ Query Operation

**AT+WSKEYC<CR>**

**+ok=<auth, encry, key><CR>< LF ><CR>< LF >**

- ◆ Set Operation

**AT+WSKEYC=< auth, encry, key><CR>**

**+ok<CR>< LF ><CR>< LF >**

- Parameters:

- ◆ auth: Authentication mode

- ◇ OPEN
- ◇ SHARED
- ◇ WPAPSK

- ◆ encry: Encryption algorithm

- ◇ NONE: When "auth=OPEN", effective
- ◇ WEP-H: When "auth=OPEN" or "SHARED", effective, HEX format
- ◇ WEP-A: When "auth=OPEN" or "SHARED", effective, ASCII format
- ◇ TKIP: When "auth= WPAPSK", effective
- ◇ AES: When "auth= WPAPSK", effective

- ◆ key: password, ASCII code, shall less than 64 bit and greater than 8bit

This Instruction only effective for The device works as STA. After device boots up again, the setting will be effective. But user can set this command when device configured as AP.

#### 5.2.2.13. AT+WSSSID/AT+WSSSIDA

- Function: Set/Query WIFI first target AP SSID parameters as STA.

- Format:

- ◆ Query Operation

**AT+WSSSID/AT+WSSSIDA<CR>**

**+ok=<ap's ssid><CR>< LF ><CR>< LF >**

- ◆ Set Operation

**AT+ WSSSID/AT+WSSSIDA=<ap's ssid ><CR>**

**+ok<CR>< LF ><CR>< LF >**

- Parameters:

- ◆ ap's ssid: AP's SSID

This Instruction only effective for The device works as STA. After device boots up again, the setting will be effective. But user can set this command when device configured as AP. The default is DTU-H100\_XXXX.

#### 5.2.2.14. AT+WSSSIDB

- Function: Set/Query WIFI second target AP SSID parameters as STA.

- Format:

- ◆ Query Operation

**AT+WSSSIDB<CR>**

**+ok=<ap's ssid><CR>< LF ><CR>< LF >**

- ◆ Set Operation

**AT+ WSSSIDB=<ap's ssid ><CR>**

**+ok<CR>< LF ><CR>< LF >**

- Parameters:
  - ◆ ap's ssid: AP's SSID

This Instruction only effective for The device works as STA. After device boots up again, the setting will be effective. But user can set this command when device configured as AP. The default is DTU-H100\_AP2.

#### 5.2.2.15. AT+WSSSIDC

- Function: Set/Query WIFI third target AP SSID parameters as STA.
- Format:
  - ◆ Query Operation

**AT+WSSSIDC<CR>**

**+ok=<ap's ssid><CR>< LF ><CR>< LF >**

- ◆ Set Operation

**AT+ WSSSIDC=<ap's ssid ><CR>**

**+ok<CR>< LF ><CR>< LF >**

- Parameters:
  - ◆ ap's ssid: AP's SSID

This Instruction only effective for The device works as STA. After device boots up again, the setting will be effective. But user can set this command when device configured as AP. The default is DTU-H100\_AP3.

#### 5.2.2.16. AT+MSSID

- Function: Enable/Disable device wi-fi STA auto switch function
- Format:
  - ◆ Query Operation

**AT+MSSID<CR>**

**+ok=<ret><CR>< LF ><CR>< LF >**

- ◆ Set Operation

**AT+MSSID=<ret><CR>**

**+ok<CR>< LF ><CR>< LF >**

- Parameters:
  - ◆ ret: on/off
    - ✧ off: disable auto switch, default value
    - ✧ on: enable auto switch.

Note: If enable auto switch function, when the device reboot, it will choose the most strong signal strength to connect according to the three AP setting by AT+WSSSIDX command.

#### 5.2.2.17. AT+WSLK

- Function: Query WiFi link status as STA
- Format:
  - ◆ Query Operation

**AT+ WSLK<CR>**

**+ok=<ret><CR>< LF ><CR>< LF >**

- Parameters:
  - ◆ ret
    - ◇ "Disconnected", if no WiFi connection;
    - ◇ "AP' SSID (AP's MAC" ) , if WiFi connection available;
    - ◇ "RF Off", if WiFi OFF;

This Instruction only effective for The device works as STA. After device boots up again, the setting will be effective. But user can set this command when device configured as AP.

#### 5.2.2.18. AT+WEBU

- Function: Set/Query WEB page login parameters;
- Format:
  - ◆ Query Operation

**AT+WEBU<CR>**

**+ok=<usr,password><CR>< LF ><CR>< LF >**

- ◆ Set Operation

**AT+ WEBU=< usr,password ><CR>**

**+ok<CR>< LF ><CR>< LF >**

- Parameters:
  - ◆ usr: User name for WEB page access;
  - ◆ password: Password for WEB page access;

#### 5.2.2.19. AT+WAP

- Function: Set/Query WIFI parameters as AP;
- Format:
  - ◆ Query Operation

**AT+WAP<CR>**

**+ok=<wifi\_mode,ssid,channel><CR>< LF ><CR>< LF >**

- ◆ Set Operation

**AT+ WAP=<wifi\_mode,ssid,channel><CR>**

**+ok<CR>< LF ><CR>< LF >**

- Parameters:
  - ◆ wifi\_mode: WiFi protocols
    - ◇ 11BG
    - ◇ 11B
    - ◇ 11G
    - ◇ 11BGN
    - ◇ 11N
  - ◆ ssid: SSID when device works as AP;
  - ◆ channel: WIFI channel selection
    - ◇ AUTO
    - ◇ CH1~CH11

This Instruction only effective for The device works as AP. After device boots up again, the setting will be effective. But user can set this command when device configured as STA.

## 5.2.2.20. AT+WAKEY

- Function: Set/Query WIFI security parameters as AP;
- Format:

- ◆ Query Operation

**AT+WAKEY<CR>**

**+ok=<auth, encry, key><CR>< LF ><CR>< LF >**

- ◆ Set Operation

**AT+ WAKEY=< auth, encry, key><CR>**

**+ok<CR>< LF ><CR>< LF >**

- Parameters:

- ◆ auth: Authentication mode

- ◇ OPEN
- ◇ SHARED
- ◇ WPAPSK

- ◆ encry:Encryption algorithm

- ◇ NONE: When "auth=OPEN", effective;
- ◇ WEP: When "auth=OPEN", effective or "SHARED", effective;
- ◇ TKIP: When "auth=WPAPSK", effective;
- ◇ AES:When "auth=WPAPSK", effective;
- ◇ TKIPAES:When "auth=WPAPSK", effective;

- ◆ key: password, ASCII code, shall less than 64 bit and greater than 8bit;

This Instruction only effective for The device works as AP. After device boots up again, the setting will be effective. But user can set this command when device configured as STA.

## 5.2.2.21. AT+HIDESSID

- Function: Set/Query hide AP's SSID;
- Format:

- ◆ Query Operation

**AT+ HIDESSID <CR>**

**+ok=<sta.><CR>< LF ><CR>< LF >**

- ◆ Set Operation

**AT+ HIDESSID=<sta><CR>**

**+ok<CR>< LF ><CR>< LF >**

- Parameters:

- ◆ When Query, sta reply if device's SSID is hide;

- ◇ On – not hide SSID;
- ◇ Off - hide SSID;

- ◆ When Set,

- ◇ Off - hide SSID;
- ◇ On - not hide SSID;

## 5.2.2.22. AT+MSLP

- Function: Set devices into power save mode.(Turn OFF WiFi);
- Format:

- ◆ Query Operation

**AT+ MSLP <CR>**

**+ok=<sta.><CR>< LF ><CR>< LF >**

- ◆ Set Operation

**AT+ MSLP=<on/off><CR>**

**+ok<CR>< LF ><CR>< LF >**

- Parameters:

- ◆ When Query, sta reply if the device in sleep mode;

- ◇ On - Device not in sleep mode (WiFi ON);

- ◇ Off - Device in sleep mode(WiFi OFF);

- ◆ When Set,

- ◇ Off - Set device to sleep mode (WiFi OFF);

- ◇ On - Set device to normal mode (WiFi ON);

When device go into sleep mode, user can input "AT+MSLP=on" to re-start the device and device go into transparent transmission mode.

#### 5.2.2.23. AT+WSCAN

- Function: Seek AP when device works as STA mode;

- Format:

**AT+ WSCAN<CR>**

**+ok=<ap\_site><CR>< LF ><CR>< LF >**

- Parameters:

- ◆ ap\_site: AP searched;

#### 5.2.2.24. AT+ TCPLK

- Function: Query if TCP link already build-up;

- Format:

**AT+ TCPLK<CR>**

**+ok=<sta><CR>< LF ><CR>< LF >**

- Parameters:

- ◆ sta.: if device already setup TCP link;

- ◇ on: TCP link setup;

- ◇ off: TCP link not setup;

#### 5.2.2.25. AT + TCPDIS

- Function: Open/Cose TCP (Only TCP Client available);

- Format:

- ◆ Query Operation

**AT+TCPDIS<CR>**

**+ok=<sta><CR>< LF ><CR>< LF >**

- ◆ Set Operation

**AT+ TCPDIS=<on/off><CR>**

**+ok<CR>< LF ><CR>< LF >**

- Parameters:

- ◆ sta.: set/query TCP link status;
  - ✧ on: TCP link available; When setting "on", device will connect to TCP server right away.
  - ✧ off: TCP link not available; when setting "off", device will disconnect with TCP server and not connect again.

#### 5.2.2.26. AT+ WANN

- Function: Set/Query WAN setting, only effective as STA mode;
- Format:
  - ◆ Query Operation  
**AT+WANN<CR>**  
**+ok=<mode,address,mask,gateway><CR>< LF ><CR>< LF >**
  - ◆ Set Operation  
**AT+ WANN=< mode,address,mask,gateway ><CR>**  
**+ok<CR>< LF ><CR>< LF >**
- Parameters:
  - ◆ mode: IP setting for WAN port
    - ✧ static: Static IP
    - ✧ DHCP: Dynamic IP
  - ◆ address: WAN port IP address;
  - ◆ mask: WAN port subnet mask;
  - ◆ gateway: WAN port gateway address;

This Instruction only effective for The device works as STA. After device boots up again, the setting will be effective. But user can set this command when device configured as AP.

#### 5.2.2.27. AT+ LANN

- Function: Set/Query LAN setting, only effective as AP mode;
- Format:
  - ◆ Query Operation  
**AT+LANN<CR>**  
**+ok=<address,mask ><CR>< LF ><CR>< LF >**
  - ◆ Set Operation  
**AT+ LANN=<address,mask ><CR>**  
**+ok<CR>< LF ><CR>< LF >**
- Parameters:
  - ◆ address: LAN port IP address;
  - ◆ mask: LAN port subnet mask;

This Instruction only effective for The device works as AP. After device boots up again, the setting will be effective. But user can set this command when device configured as STA.

#### 5.2.2.28. AT + DHCPDEN

- Function: Enable/Disable LAN DHCP server function;
- Format:
  - ◆ Query Operation

**AT+DHCPDEN<CR>**

**+ok=<sta><CR>< LF ><CR>< LF >**

- ◆ Set Operation

**AT+ DHCPDEN=<sat><CR>**

**+ok<CR>< LF ><CR>< LF >**

- Parameters:
  - ◆ sta. if Enable/Disable LAN DHCP server function;
    - ◇ on: Enable LAN DHCP server function.
    - ◇ off: Disable LAN DHCP server function.

#### 5.2.2.29. AT+ DHCPGW

- Function: Set/Query DHCP gateway address;
- Format:
  - ◆ Query Operation

**AT+ DHCPGW<CR>**

**+ok=<address><CR>< LF ><CR>< LF >**

- ◆ Set Operation

**AT+ DHCPGW=<address ><CR>**

**+ok<CR>< LF ><CR>< LF >**

- Parameters:
  - ◆ address: DHCP gate address;

#### 5.2.2.30. AT+ TCPTO

- Function: Set/Query TCP timeout;
- Format:
  - ◆ Query Operation

**AT+ TCPTO<CR>**

**+ok=<time><CR>< LF ><CR>< LF >**

- ◆ Set Operation

**AT+ TCPTO=<time ><CR>**

**+ok<CR>< LF ><CR>< LF >**

- Parameters:
  - ◆ time: TCP timeout time.
    - ◇ <= 600, (600s);
    - ◇ >=0, (0 means no timeout);
    - ◇ Default, 300s;

#### 5.2.2.31. AT+ MAXSK

- Function: Set/Query maxima TCP connection;
- Format:
  - ◆ Query Operation

**AT+ MAXSK<CR>**

**+ok=<num><CR>< LF ><CR>< LF >**

- ◆ Set Operation



**AT+ MAXSK =<num ><CR>**

**+ok<CR>< LF ><CR>< LF >**

- Parameters:
  - ◆ num: 1~32, default 32. maxima TCP connection;

When configure as TCP/Server, The device support maxime 32 TCP connections. If not require so much connection, user can resetting this parameters.

#### 5.2.2.32. AT+TCPB

- Function: Open/Close TCPB function;
- Format:
  - ◆ Query Operation

**AT+TCPB<CR>**

**+ok=<sta><CR>< LF ><CR>< LF >**

- ◆ Set Operation

**AT+ TCPB=<on/off><CR>**

**+ok<CR>< LF ><CR>< LF >**

- Parameters:
  - ◆ sta: TCPB enable status
    - ◇ on, TCPB enable
    - ◇ off, TCPB disable

After device boots up again, the setting will be effective.

#### 5.2.2.33. AT+TCPPTB

- Function: Set/Query TCPB port number;
- Format:
  - ◆ Query Operation

**AT+TCPPTB<CR>**

**+ok=<port><CR>< LF ><CR>< LF >**

- ◆ Set Operation

**AT+ TCPB=<port><CR>**

**+ok<CR>< LF ><CR>< LF >**

- Parameters:
  - ◆ port: decimal ,<65535

After device boots up again, the setting will be effective.

#### 5.2.2.34. AT+TCPADDB

- Function: Set/Query TCPB server address;
- Format:
  - ◆ Query Operation

**AT+TCPADDB<CR>**

**+ok=<add><CR>< LF ><CR>< LF >**

- ◆ Set Operation

**AT+ TCPADDB=<add><CR>**

**+ok<CR>< LF ><CR>< LF >**

- Parameters:
  - ◆ add: TCPB server address, can be IP address or url.

After device boots up again, the setting will be effective

#### 5.2.2.35. AT+TCPTOB

- Function: Set/Query TCPB time out time;
- Format:
  - ◆ Query Operation

**AT+TCPTOB<CR>**

**+ok=<time><CR>< LF ><CR>< LF >**

- ◆ Set Operation

**AT+ TCPTOB=<time><CR>**

**+ok<CR>< LF ><CR>< LF >**

- Parameters:
  - ◆ time: TCPB time out time, <=600 (600s), >=0 (No time out), default 300

After device boots up again, the setting will be effective.

#### 5.2.2.36. AT+TCPLKB

- Function: Query TCPB link status;
- Format:

**AT+TCPCKB<CR>**

**+ok=<sta><CR>< LF ><CR>< LF >**

- Parameters:
  - ◆ sta: TCPB link status
    - ◇ on, TCPB link OK
    - ◇ off, TCPB link not available

#### 5.2.2.37. AT+NTCPBSSLEN

- Function: Set/Query TCPB SSL function(Only for firmware version with TLS support this feature)
- Format:
  - ◆ Query Operation

**AT+NTCPBSSLEN<CR>**

**+ok=<status><CR>< LF ><CR>< LF >**

- ◆ Set Operation

**AT+ NTCPBSSLEN=<status><CR>**

**+ok<CR>< LF ><CR>< LF >**

- Parameters:
  - ◆ status: on/off, Enable/Disable TCPB SSL function.

#### 5.2.2.38. AT+REGEN

- Function: Set/Query TCP Client register packet, setting is valid after reboot.
- Format:
  - ◆ Query Operation

**AT+REGEN<CR>**

**+ok=<mode><CR>< LF ><CR>< LF >**

- ◆ Set Operation

**AT+REGEN=<mode><CR>**

**+ok<CR>< LF ><CR>< LF >**

- Parameters:
  - ◆ mode: Register packet type
    - ◇ id: id type
    - ◇ mac: mac type
    - ◇ off: disable this function, default value.

#### 5.2.2.39. AT+REGTCP

- Function: Set/Query methods of TCP Client register packet, setting is valid after reboot.

- Format:

- ◆ Query Operation

**AT+REGTCP<CR>**

**+ok=<type><CR>< LF ><CR>< LF >**

- ◆ Set Operation

**AT+REGTCP=<type><CR>**

**+ok<CR>< LF ><CR>< LF >**

- Parameters:
  - ◆ type: Register packet method
    - ◇ first: Register packet is sent when connection is created, default value.
    - ◇ every: Register packet is send for every data packet.

#### 5.2.2.40. AT+REGID

- Function: Set/Query TCP Client register packet id, setting is valid after reboot.

- Format:

- ◆ Query Operation

**AT+REGID<CR>**

**+ok=<id><CR>< LF ><CR>< LF >**

- ◆ Set Operation

**AT+REGID=<id><CR>**

**+ok<CR>< LF ><CR>< LF >**

- Parameters:
  - ◆ id: Register packet id, 0~65535, default is 1111.

Note: When device connect to server, it will send two bytes id number(0~65535, high byte first) and two bytes id complement number, for example id is 1111. Then the data sent to server is "0x04 0x57 0xFB 0xA8". If choose MAC address type, for example ACCF23300130, it will be "0xAC 0xCF 0x23 0x30 0x01 0x30"

#### 5.2.2.41. AT+EPHY

- Function: Enable ETH interface;
- Format:

- ◆ Set Operation

**AT+ EPHY=<CR>**

**+ok<CR>< LF ><CR>< LF >**

Ethernet port function is disabled by default. Input this command to enable Ethernet. This command is not saved, this means after the device reset, Ethernet is disabled by default. Input "AT+FEPHY=on" to enable Ethernet forever..

#### 5.2.2.42. AT+STTC

- Function: Enable/Disable STA port scan function;
- Format:

- ◆ Query Operation

**AT+ STTC<CR>**

**+ok=<sta><CR>< LF ><CR>< LF >**

- ◆ Set Operation

**AT+ STTC=<on/off><CR>**

**+ok<CR>< LF ><CR>< LF >**

- Parameters:
  - ◆ sta: when query, this value feedback
    - ◇ On: Enable STA port scan function;
    - ◇ Off: Disable STA port scan function;

#### 5.2.2.43. AT+DOMAIN

- Function: Set/Query domain of device webpage;
- Format:
  - ◆ Query Operation

**AT+ DOMAIN<CR>**

**+ok=<domain><CR>< LF ><CR>< LF >**

- ◆ Set Operation

**AT+ DOMAIN=<domain><CR>**

**+ok<CR>< LF ><CR>< LF >**

- Parameters:
  - ◇ domain: domain to access to device webpage.

#### 5.2.2.44. AT+FRLDEN

- Function: Enable/Disable nReload pin function;
- Format:
  - ◆ Query Operation

**AT+ FRLDEN<CR>**

**+ok=< on/off ><CR>< LF ><CR>< LF >**

- ◆ Set Operation

**AT+ FRLDEN=<on/off><CR>**

**+ok<CR>< LF ><CR>< LF >**

- Parameters:
  - ◆ on/off: Enable or Disable nReload pin function.

- ◇ On, enable nReload pin function;
- ◇ Off, disable nReload pin function;

Notes: AT+FRLDEN is F-Setting, means restore to factory setting will not affect this command.

#### 5.2.2.45. AT+RELD

- Function: Restore to factory default setting;
- Format:

**AT+RELD<CR>**

**+ok=rebooting...<CR><LF><CR><LF>**

This command restores the device to factory default setting, and then re-starts the device.

#### 5.2.2.46. AT+Z

- Function: Re-start device;
- Format:

**AT+Z<CR>**

#### 5.2.2.47. AT+MID

- Function: Query device ID information;
- Format:
  - ◆ Query Operation

**AT+MID<CR>**

**+ok=<device\_id><CR><LF><CR><LF>**

- Parameters:
  - ◆ device\_id: Device ID information;

#### 5.2.2.48. AT+WRMID

- Function: Set device ID information;
- Format:
  - ◆ Set Operation

**AT+WRMID=<device\_id><CR>**

**+ok<CR><LF><CR><LF>**

- Parameters:
  - ◆ device\_id: Device ID information;

#### 5.2.2.49. AT+VER

- Function: Query device software version information;
- Format:
  - ◆ Query Operation

**AT+VER<CR>**

**+ok=<ver><CR><LF><CR><LF>**

- Parameters:
  - ◆ ver: Device software version information;

#### 5.2.2.50. AT+H

- Function: Help;

- Format:
  - ◆ Query Operation
 

```
AT+H<CR>
```

```
+ok=<commod help><CR><LF><CR><LF>
```
- Parameters:
  - ◆ commod help: command introduction;

#### 5.2.2.51. AT+FVEW

- Function: Enable/Disable Ethernet WANN mode. It's valid only if restore to factory setting.;
- Format:
  - ◆ Query Operation
 

```
AT+ FVEW<CR>
```

```
+ok=<status><CR><LF><CR><LF>
```
  - ◆ Set Operation
 

```
AT+ FVEW=<status><CR>
```

```
+ok<CR><LF><CR><LF>
```
- Parameters:
  - ◆ status: Enable or Disable Ethernet WANN mode..
    - ◇ enable, enable Ethernet WANN mode;
    - ◇ disable, disable Ethernet WANN mode, then it works in Ethernet LANN mode.(**default mode**)

If Ethernet WANN mode is valid. Then wireless connecting router in STA mode is invalid. It only support connecting to router by Ethernet..

#### 5.2.2.52. AT+FVER

- Function: Set/Query device working mode;
- Format:
  - ◆ Query Operation
 

```
AT+ FVER<CR>
```

```
+ok=<status><CR><LF><CR><LF>
```
  - ◆ Set Operation
 

```
AT+ FVER=<n/z><CR>
```

```
+ok<CR><LF><CR><LF>
```
- Parameters:
  - ◆ status: device working mode..
    - ◇ n: router mode.(default mode)
    - ◇ z: bridge mode.

#### 5.2.2.53. AT+WMAC

- Function: Set/Query device MAC address;
- Format:
  - ◆ Query Operation
 

```
AT+ WMAC<CR>
```

**+ok=<address><CR><LF><CR><LF>**

- ◆ Set Operation

**AT+ WMAC=<address><CR>**

**+ok<CR><LF><CR><LF>**

- Parameters:
  - ◆ address: device MAC address in AP mode.

The device's STA MAC address is AP's MAC address plus 1. For example, AP address: ACCF23208888, then STA address: ACCF23208889.

#### 5.2.2.54. AT+PING

- Function: PING command;
- Format:
  - ◆ Set Operation

**AT+ PING=<address><CR>**

**+ok=<status><CR><LF><CR><LF>**

- Parameters:
  - ◆ address: target IP address.
  - ◆ Status:command result.

#### 5.2.2.55. AT+HTPSV/AT+HTTPURL

- Function: Query/Set device http address and port, it is valid only in httpdclient mode, setting is valid after reboot
- Format:
  - ◆ Query Operation

**AT+HTPSV/AT+HTTPURL<CR>**

**+ok=<IP,Port><CR>< LF ><CR>< LF >**

- ◆ Set Operation

**AT+HTPSV/AT+HTTPURL=<IP,Port><CR>**

**+ok<CR>< LF ><CR>< LF >**

- Parameters:
  - ◆ IP: HTTP server address or domain name, default is 10.10.100.200
  - ◆ Port: HTTP server port, default is 80.

#### 5.2.2.56. AT+HTPTP/AT+HTTPTP

- Function: Query/Set device http request type, it is valid only in httpdclient mode, setting is valid after reboot
- Format:
  - ◆ Query Operation

**AT+HTPTP/AT+HTTPTP<CR>**

**+ok=<Type><CR>< LF ><CR>< LF >**

- ◆ Set Operation

**AT+HTPTP/AT+HTTPTP=<Type><CR>**

**+ok<CR>< LF ><CR>< LF >**

- Parameters:

- ◆ Type: GET/PUT/POST, default GET.

#### 5.2.2.57. AT+HTPURL/AT+HTTTPH

- Function: Query/Set device http header directory, it is valid only in httpdclient mode, setting is valid after reboot
- Format:
  - ◆ Query Operation
 

```
AT+HTPURL/AT+HTTTPH<CR>
+ok=<Path><CR>< LF ><CR>< LF >
```
  - ◆ Set Operation
 

```
AT+HTPURL/AT+HTTTPH=<Path><CR>
+ok<CR>< LF ><CR>< LF >
```
- Parameters:
  - ◆ Path: 1~50 length, default "/abcd".

#### 5.2.2.58. AT+HTTPCN

- Function: Query/Set device old http format header connection type, it is valid only in httpdclient mode, setting is valid after reboot.(Reserved)
- Format:
  - ◆ Query Operation
 

```
AT+HTTPCN<CR>
+ok=<Connection><CR>< LF ><CR>< LF >
```
  - ◆ Set Operation
 

```
AT+HTTPCN=<Connection><CR>
+ok<CR>< LF ><CR>< LF >
```
- Parameters:
  - ◆ Connection: 1~20 length, default "keep-alive".

#### 5.2.2.59. AT+HTTTPUA

- Function: Query/Set device old http format header User-Agent, it is valid only in httpdclient mode, setting is valid after reboot.(Reserved)
- Format:
  - ◆ Query Operation
 

```
AT+HTTTPUA<CR>
+ok=<Parameter><CR>< LF ><CR>< LF >
```
  - ◆ Set Operation
 

```
AT+HTTTPUA=<Parameter><CR>
+ok<CR>< LF ><CR>< LF >
```
- Parameters:
  - ◆ Parameter: 1~20 length, default "lwip1.3.2".

#### 5.2.2.60. AT+HTPMODE

- Function: Query/Set device http format, it is valid only in httpdclient mode, setting is valid after reboot.(Reserved)
- Format:



- ◆ Query Operation

**AT+HTPMODE<CR>**

**+ok=<type><CR>< LF ><CR>< LF >**

- ◆ Set Operation

**AT+HTPMODE=<type><CR>**

**+ok<CR>< LF ><CR>< LF >**

- Parameters:

- ◆ type: HTTP format,
  - ◇ new: new HTTP format mode.(default mode)
  - ◇ old: old HTTP format mode.(Reserved)

#### 5.2.2.61. AT+HTPHEAD

- Function: Query/Set device new http format header, it is valid only in httpdclient mode, setting is valid after reboot.(Reserved)

- Format:

- ◆ Query Operation

**AT+HTPHEAD<CR>**

**+ok=<head><CR>< LF ><CR>< LF >**

- ◆ Set Operation

**AT+HTPHEAD=<head><CR>**

**+ok<CR>< LF ><CR>< LF >**

- Parameters:

- ◆ head: new HTTP format packet content, if there exist <CR><LF> characters in the content, replace it with "<<CRLF>>", when set the content in webpage, does not need to consider this,1~200 bytes length, default is "**Content-type:text/html;charset=utf-8**"

#### 5.2.2.62. AT+FASWD

- Function: Query/Set device find password

- Format:

- ◆ Query Operation

**AT+FASWD<CR>**

**+ok=<password><CR>< LF ><CR>< LF >**

- ◆ Set Operation

**AT+FASWD=<password><CR>**

**+ok<CR>< LF ><CR>< LF >**

- Parameters:

- ◆ password: scan password, 1~100 length, the default is "HF-A11ASSISTHREAD" if blank value.

# APPENDIX A: QUESTIONS AND ANSWERS

## Q1: How to configure transparent serial port application (TCP protocol) with two DTU devices?

➤ Network structure as below figure:

■ DTU 1# Setting:

- ✧ Works as AP mode; --See "Mode Selection Page"
- ✧ LAN IP address: 10.10.100.254; --See "AP Interface Setting Page"
- ✧ Network Protocol:TCP/Server, Port ID: 8899; -- See "Application Setting Page"  
(DTU default setting);

■ DTU 2# Setting:

- ✧ Works as STA mode; --See "Mode Selection Page"
- ✧ WAN connection type: DHCP or Static IP (For this example:10.10.100.100) --See "STA Interface Setting Page"
- ✧ Network Protocol:TCP/Client, Port ID: 8899; Application IP address: Module 1#'s LAN IP address (10.10.100.254); -- See "Application Setting Page"
- ✧ **Notes:** When DTU 2# works as STA mode, DTU's WiFi interface works as WAN port. DTU's WAN IP address and LAN IP address shall be setting different segment. So, DTU 2#'s LAN IP address must change to other segment; (For this sample, we change to 10.10.99.254); --See "AP Interface Setting Page"

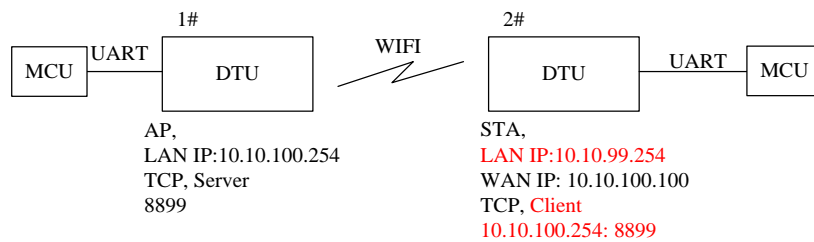

Figure 39. Configure Transparent Serial Port Connection (TCP)

## Q2: Where to SetDTU LAN IP and WAN IP through Web Page?

➤ DTU Wireless LAN IP address setting see "AP Interface Setting Page" as below Figure,

LAN Setup	
IP Address(Default DHCP Gateway)	10.10.100.254
Subnet Mask	255.255.255.0
DHCP Type	Server

Figure 40. DTU LAN IP Setting

- Wireless WAN IP address setting see “STA Interface Setting Page” as below Figure, User can set WAN connection type to DHCP and STATIC IP.

WAN Connection Type: STATIC(fixed IP) ▼

Static Mode	
IP Address	<input style="width: 90%;" type="text" value="0.0.0.0"/>
Subnet Mask	<input style="width: 90%;" type="text" value="0.0.0.0"/>
Default Gateway	<input style="width: 90%;" type="text" value="0.0.0.0"/>
DNS	<input style="width: 90%;" type="text"/>

Figure 41. DTU WAN IP Setting

### Q3: How to configure transparent serial port application (UDP protocol) with two DTUs?

- Network structure as below figure:
  - DTU 1# Setting:
    - ✧ Works as AP mode; --See “Mode Selection Page”
    - ✧ LAN IP address: 10.10.100.254; --See “AP Interface Setting Page”
    - ✧ Network Protocol:UDP, Port ID: 8899; Application IP address:10.10.100.100; -- See “Application Setting Page”
  - DTU 2# Setting:
    - ✧ Works as STA mode; --See “Mode Selection Page”
    - ✧ WAN connection type: Static IP (10.10.100.100) --See “STA Interface Setting Page”
    - ✧ Network Protocol:UDP, Port ID: 8899; Application IP address: DTU 1#'s LAN IP address (10.10.100.254); -- See “Application Setting Page”
    - ✧ LAN IP address: 10.10.99.254 (Different net segment with WAN port) --See “AP Interface Setting Page”

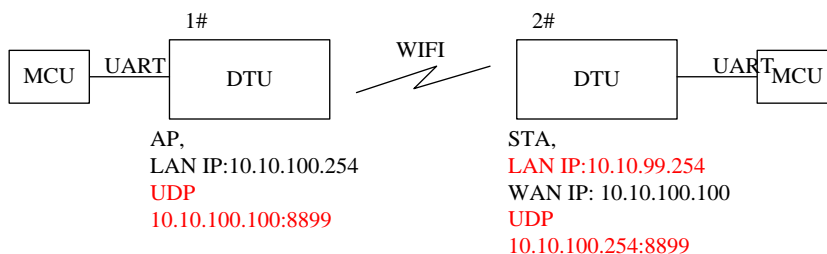

Figure 42. Configure Transparent Serial Port Connection (UDP)

### Q4: Where to set DTU network protocol (TCP/UDP)?

- network protocol setting see “Application Setting Page” as below Figure,
  - Protocol: TCP Server
    - ✧ Only Port ID required: 8899 (Default)

Network A Setting	
Mode	Server ▼
Protocol	TCP ▼
Port	8899
Server Address	10.10.100.254
MAX TCP Num. (1~32)	32
TCP Time out (MAX 600 s)	0
TCP connection password authentication	Disable ▼
Socket B Setting	
Open the SocketB function	on ▼
Port	18899
Server Address	10.10.100.100
TCPB Time out (MAX 600 s)	0

Figure 43. DTU Network Protocols: TCP/Server

■ Protocol: TCP Client

- ✧ Application IP address required: it's target TCP server 's IP address;
- ✧ Port ID required: 8899 (Default)

Network A Setting	
Mode	Client ▼
Protocol	TCP ▼
Port	8899
Server Address	10.10.100.254
MAX TCP Num. (1~32)	32
TCP Time out (MAX 600 s)	0
Socket B Setting	
Open the SocketB function	on ▼
Port	18899
Server Address	10.10.100.100
TCPB Time out (MAX 600 s)	0

Figure 44. DTU Network Protocol: TCP/Client

■ Protocol: UDP

- ✧ No Server/Client selection required;
- ✧ Application IP address required: it's target device 's IP address;
- ✧ Port ID required: 8899 (Default)

Network A Setting	
Mode	Client ▾
Protocol	UDP ▾
Port	8899
Server Address	10.10.100.254
MAX TCP Num. (1-32)	32
Socket B Setting	
Open the SocketB function	on ▾
Port	18899
Server Address	10.10.100.100
TCPB Time out (MAX 600 s)	0

Figure 45. DTU Network Protocol: UDP

### Q5: How to configure transparent serial port application: Two DTUs all configured as STA and connection through AP?

➤ Network structure as below figure:

- DTU 1# Setting:
  - ✧ Works as AP mode and all default setting;
- DTU 2# Setting:
  - ✧ Works as STA mode; --See "Mode Selection Page"
  - ✧ WAN connection type: Static IP: 10.10.100.100; --See "STA Interface Setting Page"
  - ✧ Network Protocol: TCP/Server, Port ID: 8899; -- See "Application Setting Page"
  - ✧ LAN IP address: 10.10.99.254 (Different net segment with WAN port); --See "AP Interface Setting Page"
- DTU 3# Setting:
  - ✧ Works as STA mode; --See "Mode Selection Page"
  - ✧ WAN connection type: Static IP: 10.10.100.101; --See "STA Interface Setting Page"
  - ✧ Network Protocol: TCP/Client, Port ID: 8899; Application IP address: DTU 2#'s WAN IP address (10.10.100.100); -- See "Application Setting Page"
  - ✧ LAN IP address: 10.10.98.254 (Different net segment with WAN port); --See "AP Interface Setting Page"

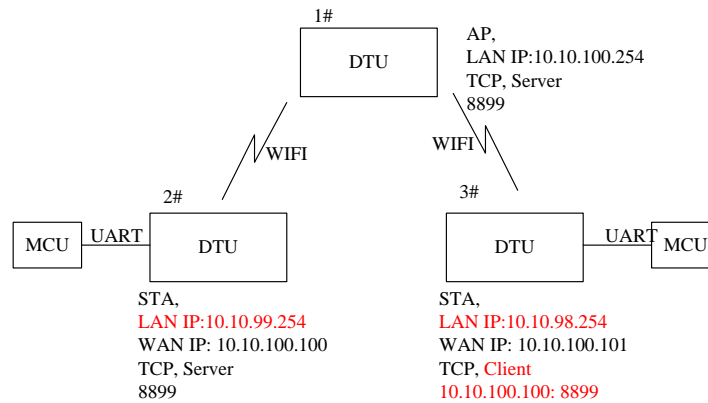

Figure 46. Two DTUs Connection Through AP

### Q6: How to avoid IP address conflict when apply DTU?

- The following address allocation method can avoid the IP address conflict for dynamic and static IP address mixed application.
  - DTU dynamic IP address range from 100 to 200 for last IP address segment.
    - ✧ Such as default IP: 10.10.100.254. When DTU works as AP, the IP address DTU can allocate to STA is from 10.10.100.100 to 10.10.100.200;
  - So, if user needs to set static IP for dedicated STA internal network, the available IP address range can start from 10.10.100.1 to 10.10.100.99.

### Q7: PC works as server, all DTUs works as data acquisition card and connect with PC, how to configure this application?

- Network structure as below figure: Three DTU setup 3 TCP links with PC server. DTU 1# works as AP and all devices connect to DTU 1# through WiFi interface;
  - PC Setting:
    - ✧ IP address: 10.10.100.100;
    - ✧ Network Protocol:TCP/Server, Port ID: 8899;
  - DTU 1# Setting:
    - ✧ Works as AP mode;
    - ✧ LAN IP address: 10.10.100.254;
    - ✧ Network Protocol:TCP/Client, Port ID: 8899; Application IP address:10.10.100.100;
  - DTU 2# Setting:
    - ✧ Works as STA mode;
    - ✧ WAN connection type: Static IP: 10.10.100.101;
    - ✧ Network Protocol:TCP/Client, Port ID: 8899; Application IP address:10.10.100.100;
    - ✧ LAN IP address: 10.10.99.254 (Different net segment with WAN port);
  - DTU 3# Setting:
    - ✧ Works as STA mode;
    - ✧ WAN connection type: Static IP: 10.10.100.102;
    - ✧ Network Protocol:TCP/Client, Port ID: 8899; Application IP address:10.10.100.100;
    - ✧ LAN IP address: 10.10.98.254 (Different net segment with WAN port);

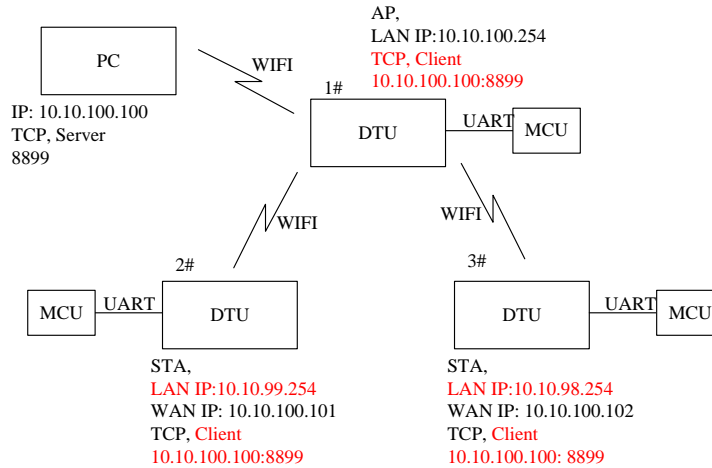

Figure 47. Wireless Data Acquisition Card Setting

**Q8: DTU works in STA mode, how does the PC get the DTU IP address.**

The DTU device supports UDP search function, they will return to the its IP,MAC,MID after get the query password.

- 1、 PC send UDP broadcast password data(E.g xxx.xxx.xxx.255, port 48899), the default password is "HF-A11ASSISTHREAD" and can be modified by AT+FASWD.
- 2、 If the password is correct, the DTU will feedback with its IP/MAC/MID as the following pic show.

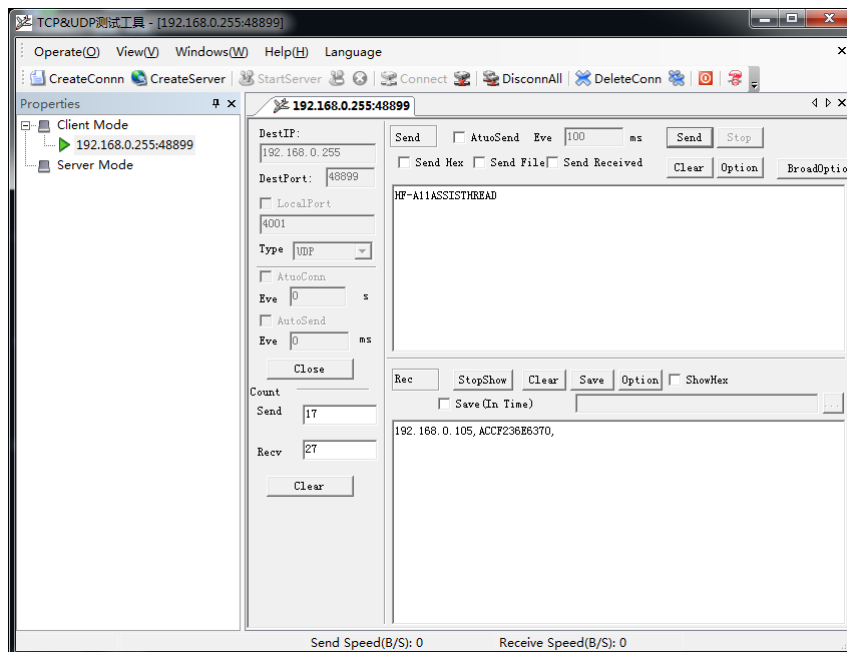

Figure 48. UDP Search Function

## **APPENDIX B:RECOMMEND TOOLST**

Debug Tools download link : <http://pan.baidu.com/s/1i413aUL>, include the following tools.

### **B.1. UART Tools**

SecureCRT

Accessport

### **B.2. TCPUDP Tools**

TCPUDPDbg:

### **B.3. APP Tools**

Wi-Fi Config Tools:



## APPENDIX C: CONTACT INFORMATION

---

Web Site: <http://www.iotworkshop.com/>

Business Contact: [business@iotworkshop.com](mailto:business@iotworkshop.com)

Technical Contact: [support@iotworkshop.com](mailto:support@iotworkshop.com)

After Sale Contact: [service@iotworkshop.com](mailto:service@iotworkshop.com)

---

**END OF DOCUMENT**