

# HILTI

## Hilti Corporation

FL-9494 Schaan

Tel.: +423 / 234 21 11

Fax: +423 / 234 29 65

[www.hilti.com](http://www.hilti.com)



228790

# HILTI

# PD 38

Bedienungsanleitung  
Operating instructions

de  
en



CE

1

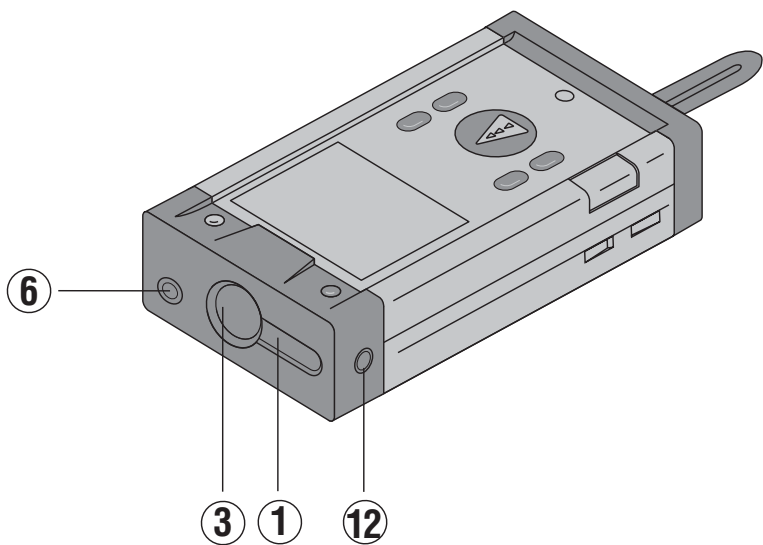
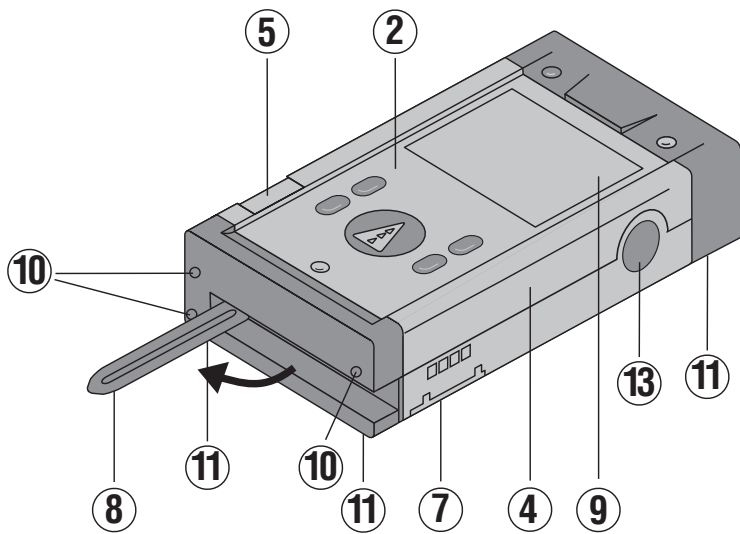

**2**

**PDA 50**

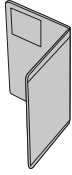

**PDA 80**

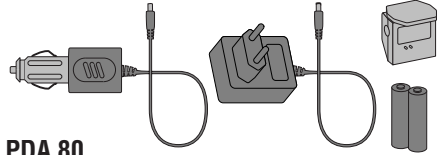

**PDA 60**

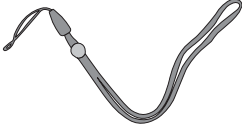

**PDA 81**

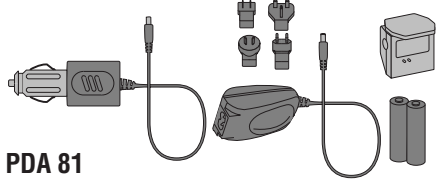

**PDA 61**



**PDAW 80-1**

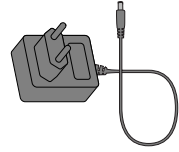

**PDA 62**

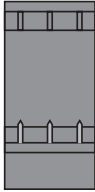

**PDAW 80 / 81-1**



**PDA 70**



**PDAW 80 / 81-2**

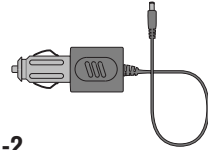

**PUA 60**

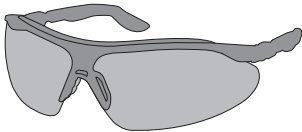

**PDAW 80 / 81-3**



**PDA 66**

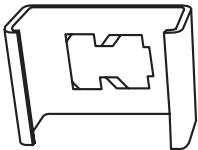

**PDAW 81-1**

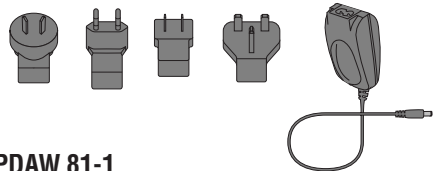

**It is essential that the operating instructions are read before the range meter is used the first time.**

**Always keep these operating instructions together with the range meter.**

**Ensure that the operating instructions are with the range meter when it is given to other persons.**

## Component parts **1**

- ① Laser exit aperture
- ② Control panel
- ③ Receiving lens
- ④ Plastic casing
- ⑤ Horizontal bubble
- ⑥ Vertical bubble
- ⑦ Battery compartment
- ⑧ Folding spike
- ⑨ Graphic display showing operating status
- ⑩ Metal contact points for precise measurement (3x rear)
- ⑪ Metal supports for precise measurement (3x underneath)
- ⑫ Optical sight
- ⑬ Side measure button

## Contents

<b>1.</b>	<b>General information</b> . . . . .	<b>3</b>
1.1	Safety notices and their meaning . . . . .	3
1.2	Pictograms . . . . .	3
1.3	Location of identification data on the range meter . . . . .	3
<b>2.</b>	<b>Description</b> . . . . .	<b>4</b>
2.1	Intended use . . . . .	4
2.2	Items supplied . . . . .	4
2.3	Measuring principle . . . . .	4
2.4	Range meter functions . . . . .	4
2.4.1	General range meter functions . . . . .	4
2.4.2	PD 38 side measure button . . . . .	4
2.4.3	PD 38 optical sight . . . . .	4
2.5	Bluetooth . . . . .	4
<b>3.</b>	<b>Tools and accessories</b> . . . . .	<b>6</b>
3.1	PDA 50 target plate . . . . .	6
3.2	PDA 80/81 charging kits . . . . .	6
3.3	PDAW 80-1 mains adapter . . . . .	6
3.4	PDAW 80/81-2 car battery plug . . . . .	7
3.5	PDAW 80/81-1 charging adapter . . . . .	7
3.6	PDAW 80/81-3 battery pack . . . . .	7
3.7	PDAW 81-1 mains adapter . . . . .	7
3.8	PUA 60 laser visibility glasses . . . . .	7
3.9	PDA 62 belt clip . . . . .	7
3.10	PDA 70 measuring extension . . . . .	7
3.11	PDA 66 Holder . . . . .	7
<b>4.</b>	<b>Technical data</b> . . . . .	<b>8</b>
<b>5.</b>	<b>Safety information</b> . . . . .	<b>9</b>
5.1	Basic safety information . . . . .	9
5.2	Misuse . . . . .	9
5.3	General safety precautions . . . . .	9
5.4	Proper organization of workplace . . . . .	10
5.4.1	Electromagnetic compatibility . . . . .	10
5.4.2	Laser classification . . . . .	10
5.4.3	Transport . . . . .	10

<b>6.</b>	<b>Getting started</b> . . . . .	<b>11</b>	<b>8.</b>	<b>Applications and functions</b> . . . . .	<b>21</b>
6.1	Inserting alkaline/rechargeable batteries . . . . .	11	8.1	Measurement data memory . . . . .	21
6.2	Battery charging . . . . .	11	8.1.1	Saving measurements . . . . .	21
6.2.1	Standard charging of batteries . . . . .	11	8.1.2	Historical data memory . . . . .	21
6.2.2	Fast battery charging . . . . .	12	8.2	Area measurement . . . . .	21
6.3	Switching the range meter on and off . . . . .	12	8.3	Volume measurement . . . . .	22
6.3.1	Initial distance measurement . . . . .	12	8.4	Adding distances . . . . .	23
6.4	Settings . . . . .	13	8.5	Subtracting distances . . . . .	23
6.4.1	Activating the settings menu . . . . .	13	8.6	Setting out . . . . .	24
6.4.2	Menu/Beep . . . . .	13	<b>9.</b>	<b>Measuring using a Bluetooth connection</b> . . . . .	<b>25</b>
6.4.3	Menu/Units . . . . .	13	9.1	Setting up PDA/MDA . . . . .	25
6.4.4	Switching Bluetooth on and off . . . . .	13	9.2	Establishing connection between PD 38 and PDA/MDA . . . . .	25
6.4.5	Terminating the menu . . . . .	13	9.3	Measuring using Bluetooth connection to PDA/MDA . . . . .	26
<b>7.</b>	<b>PD 38 operation</b> . . . . .	<b>14</b>	<b>10.</b>	<b>PDA/MDA Windows CE with Hilti PD 38 application</b> . . . . .	<b>27</b>
7.1	General controls . . . . .	14	<b>11.</b>	<b>Data transfer from PDA/MDA to PC</b> . . . . .	<b>28</b>
7.1.1	Control panel . . . . .	14	<b>12.</b>	<b>Calibration and adjustment</b> . . . . .	<b>29</b>
7.1.2	On/off and control buttons . . . . .	14	12.1	Calibration . . . . .	29
7.1.3	Measure buttons . . . . .	14	12.2	Adjustment . . . . .	30
7.1.4	Function buttons . . . . .	14	12.3	Hilti calibration service . . . . .	30
7.2	Display . . . . .	15	<b>13.</b>	<b>Care and maintenance</b> . . . . .	<b>30</b>
7.2.1	Symbols displayed . . . . .	15	13.1	Cleaning and drying . . . . .	30
7.2.2	Display illumination . . . . .	16	13.2	Storage . . . . .	30
7.3	Optical sight . . . . .	16	13.3	Transportation . . . . .	30
7.4	Measuring distances . . . . .	17	<b>14.</b>	<b>Disposal</b> . . . . .	<b>31</b>
7.4.1	Measuring references . . . . .	17	<b>15.</b>	<b>Warranty</b> . . . . .	<b>31</b>
7.4.2	Measuring distances step by step . . . . .	17	<b>16.</b>	<b>FCC statement (applicable in USA)</b> . . . . .	<b>32</b>
7.4.3	Measurement mode . . . . .	18	<b>17.</b>	<b>Troubleshooting</b> . . . . .	<b>33</b>
7.4.4	Measuring from corners . . . . .	19	<b>18.</b>	<b>Bluetooth declaration of compliance</b> . . . . .	<b>33</b>
7.4.5	Measuring with the aid of target objects . . . . .	19	<b>19.</b>	<b>EC declaration of conformity</b> . . . . .	<b>34</b>
7.4.6	Measuring in bright conditions . . . . .	19			
7.4.7	Taking measurements to rough surfaces . . . . .	20			
7.4.8	Taking measurements to round or inclined surfaces . . . . .	20			
7.4.9	Taking measurements to wet or shiny surfaces . . . . .	20			
7.4.10	Taking measurements to transparent surfaces . . . . .	20			
7.4.11	Measuring ranges . . . . .	20			

# 1. General information

## 1.1 Safety notices and their meaning

### -CAUTION-

This word indicates a possibly hazardous situation which could result in slight bodily injuries or damage to property.

### -NOTE-

This word indicates information to help the user employ the product efficiently, and other useful notes.

## 1.2 Pictograms

### Warning signs



General warning



Laser class 2  
(Do not stare into the beam.)



### Symbols



Read the operating instructions before use.



Return waste material for recycling.

**1** These numbers refer to the corresponding illustrations. The illustrations can be found on the fold-out cover pages. Keep these pages open when studying the operating instructions. In these operating instructions, the PD 38 laser range meter is referred to as « the range meter ».

## 1.3 Location of identification data on the range meter

The type designation and serial number can be found on the rating plate on the range meter. Make a note of this data in your operating instructions and always refer to it when making an enquiry to your Hilti representative or service department.

Type : \_\_\_\_\_

Serial no.: \_\_\_\_\_



## 2. Description

The distance is determined along a laser beam emitted by the range meter up to the surface where the laser beam is reflected. The red laser spot clearly identifies the target from which the measurement is taken.

The measuring range depends on the reflectivity and the surface structure of the target surface.

### 2.1 Intended use

The range meter is designed for:

- Measurement of distances
- Calculation of areas, volumes and distances
- Addition and subtraction of distances
- Operation and storage in the specified temperatures

### 2.2 Items supplied

1 PD 38 laser range meter

1 PDA 50 target plate

1 PDA 60 hand strap

1 PDA 66 holder

2 type AA batteries

1 soft pouch

1 operating instructions

1 producer certificate

### 2.3 Measuring principle

The range meter emits a visible laser beam carrying a wave signal which is reflected and received with a phase shift. The phase shift is used to determine the distance. This measuring principle permits highly accurate and reliable distance measurements to objects without use of special reflectors.

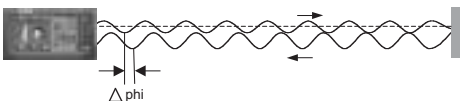

## 2.4 Range meter functions

### 2.4.1 General range meter functions

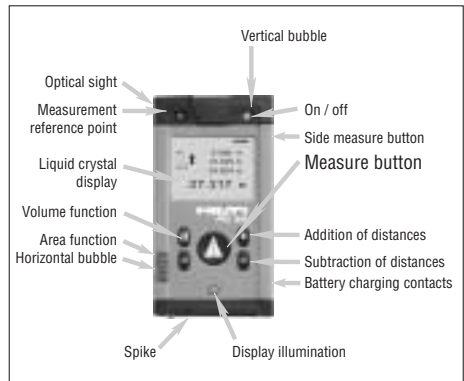

### 2.4.2 PD 38 side measure button

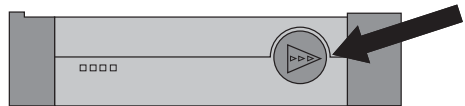

### 2.4.3 PD 38 optical sight

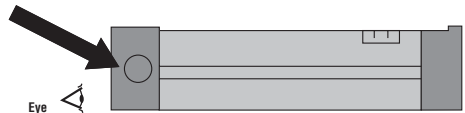

## 2.5 Bluetooth

Bluetooth technology enables wireless data exchange over short distances with fast, reliable and secure data connection maintained typically over 10 m (30 ft). Transmission range can drop to about 5 m (15 ft) under very unfavourable conditions but can also reach up to 20 m (60 ft) under very favourable conditions.



**Unfavourable conditions for Bluetooth communication range**

- Steel surfaces in immediate surroundings
- PD 38 is placed in corners or on wet surfaces
- PD 38 and PDA/MDA are held in wet hands
- Obstructions between PD 38 and PDA/MDA, e.g. thick wall with a lot of steel reinforcement, wire mesh, etc...

**Favourable conditions for Bluetooth communication range**

- Direct sight between PD 38 and PDA/MDA without any obstructions
- PD 38 and PDA/MDA kept at adequate distance (approx. 0.5 m, 2 ft) walls and steel surfaces, etc...
- PD 38 and PDA/MDA are held in dry hands

### 3. Tools and accessories **2**

Description	Designation
Target plate	PDA 50
Hand strap	PDA 60
Soft pouch	PDA 61
Belt clip	PDA 62
Measuring extension	PDA 70
Charging kit	PDA 80
Charging kit	PDA 81
Mains adapter	PDAW 80-1
Mains adapter	PDAW 81-1
Car battery plug	PDAW 80/81-2
Charging adapter	PDAW 80/81-1
Battery pack	PDAW 80/81-3
Laser visibility glasses*	PUA 60



\* These are not laser safety glasses and do not protect the eyes from laser radiation. The laser visibility glasses restrict colour vision. These glasses are therefore not permitted to be worn by a person driving on a public road and must not be used to look directly into the sun

#### 3.1 PDA 50 target plate

The PDA 50 target plate is made of durable plastic with a special reflective coating. In poor light conditions it is advisable to use the target plate for distances above 10 m (30 ft).



#### **-NOTE-**

- For reliable distance measurements the laser beam should be perpendicular to the target plate whenever possible. If this is not the case, the laser spot on the target plate may not be in the same plane as the target point and the distance measured will be incorrect.
- For very accurate measurements using the target plate, 1.2 mm (1/20 inch) should be added to the measured distances.

#### 3.2 PDA 80/81 charging kits

The PDA 80 and PDA 81 charging kits enable use of the range meters with rechargeable cells. Battery charging time is approx. 12 hours for fully discharged cells. However, within the first 15 minutes, the cells are charged with sufficient current for 150–200 measurements.

Please also refer to the description of battery charging in section 6. “Getting started”.

#### Contents of PDA 80 charging kit

- Mains adapter 100–240 V AC with 2-pole Europlug
- Car battery plug
- Charging adapter for range meter
- 2 rechargeable battery cells (NiMH)

#### Contents of PDA 81 charging kit

- Mains adapter 100–240 V AC with 4 interchangeable plugs for US, GB, AUS, EU.
- Car battery plug
- Charging adapter for range meter
- 2 rechargeable battery cells (NiMH)

#### 3.3 PDAW 80-1 mains adapter

The mains adapter is an integral part of the charging kit. It is equipped with a two-pin plug. The mains adapter transforms the power from alternating current to direct

current which is used to charge the batteries. The mains adapter automatically adjusts itself to suit an AC voltage between 100–240 V and 50–60 Hz. The mains adapter has been specially designed to supply current to the charging adapter.



**-NOTE-**

Battery chargers or mains adapters with other voltage outputs, such as those for mobile phones, may not be used. Use of other battery chargers or mains adapters may damage the range meter.

### 3.4 PDAW 80/81-2 car battery plug

The car battery plug is an integral part of the PDA 80/81 charging kit. It can be inserted into a vehicle cigarette lighter or into sockets of the same design. This adapter has a special design and transforms the 12–24 V direct current of a vehicle battery into a voltage suitable for the charging adapter.

A light-emitting diode (LED) is incorporated in the adapter to indicate correct connection for charging. An additional fuse in the adapter's front section provides protection against voltage peaks.



**-NOTE-**

As the car battery plug has been especially designed to charge the NiMH batteries of the PD 38, it may not be replaced by other types of car battery plugs.

### 3.5 PDAW 80/81-1 charging adapter

The respective mains adapter supplies current to the charging adapter. Prior to charging the battery, the side flange connections should be carefully checked.

### 3.6 PDAW 80/81-3 battery pack

The battery pack consists of two rechargeable, 1.2 V NiMH cells with a capacity of approx. 1800 mAh. The battery pack

remains in the battery compartment while being charged.

**-NOTE-**

- There is virtually no “memory effect” with this type of battery and the charging process used.  
The charging process can be interrupted at any time without damaging the battery cells.
- Other brands of rechargeable batteries can be used. It must be ensured, however, that the batteries have a similar capacity of approx. 1800 mAh.

### 3.7 PDAW 81-1 mains adapter

The PDAW 81-1 mains adapter is virtually identical to the PDAW 80-1 mains adapter. The only difference is the type of mains plugs (interchangeable plugs).

### 3.8 PUA 60 laser visibility glasses

The laser visibility glasses clearly improve the visibility of the laser beam (spot).

### 3.9 PDA 62 belt clip

The belt clip is made from durable plastics and is quickly and easily fixed to the belt using the snapper. The range meter snaps into position for carrying and easily detaches when needed.

### 3.10 PDA 70 measuring extension

The measuring extension is made from aluminium and is equipped with a nonconductive plastic grip.

The range meter attaches to the measuring extension with the help of the belt clip. The rear reference is then extended by 1.270 m/50 inches. Please also refer to **section “7. Operation”** for more information on how to change the reference setting when using the measuring extension.

### 3.11 PDA 66 holder

The PDA 66 holder joins the PDA/MDA and PD 38 as one unit. The smaller part can be attached to a solid surface on the rear of the PDA/MDA. The PD 38 can then be clipped into the holder.

## 4. Technical data

### Power supply

3 V DC

Type: AA (LR6, AM3, Mignon)

Standard: two alkaline batteries

Optional: rechargeable NiMH batteries

---

### Battery status indicator

Battery display with four segments showing 100%, 75%, 50% and 25% charged

All segments deleted = discharged battery

---

### Measuring range

0.05 m to 200 m (2 in to 600 ft)

0.05 m (2 in) from the front edge

Max. distance resolution 750 m (2,500 ft)

Typical measuring range without target plate:

– Drywall panel, white 70 m (210 ft)

– Concrete, dry 50 m (150 ft)

– Brick, dry 50 m (150 ft)

---

The maximum range depends on:

– Reflectivity of the target surface

– Ambient light conditions

In case measurements are not possible, use the Hilti PDA 50 target plate.

---

### Accuracy

±1.5 mm (±1/16 in) is typical for individual and continuous measurements \*\*

\*\* The measuring accuracy is affected by ± (1.5 mm + 20 ppm)/± (1/16 in + 20 ppm) due to atmospheric conditions. This effect is typically noticeable at distances > 100 m (> 300 ft).

---

### Smallest unit displayed

1 mm (1/16 in)

---

### Beam diameter

< 6 mm @ 10 m (< 0.2 in @ 30 ft)

< 30 mm @ 50 m (< 1.2 in @ 150 ft)

< 60 mm @ 100 m (< 2.4 in @ 300 ft)

---

### Basic operating modes

Single measurement

Continuous measurement

Calculation/functions

---

### Display

Illuminated liquid-crystal display showing operating status and battery status

---

### Laser

Visible, 620–690 nm, laser class 2

(IEC60825-1: 2003,

CFR 21 § 1040 [FDA])

output power: < 1 mW

---

### Automatic time-out

Laser: 1 min.

Range meter: 10 min.

---

### Battery life at 25 °C (77 °F)

Max. number of measurements

with single set of batteries

(laser switched on for 10 sec.)

Alkaline: 8,000–10,000

NiMH: 6,000–8,000

---

### Operating temperature

–10 °C...+ 50 °C (14 °F... 122 °F)

---

### Storage temperature

–30 °C...+ 70 °C (–22 °F... 158 °F)

---

### Protection class

Dust and splash-proof, IP 54 as

per IEC529 standard

---

### Weight

220 g/0.48 lb (without batteries)

---

### Dimensions

120 (L) x 65 (W) x 28 (H) mm

4.7" (L) x 2.5" (W) x 1.1" (H) in

---

## 5. Safety information

### 5.1 Basic safety information

In addition to the safety precautions listed in the individual sections of these operating instructions, the following points must be strictly observed at all times.

### 5.2 Misuse



The range meter and its accessories can be a source of hazard if they are not used properly or not used for the intended purpose by untrained people.

- Do not use the range meter without suitable prior instruction.
- Do not render any safety devices ineffective and do not remove information and warning notices.
- Have the range meter repaired only at a Hilti service center. Unauthorized opening of the range meter may cause the emission of laser radiation in excess of class 2.
- Tampering with or modification of the range meter is not permissible.
- Use only genuine Hilti accessories and auxiliary tools in order to avoid the risk of injury.
- Do not use the range meter in atmospheres where there is a risk of explosion.
- Use only a clean, soft cloth for cleaning. If necessary, moisten the cloth slightly with pure alcohol.
- Keep the range meter out of the reach of children.
- Measurements taken to plastic foam materials, such as polystyrene foam, or to snow or other strongly reflecting surfaces, may be inaccurate.
- Taking measurements to surfaces with low reflectivity surrounded by areas with high reflectivity may lead to measurement errors.

- Measurements taken through panes of glass or other objects may be inaccurate.
- Rapid changes of the measuring conditions, e.g. persons walking through the laser beam, may lead to measurement errors.
- Do not direct the range meter towards the sun or other sources of bright light.
- Do not use the range meter as a levelling tool.
- Check the range meter before taking important measurements and after it has been dropped or subjected to other mechanical stressing.
- Check the setting of the measuring reference before measuring.

### 5.3 General safety precautions

- Check the range meter for possible damage before use. If the range meter is found to be damaged, have it repaired at a Hilti service centre. The accuracy of the range meter must be checked after it has been dropped or subjected to other mechanical stressing.
- When the range meter is brought into a warm environment from very cold conditions, or vice versa, allow it to become acclimatised before use.
  - Although the range meter is designed for the tough conditions of jobsite use, as with other optical instruments (binoculars, spectacles, cameras, etc.) it should be treated with care.
  - Although the range meter is protected to prevent entry of dampness, it should be wiped dry each time before being put away in its transport container.
  - As a precaution, check the settings you have made before using the range meter.
  - When using the circular bubble level (bull's eye) for alignment, only look at the range meter from the side.

### 5.4 Proper organization of workplace



- Secure the area in which you are measuring. When setting up the range meter, take care to avoid directing the beam toward yourself or other people.
- Avoid unfavourable body positions when working on ladders or scaffolding. Make sure you have a stable stance and avoid danger of overbalancing at all times.
- Measurements taken through panes of glass or other objects may be inaccurate.
- Use the range meter only while observing the specified operating conditions, i.e. not directed towards a mirror, stainless steel, polished stone, etc.
- Observe the accident prevention regulations applicable in the country in which you are working.
- Use the PDA 66 holder only together with the PDAs/MDAs recommended by Hilti and only in conjunction with the PD 38.
- Check to ensure that your PD 38 communicates only with your PDA/MDA, and vice versa.

#### 5.4.1 Electromagnetic compatibility

Although the range meter complies with the strict requirements of the relevant guidelines, Hilti cannot entirely rule out the following possibilities:

- The range meter might cause interference to other equipment, e.g. aircraft navigational equipment.
- The range meter might be subject to interference caused by powerful radiation, which can then lead to incorrect operation. Check the readings for plausibility when measuring in these conditions or if you are unsure of the results.

#### 5.4.2 Laser classification

The range meter conforms to laser class 2 based on the IEC60825-1: 2003; standard and class II based on CFR 21 § 1040 (FDA). These range meters may be used without need for further protective measures. The eyelid closure reflex protects the eyes if a person looks into the beam unintentionally for a brief moment. The eyelid closure reflex can, however, be negatively influenced by medication, alcohol or drugs. Nevertheless, as with the sun, a person should not look directly into sources of bright light. The laser beam should not be directed towards persons.

#### Laser information plates based on IEC60825-1: 2003



#### Laser information plates for the US based on CFR 21 § 1040 (FDA)



This laser product complies with 21 CFR 1040, as applicable.

#### 5.4.3 Transport

Remove the alkaline or rechargeable batteries whenever transporting the range meter.

## 6. Getting started



### 6.1 Inserting alkaline/rechargeable batteries

#### -CAUTION-

- Observe the polarity of the batteries. (refer to symbols inside the battery compartment.)
- Make sure the battery compartment is properly locked.

1. Press the cover of the battery compartment lightly.
2. Slide the cover out and off.
3. Replace the batteries.

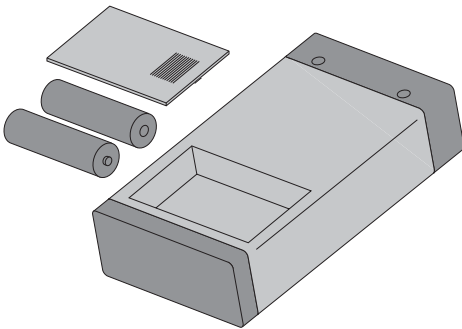

#### -NOTE-

For alkaline batteries

- Always replace a complete set of batteries.
- Do not mix used and new batteries.
- Do not mix batteries of different makes or types.
- Use only undamaged batteries of an approved type.

For rechargeable batteries

- Always use rechargeable batteries of the same make and same type.
- Always use rechargeable batteries of the same age and charged to the same level.
- New rechargeable batteries are supplied uncharged and have to be charged prior to first use.
- Use only 1.2 V NiMH batteries with 1500–2000 mAh capacity.

### 6.2 Battery charging

#### 6.2.1 Standard battery charging

The charging process ensures that there will be virtually no “memory effect”. In view of this, charging can begin at any time regardless of the level to which the battery is already charged.

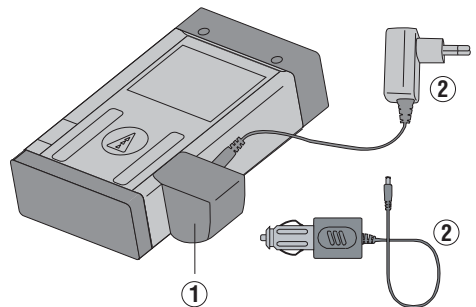

Attach the PDAW 80/81-1 charging adapter to the range meter ①.

For charging, connect either the mains adapter or the car battery plug ② to the charging adapter.







The maximum charging time is 12 hours. As with many mobile phones, the level of charging is shown by movement of battery display segments.

### 6.2.1.1 Battery charging level display

- The level of charging is indicated by moving battery status segments  at top right of the display.
- When a battery is fully charged,   (battery fully charged) will be displayed.

### 6.2.1.2 Charging display for unintentionally inserted alkaline batteries

- If alkaline batteries are identified, all battery status segments flash continually to indicate missing rechargeable batteries. Additionally, the symbol   shows in the display. The range meter cannot be switched on.
- If defective or non re-chargeable alkaline batteries are inserted, the battery display will flash and, at the same time,   (defective battery) will appear in the display.

#### -NOTE-

- The range meter can be switched on and used at any time while the batteries are being charged. The battery charging process stops when the range meter is switched on and the laser activated.
- Rechargeable batteries discharge if they are stored for a long time. The battery charging process terminates after 1 minute when charging deeply discharged or defective rechargeable batteries and the display switches off. In this case, the charging process can be restarted only by disconnecting the range meter from the mains adapter or by removing/replacing the rechargeable batteries.
- Keep the range meter in a safe place.

### 6.2.2 Fast battery charging

The charging process ensures that 15 minutes of charging with the PDAW 80/81-2 car battery plug provides the battery with enough power for a further 150 to 200 measurements.

This process in combination with the car battery plug is of particular advantage in situations where the user needs the range meter ready for use quickly.

### 6.3 Switching the range meter on and off

The range meter is switched on or off by pressing the “On/Off” button. After switching on, the range meter is in the basic display mode.

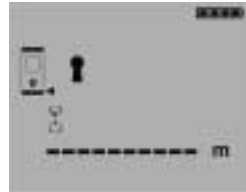

#### 6.3.1 Initial distance measurement

Press the “Measure” button once.

This will switch on the range meter and the laser beam if the range meter was previously switched off.

If the range meter is already switched on, this will activate the laser beam.

Aim the visible laser spot at a target about 3 to 10 (10–30 ft) meters away.

Press the “Measure” button again.

The distance will be shown in less than 1 second, e.g. 5.489 m (16.296 ft).

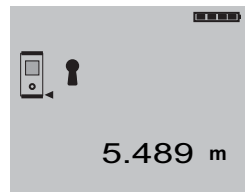

You have taken the first distance measurement with the PD 32 range meter.



## 6.4 Settings

### 6.4.1 Activating the settings menu

The menu is activated by pressing the “On/Off” button for about 2 seconds while the range meter is switched off.

The menu allows beep, units and Bluetooth settings to be made.

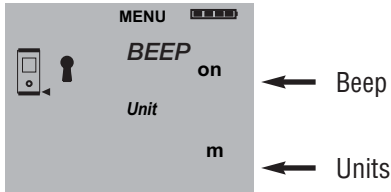

### 6.4.2 Menu/Beep

The “Plus” button is used to switch between the “On” and “Off” modes.

Setting	Option
Beep	On
	Off

### 6.4.3 Menu/Units

The “Minus” button is used to switch between the units, as shown below.

Setting	Distance	Area	Volume
m	meters	m <sup>2</sup>	m <sup>3</sup>
mm	millimeters	m <sup>2</sup>	m <sup>3</sup>
ft	feet (decimal)	feet <sup>2</sup>	feet <sup>2</sup>
yd	feet (decimal)	yard <sup>2</sup>	yard <sup>3</sup>
in	inch (decimal)	inch <sup>2</sup>	inch <sup>3</sup>
in 1/8	feet & inch 1/8	feet <sup>2</sup>	feet <sup>3</sup>
in 1/16	feet & inch 1/16	feet <sup>2</sup>	feet <sup>3</sup>

### 6.4.4 Switching Bluetooth on and off

The menu must be activated with the “ON/OFF” button beforehand. Refer to “6.4.1. Activating the settings menu”.

The volume button toggles Bluetooth between ON and OFF.

The  symbol shows the Bluetooth on-status. Bluetooth is switched off when this symbol is not displayed.

The  symbol indicates an active connection to a PDA/MDA running the Hilti PD 38 software.

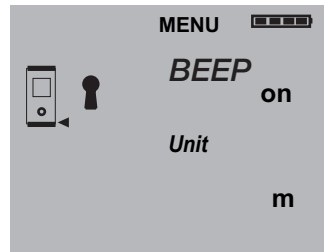

Bluetooth switched on

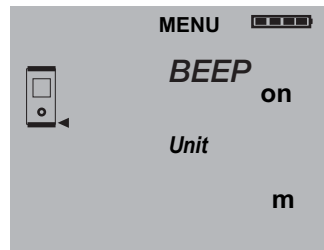

Bluetooth switched off

#### -NOTE-

The PD 38 connects only to devices running the Hilti PD 38 measuring application on the Windows CE operating system or wherever a Hilti Bluetooth interfacing version is installed and active (typical PDA/MDA).

### 6.4.4 Terminating the menu

The menu is terminated by pressing the “On/Off” button. All settings displayed will be saved.

## 7. Operation

### 7.1 General controls

#### 7.1.1 Control panel



#### 7.1.2 On/off and control buttons



**ON/OFF**  
– switches the range meter on and off.



**Measuring reference point**  
– switches the measuring reference between front and rear.



**Display illumination**  
– switches the display illumination on and off.

#### 7.1.3 Measuring extension as reference



+



– Tool is switched off. Press the measuring reference button and the on/off button simultaneously. The measuring spike flashes in the display. The reference is then set to the end of the fully extended measuring extension.

#### 7.1.3 Measure buttons



**“Measure” button**  
– switches the range meter on  
– activates the laser beam for aiming at the target,  
– activates single distance measurement  
– activates and deactivates continuous distance measurement.



**Side “Measure” button**  
– activates the laser beam for aiming at the target,  
– activates individual distance measurement  
– activates and deactivates continuous distance measurement.

#### 7.1.4 Function buttons

Calculation functions are activated by pressing the relevant function buttons. When a measurement using a function has been carried out incorrectly or unintentionally, the function can be reset at any time by pressing the same function button again or any other function button.



**Volume**  
– activates the “volume” function and deactivates every other function.

**Area**

- activates the “area” function and deactivates every other function.

**Plus**

- activates the “distance addition” function and deactivates every other function.

**Minus**

- activates “distance subtraction” and deactivates every other function.

**7.2 Display**

The display shows the measurements, settings and range meter status.

In the measuring mode, the latest readings are shown in the lowest display line (result line) and the prior readings in the lines above. For functions such as area, volume, Pythagoras, etc., the measured distances are displayed in the intermediate lines and the calculated result appears in the lowest display line (result line).

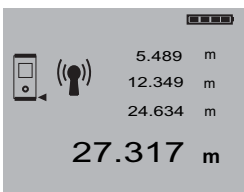
**7.2.1 Symbols displayed****Temperature too high**

> +50 °C (122 °F)

**Action:**

Allow the range meter to cool down.

**Temperature too low**

< -10 °C (14 °F)

**Action:**

Warm up the range meter.

**Unfavourable signal conditions**

Insufficient reflected laser light

**Action:**

- Observe the minimum measuring distance of > 50 mm (2 in) from the front edge.
- Clean the lens.
- Take a measurement from another surface or use the PDA 50 target plate.

**Ambient light at target too bright****Action:**

- Shade the target from bright light or use the PDA 50 target plate.

**Laser switched on**

- Moving broken line

**Display reference status**

- Front edge
- Rear edge
- Spike
- Spike (flashing) – automatically adds 1.270 m/50 inches to measurements

**Battery status**

- 4 segments = 100% fully charged
- 3 segments = 75%
- 2 segments = 50%
- 1 segment = 25%
- 0 segments = discharged

 Batteries fully discharged

**Action:**

- Replace batteries.
- Recharge rechargeable batteries.

---

**MENU**      **Menu activated**



**Bluetooth is switched on**



**Bluetooth has established connection to another device**



**Historical data mode active**

- Displays the previous 5 measurements or complete functions results including graphics.



**General hardware error**

Switch the range meter off and then back on. If the error persists, notify the local Hilti service centre.



**Volume measurement active**



**Area measurement active**

### 7.2.2 Display illumination



= Illumination button

The illumination button switches the display illumination on or off. In the dark or in very bright light, e.g. sunlight or a strong spotlight, the display illumination makes it easier to read the display.

**-NOTE-**

Display illumination consumes additional power. If it is used frequently, shorter battery life must be expected.

### 7.3 Optical sight

The built-in optical sight is of great benefit when measuring outdoors and whenever the laser spot is poorly visible. The optical sight allows the laser spot to be positioned on the target accurately even at great distance. The laser spot is visible in the optical sight when the range meter is switched on. If the laser spot is not visible in the optical sight then either the measurement has been completed successfully or the laser beam has switched itself off automatically after the preset time (1 minute). The optical axis of the sight runs parallel to the laser beam.

#### Typical measuring procedure with the optical sight

- Press the “Measure” button to activate the laser beam.
- Use the optical sight to aim the range meter and position the laser spot on the target.
- Press the measure button or side measure button and keep the laser spot on the target until the spot disappears from the optical sight.
- Read the distance from the display.

## Diagram of optical sight

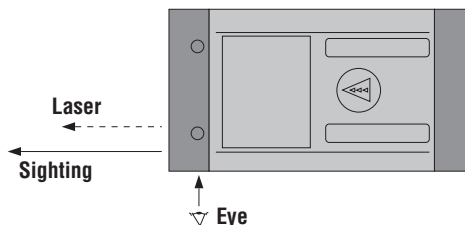

### -NOTE-

Use of the optical sight is recommended for distances above 10 m (30 ft.).

## 7.4 Measuring distances

Distance measurements can be taken to all stationary targets without a highly reflective surface, i.e. concrete, rock, wood, plastic, paper, etc. The use of prisms or measuring to highly reflective surface is not permitted and, if attempted, might falsify the results.

### 7.4.1 Measuring references



= Reference button

The range meter can measure distances from three different measuring reference points.

The measuring reference point can be toggled between the front edge and rear edge by pressing the reference button on front left of the range meter. The reference is set automatically to the end of the spike when the spike is folded out to the 90° position. The reference can be set to the end of the PDA 70 measuring reference extension by pressing the reference button (top left) and the on/off button (top right) simultaneously while the range meter is switched off. The spike symbol in the display then begins to blink.

This measuring reference setting for the PDA 70 can be deactivated by switching the range meter off and then on again.

### Display



Reference position

Front edge



Rear edge



End of spike



PDA 70 measuring extension Spike (flashing) extends by 1.270 m/50 inches

### -NOTE-

– If the spike is folded out 180°, the reference point is always automatically set to the rear edge.

### 7.4.2 Measuring distances step by step

The range meter measures distances in a very short time and, when doing so, shows various information in the display.

1. Switch on the range meter by pressing the “On” button.

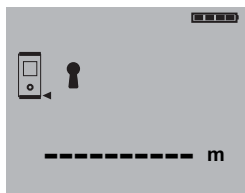

2. Press the “Measure” button once. This switches on the red laser beam which is visible as a laser spot on the target surface. The display shows this aiming mode as an animated broken line.

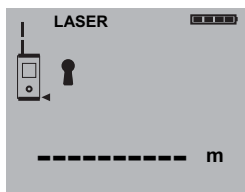

3. Aim at the target.
4. Press the “Measure” button once again to measure the distance.

The result appears in the result line normally in less than a second. The laser beam switches off.

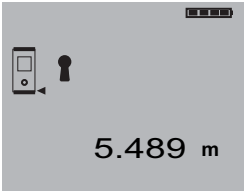

If further measurements are taken, up to three previously determined distances are shown in the intermediate result lines, i.e. a total of the last four measured distances are shown.

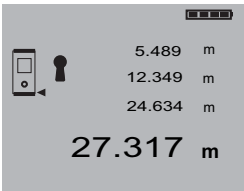

### 7.4.3 Measuring mode

Two different distance measuring modes are available. These are single distance measurement and continuous distance measurement. The continuous measurement mode is used for setting out given distances or offsets and is also used where distance measurements are more difficult, e.g. to corners, edges, niches, etc.

#### 7.4.3.1 Single distance measurement (“Measure”)

1. Switch on the laser beam by pressing the “Measure” button.
2. Press the “Measure” button once again. The measured distance will normally be shown in the result line in less than a second.

#### -NOTE-

Alternatively, the range meter may be switched on by pressing the “On” button and the laser then activated by pressing the “Measure” button.

#### 7.4.3.2 Continuous measurement

Press the “Measure” button for about 2 seconds to activate this measuring mode. When doing so, it does not matter whether or not the range meter or the laser beam is switched on or off. The range meter will always switch to continuous measurement. During continuous measurement, distances are updated in the result line at the rate of about 8 to 15 measurements every second. The rate of measurement depends on the reflectivity of the target surface.

If the beep signal is active, continuous measurement is indicated by a beep. The measuring process is stopped by pressing the “Measure” button once again. On doing so, the last valid distance measurement will be shown in the result line in the display.

#### -NOTE-

Continuous measurement is possible in all situations where distances can be measured. This applies also to functions, such as areas and volumes.

### 7.4.4 Measuring from corners

The spike is used when measuring diagonally across rooms or from inaccessible corners.

1. Fold out the spike 90°.

This automatically sets the measuring reference to the end of the spike. The range meter takes the extended reference point into account and corrects the measured distances accordingly.

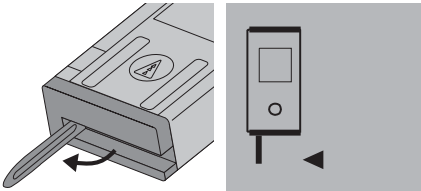

2. Position the range meter with the spike at the desired starting point for the measurement and aim towards the target.

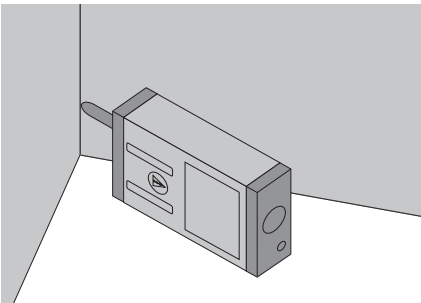

3. Press the "Measure" button. The measured distance appears in the display.

### 7.4.5 Measuring with the aid of target objects

When taking measurements to outside corners, e.g. on buildings, perimeter fences, etc., boards, bricks or other suitable objects can be used as the target.

Use of the PDA 50 target plate is recommended for long distances and in unfavourable light conditions, e.g. strong sunlight.

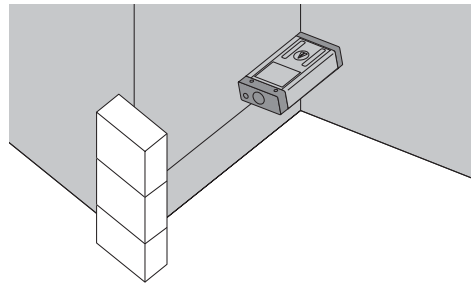
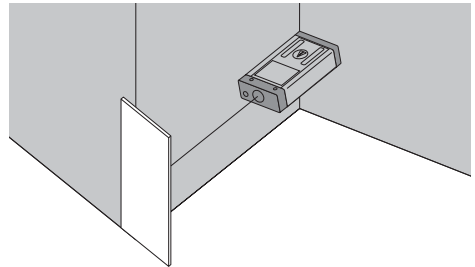

### 7.4.6 Measuring in bright conditions

The PD 38 has a built-in optical target sight. When measuring to very bright surfaces, the laser spot is often not visible. Thanks to the laser spot superimposed in the optical sight, you can always clearly and reliably aim at the target. We recommend use of the PDA 50 target plate for long distances and bright light conditions.

### 7.4.7 Taking measurements to rough surfaces

When measuring to rough surfaces, e.g. coarse render, stucco, etc, an average distance value is measured with the centre of laser spot weighted higher than the edges of the laser spot.

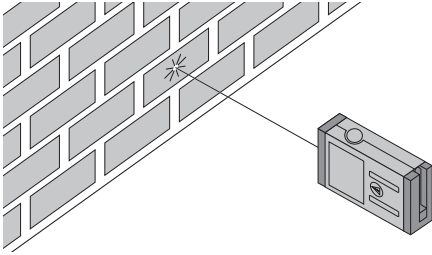

### 7.4.8 Taking measurements to round or inclined surfaces

If the laser beam strikes the target surface at a very narrow angle, the light reflected may be inadequate.

Conversely, too much light may be reflected toward the range meter in certain situations where the laser beam strikes the target perpendicularly.

We recommend use of the PDA 50 target plate in both of these situations.

### 7.4.9 Taking measurements to wet or shiny surfaces

As long as the range meter can be aimed towards the surface, the distance to the target will be reliably measured. In the case of highly reflective surfaces, a reduction in range or measurement of the distance to the actual point of reflection must be expected.

### 7.4.10 Taking measurements to transparent surfaces

It is not possible to measure distances to transparent materials, e.g. liquids, polystyrene foam, etc. This is because light penetrates these materials and therefore measuring errors may occur. Measuring errors may also occur if measurements are taken through glass or if obstructions are present within the line of the laser beam.

### 7.4.11 Measuring ranges

#### 7.4.11.1 Increased distances

- Taking measurements in the dark, at dawn, dusk and to shaded targets or with the front of the range meter shaded, generally leads to an increase in the measuring range.
- Taking measurements to the PDA 50 target plate also results in an increase in the measuring range.

#### 7.4.11.2 Reduced distances

- Taking measurements in very bright ambient light, e.g. in sunshine or a very bright spotlight etc, can lead to a reduction in range.
- Taking measurements through glass or other objects in the target beam can lead to reduced measuring range.
- Taking measurements to matt green, blue or black, wet or shiny surfaces can lead to reduced measuring range.



## 8. Applications and functions

The individual steps within all functions are supported by the graphical display.

### -NOTE-

- Continuous measurement can be used within all functions where single measurements are possible.
- If measuring errors occur during continuous measurement or if continuous measurement is stopped by pressing the “Measure” button again, the last valid distance will be shown.

All PD 38 on-board functions such as area, volume, plus and minus are disabled while a Bluetooth connection is active.

An active connection is indicated by the  symbol.

### 8.1 Measurement data memory

The range meter continuously saves the measured values and the results of calculations while measuring.

#### 8.1.1 Saving measurements

When measuring several distances, up to three previous distances are displayed in the intermediate result lines. This means that, in total, the last four measured distances are displayed or saved.

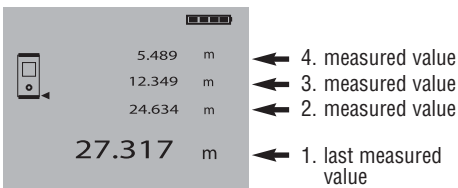

### 8.1.2 Historical data memory

The range meter saves the last five measurements or calculations including the graphics. This saved data can be shown consecutively in the display by pressing the plus and minus buttons immediately after switching on the range meter with the on/off button (as long as no function has been carried out or distance measurement taken).

The symbol “Historical data mode active” shows the data stored in the memory.

Example of the display of a saved volume measurement:

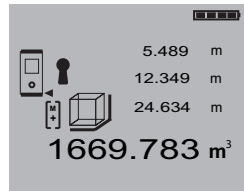

### 8.2 Area measurement

Areas can be determined easily and quickly. Press the “Area” function button. This switches the laser beam on – ready for measuring.

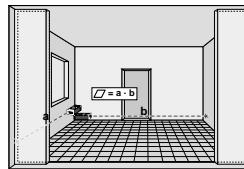

The individual steps for determining an area are supported by a corresponding graphic display. To determine the floor space of a room, for example, the procedure is as follows:

## 8. Applications and functions

1. At the start of the area function, the laser beam is switched on.
2. Aim the range meter at the target.
3. Press the “Measure” button.  
The room width will be measured and shown.
4. After this, the graphic display will automatically request measurement of the room length.
5. Aim the range meter at the next target to obtain the room length.
6. Press the “Measure” button.  
The second distance will be measured, the area immediately calculated and the result shown in the result line.

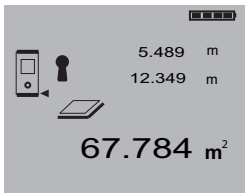

Both distances required to calculate the area appear in the intermediate result lines and can be conveniently noted after the measurements and the calculation.

### -NOTE-

To determine another area, press the “Area” function button again.

### 8.3 Volume measurement

Volumes can be determined in one measuring operation.

Press the “Volume” function button. This switches the laser beam on – ready for measuring.

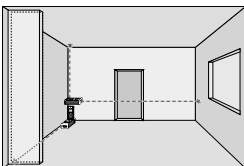

The individual steps for determining a volume are supported by a corresponding graphic display. To determine the volume of a room, for example, the following procedure must be followed:

1. At the start of the volume function, the laser beam is switched on.
2. Aim the range meter towards at the target.
3. Press the “Measure” button.  
The room width will be measured and shown.
4. After this, the graphic display will automatically request measurement of the room length.
5. Aim the range meter at the next target to obtain the room length.
6. Press the “Measure” button.  
The room length will be measured.
7. After this, the graphic display will automatically request measurement of the room height.
8. Aim the range meter at the next target to obtain the room height.
9. Press the “Measure” button.  
The room height will be measured, the volume immediately calculated and the result shown in the result line.

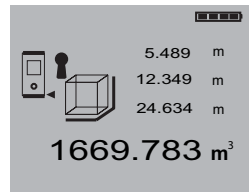

All three distances required to calculate the volume appear in the intermediate result lines and can be conveniently noted after the measurements and the calculation.

### -NOTE-

To determine another volume, press the “Volume” function button again.

### 8.4 Adding distances

Individual distances can be conveniently added. This is useful for determining the total length of the inner face of door or window openings or for adding several partial distances that form a perimeter.

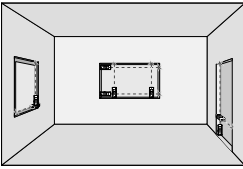

1. Press the “Measure” button.  
(The laser beam will be switched on.)
2. Direct the range meter towards the target.
3. Press the “Measure” button.  
The first distance will be measured and shown. (The laser will be switched off.)
4. Press the “Plus” button to add the next distance. The first distance will appear in the middle (intermediate) result line and a plus sign in the lower line. (The laser beam will be switched on.)
5. Aim the range meter at the next target.
6. Press the “Measure” button.  
The second distance will be measured and shown in the lower (intermediate) result line. The calculation result will appear in the result line at the same time.

The current total of the distances is always shown in the result line.



This procedure can be repeated until all distances have been added.

To terminate the addition of distances, simply measure a distance without first pressing the “Plus” button. The previous three measurement and calculation results will be shown in the intermediate displays.

### 8.5 Subtracting distances

Individual distances can be conveniently subtracted from each other. This is useful for determining, for example, offsets to inaccessible places or the distance from the underside of a pipe to the ceiling. To do so, the distance from the floor to the underside of the pipe is subtracted from the distance from the floor to the ceiling. If, additionally, the pipe diameter is deducted, the result is the distance from the top of the pipe to the ceiling.

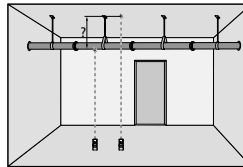

1. Press the “Measure” button.  
(The laser beam will be switched on.)
2. Aim the range meter at the target.
3. Press the “Measure” button.  
The first distance will be measured and shown. (The laser beam will switch off.)
4. Press the “Minus” button for subtraction.  
The first distance will appear in the middle (intermediate) result line and a minus sign in the lower line. (The laser beam will switch on.)
5. Aim the range meter at the next target.
6. Press the “Measure” button.  
The second distance will be measured and shown in the lower (intermediate) result line. The result of the subtraction will appear in the result line.

The current difference between distances is always shown in the result line.



This procedure can be followed until all distances have been subtracted. To terminate the subtraction of distances, simply measure a distance without first pressing the “Minus” button. The previous measurement and calculation results will be shown in the intermediate displays.

### 8.6 Setting out

Predetermined dimensions, such as for installing drywall tracks, can be set out and marked with the range meter.

The continuous measurement mode is used when transferring dimensions from drawings. (See also section 7.4.3.2 “Continuous measurement.”)

Hold the “Measure” button pressed for approx. 2 seconds to activate the continuous measurement mode. When doing so, it does not matter whether the range meter or the laser beam are switched on or off. The range meter always switches to the continuous measurement mode. Move the range meter slowly until the desired distance is reached or appears in the display.

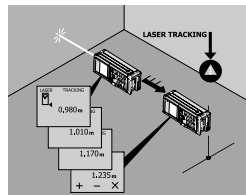

Press the “Measure” button once again to end the continuous measurement mode.

## 9. Measuring using a Bluetooth connection

### -NOTE-

Only PDAs/MDAs running the Windows CE operating system are compatible with the PD 38.

### 9.1 Setting up the PDA/MDA

If you intend to use a new PDA/MDA out of the box for the first time with a PD 38, it is required to first connect the PDA/MDA to the PC. Please follow the user instructions for the PDA/MDA which describe how to make a PC connection and how to set up the PDA/MDA for data exchange with a PC. Section 9.1.1 can be used as a general guideline. Please refer to the instructions supplied with your PDA/MDA for more detailed information.

If your PDA/MDA running the Windows CE operating system is already set up for data exchange using "Active Sync", please go to section 9.2 "Establishing a connection between PDA/MDA and PD 38".

#### 9.1.1 Installation and connection of PDA/MDA and PC

General step-by-step instructions for connecting a PDA/MDA and a PC:

1. The CD-ROM supplied with the PDA/MDA contains the Windows connection software Active Sync. Install this software on the PC in accordance with the instructions of the PDA/MDA manufacturer.
2. Connect the PDA/MDA docking station to the PC with a USB cable.
3. Place the PDA/MDA in the docking station and switch it on.
4. Active Sync should activate itself automatically on the PC after the PDA/MDA has been placed in the docking station and switched on. Alternatively, Active Sync can be started manually on the PC.

5. Follow the instructions of "Active Sync" to establish a guest partnership with the PC.

### -NOTE-

Read the instructions for the PDA/MDA carefully about setting up the connection to the PC using the Windows software "Active Sync".

#### 9.1.2 Installation of Hilti PD 38 application software on a PDA/MDA

Installation of Hilti PD 38 application software on a PDA/MDA:



Before beginning the installation, it is essential that the connection between the PDA/MDA and the PC has been established by installing the Active Sync Windows PC software.

1. Place the PDA/MDA in the docking station and switch it on.
2. Follow the instructions of "Active Sync" to establish a guest partnership with the PC.
3. Insert the Hilti PD 38 CD-ROM in the CD-ROM drive. The installation will start automatically.  
Please follow the instructions on the screen.

Remove the PDA/MDA from the docking station after successful installation of the Hilti PD 38 application software.

#### 9.2 Establishing a connection between PD 38 and PDA/MDA

Before the connection can be established it is essential that the Hilti PD 38 application software has been successfully installed on the PDA/MDA.

1. Switch on the PD 38 by pressing the "On" button . Check that the  symbol is displayed. If this symbol is not displayed, check that Bluetooth is switched on (refer to section 6.4.4 "Switching Bluetooth on and off").

2. Switch on the PDA/MDA and proceed as follows:

- Select Windows **Start**
- Select **Programs**
- Select the Hilti PD 38 symbol 

The Hilti PD 38 application then starts with the following screen:



A search for all nearby Hilti PD 38 laser range meters with active Bluetooth mode will start as soon as the above screen is shown. The search can take up to 2 minutes. The displayed list shows the serial numbers of all PD 38s found. Select the serial number of your PD 38. The serial number can be found on the back of the PD 38. Press the  button to make the connection.

The connection is established after approximately 30 seconds. The  symbol provides verification of a successful connection.

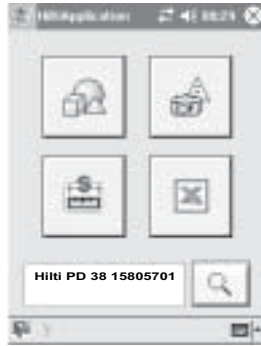

3. On successful connection between PDA/MDA and PD 38 the display of the PDA/MDA changes to the start-up display of the Hilti PD 38 applications and shows the serial number of the connected PD 38 in the lower window.



### 9.3 Measuring using Bluetooth connection to PDA/MDA

#### -NOTE-

During an active Bluetooth connection all PD 38 on-board functions such as area, volume, plus and minus are disabled. The  symbol indicates an active Bluetooth connection.

Distance measurement functions using the PDA/MDA are shown either with the  icon or with the  icon.

Distance measurement can always be triggered from the PDA/MDA if one of above symbols is available or by pressing the measuring button  on the PD 38 laser range meter.

## 10. PDA/MDA Windows CE with Hilti PD 38 application

The Hilti PD 38 application is installed on a PDA/MDA as described in chapter “9.1.2 Installation of Hilti PD 38 application software on a PDA/MDA”. The program contains four major functions, Image Sketch, Line Draw, Data Table and Formulary. The measurements are transferred to the particular function by wireless communication – all measurements can also be entered manually.

### -NOTE-

Further instructions about the separate functions can be found in the help texts for the particular function on the PDA/MDA.

#### 1. “Image Sketch”

Some PDAs and most MDAs are equipped with a digital camera which allows photos to be taken of a particular object on the spot, e.g. window, door, room, etc. Existing digital images can also be transferred to the PDA/MDA. Measured lengths, shown as lines with dimensions, can be added directly to the photos taken on the spot with the PDA/MDA or those transferred from the PC.

These photos with measurements can then be printed out or transferred to the PC for further use.

Using an MDA, the photos can be sent as an E-mail from the photo location, for example, to an office.

All relevant output formats, e.g. bitmap (\*.bmp) or JPEG (\*.jpg) can be transferred to the PC.

#### 2. “Line Draw”

This drawing function creates outline plans – combining measuring and scale drawing – on the spot.

Other possible uses are the design and drawing of non-rectangular objects and features.

The calculation of the area of enclosed geometrical figures is also possible, even when several are joined together.

### All common CAD output formats are supported for transfer to the PC

- Felixcad (\*.flx)
- AutoCad DXF (\*.dxf) for release 12 up to release 14 and AutoCad 2000/2002
- AutoCad Format (\*.dwg) for release 12 up to release 14 and also AutoCad 2000/2002

### All drawings can also be transferred as pixel data to the PC

- Bitmap (\*.bmp)
- JPEG (\*.jpg)

This allows the drawings to be displayed on a PC without a CAD system.

#### 3. “Data Table”

The Data Table function creates a table fully compatible with Windows Excel, with measurements entered directly in the appropriate cells.

However, measurements are activated (from the PDA/MDA or from the PD 38) only when the “Hilti Measuring Interface” in the lower right-hand window has been activated.

Once active, the  symbol is shown in the lower section of the PDA/MDA display.

### -NOTE-

Take note of the units used in Excel as these are not saved.

### **Different options exist when using the data table**

- The data table can be used with the cells simply containing measurements, without any line or column description.
- The structure of the table can be established on the PDA/MDA, i.e. the lines and columns are pre-defined according to the measurement needs and the measurements entered into the respective cells.
- The structure of the table can be defined and established in Windows Excel on the PC, i.e. a relevant structured measurement table fully pre-defined on the PC. This can also contain formats and formulas which can be used as checks on the spot.

### **-NOTE-**

Measurements initiated from the PD 38 are displayed on the PDA only when the Hilti Measuring Interface is active.

On completion of the measurements, the table can be transferred to the PC for further use.

#### **4. “Formulary”**

The functions of the formulary serve to assist with less common measuring tasks, e.g. measuring length at inaccessible places, angle and area determinations of non-rectangular areas and much more ...

Measurements are transferred directly to the relevant location within the function. Measurements can also be entered manually. The user is guided step by step by the graphical user interface.

List of functions:

- Area computations
- Volume computations
- Indirect distance measurement using Pythagorean function (3 options)
- Circle computations (area and circumference)
- Inclination computations (roof slope, pipe slope, etc ... in inaccessible places)
- Minimum and maximum measurements for diagonals and much more
- Average computations from eight consecutive measurements

Computation results can be copied for further use in other programs, as far as this option exists.

## **11. Data transfer from PDA/MDA to PC**

Data is transferred between the PDA/MDA and the PC using the Windows Active Sync software. It is essential that Active Sync is previously installed on the PC and a connection established between the PDA/MDA and the PC.

The exchange of data files between the PC and PDA/MDA is carried out using the “Copy” and “Insert” functions.

The data must be saved in the correct format before it can be transferred from the PDA/MDA to the PC.

- Data from “Image sketch” must be saved in an appropriate folder in the \*.bmp or \*.jpg format.
- Data from “Line draw” must be stored in one of the many optional data formats.
- Data from “Data table” is already saved in the Windows Excel \*.xls format.



**Example of data transfer from PDA/MDA to PC**

1. Place the PDA/MDA in the docking station and switch it on.
2. For access to the data memory in the PDA/MDA select “**File**” and then “**Search**” in the Active Sync window.
3. The complete contents of data memory in the PDA/MDA are then displayed.
4. Select the applicable folder and then the file to be transferred to the PC.
5. Mark the file and then select “**Copy**”.
6. Select the applicable PC drive, e.g. drive “C:” from the bar at the top of the Active Sync window.
7. Then select the folder on the PC drive into which the file from the PDA/MDA is to be transferred.
8. Select “**Insert**” and the applicable file will then be transferred from the PDA/MDA to the PC.

The procedure for transferring data from the PC to the PDA/MDA is very similar, the main difference being that the file is first selected on the PC before being transferred to the PDA/MDA.

**12. Calibration and adjustment****12.1 Calibration**

Inspection and testing of the range meter for users (companies) certified in accordance with ISO 900X...

You may carry out the inspection, and testing of the PD 38 laser range meter as specified in ISO 900X... by yourself. (See ISO 17123-4 Field Process for Accuracy Examinations of Geodetic Instruments: Part 6, Close-range Opto-electrical Range Meters.)

Select a readily accessible measuring distance of a known length approx. 1 to 5 meters (3–15 ft) long which does not vary with time and take five measurements of the same distance.

Determine the mean of the deviations to the known distance. This value should be within the specific accuracy tolerance for the range meter.

Keep a record of this value and note the time for the next test.

Repeat this check measurement at regular intervals as well as before and after important measuring tasks.

Apply a sticker to the PD 38 documenting this control of the measuring, inspection and test equipment for the range meter and keep a record of the entire control process, inspection procedure and the results.

Please refer to the technical data contained in the operating instructions and the information concerning measuring accuracy.

## 12.2 Adjustment

For optimum accuracy, have the laser range meter adjusted at a Hilti workshop where accurate adjustment of the range meter will be confirmed with a calibration certificate.

## 12.3 Hilti calibration service

We recommend that you undertake a regular check of the laser range meter through the Hilti calibration service in order to verify its reliability in accordance with standards and legal requirements.

The Hilti calibration service is available at all times, but a check at least once a year is recommended.

As a part of the Hilti calibration service, it is verified that on the day of the check the specifications of the range meter comply with the technical information given in the operating instructions.

If there are deviations from the manufacturer's specifications, the range meter will be re-adjusted. After the check and adjustment, a calibration sticker will be applied to the range meter and it will be verified in writing in a calibration certificate that the range meter functions in compliance with the manufacturer's specification.

Calibration certificates are always required for companies certified in accordance with ISO 900X...

Your local Hilti contact/representative will be pleased to provide further information.

## 13. Care and maintenance

### 13.1 Cleaning and drying

- Blow dust off the lens.
- Do not touch the lens with your fingers.
- Use only a clean, soft cloth for cleaning. If necessary, slightly moisten the cloths with pure alcohol or a little water.

#### -NOTE-

- Do not use any other liquids as these might damage the plastic parts.
- Observe the temperature limits when storing your equipment. This is particularly important in winter or summer, especially if the equipment is kept inside a vehicle (storage temperatures:  $-30\text{ }^{\circ}\text{C}$  to  $+70\text{ }^{\circ}\text{C}$ / $-22\text{ }^{\circ}\text{F}$  to  $+158\text{ }^{\circ}\text{F}$ ).
- Replace damaged parts.

### 13.2 Storage

- Remove the range meter from its case if it has become wet. Clean the range meter, carrying case and accessories. Re-pack the equipment only when it is completely dry.
- Check the accuracy of the equipment before it is used after a long period of storage or transportation.
- Remove the batteries if the range meter is not going to be used for a considerable time. The range meter can be damaged by leaking batteries.

### 13.3 Transportation

Use either the original Hilti cardboard box the tool was delivered in or packaging of equivalent quality for transporting or shipping your equipment.



#### -NOTE-

Always remove the batteries before shipment.

## 14. Disposal

### -CAUTION-

Improper disposal of the equipment may have serious consequences:

Burning plastic parts/components generates toxic fumes which may present a health hazard.

Batteries might explode if damaged or exposed to very high temperatures. This could cause poisoning, burns, acid burns or environmental pollution. Careless disposal might permit unauthorized and improper use of the equipment, possibly leading to serious personal injury, injury to third parties and pollution of the environment.



Most of the materials from which Hilti range meters are manufactured can be recycled. A prerequisite for recycling is proper separation of the materials. In many countries, Hilti has already made arrangements for old range meters (and other tools and machines) to be taken back for recycling. Ask Hilti customer service or your local Hilti representative for further information.



Dispose of batteries in accordance with national regulations



Only for EU countries  
Disposal of electric tools together with household waste is not permissible!

In observance of European Directive 2002/96/EC on waste electrical and electronic equipment and its implementation in accordance with national law, electric tools that have reached the end of their life must be collected separately and returned to an environmentally compatible recycling facility.

## 15. Warranty

Hilti warrants that the product supplied is free of defects in material and workmanship. This warranty is valid as long as the product is operated and handled correctly, cleaned and serviced properly and in accordance with the Hilti operating instructions, all warranty claims are made within 12 months from the date of the sale (invoice date), and the technical system is maintained. This means that only genuine Hilti consumables, components and spare parts may be used in the product. This warranty provides the free-of-charge repair or replacement of defective parts only. Parts requiring repair or replacement as a result of normal wear and tear are not covered by this warranty.

**Additional claims are excluded, unless stringent national rules prohibit such exclusion. In particular, Hilti is not obligated for direct, indirect, incidental or consequential damages, losses or expenses in connection with, or by reason of, the use of, or inability to use the product for any purpose. Implied warranties of merchantability or fitness for a particular purpose are specifically excluded.**

Send the product and/or related parts immediately upon discovery of the defect to the address of the local Hilti marketing organization for repair or replacement.

This constitutes Hilti's entire obligation with regard to warranty and supersedes all prior or contemporaneous comments and oral or written agreements concerning warranties.

## **16. FCC statement (applicable in US)**

### **-WARNING-**

This equipment has been tested and has been found to comply with the limits for a class B digital device, pursuant to part 15 of the FCC rules.

These limits are designed to provide reasonable protection against harmful interference in a residential installation. This equipment generates, uses, and can radiate radio frequency energy and, if not installed and used in accordance with the instructions, may cause harmful interference to radio communications. However, there is no guarantee that interference will not occur in a particular installation. If this equipment does cause harmful interference to radio or television reception, which can be determined by turning the equipment on and off, the user is encouraged to try to correct the interference by one or more of the following measures:

- Re-orient or re-locate the receiving antenna.
- Increase the separation between the equipment and receiver.
- Connect the equipment to an outlet on a circuit different from that to which the receiver is connected.
- Consult the dealer or an experienced TV/radio technician for assistance.

This device complies with Part 15 of the FCC Rules and RSS-210 of IC. Operation is subject to the following two conditions:

1. this device may not cause harmful interference, and
2. this device must accept any interference received, including interference that may cause undesired operation.

## 17. Troubleshooting

No connection between PDA/MDA and PC	<ul style="list-style-type: none"> <li>• Check the cable connection between docking station and PC</li> <li>• Restart PC</li> </ul>
No connection between PDA/MDA and PD 38 when Hilti PD 38 application is started	<ul style="list-style-type: none"> <li>• Switch on the PD 38</li> <li>• Switch on Bluetooth on the PD 38</li> <li>• Reduce distance between PDA/MDA und PD 38</li> <li>• Switch off Bluetooth on PDA/MDA and restart Hilti PD 38 application on PDA</li> <li>• Reset PDA</li> </ul>
Hilti PD 38 application software establishes no connection to PD 38 after installation	<ul style="list-style-type: none"> <li>• Reset PDA</li> <li>• Switch on the PD 38</li> <li>• Check if PDA is equipped with Bluetooth</li> <li>• Reduce distance between PDA/MDA und PD 38</li> </ul>
No measurements transferred but PDA and PD 38 are connected	<ul style="list-style-type: none"> <li>• Check serial numbers to verify connection to the right PD 38</li> <li>• Reduce distance between PDA/MDA und PD 38</li> <li>• Reset PDA</li> </ul>
Data is transferred but no longer visible	<ul style="list-style-type: none"> <li>• Check the folders where files are stored</li> <li>• Check folder before copying</li> </ul>
PDA/MDA doesn't react	<ul style="list-style-type: none"> <li>• Reset PDA</li> </ul>
No measurements in data table	<ul style="list-style-type: none"> <li>• Activate "Hilti Measuring Interface"</li> </ul>

## 18. Bluetooth declaration of compliance

This product is qualified in accordance with Bluetooth identifier B01839.

Product information plate

**HILTI**  
Hilti - registered trademark of Hilti Corporation,  
Schaan, LI  
**Type: PD 38**

**CAUTION**  
LASER RADIATION - DO NOT  
STARE INTO BEAM  
720-790nm/0.95mW max.  
CLASS II LASER PRODUCT

**AVOID EXPOSURE**  
Laser radiation is emitted  
from this aperture

**2**

DIN EN 60825-1:2003  
Made in Germany  
N4025

319876 - A405.05

CE  
This device complies with  
Part 15 of the FCC Rules  
and RSS-210 of IC.  
FCC ID: SDL-PD38XR01 IC: 5228A-PD38XR01

19. EC declaration of conformity

Designation: Laser range meter  
Type: PD 38  
Year of design: 2005

In conformance with **CE**

We declare, on our own responsibility, that this product complies with the following standards or directives: EN 301489-17; EN 300328 and EN 60950-1; 2001 according to the stipulations of the directive 89/336/EEC.

Hilti Corporation

Matthias Gillner  
Head BU  
Measuring Systems  
11/2005

Dr. Heinz-Joachim  
Schneider  
Executive Vice President  
BA Electric Tools &  
Accessories  
11/2005