

PROSCAN®

USER'S MANUAL

Before using the TV, please read this manual thoroughly,
and retain it for future reference.



37LC30S60

English
French
Spanish

PART NO. IES090319

Federal Communications Commission Statement

NOTE

The manufacturer is not responsible for any radio or tv interference caused by unauthorized modifications to this equipment. Such modifications could void the user's authority.

NOTE





This equipment has been tested and found to comply with the limits for a class B digital Device, pursuant to part 15 of the FCC Rules. These limits are designed to provide reasonable protection against harmful interference in a residential installation. This equipment generates, uses and can radiate radio frequency energy and, if not installed and used in accordance with the instructions, may cause harmful interference to radio Communications. However, there is no guarantee that interference will not occur in a particular installation. If this equipment does cause harmful interference to radio or television reception, which can be determined by turning the equipment off and on, the user is encouraged to try to correct the interference by one or more of the following Measures:

1. Reorient or relocate the receiving antenna.
2. Increase the separation between the equipment and the receiver.
3. Connect the equipment into an outlet on a circuit different from that to which the receiver is connected.
4. Consult the dealer or an experienced radio/TV technician for help.

CONTENTS

Important safety instructions	3
Preparation for using your new TV	5
Base installation instruction.....	5
Learning about your TV.....	6
View the front connection panel.....	6
View the back connection panel.....	6
Selecting a location for the TV.....	7
Connection to other devices.....	7
The side panel connection.....	7
The back panel connection.....	8
Connecting your TV.....	9
Connecting to an antenna.....	9
Connecting to A/V equipments.....	9
Service jack.....	9
Connecting component devices (DVD/DVR).....	9
Connecting HDMI.....	10
Connecting computer.....	10
Connecting audio.....	10
Connecting to a cable converter box.....	10
Using the remote control	12
Preparing the remote control for use.....	12
Learning about the remote control.....	13
Understanding the TV features	14
Basic operation	14
Menu operation.....	14
Video mode adjustment.....	17
Audio mode adjustment.....	17
Setup.....	18
Parental control.....	19
Appendix	21
Cleaning and care.....	21
Troubleshooting.....	22
Wall-mounting Bracket Installation	23
Specifications.....	25

SAFETY CLASS :This is an IEC safety class I product and it must be grounded for safety.

 <div style="text-align: center;"> <p>CAUTION</p> <p>RISK OF ELECTRIC SHOCK</p> <p>DO NOT OPEN</p> </div> 	 <p>The lightning flash symbol with an arrowhead inside a triangle alerts the user about an un-insulated dangerous voltage that may be of sufficient magnitude to constitute a risk of electric shock.</p>
<p>CAUTION: TO REDUCE THE RISK OF AN ELECTRIC SHOCK, DO NOT REMOVE THE COVER (OR BACK). THERE ARE NO USER SERVICEABLE PARTS INSIDE. FOR ANY REQUIRED SERVICING, PLEASE CONTACT QUALIFIED SERVICE PERSONNEL.</p>	 <p>The flash with the symbol of an exclamation point inside a triangle alerts the user about important operating and maintenance instructions related to the product.</p>

CAUTION: CHANGES OR MODIFICATIONS NOT EXPRESSLY APPROVED BY THE PARTY RESPONSIBLE FOR COMPLIANCE WITH THE FCC RULES COULD VOID THE USERS AUTHORITY TO OPERATE THIS EQUIPMENT.

WARNING: TO PREVENT FIRE OR SHOCK HAZARD, DO NOT EXPOSE THIS APPLIANCE TO RAIN OR MOISTURE.

Important safety instructions

1. Read these instructions
2. Keep these instructions
3. Heed all warnings
4. Follow all instructions
5. Do not use this apparatus near water
6. Clean only with dry cloth
7. Do not block any ventilation openings
8. Do not install near any heat sources
9. Do not defeat the safety purpose of the polarized or grounding-type plug
10. Protect the power cord from being damaged particularly at plugs, convenience receptacles, and at points in which they exit from the apparatus.
11. Only use attachments/accessories specified by the manufacturer.
12. Use only with cart, stand, tripod, bracket, or table specified by the manufacturer or sold with the apparatus. When a cart is used, use caution when moving the cart/apparatus combination to avoid injury from tip-over.
13. Unplug this apparatus during lightning storms or when unused for long periods of time.
14. Refer all servicing to qualified service personnel. Servicing is required when the apparatus has been damaged in any way, such as when the power-supply cord or plug is damaged, when liquid has been spilled or when objects have fallen into the apparatus, or when the apparatus has been exposed to rain or moisture, does not operate normally, or has been dropped.



S3126A

Important safety instructions

- 15. POWER SOURCE:** This TV should be operated only from the type of power source indicated on the marking label. If you are not sure of the type of power supply to your home, consult your appliance dealer or local power company . For TVs intended to operate from battery power, or other sources, refer to the operating instructions.
- 16. POWER CORD PROTECTION:** Power-supply cords should be routed so that they are not likely to be walked on or pinched by items placed upon or against them, paying particular attention to cords at plugs, convenience receptacles, and the point where they exit from the appliance.
- 17. OUTDOOR ANTENNA GROUNDING :** If an outside antenna or cable system is connected to the TV, be sure the antenna or cable system is grounded to provide some protection against voltage surges and built-up static charges. Section 810 of the National Electrical Code, ANSI/NFPA NO.70, provides information with respect to proper grounding of the mast and supporting structure, grounding of the lead-in wire to an antenna discharge unit , size of grounding conductors, location of antenna discharge unit, connection to grounding electrodes, and requirements for the grounding electrode. (Fig.A)
- 18. LIGHTNING:** For added protection for this TV receiver during a lightning storm, or when it is left unattended and unused for long periods of time, unplug it from the wall outlet and disconnect the antenna or cable system. This will prevent damage to the TV due to lightning and power line surges.
- 19. POWER LINES:** An outside antenna system should not be located in the vicinity of overhead power lines, or other electric light or power circuits, or where it can fall into such power lines or circuits. When installing an outside antenna system, extreme care should be taken to keep from touching such power lines or circuits as contact with them might be fatal.
- 20. OVERLOADING:** Do not overload wall outlets and extension cords as this can result in a risk of fire or electric shock.
- 21. OBJECT AND LIQUID ENTRY:** Never push objects of any kind into this TV through openings as they may touch dangerous voltage points or short out parts that could result in fire or electric shock. Never spill liquid of any kind into the TV.
- 22. SERVICING:** Do not attempt to service this TV yourself as opening or removing covers may expose you to dangerous voltage or other hazards. Refer all servicing to qualified service personnel.
- 23. REPLACEMENT PARTS:** When replacement parts are required, be sure that the service technician uses replacement parts with the same characteristics as the original parts specified by the manufacturer. Unauthorized substitutions may result in fire, electric shock, injury to persons or other hazards.
- 24. SAFETY CHECK:** Upon completion of any service or repairs to this TV, ask the service technician to perform routine safety checks to determine that the TV is in proper operating condition.
- 25.** The apparatus should not be exposed to any dripping or splashing, and no objects filled with liquids (such as a vase) should be placed on the apparatus.
- 26. WARNING:** Plug the power cord into a power outlet where access to a power cord connector is readily accessible, in case if the power needs to be immediately disconnected.
- 27. ATTENTION:** This device complies with Part 15 of the FCC Rules. Operation is subject to the following two conditions: (1) this device may not cause harmful interference, and (2) this device must accept any interference received, including interference that may cause undesired operation.
- 28. CAUTION:** To reduce the risk of electric shock, the grounding of the center pin of this plug must be maintained.

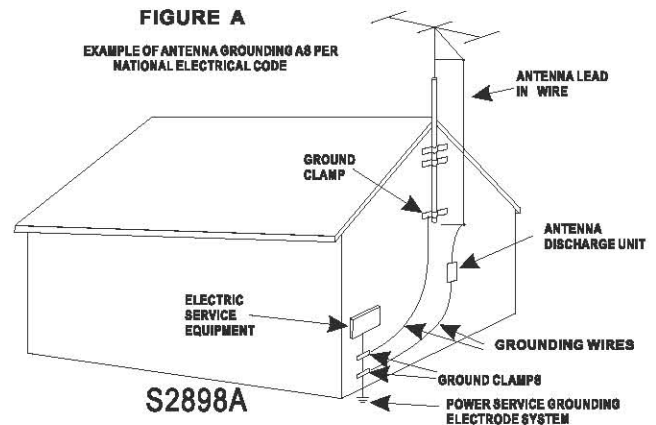

Preparation for using your new TV

Base installation instruction

1. Lay a cloth or other soft material that can afford adequate weight on a flat table to avoid damage to the LCD screen.
2. Put the TV back upward and the LCD screen downward and keep it flat on the table-board.
3. Take out the base and insert it into the installing slot in the lower part of the TV in the arrow direction as illustrated in the figure.
4. Fasten the base and the TV set together with the 4 screws provided.

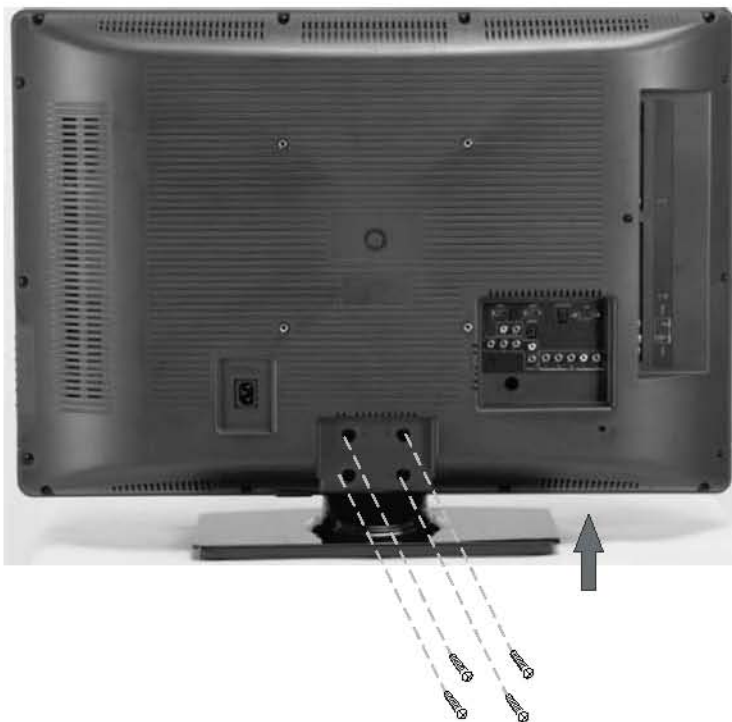

Preparation for using your new TV

Learning about your TV

Operate your TV via the buttons located on the front or side of cabinet or use the remote control. The terminals located on back of TV provides all the connections from other equipment to TV.

View the front connection panel

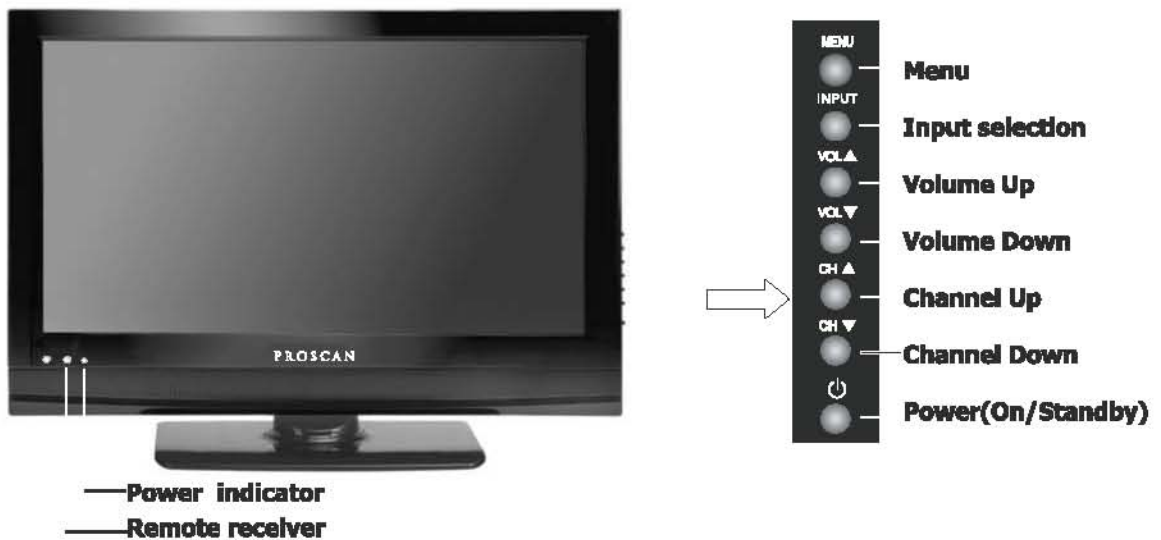

View the back connection panel

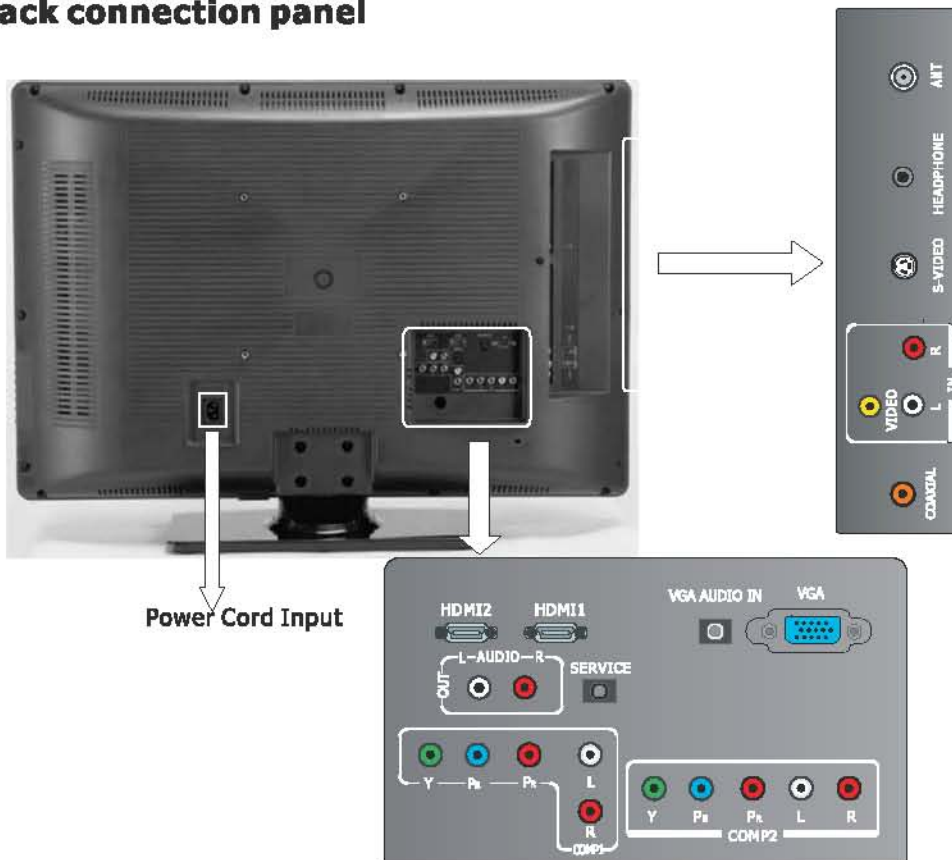

Preparation for using your new TV

Selecting a location for the TV

1. Place the TV on an open stand in a location where light does not directly hit the screen.
2. Place the TV far enough from the walls to allow proper ventilation. Inadequate ventilation may cause overheating, which may damage the TV.

NOTE: Please contact a local dealer for wall mounting.

Connection to other devices

The side panel connection

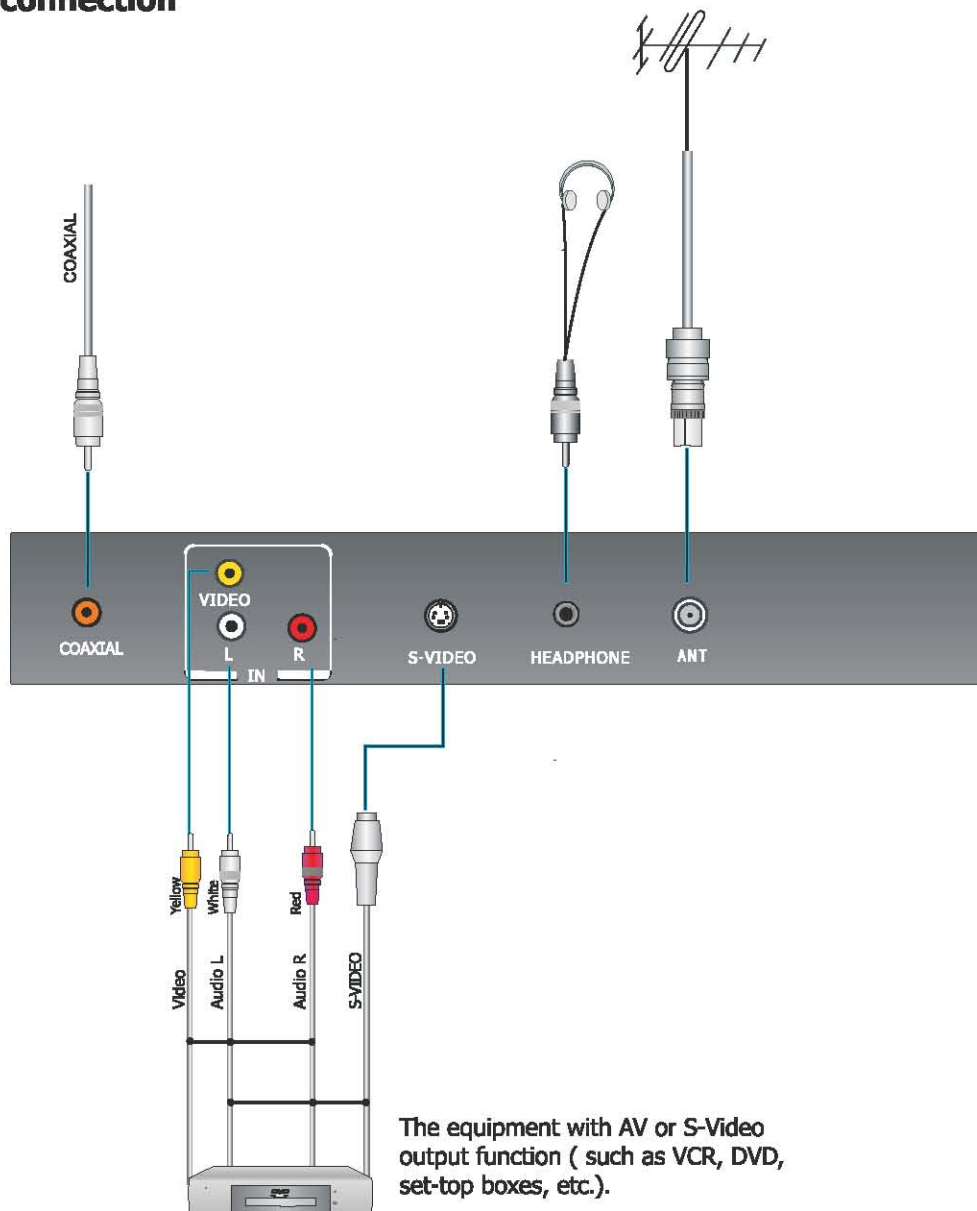

Preparation for using your new TV

The back panel connection

The equipment with HDMI output jack
(such as DVD players, set-top boxes, etc.).

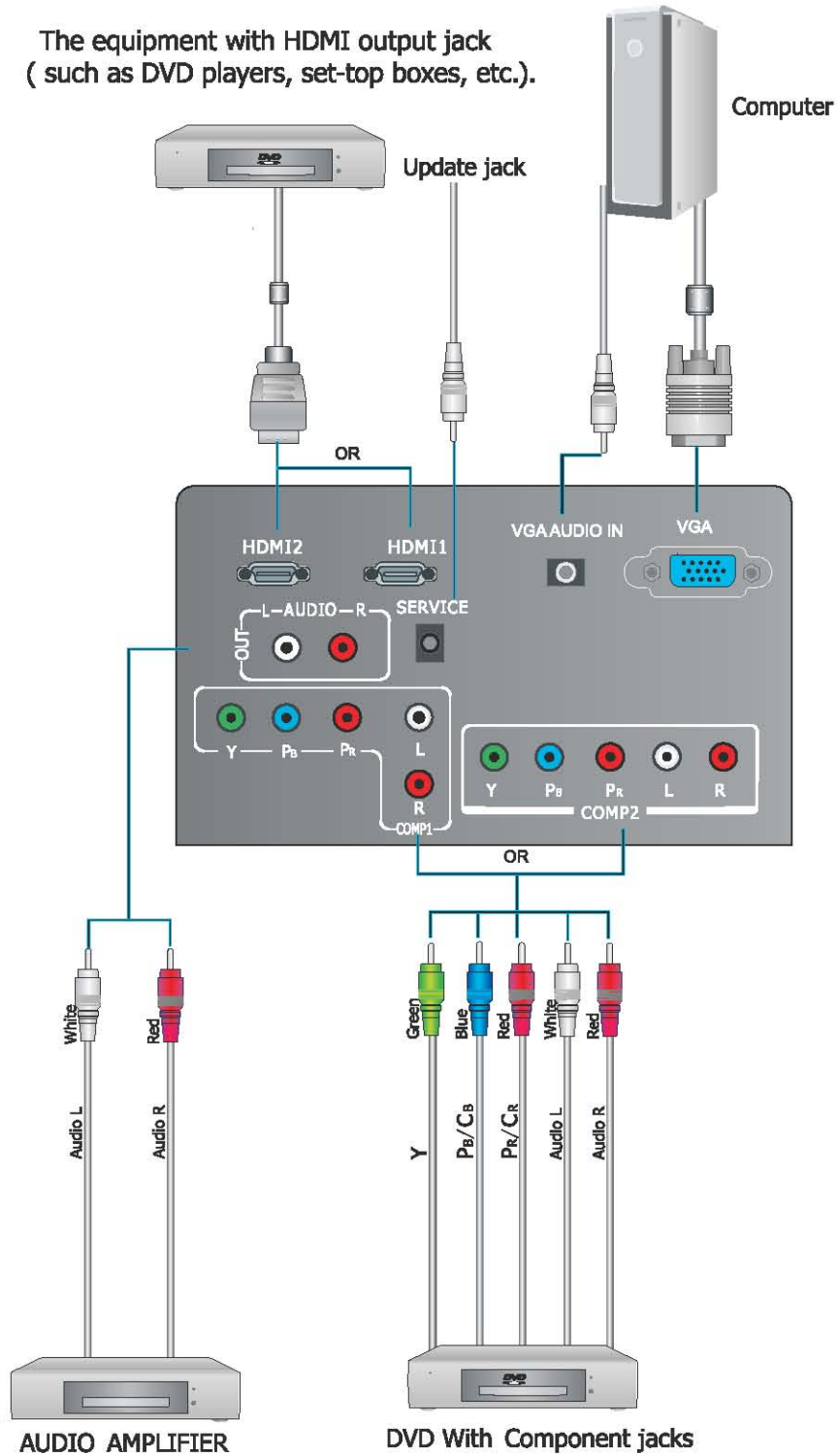

Preparation for using your new TV

Connecting your TV

Caution: Do not plug in the TV until you have finished connecting all of your equipment.

Connecting to an antenna

To enjoy the television program transmitted by your local TV station, you need an indoor or outdoor antenna (not supplied). An outdoor antenna is necessary for superior picture quality. If you are a subscriber of your local cable network net, the outdoor or indoor antenna is not needed. Connect the equipment as shown below.

Side Panel

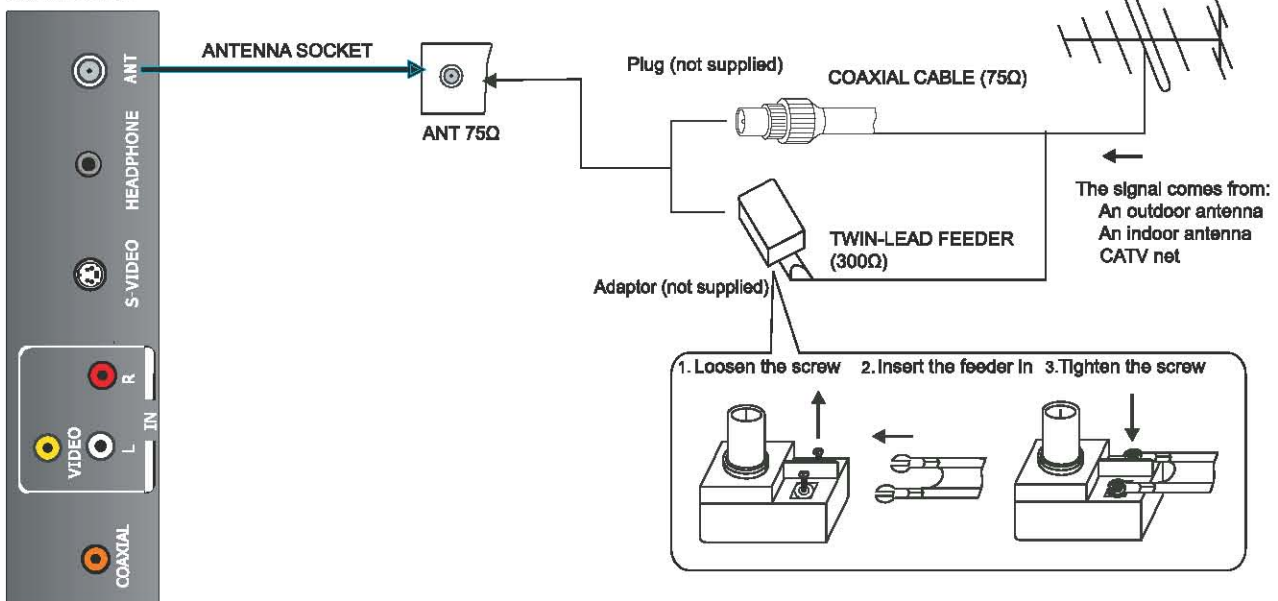

Connecting Cable/ Satellite and A/V Equipment

To enjoy the multimedia features, you can connect your TV to A/V equipment such as VCR, DVD, Digital Video Recorder (DVR), Cable Set Top box, Satellite receiver, BluRay Camcorder, Audio amplifiers, etc., and select signal source using your remote control.

Connect RCA audio cables to "R -AUDIO - L" on the rear of your set and the other ends to corresponding audio out connectors on the A/V device.

NOTE: 1. Headphones are not included.

2. No sound will be heard from the main unit speakers when a headphone mini-plug is connected into the headphone jack.

Service jack

Connector for service only (do not connect any equipment here).

Connecting component devices (DVD/DVR)

Connect Component video and audio cables to Component inputs ("PR/CR", "PB/CB", "Y") on the rear of your set and the other ends to corresponding component video out connectors on the DVR or DVD.

The Y, PB/CB and PR/CR connectors on your component devices (DVR or DVD) are sometimes labeled Y, B-Y and R-Y or Y, CB and CR (Colors for inputs and cables must correspond to both devices).

NOTE: Some devices such as a DVR or DVD players require 'Component/YPBPR' signal to be set via output in the devices settings. Please consult your device user manual for instructions.

Preparation for using your new TV

Connecting HDMI

Supports digital connections between HDMI - enabled AV devices such as (DVRs, DVD, BluRay, HDDVD, AV receivers and digital devices). No sound connection is needed for an HDMI to HDMI connection.

NOTE: Some devices such as a DVR or DVD players require a HDMI signal to be set via the output in the devices' settings. Please consult your device user manual for instructions.

What is HDMI?

HDMI, or high-definition multimedia interface, is a next-generation interface that enables the transmission of digital audio and video signals using a single cable without compression.

"Multimedia interface" is a more accurate name for it because it allows multiple channels of digital audio (5.1 channels). The difference between HDMI and DVI is that the HDMI device is smaller in size, has the HDCP (High Bandwidth Digital Copy Protection) coding feature installed, and supports multi - channel digital audio.

Use the HDMI terminal for HDMI connection to a compatible device.

If your external device has DVI only, you should use a DVI-to-HDMI cable(or adapter) for the connection, and the "R -AUDIO - L" terminal on DVI for sound output.

Connecting Computer

Connect the D- Sub cable to "VGA (VGA IN)" on the rear of your set and the other end to the Video Card of your computer.

Connect the stereo audio cable to "VGA AUDIO IN" on the rear of your set and the other end to "Audio Out" of the sound card on your computer.

This device may not be compatible with all PC video/graphic cards.

Connecting AUDIO

Connect RCA audio cables to "R -AUDIO - L" on the rear of your set and the other ends to corresponding audio in connectors on the Amplifier or DVD Home Theater.

Connecting to a cable converter box

This television has an extended tuning range and can tune most cable channels without using a cable converter box. Some cable companies offer premium pay channels in which the signal is scrambled. Descrambling these signals for normal viewing requires the use of a descrambler device which is generally provided by the cable company.

Preparation for using your new TV

- **For subscribers to Basic Cable TV Service**

For basic cable service not requiring a Converter/Descrambler box, connect the CATV 75 ohm Coaxial Cable directly into the Antenna Jack on the back of the television.

- **For subscribers to Scrambled Cable TV Service**

If you subscribe to a cable service which requires the use of a Converter/Descrambler box, connect the incoming cable to the Converter/Descrambler box and connect the output of the box to the Antenna Jack on the back of the television. Follow the connections as shown below. Set the television to the output of the Converter/Descrambler box (usually channel 3 or 4) and use the Converter/Descrambler box to select channels.

- **For Subscribers to Unscrambled Basic Cable with Scrambled Premium Channels**

If you subscribe to a cable service in which basic cable channels are unscrambled and premium channels require the use of a Converter/Descrambled box, you may wish to use a two-set signal splitter (sometimes referred to as a two-set coupler) and an A/B Switch box from the cable installer or an electronics supply store. Follow the connections shown below. With the switch in the B position, you can directly tune any unscrambled channels on your TV. With the switch in the A position, tune your TV to the output of the Converter/Descrambler box (usually channel 3 or 4) and use the box to tune scrambled channels.

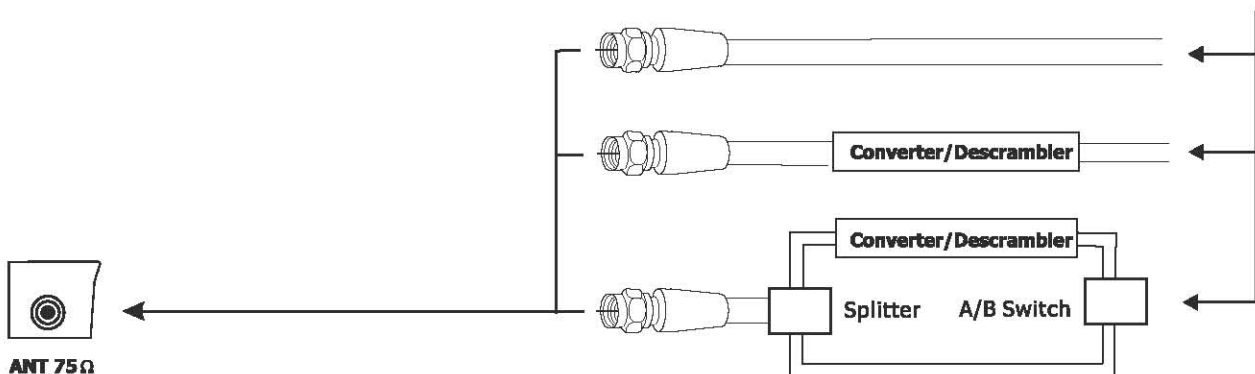

Note:

When you use a converter box with your TV, there may be features that you cannot program when using the remote control.