

Using the remote Control

Installing batteries

Installing the remote control batteries

1. Open the battery cover on the back of the remote control.
2. Install two AAA size(1.5V) batteries. Match the "+" and "-" signs on the batteries to the signs on the battery compartment.
3. Close the battery cover.

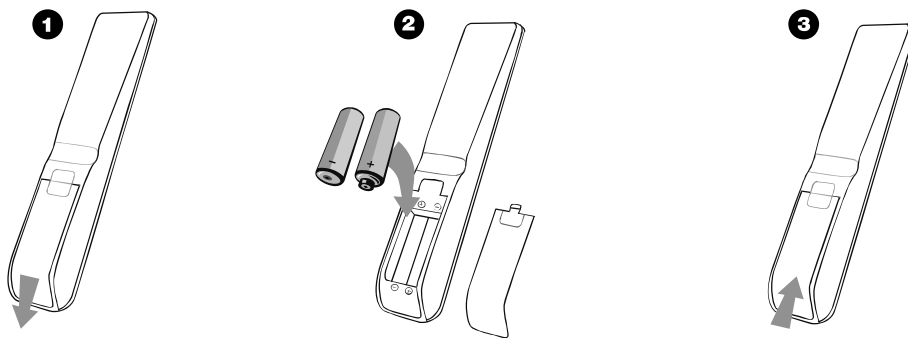

Note:

1. Dispose of your batteries in a designated disposal area. Do not throw the batteries into fire.
2. Do not mix battery types or combine used batteries with new ones.
3. Remove depleted batteries immediately to prevent battery acid from leaking into the battery compartment.
4. If you do not intend to use the remote control for a long time, remove the batteries.
5. The effective range of remote control is suggested below.

Remote control range

1. The remote control distance: 8 meters(26.2 feet) in front of the TV set.
2. The remote control angle: taking the television infrared light receiver window as an apex, 6 meters (19.7 feet) away, its controlled angle (left to right) is within 30 degrees, while the vertical angle (up to down) is within 30 degrees.

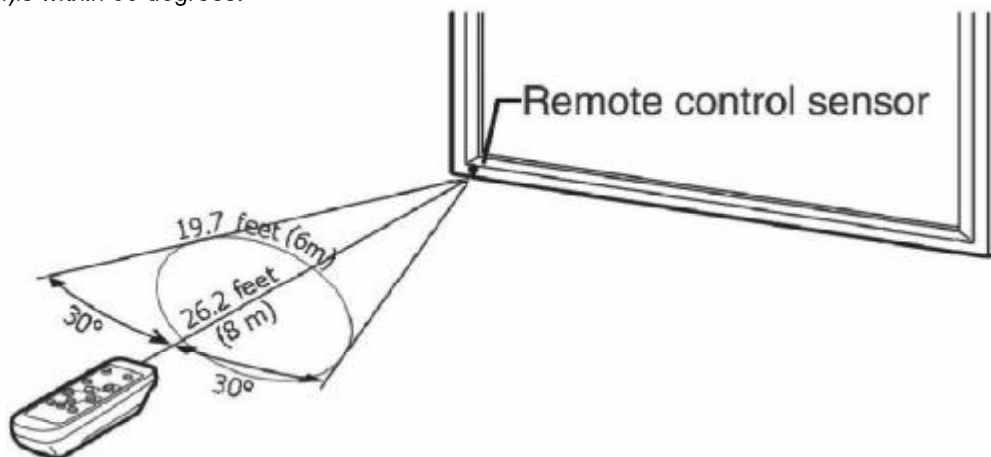

Using the Remote Control

Learning about the remote control panel □

Remote Control Panel	Buttons instructions
	<ol style="list-style-type: none"> (1) Power indicator. (2) Power On/Off. (3) INPUT: Switch among TV, Video, S-Video, Component, HDMI and VGA. (4) 1,2,... numbers: For direct channel access. (5) Last: Return to previous channel. (6) — : Select digital channels. (7) PICTURE: Picture Mode selecting. (8) SOUND: Sound Mode selecting. (9) DISPLAY: Display current status information. (10) MUTE: Mute the sound. (11) VOL ▲/▼: Volume increase/Volume decrease. (12) CH ▲/▼: Next channel/Previous channel. (13) MENU: Display the main menu/Back menu display. (14) EXIT: On screen display (OSD) menu exit. (15) ENTER: Enter or confirm the operation/return to the previous menu. ▲/▼/◀/▶: Up/Down/Left/Right operation. (16) MTS/SAP: Multi-channel television sound selection. (17) ASPECT: Select screen mode. (18) CCD: Closed caption decoder function. (19) GUIDE: ATSC tuners feature the Electronic Program Guide (EPG) function. (20) Sleep: Set the sleep timer. (21) TIME: Display the current timer. (22) Electronic Program Guide(EPG) function: After pressing the "GUIDE" button in the digital TV channel option, the 4 same color buttons will appear with explanations in the OSD. Follow the steps illustrated in the OSD. (23) NOT supported in this TV. <p>Note:The design of the remote control is subject to change and may be different from the actual one. Those buttons without comment have no relations with this TV.</p>

Using the Remote Control

Quick starts

Basic Operation

Power ON/OFF

1. Connect the TV to a power outlet. If the power indicator is red, it means that the TV is switched off. Press the Power button on the front control or on the remote control to switch on the TV. Once the Power button is switched on, the power indicator will be displayed as blue. Several seconds later, the TV picture will be displayed on the screen.
2. Press the Power button on the front control or on the remote control to turn the TV off temporarily.
3. Always remove the AC power plug from the outlet when not using this TV for a long period of time.

Signal source selection

Press the [INPUT] button to select TV, AV, S-Video, Component, VGA and HDMI inputs. There are two ways to select the source: One is to press the [INPUT] button continuously, while the other is to use the [ARROW] and [ENTER] buttons to confirm the source.

Select channels

Please use [CH \wedge / CHV] button on the remote panel to select channels. [CH \wedge] indicates channel number up; [CHV] indicates channel number down. Press [CH \wedge / ChV] button on the side panel of the TV to select the channels. If you want to choose any of the skipped channels, press the number directly.

Use [Mute] button

Press the [Mute] button to mute the sound. Press the [Mute] button again to resume the sound.

Select picture modes

Press the [PICTURE] button to select the picture mode from four options: Standard, Cinema, User or Vivid. You can adjust the picture mode based upon your personal preference.

Select sound modes

Press the [AUDIO] button to select sound modes from Standard, Speech, User or Music.

Select screen modes

Press the [ASPECT] button to select from five zoom modes: Wide, Normal, Zoom, Cinema or Dot-to-Dot.

Use [GUIDE] button

Press the [GUIDE] button to display features of the ATSC program and the EPG function.

Use [DISPLAY] button

Press the [DISPLAY] button to view current source information.

Use [EXIT] button

Press the [EXIT] button to exit the OSD menu.

Using the Remote Control

Quick starts

Select channels by numbers

To select a channel: Press the channel number you would like to go to. For example, to select channel number 120, press buttons 1, 2 and 0, respectively and then press [ENTER] to confirm.

Use [MENU] button

Press the [MENU] button to display the TV OSD menu.

Use [LAST] button

Press the [LAST] button to return to the previous channel.

Use [ENTER] button

Press the [ENTER] button to select a particular item.

Adjust Volume

Press [VOL \wedge / VOLV] button to adjust the volume.

Use [CCD] button

Press the [CCD] button to change the CCD mode. Using this button will set the Closed Caption mode when viewing a DTV or TV channel.

Note: Set the default Closed Caption setting for all channels in the Menu. For ATV the options are CC1, CC2, CC3, CC4, TEXT1, TEXT2, TEXT3, TEXT4 or Off. For DTV, the options are from Service1 to Service6 or Off.

Use [MTS/SAP] button

Press the [MTS/SAP] button to change the sound mode (Mono, Stereo, SAP). This button will select the MTS options of Stereo, SAP, or Mono in TV mode, alternate audio channels, and when available, in DTV mode.

Use [SLEEP] button

Press the [SLEEP] button repeatedly to set the sleep time, which can be set to: 10 Mins, 20 Mins, 30 Mins, 40 Mins, 50 Mins, 60 Mins, 90 Mins, 120 Mins or Off.

Use [TIME] button

Press the [TIME] button to display the current time.

Changing the TV Settings

Using the Channel Menu

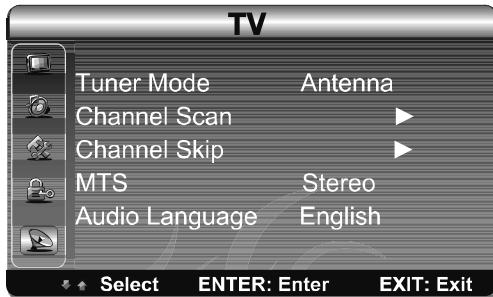

- 1 Press [MENU] button to display the main menu.
- 2 Press [▲/▼] button to select TV item.
- 3 Press [▶/OK] button to enter TV menu.
- 4 Press [▲/▼] button to select the option, press [▶/OK] button to enter or press [◀/▶] button to adjust the option.
- 5 Press the [Menu] button to close the menu.

You can adjust:

- Tuner Mode - Select the TV signal source. You can select Antenna or Cable.
- Channel Scan - Scans for channels that have signals and stores the channels information in memory.
- Channel Skip - Deletes a channel stored in memory. When you press CHA or CHV, your TV skips the channel you deleted. You can still tune to the channel using the number buttons on the remote control.
- MTS - Selects the sound mode. You can select Mono, Stereo, or SAP(Second Audio Program)
- Audio Language - Selects the audio language for a program.

Changing the TV Settings

Using the Video Menu

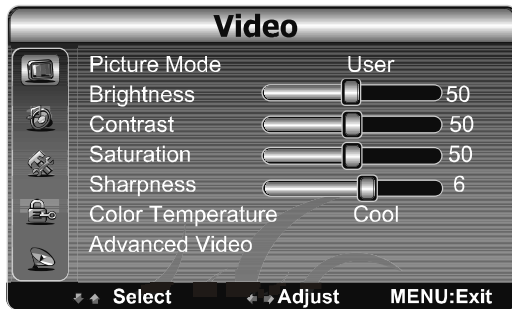

- 1 Press [MENU] button to display the main menu.
- 2 Press [▲/▼] button to select Video item.
- 3 Press [▶/OK] button to enter Video menu.
- 4 Press [▲/▼] button to select the option, press [▶/OK] button to enter or press [◀/▶] button to adjust the option.
- 5 Press the [Menu] button to close the menu.

You can adjust:

- Picture Mode - Adjusts the Picture Mode. You can select Standard, Cinema, User or Vivid.
- Brightness - You can increase or decrease the brightness of the picture. Increasing the brightness can add more light to dark areas of the picture, while decreasing the brightness can add more darkness to light areas of the picture.
- Contrast - You can increase or decrease the contrast of the picture. Increase the contrast to adjust the white areas of the picture or decrease the contrast to adjust the black areas of the picture.
- Saturation - Adjusts the intensity of the colors.
- Sharpness - You can increase the sharpness level for clearer images or decrease the sharpness level for smoother images.
- Color temperature - Changes the color temperature. You can select the color temperature from three options: Cool, Standard or Warm.
- Advanced Video - Accesses advanced video settings such as DNR, Adaptive Luma Control, Flesh Tone
 - ◇ DNR: It can optimize the picture signal from time and space; reduce the outside noise interference and return the pure initial signal. It has four ratings: Low, Standard, Strong and Off.
 - ◇ Adaptive Luma Control: According to the content of picture, it can adjust brightness automatically.
 - ◇ Flesh Tone: When this feature is "on" state, the TV could be the basis of image content, for color correction.

Changing the TV Settings

Using the Audio Menu

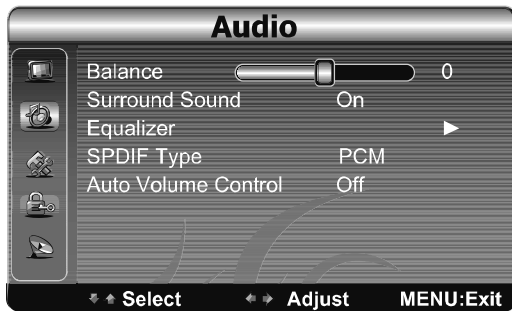

- 1 Press [MENU] button to display the main menu.
- 2 Press [▲/▼] button to select Audio item.
- 3 Press [▶/OK] button to enter Audio menu.
- 4 Press [▲/▼] button to select the option, press [▶/OK] button to enter or press [◀/▶] button to adjust the option.
- 5 Press the [Menu] button to close the menu.

The options are:

- Balance - Adjusts the volume of the left and right speakers.
- Surround Sound - Turns the surround sound effect on or off.
- SPDIF Type - Selects the SPDIF type. You can select PCM, Dolby Digital or Off.
- Auto Volume Control - Turns automatic volume control on or off. The option keeps the audio in a preset range to eliminate large spikes in volume.

Note: Via SPDIF Type, you can choose the digital audio out type. If Audio Volume Control is On, that means audio out control is activated.

Changing the TV Settings

Using the Setup Menu

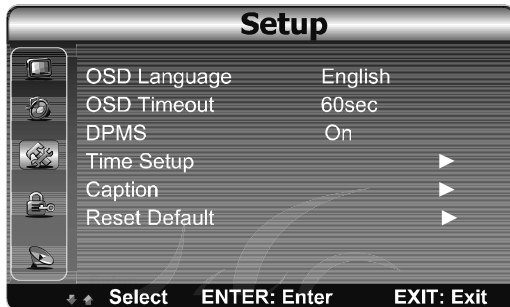

- 1 Press [MENU] button to display the main menu.
- 2 Press [▲/▼] button to select Setup item.
- 3 Press [▶/OK] button to enter Setup menu.
- 4 Press [▲/▼] button to select the option, press [▶/OK] button to enter or press [◀/▶] button to adjust the option.
- 5 Press the [Menu] button to close the menu.

- OSD Language - Use the right or left arrow button to choose the OSD Language among English, Spanish and French.
- OSD Timeout - Set OSD display time
- DPMS - This is a good function for a computer monitor. When DPMS is on, the computer will control the screen on or off. For example, if the computer is in sleep mode, the screen will be switched off. If the computer is activated, the screen also is activated.
- Time Setup - You can set up the exact time by yourself. You can also set up Sleeper Time and Auto Sleep Time.
- Caption: There are three items in it - Analog Closed Caption, Digital Closed Caption and Digital Caption Style.
 - Analog Closed Caption: CC1, CC2, CC3, CC4, TEXT1, TEXT2, TEXT3, TEXT4.
 - Digital Closed Caption: Service1, Service2, Service3, Service4, Service5, Service6.
 - Digital Caption Style: There are two Caption Styles. One is the automatic function set as the broadcaster, while the other is the custom style where you can adjust the font size, color, opacity, background color etc., accordingly.
- Reset Default - Every TV has its original setting before leaving the factory. So this function helps you restore these settings.

Changing the TV Settings

Using the Parental Menu

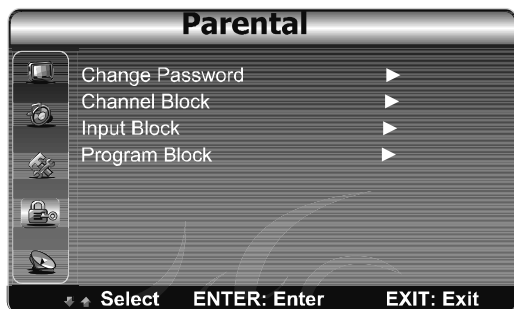

- 1 Press [MENU] button to display the main menu.
- 2 Press [▲/▼] button to select Parental item.
- 3 Press [▶/OK] button to enter Parental menu.
- 4 Press [▲/▼] button to select the option, press [▶/OK] button to enter or press [◀/▶] button to adjust the option.
- 5 Press the [Menu] button to close the menu.

When you first use this function, the default password is [0000].

Once you input this password, you can: Press ▲/▼ to highlight an option, then press ◀/ ▶ to adjust the option. You can adjust:

- Change Password - The first time you use this function, use the default password. If you want to change it, first enter the new password then enter the same password again.
- Channel Block - This function will let you block any channel you want.
- Input Block - You can block the input source with this function. For example, if you want to block AV input, just highlight [AV] and press [ENTER]. The AV input will not be seen in the screen.
- Clean All - This function will let you clean all the channels stored on this TV.
Note: If you choose this function, all the programs you preset will be lost.
- Program Block-A. Rating Enable is on
 - B. U.S. TV Ratings: You can choose TV ratings according to the illustration on the screen.
 - C. The settings for U.S. Movie Ratings, Canada (English) Ratings and Canada (French) Ratings follow Step B.

If you want to block the unrated program, please turn on this function.

Following is the description of these ratings.

Age	Defined as
TV-Y	All children
TV-Y7	Directed to older children
TV-G	General audience
TV-PG	Parental Guidance suggested
TV-14	Parents Strongly cautioned
TV-MA	Mature Audience only

Contents	Defined as
FV	Fantasy Violence
D	Suggestive dialogue
L	Strong language
S	Sexual situations
V	Violence

Changing the TV Settings

Using the Parental Menu

Rating	Defined as
G	General audience
PG	Parental Guidance suggested
PG-13	Parents strongly cautioned
R	Restricted
NC-17	No one 17 and under admitted
X	Adult audience only

About Canada (French)

Rating	Description
G	General
8 ans+	8+General; Not recommended for young children
13 ans+	Programming may not be suitable for children under the age of 13
16 ans+	Programming is not be suitable for children under the age of 16
18 ans+	Programming restricted to adults

About Canada (English)

Rating	Description
C	Children
C8+	Children eight years and older
G	General Programming, suitable for all audiences
PG	Parents Guidance
14+	Viewers 14 years and older
18+	Adult programming

NOTE: As you block rating, all rating higher than the ones you select are blocked as well. For example, if you choose to block the MPAA rating R, the higher ratings, NC-17 and X, are automatically blocked too .

Hotel Menu Description

Hotel Menu Description

Follow "MENU" -> "AUDIO" -> "BALANCE (setting is 0)", Input " 548 "by remote control to open hotel menu.



1. Use UP/DOWN arrow button on remote control to select hotel menu function.
2. Use LEFT/RIGHT arrow button on remote control to change setting.
3. Use OK button on remote control to confirm setting.
4. Use EXIT button on remote control to exit hotel menu.

Following content is description of every function in Hotel menu. Please refer to above picture.

1. Restore



Function: Clone the desired TV setting from the USB flash driver to this TV.

- 1.1. Turn a new TV on and insert the USB flash driver ,with "HOTEL.bin" file in ,to service port on the TV.
- 1.2. Use UP/DOWN arrow button to highlight "Restore" and press OK button to clone the setting. Hotel menu will exit automatically when finish restore.
- 1.3. Remove USB flash. Turn the TV off and Turn it on again to check the setting.

2. Clone



Function: Clone the desired TV setting from the USB flash driver to this TV.

- 1.1. Turn a new TV on and insert the USB flash driver ,with "HOTEL.bin" file in ,to service port on the TV.
- 1.2. Use UP/DOWN arrow button to highlight "Restore" and press OK button to clone the setting. Hotel menu will exit automatically when finish restore.
- 1.3. Remove USB flash. Turn the TV off and Turn it on again to check the setting.

Hotel Menu Description

Hotel Menu Description

3. Hotel Mode



Function: Enable or Disable the setting in hotel menu.

- Select "ON" to enable the functions.
- Select "OFF" to disable the functions.

4. KB Lock

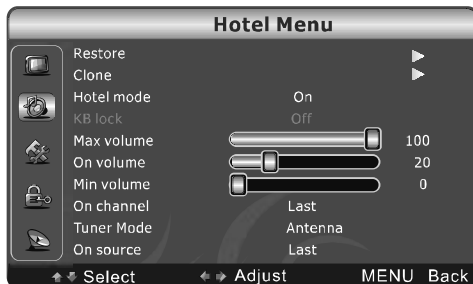

Function: Enable or Disable the Key function.

- Select "ON", key button doesn't work when customer press it on the front of TV frame.
- Select "OFF", key button works as normal TV when customer press it on the front of TV frame.

5. Max Volume



Function: Control the max volume that can be adjusted by customer.

Setting range is from 0 to 100.

6. On Volume

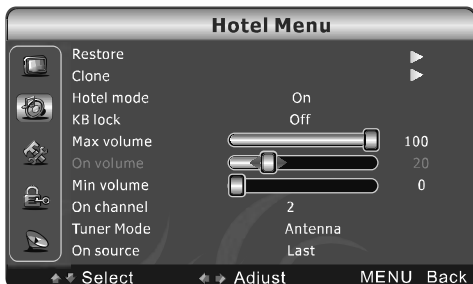

Force the default volume when turn the TV on.

Setting range is from 0 to 100.

Hotel Menu Description

Hotel Menu Description

7. Min volume

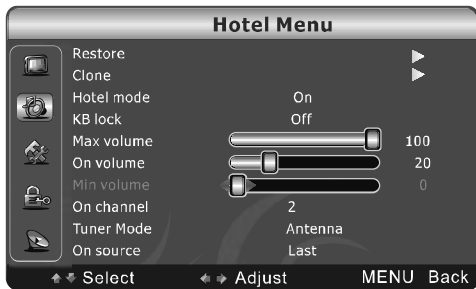

Function: Control the min volume that can be adjusted by customer.

Setting range is from 0 to 100.

8. On Channel

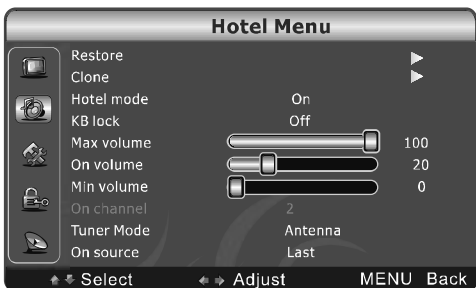

Function: Force the default channel when turn the TV on. It is available only when the "ON SOURCE" setting is "TV".

- Setting range is from 1 to 135 in cable model.
- Setting range is from 2 to 69 in Antenna model.

LAST means TV will show the last watch channel when turn TV on again.

9. Tuner Mode

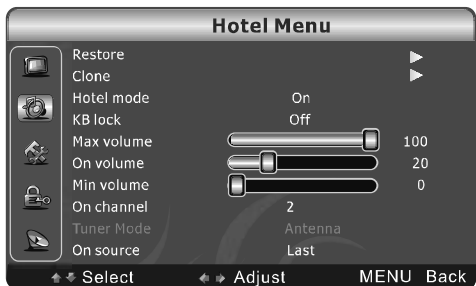

Function: Select cable or antenna. It is available only when the "ON SOURCE" setting is "TV" and On Channel setting isn't "Last".

- Select Cable to enable cable model.
- Select Antenna to enable antenna model.

10. On Source

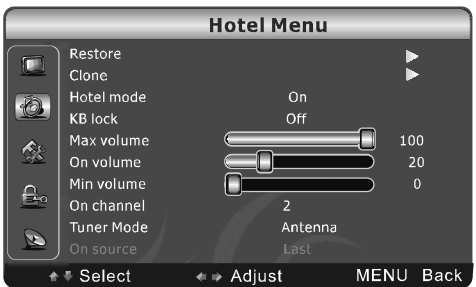

Function: Force the input source when turn the TV on. Setting range includes all input sources and LAST.

LAST means TV will show the last watch source when turn TV on again.

Hotel Menu Description

Hotel Menu Description

11. User Save Lock

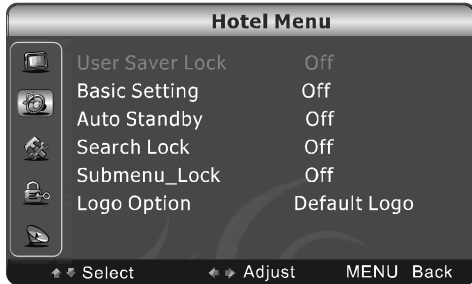

Function: Control to restore the customer setting or default setting when turn on the TV.

- Select ON to restore the default setting when turn on the TV.
- Select OFF to restore the customer setting when turn on the TV.

12. Basic Setting



Function: enable or disable standard mode setting.

Note: "Basic setting" is prior than "User save lock" function.

- Select "ON" to force video mode, audio mode to "Standard" mode and Zoom to "Wide" mode. And disable User Save Lock function.
- Select "OFF" to disable the function.

13. Auto Standby

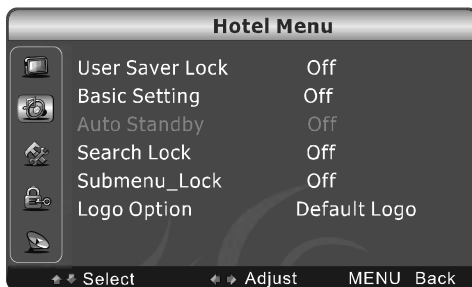

Function: TV Power management.

- Select "ON" to turn TV off after 15 minutes if there is no input signal.
- Select "OFF" to turn TV on all the time.

14. Search Lock

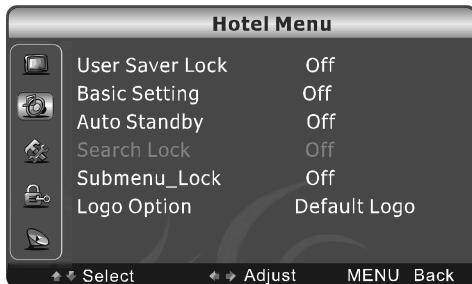

Function: Enable or disable channel scan function.

- Select ON to enable channel scan function.
- Select OFF to disable channel scan function.

Hotel Menu Description

Hotel Menu Description

15. Submenu Lock

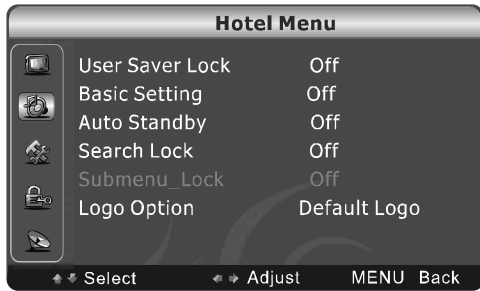

Function: Enable or disable advance setting in picture menu.

- Select ON to disable advance setting in picture menu.
- Select OFF to enable advance setting in picture menu.

16. Logo Option



Function: Select type of Logo when turn TV on.

Range includes "Default Logo", "No Logo", "welcome" and "Hisense".

