

Hisense®

-Innovation for life-

HOSPITALITY LED TELEVISION
MODEL NO. LHD32K21MH

USER'S MANUAL

Before using the TV, Please read this manual thoroughly, retain it for future reference.

ES-G112064

English

Table of contents

Important safety instructions	2
Warnings	2
Cautions	3
Accessories	3
Installing and removing the stand	3
Installing the stand	3
Attaching the TV to the desk	4
Removing the stand	4
Installing a wall-mount bracket	4
TV components	4
Front and side controls	4
Back connections	5
Remote control	5
Using the remote control	6
Installing remote control batteries	6
Aiming the remote control	6
Making connections	7
Connecting the power	7
Selecting a location	7
Connecting an HDMI device	7
Connecting a component video device	7
Connecting an antenna, cable TV, or satellite TV box	8
Connecting a VCR, camcorder, or game console	8
Connecting a computer	8
Connecting a home theater system	9
Connecting headphones	9
Connecting devices with USB interface	9
Understanding the basics	9
Turning your TV on or off	9
Selecting the video input source	9
Selecting a channel	9
Adjusting the volume	9
Displaying program information	10
Navigating the menus	10
On-screen menu overview	10
Adjusting the picture	12
Choosing the display format (aspect ratio)	12
Adjusting the sound	12
Selecting the audio mode	12
Adjusting the Features	12
Adjusting the Installation	14
Troubleshooting	14
Video and audio	15
Remote control	15
General	15
Maintenance	16
Cleaning	16
Specifications	16
Legal notices	16
Adjusting hotel settings	17

CHILD SAFETY

It makes a difference how and where you use your flat panel display

As you enjoy your new product, keep these safety tips in mind

The issue

The home theater entertainment experience is a growing trend, and larger TVs are popular purchases. However, TVs are not always supported on the proper stands or installed according to the manufacturer's recommendations. We and the consumer electronics industry are committed to making home entertainment enjoyable and safe.

TVs that are inappropriately placed on dressers, bookcases, shelves, desks, speakers, chests, or carts may fall over and cause injury.

Tune into safety

- One size of TV stand does **not** fit all. Use only a TV stand rated for the weight of your TV.
- Carefully read and understand all enclosed instructions for proper use of this product.
- Don't let children climb on or play with entertainment system furniture and TVs.
- Don't place TVs on furniture that can easily be used as steps, such as a crate or chest of drawers.
- Remember that children can become excited while watching a program, especially on a "larger-than-life" TV. Make sure that you place or install the TV where it cannot be pushed, pulled over, or knocked down.
- Make sure that you route all cords and cables so that they cannot be pulled or grabbed by curious children.



Wall mounting

If you decide to wall mount your TV, always remember:

- One size of wall mount does **not** fit all. Use only a wall mount rated for the weight of your TV and that has been recommended by this TV manufacturer, listed in this manual, or otherwise listed by an independent laboratory as suitable for your TV.
- Follow all instructions supplied by the TV and wall mount manufacturers.
- If you have any doubts about your ability to safely wall mount your TV, get help from a professional installer.
- Make sure that the wall where you are mounting the TV is appropriate. Some wall mounts are not designed to be mounted to walls backed with steel studs or cinder blocks. If you are unsure, ask a professional installer.
- TVs can be heavy. At least two people are required for safe wall mount installation.



Important safety instructions

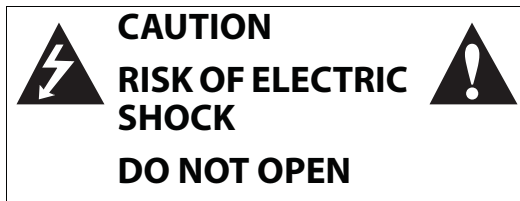

This symbol indicates that dangerous voltage constituting a risk of electric shock is present within your TV. This label is located on the back of your TV.



This symbol indicates that there are important operating and maintenance instructions in the literature accompanying your TV.

- 1 Read these instructions.
- 2 Keep these instructions.
- 3 Heed all warnings.
- 4 Follow all instructions.
- 5 Do not use this apparatus near water.
- 6 Clean only with a dry cloth.
- 7 Do not block any ventilation openings. Install in accordance with the manufacturer's instructions.
- 8 Do not install near any heat sources such as radiators, heat registers, stoves, or other apparatus (including amplifiers) that produce heat.
- 9 Do not defeat the safety purpose of the polarized or grounding-type plug. A polarized plug has two blades with one wider than the other. A grounding type plug has two blades and a third grounding prong. The wide blade or the third prong are provided for your safety. If the provided plug does not fit into your outlet, consult an electrician for replacement of the obsolete outlet.
- 10 Protect the power cord from being walked on or pinched particularly at plugs, convenience receptacles, and the point where they exit from the apparatus.
- 11 Only use attachments/accessories specified by the manufacturer.
- 12 Use only with a cart, stand, tripod, bracket, or table specified by the manufacturer, or sold with the apparatus. When a cart is used, use caution when moving the cart/apparatus combination to avoid injury from tip-over. 
- 13 Unplug this apparatus during lightning storms or when unused for long periods of time.
- 14 Refer all servicing to qualified service personnel. Servicing is required when the apparatus has been damaged in any way, such as power-supply cord or plug is damaged, liquid has been spilled or objects have fallen into the apparatus, the apparatus has been exposed to rain or moisture, does not operate normally, or has been dropped.
- 15 The wall plug is the disconnecting device. The plug must remain readily operable.
- 16 An apparatus with a three-prong, grounding-type plug is a Class I apparatus, which needs to be grounded to prevent possible electric shock. Make sure that you connect this Class I television to a grounding-type, three-prong outlet.
- 17 Remote control batteries should not be exposed to excessive heat such as sunshine, fire, or the like.

- 18 The apparatus should not be exposed to dripping or splashing, and no objects filled with liquids, such as vases, should be placed on the apparatus.

Warnings

Electric shock hazard

To reduce the risk of fire or electric shock, do not remove any cover or expose the device to rain or moisture. No user-serviceable parts are inside. Refer servicing to qualified service technicians.

Lightning

For added protection for your device receiver during a lightning storm, or when it is left unattended and unused for long periods of time, unplug it from the power outlet and disconnect any antenna or cable system. This helps prevent property damage and personal injury from lightning and power line surges.

Power lines

An outside antenna system should not be located in the vicinity of overhead power lines or other electric light or power circuits, or where it can fall into such power lines or circuits. When installing an outside antenna system, extreme care should be taken to keep from touching such power lines or circuits as contact with them might be fatal.

Handling the LED panel

- Your TV's screen is made of glass. Do not drop your TV or hit, jolt, or press hard against the LED panel. If the screen breaks, be careful of broken glass.
- If the LED panel is broken, make absolutely sure that you do not touch the liquid in the panel. This may cause skin inflammation.
- If the liquid gets in your mouth, immediately gargle, rinse, and consult with your doctor. Also, if the liquid gets in your eyes or touches your skin, consult with your doctor after rinsing for at least 15 minutes or longer in clean water.

Replacement parts

When replacement parts are required, make sure that the service technician uses replacement parts specified by the manufacturer that have the same characteristics as the original part. Unauthorized substitutions may result in fire, electric shock, personal injury, or other hazards.

Safety check

After completing any service or repair to this device, ask the service technician to perform routine safety checks to determine that your TV is in correct operating condition.

Power source

Operate your TV only from the type of power source indicated on the marking label. If you are not sure of the type of power supplied to your home, consult an electrician or your local power company.

Cautions

Damage requiring service

Unplug this TV from the power outlet and refer servicing to qualified service personnel under the following conditions:

- When the power supply cord or plug is damaged or frayed.
- If liquid has been spilled or objects have fallen into your TV.
- If your TV has been exposed to rain or water.
- If your TV does not operate normally by following the operating instructions. Adjust only those controls that are covered by the operating instructions because incorrect adjustment of other controls may result in damage and will often require extensive work by a qualified technician to restore your TV to its normal operation.
- If your TV has been dropped or damaged in any way.
- When your TV exhibits a distinct change in performance.

Outdoor antenna grounding

If an outside antenna or cable system is connected to your TV, make sure that the antenna or cable system is grounded to provide some protection against voltage surges and built-up static charges. Article 810 of the National Electrical Code, ANSI/NFPA No. 70, provides information with respect to correct grounding of the mast and supporting structure, grounding of the lead-in wire to an antenna discharge unit, size of grounding conductors, location of the antenna-discharge unit, connection to grounding electrodes, and requirements for the grounding electrode.

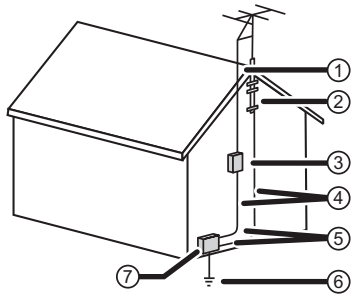

①	Antenna lead-in wire
②	Grounding clamp
③	Antenna discharge unit
④	Grounding conductors
⑤	Ground clamps
⑥	Power service grounding electrode system
⑦	Electric service equipment

Note to CATV system installer

Article 820 of the National Electrical Code, ANSI/NFPA No. 40 provides guidance for correct grounding. Specifically, it states that the cable ground must be connected to the grounding system of the building as close to the point of cable entry as practical.

Condensation

Moisture will form on the TV if the TV is brought from cool surroundings into a warm room or if the temperature of the room rises suddenly. When this happens, the TV's performance may be impaired. To prevent this, let the TV stand in its new surroundings for about an hour before switching it on, or make sure that the room temperature rises gradually.

Condensation may also form during the summer if the TV is exposed to the breeze from an air conditioner. In such cases, change the location of the TV.

Mobile telephone warning

To avoid interference with your TV picture and sound, operating problems, or even damage, keep your cordless and cellular telephones away from the TV.

End of life directives

Your TV contains tin-lead solder and a fluorescent lamp containing a small amount of mercury. Disposal of these materials may be regulated for environmental reasons. Your TV also contains material that can be recycled and reused. For disposal or recycling information, contact your local authorities or the Electronic Industries Alliance at www.eia.org to find a recycler in your area.

Non-active pixels

The LED panel contains almost 3 million thin film transistors, which provide exceptionally sharp video quality. Occasionally, a few non-active pixels may appear on the screen as a fixed blue, green, or red point. These non-active pixels do not adversely affect the performance of your TV, and are not considered defects.

Accessories

Make sure the following accessories are included in the box with your TV:

- Remote control
- User manual
- AC power cord
- AAA batteries (2)
- Stand
- Quick Setup Guide

Installing and removing the stand

You must install your TV into the stand in order for it to stand upright on a cabinet or other flat surface. If you intend to mount your TV on a wall or other vertical surface, you must remove the stand.

Warning: Before attempting assembly or removal of the stand, unplug the AC power cord.

Cautions:

- Read these instructions carefully before you try to assemble the stand or remove the stand.
- Make sure that you handle the TV carefully when attempting to assemble or remove the stand. If you are not sure of your ability to do this, contact a professional installer or service technician. Hisense is not responsible for any damages or injuries that occur because of mishandling or incorrect assembly.
- Use a soft cushion or covering to prevent scratching or damage to the TV screen or cabinet.

Installing the stand

Note: Your TV may differ from the illustrations shown.

To install the stand:

1. Insert the stand column into the base plate, aligning the ridge on the column with the groove in the base plate. Making sure the FRONT of stand column match the FRONT of base plate. Secure the stand column to the base plate with the four screws (M4, 12mm) provided.

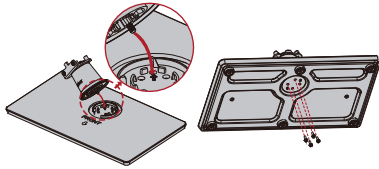

- 2 Secure the stand column to the stand cover vertically with the 2 screws (M4, 12mm) provided. Secure the stand column to the stand cover horizontally with the 2 screws (ST4, 14mm) provided.

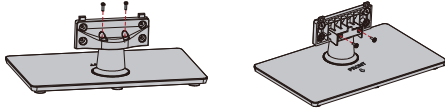

- 3 Insert the stand cover into the slot of TV bottom side and secure the stand to the TV with the four provided screws (M5, 12 mm).

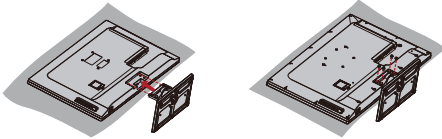

Attaching the TV to a desk

Here shown may be somewhat different from your TV. The TV must be attached to desk so it cannot be pulled in a forward/backward direction, potentially causing injury or damaging the product.

Screws: M5×L(table depth + 8~10mm)

Example: Table depth = 15mm Screws: M5×25

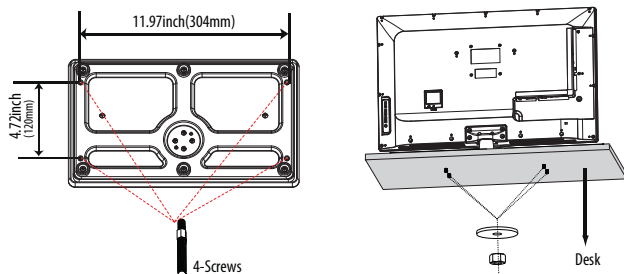

NOTE:
Be sure to follow the instructions, in correct installation of the stand (pedestal) may result in the TV falling over.

Removing the stand

You must remove the stand before you can wall-mount the TV.

Note: Your TV may differ from the illustrations shown.

To remove the stand:

- 1 Lay the TV (screen down) on the edge of the table or bench. Make sure that you put a soft cloth or cushion between the table or bench and the TV.
- 2 Remove the 4 screws holding the stand to the TV, then remove the stand.

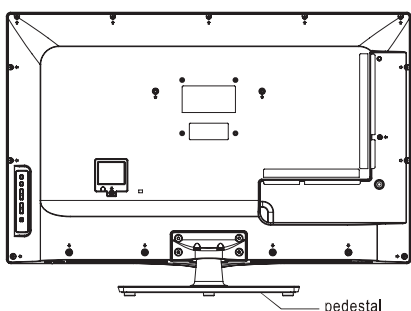

Installing a wall-mount bracket

If you want to attach the TV to a wall-mount bracket (not provided), you should first remove the stand, if it has been installed.

Warning: These instructions are for use by qualified service personnel only. To reduce the risk of hazards, do not perform any servicing other than that contained in the operating instructions unless you are qualified to do so.

To install a wall-mount bracket:

- 1 Lay your TV face down on a table or bench. Make sure that you put down a soft cushion or cloth so that your TV is not scratched.
- 2 Remove the pedestal stand. See "Removing the stand" above.
- 3 Secure the wall-mount bracket to the back of your TV using the four screws provided with the bracket.

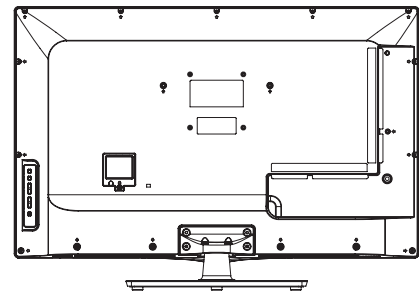

TV components

Front and side controls

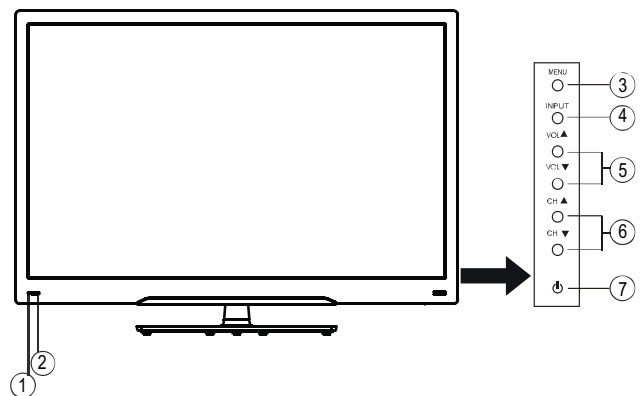

Item	Name	Description
①	Power indicator	The light shows whether the TV is on or standby mode.
②	Remote control sensor	Receives signals from the remote control. Please do not block.
③	MENU	Display the onscreen display(OSD) or Exit to close the OSD.
④	INPUT	Select the INPUT menu.
⑤	VOL ▲ / VOL ▼	Volume adjusting bottom, to increase or decrease the volume.
⑥	CH ▲ / CH ▼	Channel selection bottom, to increase or decrease the channel.
⑦	⏻ (power)	Press to turn your TV on or off (standby mode).

Back connections

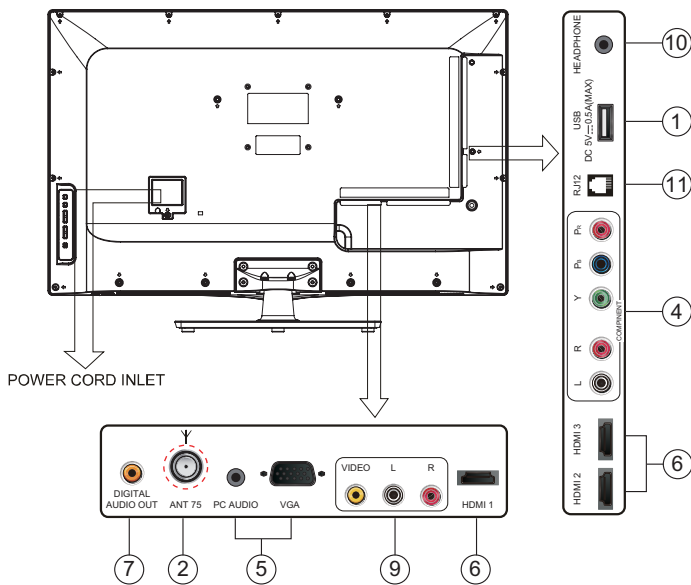

Remote control

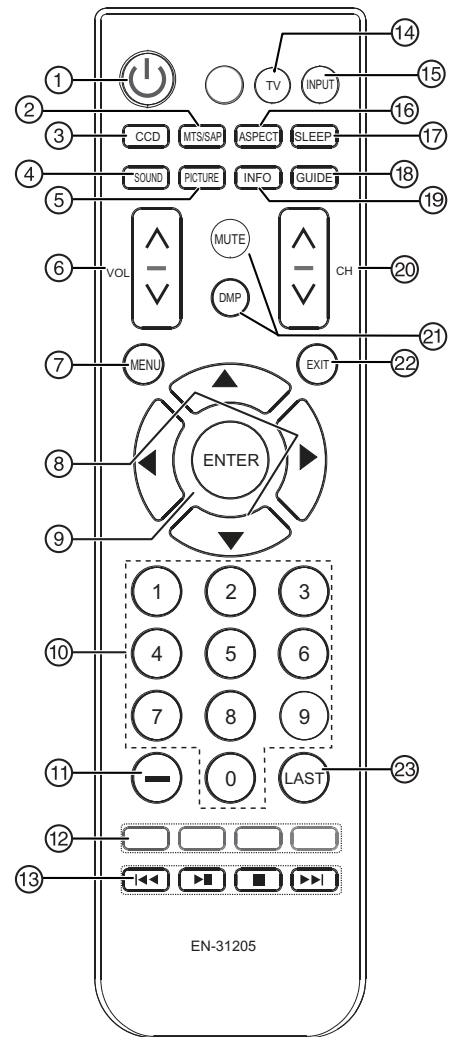

Item	Name	Description
①	USB	This unit has USB interface and can be connected the stand avd USB 1.1 and USB 2.0 USB FLASH STICK.
②	ANT IN jack	Connect an antenna or cable TV to this jack.
③	SERVICE	Service only, don't use.
④	COMP1 COMP2	Connect component video devices to these jacks.
⑤	PC AUDIO jacks VGA jack	Connect a computer (audio and video) to these jacks.
⑥	HDMI 1/2/3	Connect an HDMI device to one of these jacks.
⑦	DIGITAL AUDIO OUT jack	Connect a digital coaxial cable to this connector, then to a digital sound system.
⑧	AUDIO OUT	Connect a audio cable to this connector.
⑨	AV jack	Connect a standard AV device, such as a camcorder or game console, to these jacks.
⑩	(headphone) jack	Plug headphones into this jack.
⑪	RJ12	Connect a RJ-12 Cable to this jack, then to an external control device(such as a computer or A/V control system), to control the TV functions externally.

Item	Name	Description
①	POWER	Press to turn on the TV or put the TV in standby mode. Caution: The TV continues to receive power even in standby mode. Unplug the power cord to disconnect power.
②	MTS/SAP	In analog TV mode, press to select STEREO , SAP (secondary audio language), or MONO . In digital TV mode (DTV), press to select the audio track. For more information.
③	CCD	Press to turn closed captioning on or off. For more information.
④	SOUND	Press to select the sound mode. You can select standard , custon , music and clear voice.
⑤	PICTURE	Press to select the video mode. You can select Standard, Custom, Vivid, Game, Cinema and Power Saver.
⑥	VOL^ / VOL^v	Press to increase or decrease the volume.

Item	Name	Description
⑦	MENU	Display the main menu. Go back to preview menu.
⑧	▲ ▼ ◀ ▶	Press ▲ or ▼ to move up or down in on-screen menus. Press ◀ or ▶ to move left or right in on-screen menus or to adjust menu settings.
⑨	ENTER	Press to confirm selections in on-screen menus or to open sub-menus.
⑩	Numbers	Press the number buttons to enter channel numbers or the parental control password.
⑪	— (dash)	Press to select a digital sub-channel.
⑫	Program guide (EPG) function buttons	After pressing the GUIDE button in the digital TV channel option, the same color buttons will appear with explanations in the on-screen display (OSD). Follow the steps shown in the OSD.
⑬	⏮	Play the previous files.
	⏭	Play the next files.
	⏸	When you are listening to music and enjoy pictures. You can switch between playing and pause through this button.
	■	Exit the current state.
⑭	TV	Press to select the TV as the video input source.
⑮	INPUT	Press to open the <i>INPUT SOURCE</i> menu, then press ▲ or ▼ to select the video input source you want.
⑯	ASPECT	Select screen mode.
⑰	SLEEP	Press to set the sleep timer.
⑱	GUIDE	Press to open the DTV program guide (if available).
⑲	INFO	Display the current channel number.
⑳	CH ^ / CH v	Press to go to the next or previous channel in the channel list.
㉑	MUTE	Press to mute the sound. Press again to restore the sound.
	DMP	Press to browse Music and Phone on USB stick plugged into TV.
㉒	EXIT	Press to close the on-screen menu.
㉓	LAST	Return to previous channel.

Using the remote control

Installing remote control batteries

To install remote control batteries:

- 1 Press down on the battery compartment cover lock, then remove the remote control cover.
- 2 Insert two AAA batteries into the battery compartment. Make sure that the + and – symbols on the batteries match the + and – symbols in the battery compartment.
- 3 Replace the cover. Make sure that the lock snaps into place.
- 4 Install screw.



Battery precautions:

- Dispose of batteries as hazardous waste.
- Do not mix batteries of different types.
- Do not mix old and new batteries. Mixing old and new batteries can shorten the life of new batteries and can cause old batteries to leak.
- Remove batteries as soon as they become inoperable. Chemicals that can leak from the batteries can cause a rash. If the batteries leak, clean the battery compartment with a cloth.
- If the remote control is not used for an extended period of time, remove the batteries.
- Do not expose batteries to excessive heat such as sunshine, fire, or other heat sources.

Aiming the remote control

To aim the remote control:

- Point the remote control towards the remote sensor on the front of your TV.

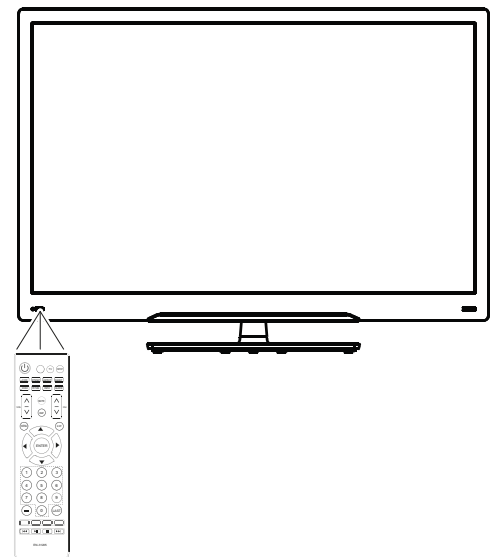

Notes:

- Do not expose the remote control to shock or liquids.
- Do not use the remote control in an area with high humidity.
- Do not place the remote control in direct sunlight.
- Do not place objects, such as furniture, between the remote control and the remote sensor.
- The remote control may not work if direct sunlight or bright light shines on the remote sensor. Either move your TV or change the angle at which you use the remote control.

Making connections

Before you make any connections:

- Check the plugs on the ends of cables to make sure that they are the correct type before you try plugging them into jacks on the TV.
- Make sure that all plugs are securely inserted into the jacks. Loose connections can result in image or color problems.
- When connecting devices to the TV, make sure that the TV and the device are turned off and that the power cords are unplugged.

Connecting the power

To connect the power cord:

- Connect the power cable to the **AC IN** jack on the back of the TV, then connect the other end to a power outlet.

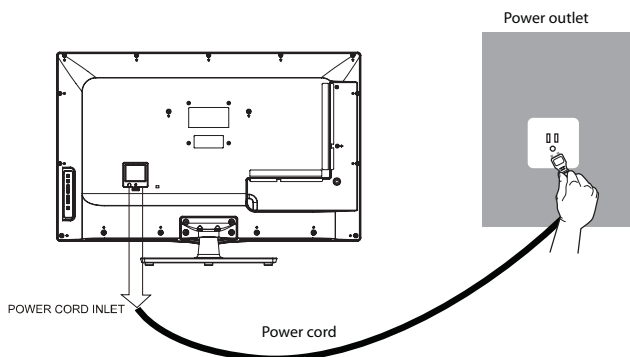

Notes:

- The AC plug on the TV may be different from the one shown.
- Make sure that you only use the type of power source indicated on the marking label.
- Always unplug the power cord when not using the TV for a long period of time.

Selecting a location

You should select a location for the TV:

- Where direct light does not reflect on the screen
- That has indirect and soft lighting
- Where the TV has access to an antenna or cable TV connection
- Where the TV has access to a power outlet

Note: Watching TV in total darkness or with a reflection on the screen may cause eye strain.

Connecting an HDMI device

Note: If your device has an HDMI connection, we recommend you use it to get the best picture and sound quality possible.

To connect an HDMI device:

- Connect one end of an HDMI cable (not included) to the HDMI 1 or HDMI 2 jack on Or HDMI3 on the side of your TV. then connect the other end of the cable to the HDMI OUT jack on the HDMI device.

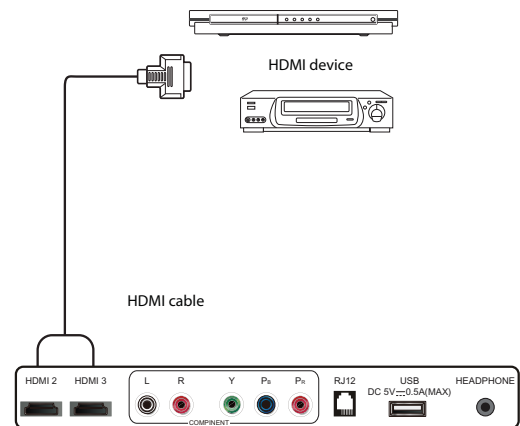

Note: To connect a DVI device, use a DVI to HDMI adapter cable to connect to the **HDMI** jack on the TV, then connect an audio cable to the **PC AUDIO** jack on the back of the TV.

To play from the HDMI device:

- 1 Turn on the TV, then press **INPUT**. The **INPUT SOURCE** menu opens.
- 2 Press **▲** or **▼** to select **HDMI1, HDMI2, HDMI3**, then press **ENTER**.
- 3 Turn on the HDMI device, then set it to the correct mode. Refer to the instructions that came with the HDMI device.

Connecting a component video device

Component cables often have red, green, and blue color-coded video connectors and red and white audio connectors. Match the colors when making connections.

To connect a component video device:

- 1 Make sure that your TV's power cord is unplugged and the component video device is turned off.
- 2 Connect a component video cable to the **COMPONENT OUT** jacks on the component video device.

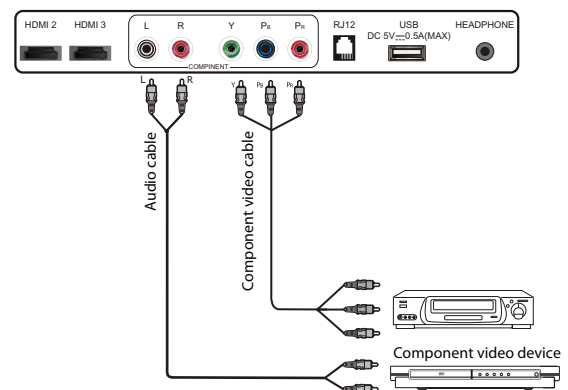

- 3 Connect the other end of the component video cable to the **COMPONENT** jacks on the back/side of your TV.
- 4 Connect an audio cable to the **AUDIO OUT** jacks (L/R) on the component device.
- 5 Connect the other end of the audio cable to the **COMPONENT AUDIO-R** and **AUDIO-L** jacks on the back/side of your TV.

To play from the component video device:

- 1 Turn on the TV, then press **INPUT**. The *INPUT SOURCE* menu opens.
- 2 Press **▲** or **▼** to select **Component** then press **ENTER**.
- 3 Turn on the component video device and start playback. Refer to the instructions that came with the component video device.

- 3 Connect the audio connectors of the AV cable (the red and white connectors) to the **AV OUT AUDIO** jacks of the external device, then connect them to the **AV L** and **R** jacks on the back of your TV.

Connecting an antenna, cable TV, or satellite TV box

If you are connecting a satellite TV or cable box, you can use one of the following (if available):

- Best - HDMI cable
- Better - Video component cables
- Good - Video composite cable
- Acceptable - 75-ohm coaxial cable.

To connect an antenna, cable TV, or satellite TV box:

- Connect one end of a 75-Ohm, coaxial cable to the **ANT IN** jack on the back of the TV, then connect the other end of the cable to the antenna or cable TV wall jack.

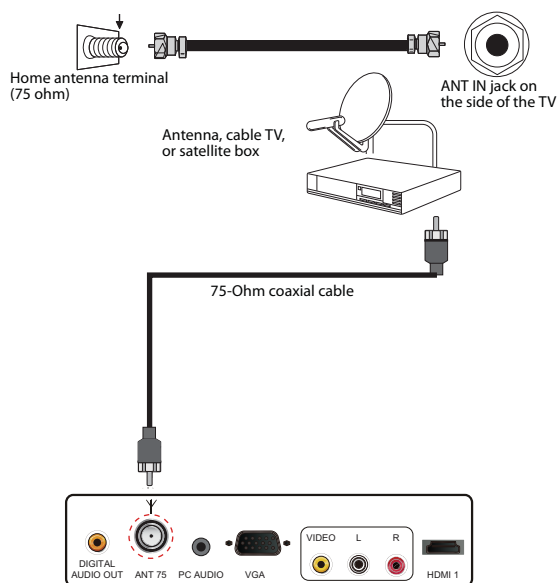

Notes:

- We recommend using a 75-Ohm, coaxial cable to reduce interference and noise that may be caused by radio wave transmissions.
- Do not bundle the coaxial cable with the power cord or any other cables.
- If you are using an antenna and reception is not good, contact a service technician to adjust the antenna.

Connecting a VCR, camcorder, or game console

Note: If the VCR, camcorder, or game console has component jacks (better), or an HDMI jack (best), connect them using the best available connection.

To connect a VCR, camcorder, or game console:

- 1 Make sure that your TV's power cord is unplugged and the VCR, camcorder, or game console is turned off.
- 2 Connect one end of a standard AV cable (not included) into the **AV** video jack on the back of the TV, then connect the other end of the cable to the **AV OUT VIDEO** jack on the external device.

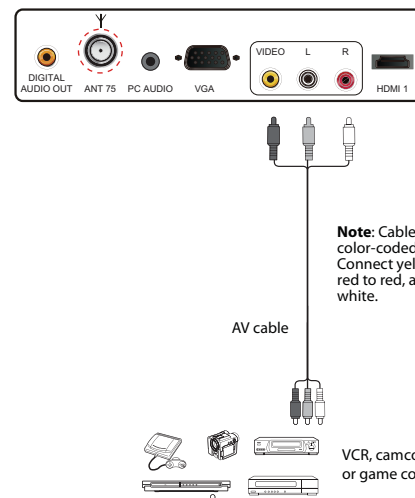

To play the external AV device:

- 1 Turn on the TV, then press **INPUT**. The *INPUT SOURCE* menu opens.
- 2 Press **▲** or **▼** to select **Video**, then press **ENTER**.
- 3 Turn on the device, then start playback on the device.

Connecting a computer

To connect a computer:

- 1 Make sure that your TV's power cord is unplugged and the computer is turned off.
- 2 Connect one end of a VGA cable (not included) to the **VGA** jack on the side of the TV, then connect the other end of the cable to the VGA jack on the computer. The D-Sub cable will not be supplied with the product. We strongly recommend to use D-Sub cable with 2 cores as shown in the figure.

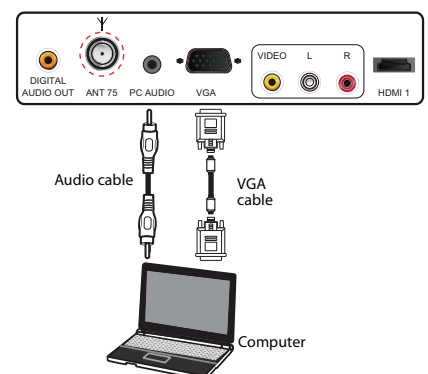

- 3 Connect one end of an audio cable with a stereo mini-plug (not included) to the **PC AUDIO** jack on the side of the TV, then connect the other end of the cable to the **AUDIO OUT** jack on the computer.

To play video from the computer:

- 1 Turn on the TV, then press **INPUT**. The *INPUT SOURCE* menu opens.
- 2 Press **▲** or **▼** to select **PC**, then press **ENTER**.
- 3 Turn on the computer, then adjust the computer display properties as needed.

Connecting a home theater system

Connecting using a digital audio cable

To connect using a digital coaxial cable:

- 1 Make sure that your TV's power cord is unplugged and the home theater system is turned off.
- 2 Connect one end of a digital coaxial audio cable (not included) to the **DIGITAL AUDIO OUT** jack on the back of the TV.

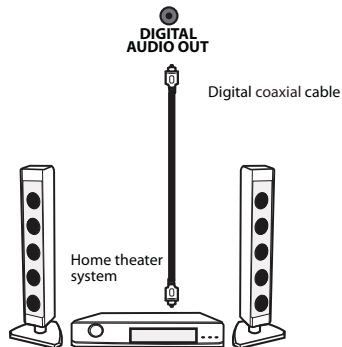

- 3 Connect the other end of the audio cable to the digital coaxial input jack on the home theater system.

To play TV sound through a home theater system:

- 1 Turn on the TV and select a program to watch.
- 2 Turn on the home theater system and select the TV sound source, then adjust the volume to a comfortable level.

Connecting headphones

Warning: When using headphones, adjust the headphone volume to avoid excessively loud volume which can damage your hearing.

To connect headphones:

- Plug the headphones (not included) into the  (headphone) jack on the back of the TV.

Note: The TV sound automatically mutes when headphones are

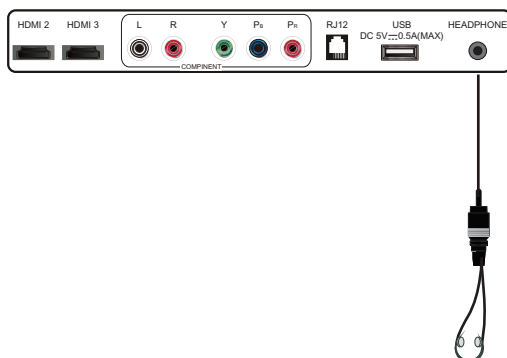

Connecting devices with USB interface

Plug the USB stick into USB port on the side of TV.

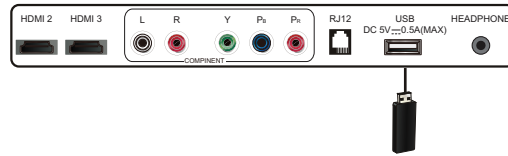

1. The USB detect message will pop out when you plug in USB stick into TV. Select "OK" to review content on USB.
2. Or you can press INPUT button on the remote control or on the TV and select DMP in source list.



Understanding the basics

Turning your TV on or off

To turn your TV on or off (standby mode):



- 1 Plug the power cord into an AC power outlet.
- 2 Press  (power). Your TV turns on.
- 3 Press  again to turn off your TV. When you turn off your TV, it goes into standby mode.

Warning: When your TV is in standby mode, it is still receiving power. To completely disconnect power, unplug the power cord.

Note: If your TV does not receive an input signal for several minutes, it automatically goes into standby mode.

Selecting the video input source



To select the video input source:

- 1 Turn on your TV, then press **INPUT** on the remote control or on the TV. The **INPUT SOURCE** menu opens.
- 2 Press  or  to highlight the video source you want, then press **ENTER**. Options include **TV, Video, Component, PC (computer), HDMI1, HDMI2, HDMI3, DMP.**



Selecting a channel

Tip: If you are using a cable or satellite box, use the remote control that came with that device to change channels.

To select a channel:

- Press **CH**  / **CH**  to go to the next or previous channel.
- Press the number buttons to enter the channel number you want, then wait for the channel to change, or press **ENTER** to change the channel immediately.
 - To select a digital channel, press the number buttons to select the main digital channel, then press the dash(-) button, then the number buttons again to select the sub-channel. Wait for the channel to change or press **ENTER** to change the channel.



Note: Button presses must be within three seconds of each other.

- Press **LAST** to go to the last channel viewed.
- Press **GUIDE** to display a list of memorized channels, press  or  to select the channel you want from the list, then press **ENTER** to go to that channel.

Note: If the list has more than one page, press  or  to scroll through the pages.

Adjusting the volume

To adjust the volume:

- Press **VOL**  / **VOL**  to increase or decrease the volume.
- Press **MUTE** to temporarily turn off all sound. Press **MUTE** again to restore the sound.

Displaying program information

To display program information:

- Press **INFO** to show an information banner. The information banner shows current program information such as channel number, video input source, and resolution.
- **Digital signal information**—Displays channel number, station name, channel label (if preset), broadcast program name, signal type, audio information, resolution, and current program start and end times when watching a digital channel.
- **Analog signal information**—Displays channel number, channel label (if preset), signal type, audio information, and resolution when watching an analog channel.
- Press **GUIDE** to show the digital program guide, which may show a list of available programs, program times, and program summaries, depending on the information provided by the broadcaster.

Navigating the menus

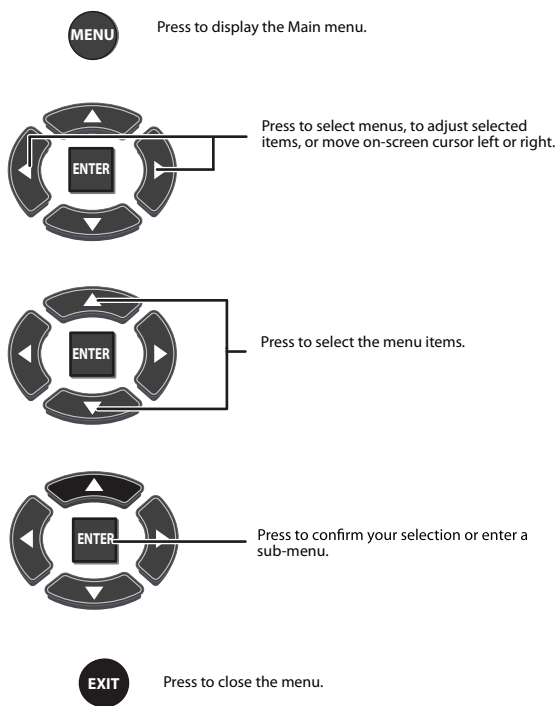

On-screen menu overview

Use the on-screen menu to configure the various operational settings of your TV. To access the menu, press **MENU**. The menus and their corresponding functions are described in the following table:

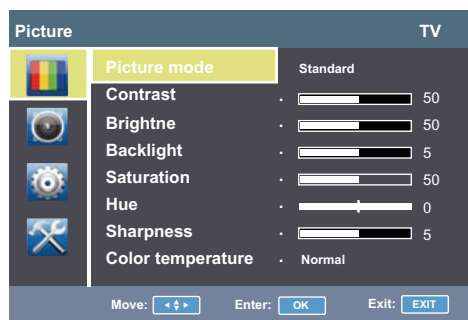

① Picture	Preset Mode	Lets you enable one of five preset viewing options optimized for different viewing conditions.
	Contrast	Lets you adjust the level of picture contrast. Increasing the contrast adds more light to the white areas of the picture.
	Brightness	Lets you adjust the level of brightness on the screen. Increasing brightness can add more light to dark areas of the picture.
	Backlight	Lets you control panel overall brightness and background.
	Saturation	Lets you adjust the level of color intensity.
	Hue	Adjusts the color balance of the picture. Use this control to make skin tone look more natural.
	Sharpness	Lets you adjust the focus of the picture. Increase sharpness for a clearer picture, or decrease sharpness for a smoother picture.
	Color Temperature	Lets you select one of three preset color temperature settings: Cool , Normal or Warm .

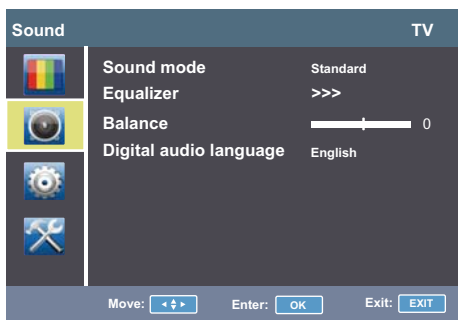

② Sound	Sound mode	Lets you select one of preset sound mode or customized sound effective by yourself.
	Equalizer	Lets you select the audio frequency you want to adjust and change its value.
	Balance	Lets you adjust the balance between the left and right speakers.
	Digital audio language	Lets you select the language track you prefer for viewing digital TV programs. Available options depend on your digital TV provider.

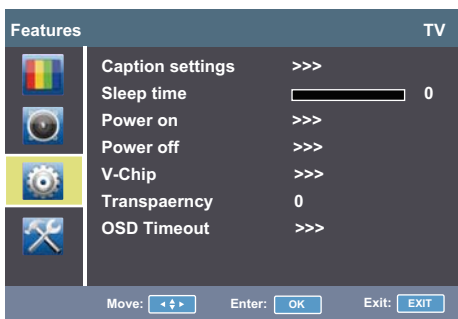

③ Features	Caption settings	Lets you configure the settings for closed caption in TV programs.
	Sleep time	Lets you select sleep timer among 0 to 180 minutes.
	Power on	Lets you set the TV on time of every day.

③ Features	Power off	Lets you set the TV off time every day.
	V-Chip	Lets you select certain programs to be blocked.
	Transparency	Lets you adjust Menu transparency.
	OSD Timeout	Set display time of Menu.



④ Installation	Language	Lets you select the lanugage for the On-Screen Display. Choose from English, French, or Spanish.
	Channels	Lets you select RF signal source for your TV. And lets you initiate an automatic channel scan to search the available channels on your TV.
	Time	Lets you configure the system clock,time zone settings and daylight saving.
	Source Labels	Lets you name each input.
	Reset AV settings	Change setting back to default. (picture and sound only)

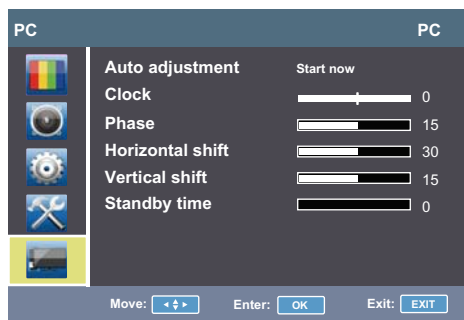

⑤ PC	Auto adjustment	Adjust the position of image on screen automatically.
	Clock	Adjust the clock used to synchronizing the image.
	Phase	Adjust the phase of the clock used for synchronizing the image.
	Horizontal shift	Adjust the horizontal position of the image.
	Vertical shift	Adjust the vertical position of the image.
	Standby time	Adjust the off time when there is no signal input.

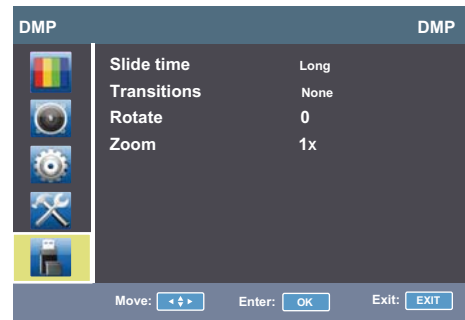

⑥ DMP	Slide time	Lets you select the photo slide time: Long, Medium or Shot.
	Transitions	Lets you select photo transitions way from current picture to next picture.
	Rotate	Lets you rotate picture.
	Zoom	Lets you zoom in/out picture.

DMP Function Introduction

Signal mode	support format
Pcture	JPEG
Music	MP3

Adjusting the picture

To adjust the picture:

In TV mode, you can adjust:

- 1 Press **MENU**. The *Main* menu opens.
- 2 Press **ENTER** or **▶**. The *Picture* menu opens.

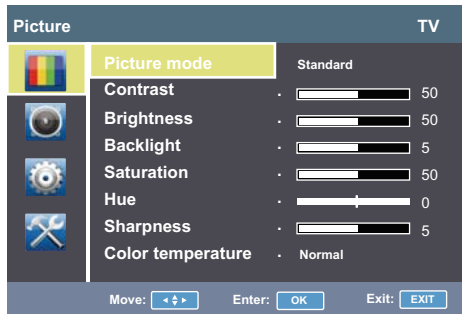

- 3 Press **▲** or **▼** to highlight an option, then press **ENTER** or **▶** to access the option, and press **◀** or **▶** to adjust the option. You can select:
 - **Picture Mode**—Selects the picture mode. You can select:
 - **Vivid** (a bright and vivid picture)
 - **Standard** (a standard picture)
 - **Game** (a finely detailed picture)
 - **Cinema** (the brightness is decreased)
 - **Power saver** (decrease the backlight for to save energy)

Note: You can also press **PICTURE** on the remote control to select the picture mode.

- **Contrast**—Lets you increase or decrease the contrast of the picture. Increase the contrast to adjust the white areas of the picture or decrease the contrast to adjust the black areas of the picture.
- **Brightness**—Lets you increase or decrease the brightness of the picture. Increasing the brightness can add more light to dark areas of the picture, while decreasing the brightness can add more darkness to light areas of the picture.
- **Backlight**—Lets you control panel overall brightness. Increasing the backlight can add more light to overall screen picture and the TV uses more power consumption. While decreasing the backlight can add more darkness to overall screen picture and the TV uses less power consumption.
- **Saturation**— Lets you adjust the intensity of the colors.
- **Hue**— Lets you adjust the overall color of the picture (only supported in TV/AV mode).
- **Sharpness**—Lets you increase the sharpness level for clearer images or decrease the sharpness level for smoother images.
- **Color temperature**— Lets you change the color temperature. You can select the color temperature from three options: **Cool**, **Normal** or **Warm**.

- 4 Press **◀** to return to the previous menu, or press **EXIT** to close the menu.

Choosing the display format (aspect ratio)

To choose the display format:

- 1 Press **ASPECT** on the remote control repeatedly to cycle through the available display formats. Options include:
 - **Normal**—Selects the 4:3 aspect ratio to show a picture with black bar on both right and left hand side.
 - **Full Screen**—Shows a full-screen picture.
 - **Zoom1**—Enlarges the picture but may crop the top and bottom of picture. And has less black bar on right and left than Normal aspect mode.

- **Zoom2**—Enlarges the picture but may crop the top and bottom of picture. And no black bar on right and left.
- **Panorama**—Stretches the picture at the edges, but maintains a good aspect ratio at the center of the screen.

Note: In analog TV mode, allows you to select all aspect modes. In digital TV mode, allows you to select Normal mode and full-screen mode. Zoom and panorama modes are not available.

Adjusting the sound

To adjust the sound:

In TV mode, you can adjust:

- 1 Press **MENU**. The *Main* menu opens.
- 2 Press **▲** or **▼** to highlight **sound**, then press **ENTER** or **▶**. The *sound* menu opens.

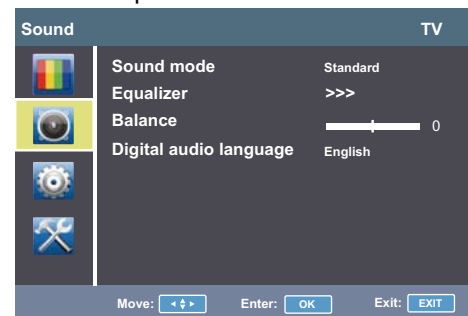

- 3 Press **▲** or **▼** to highlight an option, then press **ENTER** or **▶** to access the option, and press **◀** or **▶** to adjust the option. You can select:
 - **Sound mode**— Press **[◀/▶]** to select between 3 different pre-adjusted sound modes: Standard, music, and Clear voice. The User mode preserves your preferred sound settings after using the Equalizer available under the Sound submenu.
 - **Equalizer**—Set the users' mode of sound, press **[▲/▼]** button to select the sound component of 120HZ, 500HZ, 1.5K, 5K, and 10K. Press **[◀/▶]** button to weaken or enlarge the sound to the proper value.
 - **Balance**—Adjusts the balance between the left and right audio channels.
 - **Digital audio language**— In digital TV mode, allows you to select the audio language for a program. In analog TV mode, you can't see this option
- 4 Press **◀** to return to the previous menu, or press **EXIT** to close the menu.

Selecting the audio mode

To select the audio mode:

- Press **SOUND** on the remote control one or more times to cycle through the available sound modes. Options include:
 - **Standard** (for normal programs).
 - **Music** (for music programs).
 - **Clear Voice** (for news or sports programs).
 - **Custom** (for a customized sound mode).

Adjusting the Features

In TV mode, you can adjust:

- 1 Press **MENU**. The *Main* menu opens.
- 2 Press **▲** or **▼** to highlight **Features**, then press **ENTER** or **▶**. The *Features* menu opens.

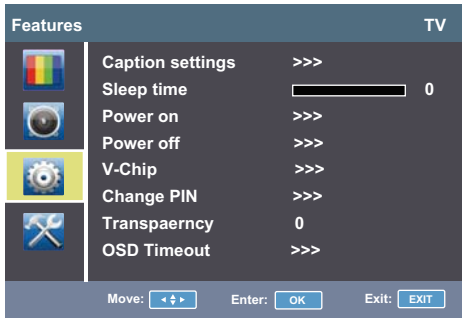

3 Press **▲** or **▼** to highlight an option, then press **ENTER** or **▶** to access the option, and press **◀** or **▶** to adjust the option. You can select:

- **Caption settings** – Lets you set up closed captions (CC). Settings include Closed captions On/Off, Analog caption service, Digital caption service and Digital caption options.
 Closed captions - Lets you select On, Off or On during mute.
 Analog caption service - Lets you select one CC server among CC-1, CC-2, CC-3, CC-4, T-1, T-2, T-3 and T-4.
 Digital caption service: Lets you select one cc server among CS-1, CS-2, CS-3, CS-4, CS-5 and CS-6.
 Digital caption options: Lets you adjust the CCfont, color, background etc or you can keep default set by the broadcaster.
- **Sleep time** – Lets you select auto sleep time among 0 to 180 minutes.
- **Power on** – Lets you set up auto turn TV on time.
- **Power off** – Lets you set up auto turn TV off time.
- **V-Chip** – Lets you prevent your children from watching inappropriate material on TV. When set, parental controls read the rating of the program and deny access to programs that exceed the ratings level you select. To watch programs that exceed the selected rating, you must enter a password.

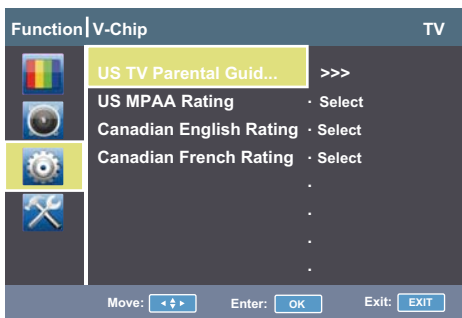

- **Access to V-Chip Menu**
 Press the number buttons to enter the four-digit password. The default password is **0532**. The *V-Chip* menu opens.
- Press **▲** or **▼** to highlight an option, then press **ENTER** or **▶** to access the option. Press **▲** or **▼** to highlight a rating and press **ENTER** to lock the rating and all other higher ratings or unlock the rating and all other lower ratings.
- **Program Block** –
 - **A** – Rating Enable is on.
 - **B** – U.S. TV Ratings: You can choose TV ratings according to the illustration on the screen.
 - **C** – The settings for U.S. Movie Ratings, Canada (English) Ratings, and Canada (French) Ratings follow Step B. If you want to block an unrated program, turn on this function. You can select all the ratings listed in the charts below.

U.S. TV ratings (age-based)	
These ratings are determined by the Federal Communications Commission (FCC).	
TV-Y	All children.
TV-Y7	Suitable for children 7 and older.
TV-G	General audiences.
TV-PG	Parental guidance suggested.
TV-14	Parental guidance strongly suggested.
TV-MA	Mature audiences only.

U. S. TV ratings (content-based)	
FV	Fantasy violence.
V	Violence.
S	Sexual situations.
L	Strong language.
D	Suggestive dialog.

U.S. movie (MPAA) ratings	
These ratings are determined by the Motion Picture Association of America (MPAA).	
G	General audiences.
PG	Parental guidance suggested.
PG-13	Suitable for children 13 and older.
R	Parental guidance suggested for children under 17.
NC-17	Not suitable for children under 17.
X	Adults only.

Canadian English ratings	
These ratings are based on the Canadian Home Video Rating System, determined by the Canadian Motion Picture Distributors Association (CMPDA).	
C	Suitable for all children.
C8+	Suitable for children 8 and older.
G	General audiences.
PG	Parental guidance suggested.
14+	Suitable for children 14 and older.
18+	Adults only.

Canadian French ratings	
These ratings are based on the classification categories determined by La Régie du cinéma du Québec.	
G	General audiences.
8 ans+	Suitable for children 8 and older.
13 ans+	Suitable for children 13 and older.
16 ans+	Suitable for children 16 and older.
18 ans+	Adults only.

Note: The V-Chip can block non rated programs as per "CEA-608-E sec. L.3". If the option to block [None], [NR], [E] or [E] programs is used in [U.S. TV ratings]kk, [U.S. movie (MPAA) ratings]kk, [Canada English ratings]kk or [Canada French ratings]kk accordingly "unusual results may occur, and the unit may not receive emergency bulletins or other types of programming:" - Emergency Bulletins (Such as EAS messages, weather warnings and others) · Locally originated programming · News · Political · Public Service Announcements · Religious · Sports · Weather.

Change PIN—Change the password of the V-Chip function.

Transparency—Adjust the transparency of menu.

OSD Timeout—The time it takes the OSD to disappear when no operations are performed. You can change it from Off, 5 seconds, 10seconds, and 30seconds.

Adjusting the Installation

To change the channel settings:

In TV mode, you can adjust:

- 1 Press **MENU**. The *Main* menu opens.
- 2 Press **▲** or **▼** to highlight **Installation**, then press **ENTER** or **▶**. The *installation* menu opens.



- 3 Press **▲** or **▼** to highlight an option, then press **ENTER** or **▶** to access the option, and press **◀** or **▶** to adjust the option. You can select:

Language—You can select the menu's language among English, French and Spanish.

Channels—You can select the mode of RF input and scan the available channels.

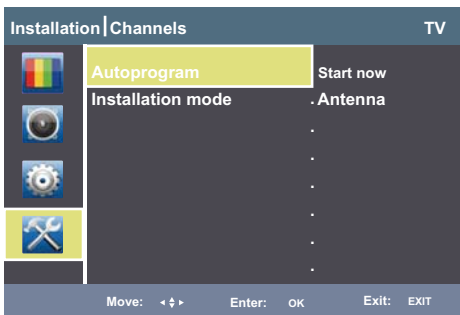

Time— Lets you set the exact time. You can setup date,time,time zone and daylight saving.

Source Labels—Lets you name input source.

Reset AV settings—Change setting back to default. (picture and sound only)

Note: Menu items that are not selectable are grayed out. Menus in this manual are described in TV mode, unless otherwise indicated.

Troubleshooting

Before calling for service, check the following information for possible solutions to problems you may experience. If none of these solutions work, turn off the TV, then turn it on again.

Caution: Do not try to repair the TV yourself. Refer all servicing to qualified repair personnel.

Video and audio

Problem	Solution
No picture (screen is not lit) and no sound.	<ul style="list-style-type: none"> • Make sure that the power cord is plugged in. • Press POWER  on the TV or the remote control. • Make sure that the correct video input source is selected. For more information, see "Selecting the video input source" on page 9. • Try another channel. The station may be experiencing problems.
Dark, poor, or no picture (screen is lit), but sound is good.	<ul style="list-style-type: none"> • Adjust the brightness. For more information, see "To adjust the picture:" on page 12. • Make sure that the correct picture mode is selected. For more information, see "To adjust the picture:" on page 12. • Make sure that the antenna or cable TV is connected correctly and securely. For more information, see "Connecting an antenna, cable TV, or satellite TV box" on page 8.
No color, dark picture, or color is not correct.	<ul style="list-style-type: none"> • Adjust the color saturation. For more information, see "Adjusting the picture" on page 12.
Only snow (noise) appears on the screen.	<ul style="list-style-type: none"> • Try another channel. The station may be experiencing problems. • Make sure that the antenna or cable TV is connected correctly and securely. For more information, see "Connecting an antenna, cable TV, or satellite TV box" on page 8.
Dotted lines or stripes appear on the screen.	<ul style="list-style-type: none"> • Adjust the antenna. • Move the TV away from noise sources such as cars, neon signs, or hair dryers.
Double images.	<ul style="list-style-type: none"> • Try using a highly directional outdoor antenna or cable TV.

Problem	Solution
The picture has a few bright or dark spots.	<ul style="list-style-type: none"> • A few bright or dark spots on an LED screen is normal. It does not affect the operation of this TV.
Good picture, but no sound.	<ul style="list-style-type: none"> • Make sure that the sound is not muted. • Make sure that the sound mode is set to Stereo or Mono. For more information, see "Selecting the audio mode" on page 12.
Audio noise.	<ul style="list-style-type: none"> • Make sure that there is no interference with infrared equipment such as a cordless telephone or headphones. Move the infrared equipment away from the TV to eliminate the noise.

Remote control

Problem	Solution
Remote control does not work.	<ul style="list-style-type: none"> • Make sure that the TV power cord is plugged in. • Make sure that there are no obstructions between the remote control and the remote control sensor on the front of the TV. • Make sure that the batteries are installed correctly. For more information, see "Installing remote control batteries" on page 6. • Replace the batteries. For more information, see "Installing remote control batteries" on page 6.
Trouble programming your existing universal remote control.	<ul style="list-style-type: none"> • See instructions and a table of common codes in "Programming a universal remote control to work with your TV" on page 7. • Codes are subject to change. For up to date codes, go to www.dynexproducts.com. • Replace the batteries. For more information, see "Installing remote control batteries" on page 6. • Refer to the User Guide that accompanied your universal remote control and contact the manufacturer if problems persist.

General

Problem	Solution
One or more channels do not display.	<ul style="list-style-type: none"> • Make sure that the channels are not blocked. For more information, see "Setting parental controls" on page 13.
Password is lost.	<ul style="list-style-type: none"> • Enter 0532 to access parental controls, then set a new password. For more information, see "Setting parental controls" on page 13.
Some settings cannot be accessed.	<ul style="list-style-type: none"> • If a setting is grayed, the setting is not available in the current video input mode.
TV cabinet creaks.	<ul style="list-style-type: none"> • When the TV is in use, the temperature rises naturally and may cause the cabinet to expand or contract which can cause a creaking noise. This is not a malfunction.
Control buttons on the TV do not work.	<ul style="list-style-type: none"> • Disconnect the power cord, wait a few seconds, then reconnect the power cord and turn on the TV.

Note: If the problem is not solved by using these troubleshooting instructions, try turning off your TV, then turning it on again.

Maintenance

Just like with any other household appliance, the performance and life-expectancy of your TV depends on how well you maintain it. Follow the procedures described here to clean the TV case and the **LED** screen.

Cautions:

- Make sure that the TV is turned off and the power cord is disconnected from the power outlet before cleaning the TV.
- Never spray or pour any liquid directly onto the screen or the case.

Cleaning

- Clean your TV with a soft, dry cloth. If surfaces are extremely dirty, use a soft cloth dampened with a small amount of non-ammonia, non-alcohol-based, non-abrasive detergent solution.
- Clean the screen with a clean, soft, lint-free cloth. If additional cleaning is necessary, apply a small amount of non-ammonia, non-alcohol-based, non-abrasive detergent solution to the cloth.

Specifications

Specifications subject to change without notice.
Weight and dimensions shown are approximate.

TV type	LED
TV panel	31.5-inch TFT LED
TV system	NTSC-M, ATSC
Receiving channels	VHF: 2 - 13 UHF: 14 - 69 CATV: 1 - 125 CADTV: 1-135 DTV: 2-69
Audio multiples	BTSC system
Audio out	6 W x 2
Power requirement	AC 120 V, 60 Hz
Power consumption	70 W (With Max backlight)
Dimensions (W x H x D with stand)	29.92 x 20.90 x 7.87 inches (760 x 531 x 200 mm)
Weight	22.04 lbs. (10 kg)
Wall Mounting VESA Size	100 X 100 (mm)
Wall-mount screws pattern	M4X25 (4 pc)
Input terminals	Composite video/L and R audio (1) Component video/L and R audio (2) HDMI (3) VGA/audio (1) ANT/Cable In (1) USB(1)
Output terminals	Digital Coaxial Audio (1) Headphone (1)
Control terminals	SERVICE PORT (2)
Video Input	NTSC-M
Component Input	480I/60Hz 480P/60Hz 720P/60Hz 1080I/60Hz 1080P/60Hz
PC Input	VGA (640 x 480 60Hz) SVGA (800 x 600 60Hz) SGA (1024 x 768 60Hz)
HDMI Input	RGB/60Hz(640 x 480 800 x 600 1024 x 768) YUV/60Hz (480I 480P 720P 1080I 1080P)

Legal notices

FCC Part 15

This device complies with Part 15 of the FCC Rules. Operation of this product is subject to the following two conditions: (1) this device may not cause harmful interference, and (2) this device must accept any interference received, including interference that may cause undesired operation.

This equipment has been tested and found to comply within the limits for a class B digital device, pursuant to Part 15 of the FCC Rules. These limits are designed to provide reasonable protection against harmful interference in a residential installation. This equipment generates, uses, and can radiate radio frequency energy and, if not installed and used in accordance with the instructions, may cause harmful interference to radio communications. However, there is no guarantee that interference will not occur in a particular installation. If this equipment does cause harmful interference to radio or television reception, which can be determined by turning the equipment off and on, the user is encouraged to try to correct the interference by one or more of the following measures:

- Reorient or relocate the receiving antenna.
- Increase the separation between the equipment and receiver.
- Connect the equipment into an outlet on a circuit different from that to which the receiver is connected.
- Consult the dealer or an experienced technician for help.

FCC warning

Changes or modifications not expressly approved by the party responsible for compliance with the FCC Rules could void the user's authority to operate this equipment.

Cables

Connections to this device must be made with shielded cables with metallic RF/EMI connector hoods to maintain compliance with FCC Rules and Regulations.

Canada ICES-003 statement

This Class B digital apparatus complies with Canadian ICES-003.
Cet appareil numérique de la classe B est conforme à la norme NMB-003 du Canada.

Standard Television Receiving Apparatus — Appareil de réception télévision ordinaire, Canada BETS-7 / NTMR-7

HDMI

HDMI®

HIGH-DEFINITION MULTIMEDIA INTERFACE

HDMI, the HDMI logo, and High-Definition Multimedia Interface are trademarks or registered trademarks of HDMI Licensing LLC.

Adjusting hotel settings

To adjust hotel settings:

- 1 Press **MENU**. The *Main* menu opens.
- 2 Press **▲** or **▼** to highlight **SOUND**, then press **ENTER** or **▶**, audio menu opens. Press **▲** or **▼** to highlight **balance**, use **◀** or **▶** to adjust to zero, then press the number buttons to enter the three-digit password 5 4 8. The Hotel Settings Menu opens.

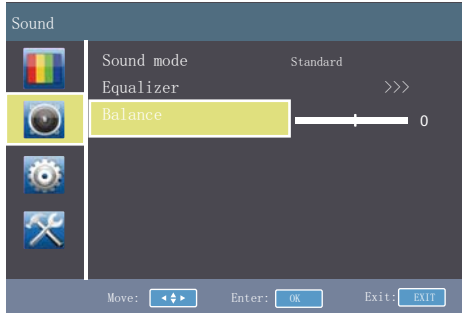

Note: Please redo above step if fail when opening Hotel Settings Menu.

- 3 Press **▲** or **▼** to highlight an option, then press **ENTER** or **▶** to access the option, press **▲** or **▼** to select a value and press **ENTER** to adjust the option. You can select:
 - **HOTEL MODE** —Allows installer to active or disable hotel options.
 - On** : Hotel options are active.
 - Off** : Hotel options are disabled.
 - **TV ON SETTING** —Allows installer to set up of initial options each time a guest turns TV on.

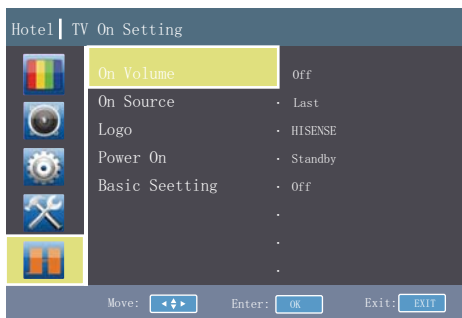

- **On Volume** —Adjust On Volume setting On or Off. In ON mode, **ON VOLUME VALUE** can be adjusted from 0 to 100.
- **On Source** —Allows installer to choose one of ten difference Input options. Choices include **TV, Video, Component, PC(computer), HDMI1, HDMI2, HDMI3 and DMP**. **LAST** will remember previous input source. **TV** on source will activate **ON CHANNEL** selection and **ON CHANNEL NUMBER**.
- **On Channel Number** —Allows installer to set up desired channel when TV is turned on. If no desired channel is requested or required, turn **ON CHANNEL** off.

- **LOGO** —Allows installer to choose one of three options. Choices are **OFF, HISENSE** and **WELCOME** .
 - OFF** : No logo when TV is turned on. TV goes directly to source.
 - HISENSE** : Displays Hisense TV logo.
 - WELCOME** : Displays welcome logo.
- **Power On** —Allows installer to select one of three options. Choices are **LAST, ON** and **Standby**.
 - LAST** : TV will return to whatever operation it was in before power out.
 - ON** : TV will turn on when power is restored.
 - Standby** : TV will be activated but not turned on.
- **Basic Setting** —Allows installer to active or disable basic settings.
 - ON** : TV picture defaults to Normal viewing mode, Normal Audio and Zoom Aspect is full screen.
 - OFF** : Installer can go to **User Save Lock** and adjust settings.
- **FUNCTION Lock** —Allows installer to lock the following functions.

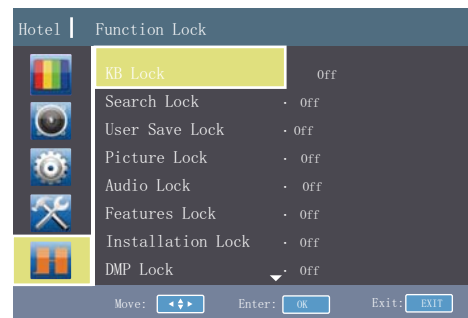

- **KB lock** —Locks key pad.
 - OFF** : Usable.
 - ON** : Locked down (disabled).
- **Search Lock** —Locks key pad.
 - OFF** : Usable.
 - ON** : Locked down (disabled).
- **User Save Lock** —Locks hotel guest adjustment.
 - OFF** : Menu features can be adjusted by hotel guest and be remembered in TV memory.
 - ON** : When TV is turned off, menu features will return to factory default settings.
- **Picture Lock** —Locks Picture adjustments in menu.
 - OFF** : Picture adjustments in menu are allowed by user.
 - ON** : Locks all picture adjustments.
- **Audio Lock** —Locks Audio adjustments in menu.
 - OFF** : Audio adjustments in menu are allowed by user.
 - ON** : Locks all audio adjustments except Balance.

- **Feature Lock**—Locks Feature menu adjustment in menu.
- **Installation Lock**—Locks Installation menu adjustment in menu.
- **DMP Lock**—Locks DMP menu adjustment in menu.
- **V-Chip**—Locks V-Chip function in menu.
- **Info Lock** —Turn on or off all available programing info.
 - OFF**: Programing name and description (if available) are displayed when info button on remote is touched. Programing info may also be available depending on provider.
 - ON**: No detail information on channel.
- **Hotel mute**— Allows installer to mute TV speaker.
 - ON**: TV is muted. User can not adjust volume.
 - OFF**: TV is not muted. User can adjust volume.
- **Input Selection** —Turn on or off all available inputs.
 - OFF**: Locked down (disabled).
 - ON**: Usable.
- **MAX VOLUME** —Allows installer to adjust max volume from 0 to 100. The volume value can be input by digit-number buttons on remote.
- **MIN VOLUME** —Allows installer to adjust minimum volume from 0 to 100. The volume value can be input by digit-number buttons on remote.
- **AUTO Standby** —Allows installer to turn Auto Standby function on or off.
 - OFF**: TV will stay on with no signal.
 - ON**: TV goes to Standby mode when there is no signal after 15 mimutes.
- **CHANNEL SETTINGS** —Allows access to channel setting without exiting hotel settings menu.
 - **Program Guide Edit**— In channel setting mode, Allows edit and remapping and editing of channels available. Using the color keys installer can change channel position and name.

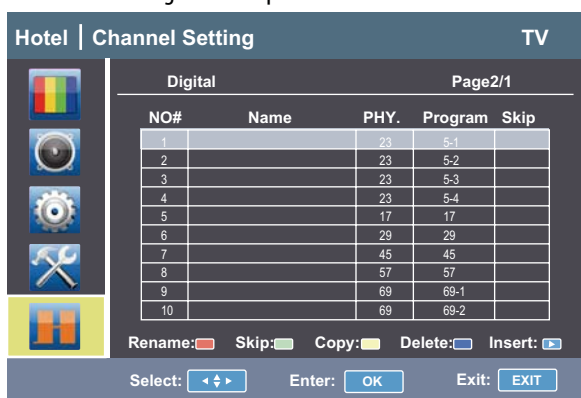

- **CLONE** —After you program first unit, you can use a USB driver to clone (copy) settings to any additional units you are installing.
 - A**--- First plug in USB driver to unit that is already set up.
 - B**--- Select READ OUT which brings up cloning function.
 - C**--- Select YES to clone (copy). When complete, TV will show upload success. Hotel Menu will close automatically.
- **CLONING OPTION 1.**
 - A**--- Plug in new TV.
 - B**--- Plug in loaded USB drive.
 - C**--- Turn TV on.
 - D**--- Press menu.
 - E**--- Key in numbers 2 5 6 3 on remote.
 - F**--- Cloning option will appear on screen.

- **CLONING OPTION 2.**
 - A**--- Take loaded USB drive to next unit, plug in next installation unit (You do not need to have sources connected).
 - B**--- Plug in loaded USB drive.
 - C**--- Turn TV on.
 - D**--- Go to Menu.
 - E**--- Go to Audio menu.
 - F**--- Go to Balance. Use arrows to adjust to zero.
 - G**--- Enter access code 548 with remote number key. Hotel menu opens.
 - H**--- Go to clone near bottom.
 - J**--- Choose option Write In. Hit Enter on remote. Cloning option will appear on screen.
 - k**--- Select Yes. System will acknowledge download success. TV will be cloned.
- **SSID setting**—Set or reset SSID code for Pro:Idiom decoding.
 - **Set SSID** —Enter new SSID code.
 - **Reset SSID**—Reset SSID code to factory default value.
 - yes**: Reset to factory default code.
 - No**: Maintain current settings.
- **SW Version**—shows current software version information.

