

USER MANUAL

Before using the TV, Please read this manual thoroughly, retain it for future reference.

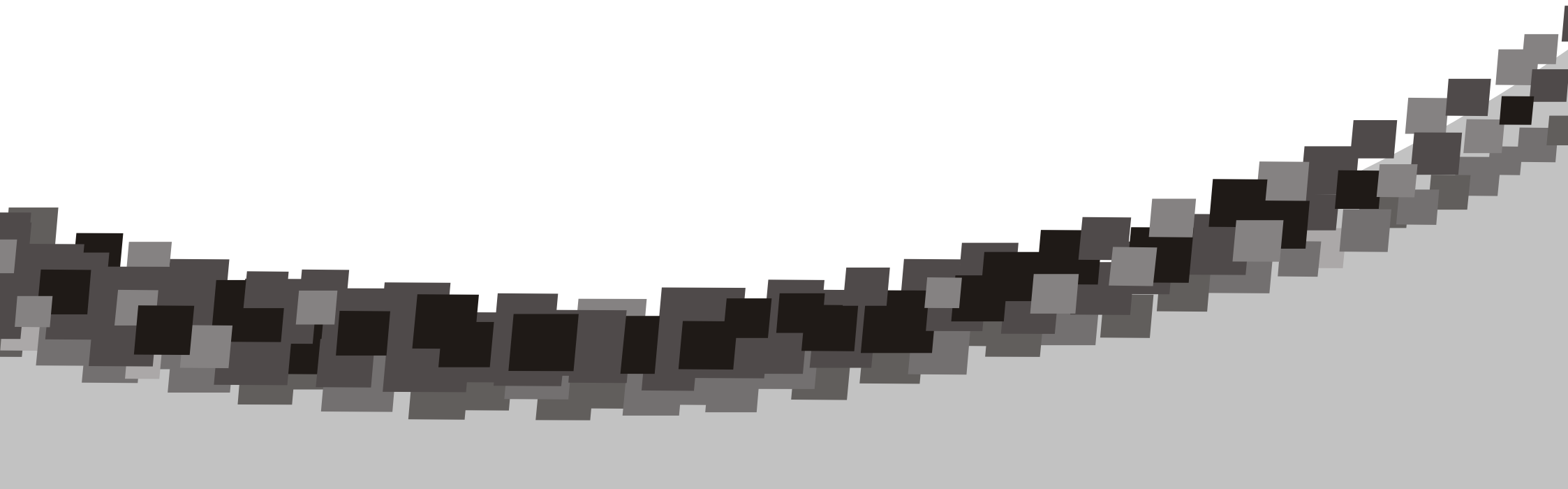

Table of contents

Important safety instructions	2
Warnings	2
Cautions	3
Accessories	3
Installing and removing the stand	3
Installing the stand	3
Attaching the TV to the desk	4
Removing the stand	4
Installing a wall-mount bracket	4
TV components	4
Front and side controls	4
Back connections	5
Remote control	5
Using the remote control	6
Installing remote control batteries	6
Aiming the remote control	6
Making connections	7
Connecting the power	7
Selecting a location	7
Connecting an HDMI device	7
Connecting a component video device	7
Connecting an antenna, cable TV, or satellite TV box	8
Connecting a VCR, camcorder, or game console	8
Connecting a computer	8
Connecting a home theater system	9
Connecting headphones	9
Connecting devices with USB interface	9
Understanding the basics	9
Turning your TV on or off	9
Selecting the video input source	9
Selecting a channel	9
Adjusting the volume	9
Displaying program information	10
Navigating the menus	10
On-screen menu overview	10
Adjusting the picture	12
Choosing the display format (aspect ratio)	12
Adjusting the sound	12
Selecting the audio mode	12
Adjusting the Features	12
Adjusting the Installation	14
Troubleshooting	14
Video and audio	15
Remote control	15
General	15
Maintenance	16
Cleaning	16
Specifications	16
Legal notices	16
Adjusting hotel settings	17

CHILD SAFETY

It makes a difference how and where you use your flat panel display

As you enjoy your new product, keep these safety tips in mind

The issue

The home theater entertainment experience is a growing trend, and larger TVs are popular purchases. However, TVs are not always supported on the proper stands or installed according to the manufacturer's recommendations. We and the consumer electronics industry are committed to making home entertainment enjoyable and safe.

TVs that are inappropriately placed on dressers, bookcases, shelves, desks, speakers, chests, or carts may fall over and cause injury.

Tune into safety

- One size of TV stand does **not** fit all. Use only a TV stand rated for the weight of your TV.
- Carefully read and understand all enclosed instructions for proper use of this product.
- Don't let children climb on or play with entertainment system furniture and TVs.
- Don't place TVs on furniture that can easily be used as steps, such as a crate or chest of drawers.
- Remember that children can become excited while watching a program, especially on a "larger-than-life" TV. Make sure that you place or install the TV where it cannot be pushed, pulled over, or knocked down.
- Make sure that you route all cords and cables so that they cannot be pulled or grabbed by curious children.

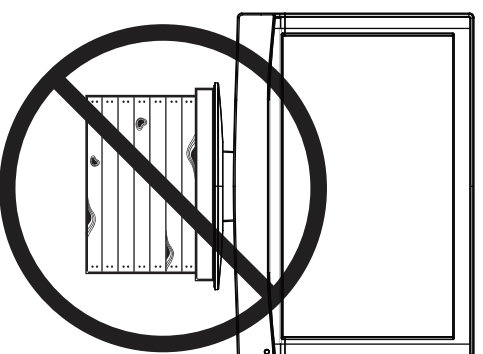

Wall mounting

If you decide to wall mount your TV, always remember:

- One size of wall mount does **not** fit all. Use only a wall mount rated for the weight of your TV and that has been recommended by this TV manufacturer, listed in this manual, or otherwise listed by an independent laboratory as suitable for your TV.
- Follow all instructions supplied by the TV and wall mount manufacturers.
- If you have any doubts about your ability to safely wall mount your TV, get help from a professional installer.
- Make sure that the wall where you are mounting the TV is appropriate. Some wall mounts are not designed to be mounted to walls backed with steel studs or cinder blocks. If you are unsure, ask a professional installer.
- TVs can be heavy. At least two people are required for safe wall mount installation.

Important safety instructions

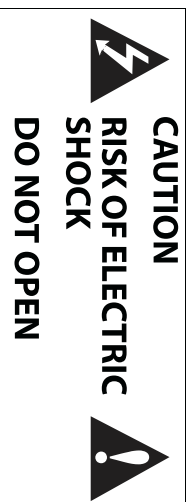

This symbol indicates that dangerous voltage constituting a risk of electric shock is present within your TV. This label is located on the back of your TV.



This symbol indicates that there are important operating and maintenance instructions in the literature accompanying your TV.

- 1 Read these instructions.
- 2 Keep these instructions.
- 3 Heed all warnings.
- 4 Follow all instructions.
- 5 Do not use this apparatus near water.
- 6 Clean only with a dry cloth.
- 7 Do not block any ventilation openings. Install in accordance with the manufacturer's instructions.
- 8 Do not install near any heat sources such as radiators, heat registers, stoves, or other apparatus (including amplifiers) that produce heat.
- 9 Do not defeat the safety purpose of the polarized or grounding-type plug. A polarized plug has two blades with one wider than the other. A grounding type plug has two blades and a third grounding prong. The wide blade or the third prong are provided for your safety. If the provided plug does not fit into your outlet, consult an electrician for replacement of the obsolete outlet.
- 10 Protect the power cord from being walked on or pinched particularly at plugs, convenience receptacles, and the point where they exit from the apparatus.
- 11 Only use attachments/accessories specified by the manufacturer.
- 12 Use only with a cart, stand, tripod, bracket, or table specified by the manufacturer, or sold with the apparatus. When a cart is used, use caution when moving the cart/apparatus combination to avoid injury from tip-over.  CS125K
- 13 Unplug this apparatus during lightning storms or when unused for long periods of time.
- 14 Refer all servicing to qualified service personnel. Servicing is required when the apparatus has been damaged in any way, such as power-supply cord or plug is damaged, liquid has been spilled or objects have fallen into the apparatus, the apparatus has been exposed to rain or moisture, does not operate normally, or has been dropped.
- 15 The wall plug is the disconnecting device. The plug must remain readily operable.
- 16 An apparatus with a three-prong, grounding-type plug is a Class I apparatus, which needs to be grounded to prevent possible electric shock. Make sure that you connect this Class I television to a grounding-type, three-prong outlet.
- 17 Remote control batteries should not be exposed to excessive heat such as sunshine, fire, or the like.

- 18 The apparatus should not be exposed to dripping or splashing, and no objects filled with liquids, such as vases, should be placed on the apparatus.

Warnings

Electric shock hazard

To reduce the risk of fire or electric shock, do not remove any cover or expose the device to rain or moisture. No user-serviceable parts are inside. Refer servicing to qualified service technicians.

Lightning

For added protection for your device receiver during a lightning storm, or when it is left unattended and unused for long periods of time, unplug it from the power outlet and disconnect any antenna or cable system. This helps prevent property damage and personal injury from lightning and power line surges.

Power lines

An outside antenna system should not be located in the vicinity of overhead power lines or other electric light or power circuits, or where it can fall into such power lines or circuits. When installing an outside antenna system, extreme care should be taken to keep from touching such power lines or circuits as contact with them might be fatal.

Handling the LED panel

- Your TV's screen is made of glass. Do not drop your TV or hit, jolt, or press hard against the LED panel. If the screen breaks, be careful of broken glass.
- If the LED panel is broken, make absolutely sure that you do not touch the liquid in the panel. This may cause skin inflammation.
- If the liquid gets in your mouth, immediately gargle, rinse, and consult with your doctor. Also, if the liquid gets in your eyes or touches your skin, consult with your doctor after rinsing for at least 15 minutes or longer in clean water.

Replacement parts

When replacement parts are required, make sure that the service technician uses replacement parts specified by the manufacturer that have the same characteristics as the original part. Unauthorized substitutions may result in fire, electric shock, personal injury, or other hazards.

Safety check

After completing any service or repair to this device, ask the service technician to perform routine safety checks to determine that your TV is in correct operating condition.

Power source

Operate your TV only from the type of power source indicated on the marking label. If you are not sure of the type of power supplied to your home, consult an electrician or your local power company.

HDMI™

This TV incorporates High-Definition Multimedia Interface (HDMI™) technology. HDMI, the HDMI logo and High-Definition Multimedia Interface are trademarks or registered trademarks of HDMI Licensing LLC.

Cautions

Damage requiring service

- Unplug this TV from the power outlet and refer servicing to qualified service personnel under the following conditions:
- When the power supply cord or plug is damaged or frayed.
 - If liquid has been spilled or objects have fallen into your TV.
 - If your TV has been exposed to rain or water.
 - If your TV does not operate normally by following the operating instructions. Adjust only those controls that are covered by the operating instructions because incorrect adjustment of other controls may result in damage and will often require extensive work by a qualified technician to restore your TV to its normal operation.
 - If your TV has been dropped or damaged in any way.
 - When your TV exhibits a distinct change in performance.

Outdoor antenna grounding

If an outside antenna or cable system is connected to your TV, make sure that the antenna or cable system is grounded to provide some protection against voltage surges and built-up static charges. Article 810 of the National Electrical Code, ANSI/NFPA No. 70, provides information with respect to correct grounding of the mast and supporting structure, grounding of the lead-in wire to an antenna discharge unit, size of grounding conductors, location of the antenna-discharge unit, connection to grounding electrodes, and requirements for the grounding electrode.

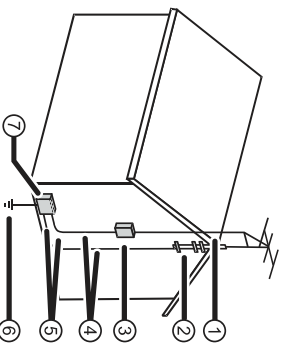

①	Antenna lead-in wire
②	Grounding clamp
③	Antenna discharge unit
④	Grounding conductors
⑤	Ground clamps
⑥	Power service grounding electrode system
⑦	Electric service equipment

Note to CATV system installer

Article 820 of the National Electrical Code, ANSI/NFPA No. 40 provides guidance for correct grounding. Specifically, it states that the cable ground must be connected to the grounding system of the building as close to the point of cable entry as practical.

Condensation

Moisture will form on the TV if the TV is brought from cool surroundings into a warm room or if the temperature of the room rises suddenly. When this happens, the TV's performance may be impaired. To prevent this, let the TV stand in its new surroundings for about an hour before switching it on, or make sure that the room temperature rises gradually.

Condensation may also form during the summer if the TV is exposed to the breeze from an air conditioner. In such cases, change the location of the TV.

Mobile telephone warning

To avoid interference with your TV picture and sound, operating problems, or even damage, keep your cordless and cellular telephones away from the TV.

End of life directives

Your TV contains tin-lead solder and a fluorescent lamp containing a small amount of mercury. Disposal of these materials may be regulated for environmental reasons. Your TV also contains material that can be recycled and reused. For disposal or recycling information, contact your local authorities or the Electronic Industries Alliance at www.eia.org to find a recycler in your area.

Non-active pixels

The LED panel contains almost 3 million thin film transistors, which provide exceptionally sharp video quality. Occasionally, a few non-active pixels may appear on the screen as a fixed blue, green, or red point. These non-active pixels do not adversely affect the performance of your TV, and are not considered defects.

Accessories

Make sure the following accessories are included in the box with your TV:

- Remote control
- User manual
- AC power cord
- AAA batteries (2)
- Stand
- Quick Setup Guide

Installing and removing the stand

You must install your TV into the stand in order for it to stand upright on a cabinet or other flat surface. If you intend to mount your TV on a wall or other vertical surface, you must remove the stand.

Warning: Before attempting assembly or removal of the stand, unplug the AC power cord.

Cautions:

- Read these instructions carefully before you try to assemble the stand or remove the stand.
- Make sure that you handle the TV carefully when attempting to assemble or remove the stand. If you are not sure of your ability to do this, contact a professional installer or service technician. Hisense is not responsible for any damages or injuries that occur because of mishandling or incorrect assembly.
- Use a soft cushion or covering to prevent scratching or damage to the TV screen or cabinet.

Installing the stand

Note: Your TV may differ from the illustrations shown.

To install the stand:

1. Insert the stand column into the base plate, aligning the ridge on the column with the groove in the base plate.
Making sure the FRONT of stand column match the FRONT of base plate.
Secure the stand column to the base plate with the four screws (M4, 12mm) provided.

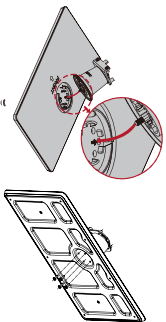

2 Secure the stand cover to the stand column vertically with the 2 screws (M4, 12mm) provided. Secure the stand cover to the stand column horizontally with the 2 screws (ST4, 14mm) provided.

3 Insert the stand cover into the slot of TV bottom side and secure the stand to the TV with the four provided screws (M5, 12 mm).

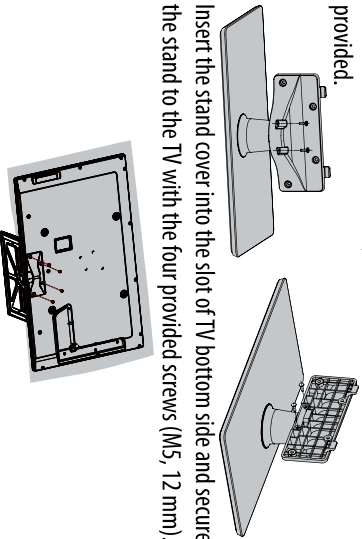

Attaching the TV to a desk

Here shown may be somewhat different from your TV. The TV must be attached to desk so it cannot be pulled in a forward/backward direction, potentially causing injury or damaging the product.

Screws:M5×L(table depth + 8~10mm)

Example:Table depth = 15mm Screws:M5×25

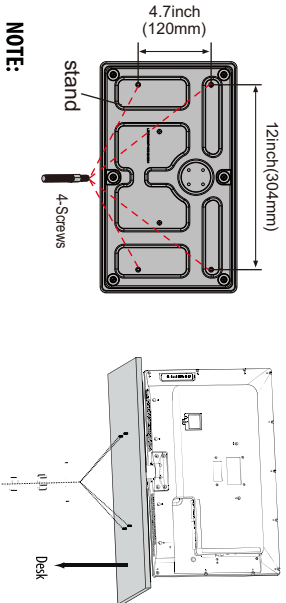

NOTE:

Be sure to follow the instructions in correct installation of the stand (pedestal) may result in the TV falling over.

Removing the stand

You must remove the stand before you can wall-mount the TV.

Note: Your TV may differ from the illustrations shown.

To remove the stand:

- 1** Lay the TV (screen down) on the edge of the table or bench. Make sure that you put a soft cloth or cushion between the table or bench and the TV.
- 2** Remove the 4 screws holding the stand to the TV, then remove the stand.

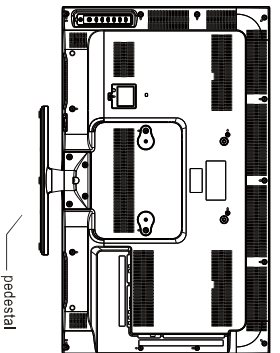

Installing a wall-mount bracket

If you want to attach the TV to a wall-mount bracket, you should first remove the stand if it is pre-attached. Carefully place your TV screen face-down on a cushioned, clean surface to protect the screen from damages and scratches. Insert four spacers (provided) into the corresponding bracket screw holes on the back of your TV, then attach the wall-mount bracket to your TV using four M6 x 30 screws (provided) or the screws/spacers provided with the wall-mount bracket. See the instructions that came with the wall-mount bracket for screw/washer configurations and information on how to correctly hang your TV.

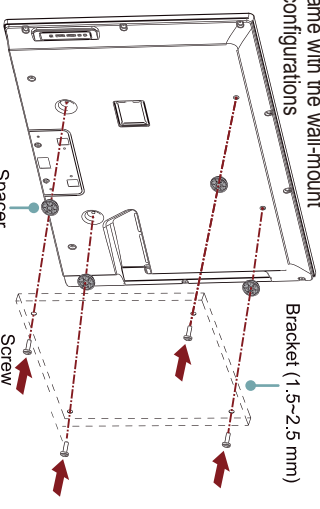

Warning
To prevent internal damage to the TV and ensure the TV is mounted securely, be sure to use fixing screws (provided)

Wall-mount hole pattern VESA (mm)	200 x 200
Wall-mount screw size (mm)	M6

TV components

Front and side controls

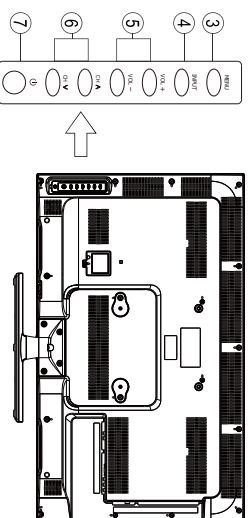

①	Power indicator	The light shows whether the TV is on or standby mode.
②	Remote control sensor	Receives signals from the remote control. Please do not block.
③	MENU	Display the onscreen display(OSD) or Exit to close the OSD.
④	INPUT	Select the INPUT menu.
⑤	VOL+ / VOL-	Volume adjusting bottom, to increase or decrease the volume.
⑥	CH ▲/CH▼	Channel selection bottom, to increase or decrease the channel.
⑦	⏻ (power)	Press to turn your TV on or off (standby mode).

①	Power indicator	The light shows whether the TV is on or standby mode.
②	Remote control sensor	Receives signals from the remote control. Please do not block.
③	MENU	Display the onscreen display(OSD) or Exit to close the OSD.
④	INPUT	Select the INPUT menu.
⑤	VOL+ / VOL-	Volume adjusting bottom, to increase or decrease the volume.
⑥	CH ▲/CH▼	Channel selection bottom, to increase or decrease the channel.
⑦	⏻ (power)	Press to turn your TV on or off (standby mode).

Back connections

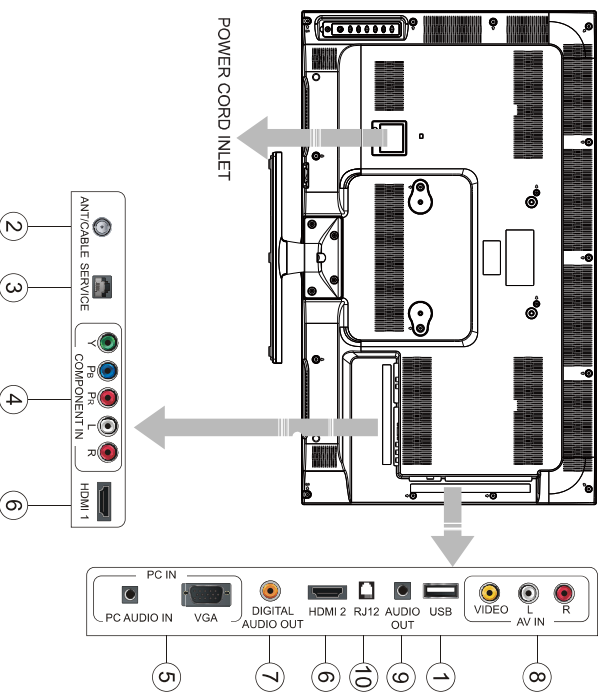

Item	Name	Description
①	USB	This unit has USB interface and can be connected the stand avd USB 1.1 and USB 2.0 USB FLASH STICK.
②	ANT IN jack	Connect an antenna or cable TV to this jack.
③	SERVICE	Service only, don't use.
④	COMP	Connect component video devices to these jacks.
⑤	PC AUDIO jacks	Connect a computer (audio and video) to these jacks.
⑥	HDMI 1/2	Connect an HDMI device to one of these jacks.
⑦	DIGITAL AUDIO OUT jack	Connect a digital coaxial cable to this connector, then to a digital sound system.
⑧	AV jack	Connect a standard AV device, such as a camcorder or game console, to these jacks.
⑨	(headphone) jack	Plug headphones into this jack.
⑩	RJ12	Connect a RJ-12 Cable to this jack, then to an external control device(such as a computer or A/V control system), to control the TV functions externally.

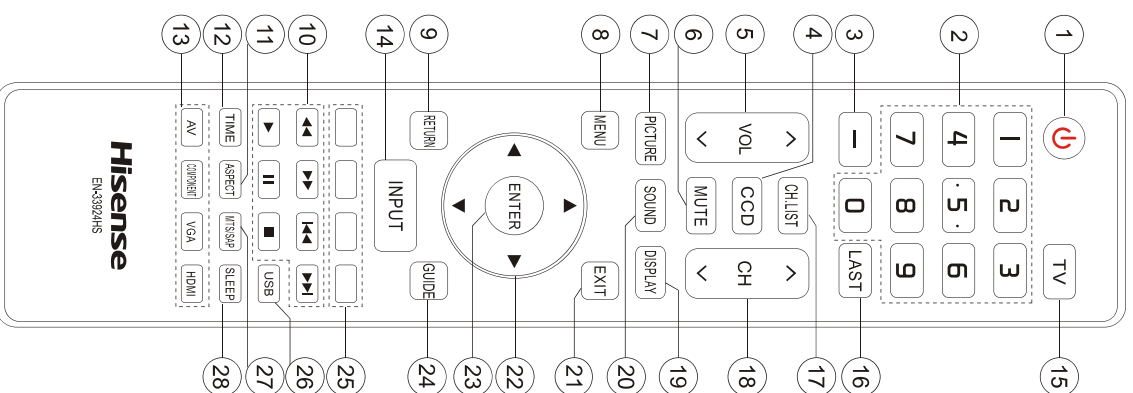

Item	Name	Description
①	POWER	Press to turn on the TV or put the TV in standby mode. Caution: The TV continues to receive power even in standby mode. Unplug the power cord to disconnect power.
②	Numbers	Press the number buttons to enter channel numbers or the parental control password.
③	(dash)	Press to select a digital sub-channel.
④	CCD	Press to turn closed captioning on or off. For more information.
⑤	VOL ^ / VOL v	Press to increase or decrease the volume.
⑥	MUTE	Press to mute the sound. Press again to restore the sound.
⑦	PICTURE	Press to select the video mode. You can select Standard, Custom, Vivid, Game, Cinema and Power Saver.
⑧	MENU	Display the main menu. Go back to preview menu.
⑨	RETURN	Not available.

Item	Name	Description
10	◀▶	Play the previous files.
	▶▶	Play the next files.
	▶■	When you are listening to music and enjoy pictures, you can switch between playing and pause through this button.
	■	Exit the current state.
	◀◀	Not available.
	▶▶	Not available.
11	ASPECT (Zoom button)	Select screen mode.
12	TIME	Not available.
13	AV/COMPONENT /G/A/HDMI	Select VIDEO/COMPONENT/ PC / HDMI source.
14	INPUT	Press to open the <i>INPUT SOURCE</i> menu, then press ▲ or ▼ to select the video input source you want.
15	TV	Press to select the TV as the video input source.
16	LAST	Return to previous channel.
17	CH.LIST	Display the channel name.
18	CH▲/CH▼	Press to go to the next or previous channel in the Channel list.
19	DISPLAY	Display the information banner.
20	SOUND	Press to select the sound mode. You can select standard, custom, dynamic and clear voice.
21	EXIT	Press to close the on-screen menu.
22	▲▶▶▶	Press ▲ or ▼ to move up or down in on-screen menus. Press ◀ or ▶ to move left or right in on-screen menus or to adjust menu settings.
23	ENTER	Press to confirm selections in on-screen menus or to open sub-menus.
24	GUIDE	Press to open the DTV program guide(if available).
25	Program guide (EPG) function buttons	After pressing the GUIDE button in the digital TV channel option, the same color buttons will appear with explanations in the on-screen display (OSD). Follow the steps shown in the OSD.
26	USB	Select DMP source.
27	MTS/SAP	In analog TV mode, press to select STEREO, SAP (secondary audio language), or MONO . In digital TV mode (DTV), press to select the audio track. For more information.
28	SLEEP	Press to set the sleep timer.

Using the remote control

Installing the remote control batteries

To install remote control batteries:

- 1 Press down on the battery compartment cover lock, then remove the remote control cover.
- 2 Insert two AAA batteries into the battery compartment. Make sure that the + and – symbols on the batteries match the + and – symbols in the battery compartment.
- 3 Replace the cover. Make sure that the lock snaps into place.
- 4 Install screw.



Battery precautions:

- Dispose of batteries as hazardous waste.
- Do not mix batteries of different types.
- Do not mix old and new batteries. Mixing old and new batteries can shorten the life of new batteries and can cause old batteries to leak.
- Remove batteries as soon as they become inoperable. Chemicals that can leak from the batteries can cause a rash. If the batteries leak, clean the battery compartment with a cloth.
- If the remote control is not used for an extended period of time, remove the batteries.
- Do not expose batteries to excessive heat such as sunshine, fire, or other heat sources.

Aiming the remote control

To aim the remote control:

- Point the remote control towards the remote sensor on the front of your TV.

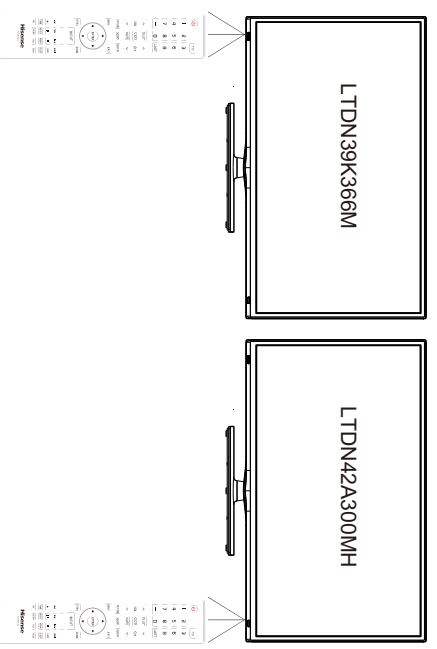

Notes:

- Do not expose the remote control to shock or liquids.
- Do not use the remote control in an area with high humidity.
- Do not place the remote control in direct sunlight.
- Do not place objects, such as furniture, between the remote control and the remote sensor.
- The remote control may not work if direct sunlight or bright light shines on the remote sensor. Either move your TV or change the angle at which you use the remote control.

Making connections

Before you make any connections:

- Check the plugs on the ends of cables to make sure that they are the correct type before you try plugging them into jacks on the TV.
- Make sure that all plugs are securely inserted into the jacks. Loose connections can result in image or color problems.
- When connecting devices to the TV, make sure that the TV and the device are turned off and that the power cords are unplugged.

Connecting the power

To connect the power cord:

- Connect the power cable to the **AC IN** jack on the back of the TV, then connect the other end to a power outlet.

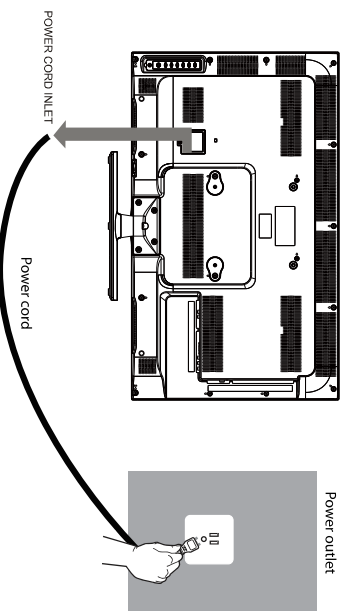

Notes:

- The AC plug on the TV may be different from the one shown.
- Make sure that you only use the type of power source indicated on the marking label.
- Always unplug the power cord when not using the TV for a long period of time.

Selecting a location

You should select a location for the TV:

- Where direct light does not reflect on the screen
- That has indirect and soft lighting
- Where the TV has access to an antenna or cable TV connection
- Where the TV has access to a power outlet

Note: Watching TV in total darkness or with a reflection on the screen may cause eye strain.

Connecting an HDMI device

Note: If your device has an HDMI connection, we recommend you use it to get the best picture and sound quality possible.

To connect an HDMI device:

- Connect one end of an HDMI cable (not included) to the HDMI 1 or HDMI 2 jack on the side of your TV, then connect the other end of the cable to the HDMI OUT jack on the HDMI device.

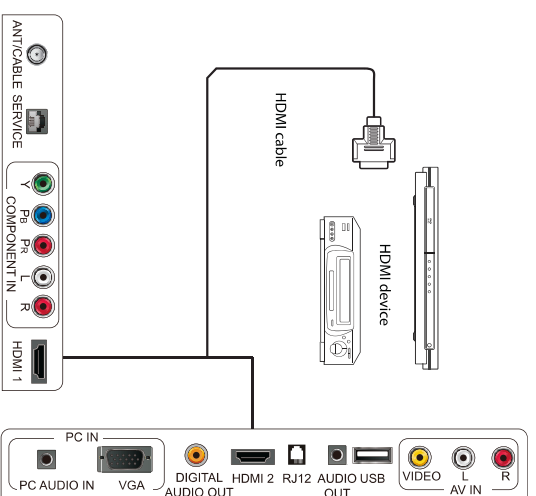

Note: To connect a DVI device, use a DVI to HDMI adapter cable to connect to the **HDMI** jack on the TV, then connect an audio cable to the **PC AUDIO** jack on the back of the TV.

To play from the HDMI device:

- 1 Turn on the TV, then press **INPUT**. The **INPUT SOURCE** menu opens.
- 2 Press **▲** or **▼** to select **HDMI1**, **HDMI2** then press **ENTER**.
- 3 Turn on the HDMI device, then set it to the correct mode. Refer to the instructions that came with the HDMI device.

Connecting a component video device

Component cables often have red, green, and blue color-coded video connectors and red and white audio connectors. Match the colors when making connections.

To connect a component video device:

- 1 Make sure that your TV's power cord is unplugged and the component video device is turned off.
- 2 Connect a component video cable to the **COMPONENT OUT** jacks on the component video device.

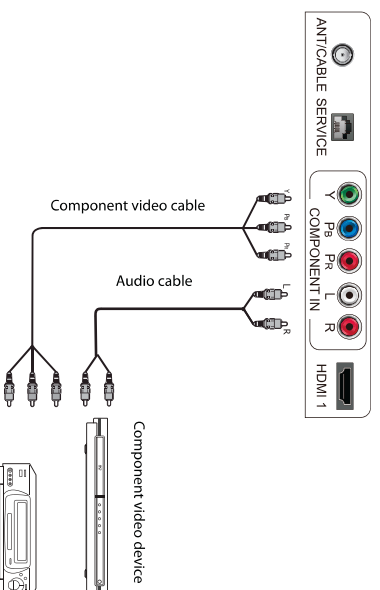

- 3 Connect the other end of the component video cable to the **COMPONENT** jacks on the back/side of your TV.
- 4 Connect an audio cable to the **AUDIO OUT** jacks (L/R) on the component device.
- 5 Connect the other end of the audio cable to the **COMPONENT AUDIO-R** and **AUDIO-L** jacks on the back/side of your TV.

To play from the component video device:

- 1 Turn on the TV, then press **INPUT**. The **INPUT SOURCE** menu opens.
- 2 Press **▲** or **▼** to select **Component**, then press **ENTER**.
- 3 Turn on the component video device and start playback. Refer to the instructions that came with the component video device.

Connecting an antenna, cable TV, or satellite TV box

If you are connecting a satellite TV or cable box, you can use one of the following (if available):

- Best - HDMI cable
- Better - Video component cables
- Good - Video composite cable
- Acceptable - 75-ohm coaxial cable.

To connect an antenna, cable TV, or satellite TV box:

- Connect one end of a 75-ohm, coaxial cable to the **ANT IN** jack on the back of the TV, then connect the other end of the cable to the antenna or cable TV wall jack.

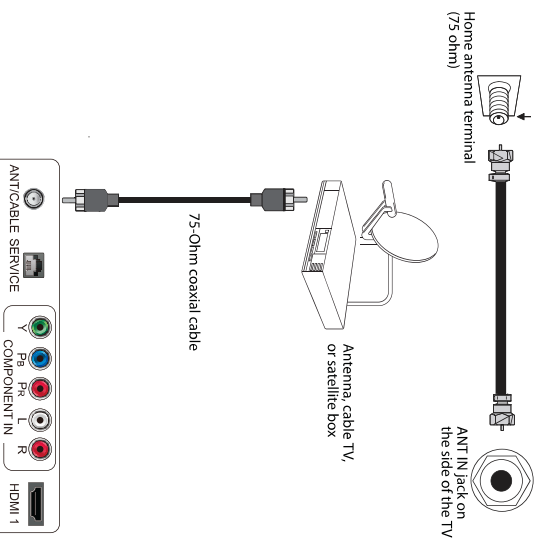

Notes:

- We recommend using a 75-ohm, coaxial cable to reduce interference and noise that may be caused by radio wave transmissions.
- Do not bundle the coaxial cable with the power cord or any other cables.
- If you are using an antenna and reception is not good, contact a service technician to adjust the antenna.

Connecting a VCR, camcorder, or game console

Note: If the VCR, camcorder, or game console has component jacks (better), or an HDMI jack (best), connect them using the best available connection.

To connect a VCR, camcorder, or game console:

- 1 Make sure that your TV's power cord is unplugged and the VCR, camcorder, or game console is turned off.
- 2 Connect one end of a standard AV cable (not included) into the **AV** video jack on the back of the TV, then connect the other end of the cable to the **AV OUT VIDEO** jack on the external device.

- 3 Connect the audio connectors of the AV cable (the red and white connectors) to the **AV OUT AUDIO** jacks of the external device, then connect them to the **AV L** and **R** jacks on the back of your TV.



Note: Cables are often color-coded to connectors. Connect yellow to yellow, red to red, and white to white.



To play the external AV device:

- 1 Turn on the TV, then press **INPUT**. The **INPUT SOURCE** menu opens.
- 2 Press **▲** or **▼** to select **Video**, then press **ENTER**.
- 3 Turn on the device, then start playback on the device.

Connecting a computer

To connect a computer:

- 1 Make sure that your TV's power cord is unplugged and the computer is turned off.
- 2 Connect one end of a VGA cable (not included) to the **VGA** jack on the side of the TV, then connect the other end of the cable to the **VGA** jack on the computer. The D-Sub cable will not supplied with the product. We strongly recommend to use D-Sub cable with 2 cores as shown in the figure.

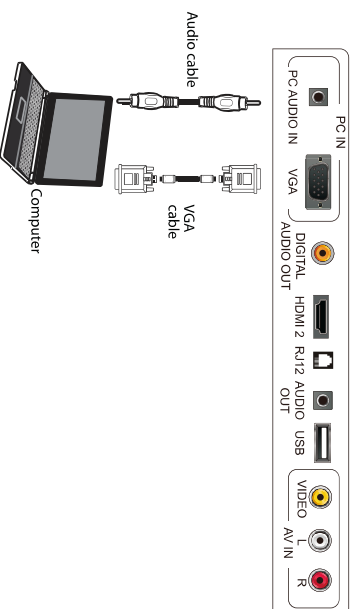

- 3 Connect one end of an audio cable with a stereo mini-plug (not included) to the **PC AUDIO** jack on the side of the TV, then connect the other end of the cable to the **AUDIO OUT** jack on the computer.

To play video from the computer:

- 1 Turn on the TV, then press **INPUT**. The **INPUT SOURCE** menu opens.
- 2 Press **▲** or **▼** to select **PC**, then press **ENTER**.
- 3 Turn on the computer, then adjust the computer display properties as needed.