

Hisense

USER MANUAL

Before using the TV, please read this manual thoroughly and retain it for future reference.

English

CHILD SAFETY:

It Makes A Difference How and Where
You Use Your Flat Panel Display

Congratulations on your purchase! As you enjoy your new product, please keep these safety tips in mind:



THE ISSUE

- The home theater entertainment experience is a growing trend and larger flat panel displays are popular purchases. However, flat panel displays are not always supported on the proper stands or installed according to the manufacturer's recommendations.
- Flat panel displays that are inappropriately situated on dressers, bookcases, shelves, desks, speakers, chests or carts may fall over and cause injury.

THIS MANUFACTURER CARES!

- The consumer electronics industry is committed to making home entertainment enjoyable and safe.

TUNE INTO SAFETY

- One size does NOT fit all. Follow the manufacturer's recommendations for the safe installation and use of your flat panel display.
- Carefully read and understand all enclosed instructions for proper use of this product.
- Don't allow children to climb on or play with furniture and television sets.
- Don't place flat panel displays on furniture that can easily be used as steps, such as a chest of drawers.
- Remember that children can become excited while watching a program, especially on a "larger than life" flat panel display. Care should be taken to place or install the display where it cannot be pushed, pulled over, or knocked down.
- Care should be taken to route all cords and cables connected to the flat panel display so that they cannot be pulled or grabbed by curious children.



WALL MOUNTING: IF YOU DECIDE TO WALL MOUNT YOUR FLAT PANEL DISPLAY, ALWAYS:

- Use a mount that has been recommended by the display manufacturer and/or listed by an independent laboratory (such as UL, CSA, ETL).
- Follow all instructions supplied by the display and wall mount manufacturers.
- If you have any doubts about your ability to safely install your flat panel display, contact your retailer about professional installation.
- Make sure that the wall where you are mounting the display is appropriate. Some wall mounts are not designed to be mounted to walls with steel studs or old cinder block construction. If you are unsure, contact a professional installer.
- A minimum of two people are required for installation. Flat panel displays can be heavy.



Important Safety Instructions

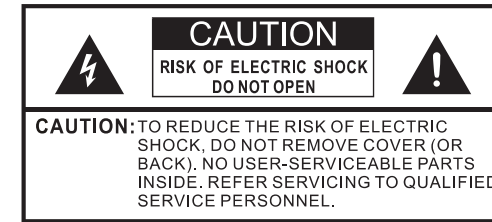

The lightning flash with arrowhead symbol, within an equilateral triangle is intended to alert the user to the presence of uninsulated dangerous voltage within the product's enclosure that may be of sufficient magnitude to constitute a risk of electric shock.



The exclamation point within an equilateral triangle is intended to alert the user to the presence of important operating and maintenance (servicing) instructions in the literature accompanying the appliance.

1. Read these instructions.
2. Keep these instructions.
3. Heed all warnings.
4. Follow all instructions.
5. Do not use this apparatus near water.
6. Clean only with dry cloth.
7. Do not block any ventilation openings. Install in accordance with the manufacturer's instructions.
8. Do not install near any heat sources such as radiators, heat registers, stoves, or other apparatus (including amplifiers) that produce heat.
9. Do not defeat the safety purpose of the polarized or grounding-type plug. A polarized plug has two blades with one wider than the other. A grounding type plug has two blades and a third grounding prong. The wide blade or the third prong are provided for your safety. If the provided plug does not fit into your outlet, consult an electrician for replacement of the obsolete outlet.
10. Protect the power cord from being walked on or pinched particularly at plugs, convenience receptacles, and the point where they exit from the apparatus.
11. Only use attachments/accessories specified by the manufacturer.
12. Use only with cart, stand, tripod, bracket, or table specified by the manufacturer, or sold with the apparatus. When a cart is used, use caution when moving the cart/apparatus combination to avoid injury from tip-over.
13. Unplug this apparatus during lightning storms or when unused for long periods of time.



Important Safety Instructions

14. Refer all servicing to qualified service personnel. Servicing is required when the apparatus has been damaged in any way, such as power-supply cord or plug is damaged, liquid has been spilled or objects have fallen into the apparatus, the apparatus has been exposed to rain or moisture, does not operate normally, or has been dropped.
15. To reduce the risk of fire or electric shock, do not expose this apparatus to rain or moisture.
16. The battery (battery or batteries or battery pack) shall not be exposed to excessive heat such as sunshine, fire or the like.
17. The mains plug is used as disconnect device, the disconnect device shall remain readily operable.
18. This equipment is a Class II or double insulated electrical appliance. It has been designed in such a way that it does not require a safety connection to electrical earth.
19. Apparatus should not be exposed to dripping or splashing, and objects filled with liquids, such as vases, should not be placed on the apparatus.
20. An outside antenna system should not be located in the vicinity of overhead power lines or other electric light or power circuits, or where it can fall into such power lines or circuits. When installing an outside antenna system, extreme care should be taken to keep from touching such power lines or circuits, as contact with them might be fatal.
21. Do not overload wall outlets and extension cords, as this can result in a risk of fire or electric shock.
22. Do not push objects through any openings in this unit, as they may touch dangerous voltage points or short out parts that could result in fire or electric shock. Never spill or spray any type of liquid into the unit.

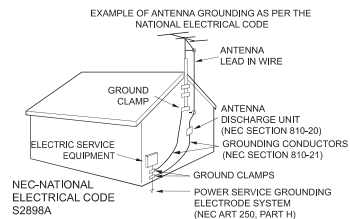

23. If an outside antenna or cable system is connected to the unit, be sure the antenna or cable system is grounded to provide some protection against voltage surges and built-up static charges, Section 810 of the National Electrical Code, ANSI/NFPA 70, provides information with respect to proper grounding of the mast and supporting structure, grounding of the lead-in wire to an antenna discharge unit, size of grounding conductors, location of antenna discharge unit, connection to grounding electrodes, and requirements for the grounding electrode.

Important Safety Instructions

24. When replacement parts are required, be sure the service technician uses replacement parts specified by the manufacturer or those that have the same characteristics as the original part. Unauthorized substitutions may result in fire, electric shock or other hazards.
25. Upon completion of any service or repairs to this unit, ask the service technician to perform safety checks to determine that the unit is in proper operating condition.
26. When you connect the product to other equipment, turn off the power and unplug all of the equipment from the wall outlet. Failure to do so may cause an electric shock and serious personal injury. Read the owner's manual of the other equipment carefully and follow the instructions when making any connections.
27. Sudden high volume sound may cause hearing or speaker damage. When you use headphones, (if the unit is equipped with a headphone jack) keep the volume at a moderate level. If you use headphones continuously with high volume sound, it may cause hearing damage.

CONDENSATION:

Moisture will form in the operating section of the unit if the unit is brought from cool surroundings into a warm room or if the temperature of the room rises suddenly. When this happens, unit's performance will be impaired. To prevent this, let the unit stand in its new surroundings for about an hour before switching it on, or make sure that the room temperature rises gradually.

Condensation may also form during the summer if the unit is exposed to the breeze from an air conditioner. In such cases, change the location of the unit.

HOW TO HANDLE THE LCD PANEL:

- Do not press hard or jolt the LCD panel. It may cause the LCD panel glass to break and injury may occur.
- If the LCD panel is broken, make absolutely sure that you do not touch the liquid in the panel. This may cause skin inflammation.
If the liquid gets in your mouth, immediately gargle and consult with your doctor. Also, if the liquid gets in your eyes or touches your skin, consult with your doctor after rinsing for at least 15 minutes or longer in clean water.

Possible Adverse Effects on LCD Panel:

If a fixed (non-moving) pattern remains on the LCD Panel for long periods of time, the image can become permanently engrained in the LCD Panel and cause subtle but permanent ghost images. This type of damage is NOT COVERED BY YOUR WARRANTY. Never leave your LCD Panel on for long periods of time while it is displaying the following formats or images:

- Fixed Images, such as stock tickers, video game patterns, TV station logos, and websites.

Important Safety Instructions

- Special Formats that do not use the entire screen. For example, viewing letterbox style (16:9) media on a normal (4:3) display (black bars at top and bottom of screen); or viewing normal style (4:3) media on a widescreen (16:9) display (black bars on left and right sides of screen).

The following symptoms are not signs of malfunction but technical limitation. Therefore we disclaim any responsibility for these symptoms.

- LCD Panels are manufactured using an extremely high level of precision technology, however sometimes parts of the screen may be missing picture elements or have luminous spots.
This is not a sign of a malfunction.
- Do not install the LCD Panel near electronic equipment that produces electromagnetic waves. Some equipment placed too near this unit may cause interference.
- Effect on infrared devices - There may be interference while using infrared devices such as infrared cordless headphones.

End of life directives

Your TV also contains material that can be recycled and reused. For disposal or recycling information, contact your local authorities or the Electronic Industries Alliance at www.eia.org to find a recycler in your area.

Non-active pixels

The LCD panel contains almost 3 million thin film transistors, which provide exceptionally sharp video quality. Occasionally, a few non-active pixels may appear on the screen as a fixed black (in the case of a dead pixel), blue, green, or red point. These non-active pixels do not adversely affect the performance of your TV, and are not considered defects.

Power source

TO USE AC POWER

1. The power cord is attached to the TV at the factory.
2. Connect the AC cord into an AC outlet.

⚠ WARNING

Do not connect this unit to the power using any device other than the supplied AC cord. This could cause fire, electrical shock, or damage.

Do not use with a voltage other than the power voltage specified. This could cause fire, electrical shock, or damage.

⚠ CAUTION

When this unit is not used for a long time, (e.g., away on a trip) in the interest of safety, be sure to unplug it from the AC outlet.

Do not plug/unplug the AC cord when your hands are wet. This may cause electrical shock.

Instructions importantes de sécurité

	ATTENTION RISQUE DE CHOC ÉLECTRIQUE NE PAS OUVRIR	
ATTENTION : POUR RÉDUIRE LE RISQUE DE CHOC ÉLECTRIQUE, NE PAS ENLEVER LE COUVERCLE OU LE DOS. AUCUNE PIÈCE À ÊTRE ENTRETENUE PAR L'UTILISATEUR NE SE TROUVE À L'INTÉRIEUR. POUR L'ENTRETIEN, CONSULTER LE PERSONNEL DE SERVICE QUALIFIÉ.		



L'éclair accompagné d'une flèche dans des triangles équilatéraux avertit l'utilisateur de la présence d'une tension dangereuse non isolée, dans l'enveloppe du produit, suffisante pour poser un risque de choc électrique.



Le point d'exclamation dans les triangles équilatéraux avertit l'utilisateur de la présence d'importantes instructions d'utilisation et d'entretien dans la documentation qui accompagne l'appareil.

1. Lire ces instructions.
2. Conserver ces instructions.
3. Respecter tous les avertissements.
4. Suivre toutes les instructions.
5. Ne pas utiliser ce dispositif près de l'eau.
6. Nettoyer seulement avec un chiffon sec.
7. Ne bloquez pas les ouvertures de ventilation. Installez conformément aux instructions du fabricant.
8. Ne pas installer près de sources de chaleur telles que radiateurs, registres de chaleur, poêles ou d'autres appareils (y compris les amplificateurs) qui produisent de la chaleur.
9. Ne contournez pas le dispositif de sécurité d'une fiche polarisée. Une fiche polarisée possède deux lames dont l'une est plus large que l'autre. Une fiche de type mise à la masse possède deux lames et une fourche de mise à la masse. La lame large ou la troisième fourche sont conçues pour assurer votre sécurité. Si la fiche fournie ne s'insère pas dans la prise murale, consultez un électricien pour le remplacement de la prise désuète.
10. Protégez le cordon d'alimentation pour éviter qu'on ne marche dessus, ou qu'il ne soit pincé, en particulier au niveau des prises, des prises de courant et au point où il sort de l'appareil.
11. Utiliser seulement des accessoires spécifiés par le fabricant.
12. Utilisez uniquement un chariot, support, trépied, fixation ou table recommandés par le fabricant ou vendus avec l'appareil. Lorsque le chariot est utilisé, fait attention lors du déplacement de la combinaison chariot/appareil afin d'éviter des blessures causées par son renversement.
13. Débranchez cet appareil durant les orages électriques ou lorsqu'il est inutilisé pendant de longues périodes.



Instructions importantes de sécurité

14. Pour toute réparation, consultez un personnel de service qualifié. Des réparations sont requises lorsque l'appareil a été endommagé d'une façon ou d'une autre, par exemple lorsque le cordon d'alimentation est endommagé, si du liquide a été renversé ou si des objets sont tombés dans l'appareil, si l'appareil a été exposé à la pluie ou à l'humidité, s'il ne fonctionne pas normalement, ou s'il a été échappé.
15. Afin de réduire le risque d'incendie ou de choc électrique, n'exposez pas cet appareil à la pluie ou à l'humidité.
16. Les piles (ou le bloc-piles) installées ne doivent pas être exposées à une chaleur intense, comme la lumière du soleil, le feu et d'autres sources de chaleur semblables.
17. Lorsque la fiche d'alimentation est utilisée comme dispositif de débranchement de l'appareil, elle doit rester facilement accessible.
18. Cet appareil est un appareil électrique à double isolation, de classe II. Il a été conçu de telle sorte qu'il ne nécessite pas une connexion de sécurité à la terre électrique.
19. L'appareil ne doit pas être exposé à des égouttements ou éclaboussures, ni des objets remplis de liquides, tels que des vases, ne doivent être placés sur l'appareil.
20. Un système d'antenne extérieure ne doit pas être placé à proximité des lignes électriques aériennes non plus que de tout autre circuit électrique, ou à un endroit d'où il pourrait tomber dans de telles lignes ou circuits électriques. Lors de l'installation d'un système d'antenne extérieure, vous devez être extrêmement prudent et faire attention de ne pas toucher les lignes ou circuits électriques car leur contact pourrait être fatal.
21. Ne surchargez pas les prises murales et les cordons d'extension car cela pourrait entraîner un risque d'incendie ou de choc électrique.
22. Ne poussez jamais aucun objet d'aucune sorte dans les fentes de l'appareil car il pourrait toucher des points de tension élevée ou causer un court-circuit qui pourrait entraîner un incendie ou un choc électrique. Ne renversez jamais et ne vaporisez aucun type de liquide sur l'appareil.

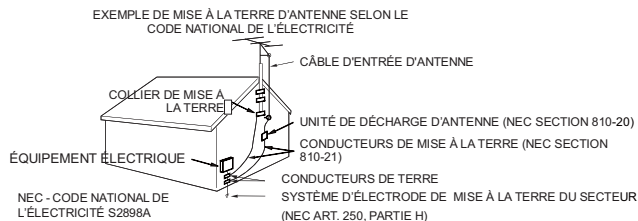

23. Si une antenne ou un système de câble extérieur est branché à l'appareil, assurez-vous que l'antenne ou le système est relié à la terre afin de protéger contre la surtension ou les décharges électrostatiques. La section 810 du Code national de l'électricité, ANSI/NFPA 70, renseigne sur la mise à la terre appropriée du mât et de la structure de soutien, la mise à la terre du fil conducteur à une unité de décharge d'antenne, la taille des conducteurs de terre, l'emplacement de l'unité de décharge d'antenne, la connexion aux électrodes de terre et les exigences concernant l'électrode de terre.

Instructions importantes de sécurité

24. Lorsque des pièces de rechange sont requises, assurez-vous qu'un technicien de service utilise des pièces de rechange spécifiées par le fabricant ou celles qui ont les mêmes caractéristiques que la pièce d'origine. Des substitutions non autorisées peuvent entraîner un incendie, un choc électrique ou autres risques.
25. Une fois l'entretien ou la réparation terminée, demandez au technicien d'effectuer une vérification de sécurité afin d'établir si l'appareil fonctionne correctement.
26. Si vous connectez le produit à un autre appareil, éteignez-le et débranchez-le de la prise de courant. Autrement vous risquez un choc électrique ou des blessures graves. Lisez le manuel de l'utilisateur de l'autre appareil et suivez les directives de connexion.
27. Un son soudain d'intensité élevée peut endommager l'ouïe ou les haut-parleurs. Si vous utilisez des écouteurs (appareil doté d'une prise d'écouteurs), tenez l'intensité sonore à un niveau moyen. L'utilisation continue d'écouteurs à intensité sonore élevée peut endommager l'ouïe.

CONDENSATION :

De l'humidité peut se former dans la partie fonctionnelle de l'appareil si celui-ci passe d'un endroit frais à un endroit chaud ou si la température de la pièce s'élève subitement. Dans pareil cas, le rendement de l'appareil peut diminuer. Pour éviter une telle situation, laissez l'appareil s'ajuster au niveau milieu pendant une heure environ avant de l'allumer ou assurez-vous que la température de la pièce s'élève graduellement.

Une condensation peut aussi se former en été si l'appareil est exposé au courant d'air d'un climatiseur. Dans pareil cas, changez l'emplacement de l'appareil.

MANIPULATION DU PANNEAU ACL :

- N'appuyez pas fort sur l'ACL et ne le secouez pas. Vous risqueriez de briser le verre de l'ACL et de vous blesser.
- Si l'ACL est brisé, assurez-vous de ne pas toucher le liquide dans le panneau. Le liquide peut irriter la peau.
- Si vous avalez du liquide, gargarisez-vous immédiatement et consultez un médecin. Si le liquide entre en contact avec les yeux ou la peau, rincez-les pendant au moins 15 minutes à l'eau claire et consultez un médecin.

Effets nocifs possibles de l'écran ACL :

Si un motif fixe reste à l'écran pendant une longue durée, l'image peut devenir imprégnée en permanence sur l'écran ACL et former une image fantôme subtile mais permanente. Ce type de dommage n'est PAS COUVERT PAR LA GARANTIE. Ne laissez jamais l'écran ACL allumé pendant une longue durée quand il affiche des images des types suivants :

- Images fixes comme les résultats de la Bourse, les motifs de jeu vidéo, les logos de stations de télévision et les sites Web.

Instructions importantes de sécurité

- Formats spéciaux qui ne couvrent pas l'écran entier. Par exemple, visualiser le format boîte aux lettres (16:9) sur écran normal (4:3) (barres noires en haut et en bas de l'écran) ou vue normale (4:3) sur grand écran (16:9) (barres noires sur la gauche et la droite de l'écran).

Les symptômes suivants ne sont pas des signes de dysfonctionnement, mais de limitation technique. Par conséquent, nous déclinons toute responsabilité quant à ces symptômes.

- Les écrans ACL sont fabriqués avec un niveau extrêmement élevé de précision mais certaines parties de l'écran peuvent ne pas avoir d'éléments d'image ou présenter des points lumineux. Il ne s'agit pas d'un signe de mauvais fonctionnement.
- N'installez pas l'écran ACL près d'un équipement électronique qui génère des ondes électromagnétiques. Certains équipements sont placés trop près de l'appareil peuvent provoquer des interférences.
- Effet sur les appareils à infrarouge - Il peut y avoir des interférences quand on utilise un appareil à infrarouges comme un téléphone sans fil à infrarouges.

Directives de fin de vie

Votre téléviseur contient des matériaux qui peuvent être recyclés et réutilisés. Pour de l'information en rapport avec la mise au rebut et le recyclage, contactez les autorités locales ou Electronic Industries Alliance : www.eia.org.

Pixels non actifs

L'écran ACL compte près de 3 millions de transistors en couches minces fournissant une qualité d'image extrêmement élevée. À l'occasion, des pixels inactifs peuvent apparaître à l'écran sous forme de point fixe noir (pixel mort), bleu, vert ou rouge. Ces pixels inactifs ne nuisent pas au rendement de votre téléviseur et ne sont pas considérés un vice.

Source d'alimentation

POUR UTILISER L'ALIMENTATION C.A.

1. Le cordon d'alimentation est branché au téléviseur à l'usine.
2. Branchez le cordon dans une prise de courant.

⚠ AVERTISSEMENT

Ne branchez pas l'appareil à l'aide d'un dispositif autre que le cordon fourni car cela présenterait un risque d'incendie, de choc électrique ou de dommage. N'utilisez pas une tension autre que celle spécifiée pour l'appareil car cela présenterait un risque d'incendie, de choc électrique ou de dommage.

⚠ ATTENTION

Pour des raisons de sécurité, débranchez l'appareil de la prise de courant si vous prévoyez ne pas l'utiliser pendant une période prolongée (ex. : voyage). Ne branchez/débranchez pas le cordon d'alimentation si vous avez les mains mouillées car cela pourrait provoquer un choc électrique.

Important Safety Instructions

When Installing the TV Against a Wall or Enclosed Area

Make sure that your TV has adequate air circulation. Allow enough space around the TV as shown below. Avoid operating the TV at temperatures below Inadequate air 41°F (5°C).

Install with Base

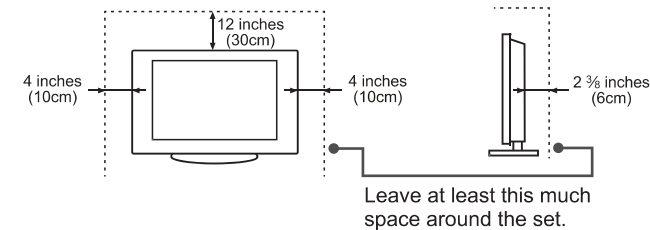

Install on the wall

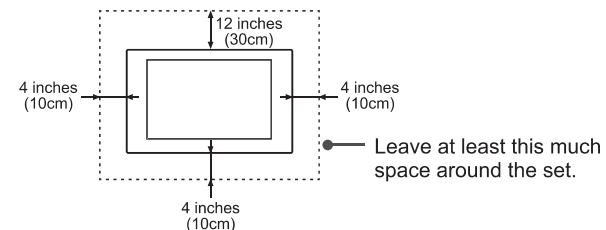

Never install the TV set as follows:

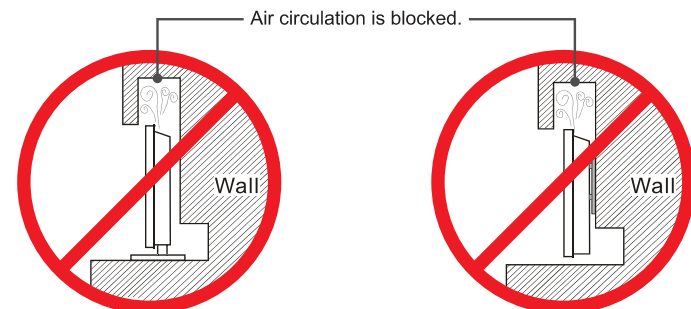

Inadequate air circulation can lead to overheating of the TV and may cause damage to your TV or cause a fire.

FCC Statement

FCC ID : W9HLCDD0041

This device complies with Part 15 of the FCC Rules. Operation is subject to the following two conditions: (1) this device may not cause harmful interference, and (2) this device must accept any interference received, including interference that may cause undesired operation.

NOTE:

This equipment has been tested and found to comply with the limits for a class B digital Device, pursuant to part 15 of the FCC Rules. These limits are designed to provide reasonable protection against harmful interference in a residential installation. This equipment generates, uses and can radiate radio frequency energy and, if not installed and used in accordance with the instructions, may cause harmful interference to radio Communications. However, there is no guarantee that interference will not occur in a particular installation. If this equipment does cause harmful interference to radio or television reception, which can be determined by turning the equipment off and on, the user is encouraged to try to correct the interference by one or more of the following measures:

- Reorient or relocate the receiving antenna.
- Increase the separation between the equipment and the receiver.
- Connect the equipment into an outlet on a circuit different from that to which the receiver is connected.
- Consult the dealer or an experienced radio/TV technician for help.

Energy Star

Your Hisense TV is ENERGY STAR[®] qualified in the “Energy Savings” mode. It meets strict energy efficiency guidelines set by the U.S. Environmental Protection Agency and Department of Energy. ENERGY STAR is a joint program of these government agencies, designed to promote energy efficient products and practices. Changes to certain features, settings, and functionalities of this TV (i.e. TV Guide, Picture, Sound) can increase or change the power consumption. Depending upon such changed settings, the power consumption may exceed the limits required for the ENERGY STAR qualification in the “Energy Savings” mode.



NOTE

Where the MAINS plug or an appliance coupler is used as the disconnect device, the disconnect device shall remain readily operable.

WARNING

The manufacturer is not responsible for any radio or TV interference caused by unauthorized modifications to this equipment. Such modifications could void the user's authority.

This TV incorporates High-Definition Multimedia Interface (HDMI[™]) technology.

HDMI, the HDMI logo and High-Definition Multimedia Interface are trademarks or registered trademarks of HDMI Licensing LLC.

Hisense and associated logos where applicable are registered trademarks of Hisense Group in the United States and/or other countries. All other trademarks are property of their respective owners. 2011 Hisense USA, Corporation. All Rights Reserved.

Manufactured under license from Dolby Laboratories. Dolby and the double-D symbol are trademarks of Dolby Laboratories.

* Specifications subject to change without notice.



Contents

Getting Started

Accessories List.....	2
Installing the Base	2
Viewing the Control Panel	3
Viewing the Remote Control	4
Installing Batteries in the Remote Control	5
Making Connections	6

Basic Features

Turning your TV on or off	11
Selecting the Input Source	11
Changing Channels / Volume	11
Shortcuts Instructions	12
Turning your TV for the First Time	13
To Use the Main Menu.....	14
Using the Picture Menu	14
Using the Sound Menu	15
Using the Time Menu.....	16
Using the Setup Menu	16
Using the Lock Menu	17
Using the Channel Menu.....	19
PC Setting.....	19

Advanced Features

Digital Media Player.....	21
Browse the Pictures.....	22
Enjoy Music Files.....	22
Enjoy Video Files.....	23
Playable Format List.....	24
Trouble Shooting.....	25

Getting Started

Accessories List

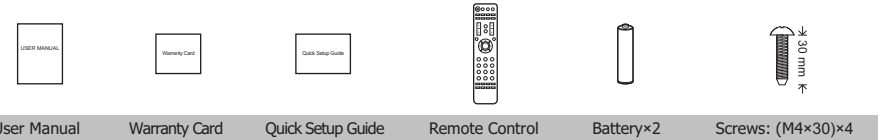

Installing the Base

NOTES

1. The LCD display is very fragile, and must be protected at all times when removing the Table-Top Stand. Be sure that no hard or sharp object, or anything that could scratch or damage the LCD display, comes into contact with it. DO NOT exert pressure on the front of the TV at any time because the screen could crack.
2. For tabletop use, the TV must be attached to the provided base as shown on this page.
3. To Wall-Mount, the Table-Top Stand must be removed from the TV first, and the brackets (not provided) must be attached to the TV. Please refer to the Wall Bracket Installation Instruction (inside the Wall Bracket Box).

WARNING

Be sure to disconnect the AC power cord before installing a base or Wall-Mount brackets.

CAUTION

Follow the illustrations below to complete the installation steps:

1. Attach the stand to the TV set as shown in the picture.
2. Use the screws (M4 × 30) × 4 to fix the stand tightly.

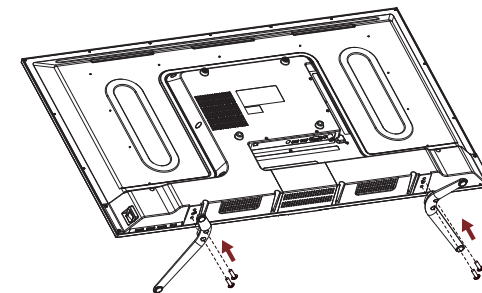

Getting Started

Viewing the Control Panel

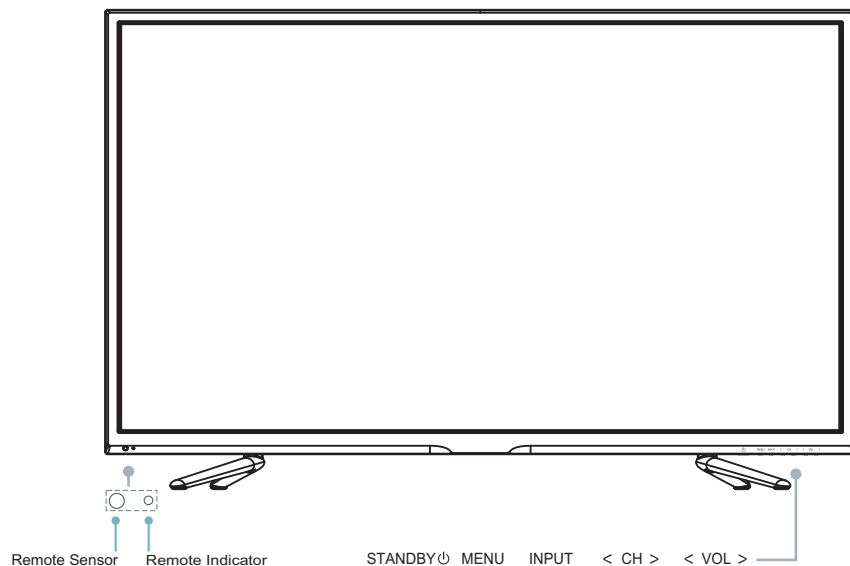

item	Description
Remote Sensor	Receive remote signals from the remote control. Do not put anything near the sensor, as its function may be affected.
Remote Indicator	Red light up in standby mode. Blue light up in power on mode
MENU	Open the OSD menu
INPUT	Select among the different signal sources.
< CH >	Select the channel
< VOL >	Adjust the volume.
STANDBY	Turn on the TV or put the TV in standby mode.

NOTES

- FOR ILLUSTRATION ONLY.
- Powering up or down the TV requires several seconds of processing time. Do not rapidly turn the TV on/off as abnormal operation may occur.

Getting Started

Viewing the Remote Control

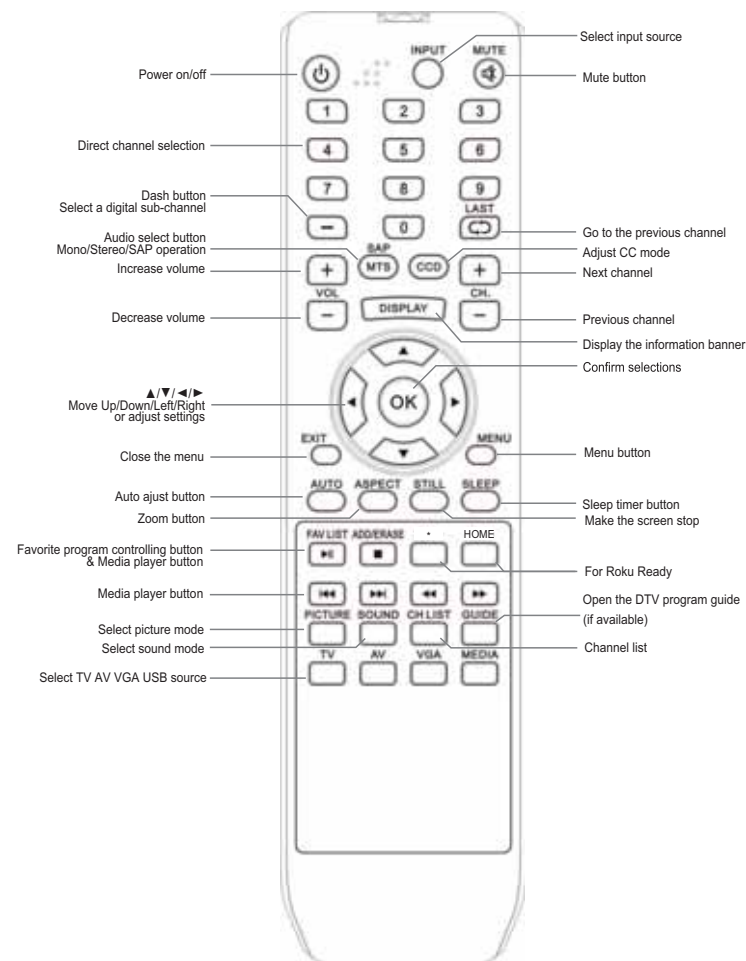

Program Your Universal Cable or Satellite Remote Control to Operate Your New Hisense Television!

If you would like to program your other household remote controls to your new Hisense television, please consult the User's Manual supplied by your Cable or Satellite provider. The Cable or Satellite providers' User's Manuals should include instructions on how to program their remote to your television.

Getting Started

Below is a list of Hisense codes for the most common Cable and Satellite providers. Use the Hisense code that is associated with your Cable or Satellite provider(if applicable).

DIRECTV.....	0178 or 10019
Time Warner Cable.....	386,0178 or 10178
Comcast	0178 or 10178
Cox Communications	0178 or 10178
Dish Network	627 or 505
AT&T U-verse	1346 or 1041

NOTE

If the Hisense code associated with your Cable or Satellite provider is not listed above, if the code above does not work, or if you cannot locate the instructions for programming your household remote to your television, call your local Cable or Satellite provider's customer service center. If your Cable or Satellite provider does not have an Hisense code available, please visit <http://www.hisense-usa.com> for additional codes.

Installing Batteries in the Remote Control

Change the batteries

1. Push the back cover to open the battery compartment of the remote control.
2. Insert two AAA size batteries. Make sure to match the (+) and (-) ends of the batteries with the (+) and (-) ends indicated in the battery compartment.
3. Close the battery compartment cover.

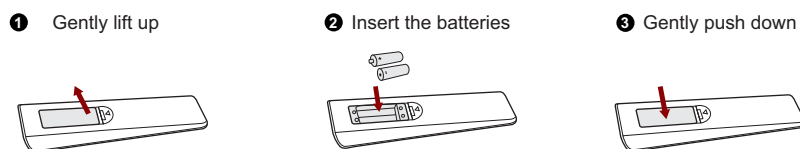

NOTES

1. Dispose of your batteries in a designated disposal area. Do not throw the batteries into fire.
2. Remove depleted batteries immediately to prevent battery acid from leaking into the battery compartment.
3. If you do not intend to use the remote control for a long time, remove the batteries.
4. Battery chemicals can cause a rash. If the batteries leak, clean the battery compartment with a cloth. If chemicals touch your skin, wash immediately.
5. Do not mix old and new batteries.
6. Do not mix alkaline, standard (carbon-zinc) or rechargeable (ni-cad, ni-mh, etc.) batteries.
7. The batteries shall not be exposed to excessive heat such as sunshine, fire or the like.

Getting Started

Making Connections

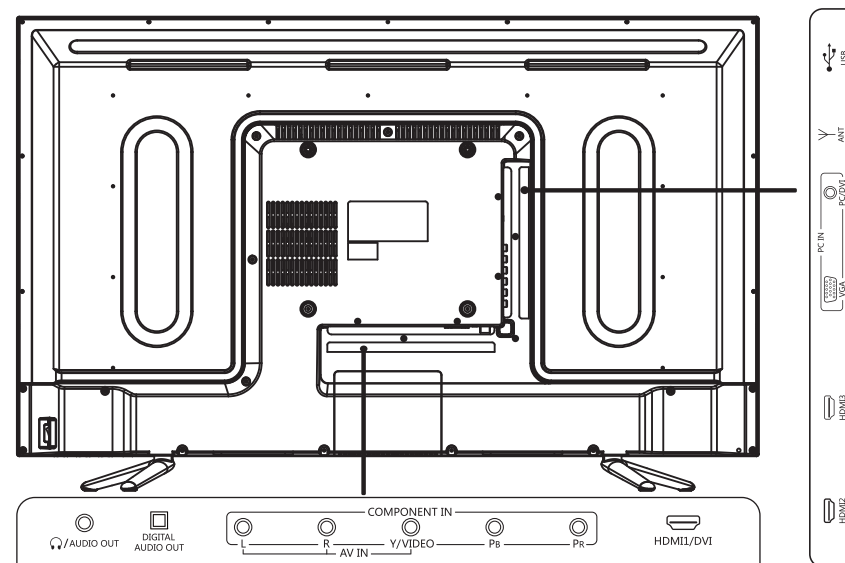

Item	Description
ANT/CABLE IN	Connect an antenna or cable TV to this jack.
HDMI/DVI	HDMI (High-Definition Multimedia Interface) provides an uncompressed, all digital audio/video interface between this TV and any HDMI-device, such as a set-top box, Blu-ray disc player, or A/V receiver.
COMPONENT IN	Connect to a DVD player, Digital Set-Top-Box, or other A/V devices with component (YPBPR) video and audio output jacks. Component audio Jack share with AV IN audio Jack. Support: 480i\480p\720p\1080i\1080p.
AV IN	Connect to the composite video and audio (L/R) output jacks on external video devices.
VGA PC/DVI AUDIO IN	Connect to a PC or other devices with a VGA interface.
/AUDIO OUT	Connect headphone or analog sound system using RCA Y-cable (1/8"-stereo mini to L/R phono-not provided).
DIGITAL AUDIO OUT	Connect to an external digital audio device.
USB	Photo, Music, Movie play and software update.

NOTE

Some external devices impossible insert to this set for individual difference. Please replace with appropriate external signal cable or increase the adapter to match with the port in such case.

Getting Started

NOTES

- Check the jacks for position and type before making any connections. Loose connections can result in image or color problems. Make sure that all connections are tight and secure.
- Not all A/V devices have the ability to connect to a TV, please refer to the user's manual of your A/V device for compatibility and connections procedure.
- Always unplug the power cord when connecting external equipment.

Connecting an antenna, cable or cable/satellite box

1. Turn off the TV before connecting the antenna.
2. Connect one end of a coaxial cable (not included) to the RF OUT jack on the antenna, cable or cable/satellite box. If you are using an antenna with twin-lead cable, you may need a 300-75 ohm adapter (not provided) to connect it to the back of your TV. Likewise, if you are using several antennas, you may need a combiner (not provided).
3. Connect the other end of the cable to the ANT/CABLE IN jack on the side of your TV.

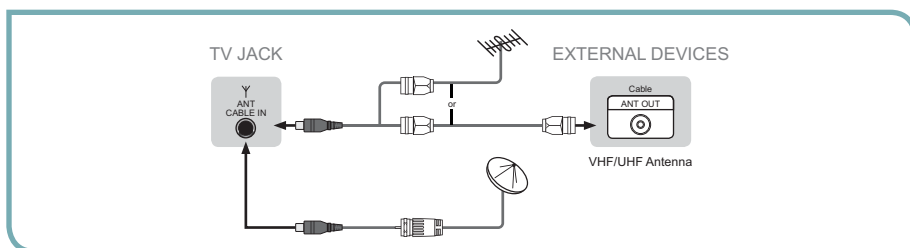

Connecting an A/V Device with Composite Cable

1. Use the audio and video cables to connect the external A/V device's composite video/audio jacks to the TV's jacks. (Video = yellow, Audio Left = white, and Audio Right = red)
2. Plug the connected devices into the mains socket before switching on the TV.
3. Select the corresponding source from the TV.

Getting Started

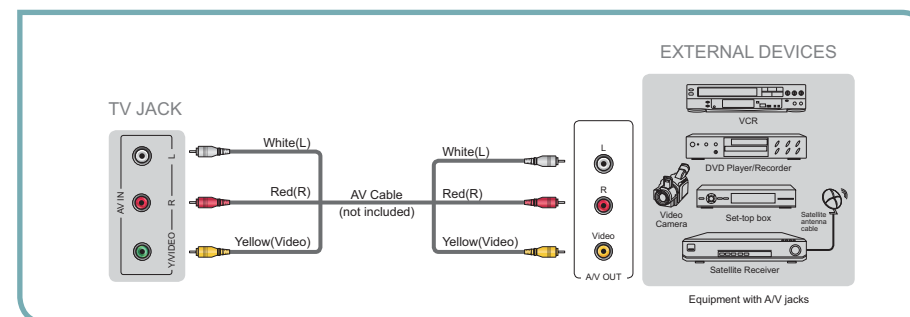

Connecting an A/V Device with Component (YPBPR) Cable

1. Use a component cable to connect the external A/V device's component output jacks to the TV's YPBPR jacks. Use an audio cable to connect the external A/V device's component audio jacks to the TV's AUDIO (L/R) jacks.
2. Plug the connected devices into the mains socket before switching on the TV.
3. Select the corresponding source from the TV.

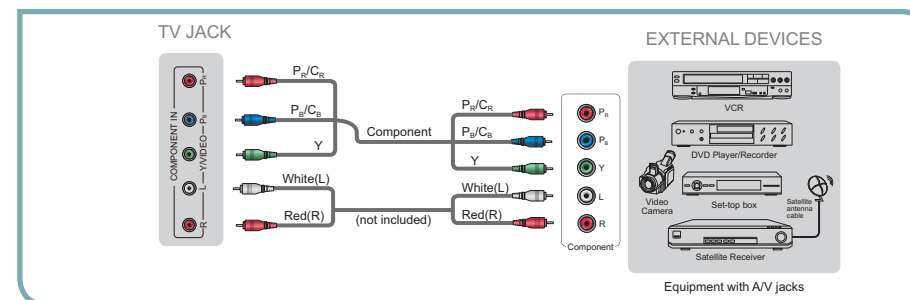

Connecting an A/V Device with HDMI Cable

- Support digital connections between HDMI - enabled AV devices such as PVR, DVD, Blu-ray, AV receiver and digital devices.
 - Some devices such as PVR or DVD player require HDMI signal to be set to output in the device's settings.
 - Please consult your device user manual for instructions.
1. Use an HDMI cable to connect the A/V device's HDMI output jack to the TV's HDMI jack.
 2. Plug the connected devices into the mains socket before switching on the TV .
 3. Select the corresponding source from the TV.

Getting Started

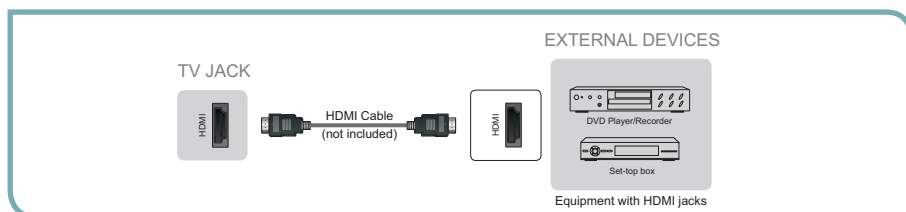

NOTE

The HDMI connector provides both video and audio signals, it's not necessary to connect the audio cable.

Connecting an MHL-enabled device

You can connect an MHL-enabled device, such as a cell phone or Roku Streaming Stick™, and view your device's screen on the TV.

1. Connect one end of an HDMI-to-MHL cable to the micro USB port on the device.
2. Connect the other end of the cable to the HDMI / MHL jack.
3. Select the corresponding source from the TV.

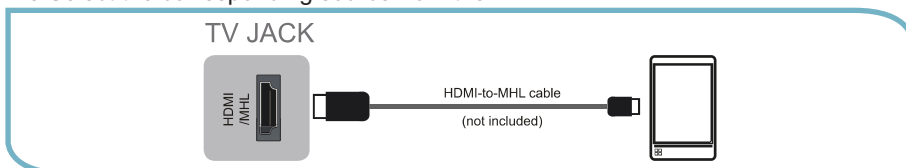

NOTE

This feature may not be available, depending on your TV series.
Not all cell phones support MHL feature as this only works with MHL-enabled phone.

Connecting a headphone

Headphones can be connected to the HEADPHONE output on your set. (While the headphone is connected, the sound from the built-in speakers will be disabled.)

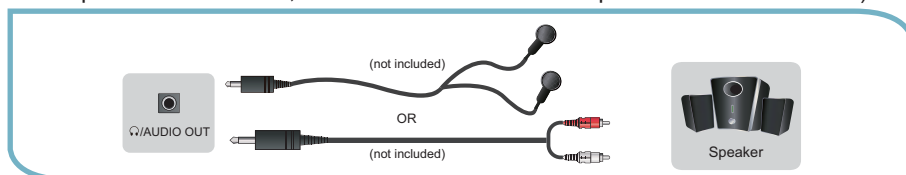

NOTE

To prevent possible hearing damage, do not listen at high volume levels for long periods.

Connecting a PC with VGA Cable

1. Use a VGA cable to connect the PC's VGA output jack to the TV's VGA jack.
Use an audio cable to connect the PC's audio output jack to TV's PC/DVI AUDIO IN jack.
2. Plug the connected devices into the mains socket before switching on the TV.
3. Select the corresponding source from the TV.

Getting Started

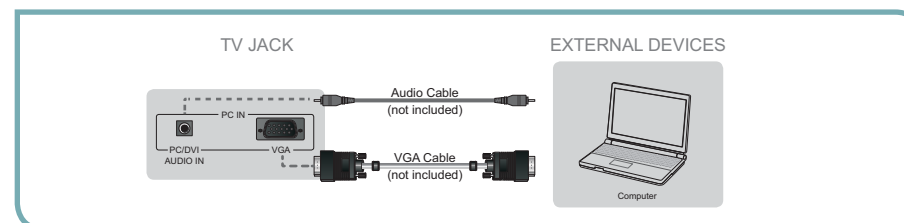

NOTES

- Primarily this unit is intended for use as an LCD TV. If you want to use it as a monitor, please contact the manufacturer of the PC Video/Graphic's card for further support. Perfect compatibility is not warranted.
- The VGA cable will not be supplied with the product.
- We strongly recommend to use VGA cable with 2 cores as shown in the figure.

Connecting an Audio Receiver with Digital Audio out cable

1. Use an Optical fiber cable to connect the A/V device's digital audio in jack to the TV's DIGITAL AUDIO OUT jack.
2. Plug the connected devices into the mains socket before switching on the TV.
3. Select the corresponding source from the TV.

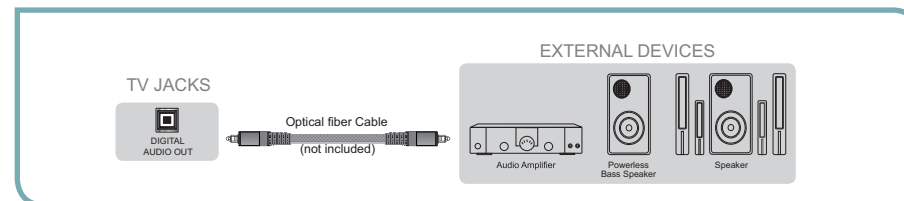

NOTES

- When a digital audio system is connected to the DIGITAL AUDIO OUT (COAXIAL) jack, decrease the volume of both the TV and the system.
- 5.1 CH (channel) audio is available when the TV is connected to an external device supporting 5.1 CH.
- When the receiver (home theater) is set to on, you can hear sound output from the TV's digital audio out jack. When the TV is receiving a DTV signal, the TV will send 5.1 CH sound to the home theater receiver. When the source is connected to the TV via HDMI, only 2 CH audio will be heard from the home theater receiver. If you want to hear 5.1 CH audio, connect the digital audio out jack from your DVD/Blu-ray player/cable box/STB satellite receiver directly to an amplifier or home theater.

Turning your TV on or off

To turn your TV on or off (standby mode):

1. Plug the power cord into an AC power outlet.
2. Press **[Power]** button. Your TV turns on.
3. Press **[Power]** button again to turn off your TV. When you turn off your TV, it goes into standby mode.

⚠ WARNING

When your TV is in standby mode, it is still receiving power. To completely disconnect power, unplug the power cord.

✓ NOTE

If your TV does not receive an input signal for several minutes, it automatically goes into standby mode.

Selecting the Input Source

The first time you turn on your TV, you must select the TV signal source. Your TV stores this information, so you do not need to change the TV signal source unless it changes. For example, you change from an outside antenna to cable TV.

To select the video input source:

1. Turn on your TV, then press **[Input]** button on the remote or on the TV. The Input Source menu opens.
2. Press **[▲/▼]** button to highlight the input source, then press **[OK]** button.

Changing Channels / Volume

1. Press the **[CH ▲/▼]** (or **[CH +/-]**) on the TV/remote control to change the channel.
2. Press the **[VOL ▲/▼]** (or **[VOL +/-]**) on the TV/remote control to adjust the volume.
3. Press the numeric buttons on the remote control to display the corresponding channels.

✓ NOTE

Changing the channels can also be achieved by directly entering the channel number using the numeric keys on the remote control. If you are entering a two or three digit channel number, the time between key presses should be less than 3 seconds.

Shortcuts Instructions

Aspect - Select the screen aspect ratio from Normal, Wide, Zoom and Cinema.

Normal: The original 4:3 aspect ratio (1.33:1 signal) is preserved, so black bars are added to the left and right of the image. Standard TV broadcasts are displayed with a 4:3 aspect ratio.

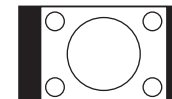

Wide: When watching a standard broadcast or full-frame movie in this mode, the display image is stretched proportionately to fill the TV screen. When watching a widescreen (1.78:1 signal) program or movie, the display image fills the TV screen.

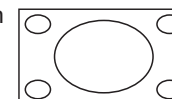

Zoom: Stretch the 4:3 aspect ratio image vertically and horizontally to fill the screen at 1:1.78 aspect ratio.



Cinema: Stretch the 4:3 aspect ratio image vertically and horizontally to fill the screen at 1:2.35 aspect ratio.

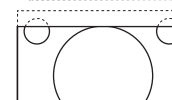

Point to Point: Use the function to see the full image without any cutoff, when VGA signal is inputted.

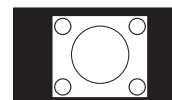

Picture - Press to set the picture mode. It can be set as Standard, Cinema, User and Vivid. This mode achieves a certain image display effect by setting the brightness, contrast and color etc.

Sound - Press to set the sound mode. It can be set as Standard, Speech, User and Music.

Mute - Press to turn the sound off, press this button again to turn the sound back on. This function is used to switch off sound temporarily.

Sleep - It can set the TV to let it enter into the Standby state automatically. Press this button repeatedly to select the proper sleeping clock mode, and the clock tells you the remaining time before the TV enters Standby state.

Display - Display the information banner. The information including channel number, channel name, current system time, tuner mode, audio stream, video format, audio language, closed caption mode, parental locks rated, program details, etc.

Basic Features

Turning your TV for the First Time

The Initial Setup menu appears the first time you turn on the TV. It will assist you to specify the Energy Saving mode.

Connect your TV's power cord to a power outlet, then press power. The Initial Setup screen opens.

Select Language

Press [◀ / ▶] button on the remote control to select the language to be used for menus and message.

Press [▼ / ▲] button on the remote control to select go to next step and press [OK / ▶] button to go.



Select Time

Press [▼ / ▲] button on the remote control to select the time zone, daylight saving time and time format you want to.

Press [◀ / ▶] button on the remote control to adjust.

Press [▼ / ▲] button on the remote control to select go to next step and press [OK / ▶] button to go.

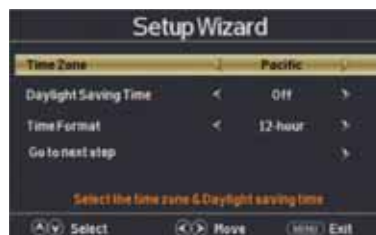

Select Picture Mode

Press [◀ / ▶] button on the remote control to select Home Mode or Retail Mode.

Press [▼ / ▲] button on the remote control to select go to next step and press [OK / ▶] button to go.



Auto Scan

Press [◀ / ▶] button on the remote control to select the antenna type, Air or Cable.

Press [▼ / ▲] button on the remote control to select go to next step and press [OK / ▶] button to start auto scan.



Basic Features



To Use the Main Menu



Press [Menu] to display the main menu or return to the previous menu or close the main menu.

Press [◀ / ▶] to highlight the desired menu icon, and press [OK] to select.

NOTE

If no buttons are pressed, the menu will close automatically after about 10 seconds.

Using the Picture Menu

You can adjust:

Picture Mode - Adjust the Picture Mode. You can select Standard, Vivid, Soft, User, Energy saving.

Brightness - Increase or decrease the brightness of the picture. Increasing the brightness can add more light to dark areas of the picture, while decreasing the brightness can add more darkness to light areas of the picture.

Contrast - Increase or decrease the contrast of the picture. Increase the contrast to adjust the white areas of the picture or decrease the contrast to adjust the black areas of the picture.

Color - Adjust the intensity of the colors.

Tint - Adjust the hue (Red, Green, Blue) of the picture.

Sharpness - You can increase the sharpness level for clearer images or decrease the sharpness level for smoother images.

Color Temperature - Adjust the overall color of the picture.

Advanced Settings - Access advanced video settings such as Aspect Ratio, Noise Reduction, and Dynamic Contrast.



Basic Features

Aspect Ratio: Adjust how the picture fills the screen.

Noise Reduction: Select to reduce the noise level of connected equipment: Off, Low, Medium or High.

Dynamic Contrast: Automatically adjust picture detail and brightness.

HDMI Mode: Adjust the HDMI output mode. You can select Graphic or Video.



NOTES

1. The option of "Aspect Ratio" is different in different input source. (For more information, see "Shortcuts Instructions")
2. Only select the "Graphic" in "HDMI Mode",you can just adjust Aspect Ratio is the Point to Point mode.

Using the Sound Menu

You can adjust:

Sound Mode - Adjust the Sound Mode. You can select Stan-dard,Music,Movie,Sports,User.

Bass - Adjust the low frequency sounds.

Treble - Adjust the high frequency sounds.

Balance - Adjust the balance between the left and right speakers.

MTS - Configures the multi-track sound.

Mono: Sets the sound to mono.

Stereo: Sets the sound to stereo when stereo is not available, the sound is automatically switched to mono.

SAP: Sets the sound to the second audio program.

Audio Language - Select the language supported by the chosen digital channel.

Digital audio output - Adjust the form of the digital audio output.You can select "Raw", "PCM" or close it by select "Off".

Raw:Source code,the digital audio code is directly outputted,unprocessed.

PCM: A form of code, pulse code modulation.

Surround Sound - Simulates surround sound and enhances bass response.

AVL - Automatically adjusts volume to a consistent level;attenuates loud passages.



Basic Features

NOTES

1,The option of "MTS" is only available in ATV.

2,The option of "Audio Language" is only available in DTV.

3,When "AVL" is "On", that means audio out control is activated.

Using the Time Menu

You can adjust:

Sleep Timer - Set a timer for the TV to turn off automatically.

Time Zone - Select your time zone.

Daylight Saving Time - Set the daylight saving time for your area.

Time Format - Select your time format.

Auto Clock - Select "On" for automatic date

and time setting using information from broadcast stations in your area.

Clock - Set the time manually when "Auto Clock" is "Off".



Using the Setup Menu

You can adjust:

Menu language - Select TV Menu language .

Transparent - Adjust the transparency of the OSD (on screen display) menu.

OSD Time Out - Adjust the duration of the OSD (on screen display) menu.

Closed Caption - Adjust Closed Captioning settings.



NOTES

1. The option of "Closed Caption" is Only available under TV and AV source.

2. The option of "Over Scan" is Only available under DTV and Component Source.

CC Mode - Turn Closed Captioning on/off.

Analog CC - Set Closed Captioning for standard (analog) program.

Digital CC - Set Closed Captioning for digital program.

Option - Adjust the digital Closed Captioning setting.

Basic Features

Mode - Set the look of digital Closed Captioning. Automatic uses broadcaster's style.

Font Style - Select from 8 font styles(Default / Font 0 / Font 1 / Font 2 /Font 3 / Font 4 / Font 5 / Font 6 / Font 7).

Font Size - Adjust the size of the digital Closed Captioning font.

Font Edge Style - Adjust the edge of the digital Closed Captioning box.

Font Edge Color - Adjust the color of the digital Closed Captioning box.

FG Color - Adjust the color of the digital Closed Captioning font.

BG Color - Adjust the digital Closed Captioning background color.

FG Opacity - Adjust the transparency of the digital Closed Captioning font.

BG Opacity - Adjust the digital Closed Captioning background transparency.

NOTE

All the options can not be adjust while the mode is Default.

Input Labels - Create labels for the devices connected to your TV.

Other Settings - Set the parameter of blue screen and audio only.

Blue screen - Set the background when there is no signal. The background will show blue screen when it's on and show noise when off.

Audio Only - Play the audio with the picture turned off. When you turn the Audio Only on and exit the OSD menu, the panel will be dark; and then press any key to exit the Audio Only status.

Software Update(USB) - Update the TV software.Select the software in the root of your USB memory.

System Info - You can find the system information in this menu.

NOTE

The item is available only When current stream has downloadable rating data.

Restore Default - Change power on options or reset TV to factory default.

Setup Wizard - Set the first time installation.

CEC Function- CEC Function lets you control HDMI CEC- compatible devices connected to the HDMI jacks on your TV using the remote control that came with your TV. To use CEC Function, you must set the CEC Control setting to On.

NOTES

- HDMI cables must be used to connect HDMI CEC-compatible devices to your TV.
- The connected device's HDMI CEC feature must be turned on.
- If you connect an HDMI device that is not HDMI CEC-compatible, all the CEC Control features do not work.
- Depending on the connected HDMI device, the CEC Control feature may not work.

CEC Control: Turning CEC Function on or off.

Device Auto Power Off: When HDMI-CEC is turned on, Device Auto Power Off turns off HDMI CEC devices when you turn off your TV.



Basic Features

TV Auto Power On: When CEC is turned on and you turn on an HDMI CEC device, TV Auto Power On turns on your TV automatically.

Audio Receiver: When CEC is turned on and you have connected an audio receiver to your TV, turning on Audio Receiver lets you use your TV's remote control to control the volume on the audio receiver.

CEC Device Lists: You can display a list of HDMI CEC devices that are connected to your TV and select the source you want.

Connect: Connect to the current CEC devices .

Root Menu: You can open an CEC-compatible device's root menu, then use your TV's remote control to control the device.

Using the Lock Menu

Enter your 4-digit password. Default password is 0000,and if forget what you set, please call the service center.



You can adjust:

Change Password - Enter a new 4-digit password then reenter it to confirm.

System Lock - Lock or unlock the buttons on the TV.

Input Block - Block or unblock the input sources.

US Rating - Restrict movie and TV programs by US Ratings

Canada Rating - Restrict movie and TV programs by Canadian Ratings.



NOTE

"US Rating" and "Canada Rating" is available only when "System Lock" is "On".

RRT Setting - Display an advance V-Chip rating table for digital channels.

Reset RRT - Reset the RRT to default.

NOTE

If you choose the "Reset RRT" function, all the programs you preset in "RRT Setting" will be lost.

For the United States, the rating setting basically include the following options: TV, MPAA.

TV - The TV rating compose of two aspects: age-based and content-based.



Basic Features

U.S. TV Ratings

Age	Defined as
TV-Y	All children
TV-Y7	Directed to older children
TV-G	General audience
TV-PG	Parental Guidance suggested
TV-14	Parents Strongly cautioned
TV-MA	Mature Audience only

Contents	Defined as
A	All of the ratings below that rating set blocked automatically
D	Suggestive dialogue
L	Strong language
S	Sexual situations
V	Violence
FV	Fantasy Violence

MPAA - This system defines the rating control which come from MPAA rules

U.S. Movie Ratings

Rating	Defined as
G	General audience
PG	Parental Guidance suggested
PG-13	Parents strongly cautioned
R	Restricted
NC-17	No one 17 and under admitted
X	Adult audience only

NOTE

The content ratings will increase depending on the level of the age-based rating. For example, a program with a TV-PG V rating may contain moderate violence, while a TV-14 V rating may contain intense violence. So locking a higher level option will automatically cause locking the options that has more sensitive level.

Using the Channel Menu

You can adjust:

Air/Cable - Select signal type.

Auto Scan - Automatically search for channels.

Favorites - Add channels to create a favorite list.

Show/Hide - Show or hide the channels in your program list.

Channel No. - Show the channel number.

Channel Label - Create label for channel, up to 7 characters.

NOTE

When the input source is AV / COMPONENT / HDMI / VGA/ MEDIA, the CHANNEL MENU is unavailable.



Basic Features

PC Setting

Press [**Input**] to select VGA source.

Press [**Menu**] to enter the main menu,

Press [**◀ / ▶**] button to select Setup menu.

Press [**▼**] to select PC Settings.

NOTE

The item is available only When a PC signal is inputted to your TV.



You can adjust:

H-Pos - Adjust the horizontal position of the picture.

V-Pos - Adjust the vertical position of the picture.

Clock - Minimize vertical stripes in the screen image.

Phase - Minimize horizontal distortion.

Auto - Adjust to the PC signal timing automatically.



Advanced Features

Digital Media Player

Please note that Hisense will not assume any responsibility for any lost data and cannot guarantee perfect compatibility with all mass storage devices. Be sure to insert the USB disk with standard USB 2.0 port. Data Input from USB Memory Stick only. Do not connect any device to this terminal such as digital camera, keyboard, mouse, etc.

NOTES

- Never remove the USB flash drive or turn off your TV while viewing video/music/photo.
- Before operating Media menu, Plug in USB device, then press [Input] button to set the Input Source to Media .

Media content control function buttons

When viewing video/music/photo, you can press these buttons on the remote control to control video/music/photo.

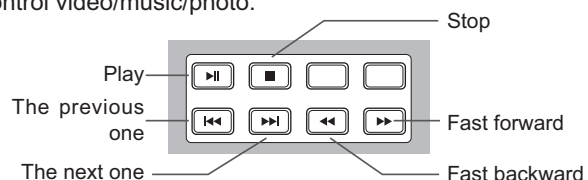

When browsing the photos, only the and buttons are available.

Press [▲ / ▼] button to select MEDIA in the Source menu, then press [OK] button to enter.



Press [◀ / ▶] button to select the option you want to adjust in the main Media menu, then press [OK] button to enter.



Advanced Features

Browse the Photos

Press [◀ / ▶] button to select drive disk you want to watch, then press [OK] button to enter. Press [◀ / ▶] button to select return option to back .



Press [◀ / ▶] button to select the file you want to watch in the file selecting menu, then press [OK or ▶] button to display picture.



Press [◀ / ▶] button to select the file folder you want to search in the file selecting menu, then press [OK] button on your remote control to enter sub-menu.

Press [◀ / ▶] button to select "Return" option and press [OK] to back to the previous menu.

Enjoy Music Files

Press [◀ / ▶] button to select drive disk, then press [OK] button to enter. Press [◀ / ▶] button to select return option to back.



Press [◀ / ▶] button to select the file you want to watch in the file selecting menu, then press [OK or ▶] button to display and operate file details.



Advanced Features

Press [◀ / ▶] button to select the file folder and press [OK] button to enter sub-menu.
Press [◀ / ▶] button to select menu in the bottom you want to run, then press [OK] button to operate.

Press [Exit] button to back to the previous menu.
Press [▼] button to hide the menu in the bottom.

Enjoy Video Files

Press [◀ / ▶] button to select drive disk, then press [OK] button to enter.

Press [◀ / ▶] button to select return option to back.

Press [▼] button to hide the menu in the bottom. When you press [DISPLAY], the menu in the bottom will appear again.



Press [◀ / ▶] button to select the file you want to watch in the file selecting menu.
Press [OK or ▶|▶] button to display and operate file details.



Press [◀ / ▶] button to select menu in the bottom you want to run, then press [OK] button to operate.

Press [Exit] button to back to the previous menu.
Press [▼] button to hide the menu in the bottom.

NOTE

When highlighting the option you select, the file information will appear on the right and the picture of photo and movie will be previewed in the center.

Advanced Features

NOTES

- The unit recognizes only a USB Memory Stick.
- Do not use a USB hub or an extension cable to connect an external hard disk drive to the unit. (Not supported)
- A USB Memory Stick is always inserted to this unit directly.
- A USB Memory Stick is not supplied with this unit.
- We do not guarantee that all USB Memory Sticks can be supported by this unit.
- Be sure to keep a backup copy of the original files on your device before you play them back on this unit. We have no responsibilities for damage or loss of your stored data.
- To protect your USB Memory Stick files from being erased place the write protect sliding tab in the protect position.
- When you are ready to remove a USB Memory Stick, set the unit to go into Standby mode to avoid any damage to your data and the unit.
- A USB Memory Stick that requires its own driver or the device with a special system such as fingerprint recognition are not supported.
- This unit is not allowed to use the USB Memory Stick which requires an external power supply (500mA or more).

Playable format list

<i>Files Format</i>	<i>Playable format</i>
Photo	JPG
Music	MP3
Video	MPEG1(.dat/.mkv),MPEG2(.mpg/.ts/.vob),MPEG4(.mp4/.mov/.mkv),XviD(.avi),H.264(.avi/.mp4/.mov/.mkv/.ts/.FLV), Motion JPEG(.avi/.mov)

Trouble Shooting

When there is something wrong with your TV, you can try turning off the TV and then restart it. You can also Operate according to the following chart. If the problem still cannot be solved, please contact the professional technicians.

<i>SYMPTOMS</i>	<i>POSSIBLE SOLUTIONS</i>
No sound or picture.	<ul style="list-style-type: none"> ● Check if the power cord is in the AC outlet and if it has electricity. ● Check if you have pressed [POWER] button on the TV or [POWER] button on the remote control. ● Check to see if LED light is either red or blue. If illuminated, power to TV is OK.
I have connected an external source to my TV and I get no picture and/or sound.	<ul style="list-style-type: none"> ● Check for the correct output connection on the external source and for the correct input connection on the TV. ● Make sure you have made the correct selection for the input mode for the incoming signal.
When I turn on my television, there is a few second delay before the picture appears. Is this normal?	Yes, this is normal. That is the TV searching for previous setting information and initializing the TV.
Picture is normal, but no sound.	<ul style="list-style-type: none"> ● Check the volume settings. ● Check if Mute mode is set "on".
Sound but no picture or black and white picture.	<ul style="list-style-type: none"> ● If black and white picture first unplug TV from AC outlet and replug after 60 seconds. ● Check Color Setting if picture is black and white.
Sound and picture distorted or appear wavy.	<ul style="list-style-type: none"> ● An electrical appliance may be affecting TV set. Turn off any appliances, if interference goes away, move appliance farther away from TV. ● Insert the power plug of the TV set into another power outlet.
Sound and picture is blurry or cuts out momentarily.	<ul style="list-style-type: none"> ● If using an external antenna, check the direction, position and connection of the antenna. ● Adjust the direction of your antenna or reset or fine tune the channel.
Horizontal/vertical stripe on picture or picture is shaking.	Check if there is interfering source nearby, such as appliance or electric tool.
The plastic cabinet makes a "clicking" type of sound.	"Click" sound can be caused when the room temperature changes. This change causes the television cabinet to inflate or contract, which makes the sound. This is normal and TV is OK.
Black square appears in the center of my television screen?	The Closed Caption function is set in the text mode. To remove it, access Closed Caption from the menu screen and change the Mode setting from text to either CC1 or off.

Trouble Shooting

<i>SYMPTOMS</i>	<i>POSSIBLE SOLUTIONS</i>
On some channels getting another language or sometimes no sound at all.	<p>That would indicate that the MTS mode on your unit is set to SAP mode. We suggest setting the MTS mode to either Stereo or Mono . For further instruction, please see Audio Adjust or MTS/SAP in your user manual.</p> <ul style="list-style-type: none"> ● SAP is Second Audio Program. It's a second audio channel that is usually used for a second language or descriptive audio for the visually impaired. ● MTS stands for Multichannel Television Sound, a standard that allows the encoding of 3 channels of audio within a standard NTSC (analog) video signal to a television. A television that is able to receive MTS Stereo allows you to watch television with stereo sound.
Not getting all of my cable channels on the television or I'm only getting 13 channels.	<ul style="list-style-type: none"> ● Check the cable connection for an incoming signal. Make sure the signal is coming OK. Best way to confirm signal is to use another TV and/or contact your cable company. ● Reprogram your channels. Press [MENU] button on your TV remote control, change Input Source setting to "Cable", then use "Auto Channels Search" to reprogram your channels.
[CH \wedge / V] don't work when I set the Channel to Cable? They work with the Air setting?	After switching to Cable, please auto program the channels. The TV will "remember" all the channels then the TV will allow you to surf the channels with [CH \wedge /V] buttons.
Remote control does not work.	<ul style="list-style-type: none"> ● Confirm that TV still has power and is operational. ● Change the batteries in the remote control. ● Check if the batteries are correctly installed. ● Clean the front of the remote control (LED window). ● If using a universal remote, be sure to select the TV mode on the remote. ● If the remote still does not work: <ul style="list-style-type: none"> • Remove and reinstall the batteries correctly to reset the remote or install new batteries. • Press the Power button to turn on the TV. With a universal remote if you have reset or changed the batteries you will need to reprogram the remote for the other units. ● Check if there is obstruction between the remote control and the TV. <p>TIP: If you have a digital camera / camera phone, you can aim the front of the remote at camera lenses (at this time, the camera should set on camera mode, not play mode). Observe the camera screen while pressing a button on the remote control; you should see flashing light on the screen. If there is no light observed, the remote control is not working. You need to repair or replace the remote control.</p>

Specifications

NOTE

Features, appearance and specifications are subject to change without notice.

Dimension	With Base	Width: 36.7 inches(931.3 mm) Height: 23.4 inches(595.2 mm) Depth: 9.4 inches(240 mm)	
	Without Base	Width: 36.7 inches(931.3 mm) Height: 21.7 inches(551.9 mm) Depth: 2.8 inches(72 mm)	
Weight	NET	17 lbs(7.7 kg)	
	GROSS	24.3 lbs(11 kg)	
LCD Panel Minimum size (diagonal)		40 inches	
Screen resolution		1920 × 1080	
Audio power		8 W + 8 W	
Power consumption		Please refer to the rating label	
Power supply		120 V ~ 60 Hz	
Receiving systems	Analog	NTSC	
	Digital	ATSC	
Environmental conditions		Temperature: 5°C-45°C Humidity: 20%-80% RH Atmospheric pressure: 86 kPa -106 kPa	
VIDEO INPUT	VGA	Format	Up to 1920x1080@60Hz
	VIDEO	Video System	PAL/NTSC
		Video level	1.0 Vp-p +/-5%
	COMPONENT	480i, 480p, 720p, 1080i, 1080p	
HDMI	480i, 480p, 720p, 1080i, 1080p		

The remote control requires:

- Number of Batteries: 2
- Type : AAA
- Voltage: 1.5Vcc