

# MANUAL DEL USUARIO

Antes de utilizar el televisor, por favor lea este manual detenidamente y consérvelo para futuras referencias.

***Español***

*English*

Before using the TV, please read this manual  
thoroughly and retain it for future reference.

# USER MANUAL

50K610GW  
55K610GW

**Hisense**  
INNOVATION IS LIFE

\* Specifications subject to change without notice.

Hisense and associated logos where applicable are registered trademarks of Hisense Group in the United States and/or other countries. All other trademarks are property of their respective owners. 2011 Hisense USA, Corporation. All Rights Reserved. Manufactured under license from Dolby Laboratories. Dolby and the double-D symbol are trademarks of Dolby Laboratories.



This TV incorporates High-Definition Multimedia Interface (HDMI™) technology. HDMI, the HDMI logo and High-Definition Multimedia Interface are trademarks or registered trademarks of HDMI Licensing LLC.

FCC ID Number WiFi Module: WMMN421V1  
The WiFi Module complies with FCC radiation exposure limits set forth for an uncontrolled environment. This device should be installed and operated with a minimum distance of 20 centimeters between the radiator and your body.

The manufacturer is not responsible for any radio or TV interference caused by unauthorized modifications to this equipment. Such modifications could void the user's authority.

**WARNING**

Where the MAINS plug or an appliance coupler is used as the disconnect device, the disconnect device shall remain readily operable.

**NOTE**

Your Hisense TV is ENERGY STAR® qualified in the "Energy Saving" mode. It meets strict energy efficiency guidelines set by the U.S. Environmental Protection Agency and Department of Energy. ENERGY STAR is a joint program of these government agencies, designed to promote energy efficient products and practices. Changes to certain features, settings, and functionalities of this TV (i.e. TV Guide, Picture, Sound) can increase or change the power consumption. Depending upon such changed settings, the power consumption may exceed the limits required for the ENERGY STAR qualification in the "Energy Saving" mode.



**Energy Star**

The lightning flash with arrowhead symbol, within an equilateral triangle is intended to alert the user to the presence of uninsulated dangerous voltage within the product's enclosure that may be of sufficient magnitude to constitute a risk of electric shock.

The exclamation point within an equilateral triangle is intended to alert the user to the presence of important operating and maintenance (servicing) instructions in the literature accompanying the appliance.



**FCC Statement**

	<b>CAUTION</b> RISK OF ELECTRIC SHOCK DO NOT OPEN	
	<b>CAUTION: TO REDUCE THE RISK OF ELECTRIC SHOCK, DO NOT REMOVE COVER (OR BACK). NO USER-SERVICEABLE PARTS INSIDE. REFER SERVICING TO QUALIFIED SERVICE PERSONNEL.</b>	

**NOTE:** This equipment has been tested and found to comply with the limits for a class B digital Device, pursuant to part 15 of the FCC Rules. These limits are designed to provide reasonable protection against harmful interference in a residential installation. This equipment generates, uses and can radiate radio frequency energy and, if not installed and used in accordance with the instructions, may cause harmful interference to radio communications. However, there is no guarantee that interference will not occur in a particular installation. If this equipment does cause harmful interference to radio or television reception, which can be determined by turning the equipment off and on, the user is encouraged to try to correct the interference by one or more of the following measures:

- Reorient or relocate the receiving antenna.
- Increase the separation between the equipment and the receiver.
- Connect the equipment into an outlet on a circuit different from that to which the receiver is connected.
- Consult the dealer or an experienced radio/TV technician for help.

# CHILD SAFETY:

It Makes A Difference How and Where  
You Use Your Flat Panel Display

Congratulations on your purchase! As you enjoy your new product, please keep these safety tips in mind:

## THE ISSUE

- The home theater entertainment experience is a growing trend and larger flat panel displays are popular purchases. However, flat panel displays are not always supported on the proper stands or installed according to the manufacturer's recommendations.
- Flat panel displays that are inappropriately situated on dressers, bookcases, shelves, desks, speakers, chests or carts may fall over and cause injury.

## THIS MANUFACTURER CARES!

- The consumer electronics industry is committed to making home entertainment enjoyable and safe.

## TUNE INTO SAFETY

- One size does NOT fit all. Follow the manufacturer's recommendations for the safe installation and use of your flat panel display.
- Carefully read and understand all enclosed instructions for proper use of this product.
- Don't allow children to climb on or play with furniture and television sets.
- Don't place flat panel displays on furniture that can easily be used as steps, such as a chest of drawers.
- Remember that children can become excited while watching a program, especially on a "larger than life" flat panel display. Care should be taken to place or install the display where it cannot be pushed, pulled over, or knocked down.
- Care should be taken to route all cords and cables connected to the flat panel display so that they cannot be pulled or grabbed by curious children.

## WALL MOUNTING: IF YOU DECIDE TO WALL MOUNT YOUR FLAT PANEL DISPLAY, ALWAYS:

- Use a mount that has been recommended by the display manufacturer and/or listed by an independent laboratory (such as UL, CSA, ETL).
- Follow all instructions supplied by the display and wall mount manufacturers.
- If you have any doubts about your ability to safely install your flat panel display, contact your retailer about professional installation.
- Make sure that the wall where you are mounting the display is appropriate. Some wall mounts are not designed to be mounted to walls with steel studs or old cinder block construction. If you are unsure, contact a professional installer.
- A minimum of two people are required for installation. Flat panel displays can be heavy.



# Important Safety Instructions

1. Read these instructions.

2. Keep these instructions.

3. Heed all warnings.

4. Follow all instructions.

5. Do not use this apparatus near water.

6. Clean only with dry cloth.

7. Do not block any ventilation openings. Install in accordance

with the manufacturer's instructions.

8. Do not install near any heat sources such as radiators,

heat registers, stoves, or other apparatus (including

amplifiers) that produce heat.

9. Do not defeat the safety purpose of the polarized or

grounding-type plug. A polarized plug has two blades with

one wider than the other. A grounding type plug has two

blades and a third grounding prong. The wide blade or the

third prong are provided for your safety. If the provided

plug does not fit into your outlet, consult an electrician for

replacement of the obsolete outlet.

10. Protect the power cord from being walked on or pinched

particularly at plugs, convenience receptacles, and the

point where they exit from the apparatus.

11. Only use attachments/accessories

specified by the manufacturer.

12. Use only with cart, stand, tripod,

bracket, or table specified by the

manufacturer, or sold with the

apparatus. When a cart is used,

use caution when moving the cart/

apparatus combination to avoid injury from tip-over.

13. Unplug this apparatus during lightning storms or when

unused for long periods of time.

14. Refer all servicing to qualified service personnel.

15. Servicing is required when the apparatus has been

damaged in any way, such as power-supply cord or plug

is damaged, liquid has been spilled or objects have fallen

into the apparatus, the apparatus has been exposed to

rain or moisture, does not operate normally, or has been

dropped.

15. Apparatus should not be exposed to dripping or

splashing, and objects filled with liquids, such as vases,

should not be placed on the apparatus.

16. An outside antenna system should not be located in the

vicinity of overhead power lines or other electric light or

power circuits, or where it can fall into such power lines

or circuits. When installing an outside antenna system,

extreme care should be taken to keep from touching

such power lines or circuits, as contact with them might

be fatal.

17. Do not overload wall outlets and extension cords, as this

can result in a risk of fire or electric shock.

18. Do not push objects through any openings in this unit,

as they may touch dangerous voltage points or short out

parts that could result in fire or electric shock. Never spill

or spray any type of liquid into the unit.

19. If an outside antenna or cable system is connected to the

unit, be sure the antenna or cable system is grounded to

provide some protection against voltage surges and built-

up static charges, Section 810 of the National Electrical

Code, ANSI/NFPA 70, provides information with respect

to proper grounding of the mast and supporting structure,

grounding of the lead-in wire to an antenna discharge

unit, size of grounding conductors, location of antenna

discharge unit, connection to grounding electrodes, and

requirements for the grounding electrode.

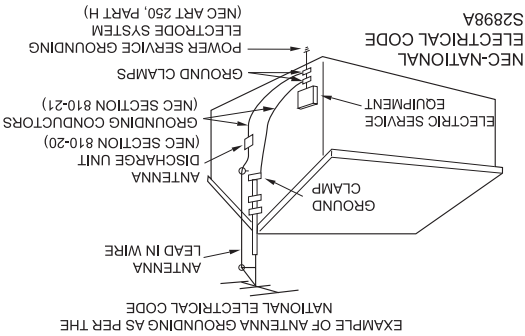

EXAMPLE OF ANTENNA GROUNDING AS PER THE NATIONAL ELECTRICAL CODE

20. When replacement parts are required, be sure the service

technician uses replacement parts specified by the

manufacturer or those that have the same characteristics

as the original part. Unauthorized substitutions may result

in fire, electric shock or other hazards.

21. Upon completion of any service or repairs to this unit,

ask the service technician to perform safety checks to

determine that the unit is in proper operating condition.

22. When you connect the product to other equipment, turn

off the power and unplug all of the equipment from the

wall outlet. Failure to do so may cause an electric shock

and serious personal injury. Read the owner's manual of

the other equipment carefully and follow the instructions

when making any connections.

23. Sudden high volume sound may cause hearing or

speaker damage. When you use headphones, (if the unit

is equipped with a headphone jack) keep the volume at a

moderate level. If you use headphones continuously with

high volume sound, it may cause hearing damage.

## CONDENSATION:

Moisture will form in the operating section of the unit if the

unit is brought from cool surroundings into a warm room or

if the temperature of the room rises suddenly. When this

happens, unit's performance will be impaired. To prevent

this, let the unit stand in its new surroundings for about an

hour before switching it on, or make sure that the room

temperature rises gradually.

Condensation may also form during the summer if the unit is

exposed to the breeze from an air conditioner. In such cases,

change the location of the unit.

## HOW TO HANDLE THE LCD PANEL:

- Do not press hard or jolt the LCD panel. It may cause the LCD panel glass to break and injury may occur.
- If the LCD panel is broken, make absolutely sure that you do not touch the liquid in the panel. This may cause skin inflammation.
- If the liquid gets in your mouth, immediately gargle and consult with your doctor. Also, if the liquid gets in your eyes or touches your skin, consult with your doctor after rinsing for at least 15 minutes or longer in clean water.

## Possible Adverse Effects on LCD Panel:

If a fixed (non-moving) pattern remains on the LCD Panel for long periods of time, the image can become permanently engrained in the LCD Panel and cause subtle but permanent ghost images. This type of damage is NOT COVERED BY YOUR WARRANTY. Never leave your LCD Panel on for long periods of time while it is displaying the following formats or images:

- Fixed images, such as stock tickers, video game patterns, TV station logos, and websites.
- Special Formats that do not use the entire screen. For example, viewing letterbox style (16:9) media on a normal (4:3) display (black bars at top and bottom of screen); or viewing normal style (4:3) media on a widescreen (16:9) display (black bars on left and right sides of screen).

## The following symptoms are not signs of malfunction but technical limitation. Therefore we disclaim any responsibility for these symptoms.

- LCD Panels are manufactured using an extremely high level of precision technology, however sometimes parts of the screen may be missing picture elements or have luminous spots.
- This is not a sign of a malfunction.
- Do not install the LCD Panel near electronic equipment that produces electromagnetic waves. Some equipment placed too near this unit may cause interference.
- Effect on infrared devices - There may be interference while using infrared devices such as infrared cordless headphones.

## Declaration of Conformity

This device complies with part 15 of the FCC Rules. Operation is subject to the following two conditions: (1) This device may not cause harmful interference and (2) This device must accept any interference received, including interference that may cause undesired operation.

## End of life directives

Your TV also contains material that can be recycled and reused. For disposal or recycling information, contact your local authorities or the Electronic Industries Alliance at [www.eia.org](http://www.eia.org) to find a recycler in your area.

## Non-active pixels

The LCD panel contains almost 3 million thin film transistors, which provide exceptionally sharp video quality. Occasionally, a few non-active pixels may appear on the screen as a fixed black (in the case of a dead pixel), blue, green, or red point. These non-active pixels do not adversely affect the performance of your TV, and are not considered defects.

## Power source

### TO USE AC POWER

1. The power cord is attached to the TV at the factory.
2. Connect the AC cord into an AC outlet.

### WARNING

Do not connect this unit to the power using any device other than the supplied AC cord. This could cause fire, electrical shock, or damage.

Do not use with a voltage other than the power voltage specified. This could cause fire, electrical shock, or damage.

### CAUTION

When this unit is not used for a long time, (e.g., away on a trip) in the interest of safety, be sure to unplug it from the AC outlet.

Do not plug/unplug the AC cord when your hands are wet. This may cause electrical shock.

# Contents

## Getting Started

Accessories List.....	3
Installing the Stand.....	3
Installing a Wall-Mount Bracket.....	4
When Installing the TV Against a Wall or Enclosed Area.....	5
Viewing the Control Panel.....	6
Viewing the Remote Control.....	7
Installing Batteries in the Remote Control.....	8
Making Connections.....	9

## Basic Features

Turning the TV on or off.....	13
Turning the TV On for the First Time.....	13
Selecting the Input Source.....	13
Changing Channels / Volume.....	14
Shortcuts Instructions.....	14
To Use the Menu.....	15
Using the Picture Menu.....	15
Using the Audio Menu.....	15
Using the Screen Menu.....	16
Using the Channels Menu.....	16
Using the Settings Menu.....	17
Using the Lock Menu.....	18

**Advanced Features**

Network Connection .....	20
DLNA Settings .....	23
Media Share Settings in Computer .....	24
Network Function .....	25
Enter the Network Applications .....	26
VUDU HD Movies .....	26
VUDU Apps .....	28
Netflix .....	28
YouTube .....	29
Pandora .....	29
Picasa .....	29
Viewster .....	30
AccuWeather .....	30
Vimeo .....	31
Network Apps Service Information .....	31
Digital Media Player .....	32
Enjoy Video Files .....	32
Enjoy Music Files .....	33
Browse the Picture .....	33
Browse the Text Files .....	34
Digital Media Receiver .....	34
<b>Other Information</b>	
Trouble Shooting .....	35
General .....	37





*Illustrations are for your reference only!*



# Getting Started

## Accessories List

	User Manual
	Quick Setup Guide
	Warranty Card
	Remote Control
	Battery x 2

	Spacer x4
	Screws: Screw A (M5xL12) x6
	Screw B (ST4xL14) x2
	Screw C (M5xL12) x4
	Screw D (M6xL45) x4

## Installing the Stand

### NOTES

1. The LCD display is very fragile, and must be protected at all times when removing the base stand. Be sure that no hard or sharp object, or anything that could scratch or damage the LCD display, comes into contact with it. DO NOT exert pressure on the front of the TV at any time because the screen could crack.
2. For tabletop use, the TV must be attached to the provided stand as shown on this page.
3. To Wall-Mount, brackets (not provided) must be attached to the TV as shown on next page.

### WARNING

Be sure to disconnect the AC power cord before installing a stand or Wall-Mount brackets.

### CAUTION

Use a covered table or bench to lay the TV on and handle the TV carefully to prevent damage to the TV screen or cabinet during assembly.

### Follow the illustrations below to complete the installation steps:

1. Secure the stand column to the base plate with the 4 screws A (M4 x L12 for 50" and M5X12 for 55") provided. See Figure 1.
2. Secure the stand cover to the stand column vertically with the 2 screws A (M4 x L12 for 50" and M5X12 for 55") provided. See Figure 2.
3. Secure the stand cover to the stand column horizontally with the 2 screws B (ST4 x L14) provided. See Figure 3.

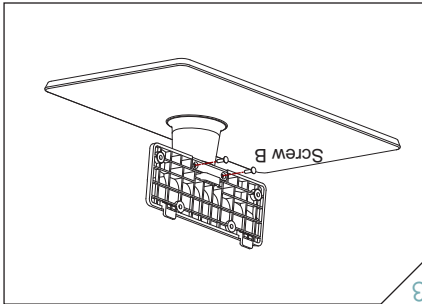
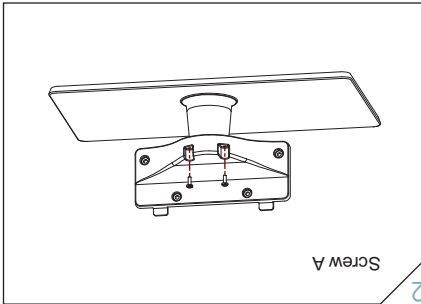
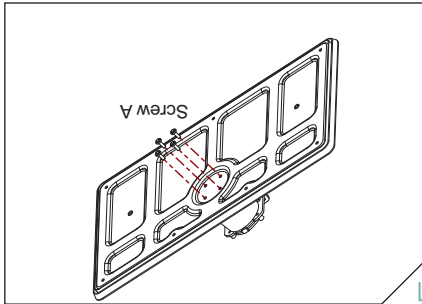

## Getting Started

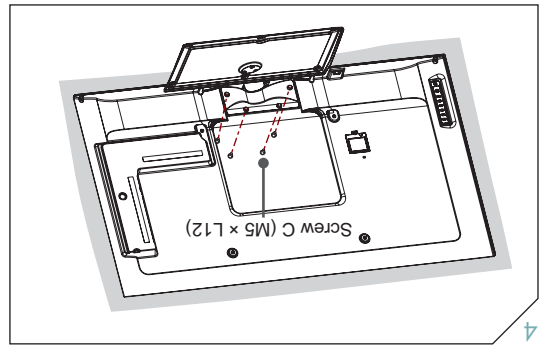

4. Carefully place your TV on a soft, cushioned, surface to prevent damage to the screen.  
Secure the stand to the TV with the 4 screws C (M5 x L12) provided. See Figure 4.

## Installing a Wall-Mount Bracket

If you want to attach the TV to a Wall-Mount bracket (not provided), you should first remove the stand if it is pre-attached (see Step 1).

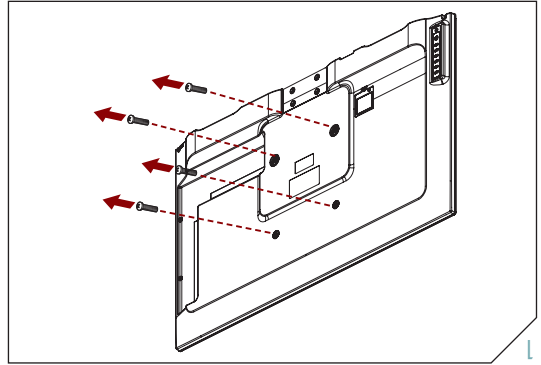

1. Make sure the TV is laid face-down on a clean, safe, and cushioned space, remove the original screws in the bracket holes on the TV back cover.

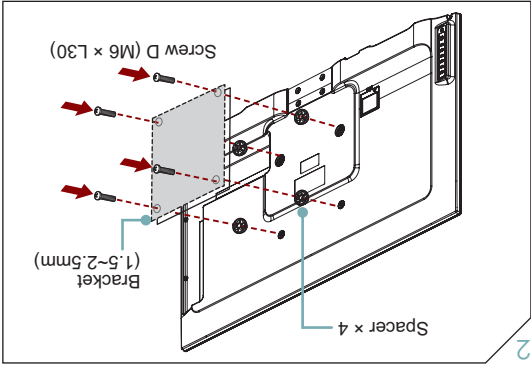

2. Place the provided spacers in the corresponding bracket holes. Attach purchased bracket (1.5~2.5 mm thickness) on the TV with 4 screws D (M6 x L30) provided. Follow instructions provided with the wall bracket.

### WARNING

Use only the 4 screws D (M6 x L30) provided with the TV to prevent internal damage to the TV set or cause it to fall.

3. Follow instructions provided with the Wall-Mount bracket.
- If you are not sure of your ability to do complete the installation, contact a professional installer or service technician for assistance. The manufacturer is not responsible for any damages or injuries that occur due to mishandling or incorrect assembly.
  - The selected screws are 9.5 ~ 12.5 mm in length when measured from the attaching surface of the TV's rear cover. The diameter and length of the screws differ depending on the Wall-Mount Bracket model.

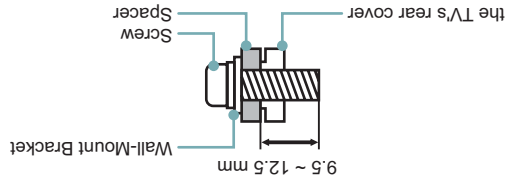

Wall-Mount hole pattern VESA (mm)	400 × 400
Wall-Mount screw size (mm)	M6

## When Installing the TV Against a Wall or Enclosed Area

Make sure that your TV has adequate air circulation. Allow enough space around the TV as shown below. Avoid operating the TV at temperatures below inadequate air 41°F (5°C).

Install with stand

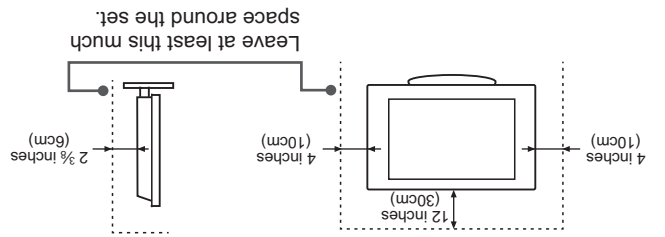

Install on the wall

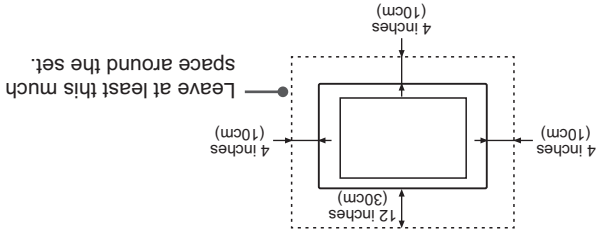

Never install the TV set as follows:

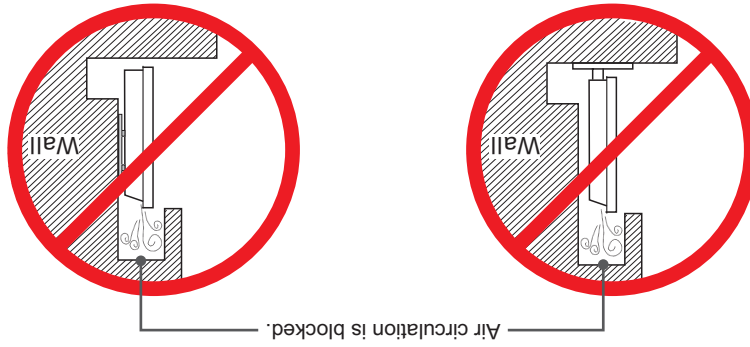

Inadequate air circulation can lead to overheating of the TV and may cause damage to your TV or cause a fire.

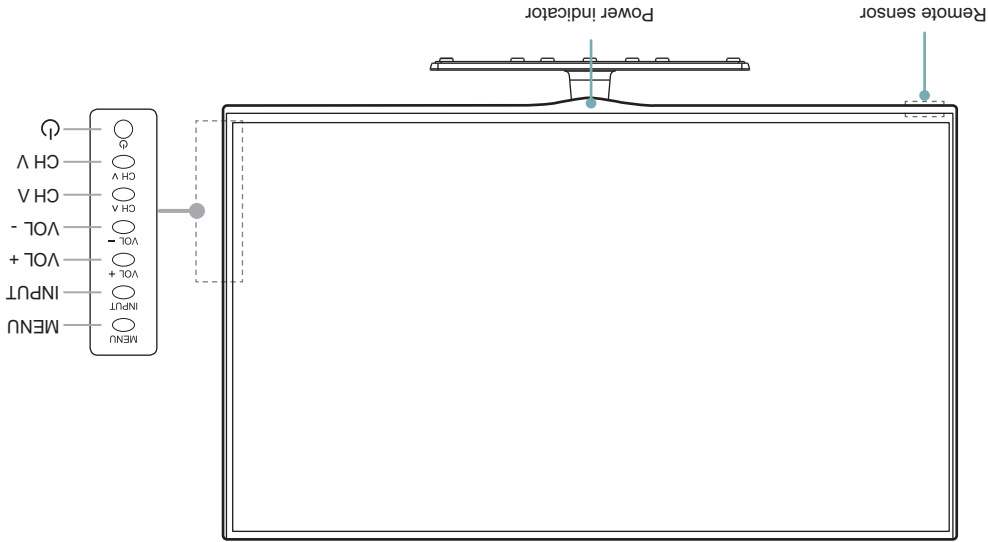

Item	Description
Power indicator	Light up when the power is on.
Remote sensor	Receives remote signals from the remote control. Do not put anything near the sensor, as its function may be affected.
MENU	Display an on-screen menu to setup your TV's features.
INPUT	Select among the different input signal sources.
VOL + / VOL -	Adjust the volume.
CH A / CH V	Select the channel.
Power button	Turn on the TV or put the TV in standby mode. <b>Caution:</b> The TV continues to receive power even in standby mode. Unplug the power cord to disconnect power.

NOTES

- FOR ILLUSTRATION ONLY.
- Powering up or down the TV requires several seconds of processing time. Do not rapidly turn the TV on/off as abnormal operation may occur.



## Installing Batteries in the Remote Control

### Change the batteries

1. Press the release button on the back of the remote control to remove the battery compartment cover.
2. Insert two AAA size batteries. Make sure to match the (+) and (-) ends of the batteries with the (+) and (-) ends indicated in the battery compartment.
3. Replace the battery compartment cover.

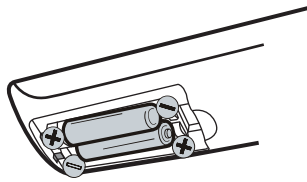

➊ Insert the batteries

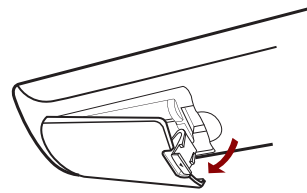

➋ Remove the battery compartment cover

### NOTES

1. Dispose of your batteries in a designated disposal area. Do not throw the batteries into a fire.
2. Do not mix battery types or combine used batteries with new ones.
3. Remove depleted batteries immediately to prevent battery acid from leaking into the battery compartment.
4. If you do not intend to use the remote control for a long time, remove the batteries.
5. Batteries should not be exposed to excessive heat, such as sunshine, heat registers, or fire.
6. Battery chemicals can cause a rash. If the batteries leak, clean the battery compartment with a cloth. If chemicals touch your skin, wash immediately.
7. Do not mix old and new batteries.
8. Do not mix alkaline, standard (carbon-zinc) or rechargeable (ni-cad, ni-mh, etc.) batteries.

Program Your Universal Cable or Satellite Remote Control to Operate Your New Hisense Television!

If you would like to program your other household remote controls to your new Hisense television, please consult the User's Manual supplied by your Cable or Satellite provider. The Cable or Satellite providers' User's Manuals should include instructions on how to program their remote to your television.

Below is a list of Hisense codes for the most common Cable and Satellite providers. Use the Hisense code that is associated with your Cable or Satellite provider (if applicable).

DIRECTV.....	0178 or 10019
Time Warner Cable.....	386 or 0178
Comcast.....	0178 or 10178
Cox Communications.....	0178
Dish Network.....	627 or 505
AT&T U-verse.....	1346

If the Hisense code associated with your Cable or Satellite provider is not listed above, if the code above does not work, or if you cannot locate the instructions for programming your household remote to your television, call your local Cable or Satellite provider's customer service center.  
If your Cable or Satellite provider does not have an Hisense code available, please visit <http://www.hisense-usa.com> for additional codes.

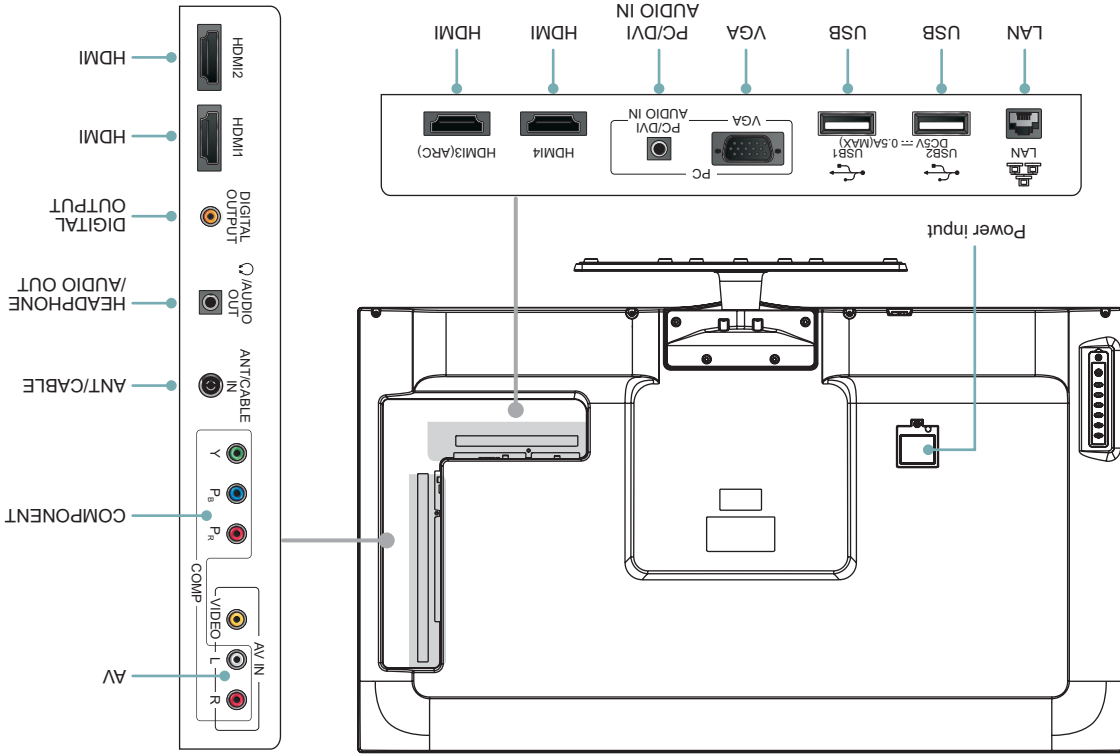

Item	Description
ANT/CABLE	Connect an antenna or cable TV to this jack.
HDMI	HDMI (High-Definition Multimedia Interface) provides an uncompressed, all digital audio/video interface between this TV and any HDMI-device, such as a set-top box, Blu-ray disc player, or AV receiver.
COMPONENT	Connect to a DVD player, Digital Set-Top-Box, or other AV devices with component (Y <sup>P</sup> B <sup>R</sup> ) video and audio output jacks.
VIDEO/AUDIO(L,R)	Connect to the composite video and audio (L/R) output jacks on external video devices.
VGA	Connect to a PC or other devices with a VGA interface.
PC/DVI AUDIO IN	Connect headphone or analog sound system using RCA Y-cable (1/8"-stereo mini to L/R phono-not provided).
DIGITAL OUTPUT	Connect to an external digital audio device.
USB	Port for Digital Media Player and for charging 3D glasses.
LAN	Connect an ethernet cable to access a network or the Internet.

**NOTE**

Some external devices impossible insert to this set for individual difference. Please replace with appropriate external signal cable or increase the adapter to match with the port in such case.

## NOTES

- Check the jacks for position and type before making any connections. Loose connections can result in image or color problems. Make sure that all connections are tight and secure.
- Not all A/V devices have the ability to connect to a TV, please refer to the user's manual of your A/V device for compatibility and connections procedure.
- Always unplug the power cord when connecting external equipment.

### Connecting an antenna, cable or cable/satellite box

1. Turn off the TV before connecting the antenna.
2. Connect one end of a coaxial cable (not included) to the RF OUT jack on the antenna, cable or cable/satellite box. If you are using an antenna with twin-lead cable, you may need a 300-75 ohm adapter (not provided) to connect it to the back of your TV. Likewise, if you are using several antennas, you may need a combiner (not provided).
3. Connect the other end of the cable to the ANT/CABLE IN jack on the side of your TV.

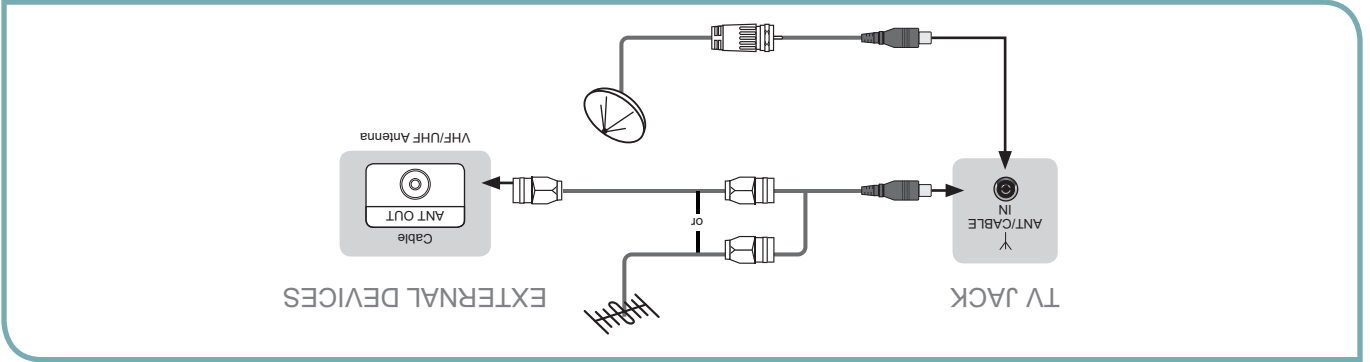

### Connecting an A/V Device with Composite Cable

1. Use the audio and video cables to connect the external A/V device's composite video/audio jacks to the TV's jacks. (Video = yellow, Audio Left = white, and Audio Right = red)
2. Plug the connected devices into the mains socket before switching on the TV.
3. Select the corresponding source from the TV.

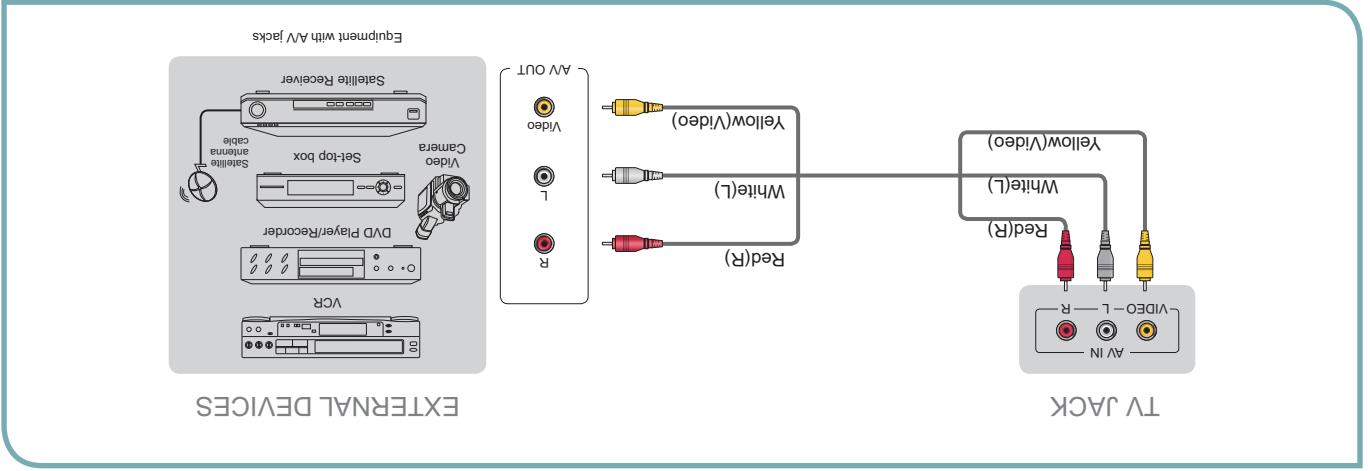



## Connecting an A/V Device with Component (Y<sup>P<sub>B</sub></sup>R<sub>R</sub>) Cable

1. Use a component cable to connect the external A/V device's component output jacks to the TV's Y<sup>P<sub>B</sub></sup>R<sub>R</sub> jacks. Use an audio cable to connect the external A/V device's component audio jacks to the TV's AUDIO (L/R) jacks.
2. Plug the connected devices into the mains socket before switching on the TV.
3. Select the corresponding source from the TV.

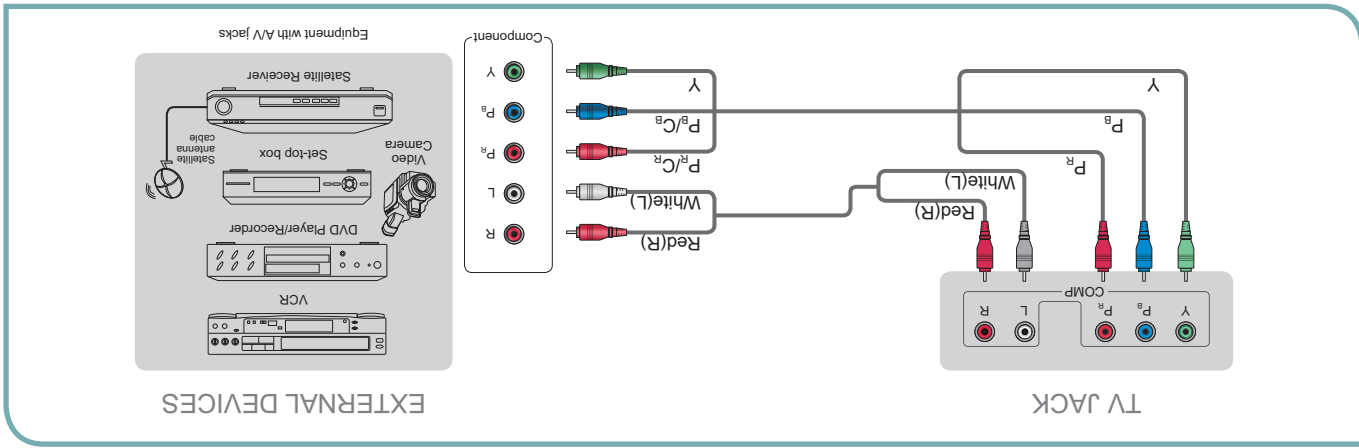

## Connecting an A/V Device with HDMI Cable

- Support digital connections between HDMI - enabled AV devices such as PVR, DVD, Blu-Ray, AV receiver and digital devices.
- Some devices such as PVR or DVD player require HDMI signal to be set to output in the device's settings.
- Please consult your device user manual for instructions.

1. Use an HDMI cable to connect the A/V device's HDMI output jack to the TV's HDMI jack.
2. Plug the connected devices into the mains socket before switching on the TV.
3. Select the corresponding source from the TV.

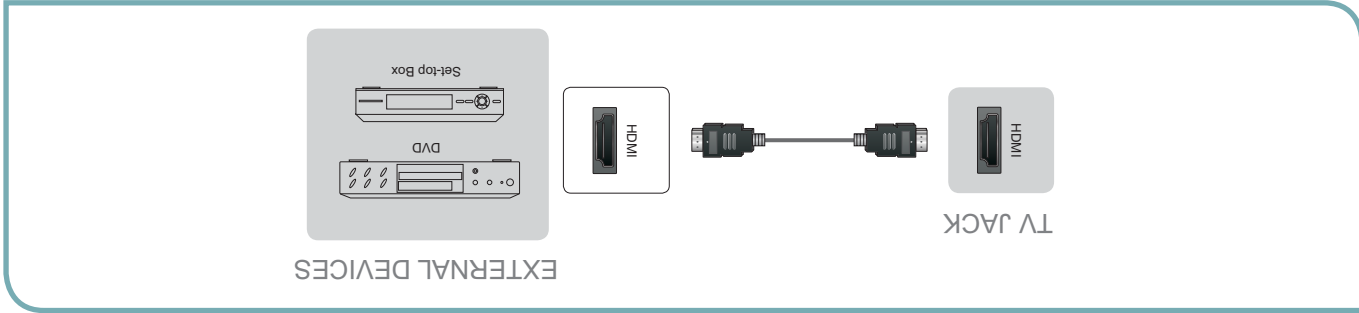

### NOTE

The HDMI connector provides both video and audio signals, it's not necessary to connect an audio cable.

## Connecting a headphone

Headphones or an analog sound bar can be connected to the AUDIO OUT jack on your set. (While the headphone is connected, the sound from the built-in speakers will be disabled.)

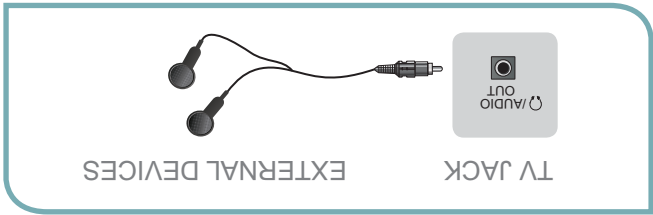

## Connecting a PC with VGA Cable

1. Use a VGA cable to connect the PC's VGA output jack to the TV's VGA jack. Use an audio cable to connect the PC's audio output jack to TV's PC/DVI AUDIO IN jack.
2. Plug the connected devices into the mains socket before switching on the TV.
3. Select the corresponding source from the TV.

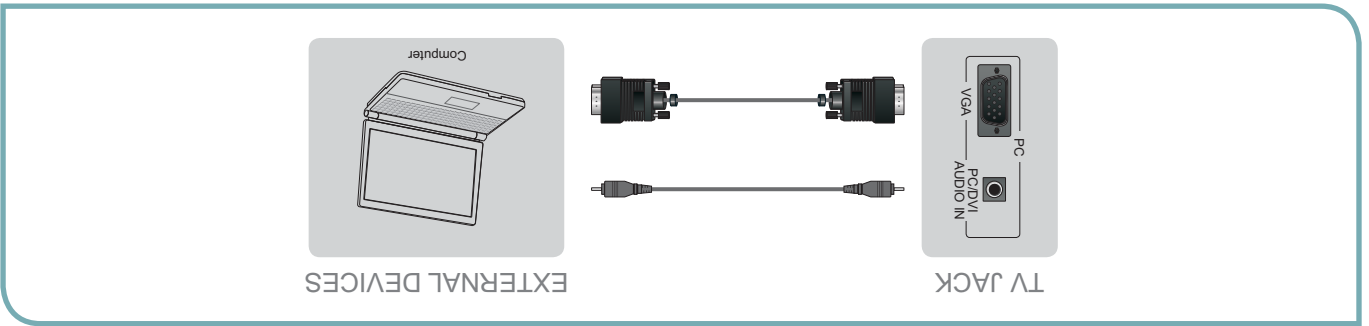

### NOTES

- Primarily this unit is intended for use as an LCD TV. If you want to use it as a monitor, please contact the manufacturer of the PC Video/Graphic's card for further support. Perfect compatibility is not guaranteed.
- The VGA cable will not supplied with the product.
- We strongly recommend to use VGA cable with 2 ferrite cores as shown in the figure.

## Connecting an Audio Receiver with Audio cable

1. Use an audio cable to connect the AV device's digital audio in jack to the TV's DIGITAL AUDIO OUT jack. Or use an RCA Y-cable (1/8"-stereo mini to L/R phono - not provided) to connect analog sound system to the TV's AUDIO OUT jack.
2. Plug the connected devices into the mains socket before switching on the TV.
3. Select the corresponding source from the TV.

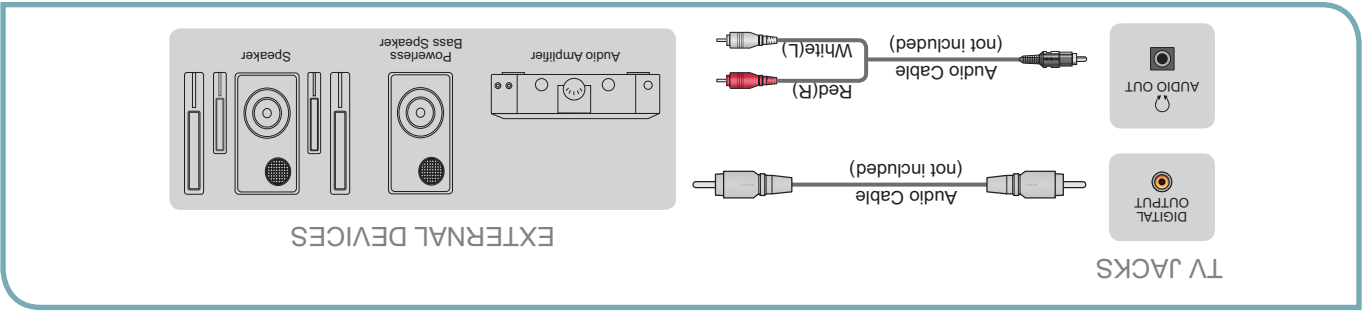

### NOTES

- When a digital audio system is connected to the DIGITAL AUDIO OUT (COAXIAL) jack, decrease the volume of both the TV and the system.
- 5.1 CH (channel) audio is available when the TV is connected to an external device supporting 5.1 CH.
- When the receiver (home theater) is set to on, you can hear sound output from the TV's digital audio out jack. When the TV is receiving a DTV signal, the TV will send 5.1 CH sound to the home theater receiver. When the source is connected to the TV via HDMI, only 2 CH audio will be heard from the home theater receiver. If you want to hear 5.1 CH audio, connect the digital audio out jack from your DVD/Blu-ray player/cable box/STB satellite receiver directly to an amplifier or home theater.

## Connecting an ethernet cable to access a network or the Internet

Connect an ethernet cable to access a network or the Internet. TV also features wireless connectivity. For more information, see "Network Connection".

## Turning the TV on or off

**IMPORTANT:** At first, you have to match the remote control with TV.

- To turn your TV on or off (standby mode):
1. Plug the power cord into an AC power outlet.
  2. Press [POWER] button, your TV turns on.
  3. Press [POWER] button again to turn off your TV. When you turn off your TV, it goes into standby mode.

### WARNING

When your TV is in standby mode, it is still receiving power. To completely disconnect power, unplug the power cord.

### NOTE

If your TV does not receive an input signal for several minutes, it automatically goes into standby mode.

## Turning the TV On for the First Time

The Setup Wizard menu appears the first time you turn on the TV. It will assist you to specify the menu language, Picture Mode, Tuner Mode and Channel Installation.

**IMPORTANT:** Make sure that the antenna or cable is connected and a wired or wireless internet connection is available.

1. Make sure that you have:
  - Installed the remote control batteries.
  - Connected an antenna or cable.
  - Connected the power cord.
  - Matched the remote control with TV.

2. Press [POWER] button to turn on your TV. The Setup Wizard menu displays.

3. Press [▲/▼/▶/◀] to select your menu language: English, Spanish or French, press [ENTER] button to confirm.

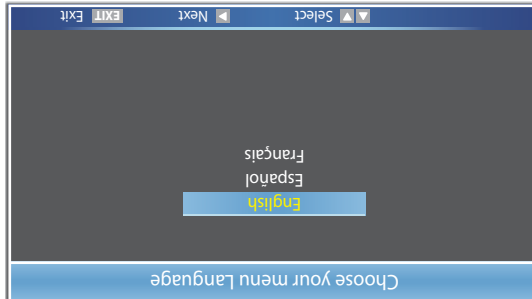

4. Press [▲/▼] to select your Picture Mode: Home Mode or Retail Mode, press [ENTER] button to confirm.

- If you select Retail Mode, a message appears "Please reconfirm Retail Mode" Select "Yes" to continue, or select "No" to change your selection.

## Selecting the Input Source

The first time you turn on your TV, you must select the TV signal source. Your TV stores this information, so you do not need to change the TV signal source unless it changes. For example, you change from an outside antenna to cable TV.

1. Turn on your TV, then press [INPUT] button on the remote or on the TV. The Input Source menu opens.

2. Press [▲/▼] button to highlight the input source, then press [ENTER] button.

3. Press [POWER] button again to turn off your TV. When you turn off your TV, it goes into standby mode.



6. Press [▲/▼] to set the Channel Installation: Scan or Skip Scan, press [ENTER] button to confirm.
  - If you select "Scan", your TV automatically starts Channel Installation available in your viewing area.
  - If you select "Skip Scan", your TV does not scan for channels.
  - Depending on the reception condition, it may take up to 25 minutes or more to complete memorizing channels. Please allow the process to complete without interruption.

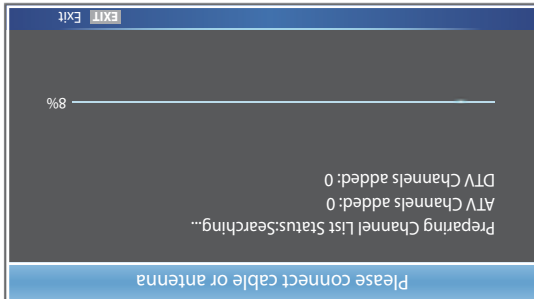

5. Press [▲/▼] to select your Tuner Mode: Antenna or Cable, press [ENTER] button to confirm.
- If you selected Retail Mode, Energy Saving is not realized.

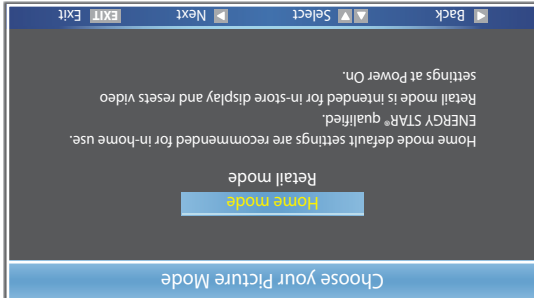

## Changing Channels / Volume

1. Press the [CH +/-] (or [CH +/-]) on the TV/remote control to change the channel.
2. Press the [VOL +/-] (or [VOL +/-]) on the TV/remote control to adjust the volume.
3. Press the numeric buttons on the remote control to display the corresponding channels.

### NOTE

Changing the channels can also be achieved by directly entering the channel number using the numeric keys on the remote control. If you are entering a two or three digit channel number, the time between key presses should be less than 3 seconds.

## Shortcuts Instructions

**Aspect** - Select the screen aspect ratio from Normal, Wide, Zoom and Cinema.

**Normal:** The original 4:3 aspect ratio (1.33:1 signal) is preserved, so black bars are added to the left and right of the image. Standard TV broadcasts are displayed with a 4:3 aspect ratio.

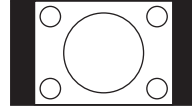

**Wide:** When watching a standard broadcast or full-frame movie in this mode, the display image is stretched proportionately to fill the TV screen. When watching a 16:9 widescreen program or movie, the display image fills the TV screen.

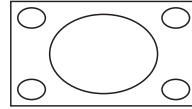

**Zoom:** Stretch the 4:3 aspect ratio image vertically and horizontally to fill the screen at 1:1.78 aspect ratio.

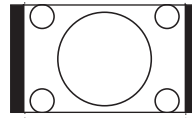

**Cinema:** Stretch the 4:3 aspect ratio image vertically and horizontally to fill the screen at 1:2.35 aspect ratio.

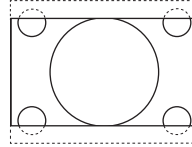

**1:1 Pixel Map:** Displays the native signal format pixel-by-pixel without any video processing or scaling. In this mode, 1920 x 1080 resolution sources fill the screen while all other resolutions are centered and surrounded by black bars.

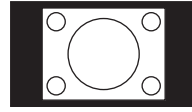

**Auto:** Detects the incoming signal format and automatically selects the proper aspect ratio.

**DISPLAY** - Display the information banner. The information including channel number, channel name, current system time, tuner mode, audio stream, video format, audio language, closed caption mode, parental locks rated, program details, etc.

**GUIDE** - Open the DTV program guide. The program guide information is provided by the broadcasting company.

**FAV** - Display your Favorite List. You can add or delete channels to create your favorite list.

**Cursor up/down:** Press [▲/▼] button to select the option.

**Add/Erase:** Press [YELLOW] button to add or delete the channel from Favorite List.

**Page up/down:** Press [RED/GREEN] button to page up or down.

**Vudu** - Vudu™ is an on-demand, pay-per-view, service that offers high-definition movies via the Web. You can access the Vudu service by pressing this button.

**Hi-Smart** - Press to open the Hi-Smart Hub. The Hi-Smart Hub provides convenient access to internet audio and video Services in addition to social networking and media sharing Services.

**NETFLIX** - Press to open the Netflix interface. Netflix is an online DVD and Blu-ray Disc rental service, offering instant access to movies and TV shows to Netflix members. Netflix unlimited membership required (subscription not included).

## To Use the Menu

- 1 Press the [MENU] button to open the main menu.
  - 2 Press [▲/▼] to select a menu option, then press [▶/ENTER] to enter the menu.
  - 3 In each menu, you can:
    - Press [▲/▼] to select an item,
    - Press [▶/◀] to adjust the value, or
    - Press [RETURN] to exit the submenu,
    - Press [EXIT] button to exit the menu.
- NOTE 
- FOR ILLUSTRATION ONLY.

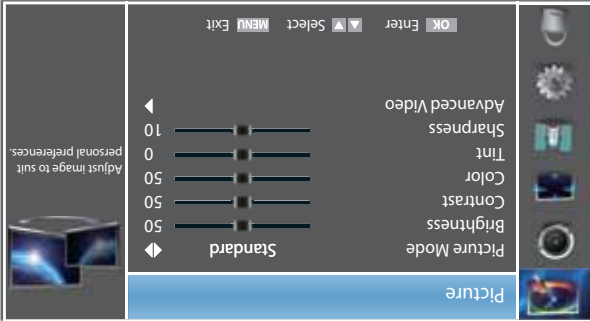

## Using the Picture Menu

### You can adjust:

- Picture Mode** - Adjust the Picture Mode. You can select Standard, Theater, Energy Saving, Game, Custom or Vivid.
- Brightness** - Increase or decrease the brightness of the picture. Increasing the brightness can add more light to dark areas of the picture, while decreasing the brightness can add more darkness to light areas of the picture.
- Contrast** - Increase or decrease the contrast of the picture. Increase the contrast to adjust the white areas of the picture or decrease the contrast to adjust the black areas of the picture.
- Color** - Adjust the level of color in the picture.
- Tint** - Adjust flesh tones so they appear natural.
- Sharpness** - You can increase the sharpness level for clearer images or decrease the sharpness level for smoother images.
- Advanced Video** - Access advanced video settings such as Color Temperature, Noise Reduction, Dynamic Backlight (DCR), Adaptive Contrast and Overscan.

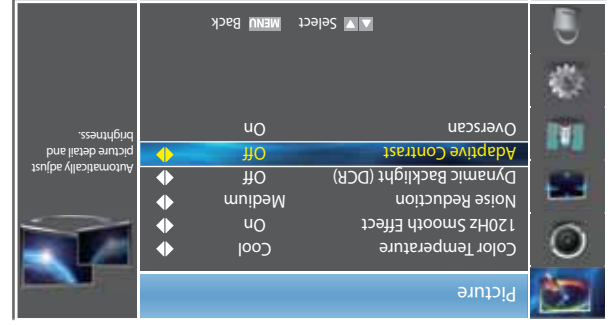

## Using the Audio Menu

select On or Off.

**Overscan:** Adjust the picture's reproduction rate. You can

level of the selected input source.

**Adaptive Contrast:** Automatically adjusts the contrast

select Off, Low or High.

**Dynamic Backlight (DCR):** Enhances the contrast ratio between light and dark areas of the picture. You can

High.

**Noise Reduction:** Optimize the picture quality by filtering signal interference. You can select Off, Low, Medium or

and Warm.

**Color Temperature:** Change the color temperature. You can select a preset color temperature: Cool, Standard

### You can adjust:

- Sound Mode** - Select the Sound Mode: Standard, Speech, Custom or Music.
- Balance** - Adjust the volume of the left and right speakers.
- Equalizer** - Soften or enhance the sound at specific frequency points.

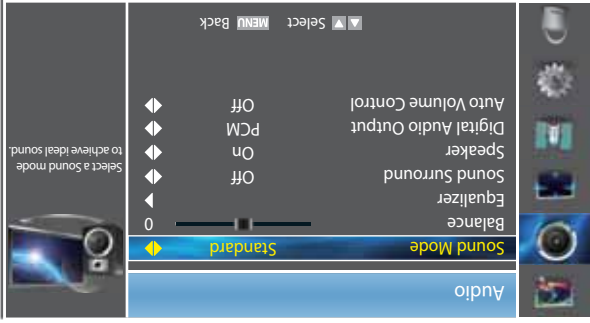

## Using the Channels Menu

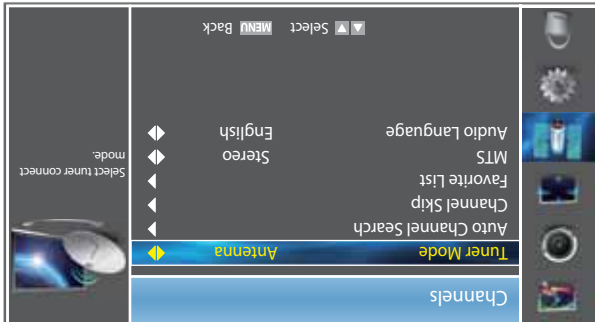

### You can adjust:

**Tuner Mode** - Select TV source: Antenna or Cable.

**Auto Channels Search** - Scans for channels that have signals and stores the channels information in the channel list.

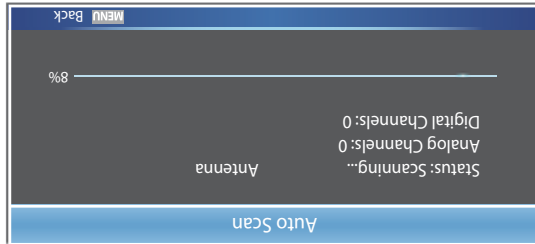

**Channel Skip** - You can cancel a channel stored in the channel list.

### NOTE

When you press [CHA / V] button, your TV skips the channel you cancelled. You can still tune to the channel using the number buttons on the remote control.

**Favorite List** - Add or delete channels to create a favorite list. You can press [FAV] button to display your Favorite List.  
**MTS** - Select the default audio stream: Mono, Stereo or SAP.  
**Audio Language** - Select the audio language: English, Español or Français.

### NOTE

Only available in TV mode.

### You can adjust:

**H.Position** - Move the image right or left.

**V.Position** - Move the image up or down.

**Phase** - Adjust the focus of stable images.

**Clock** - Adjust the sample frequency.

**Auto Adjust** - Detects input signal clock, phase and position and adjusts TV display accordingly.

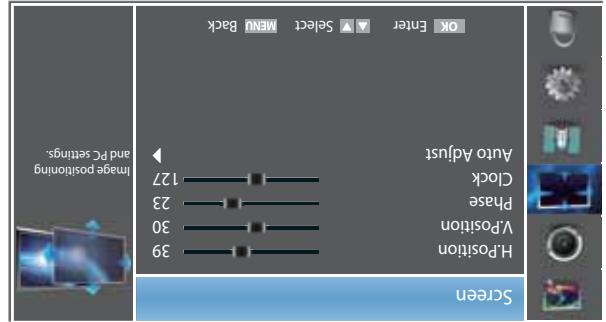

Only available in VGA mode.

### NOTE

## Using the Screen Menu

**Auto Volume Control** - Automatically adjusts volume to a consistent level; attenuates loud passages.

**RAW**: Passes through (output = input) the incoming audio signal without decoding. E.g. incoming Dolby Digital, DTS or PCM data stream is simply output as it is without any processing.

**PCM**: PCM outputs two channel audio regardless of the input format.

**Digital Audio Output** - Send digital audio to an external audio system. You can select PCM, RAW or Off.

**Speaker** - Selects where to play TV audio. You can select On (default setting) to play audio through TV speakers, or select Off to play audio through the speakers on an external audio system.

**Sound Surround** - Simulates surround sound and enhances bass response.

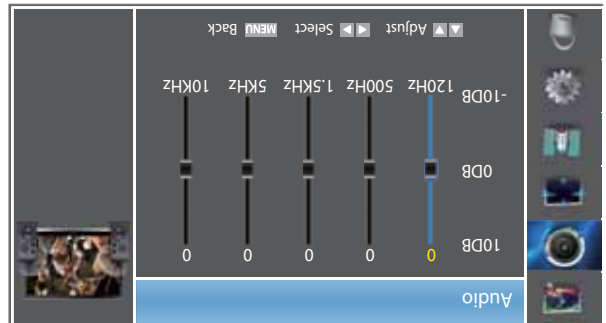



## Using the Settings Menu

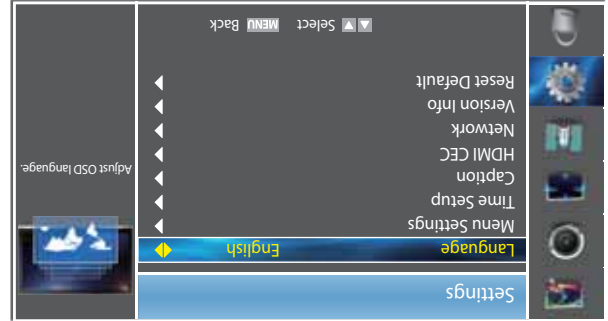

### You can adjust:

**Language** - You can select the menu's language to English, Español or Français.

**Menu Settings** - You can set On-screen menu system.

**Timeout:** Select the display time of the menu: 10-20-...

60 seconds.

**Demo Mode:**

**Time Setup** - Set the time zone, daylight saving, time and sleep timer.

**Time Zone:** Select your local time zone: Eastern Time, Indiana, Central Time, Mountain Time, Arizona, Pacific Time, Alaska or Hawaii.

**Daylight Saving:** Set the Daylight Saving time for your area.

**Time:** You can set time manually or select automatic if the TV is connected to an antenna or cable source.



● **Auto Synchronization:** Select "On" for automatic date and time setting using information from broadcast stations in your area.

● **Date/Time:** Set the current year/month/day/time.

● **Power On Timer:** When "On", you can set the time when the TV turns on automatically.

● **Time:** Set the desired time for the TV to turn on automatically.

● **Power Off Timer:** When "On", you can set the time when the TV turns off automatically.

● **Time:** Set the desired time for the TV to turn off automatically.

● **Sleep Timer:** Specify the amount of time before your TV automatically turns off: Off -10-...-120 minutes.

**Caption** - Adjust Closed Captioning settings.

● **Caption Control:** Select the Closed Caption mode: CC Off, CC On or CC On When Mute.

● **Analog Closed Caption:** Select an Analog Caption setting: CC1~CC4: Closed captioning appears in a small banner across the bottom of the screen. CC1 is usually the "printed" version of the audio. CC2~CC4 display content are provided by the broadcaster.

● **Text1~Text4:** Closed captioning that covers half or all of the screen. Text1~Text4 display content are provided by the broadcaster.

● **Off:** To turn off the Analog Caption.

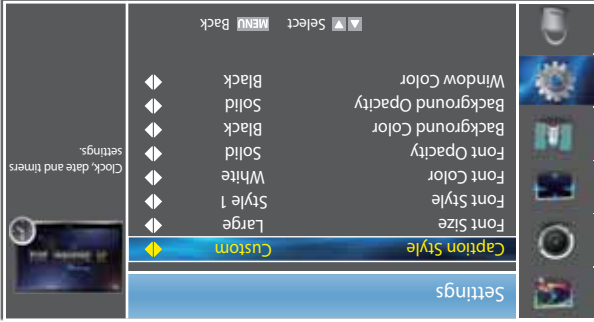

● **Digital Closed Caption:** Select a Digital Caption setting: Service1~Service6 or Off.

● **Digital Caption Style:** Customize the look of digital Closed Captioning.

● **Caption Style:** Set the look of Digital CC. "As Broadcaster" uses broadcaster's style.

● **Font Size/Color/Opacity:** Select the size/style/color/opacity level of font.

● **Background Color/Opacity:** Select the color/opacity level of the background.

## Using the Lock Menu

When you first use this function, the default password is [0000]. Once you input this password, you can set options.

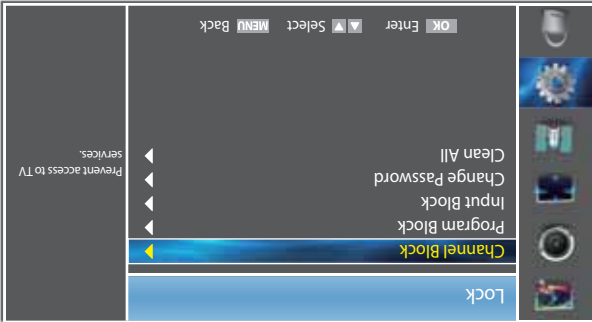

### You can adjust:

**Channel Block** - Block selected Channels on the TV.  
**Program Block** - Block selected Programs on the TV.

**Rating Enable:** Block or unblock TV ratings.

**U.S. TV Ratings:** Restrict TV programs by USA Ratings.

**U.S. Movie Ratings:** Restrict movie by USA Ratings.

**Canadian English/French Ratings:** Restrict movie and TV programs by Canadian Ratings.

**Open V-Chip:** Display an advanced V-Chip ratings table for digital channels (USA only).

**Block Unrated:** Block unrated TV programs.

**Input Block** - Block selected Input source on the TV.

**Change Password** - If you want to change the default password, first enter the new password then enter the same password again.

**Clean All** - You can reset all locks to factory mode.

- HDMI cables must be used to connect HDMI CEC - compatible devices to your TV.
- The connected device's HDMI CEC feature must be turned on.
- If you connect an HDMI device that is not HDMI CEC - compatible, all the HDMI CEC Control features will not work.
- Depending on the connected HDMI device, the HDMI CEC Control feature may not work.

- **Window Color:** Select the color of the window.

**HDMI CEC** - HDMI CEC lets you control HDMI CEC - compatible devices connected to the HDMI jacks on your TV using the remote control that came with your TV.

**Playback Device 2:** You can manually set your playback device in Standby or Power On mode.

**Setup:** To configure the HDMI CEC function.

- **CEC Function:** Enable HDMI CEC by selecting On.

● **Auto Turn Off:** When HDMI CEC is enabled, this function turns off HDMI CEC devices when you turn off your TV.

● **TV Auto On:** When HDMI CEC is enabled and you turn on an HDMI CEC device, this function turns on your TV automatically.

- **Device Discovery:** Displays a list of HDMI CEC devices that are connected to your TV.

**Network** - You can setup the network configuration in this menu. For more information, see "Network Connection" and "Network Setup".



## Basic Features

Following is the description of these ratings.

### U.S. Movie Ratings

Rating	Defined as
G	General audience
PG	Parental Guidance suggested
PG-13	Parents strongly cautioned
R	Restricted
NC-17	No one 17 and under admitted
X	Adult audience only

### U.S. TV Ratings

Age	Defined as
TV-Y	All children
TV-Y7	Directed to older children
TV-G	General audience
TV-PG	Parental Guidance suggested
TV-14	Parents Strongly cautioned
TV-MA	Mature Audience only

### Contents

Defined as	
A	All of the ratings below that rating set blocked automatically
D	Suggestive dialogue
L	Strong language
S	Sexual situations
V	Violence
FV	Fantasy Violence

### Canadian English Ratings

Rating	Description
C	Children
C8+	Children 8 years and older
G	General Programming, suitable for all audiences
PG	Parents Guidance
14+	Viewers 14 years and older
18+	Adult Programming

### Canadian French Ratings

Rating	Description
G	General
8 ans+	8+General; Not recommended for young children
13 ans+	Programming may not be suitable for children under the age of 13
16 ans+	Programming is not be suitable for children under the age of 16
18 ans+	Programming restricted to adults

## Network Connection

You can set up your TV so that it can access the Internet through your local area network (LAN) with a Ethernet or wireless connection.

### Connecting to a Wired Network

You can attach your TV to your LAN by one of the three following ways:

- You can attach your TV to your LAN by connecting the LAN port on the back of your TV to an external modem using a Cat 5 LAN cable. See the diagram below.

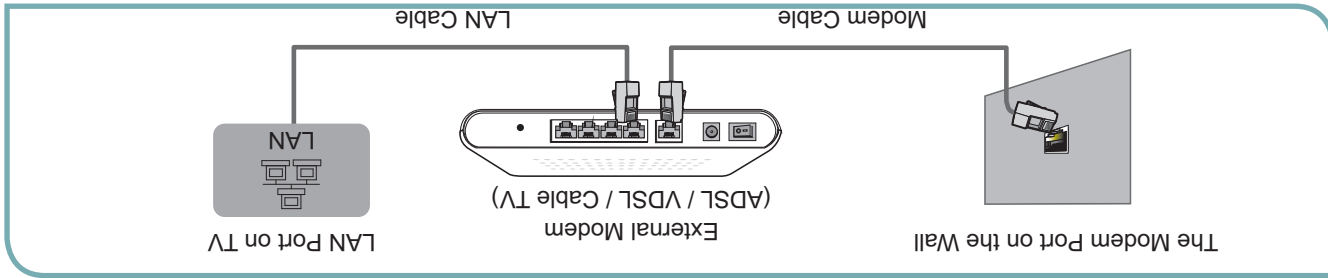

- You can attach your TV to your LAN by connecting the LAN port on the back of your TV to an IP Sharer which is connected to an external modem. Use LAN cable for the connection. See the diagram below.

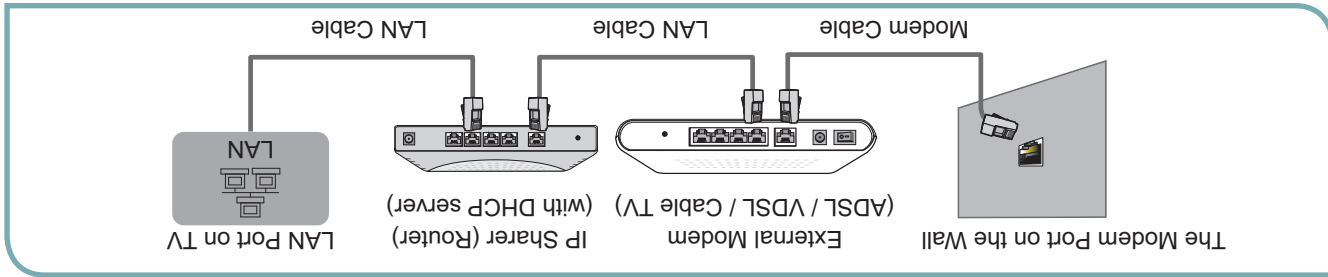

- Depending on how your network is configured, you may be able to attach your TV to your LAN by connecting the LAN port on the back of your TV directly to a network wall outlet with a Cat 5 cable. See the diagram below. Note that the wall outlet is attached to a modem or router elsewhere in your house.

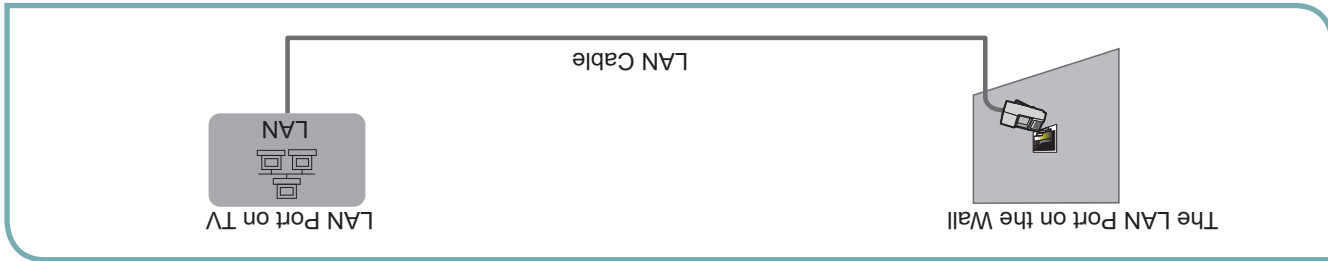

If you have a Dynamic Network, you should use an ADSL modem or router that supports Dynamic Host Configuration Protocol (DHCP). Modems and routers that support DHCP automatically provide the IP address, subnet mask, gateway, and DNS, so you don't have to enter them manually. Most home networks are Dynamic Networks. Some networks require a Static IP address. If your network requires a Static IP address, you must enter the IP address, subnet mask, gateway, and DNS values manually on your TV's Cable Setup Screen when you set up the network connection. To get the IP address, subnet mask, gateway, and DNS values, contact your Internet Service Provider (ISP).

If you have a Windows computer, you can also get these values through your computer.

### NOTE

You can use ADSL modems that support DHCP if your network requires a Static IP address. ADSL modems that support DHCP also let you use Static IP addresses.

## Network Setup (Auto)

Use the Automatic Network Setup while you connecting the TV to a network that supports DHCP. To set up your TV's cable network connection automatically, follow these steps:

1. Connect your TV to your LAN as described in the previous section.
2. Turn on your TV, operate according to the description in the Settings menu until the Network screen appears.

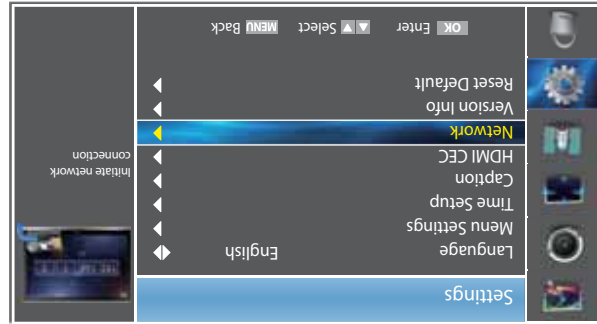

3. On the Network screen, select Configuration and press [ENTER] button to enter the submenu.

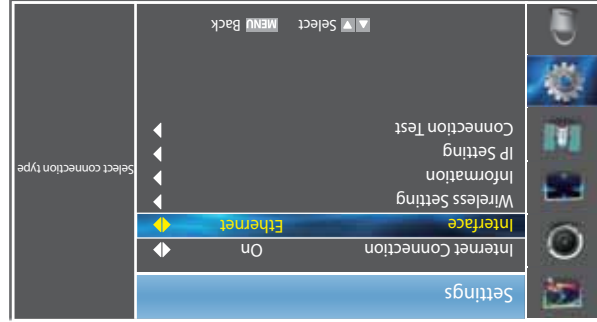

4. Set Internet Connection to On and Interface to Ethernet.



6. Set Address Type to Auto.
7. Auto acquires and enters the necessary connection values automatically.

8. If the connection values are not automatically entered, please check your modem and router manuals for directions to enable automatic IP addressing by DHCP. Or, follow the steps listed to the follow to manually configure the network connection.

## Network Setup (Manual)

Use the Automatic Network Setup when connecting your TV to a network that requires a Static IP address.

### Getting the Network Connection Values

To get the network connection values on most windows computers, follow these steps:

1. Right click the Network icon on the bottom right of the screen.
2. In the pop-up menu that appears, click Status.

3. On the dialog that appears, click the Support tab.
4. On the Support tab, click the Details button. The network connection values are displayed.

### How to set up manually

To set up your TV's network connection manually, follow these steps:

1. Follow Steps 1 through 5 in the "How to set up automatically" procedure.
2. Set Address Type to Manual.



3. Press [▲/▼] button to select IP Address and press [▶/◀] button to move the cursor to the entry field. Then press 0~9 buttons to enter the numbers.

4. Press [MENU] button to exit IP Address and press [▲/▼] button to select the next options to enter the numbers.

5. When done, press [MENU] button to return to the previous menu.
6. Select Connection Test to check the internet connectivity.

## Connecting to a Wireless Network

To connect your TV to your network wirelessly, you need a wireless router or modem. See the illustration below.

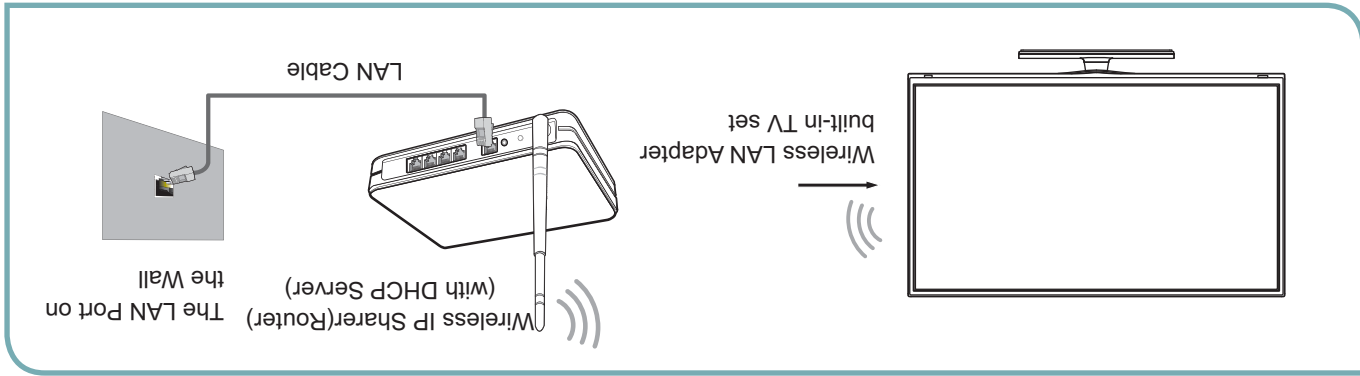

Hisense's built-in Wireless LAN Adapter supports the IEEE 802.11 b/g/n communication protocols. Hisense recommends using IEEE 802.11n router. When you play the video over a IEEE 802.11b/g connection, the video may not play smoothly.

### NOTES

- You must use the Hisense's built-in Wireless LAN Adapter to use a wireless network, the set doesn't support external USB network adapter.
- To use a wireless network, your TV must be connected to a wireless IP sharer. If the wireless IP sharer supports DHCP, your TV can use a DHCP or static IP address to connect to the wireless network.
- Select a channel for the wireless IP sharer that is not currently being used. If the channel set for the wireless IP sharer is currently being used by another device nearby, this will result in interference and communication failure.
- If you apply a security system other than the systems listed below, it will not work with the TV.
- If Pure High-throughput (Greenfield) 802.11n mode is selected and the Encryption type is set to WEP, TKIP or TKIP-AES (WPS2 Mixed) for your Access Point (AP), Hisense TVs will not support a connection in compliance with new Wi-Fi certification specifications.
- If your AP supports WPS (Wi-Fi Protected Setup), you can connect to the network via PBC (Push Button Configuration) or PIN (Personal Identification Number). WPS will automatically configure the SSID and WPA key in either mode.
- Connection Methods: You can setup the wireless network connection three ways.
  - Scan
  - Manual
  - Auto

## Wireless Setting

### How to set up

1. Turn on your TV, operate according to the description in the Settings menu until the Network screen appears.

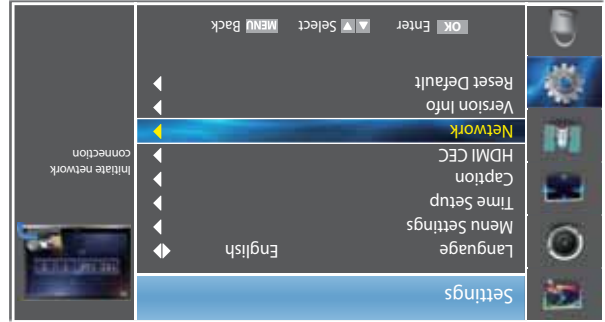

2. On the Network screen, select Configuration and press [ENTER] button to enter the submenu.

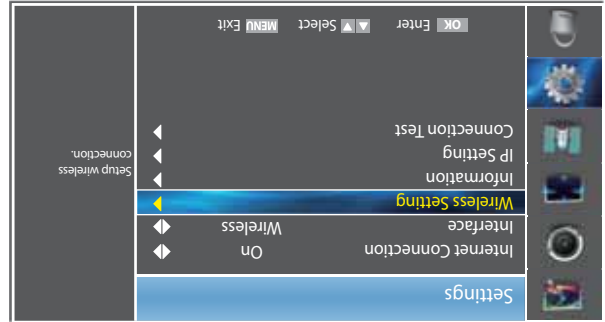

3. Set Internet Connection to On and Interface to Wireless.
4. Select Wireless Setting and press [ENTER] button to enter it.

You can select: Scan / Manual / Auto.

5. If you select Scan, a screen will appear listing all of the wireless networks within range of the TV. Use the [▼/▲] button to select the wireless network with your router SSID and press [ENTER] to confirm. Proceed to Step 7.

6. If you select Manual, a screen will appear prompting you to enter the SSID of your wireless network. Press [ENTER] and an on-screen keyboard will pop up. Enter the SSID and select OK. Press [ENTER] to confirm and a screen will appear prompting you select the security mode for your wireless network. Use the [▼/▲] button to select the proper security mode and press [ENTER] to confirm. If you selected None for the security mode, proceed to step 9.

7. A screen will appear prompting you to enter the password for the selected security mode. Press [ENTER] and an on-screen keyboard will pop up. Enter the password and select OK. Press [ENTER] to confirm. Proceed to Step 9.
8. If you select Auto, a screen will appear prompting you to select PIN (personal identification number) or PBC (push button configuration) setup. Choose the method supported by your wireless access point.

## Network Setup

Computer, TV and other digital devices can be connected via DLNA and they can share files with each other. You can use the TV set as a DLNA DMP (Digital Media Player) device to enjoy movies, pictures, music and other multimedia materials in your computer through DLNA connection. DLNA Setting needs to be set on TV and computer respectively.

## DLNA Settings

9. Press the [MENU] button to return to the previous menu.
10. Select Connection Test to check the Internet connectivity.

on your access point to connect to the TV.

- If you choose PBC, a screen will appear prompting you to press [▶] button. After pressing the [▶] button you have two minutes to locate and press the Push Button on your access point to connect to the TV.
- After entering the PIN, press the [▶] button. After entering the PIN, a screen will appear prompting you to obtain a new PIN and enter it into the access point. PIN is in use by another device, select [REFRESH] to After entering the PIN, press the [▶] button. If the on the screen for you to enter into the access point.
- If you choose PIN, an identification number will appear

1. Turn on your TV, operate according to the description in the Settings menu until the Network screen appears.

2. On the Network screen, select Configuration and press [ENTER] button to enter the submenu.

3. Set Internet Connection to On and Interface to Ethernet.
4. Select IP Setting and press [ENTER] button to enter it.

5. Set Address Type to Auto.

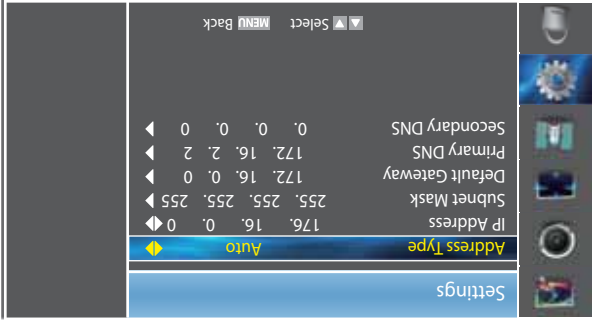

6. Auto acquires and enters the necessary connection values automatically.

7. If the connection values are not automatically entered, please check your modem and router manuals for directions to enable automatic IP addressing by DHCP. Or, follow the steps below to manually configure the network connection.

## Media Share Settings in Computer

If your computer does not support DLNA, you may install software that supports DLNA such as Tversity or Windows Media Player. We recommend Windows Media Player as the installation and setup is easier.

1. Start the Windows Media Player(V11 or higher).
2. Click "Library" and then "Add to Library...".



3. The "Add To Library" will pop up on the screen. Click "Add".



4. Select a folder and click "OK".

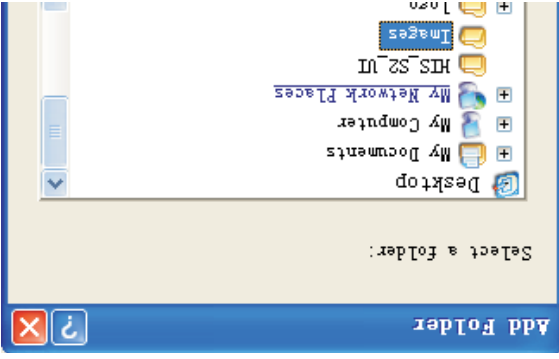

5. Click "Close" to close the dialog.

## To set up your TV's network connection manually, follow these steps:

- Follow Steps 1 through 5 in the "How to set up automatically" procedure.
- Set Address Type to Manual.



8. Set Address Type to Manual, enter IP Setting. Then press [▼/▲] button to select IP Address and press [▶/◀] button to move the cursor to the entry field. Then press 0~9 buttons to enter the numbers.
9. Press [MENU] button to exit IP Address and press [▼/▲] button to select the next options to enter the numbers.
10. When done, press [MENU] to return to the previous menu.
11. Select Connection Test to check the Internet connectivity.

## Set DLNA to On

1. On the Network screen, select Applications and press [ENTER] button to enter the submenu.
2. Press [▶/◀] button to set DLNA to On.





## Network Function

### NOTICE FOR USE

If you use VUDU services, see the following note before using it.

1. Use of Internet services requires a working broadband Internet connection (1 to 2 Mbps for SD video, 2.25 to 4.5 Mbps for HD video and 4.5 to 9 Mbps for HDX video).
2. VUDU and other Internet-based services are not provided by Hisense, may change or be discontinued at any time and may be subject to restrictions imposed by your Internet service provider. The quality, functionality, or availability of such services may be affected by the capacity of your Internet connection. Use of VUDU video-on-demand and other Internet services may require the creation of a separate account through a computer with Internet access.
3. Certain VUDU services may not be available for this TV model.
4. VUDU video-on-demand and other Internet services may require payment of one-time and/or recurring charges.
5. You are solely responsible for any charges incurred as a result of using Internet-based content, including, without limitation, communications charges for the provision of Internet or network services and any charges incurred for third-party Internet content services, such as video on demand or subscription services. All third-party services are provided in accordance with whatever terms and conditions are established between such third-party providers and you.
6. HISENSE MAKES NO REPRESENTATIONS OR WARRANTIES ABOUT THE CONTENT, AVAILABILITY OR FUNCTIONALITY OF THE VUDU SERVICE OR OTHER INTERNET DELIVERED THIRD-PARTY SERVICES AND DOES NOT WARRANT THAT ANY OF THEM WILL BE UNINTERRUPTED, ERROR FREE OR SATISFACTORY. ANY IMPLIED WARRANTY, INCLUDING BUT NOT LIMITED TO ANY IMPLIED WARRANTY OF MERCHANTABILITY OR FITNESS FOR A PARTICULAR PURPOSE OF ANY THIRD PARTY CONTENT OR SERVICE, IS EXPRESSLY EXCLUDED AND DISCLAIMED. UNDER NO CIRCUMSTANCES WILL HISENSE BE LIABLE IN CONTRACT, TORT OR UNDER ANY OTHER THEORY FOR ANY DAMAGES ARISING OUT OF OR IN CONNECTION WITH YOUR USE OF ANY CONTENT OR SERVICE PROVIDED BY ANY THIRD PARTY, EVEN IF ADVISED OF THE POSSIBILITY OF SUCH DAMAGES.

### Settings to Share Files

1. Click "Library" and move the cursor to select "Media Sharing..."



2. Click the box to select "Share my media" and click "OK".



3. An equipment icon will appear on the white area if the DLNA Settings has been correctly set. Select the appropriate icon and then click "Allow".

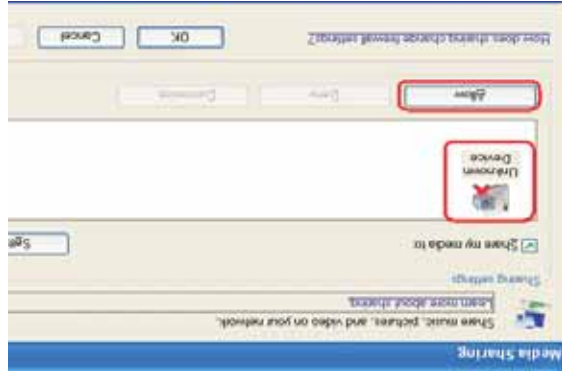

4. The TV now has access to the shared files on the computer.



Operational buttons

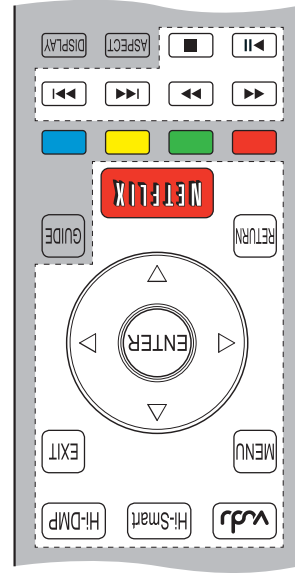

Enter the Network Applications

1. Press the [Hi-Smart] button to display network services.
- 
2. Press [▶/◀] button to select the App you want to view and press [ENTER] to launch it.

Brief introduction

VUDU is an on-demand service that offers high-definition movies on Web. For enjoying more movies, please register and log in to your account.

Operation instructions

- You can access the VUDU HD Movies by the following method:
1. Press the [Hi-Smart] button to display network hub.
  2. Press [▶/◀] button to select the VUDU HD Movies icon and press [ENTER] to enter it, or press [VUDU] button to enter directly.
  3. Select the Sign Up Now icon on the VUDU HD Movies interface, and press [ENTER] to enter.
  4. Please read the content of the Disclaimer first. If agree, press [GREEN] button and then access the network main menu. If disagree, press [RED] button or [YELLOW] button to cancel or exit Disclaimer menu, then network cannot be used.

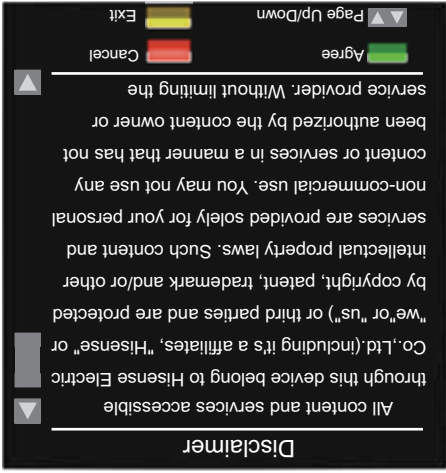

5. Enter your email address to start your VUDU experience. (Refer to "How to Input the Email Address" on page 27.)

Button	Description
	Press to launch VUDU Movies App directly.
	Open the Hi-Smart Hub with links to various Internet Services.
	Open the digital multimedia player.
	Open the menu.
	Close the menu.
	Return to the previous menu.
	Navigate Up / Down / Left / Right or adjust OSD settings.
	Confirm selections.
	Press to launch NETFLIX App directly.
	Display the TrickPlay screen and fast forwards playback.
	Display the TrickPlay screen and fast reverses playback.
	Play the previous one.
	Play the next one.
	Pause playback. Press the button to return to playback.
	Stop playback and display the file title screen.



# Advanced Features

6. Press [▲/▼/▶/◀] button to move the cursor to select service items in the VUDU HD Movies home page, and press [ENTER] button to confirm.

7. In the process of watching a movie, press [ENTER] button to display/exit the tool bar, press [▶/▶] button to select the function icon, and press [ENTER] button to confirm. 8. Press [RETURN] button to return the upper menu, or press [EXIT] button to close the menu.

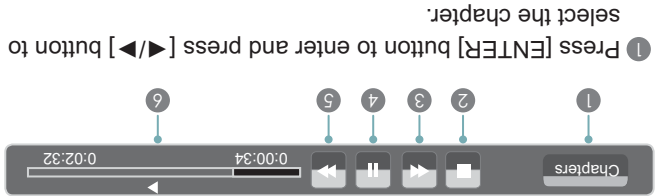

- 1 Press [ENTER] button to enter and press [▶/▶] button to select the chapter.
- 2 Stop playback.
- 3 Fast backward. Press [ENTER] to select the backward speed. You can press [▶▶] button to achieve the function.
- 4 Play/Pause. You can press [▶||] button to play/pause directly when there is no control bar on the screen.
- 5 Fast forward. Press [ENTER] button to select the forward speed. You can press [▶▶▶] button to achieve the function.
- 6 Progress bar. The progress bar when playing.

## How to Input the Email Address

1. Press [▲/▼/▶/◀] button to move the cursor to the address bar and press [ENTER] button to confirm.
  2. Press [ENTER] button to display the keyboard.
- There are some shortcuts on the bottom of the keyboard so that you can input part of the address often used directly.
- Other keys are used as the keyboard of your computer.



3. Press [▲/▼/▶/◀] button to move the cursor to the characters you want to select and then press [ENTER] button to confirm.
- If you want to delete one character, move the cursor to Back key [X] and press [ENTER] button to confirm.
4. Move the cursor to Done key and press [ENTER] button to confirm if you have completed the address input. Then the new address will appear on the address bar.

## VUDU HD Movies subpage



Title	Function
New	The latest movies
Top Picks	Mostly picked up movies
Top Rentals	Mostly rented movies
New Trailers	Latest trailers
Coming Soon	The movies can be picked soon
Browse	Browse all the movies in VUDU
Collections	Browse the classified movies
My VUDU	The movies user bought or rented
Search	Search movies in VUDU



## VUDU HD Movies home page

Title	Function
Rent/Own	To rent or buy current movie
Watch Trailer	To watch trailer of the current movie
2 Minute Preview	To preview current movie for 2 minutes
Add to Wishlist	Add current movie to your Wishlist
Rate/share	To rate current movie or share it to your friends in Facebook or Twitter
Overview	The overview of current movie
Cast & Crew	The cast and crew of current movies and find their related movies
Reviews	The reviews of current movie
Similar	The similar types of movies
More Info	The detail information of current movie

## VUDU Apps

### Brief introduction

The applications platform for connected TVs.

- VUDU Apps provides customers with access to a wide range of Internet services and applications including streaming video, music on demand, photo browsing, social networking and more.
- VUDU Apps supports the development of responsive apps designed specifically for use on home HD televisions.
- VUDU Apps uses a unique, cloud-based architecture optimized for consumer electronics devices, including delivering the latest applications to consumers without the need for software downloads or frequent firmware updates.

### Operation instructions

You can access the VUDU Apps by the following methods:

1. Press the [Hi-Smart] button to display network hub.
2. Press [▶/▶] button to select the VUDU Apps icon and press [ENTER] to enter it.
3. Press [▶/▶/▲/▲] button to select the widget you want to access, and press [ENTER] to enter it.
4. You can press [RETURN] to return the upper menu or press [EXIT] button to close the Widgets display.

### VUDU Apps home page



Title	Function
My favorites	The user's favorite applications
Most popular	The most popular applications
Newest	The newest applications in VUDU
Browse by genre	Browse applications by genre
Show Ticker	Show the applications at the bottom of screen while watching TV
Info & settings	VUDU Apps system information

## Netflix

Netflix unlimited membership required.

### Brief introduction

Instantly watch thousands of TV episodes & movies streaming over the Internet from Netflix. Unlimited membership required.

### NOTES

- TV screen may be difference with picture.
- For more information on Netflix visit <http://www.netflix.com/help> or login to your Netflix account and click "Help" at the top of the page.
- Your broadband fluency and picture quality depend on the network speed and original bit rate.
- Illustrations are examples and may differ from the actual Netflix screens. The display and operations may change as a result of a software update. Use Netflix without configuring a proxy server. Part or all of Netflix may not be available when connecting to the Internet via a proxy server.

### Operation instructions

1. Press the [Hi-Smart] button to display network hub.
2. Press [▶/▶] button to select the Netflix icon and press [ENTER] to enter it, or press [NETFLIX] button to enter Netflix website directly.
3. Input Email and Password in following window to sign in. (Refer to "How to Input the Email Address" on page 27)



4. Press [▲/▲/▶/▶] button to move the cursor to select service items in the Netflix home page, and [ENTER] button to confirm.
5. In the process of watching a movie, press operational buttons to control the movie.
6. Press [RETURN] button to return the upper menu, or press [EXIT] button to close the menu.

## Netflix Movies home page



Title	Function
Suggestions for you	The movies suggested for you by Netflix
New Arrivals	The new arrivals
Genres	Browse movies in different genres
Instant Queue	Your list of movies
Search	Search for available titles

## Brief introduction

With YouTube you can watch original videos, music videos, feature length movies, shorts, and trailers on your TV screen. Search or browse the recommendations with the TV remote control.

## Operation introduction

1. Press the [Hi-Smart] button to display network hub.
2. Press [▶/▶] button to select the YouTube icon and press [ENTER] to enter it.

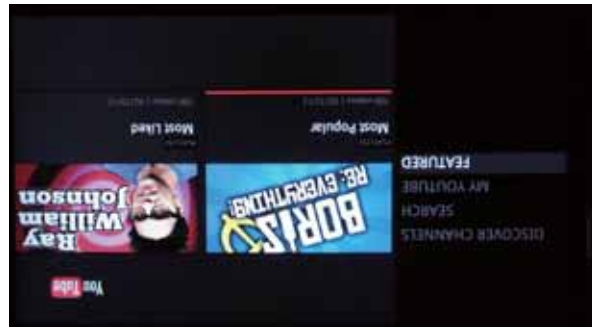

## Pandora

### Brief introduction

Pandora is a personalized radio service that streams music on your TV. Just start with the name of one of your favorite artists, songs, comedians, or composers and Pandora will create a custom station that plays similar tracks. Pandora features hundreds of music and comedy genre stations. Create up to 100 stations so you can easily switch between favorites.

### Operation introduction

1. Press the [Hi-Smart] button to display network hub.
2. Press [▶/▶] button to select the Pandora icon and press [ENTER] to enter it.

3. Input Email and Password in following window to sign in. (Refer to "How to Input the Email Address" on page 27)

4. Press [▲/▲/▶/▶] button to move the cursor to select service items in the Pandora home page, and [ENTER] button to confirm.

5. Press [RETURN] button to return the upper menu, or press [EXIT] button to close the menu.

## Picasa

### Brief introduction

With Picasa App you can explore featured photos in Google Picasa Web Album, also you can search your favorite photos in Google Picasa account, you can enjoy your private photos stored in Google Picasa Web Album. If you have already had a Google Picasa account, you can enjoy your private photos stored in Google Picasa Web Album.

### Operation introduction

1. Press the [Hi-Smart] button to display network hub.
2. Press [▶/▶] button to select the Picasa icon and press [ENTER] to enter it.





3. Press [▲/▼/▶/◀] button to move the cursor to select service items in Picasa screen and [ENTER] button to confirm.



4. To use other features, press the button showed in the help bar.
5. Press [RETURN] button to return to the upper menu, or [EXIT] button to close the App.



## Viewster

### Brief introduction

With Viewster App you can enjoy your favorite movie categories from a choice that includes comedies, action movies, thrillers, romances, documentary films, horror movies, dramas and adventures.

### Operation introduction

1. Press the [Hi-Smart] button to display network hub.
2. Press [▶/◀] button to select the Viewster icon and press [ENTER] to enter it.



3. Press [▲/▼/▶/◀] button to move the cursor to select service items in Viewster screen and [ENTER] button to confirm.
4. To use other features, press the button showed in the help bar.
5. Press [RETURN] button to return to the upper menu, or [EXIT] button to close the App.

## AccuWeather

### Brief introduction

With AccuWeather App you can instantly get the latest weather information of the city you added.

### Operation introduction

1. Press the [Hi-Smart] button to display network hub.
2. Press [▶/◀] button to select the AccuWeather icon and press [ENTER] to enter it.



3. Press [▲/▼/▶/◀] button to move the cursor to select service items in AccuWeather screen and [ENTER] button to confirm.
4. To use other features, press the button showed in the help bar.
5. Press [RETURN] button to return to the upper menu, or [EXIT] button to close the App.

## Vimeo

### ▣ Brief introduction

Vimeo App provides plenty of HD video. All these video are mainly divided into two parts: Featured Video and Categories Video which includes Activism & Non Profits, Animation & Motion Graphics, Art, Comedy, Education & DIY, Everyday Life, Experimental, Films, HD, Music, Products & Equipment, Science & Tech, Sports and so on.

When you sign in this App, you can bookmark you favorite movie and watch the movie last watched.

### ▣ Operation introduction

1. You can choose the movie you like to watch in Featured and Categories in home page.
2. If you want to sign in Vimeo, please choose Setting.
3. After signing in Vimeo, you can save your favorite video to My Stuff or Watch Later.
4. Choose Search to search the name of movie or music you love.
5. To use other features, press the button showed in the help bar.
6. Press [RETURN] button to return to the upper menu, or [EXIT] button to close the App.

## Network Apps Service Information

- **VUDU customer care:** To learn more about VUDU, visit the frequently Asked questions at [www.vudu.com/support](http://www.vudu.com/support).
- **Netflix customer service:**  
US: (866) 716-0414  
Canada: (866) 348-2353

## Digital Media Player

Please note that Hisense will not assume any responsibility for any lost data and cannot guarantee perfect compatibility with all mass storage devices. Be sure to insert the USB disk or mobile hard disk with standard USB2.0 port.

- Press [INPUT] button to display the INPUT menu, press [▲/▼] button to highlight the HI-DMP source, then press [ENTER] button to confirm. (If you want to exit HI-DMP, you can press [INPUT] button to switch to other sources).
- Press [RED] button to switch the media type.
- Press [YELLOW/BLUE] to turn to the previous/next page.
- 1. Press [▲/▼/▶/◀] button to select the folder/file you want to open and then press [ENTER] to enter/play the folder/file.
- 2. Press [RETURN] to return to the previous directory.



### ▶ Playable format list

Files Format	Playable format
Photo	JPG
Music	MP3
Video	MPEG1(.dat), MPEG2(.mpg/.ts), XVID(.avi), H.264(.mov/.ts/.mkv)

## Enjoy Video Files

1. Press [RED] button to switch to All or Video.
2. Press [▲/▼/▶/◀] to select the video you want to view.
3. Press [ENTER] to play the video.
4. Press [■/RETURN] to exit the video and return to the previous directory.
5. Press [ENTER] button to display/exit the video control bar.
6. Press [▶/◀] button to select the function icon and then press [ENTER] to confirm.

## Advanced Features

### ● Tool bar

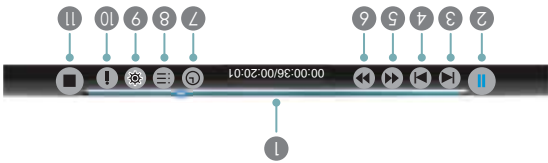

- 1 The progress bar when playing.
- 2 Play/Pause. You can press [▶||] directly to play/pause when there is no control bar on the screen.
- 3 Play the previous video. You can press [◀▶] directly to achieve the function when no control bar display on the screen.
- 4 Play the next video. You can press [▶▶] to achieve the function when no control bar display on the screen.
- 5 Fast backward. Then press [ENTER] to select the backward speed. You can press [◀◀] to achieve the function.
- 6 Fast forward. Then press [ENTER] to select the forward speed. You can press [▶▶] to achieve the function.
- 7 Select time to play. Press [▶/◀] to select the position you want to set. Press [0~9] to set the time and press [▲/▼/▶/◀] to adjust it.
- 8 Press [ENTER] to confirm and the video will play at the time you have set.
- 8 Play list
- 9 Press Yellow/Blue button to page and press [▲/▼] to select the video.
- 9 Options

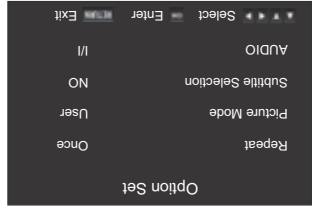

- Press [▲/▼] to select the options in the menu.
- Press [▶/◀] to select the settings.
- Press [ENTER] to confirm.
- 10 Program info
- 11 Allows you to view the program information.
- 11 Stop playback

### NOTE

You can press [ASPECT] button to change the aspect ratio (Normal, Full Screen, Original Size) while playing the video.

## Enjoy Music Files

1. Press [RED] button to switch to All or Music.
2. Press [▲/▼/▶/◀] to select the music you want to enjoy.



3. Press [ENTER] to play the music.



4. All the music is listed on the left. Press [▲/▼] button to select the music and press [▶] button to mark it. You can press [YELLOW/BLUE] button to turn to the previous / next page. Press [GREEN] button to select the Mode: Mark / All / Single.
5. Press [RETURN] to exit the music playback interface.

## Browse the Pictures

1. Press [RED] button to switch to All or Picture.
2. Press [▲/▼/▶/◀] to select the picture you want to view.



3. Press [ENTER] to browse the picture.
4. Press [■/RETURN] to exit the picture and return to the previous directory.

### Tool bar



### When browsing the pictures

- Press [ENTER] button to display/exit the picture control bar, and press [▶/◀] button to select the function icon and then press [ENTER] button to confirm.
- 1 Browse the previous picture. You can press [▶▶] button directly to achieve the function when no control bar displays on the screen.
  - 2 Browse the next picture. You can press [◀◀] button directly to achieve the function when no control bar displays on the screen.
  - 3 Allows the picture to rotate 90 degrees clockwise.
  - 4 Allows the picture to rotate 90 degrees anti-clockwise.
  - 5 Play/pause. You can press [ENTER] button directly when no control bar on the screen. You can press [■] button directly when no control bar on the screen.
  - 6 Stop browsing the picture. You can press [■] button directly when no control bar on the screen.
  - 7 Zoom in the picture.
  - 8 Zoom out the picture.
  - 9 Option Set. Press [▲/▼] button to select the options and press [▶/◀] button to set them.

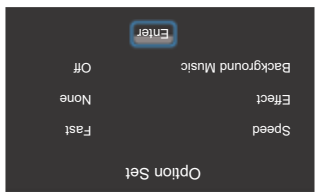

- Speed: Allows you to browse the picture at different speed.
- Effect: Allows you to set how the picture appears on the screen.
- Background Music: Allows you to enjoy the music when browsing the pictures if it is set On.
- 10 Picture info. Allows you to view the picture information.

## Digital Media Receiver

### Brief introduction

With the Digital Media Receiver you do not have to crowd around a small tablet PC or smartphone screen to share video, music or pictures with friends and family. Simply browse, discover and beam media files stored on your Android or iOS device to your TV using the Twonky Beam application.

### Operation introduction

1. TV side:
  - Confirm the TV is connected to a local area network. (See pages 20~23)
  - Set DLNA to On. (See page 24)
  - 2. Device Setup:
    - Download the Twonky Beam application using the link found on the Hisense website at [www.hisense-usa.com](http://www.hisense-usa.com).
    - Confirm the device is connected to the same local area network as the TV.
    - Launch the Twonky Beam application, select the video, music or picture you want the share and beam it to the TV.
    - You can control the playback using the TV remote or from the device application.

## Browse the Text Files

1. Press [RED] button to switch to All or Book.
2. Press [▲/▼/▶/◀] to select the text you want to view.



3. Press [ENTER] button to confirm.
4. Press [■/RETURN] to exit the text and return to the previous directory.

### Tool bar

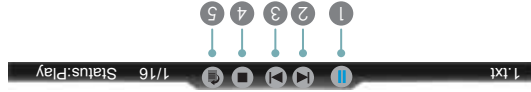

### When browsing the text files

When no tool bar appears on the screen, you can press [▲/▼] to move the text lines up/down. Press [ENTER] to display/exit the tool bar. Press [▶/◀] to select the corresponding icons and then press [ENTER] to confirm.

- 1 Stop/resume automatic page
- 2 View the previous page.
- 3 View the next page.
- 4 Stop browsing.
- 5 Allows you to select page to view.



- Press [0~9] buttons to input the page or press [▲/▼] to adjust it.
- Press [▶/◀] to select Enter and press [ENTER] to confirm.



## Trouble Shooting

### Other Information

When something appears wrong with your TV refer to below chart. If the proposed remedy's do not work, then unplug the AC cord from wall, wait at least 60 seconds, plug AC back in and then turn on the TV. If the problem still cannot be solved, please contact the help line provided on the warranty card or a professional technician.

<b>POSSIBLE SOLUTIONS</b>	<b>SYMPTOMS</b>
<ul style="list-style-type: none"> <li>● Check if the power cord is plugged into AC outlet and if it has electricity.</li> <li>● Check if you have pressed [POWER] button on the TV or [POWER] button on the remote control.</li> <li>● Check to see if LED light is either red or blue. If illuminated, power to TV is OK.</li> </ul>	<p>No sound or picture.</p>
<ul style="list-style-type: none"> <li>● Check for the correct output connection on the external source and for the correct input connection on the TV.</li> <li>● Make sure you have made the correct selection for the input mode for the incoming signal.</li> </ul>	<p>I have connected an external source to my TV and I get no picture and/or sound.</p>
<p>Yes, this is normal. That is the TV searching for previous setting information and initializing the TV.</p>	<p>When I turn on my television, there is a few second delay before the picture appears. Is this normal?</p>
<ul style="list-style-type: none"> <li>● Check the volume settings.</li> <li>● Check if Mute mode is set "on".</li> </ul>	<p>Picture is normal, but no sound.</p>
<ul style="list-style-type: none"> <li>● If black and white picture first unplug TV from AC outlet and re-plug after 60 seconds.</li> <li>● Check Color Setting if picture is black and white.</li> </ul>	<p>Sound but no picture or black and white picture.</p>
<ul style="list-style-type: none"> <li>● An electrical appliance may be affecting TV set. Turn off any appliances, if interference goes away, move appliance farther away from TV.</li> <li>● Insert the power plug of the TV set into another power outlet.</li> </ul>	<p>Sound and picture distorted or appear wavy.</p>
<ul style="list-style-type: none"> <li>● If using an external antenna, check the direction, position and connection of the antenna.</li> <li>● Adjust the direction of your antenna or reset or fine tune the channel.</li> </ul>	<p>Sound and picture is blurry or cuts out momentarily.</p>
<p>Check if there is interfering source nearby, such as appliance or electric tool.</p>	<p>Horizontal/vertical stripe on picture or picture is shaking.</p>
<p>"Click" sound can be caused when the room temperature changes. This change causes the television cabinet to expand or contract, which makes the sound. This is normal and the TV is OK.</p>	<p>The plastic cabinet makes a "clicking" type of sound.</p>
<p>The Closed Caption function is set in the text mode. To remove it, access Closed Caption from the menu screen and change the Mode setting from text to either CC1 or off.</p>	<p>Black square appears in the center of my television screen?</p>
<p>That would indicate that the MTS mode on your unit is set to "SAP" mode. We suggest setting the MTS mode to either "Stereo" or "Mono". For further instruction, please see "MTS" in your user manual.</p> <ul style="list-style-type: none"> <li>● SAP is Second Audio Program. It's a second audio channel that is usually used for a second language or descriptive audio for the visually impaired.</li> <li>● MTS stands for Multichannel Television Sound, a standard that allows the encoding of 3 channels of audio within a standard NTSC (analog) video signal to a television. A television that is able to receive MTS Stereo allows you to watch television with stereo sound.</li> </ul>	<p>On some channels getting another language or sometimes no sound at all.</p>
<p>Check the cable connection for an incoming signal. The best way to confirm signal is to use another TV and/or contact your cable company.</p>	<p>Not getting all of my cable channels on the television or I'm only getting 13 channels.</p>
<p>After switching to Cable, please auto program the channels. The TV will "remember" all the channels then the TV will allow you to surf the channels with [CHA / V] buttons.</p>	<p>[CHA / V] don't work when I set the Channel to Cable? They work with the Air setting?</p>

<b>POSSIBLE SOLUTIONS</b>	<b>SYMPTOMS</b>
<ul style="list-style-type: none"> <li>● Confirm that TV still has power and is operational.</li> <li>● Change the batteries in the remote control.</li> <li>● Check if the batteries are correctly installed.</li> <li>● Confirm the remote control is matched with the TV (see "Match the Remote Control with TV").</li> <li>● If using a universal remote, be sure to select the TV mode on the remote.</li> <li>● If the remote still does not work:             <ul style="list-style-type: none"> <li>-remove and reinstall all the batteries correctly to reset the remote or install new batteries.</li> <li>-press TV and then Power to turn on the TV. With a universal remote if you have reset or changed the batteries you will need to reprogram the remote for the other units.</li> </ul> </li> </ul> <p><b>MATCH:</b> Turn on your TV using the Tap Pad located on the TV (see "Viewing the Control Panel). Aim your remote control within 6 inches of the lower left corner of your TV. Press the [-] and [LAST] buttons on the remote control simultaneously for at least 3 seconds. The LED at the top of your remote will light for one second and blink slowly three times to indicate the remote has paired with the TV.</p>	<p>Remote control does not work.</p>
<ul style="list-style-type: none"> <li>● Check network physical connection, make sure connection is correct.</li> <li>● Enter "Menu", "Settings", "Network", "Configuration", "Connection Test" to make sure that network connection test is successful.</li> <li>● Enter "Menu", "Settings", "Network", "Configuration", "Connection Test" to make sure that network connection test is successful.</li> </ul>	<p>Network connection fail.</p>
<ul style="list-style-type: none"> <li>● Check network connection is correct, both physically and configuration.</li> <li>● Enter "Menu", "Settings", "Network", "Configuration", "Connection Test" to make sure that network connection test is successful.</li> <li>● <b>For VUDU:</b> Enter "Menu", "Settings", "Network", "Configuration", "Applications", "VUDU", "Deactivation" to reset VUDU account.</li> <li>● <b>For Netflix:</b> Enter "Menu", "Settings", "Network", "Configuration", "Applications", "Netflix", "Deactivation" to reset Netflix account.</li> </ul>	<p>Connect VUDU/Netflix fail.</p>
<ul style="list-style-type: none"> <li>● <b>For VUDU:</b> <ol style="list-style-type: none"> <li>1. Press [EXIT] button on remote to exit VUDU.</li> <li>2. Enter "Menu", "Settings", "Network", "Configuration", "Applications", "VUDU", "Deactivation" to reset VUDU account.</li> </ol> </li> <li>● <b>For Netflix:</b> <ol style="list-style-type: none"> <li>1. Press [EXIT] button on remote to exit VUDU.</li> <li>2. Enter "Menu", "Settings", "Network", "Configuration", "Applications", "Netflix", "Deactivation" to reset Netflix account.</li> </ol> </li> </ul>	<p>Log out VUDU/Netflix or change log in account.</p>
<ul style="list-style-type: none"> <li>● Check network connection is correct, both physically and configuration.</li> <li>● Make sure DLNA server (PC or Mac) has shared media content and TV has permission to access shared media.</li> <li>● Enter "Menu", "Settings", "Network", "Applications", "turn on "DLNA".</li> <li>● Select Hi-DMP source to find shared contents. Select "Hi-DMP" source by using [INPUT] button on remote or press [Hi-Smart] button and then select "Multi-Media" icon.</li> </ul>	<p>DLNA does not work.</p>
<ul style="list-style-type: none"> <li>● You need a broadband (high speed) Internet service with a speed of no less than 1.5 Mbps.</li> <li>● Connect the TV to the Internet through your router by an ethernet cable or wireless connection. If the connection fails, check with your internet service provider or router manufacturer to determine if there is a firewall, content filter, or proxy settings that may block the TV from accessing the Internet.</li> <li>● After connecting the TV to the Internet, press the [Hi-Smart] button on the remote to access the Hi-Smart Hub.</li> </ul> <p><b>Caution:</b> Do not try to repair the TV yourself. Refer all servicing to qualified repair personnel.</p>	<p>How do I get the Hi-Smart Hub to work on my TV?</p>

- The remote control requires:
- Number of Batteries: 2
  - Type: AAA
  - Voltage: 1,5 Vcc

Model Name		50K610GW		55K610GW	
Dimension	Without Stand	Width: 4.3 inches (1126 mm) Height: 26.0 inches (661 mm) Depth: 2.4 inches (59.8 mm)	Width: 49.1 inches (1248 mm) Height: 29.3 inches (743 mm) Depth: 2.3 inches (59 mm)	Without Stand	Width: 44.3 inches (1126 mm) Height: 28.5 inches (724.5 mm) Depth: 11.2 inches (285 mm)
	With Stand	Width: 44.3 inches (1126 mm) Height: 28.5 inches (724.5 mm) Depth: 11.2 inches (285 mm)	Width: 49.1 inches (1248 mm) Height: 31.6 inches (803 mm) Depth: 13.0 inches (330 mm)	With Stand	Width: 44.1 lbs (20 kg) Height: 28.7 lbs (58.6 kg) Depth: 49.8 lbs (22.6 kg)
Weight	Without Stand	37.5 lbs (17 kg)	49.8 lbs (22.6 kg)	With Stand	44.1 lbs (20 kg)
	With Stand	44.1 lbs (20 kg)	28.7 lbs (58.6 kg)	Without Stand	49.8 lbs (22.6 kg)
LCD Panel Minimum size (diagonal)		50 inches		55 inches	
Screen resolution		1920 × 1080		1920 × 1080	
Audio power		8W + 8 W		8W + 8 W	
Power consumption		Please refer to the rating label.		Please refer to the rating label.	
Power supply		120 V ~ 60 Hz		120 V ~ 60 Hz	
Receiving systems	Analog	NTSC		NTSC	
	Digital	ATSC / QAM		ATSC / QAM	
Environmental conditions		Temperature: 41°F ~ 95°F (5°C ~ 35°C) Humidity: 20% ~ 80% RH Atmospheric pressure: 86 kPa ~ 106 kPa		Temperature: 41°F ~ 95°F (5°C ~ 35°C) Humidity: 20% ~ 80% RH Atmospheric pressure: 86 kPa ~ 106 kPa	
Component Input		480 I / 60 Hz, 480 P / 60 Hz, 720 P / 60 Hz, 1080 I / 60 Hz, 1080 P / 60 Hz		480 I / 60 Hz, 480 P / 60 Hz, 720 P / 60 Hz, 1080 I / 60 Hz, 1080 P / 60 Hz	
VGA Input		VGA (640×480 / 60 Hz), SVGA (800×600 / 60 Hz), XGA (1024×768 / 60 Hz)		VGA (640×480 / 60 Hz), SVGA (800×600 / 60 Hz), XGA (1024×768 / 60 Hz)	
HDMI Input		RGB / 60 Hz (640×480, 800×600, 1024×768) YUV / 60 Hz (480 I, 480 P, 720 P, 1080 I, 1080 P)		RGB / 60 Hz (640×480, 800×600, 1024×768) YUV / 60 Hz (480 I, 480 P, 720 P, 1080 I, 1080 P)	

Features, appearance and specifications are subject to change without notice.

 NOTE

## General

## Other Information