

Getting Started

Making connections

NOTES

- Check the jacks for position and type before making any connections. Loose connections can result in image or color problems. Make sure that all connections are tight and secure.
- Not all A/V devices have the ability to connect to a TV, please refer to the user manual of your A/V device for compatibility and connections procedure.
- Always unplug the power cord when connecting external equipment.

Connecting an antenna, cable or cable/satellite box

1. Turn off the TV before connecting the antenna.
2. Connect one end of a coaxial cable (not included) to the RF OUT jack on the antenna, cable or cable/satellite box. If you are using an antenna with twin-lead cable, you may need a 300-75 ohm adapter (not provided) to connect it to the back of your TV. Likewise, if you are using several antennas, you may need a combiner (not provided).
3. Connect the other end of the cable to the ANT/CABLE jack on the side of your TV.

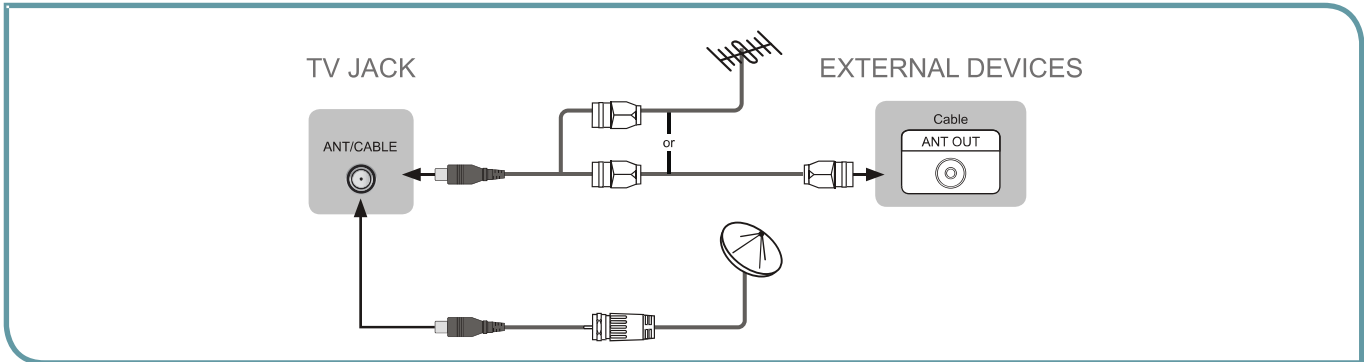

Connecting an A/V Device with Composite Cable

1. Use the audio and video cables to connect the external A/V device's composite video/audio jacks to the TV's jacks. (Video = yellow, Audio Left = white, and Audio Right = red)

NOTE

Connect the yellow video plug to the Green Y-input jack on the TV.

2. Plug the connected devices into the mains socket before switching on the TV.
3. Select the corresponding source from the TV.

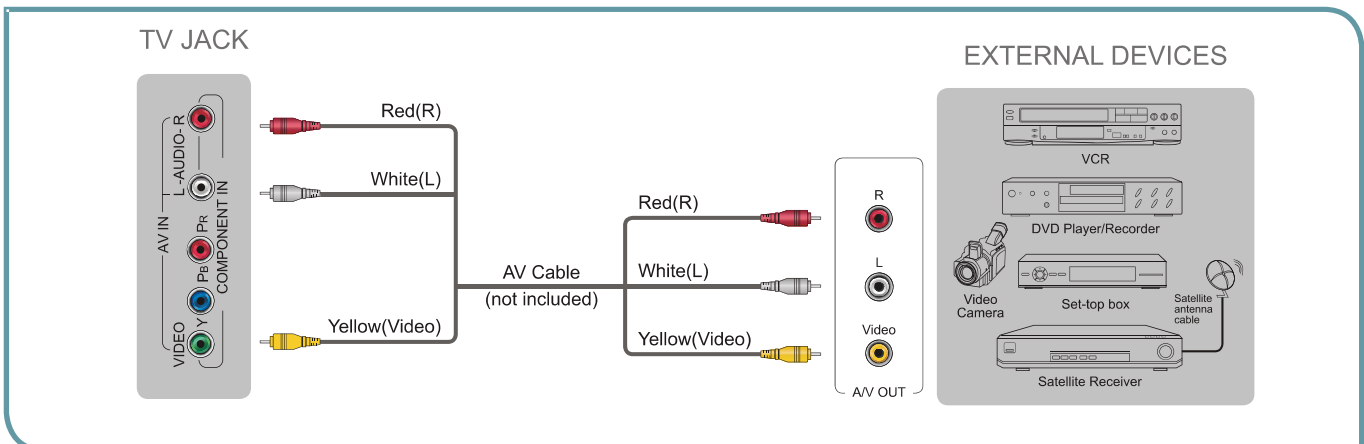

Getting Started

✚ Connecting an A/V Device with Component (YP_BP_R) Cable

1. Use a component cable to connect the external A/V device's component output jacks to the TV's YP_BP_R jacks. Use an audio cable to connect the external A/V device's component audio jacks to the TV's AUDIO (L/R) jacks.
2. Plug the connected devices into the mains socket before switching on the TV.
3. Select the corresponding source from the TV.

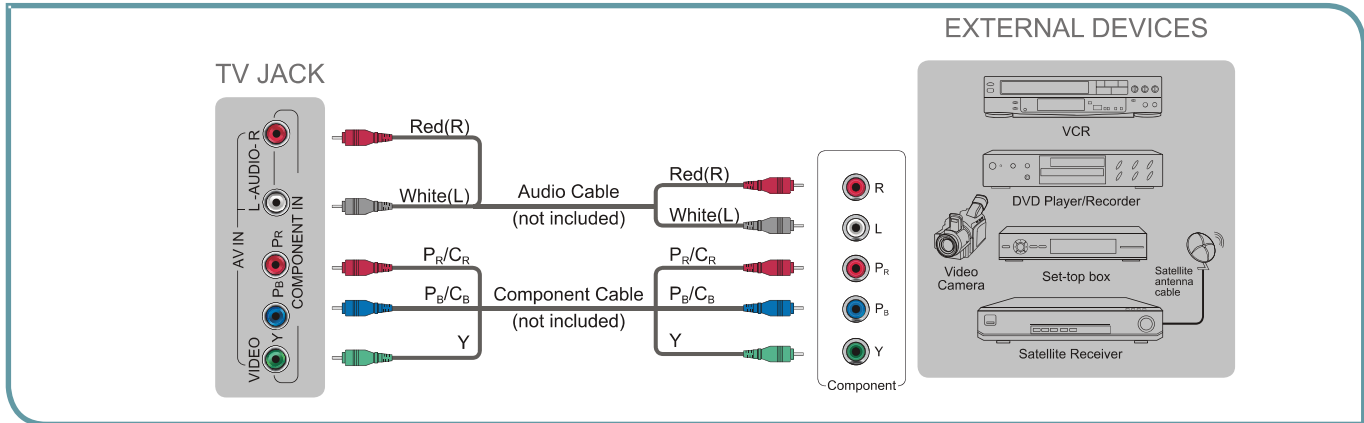

✚ Connecting an A/V Device with HDMI Cable

- Support digital connections between HDMI - enabled A/V devices such as PVR, DVD, Blu-ray, AV receiver and digital devices.
 - Some devices such as PVR or DVD player require HDMI signal to be set to output in the device's settings.
 - Please consult your device user manual for instructions.
1. Use an HDMI cable to connect the A/V device's HDMI output jack to the TV's HDMI jack.
 2. Plug the connected devices into the mains socket before switching on the TV .
 3. Select the corresponding source from the TV.

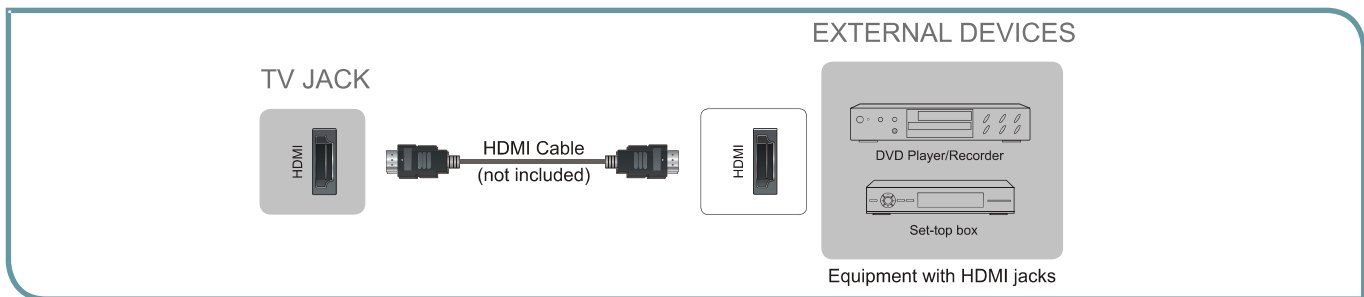

NOTE

The HDMI connector provides both video and audio signals, it's not necessary to connect the audio cable.

✚ Connecting a headphone

Headphones can be connected to the AUDIO OUT/🎧 output on your set. (While the headphone is connected, the sound from the built-in speakers is disabled.)

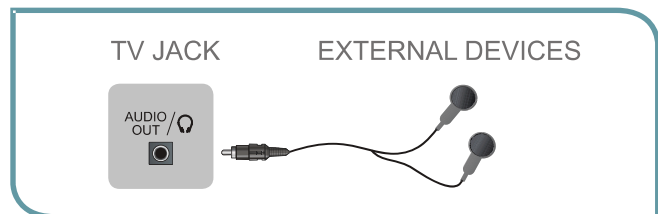

Getting Started

✚ Connecting a PC with VGA Cable

1. Use a VGA cable to connect the PC's VGA output jack to the TV's VGA jack. Use an audio cable to connect the PC's audio output jack to TV's PC/DVI AUDIO IN jack.
2. Plug the connected devices into the mains socket before switching on the TV.
3. Select the corresponding source from the TV.

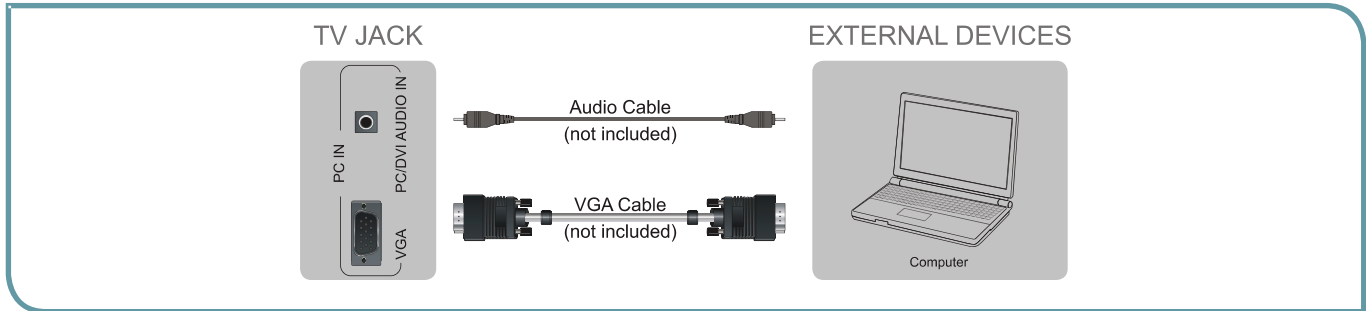

✓ NOTES

- Primarily this unit is intended for use as an LCD TV. If you want to use it as a monitor, please contact the manufacturer of the PC Video/Graphic's card for further support. Perfect compatibility is not guaranteed.
- The VGA cable is not supplied with the product.
- We strongly recommend the use of a VGA cable with two ferrite cores to reduce interference. (as shown in the illustration).

✚ Connecting an Audio Receiver with Audio cable

1. Use an audio Optical cable to connect the A/V device's digital audio in jack to the TV's DIGITAL AUDIO OUT jack. Or use an RCA Y-cable (1/8"-stereo mini to L/R phono - not provided) to connect analog sound system to the TV's AUDIO OUT/🔊 jack.
2. Plug the connected devices into the mains socket before switching on the TV.
3. Select the corresponding source from the TV.

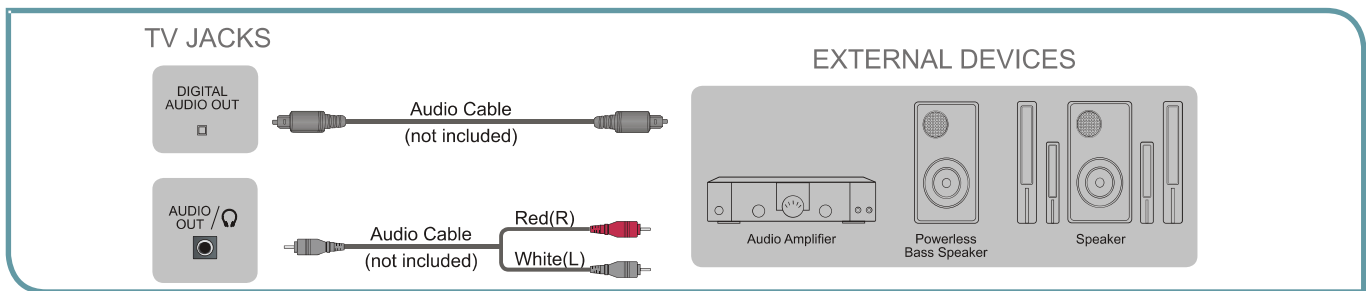

✓ NOTES

- When a digital audio system is connected to the DIGITAL AUDIO OUT jack, decrease the volume of both the TV and the system.
- 5.1 CH (channel) audio is available when the TV is connected to an external device supporting 5.1 CH.
- When the receiver (home theater) is set to on, you can hear sound output from the TV's digital audio out jack. When the TV is receiving a DTV signal, the TV will send 5.1 CH sound to the home theater receiver. When the source is connected to the TV via HDMI, only 2 CH audio will be heard from the home theater receiver. If you want to hear 5.1 CH audio, connect the digital audio out jack from your DVD/Blu-ray player/cable box/STB satellite receiver directly to an amplifier or home theater.

Getting Started

Network Connection

You can set up your TV so that it can access the Internet through your local area network (LAN) with a Ethernet or wireless connection.

✚ Connecting to a Wired Network

You can attach your TV to your LAN by one of the three following ways:

- You can attach your TV to your LAN by connecting the LAN port on the back of your TV to an external modem using a Cat 5 LAN cable. See the diagram below.

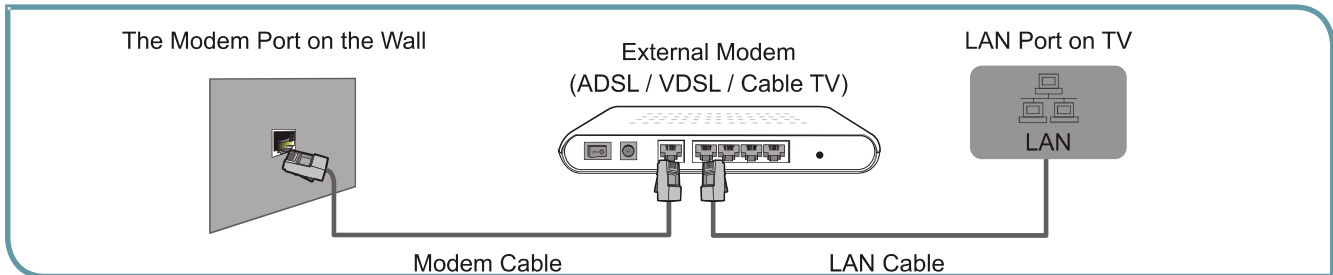

- You can attach your TV to your LAN by connecting the LAN port on the back of your TV to an IP Sharer which is connected to an external modem. Use LAN cable for the connection. See the diagram below.

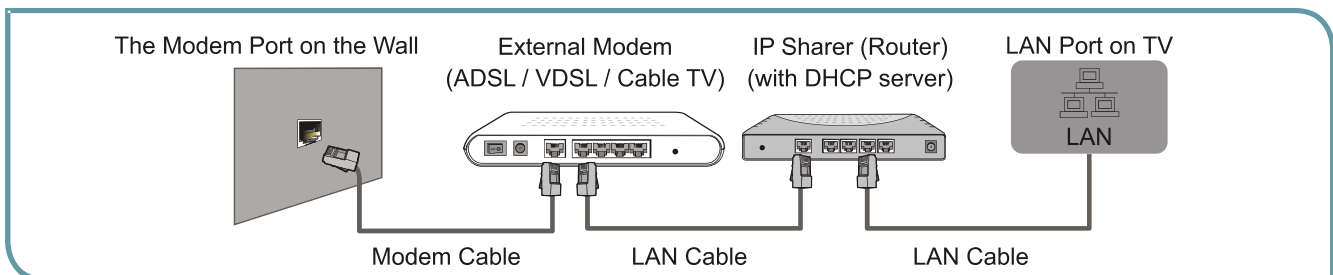

- Depending on how your network is configured, you may be able to attach your TV to your LAN by connecting the LAN port on the back of your TV directly to a network wall outlet with a Cat 5 cable. See the diagram below. Note that the wall outlet is attached to a modem or router elsewhere in your house.

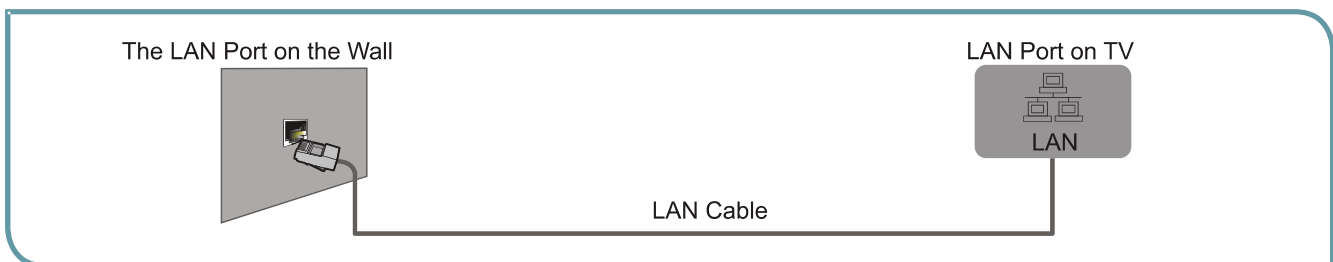

If you have a Dynamic Network, you should use an ADSL modem or router that supports Dynamic Host Configuration Protocol (DHCP). Modems and routers that support DHCP automatically provide the IP address, subnet mask, gateway, and DNS, so you don't have to enter them manually. Most home networks are Dynamic Networks.

Some networks require a Static IP address. If your network requires a Static IP address, you must enter the IP address, subnet mask, gateway, and DNS values manually on your TV's Cable Setup Screen when you set up the network connection. To get the IP address, subnet mask, gateway, and DNS values, contact your Internet Service Provider (ISP).

If you have a Windows computer, you can also get these values through your computer.

✔ NOTE

You can use ADSL modems that support DHCP if your network requires a Static IP address. ADSL modems that support DHCP also let you use Static IP addresses.

Getting Started

✚ Connecting to a Wireless Network

To connect your TV to your network wirelessly, you need a wireless router or modem. See the illustration below.

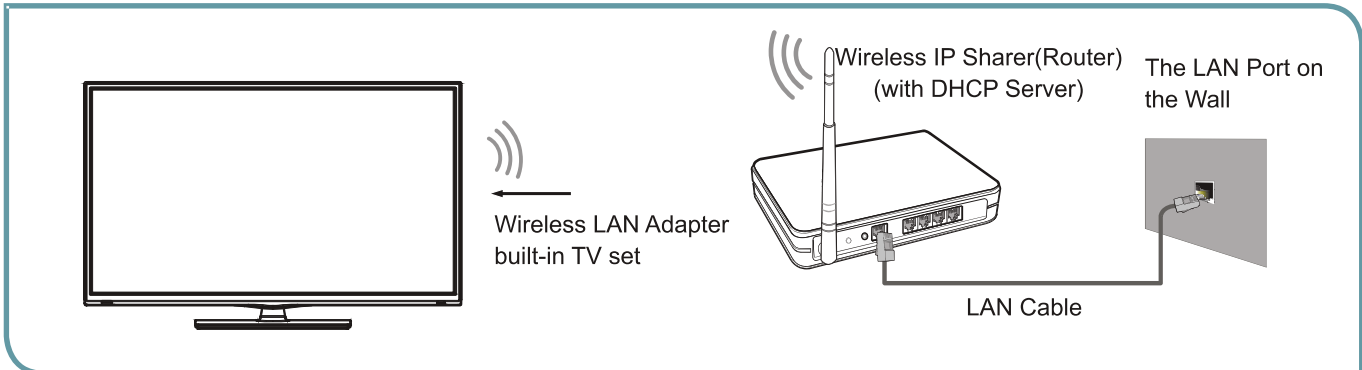

Hisense's built-in Wireless LAN Adapter supports the IEEE 802.11 b/g/n communication protocols. Hisense recommends using IEEE 802.11n router. When you play the video over a IEEE 802.11b/g connection, the video may not play smoothly.

✔ NOTES

- You must use the Hisense's built-in Wireless LAN Adapter to use a wireless network, the set doesn't support external USB network adapter.
- To use a wireless network, your TV must be connected to a wireless IP sharer. If the wireless IP sharer supports DHCP, your TV can use a DHCP or static IP address to connect to the wireless network.
- Select a channel for the wireless IP sharer that is not currently being used. If the channel set for the wireless IP sharer is currently being used by another device nearby, this will result in interference and communication failure.
- If you apply a security system other than the systems listed below, it will not work with the TV.
- If Pure High-throughput (Greenfield) 802.11N mode is selected and the Encryption type is set to WEP, TKIP or TKIP-AES (WPS2 Mixed) for your Access Point (AP), this player will not support a connection in compliance with new Wi-Fi certification specifications.
- If your AP supports WPS (Wi-Fi Protected Setup), you can connect to the network via PBC (Push Button Configuration) or PIN (Personal Identification Number). WPS will automatically configure the SSID and WPA key in either mode.
- Connection Methods: You can setup the wireless network connection three ways.
 - Scan
 - Manual
 - Auto

Turning your TV on or off

To turn your TV on or off (standby mode):

1. Plug the power cord into an AC power outlet.
2. Press [POWER] button. Your TV turns on.
3. Press [POWER] button again to turn off your TV. When you turn off your TV, it goes into standby mode.

⚠ WARNING

When your TV is in standby mode, it is still receiving power. To completely disconnect power, unplug the power cord.

✓ NOTE

If your TV does not receive an input signal for several minutes, it automatically goes into standby mode.

Turning the TV On for the First Time

The Setup Wizard menu appears the first time you turn on the TV. It will assist you to specify the menu language, country setting, Use Mode, Network Setting and Channel Installation.

IMPORTANT: Make sure that the antenna or cable is connected and a wired or wireless Internet connection is available.

1. Make sure that you have:

Installed the remote control batteries.

Connected the power cord.

Connected to an antenna or cable TV signal.

✓ NOTE

The customer will be prompted to connect a Network cable in the Select Network wizard screen.

2. Connect your TV's power cord to a power outlet, then press power. The Initial Setup screen opens.
3. Please press [ENTER] to start the wizard, then press [▲/▼] button to select your language: English, Spanish or French, select [Next] to confirm and move to the Welcome screen.

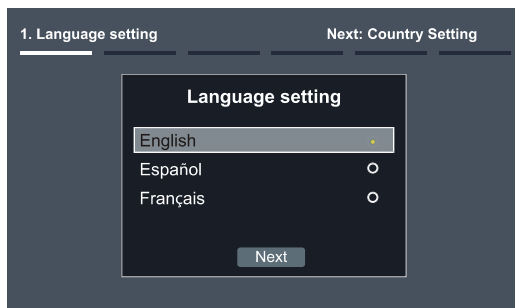

The Welcome screen displays the available input devices and interfaces.



4. Select the country where you will operate the TV.

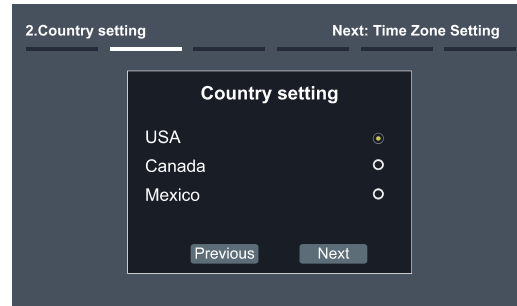

5. Select the local time zone according to your region.

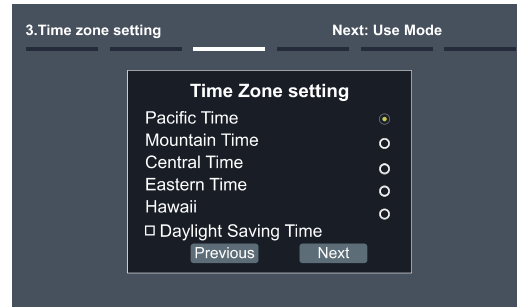

Daylight Saving: Set the Daylight Saving time for your area.

6. **Select Use Mode Setting:** Home Mode or Retail Mode. Home Mode is the recommended setting which offers full functionality of the television.

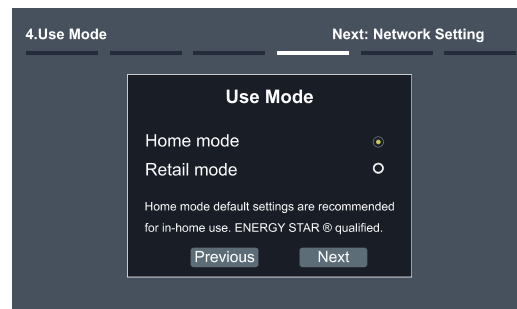

ENERGY STAR® qualified: Only applies for some models . If you select Retail Mode, a message appears "Are you sure to change to retail mode?" Select "OK" to continue, or select "Cancel" to change your selection.

Home Mode is the recommended setting which offers full functionality of the television. If you selected Retail Mode, Energy Savings are not realized.

7. **Select Network** : Connect your TV to access the network.

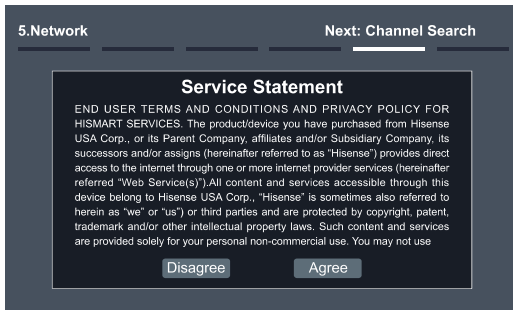

When the Network Setting menu opens, Hisense Service Terms and Conditions will appear. Press [**◀/▶**] to scroll through the pages. Please read it carefully.

If you want to access the internet, press the [**Agree**] button to set your TV's network connections. Otherwise, press the [**Disagree**] button to enter the Channel search menu.



You can select the network configuration in this menu or choose to skip network configuration. For more information or to setup the network configuration later, see “Network Connection” and “Network Setup”.

8. The Channel Search.
- Press [**▲/▼**] to select your Tuner Mode: Antenna or Cable, press [**ENTER**] button to confirm.

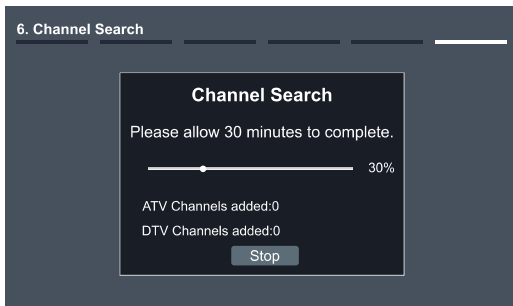

Press [**◀/▶**] to set the Channel Installation: Scan or Skip Scan, press [**ENTER**] button to confirm.

If you select “Scan”, your TV automatically starts Channel Installation available in your viewing area.

If you select “Skip Scan”, your TV does not scan for channels.

Depending on the reception condition, it may take up to 30 minutes or more to complete memorizing channels. Please allow the process to complete without interruption.

After the Channel Search, a summary of the current settings will be displayed. Select “go” to exit the wizard.

Changing Channels / Volume

1. Press the [**CH ▲/▼**] (or [**CH +/-**]) on the TV/remote control to change the channel.
2. Press the [**VOL ▲/▼**] (or [**VOL +/-**]) on the TV/remote control to adjust the volume.
3. Press the numeric buttons on the remote control to display the corresponding channels.

NOTE

Changing the channels can also be achieved by directly entering the channel number using the numeric keys on the remote control. If you are entering a two or three digit channel number, the time between key presses should be less than 3 seconds.

Selecting the Input Source

The first time you turn on your TV, you must select the TV signal source. Your TV stores this information, so you do not need to change the TV signal source unless it changes. For example, you change from an outside antenna to cable TV.

To select the video input source:

1. Turn on your TV, then press [**INPUT**] button on the remote or on the TV. The Input Source menu opens.
2. Press [**▲/▼**] button to highlight the input source, then press [**ENTER**] button.

Shortcuts Instructions

Aspect - Select the screen aspect ratio from Normal, Wide, Zoom, Cinema, 1:1 Pixel Map, and Auto.

Normal: The original 4:3 aspect ratio (1.33:1 signal) is preserved, so black bars are added to the left and right of the image. Standard TV broadcasts are displayed with a 4:3 aspect ratio.

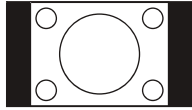

Wide: When watching a standard broadcast or full-frame movie in this mode, the display image is stretched proportionately to fill the TV screen. When watching a widescreen (1.78:1 signal) program or movie, the display image fills the TV screen.

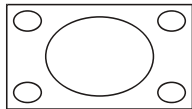

Auto: Automatically adjusts the image based on the screen size and the TV program.

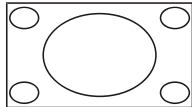

Zoom: Stretch the 4:3 aspect ratio image vertically and horizontally to fill the screen at 1:1.78 aspect ratio.

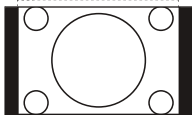

Cinema: Stretch the 4:3 aspect ratio image vertically and horizontally to fill the screen at 1:2.35 aspect ratio.

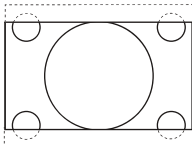

1:1 Pixel Map: Displays the native signal format pixel-by-pixel without any video processing or scaling. In this mode, 1920 x 1080 resolution sources fill the screen while all other resolutions are centered and surrounded by black bars.

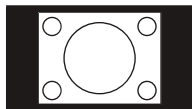

Picture - Press this button to set the picture mode. It can be set as Vivid, Standard, Energy Savings, Game, Theater or Custom. This mode achieves a certain image display effect by setting the brightness, contrast and Speech.

Sound - Press this button to set the sound mode. It can be set as Standard, Speech, Music and Custom.

Mute - Press this button to turn the sound off, press this button again to turn the sound back on. This function is used to switch off sound temporarily.

Sleep - It can set the TV to let it enter into the Standby state automatically. Press this button repeatedly to select the proper sleeping clock mode, and the clock tells you the remaining time before the TV enters Standby state.

Display - Press this button to display the information including channel number, channel name, current system time, tuner mode, audio stream, video format, audio language, closed caption mode, parental lock rating, program details, etc.

CCD - Press the [CCD] button to the Closed Caption mode: CC Off, CC On or CC On When Mute.

MTS - Press the [MTS] button to select the default audio stream: Mono, Stereo or SAP.

Basic Features

To Use the Menu

- 1 Press the [MENU] button to open the main menu.
- 2 Press [▲/▼] to select a menu option, then press [▶/ENTER] button to enter the menu.
- 3 In each menu, you can:
 - Press [▲/▼] to select an item,
 - Press [◀/▶] to adjust the value, or
 - Press [▶/ENTER] to enter the submenu,
 - Press [MENU] to back the previous menu.
- 4 Press [EXIT] to exit the menu.

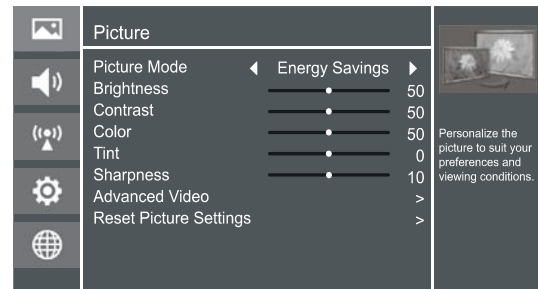

NOTE

The menus in the user manual may vary slightly from the actual screen.

Using the Picture Menu

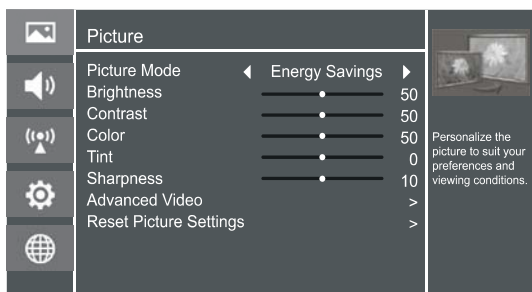

You can adjust:

Picture Mode - Adjust the Picture Mode. You can select Vivid, Standard, Energy Savings, Theater, Custom or Game mode.

NOTE

The option of the Picture Mode is different in different inputs. (For more information, see “Shortcuts Instructions”)

Brightness - Increase or decrease the brightness of the picture. Increasing the brightness can add more light to dark areas of the picture, while decreasing the brightness can add more darkness to light areas of the picture.

Contrast - Increase or decrease the contrast of the picture. Increase the contrast to adjust the white areas of the picture or decrease the contrast to adjust the black areas of the picture.

Color - Adjust the level of color in the picture.

Tint - Adjust the hue of the picture.

Sharpness - You can increase the sharpness level for clearer images or decrease the sharpness level for smoother images.

Advanced Video - Access advanced video settings such as Color Temperature, Noise Reduction, Dynamic Backlight Control (DCR) and Adaptive Contrast.

Color Temperature: Change the color temperature. You can select a preset color temperature: Cool, Normal and Warm (when set to cool, whites are bluer; when set to warm, whites are yellower)

UltraSMR or True 120Hz Refresh Rate: Inserts frames to reduce judder in fast action scenes. You can select High, Low or Off. (May not be accessible, depend on your TV series and size.)

Noise Reduction: Optimize the picture quality by filtering signal interference. You can select Off, Low, Auto, Medium or High.

Dynamic Backlight Control (DCR): Enhances the contrast ratio between light and dark areas of the picture. You can select Off, Low or High.

Backlight: Adjust the backlight level to select the optimum levels of illumination.(May not be accessible, depend on you TV series and size.)

Adaptive Contrast: Automatically adjusts the contrast level of the selected input source.

Aspect Ratio: To choose the screen aspect ration from Normal, Wide, Zoom, Cinema , Auto and 1:1 Pixel Map.

NOTE

The option of the screen Aspect Ration is different in different inputs.

Overscan: In DTV mode, Select ON to extend the image beyond the display so the picture edges are not visible.

NOTE

Only available in DTV, HDMI (Except Game mode) and Component source.

Reset Picture Settings - Resets all Picture settings to the factory defaults.

Using the Audio Menu

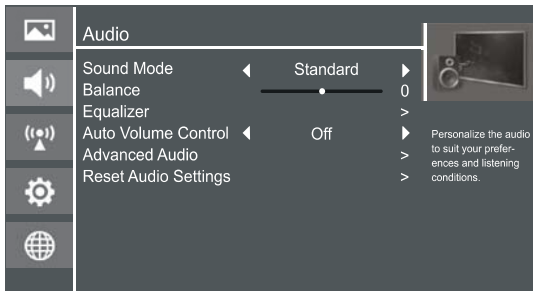

You can adjust:

Sound Mode - Select the Sound Mode: Standard, Speech, Custom or Music .

Balance - Adjust the volume of the left and right speakers.

Equalizer - Soften or enhance the sound at specific frequency points.

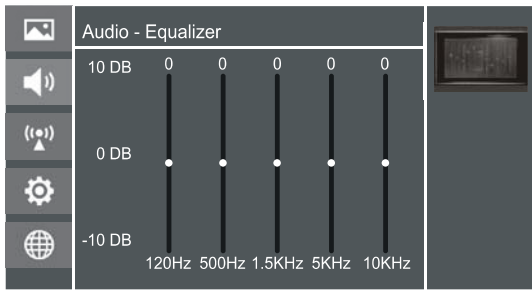

Auto Volume Control - Automatically adjusts volume to a consistent level; attenuates loud passages.

Advanced Audio - Access Advanced Audio settings such as Digital Audio Output, MTS/SAP, Audio Language, TV Speaker.

Digital Audio Output: Send digital audio to an external audio system. You can select PCM, RAW or Off.

- **PCM:** PCM outputs two channel audio regardless of the input format.
- **RAW:** When the data stream carries Dolby signal, digital SPDIF outputs Dolby data stream. When the data stream carries no Dolby signal, it transports PCM data stream.

MTS/SAP: Select the default audio stream, you can select Mono, Stereo or SAP (Second Audio Program).

- **MONO:** Select this option if there is noise or static on weak stereo broadcasts.
- **STEREO:** Select this option for programs broadcast in stereo.
- **SAP:** Depending on the particular program being broadcast, you can listen to a foreign-language translation.

Audio Language - Change the default value for audio language. (Digital channels only)

TV Speaker - Selects where to play TV audio. You can select On (default setting) to play audio through TV speakers, or select Off to play audio through the speakers on an external audio system.

Reset Audio Settings - Resets all Audio Settings to the factory defaults.