

Hisense[®]

LED TV

USER'S MANUAL

Before using the TV, Please read this manual thoroughly, retain it for future reference.

H19K15E
F24K15E
F26K15E
H32K15E

English

Table of contents

Important to user	2
Important safety instructions	3
Setting up	5
Pedestal installation instruction	5
Locating TV buttons and connectors	6
Connection to other devices	10
Using the remote control	12
Identifying the remote control buttons	12
Brief operations of the remote control	13
Basic operation	13
Power on/off	13
Changing channels/volume	13
Select input source	13
Change picture mode	13
Change sound mode	14
Mute sound	14
Set sleep timer	14
Change view ratio	14
GUIDE	14
Changing the TV settings	15
Using the TV Menu	15
Using the Video Menu	16
Using the Audio Menu	17
Using the Setup Menu	18
Using the Parental Menu	20
Appendix	22
Specification	22
Trouble shooting	23
Accessories	23

Important to user

➤ FCC Statement

NOTE:

The manufacturer is not responsible for any radio or TV interference caused by unauthorized modifications to this equipment. Such modifications could void the user's authority.



NOTE:

This equipment has been tested and found to comply with the limits for a class B digital Device, pursuant to part 15 of the FCC Rules. These limits are designed to provide reasonable protection against harmful interference in a residential installation. This equipment generates, uses and can radiate radio frequency energy and, if not installed and used in accordance with the instructions, may cause harmful interference to radio Communications. However, there is no guarantee that interference will not occur in a particular installation. If this equipment does cause harmful interference to radio or television reception, which can be determined by turning the equipment off and on, the user is encouraged to try to correct the interference by one or more of the following measures:

1. Reorient or relocate the receiving antenna.
2. Increase the separation between the equipment and the receiver.
3. Connect the equipment into an outlet on a circuit different from that to which the receiver is connected.
4. Consult the dealer or an experienced radio/TV technician for help.

Important safety instructions

➤ Important safety instructions

	CAUTION RISK OF ELECTRIC SHOCK DO NOT OPEN	
CAUTION: TO REDUCE THE RISK OF ELECTRIC SHOCK, DO NOT REMOVE COVER(OR BACK).NO USER-SERVICEABLE PARTS INSIDE. REFER SERVICING TO QUALIFIED SERVICE PERSONNEL.		



The lightning flash with arrowhead symbol, within an equilateral triangle is intended to alert the user to the presence of uninsulated dangerous voltage within the product's enclosure that may be of sufficient magnitude to constitute a risk of electric shock.



The exclamation point within an equilateral triangle is intended to alert the user to the presence of important operating and maintenance (servicing) instructions in the literature accompanying the set.

CAUTION: CHANGES OR MODIFICATIONS NOT EXPRESSLY APPROVED BY THE PARTY RESPONSIBLE FOR COMPLIANCE WITH THE FCC RULES COULD VOID THE USERS AUTHORITY TO OPERATE THIS EQUIPMENT.

WARNING: TO PREVENT FIRE OR SHOCK HAZARD, DO NOT EXPOSE THIS APPLIANCE TO RAIN OR MOISTURE.

1. READ THESE INSTRUCTIONS
2. KEEP THESE INSTRUCTIONS
3. HEED ALL WARNINGS
4. FOLLOW ALL INSTRUCTIONS
5. DO NOT USE THIS APPARATUS NEAR WATER
6. CLEAN ONLY WITH DRY CLOTH
7. DO NOT BLOCK ANY VENTILATION OPENINGS
8. DO NOT INSTALL NEAR ANY HEAT SOURCES
9. DO NOT DEFEAT THE SAFETY PURPOSE OF THE POLARIZED OR GROUNDING-TYPE PLUG
10. PROTECT THE POWER CORD FROM BEING WALKED ON OR PINCHED PARTICULARLY AT PLUGS, CONVENIENCE RECEPTACLES, AND THE POINT WHERE THEY EXIT FROM THE APPARATUS.
11. ONLY USE ATTACHMENTS/ACCESSORIES SPECIFIED BY THE MANUFACTURE.
12. USE ONLY WITH CART, STAND, TRIPOD, BRACKET, OR TABLE SPECIFIED BY THE MANUFACTURER, OR SOLD WITH THE APPARATUS. WHEN A CART IS USED, USE CAUTION WHEN MOVING THE CART/APPARATUS COMBINATION TO AVOID INJURY FROM TIP-OVER.



S3126A

Important safety instructions

➤ Important safety instructions

13. UNPLUG THIS APPARATUS DURING LIGHTNING STORMS OR WHEN UNUSED FOR LONG PERIODS OF TIME.
14. REFER ALL SERVICING TO QUALIFIED SERVICE PERSONNEL. SERVICING IS REQUIRED WHEN THE APPARATUS HAS BEEN DAMAGED IN ANY WAY, SUCH AS POWER-SUPPLY CORD OR PLUG IS DAMAGED, LIQUID HAS BEEN SPILLED OR OBJECTS HAVE FALLEN INTO THE APPARATUS, THE APPARATUS HAS BEEN EXPOSED TO RAIN OR MOISTURE, DOES NOT OPERATE NORMALLY, OR HAS BEEN DROPPED.
15. POWER SOURCE: This TV should be operated only from the type of power source indicated on the marking label. If you are not sure of the type of power supply to your home, consult your appliance dealer or local power company. For TVs intended to operate from battery power, or other sources, refer to the operating instructions.
16. POWER CORD PROTECTION: Power-supply cords should be routed so that they are not likely to be walked on or pinched by items placed upon or against them, paying particular attention to cords at plugs, convenience receptacles, and the point where they exit from the appliance.

17. OUTDOOR ANTENNA GROUNDING

If an outside antenna or cable system is connected to the TV, be sure the antenna or cable system is grounded to provide some protection against voltage surges and built-up static charges. Section 810 of the National Electrical Code, ANSI/NFPA NO.70, provides information with respect to proper grounding of the mast and supporting structure, grounding of the lead-in wire to an antenna discharge unit, size of grounding conductors, location of antenna discharge unit, connection to grounding electrodes, and requirements for the grounding electrode. (Fig.A)

18. LIGHTNING: For added protection for this TV receiver during a lightning storm, or when it is left unattended and unused for long periods of time, unplug it from the wall outlet and disconnect the antenna or cable system.

This will prevent damage to the TV due to lightning and power line surges.

19. POWER LINES: An outside antenna system should not be located in the vicinity of overhead power lines, or other electric light or power circuits, or where it can fall into such power lines or circuits. When installing an outside antenna system, extreme care should be taken to keep from touching such power lines or circuits as contact with them might be fatal.
20. OVERLOADING: Do not overload wall outlets and extension cords as this can result in a risk of fire or electric shock.
21. OBJECT AND LIQUID ENTRY: Never push objects of any kind into this TV through openings as they may touch dangerous voltage points or short out parts that could result in fire or electric shock. Never spill liquid of any kind into the TV.
22. SERVICING: Do not attempt to service this TV yourself as opening or removing covers may expose you to dangerous voltage or other hazards. Refer all servicing to qualified service personnel.
23. REPLACEMENT PARTS: When replacement parts are required, be sure the service technician uses replacement parts specified by the manufacturer that have the same characteristics as the original part. Unauthorized substitutions may result in fire, electric shock, injury to persons or other hazards.
24. SAFETY CHECK: Upon completion of any service or repairs to this TV, ask the service technician to perform routine safety checks to determine that the TV is in proper operating condition.
25. The apparatus shall not be exposed to dripping or splashing and no objects filled with liquids such as vase, shall be placed on the apparatus.
26. WARNING: Plug the power cord into a power outlet where access to the power cord connector is readily accessible in case power dis-connection is required.
27. ATTENTION: This device complies with Part 15 of the FCC Rules. Operation is subject to the following two conditions: (1) this device may not cause harmful interference, and (2) this device must accept any interference received, including interference that may cause undesired operation.
28. CAUTION: To reduce the risk of electric shock, grounding of center pin of this plug must be maintained.
29. WARNING: Plug the power cord into a power outlet where access to the power cord connector is readily accessible, in case if the power needs to be immediately disconnected.
30. ATTENTION: This device complies with Part 15 of the FCC Rules. Operation is subject to the following two conditions: (1) this device may not cause harmful interference, and (2) this device must accept any interference received, including interference that may cause undesired operation.
 - a). Disposal of packaging: The packaging of this product is intended to be recycled. Apply to the local authorities for correct disposal.
 - b). Disposal of batteries: The batteries supplied do not contain the heavy metals mercury and cadmium. Please check on how to dispose exhausted batteries according to local regulations.
 - c). Note Specifications and information are subject to change without notice. If you need further assistance, please call the customer support service in your country.
31. POWER-CORD INSERT CHECK: When connecting the power cord to the connector of the TV, make sure the power cord is fully inserted in the place. Bad contact may cause high temperature of the connector and the risk of fire or other damages.

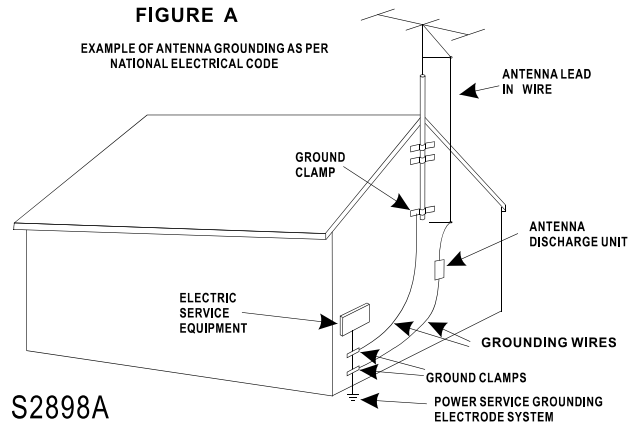

Setting up

➤ Pedestal Installation Instruction (H19K15E)

1. Attach the neck to the stand faceplate. Use the screw to fix them tightly.
2. Place the TV faced down on a soft cloth or cushion on a table.
3. Attach the stand to the TV set as shown in the picture.
4. Use the screws to fix the stand tightly.

STEP 1

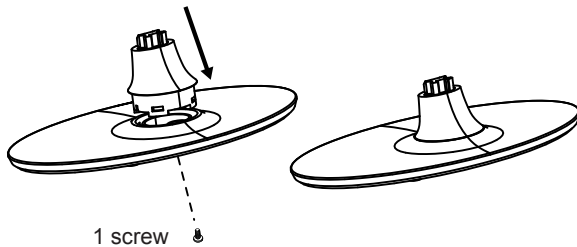

STEP 2

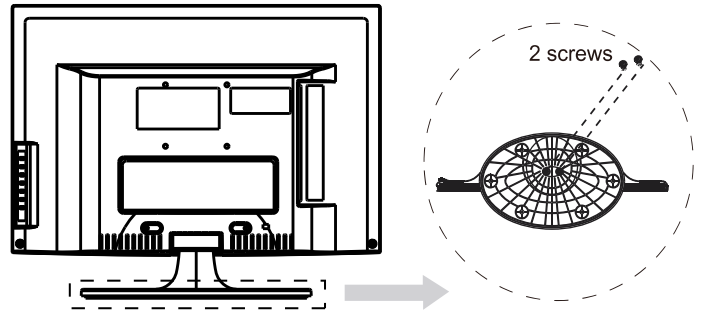

Note:

The stand includes four parts, such as neck, faceplate, spacers and screws .
Screws are used for connecting neck with faceplate and attaching the stand to the TV.

➤ Pedestal Installation Instruction (F24K15E / F26K15E / H32K15E)

1. Lay the soft froth on the table which can hold enough weight of the whole TV in case of causing damage to TV or person.
2. Put the TV on the froth ,with its back upwards and the LCD downwards.
3. Take out the pedestal, and insert the pedestal into the TV suitably, then put the pedestal to relevant position of the TV set until all the holes match each other completely.
4. Fasten the pedestal and the TV set together with screws.
5. Erect the TV set, and put it on the proper position for watching.

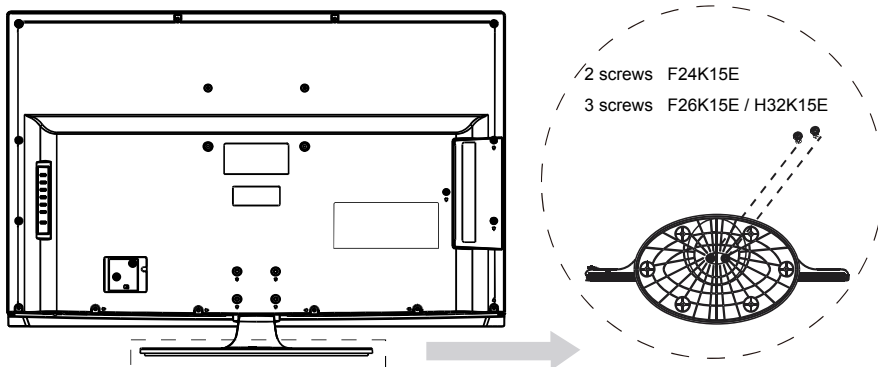

Note:

The above figures are for reference only, please refer to the actual units to determine the appearances.
Every hole of the pedestal must be fastened with screws!

Setting up

➤ Locating TV buttons and connectors

Note: The below figures are for reference only, please refer to the actual units to determine the appearance.

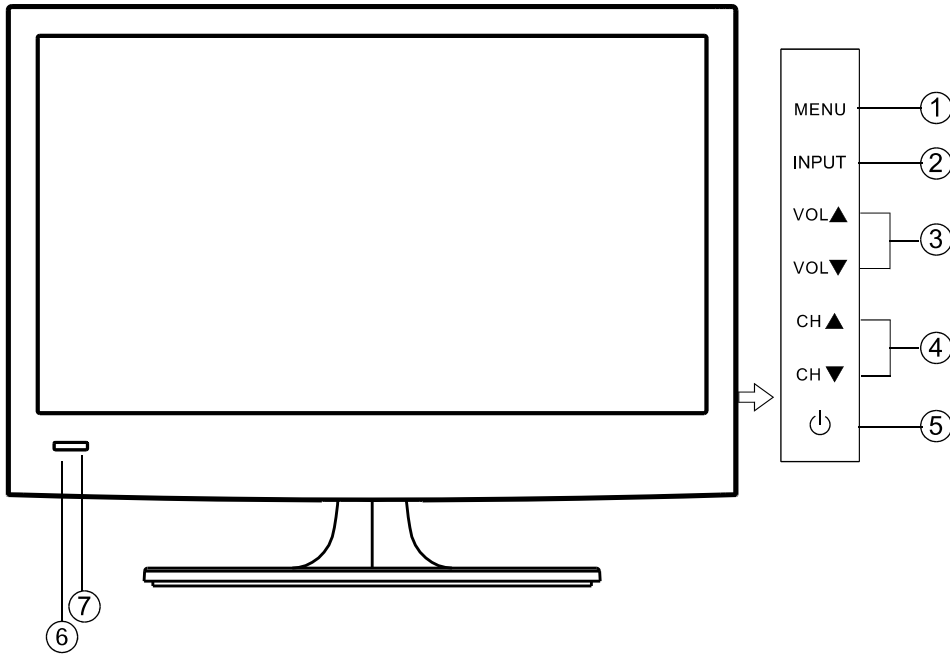

NO.	TV	Description
1	MENU	Display the onscreen display(OSD) or Exit to close the OSD.
2	INPUT	Select the input source. Press INPUT to open the list of input sources.
3	VOL▲/VOL▼	Raise or lower the sound level. In an OSD menu, press these buttons to move right or left in the menu or to adjust an item.
4	CH▲/CH▼	Select the next higher or lower channel. In an OSD menu, press these buttons to move up or down in the menu.
5	⏻ (Standby)	Press to turn your TV on or off (standby mode).
6	Remote control sensor	Receives signals from the remote control. Please do not block.
7	Power indicator	The light shows whether the TV is on or standby mode.

Setting up

➤ Locating TV buttons and connectors (H19K15E)

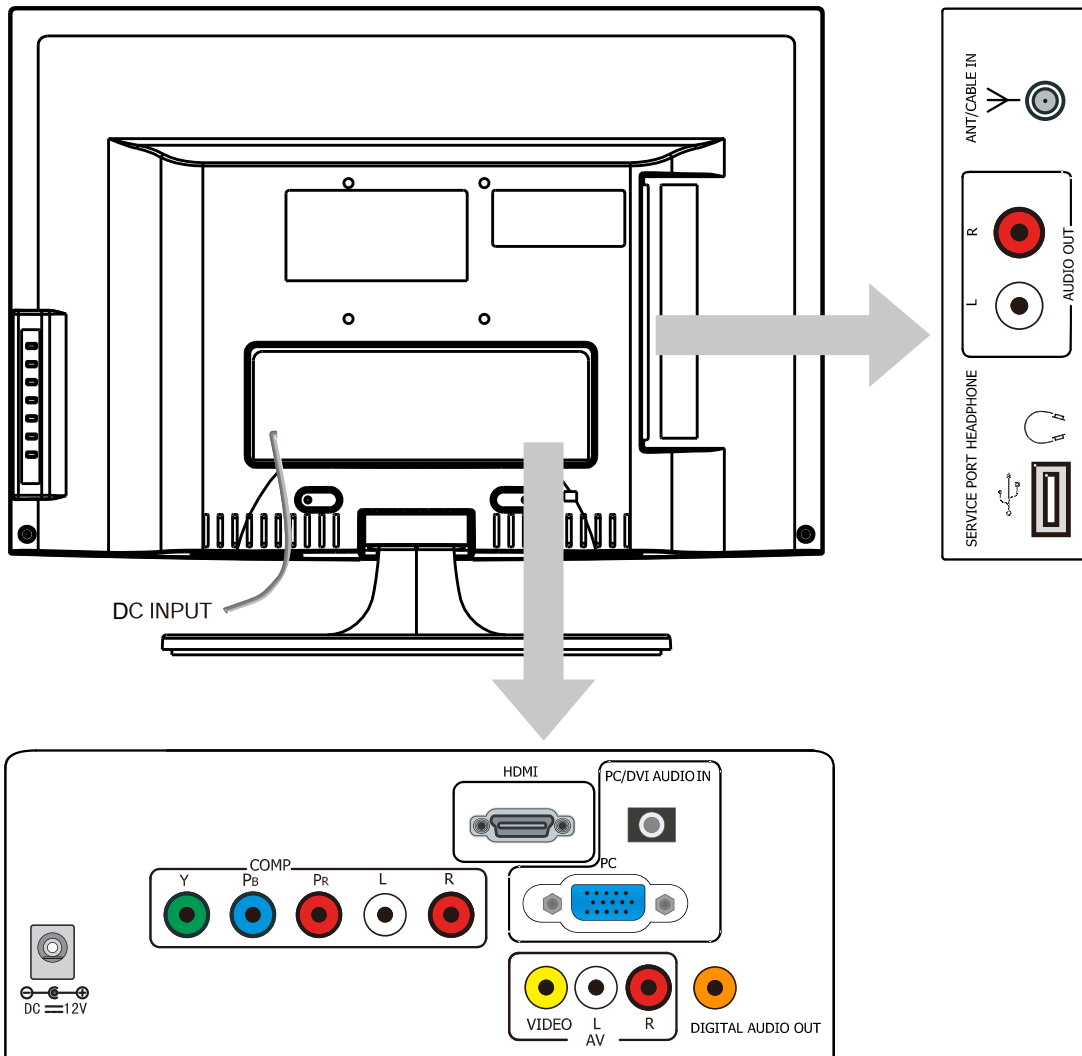

Setting up

➤ Locating TV buttons and connectors (F24K15E)

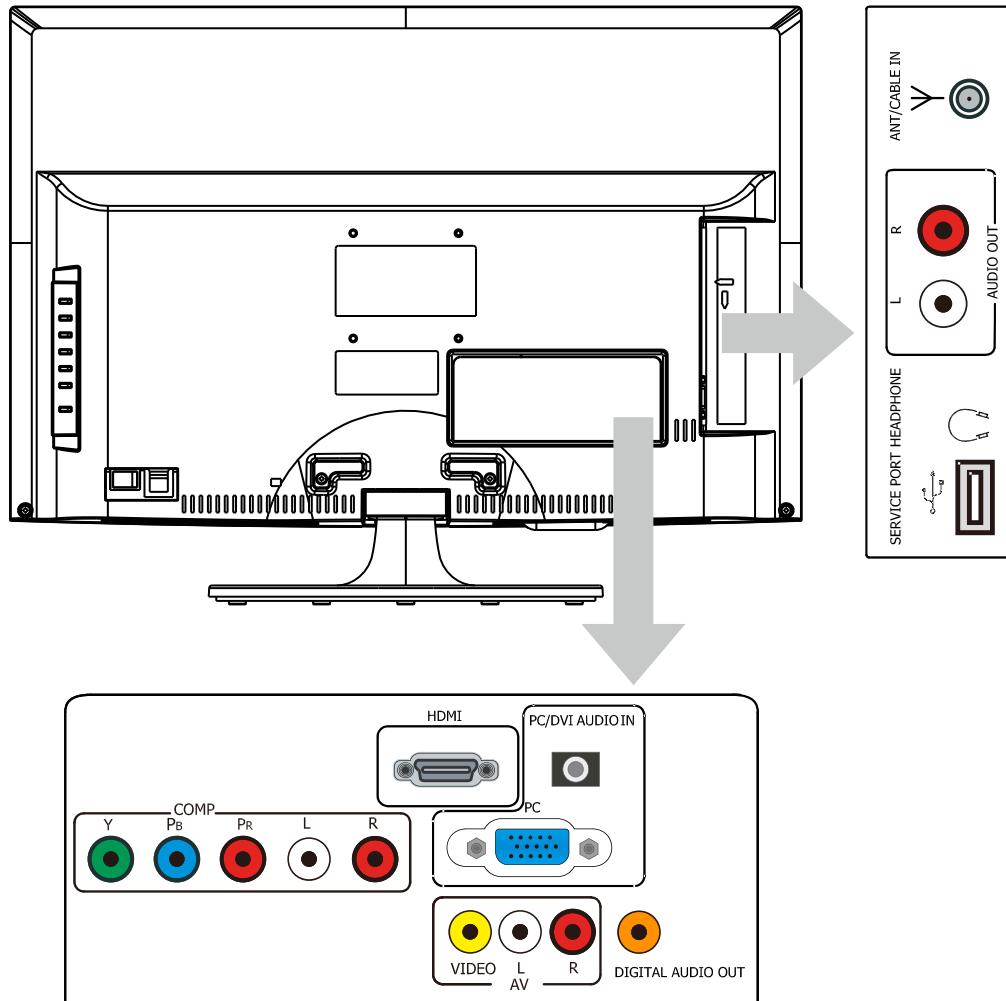

Setting up

➤ Locating TV buttons and connectors (F26K15E / H32K15E)

