

HITACHI

Inspire the Next

PLASMA TELEVISION

Operating Guide for 42HDT79, 55HDT79 42HDX99 and 55HDX99

IMPORTANT SAFETY INSTRUCTIONS.....	2-3
FIRST TIME USE	4-24
THE REMOTE CONTROL.....	25-44
ON-SCREEN DISPLAY	45-80
USEFUL INFORMATION.....	81-88
END USER LICENSE AGREEMENT FOR HITACHI DTV SOFTWARE.....	89-97
APPENDIXES.....	98-99
INDEX.....	100



As an Energy Star® Partner, Hitachi, Ltd. has determined that this product meets the Energy Star® guidelines for energy efficiency.



ULTRAVISION
Director's Series

Important Safety Instructions



SAFETY POINTS YOU SHOULD KNOW ABOUT YOUR HITACHI PLASMA TELEVISION

Our reputation has been built on the quality, performance, and ease of service of **HITACHI** plasma televisions.

Safety is also foremost in our minds in the design of these units. To help you operate these products properly, this section illustrates safety tips which will be of benefit to you. Please read it carefully and apply the knowledge you obtain from it to the proper operation of your **HITACHI** plasma television.

Please fill out your warranty card and mail it to **HITACHI**. This will enable **HITACHI** to notify you promptly in the improbable event that a safety problem should be discovered in your product model.

Follow all warnings and instructions marked on this plasma television.



The lightning flash with arrowhead symbol, within an equilateral triangle, is intended to alert the user to the presence of uninsulated "dangerous voltage" within the product's enclosure that may be of a sufficient magnitude to constitute a risk of electric shock to a person.



The exclamation point within an equilateral triangle, is intended to alert the user to the presence of important operating and maintenance (servicing) instructions in the literature accompanying the appliance.

READ BEFORE OPERATING EQUIPMENT

Follow all warnings and instructions marked on this plasma television.

1. Read these instructions.
2. Keep these instructions.
3. Heed all warnings.
4. Follow all instructions.
5. Do not use this apparatus near water.
6. Clean only with a dry cloth.
7. Do not block any ventilation openings. Install in accordance with the manufacturer's instructions.
8. Do not install near any heat sources such as radiators, heat registers, stoves, or other apparatus (including amplifiers) that produce heat.
9. Do not defeat the safety purpose of the polarized or grounding-type plug. A polarized plug has two blades with one wider than the other. A grounding type plug has two blades and a third grounding

prong. The wide blade or the third prong are provided for your safety. If the provided plug does not fit into your outlet, consult an electrician for replacement of the obsolete outlet.

10. Protect the power cord from being walked on or pinched particularly at plugs, convenience receptacles, and the point where they exit from the apparatus.
11. Only use the attachments/accessories specified by the manufacturer.



12. Use only with the cart, stand, tripod, bracket, or table specified by the manufacturer, or sold with the apparatus. When a cart is used, use caution when moving the cart/apparatus combination to avoid injury from tip-over.

13. Unplug this apparatus during lightning storms or when unused for long periods of time.
14. Refer all servicing to qualified service personnel. Servicing is required when the apparatus has been damaged in any way, such as power-supply cord or plug is damaged, liquid has been spilled or objects have fallen into apparatus, the apparatus has been exposed to rain or moisture, does not operate normally, or has been dropped.

15. Televisions are designed to comply with the recommended safety standards for tilt and stability. Do not apply excessive pulling force to the front, or top, of the cabinet which could cause the product to overturn resulting in product damage and/or personal injury.

16. Follow instructions for wall, shelf or ceiling mounting as recommended by the manufacturer.

17. An outdoor antenna should not be located in the vicinity of overhead power lines or other electrical circuits.

18. If an outside antenna is connected to the receiver be sure the antenna system is grounded so as to provide some protection against voltage surges and built up static charges. Section 810 of the National Electric Code, ANSI/NFPA No. 70-1984, provides information with respect to proper grounding for the mast and supporting structure, grounding of the lead-in wire to an antenna discharge unit, size of grounding connectors, location of antenna-discharge unit, connection to grounding electrodes and requirements for the grounding electrode.

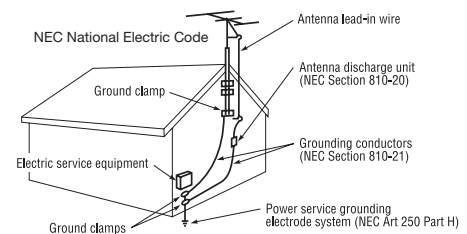

Note to the CATV system installer: This reminder is provided to call the CATV system installer's attention to Article 820-44 of the NEC that provides guidelines for proper grounding and, in particular, specifies that the cable ground shall be connected to the grounding system of the building, as close to the point of cable entry as practical.

Important Safety Instructions



Power source

This plasma television is designed to operate on 120 volts 60 Hz, AC current. Insert the power cord into a 120 volt 60 Hz outlet. The power cord is used as the disconnect device and shall remain readily operable.

To prevent electric shock, do not use the plasma television's (polarized) plug with an extension cord, receptacle, or other outlet unless the blades and ground terminal can be fully inserted to prevent blade exposure.

Never connect the plasma television to 50 Hz, direct current, or anything other than the specified voltage.

Caution



Never remove the back cover of the plasma television as this can expose you to very high voltages and other hazards. If the television does not operate properly, unplug the plasma television and call your authorized dealer or service center.

Caution

Adjust only those controls that are covered in the instructions, as improper changes or modifications not expressly approved by **HITACHI** could void the user's warranty.

Warning

- To reduce the risk of fire or electric shock, do not expose this apparatus to rain or moisture.
- The plasma television should not be exposed to dripping or splashing and objects filled with liquids, such as vases, should not be placed on the television.
- This apparatus shall be connected to a mains socket outlet with a protective earthing connection.

Public viewing of copyrighted material

Public viewing of programs broadcast by TV stations and cable companies, as well as programs from other sources, may require prior authorization from the broadcaster or owner of the video program material.

This product incorporates copyright protection technology that is protected by U.S. patents and other intellectual property rights. Use of this copyright protection technology must be authorized by Macrovision Corporation, and is intended for home and other limited consumer uses only unless otherwise authorized by Macrovision. Reverse engineering or disassembly is prohibited.

Note

This digital television is capable of receiving analog basic, digital basic and digital premium cable television programming by direct connection to a cable system providing such programming. A CableCARD provided by your cable operator is required to view encrypted digital programming. Certain advanced and interactive digital cable services such as video-on-demand, a cable operator's enhanced program guide and data-enhanced television services may require the use of a set-top box. For more information call your local cable company.

Note

- There are no user serviceable parts inside the plasma television.
- Model and serial numbers are indicated on back side of the plasma television.

Prevention of screen damages

Continuous on-screen displays such as video games, stock market quotations, computer generated graphics, and other fixed (non-moving) patterns can be permanently imprinted onto your TV screen. Such "**SCREEN DAMAGES**" constitute misuse and are **NOT COVERED** by your **HITACHI Factory Warranty**.

Lead Notice

This product contains lead. Dispose of this product in accordance with applicable environmental laws. For product recycling and disposal information, contact your local government agency or the Electronic Industries Alliance at www.eiae.org (in the US) or the Electronic Product Stewardship Canada at www.epsc.ca (in Canada).

FOR MORE INFORMATION, CALL 1-800-HITACHI.

Accessories

Check to make sure you have the following accessories before disposing of the packing material.

1 Remote Control

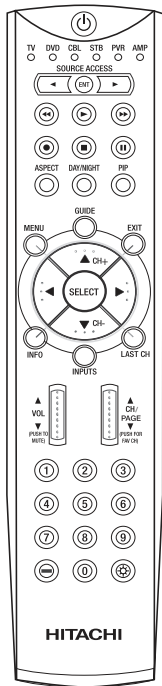

2 Simple Remote

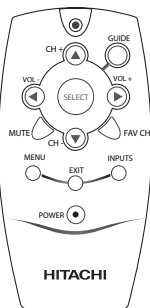

5 Power Cord

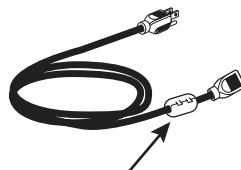

6 2 IR Blaster Cables

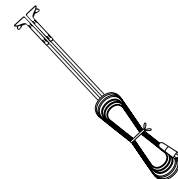

8 Ferrite Core on AC Cord (Only 55" models)



9 Power Swivel Cable



3 Two "AA" size, 1.5V batteries

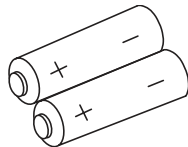

7 Table Top Stand (42" models only)

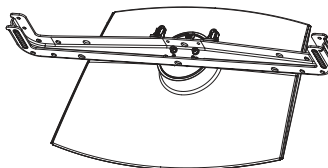

10 1 Ferrite Core (see page 14)



4 Two "AAA" size, 1.5V batteries

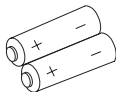

Note: Please visit our website for optional accessories.

For U.S. models:

For optional accessories, please access our web site at:

www.hitachi.us/tv



CAUTION:

1. Ceiling mounting is not recommended. Mounting the panel on the ceiling does not provide adequate ventilation for the electronics or proper support for the front glass panel. This plasma television product is designed for a maximum tilting angle of 45 degrees from vertical.
2. This stand for use only with Hitachi 42HDX99 and 42HDT79. Use with other apparatus is capable of resulting in instability causing possible injury. See important marking located on bottom of stand.

- 1 Remote Control Unit CLU-3861WL (Part No. HL02069).
- 2 Simple Remote Control Unit CLU-123S (Part No. HL01864)(HDX models only).
- 3 Two "AA" size, 1.5V batteries (P# FQ00021).
- 4 Two "AAA" size, 1.5V batteries (P# FR00061)

- 5 Power Cord (P# EV01841).
- 6 Two IR Blaster cables (P# EY01641).
- 7 Table Top Stand (QJ02681 HDT) (QJ02673 HDX) 42" models only.
- 8 Ferrite Core (P# GX00666) (Only 55" models AC Cord)
- 9 Power Swivel Cable (P# EW08432).
- 10 1 Ferrite Core (P#2169513).

REMOTE CONTROL BATTERY INSTALLATION AND REPLACEMENT

1. Open the battery cover of the remote control by pushing down and sliding the back cover off.
2. Insert two new "AA" and "AAA" size batteries for the remote control and Simple Remote Control. When replacing old batteries, push them towards the springs and lift them out.
3. Match the batteries to the (+) and (-) marks in the battery compartment.
4. Replace the cover.

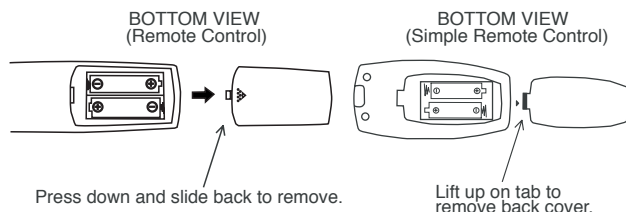

CAUTION: Do not insert batteries with the '+' and '-' polarities reversed as this may cause the batteries to swell or rupture resulting in leakage.

How To Set Up Your New Hitachi Plasma Television

To take measures to prevent the Plasma Television from tipping over and prevent possible injury it is important to mount the unit in a stable and flat surface.

Securing to a table-top

- Using wood screws (two) fasten the set to the clamping screw holes on the rear of the Plasma TV stand as shown below.
- Using commercially available wood screws, secure the set firmly in position.

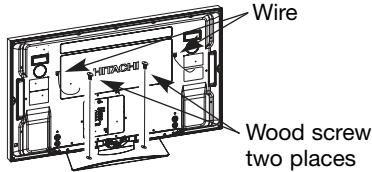

Securing to a Wall

- Keep the Plasma television 4 inches away from the wall except when mounted using the wall mount bracket.
- Secure the television to the wall as shown.

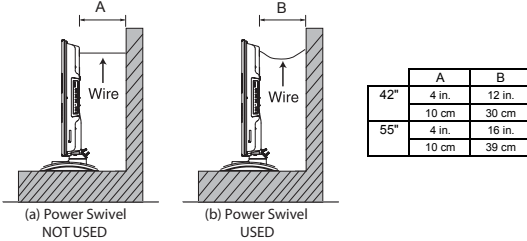

* Please adjust the wire length to avoid touching the wall when turning the TV.

NOTES: 1. Do not block the ventilation holes of the Plasma Television. Blocking the ventilation holes might cause fire or defect.

2. In case of an abnormal symptom, unplug the AC cord.

3. If you purchased the wall mount bracket option, please ask for professional installer. Do not install by yourself.

4. Install the unit at a proper area where it does not expose anyone to any danger of hitting themselves (for example their hands, head or face, etc.) against the edge of the unit and cause personal injury.



5. If the Power Swivel feature will not be used, the Plasma television should be secured to the wall as shown in fig. (a).

6. If the Power Swivel feature will be used, the Plasma television should be secured to the wall as shown in fig. (b).

Caution when moving the main unit

As this product is heavy, whenever it is moved, two people are required to transport it safely. Whenever the unit is moved it should be lifted forward using the top and base on both sides of the Television for stability. When moving the Television, lift the handles (42" models), support the top frame (55" models) and the bottom frame as shown below.

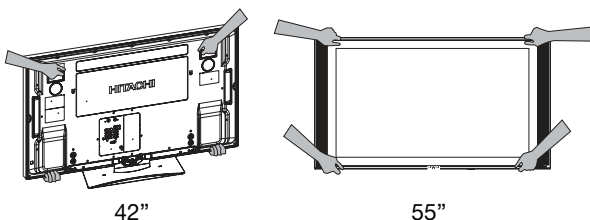

ANTENNA

Unless your Plasma Television is connected to a cable TV system or to a centralized antenna system, a good outdoor color TV antenna is recommended for best performance. However, if you are located in an exceptionally good signal area that is free from interference and multiple image ghosts, an indoor antenna may be sufficient.

LOCATION

Select an area where sunlight or bright indoor illumination will not fall directly on the picture screen. Also, be sure that the location selected allows a free flow of air to and from the perforated back cover of the set. In order to prevent an internal temperature increase, maintain a space of 10 cm (4 inches) from the sides/back of the Television, and 30 cm (12 inches) from the top of the television to the wall. To avoid cabinet warping, cabinet color changes, and increased chance of set failure, do not place the TV where temperatures can become excessively hot, for example, in direct sunlight or near a heating appliance, etc.

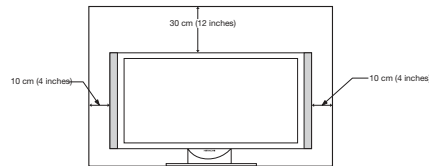

CONNECT POWER SWIVEL CABLE

Connect one end of cable (Arrow mark facing left) to the swivel slot of the Plasma Rear Panel. Connect the other end (Arrow mark facing front) to the swivel slot of the Table Top Stand.

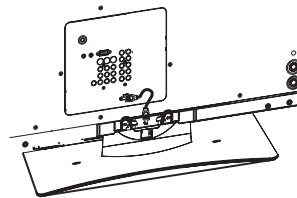

TURNING RADIUS

The maximum turning radius is 30° (left and right). Do not place any objects on the path of the monitor when using the power swivel feature.

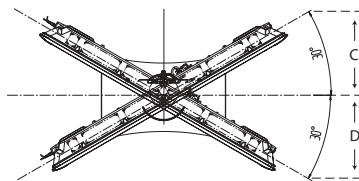

	C	D
42"	10.59 in.	13.93 in.
	27 cm	36 cm
55"	15 in.	16.85 in.
	38.1 cm	42.8 cm

NOTE: The Table Top Stand for model 55HDT79 & 55HDX99 is not included (Optional).

How to set up your new HITACHI Plasma Television

First time use

SETTING FOR WALL MOUNTING

STEP (1) :

Please locate the STAND PLATE metal on the back of the TV . This metal is use to hold the TV and the Base ; so it needs to be remove in order to separate the TV from the Base.

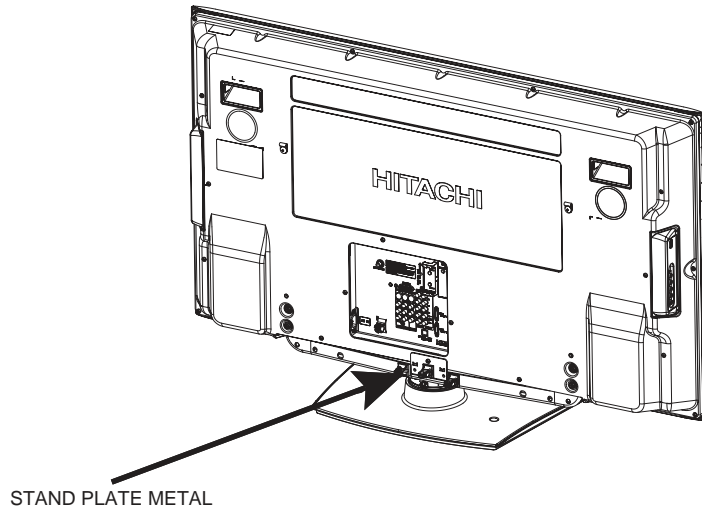

STEP (2):

Please remove the 3 screws and the STAND PLATE metal from the TV, then put back only the screw to the back cover. Now the 4 screws that holds the TV STAND can be remove to separate the TV from the STAND BASE.

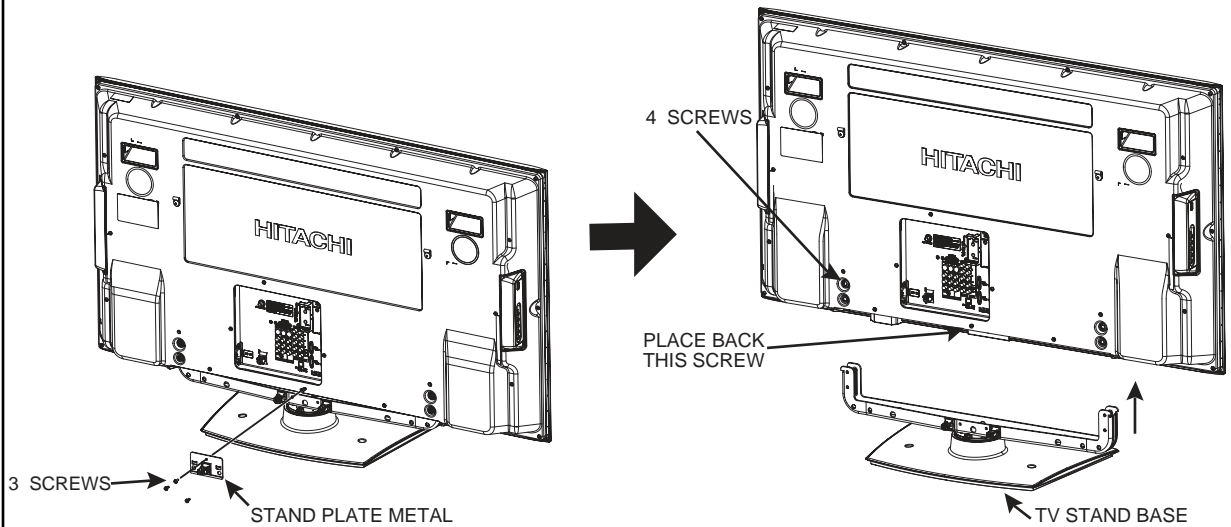

NOTE: Use the specified WALL MOUNT base for the Plasma TV depending on the size of your TV. Please access our web site at: www.hitachi.us/tv for recommended accessories for your tv.

How to set up your new HITACHI Plasma Television

VIEWING

The best picture is seen by sitting directly in front of the TV and about 10 to 18 feet from the screen.

During daylight hours, reflections from outside light may appear on the screen. If so, drapes or screens can be used to reduce the reflection or the TV can be located in a different section of the room.

If the TV's audio output will be connected to a Hi-Fi system's external speakers, the best audio performance will be obtained by placing the speakers equidistant from each side of the receiver cabinet and as close as possible to the height of the picture screen center. For best stereo separation, place the external speakers at least four feet from the side of the TV, place the surround speakers to the side or behind the viewing area. Differences in room sizes and acoustical environments will require some experimentation with speaker placement for best performance.

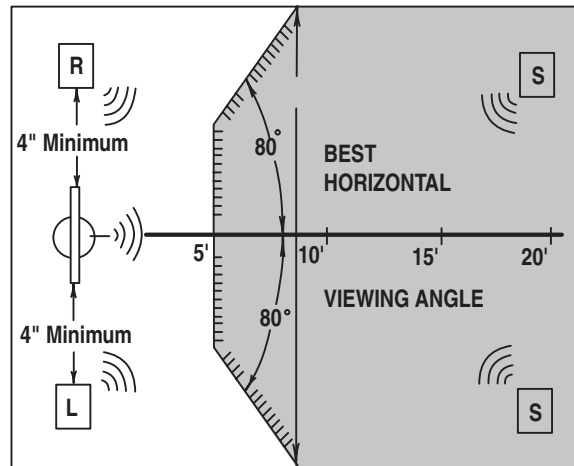
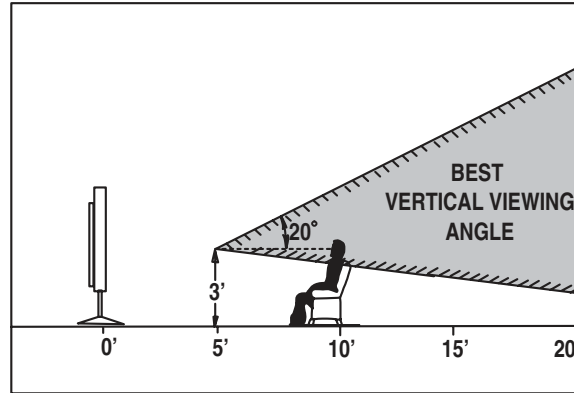

ANTENNA CONNECTIONS TO REAR JACK PANEL

VHF (75-Ohm) antenna/CATV (Cable TV)

When using a 75-Ohm coaxial cable system, connect **CATV** coaxial cable to the AIR/CABLE (75-Ohm) terminal. Or if you have an antenna, connect the coaxial cable to the same AIR/CABLE terminal.

VHF (300-Ohm) antenna/UHF antenna

When using a 300-Ohm twin lead from an outdoor antenna, connect the **VHF** or **UHF** antenna leads to screws of the **VHF** or **UHF** adapter. Plug the adapter into the antenna terminal on the TV.

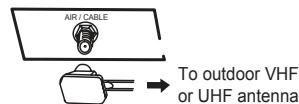
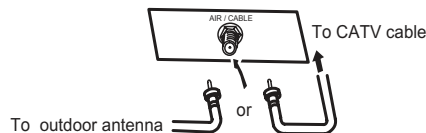

When both VHF and UHF antennas are connected

Attach an optional antenna cable mixer to the TV antenna terminal, and connect the cables to the antenna mixer. Consult your dealer or service store for the antenna mixer.

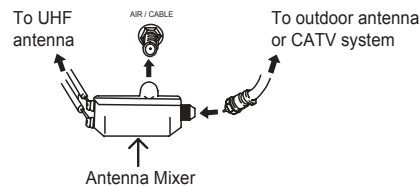

NOTE: Connecting a 300-Ohm twin lead connector may cause interference. Using a 75-Ohm coaxial cable is recommended.

Hook-up Cables and Connectors

Most video/audio connections between components can be made with shielded video and audio cables that have phono connectors. For best performance, video cables should use 75-Ohm coaxial shielded wire. Cables can be purchased from most stores that sell audio/video products. Below are illustrations and names of common connectors. Before purchasing any cables, be sure of the output and input connector types required by the various components and the length of each cable.

300-Ohm Twin Lead Cable

This outdoor antenna cable must be connected to an antenna adapter (300-Ohm to 75-Ohm).

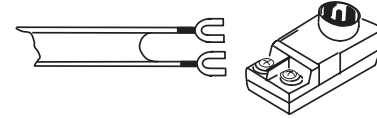

Phono Cable

Used on all standard video and audio cables which connect to inputs and outputs located on the television's rear jack panel and side control panel.



"F" Type 75-Ohm Coaxial Antenna

For connecting RF signals (antenna or cable TV) to the antenna jack on the television.



S-Video (Super Video) Cable

This connector is used on camcorders, VCRs and laser-disc players with an S-Video feature in place of the standard video cable to produce a high quality picture.

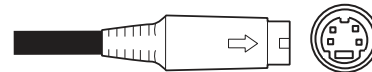

Optical Cable

This cable is used to connect to an audio amplifier with an Optical Audio In jack. Use this cable for the best sound quality.

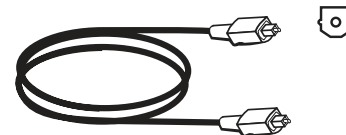

HDMI Cable

This cable is used to connect your external devices such as Set-Top-Boxes or DVD players equipped with an HDMI output connection to the TV's HDMI input.

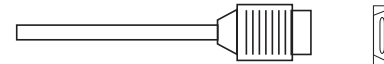

Stereo Cable (3.8mm plug to 3.5mm plug)

Used on all standard video and audio cable which connect to inputs and outputs located on the rear jack panel and side control panel.

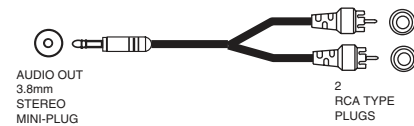

USB Cable

This cable is used to connect your digital camera to the Photo Input in the side of the Plasma television.



IR Blaster Cable (Provided)

Connect the IR Mouse to the IR output of your Plasma Television when AV Network is used. You must place the IR mouse in front of the corresponding IR window of your cable box and VCR. This connection allows your TV to control your cable box and VCR.

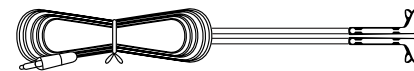

Power Swivel Cable (Provided)

This cable is used to connect the swivel stand to the rear panel of the Plasma Television.



IEEE1394 Cable (HDX only)

This cable is used to connect your digital television to external digital devices. This cable will carry both the video and audio information.



Quick Reference Remote Control Buttons and Functions

In addition to controlling all of the functions on your HITACHI Plasma TV, the new remote control is designed to operate different types of devices, such as, DVD Players, CBL (Cable Boxes), set-top-boxes, satellite receivers, and VCRs. The remote control must be programmed to control the chosen device. Please see pages 25-43 for a complete description of all features and programming of the Remote Control.

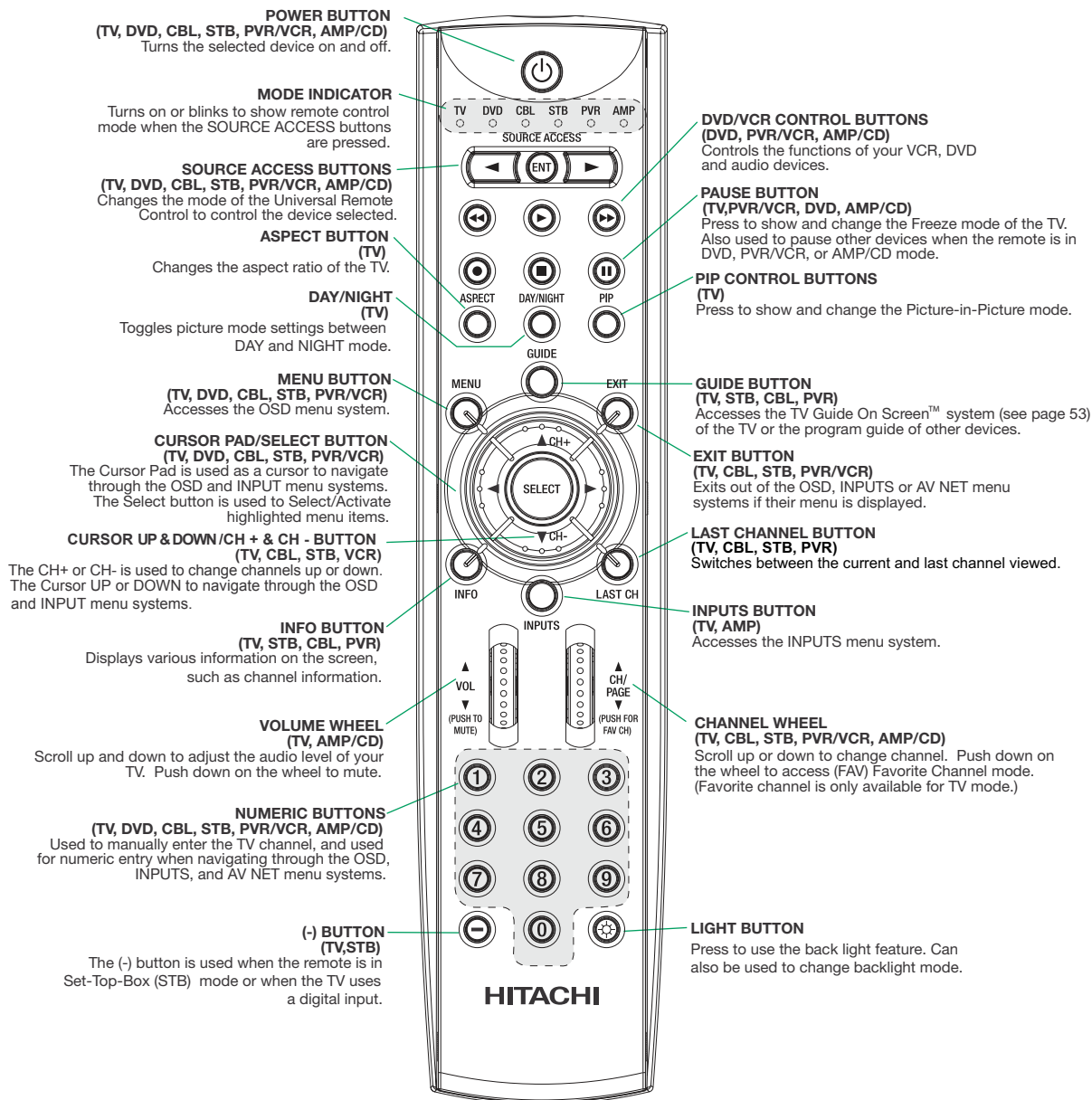

LEGEND

TV – Television	PVR – Video Recorder/Player
CBL – Cable Box	DVD – Digital Video Disc Player
STB – Set-Top-Box	AMP – Audio Amplifier

- NOTES:**
1. The TV's remote control sensor is located on the right bottom portion of the TV screen. To control TV functions, please point the remote control directly at the remote control sensor for best results.
 2. VCR precode is included in the PVR mode.
 3. CD precode is included in the AMP mode.
 4. Pressing the Light button will illuminate the backlight for 8 seconds.

Front/Side Panel Controls

First time use

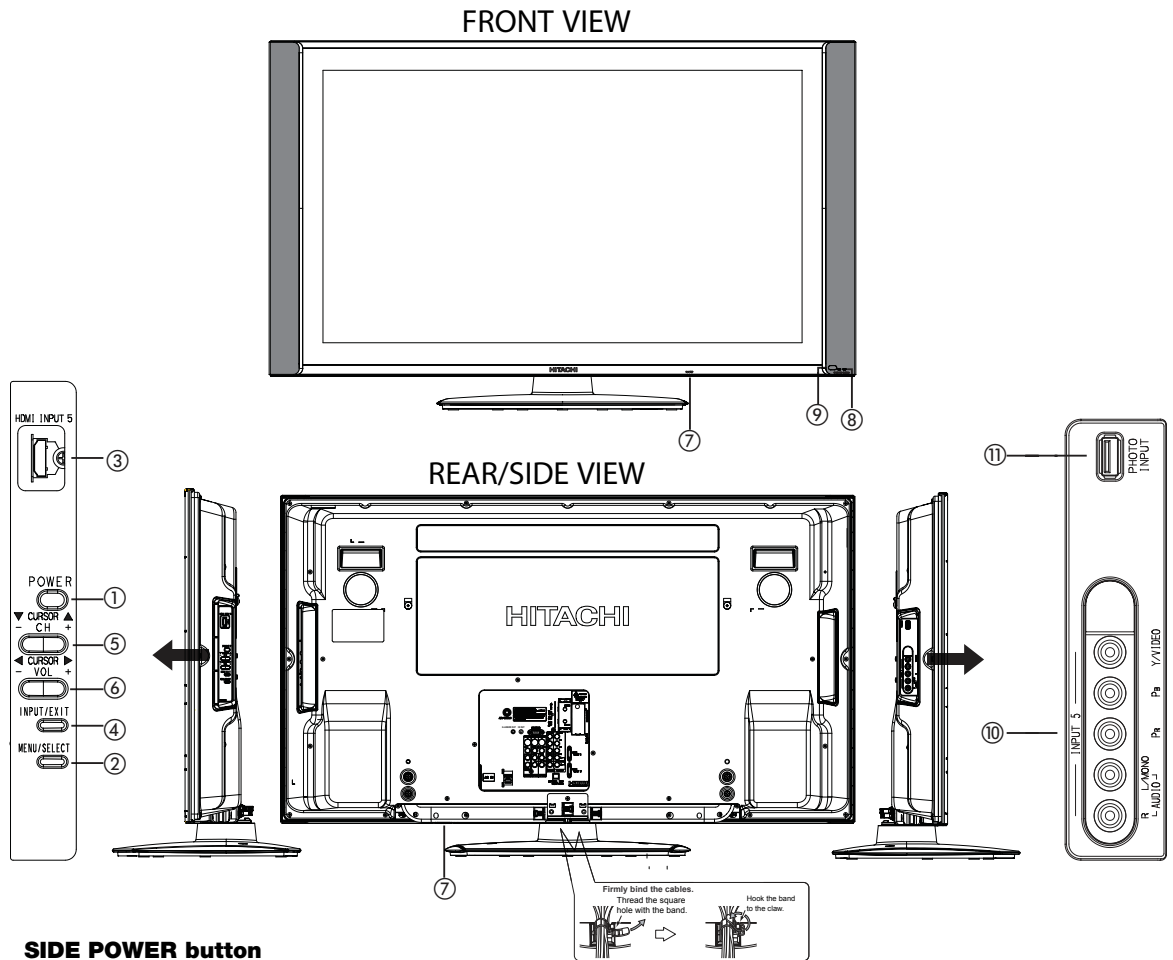

- ① SIDE POWER button**
 Press this button to turn the Plasma Television ON/OFF. It can also be turned ON/OFF by remote control. The "MAIN POWER" button must be at stand-by mode.
- ② MENU/SELECT button**
 This button allows you to enter the MENU, making it possible to set TV features to your preference without using the remote. This button also serves as the SELECT button when in MENU mode.
- ③ SIDE HDMI INPUT (5)**
 Use the side HDMI input for external devices such as Set-Top-Boxes or DVD players equipped with an HDMI output connection (see page 15 for reference).
- ④ INPUT/EXIT button**
 Press this button to access the INPUT menu. Press again to exit the MENU mode.
- ⑤ CHANNEL selector**
 Press these buttons until the desired channel appears in the top right corner of the TV screen. These buttons also serve as the cursor down (▼) and up (▲) buttons when in MENU mode.
- ⑥ VOLUME level**
 Press these buttons to adjust the sound level. The volume level will be displayed on the TV screen. These buttons also serve as the cursor left (◀) and right (▶) buttons when in MENU mode.

NOTE: The Rear View of the 55" model is slightly different from the 42" models. One of the differences are the handles that are only present on the 42" models.

- ⑦ POWER button**
Television MAIN POWER button
 This power button is for the complete system, and must be turned ON/OFF manually. It is recommended to leave the "MAIN POWER" to ON condition (lights red) for stand-by mode.

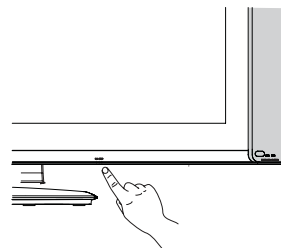

The Main Power button is located on the broadside bottom, under the label "MAIN POWER".

NOTE: When the "MAIN POWER" button is set to OFF or the TV is unplugged, the clock will stop and may eventually reset itself.

Front/Side Panel Controls

⑧ POWER light indicator

To turn the TV ON, press the main power switch located on the lower right side of the TV. A red stand-by indicator lamp located on the lower right corner of the front bezel will illuminate. The Plasma TV is now ready for remote ON/OFF operation.

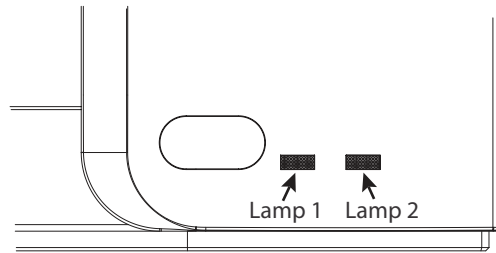

Indicating Lamp		Power Status	Operating
Lamp 1	Lamp 2		
Off	Off	OFF.	When the main power switch is set to Off.
Lights Red	Off	OFF. (Stand-by)	When the main power switch on the TV is ON.
Off	Blinking Blue	OFF. (Turning ON)	TV MAIN POWER is ON ; but no picture is shown.
Off	Lights Blue	On	TV MAIN POWER is ON ; picture is shown.
Lights Orange	Off	Off (Power Saving)	TV MAIN POWER is ON with no signal input except antenna (no sync. signal).

⑨ REMOTE CONTROL sensor

Point your remote at this area when selecting channels, adjusting volume, etc.

⑨ LEARNING AV NET sensor

Point your equipment's remote control at this area while using the AV NET Learning Wizard.

⑩ SIDE INPUT JACKS (for INPUT: 5)

INPUT 5 provide Y-PBPR jacks for connecting equipment with this capability, such as a DVD player or Set Top Box. You may use composite video signal for this input.

⑪ PHOTO INPUT

Insert USB cable from your Digital Camera, USB memory or memory card USB drive to view your digital still pictures (see Owners Guide).

- NOTE:**
1. Your component outputs may be labeled Y, B-Y, and R-Y. In this case, connect the components B-Y output to the TV's P_B input and the components R-Y output to the TV's P_R input.
 2. Your component outputs may be labeled Y-C_BC_R. In this case, connect the component C_B output to the TV's P_B input and the component C_R output to the TV's P_R input.
 3. It may be necessary to adjust **TINT** to obtain optimum picture quality when using the Y-P_BP_R inputs (see page 47).
 4. **INPUT 3, INPUT 4 and INPUT 5 (Y/VIDEO)** can be used for composite video and component video input.

- NOTES:**
1. Your HITACHI Plasma TV will appear to be turned OFF (lights orange) if there is no video input when INPUT : 1, 2, 3, 4 and 5. Check the Power Light to make sure the TV is turned off or in Stand-by mode (lights red) when not in use.
 2. Remote Control can not turn ON/OFF the "MAIN POWER" of the TV.

Rear Panel Connections

① Antenna Input

To switch between Cable and Air input, go to the Channel Manager option to change the signal source CABLE or AIR.

② Audio/Video Inputs 1, 2, 3 and 4

By using the INPUTS button, the CURSOR PAD (▲ and ▼), and the SELECT button or CURSOR PAD ► of the remote control, you can select each video source. Use the audio and video inputs to connect external devices, such as VCRs, camcorders, laserdisc players, DVD players etc. (if you have mono sound, insert the audio cable into the left audio jack).

③ MONITOR OUT & HI-FI AUDIO OUT

These jacks provide fixed and variable audio and video signals (CABLE/AIR or INPUTS) which are used for recording. Use the S-VIDEO Output for high quality video output. Component signal to Input 3,4 and 5, and HDMI inputs will not have monitor output.

④ Optical Out (Digital Audio)

This jack provides Digital Audio Output for your audio device that is Dolby® Digital and PCM compatible, such as an audio amplifier.

NOTE: *Manufactured under license from Dolby Laboratories. "Dolby" and the double-D symbol are trademarks of Dolby Laboratories.

⑤ S-VIDEO Inputs 1 and 2

Inputs 1 and 2 provide S-VIDEO (Super Video) jacks for connecting equipment with S-VIDEO output capability.

NOTE: 1. You may use VIDEO or S-VIDEO inputs to connect to INPUT 1 and 2, but only one of these inputs may be used at a time.
2. S-VIDEO output may be used for recording, only when the input is of S-VIDEO type.

⑥ HDMI 1, 2 & 5 (High Definition Multimedia Interface)

ABOUT HDMI – HDMI is the  next-generation all digital interface for consumer electronics. HDMI enables the secure distribution of uncompressed high-definition video and multi-channel audio in a single cable. Because digital television (DTV) signals remain in digital format, HDMI assures that pristine high-definition images retain the highest video quality from the source all the way to your television screen.

Use the HDMI input for your external devices such as Set-Top-Boxes or DVD players equipped with an HDMI output connection.

HDMI, the HDMI logo and High-Definition Multimedia Interface are trademarks or registered trademarks of HDMI Licensing LLC.

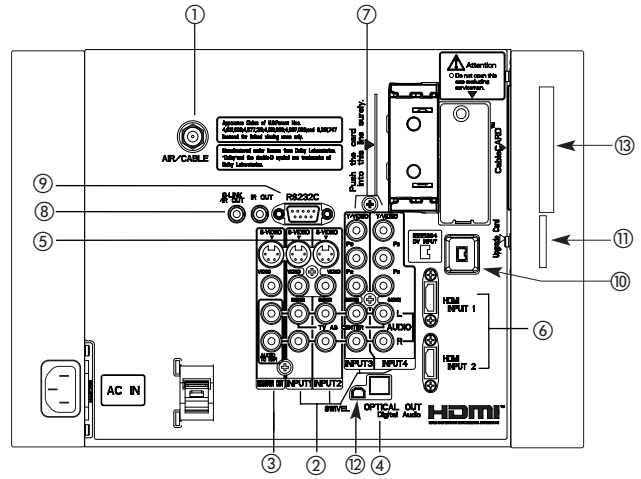

NOTE: 1. The HDMI input is not intended for use with personal computers.
2. Only DTV formats such as 1080i, 720p, 480i and 480p are available for HDMI input.

⑦ Component: Y-PbPr Inputs

INPUTS 3 and 4 provide Y-PbPr jacks for connecting equipment with this capability, such as a DVD player or Set Top Box. You may use composite video signal for both inputs.

NOTE: 1. Do not connect composite VIDEO and S-VIDEO to INPUT 1 or 2 at the same time. S-VIDEO has priority over VIDEO input.
2. Your component outputs may be labeled Y, B-Y, and R-Y. In this case, connect the components B-Y output to the TV's Pb input and the components R-Y output to the TV's Pr input.
3. Your component outputs may be labeled Y-CbCr. In this case, connect the component Cb output to the TV's Pb input and the component Cr output to the TV's Pr input.
4. It may be necessary to adjust TINT to obtain optimum picture quality when using the Y-PbPr inputs (see page 47).
5. To ensure no copyright infringement, the MONITOR OUT output will be abnormal, when using the Y-PbPr jacks and HDMI Input.
6. INPUT 3, 4 and 5 (Y/VIDEO) can be used for composite video and component video input.

⑧ IR Out / G-Link

This jack provides IR output to your external components (VCR, Cable box, DVD player, etc.). With this connection, your external components can automatically be controlled by the AV network feature(Only HDX models). This connection will allow you to control the external components with your Plasma Television's remote control in TV mode. (For reference see pages 68~75 & 77).

⑨ For Special AV control use only.

Rear Panel Connections

⑩ **IEEE1394 (DV INPUT) (Only for HDX models)**

These jacks provide a digital interface for your external digital devices, such as a Digital VCR (D-VHS), Set-Top-Box or Digital Camcorder by means of a single cable (see page 24). When using IEEE1394 connections, you enable video and audio digital data exchange between a compatible device. This connection also enables you to control basic equipment functions (such as VCR play, rewind, fast forward, stop, etc.) from your TV On-Screen Display.

⑪ **Upgrade Card**

This card slot is for future software upgrades. Hitachi will notify you if a software upgrade is required for your TV. In order to receive written notification, please complete and return your warranty card.

⑫ **To Power Swivel Connector**

Connects to the Power Swivel Table Top Stand.

⑬ **CableCARD Slot**

This slot is for the CableCARD that will be provided by your local cable operator to gain access to chosen cable channels. The CableCARD will allow you to tune digital and high definition cable channels. Please call your local cable operator if this service is available before requesting a CableCARD (also known as Point of Deployment (POD) module).

1. Connect a coaxial cable to cable terminal of the Rear Panel Jacks.
2. Insert the CableCARD into the slot (Top of card should be facing towards you as shown below).

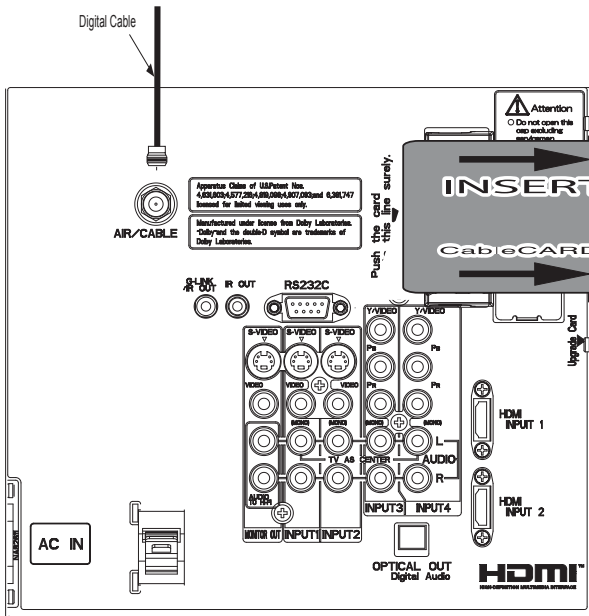

NOTE: 1. A digital cable subscription is required.
2. Do not insert a PCMCIA card into the CableCARD slot.

If the CableCARD is properly installed or removed, the TV will display the following respective screens.

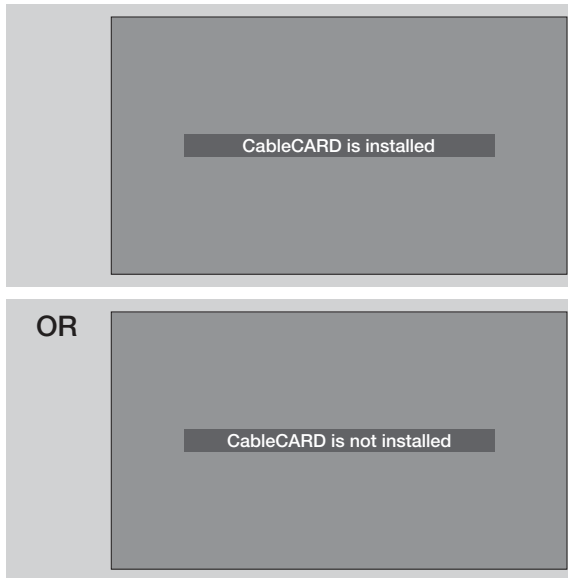

After the CableCARD is installed, wait until the second screen below appears.

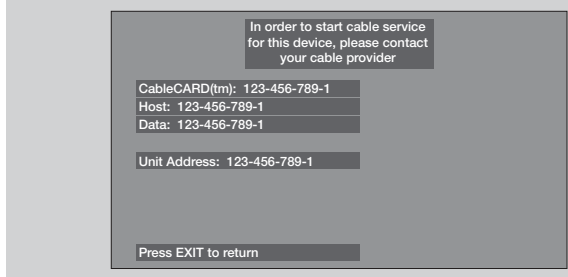

Please take note of all information on the screen (you will provide this information to your cable operator). Call your cable operator and give them the information from the card to start your cable service.

Connecting External Video Sources

The LEFT SIDE panel jacks are provided as a convenience to allow you to easily connect a camcorder , DVD, Video Game, VCR and a Digital Camera as shown in the following examples:

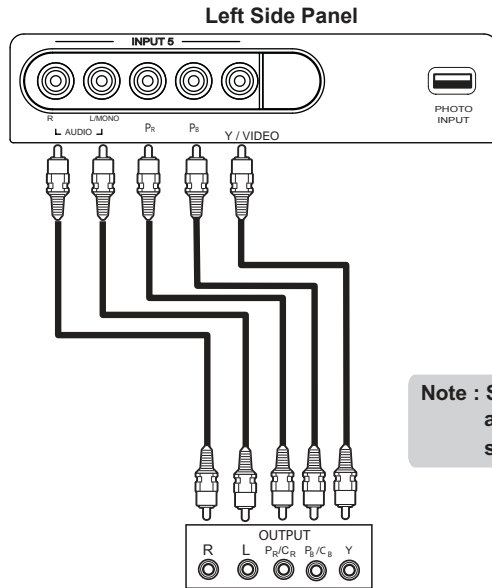

Note : Special device cables will be according to the own device specifications.

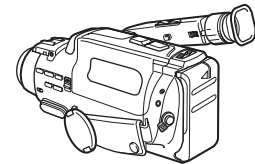
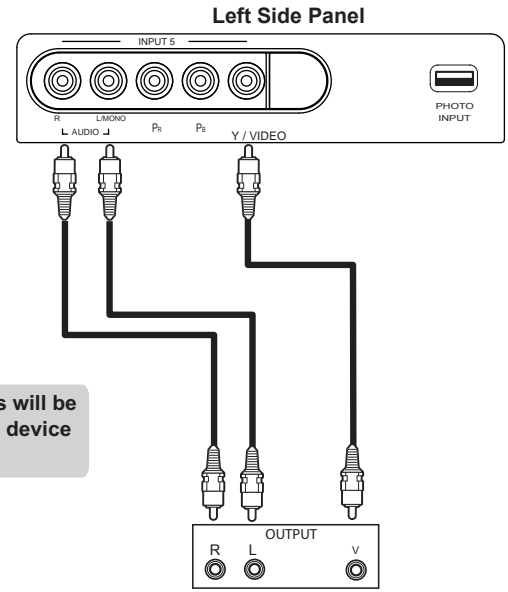

NOTE: 1. Completely insert connection cord plugs when connecting to left side panel jacks. If you do not, the played back picture may be abnormal.

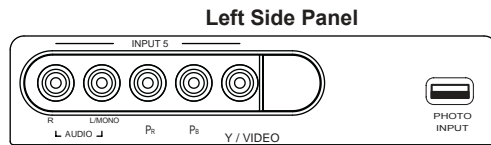

Ferrite Core Instructions:

1. Wrap once the USB cable on the ferrite core near the Photo Input as shown.
2. Fold and close the ferrite core while being careful not to pinch the cable.

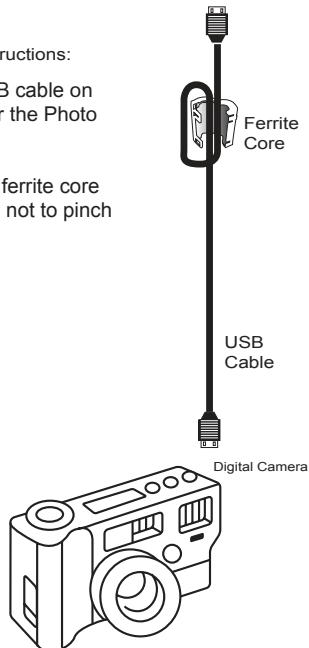

Connecting External Video Sources

The RIGHT SIDE panel jacks are provided as a convenience to allow you to easily connect HDMI or DVI signals from a DVD, Set Top Box, Video Game as shown in the following examples (When connecting DVI signal it will need to connect the audio output into the Left Side Input jacks) :

A) Connecting HDMI signal.

Right Side Panel

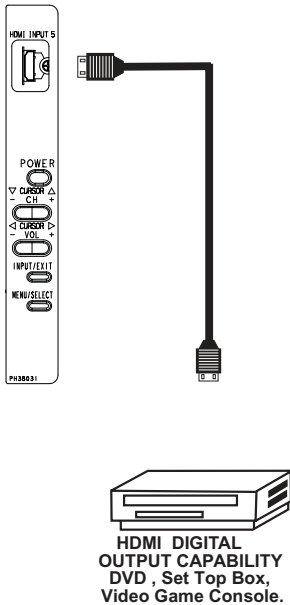

B) Connecting DVI signal.

Right Side Panel

Left Side Panel

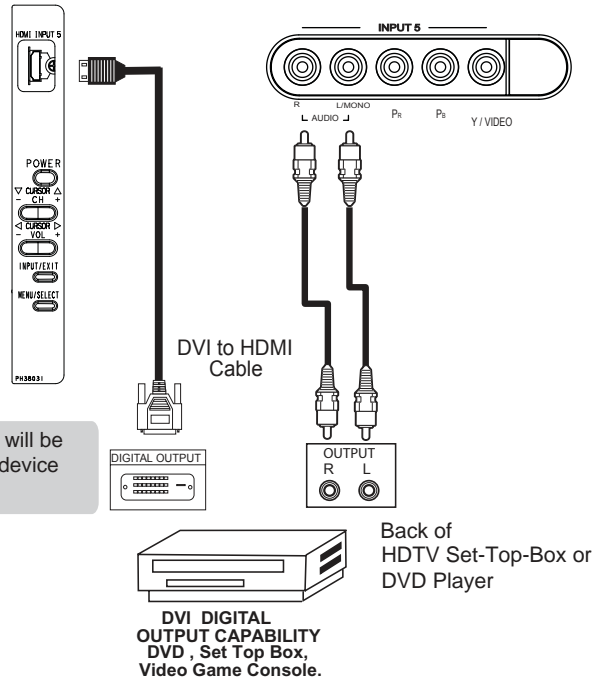

Note : Special device cables will be according to the own device specifications.

NOTE: 1. Completely insert connection cord plugs when connecting to side panel jacks. If you do not, the played back picture may be abnormal.

The exact arrangement you use to connect the VCR, camcorder, laserdisc player, DVD player, or HDTV Set Top Box to your Plasma TV is dependent on the model and features of each component. Check the owner's manual of each component for the location of video and audio inputs and outputs.

The following connection diagrams are offered as suggestions. However, you may need to modify them to accommodate your particular assortment of components and features. For best performance, video and audio cables should be made from coaxial shielded wire.

Before Operating External Video Source

Connect an external source to one of the INPUT terminals, then press the INPUTS button to show the INPUTS menu. Use the CURSOR PAD (▲ and ▼) to select the Input of your choice. Then press the SELECT button or the CURSOR PAD ► to confirm your choice (see page 28).

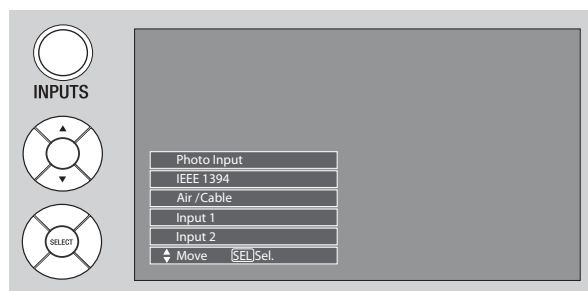

Rear Panel Connections

First time use

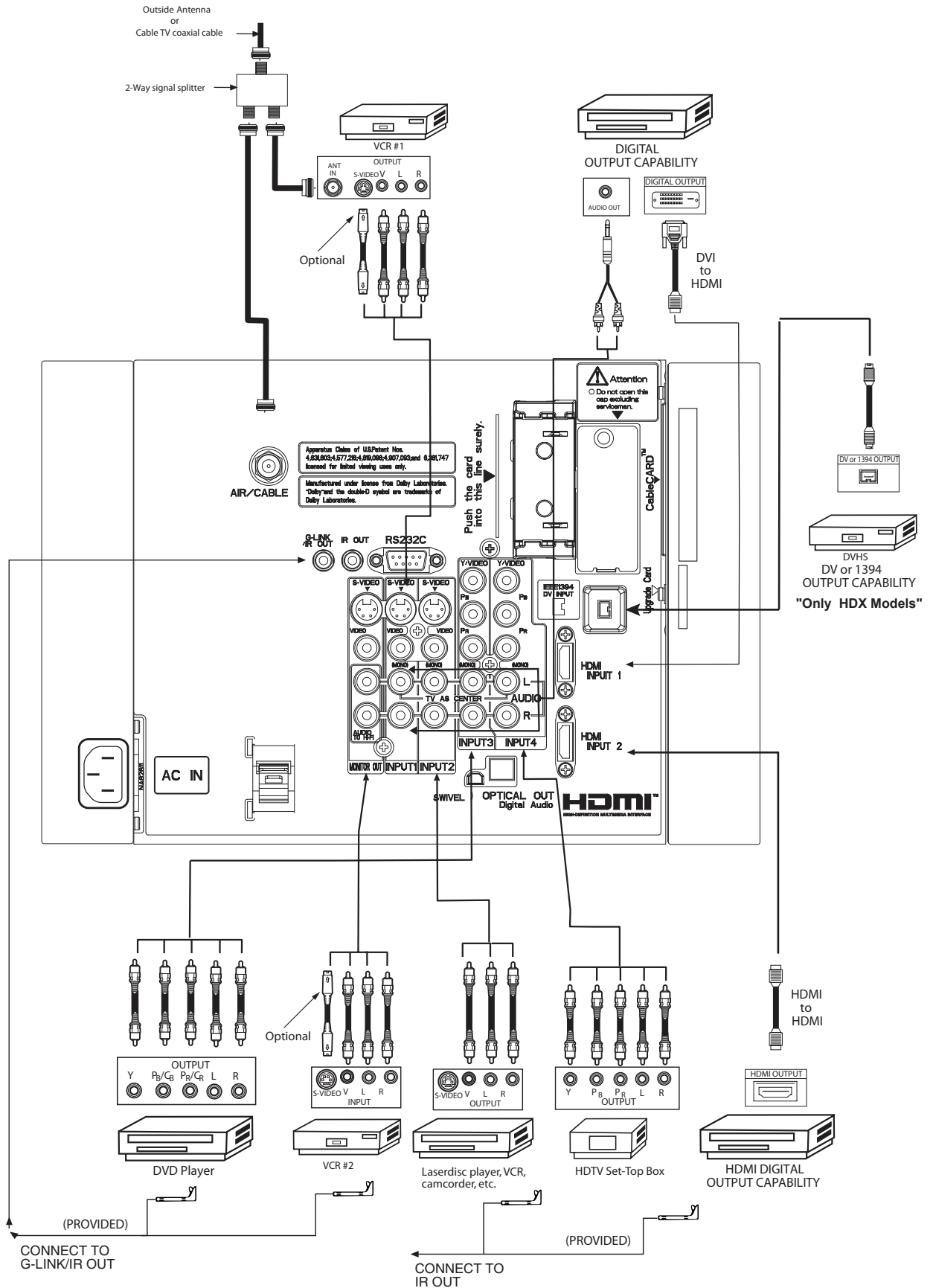

NOTE: Cables are optional, except when specified.

Tips on Rear Panel Connections

- S-VIDEO, Y-P_BP_R, or HDMI connections are provided for high performance laserdisc players, VCRs etc. that have this feature. Use these connections in place of the standard video connection if your device has this feature.
- If your device has only one audio output (mono sound), connect it to the left audio jack on (L/(MONO)) the Rear Panel.
- Refer to the operating guide of your other electronic equipment for additional information on connecting your hook-up cables.
- A single VCR can be used for VCR #1 and VCR #2, but note that a VCR cannot record its own video or line output (INPUT: 1 in the example on page 16). Refer to your VCR operating guide for more information on line input-output connections.
- Connect only 1 component (VCR, DVD player, camcorder, etc.) to each input jack.
- COMPONENT: Y-P_BP_R (Input 3, 4 & 5) connections are provided for high performance components, such as DVD players and set-top-boxes. Use these connections in place of the standard video connection if your device has this feature.
- Your component outputs may be labeled Y, B-Y, and R-Y. In this case, connect the components B-Y output to the TV's P_B input and the components R-Y output to the TV's P_R input.
- Your component outputs may be labeled Y-C_BC_R. In this case, connect the components C_B output to the TV's P_B input and the components C_R output to the TV's P_R input.
- It may be necessary to adjust TINT to obtain optimum picture quality when using the Y-P_BP_R inputs. (See page 47)
- To ensure no copyright infringement, the MONITOR OUT output will be abnormal, when using the Y-P_BP_R, and HDMI input jacks.
- Input 1, 2 or 5 can accept HDMI signal.
- S-VIDEO monitor output may be used for recording only when the input is of S-VIDEO type.
- When using a HDMI input from a Set-Top-Box, it is recommended to use a 1080i or 720p input signal.

INSTALLATION RECOMMENDATION:

1. Video signals fed through a VCR may be affected by copyright protection systems and the picture will be distorted on the television.
2. Connecting the television directly to the Audio /Video output of a Set-Top-Box will assure a more normal picture.

Connecting External Video Sources

CONNECTING A VIDEO AND STEREO AUDIO SOURCE TO INPUT 1 - INPUT 5

1. Connect the cable from the VIDEO OUT of the VCR or the laserdisc player to the INPUT (VIDEO) jack, as shown on the Rear Panel to the right.
2. Connect the cable from the AUDIO OUT R of the VCR or the laserdisc player to the INPUT (AUDIO/R) jack.
3. Connect the cable from the AUDIO OUT L of the VCR or the laserdisc player to the INPUT (AUDIO/L) jack.
4. Press the INPUTS button, then select INPUT 2 from the INPUTS menu to view the program from the VCR or laserdisc player.
5. Select CABLE or AIR from the INPUTS menu to return to the last channel tuned.

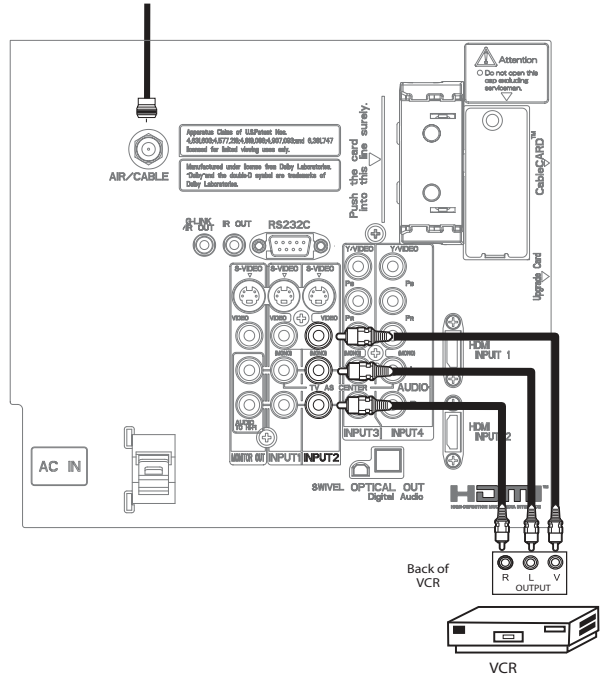

- NOTE:**
1. Completely insert the connection cord plugs when connecting to rear panel jacks. The picture and sound that is played back will be abnormal if the connection is loose.
 2. A single VCR can be used for VCR #1 and VCR #2 (see page 16) but note that a VCR cannot record its own video or line output. Refer to your VCR operating guide for more information on line input-output connections.
 3. When INPUT 3, 4 or 5 are used, it is necessary to connect the video output of the device to the Y/VIDEO input jack of the TV (For INPUT 5 please see page 14 for reference).

CONNECTING AN S-VIDEO AND STEREO AUDIO SOURCE TO INPUT 1, 2

1. Connect the cable from the S-VIDEO OUT of the S-VHS VCR or the laserdisc player to the INPUT (S-VIDEO) jack, as shown on the Rear Panel to the right.
2. Connect the cable from the AUDIO OUT R of the VCR or the laserdisc player to the INPUT (AUDIO/R) jack.
3. Connect the cable from the AUDIO OUT L of the VCR or the laserdisc player to the INPUT (AUDIO/L) jack.
4. Press the INPUTS button, then select INPUT 1 from the INPUTS menu to view the program from the VCR or laserdisc player.
5. Select CABLE or AIR from the INPUTS menu to return to the last channel tuned.

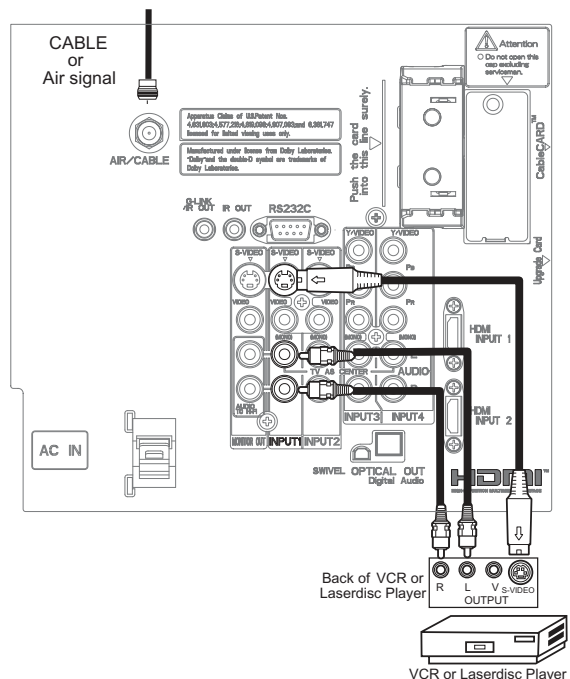

- NOTE:**
1. Completely insert the connection cord plugs when connecting to rear panel jacks. The picture and sound that is played back will be abnormal if the connection is loose.
 2. A single VCR can be used for VCR #1 and VCR #2 (see page 16), but note that a VCR cannot record its own video or line output. Refer to your VCR operating guide for more information on line input-output connections.

Connecting External Video Sources

CONNECTING A COMPONENT SOURCE WITH HDMI OR DVI CAPABILITY TO INPUT 1, 2 OR 5

1. Connect the HDMI or DVI to HDMI connection cable from the output of the HDTV set top box or DVD player to the HDMI input as shown on the Rear panel below.
2. With DVI output, connect the cable from the AUDIO OUT R of the HDTV set top box or DVD player to the INPUT (AUDIO/R) jack as shown on the Rear Panel below.
3. With DVI output, connect the cable from the AUDIO OUT L of the HDTV set top box or DVD player to the INPUT (AUDIO/L) jack as shown on the Rear Panel below.
4. Press the INPUTS button, then select INPUTS 1, 2 or 5 to view the program from the HDTV set top box or DVD player.
5. Select CABLE or AIR from the INPUTS menu to return to the last channel viewed.

- NOTE:**
1. Completely insert the connection cord plugs when connecting to rear panel jacks. The picture and sound that is played back will be abnormal if the connection is loose.
 2. The HDMI input on INPUT 1, 2 and 5 contains the copy protection system called High-bandwidth Digital Content Protection (HDCP). HDCP is a cryptographic system that encrypts video signals when using HDMI connections to prevent illegal copying of video contents.
 3. HDMI is not a "NETWORK" technology. It establishes a one-way point-to-point connection for delivery of uncompressed video to a display.
 4. The connected digital output device controls the HDMI interface so proper set-up of device user settings determines final video appearance.
 5. When using a DVI to HDMI cable, connect the Audio Out L and R cables at the same INPUT (1, 2 or 5) as your HDMI INPUT(1, 2 or 5). (For INPUT 5 please see page 15 for reference).

HDMI input

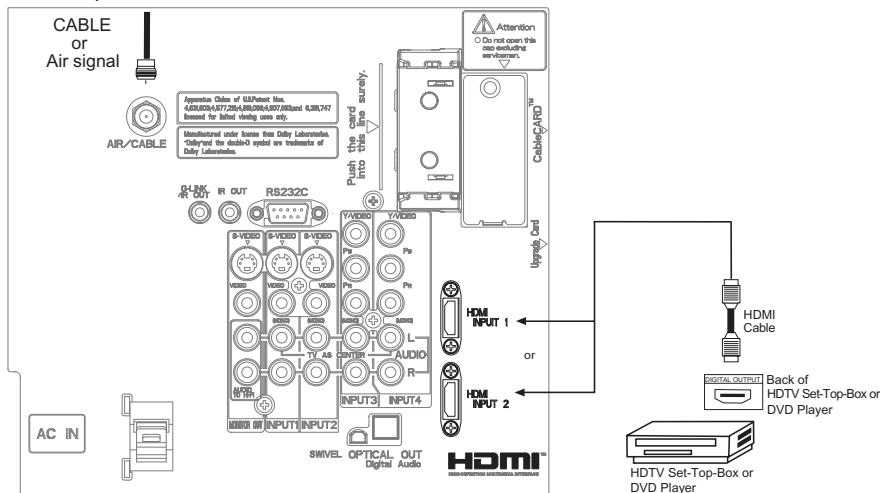

DVI to HDMI Input

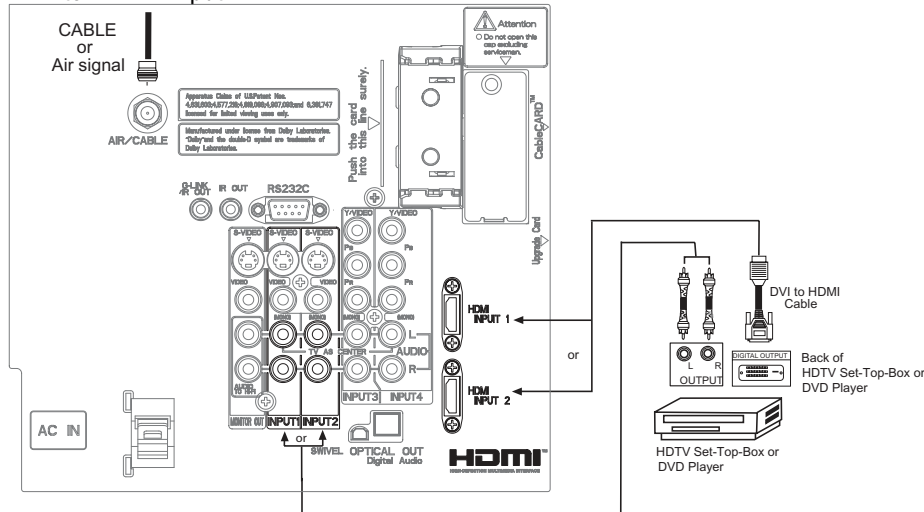

First time use

Connecting External Audio/Video Devices

CONNECTING A COMPONENT AND STEREO AUDIO SOURCE TO INPUT 3, 4 or 5 :Y-PbPr.

1. Connect the cable from the Y OUT of the Laserdisc/DVD player or HDTV set top box to the INPUT (Y) jack, as shown on the Rear panel below.
2. Connect the cable from the P_B/C_B OUT or B-Y OUT of the Laserdisc/DVD player or HDTV set top box to the INPUT (P_B) jack.
3. Connect the cable from the P_R/C_R OUT or R-Y OUT of the Laserdisc/DVD player or HDTV set top box to the INPUT (P_R) jack.
4. Connect the cable from the AUDIO OUT R of the Laserdisc/DVD player or HDTV set top box to the INPUT (AUDIO/R) jack.
5. Connect the cable from the AUDIO OUT L of the Laserdisc/DVD player or HDTV set top box to the INPUT (AUDIO/L) jack.
6. Press the INPUTS button, then select INPUT 4 from the INPUTS menu to view the program from the Laserdisc/DVD player or HDTV set top box.
7. Select CABLE or AIR to return to the last channel tuned.

NOTE: 1. Completely insert the connection cord plugs when connecting to rear panel jacks. The picture and sound that is played back will be abnormal if the connection is loose.
2. See page 17 for tips on REAR PANEL CONNECTIONS.

(For INPUT 5 please see page 14 for reference).

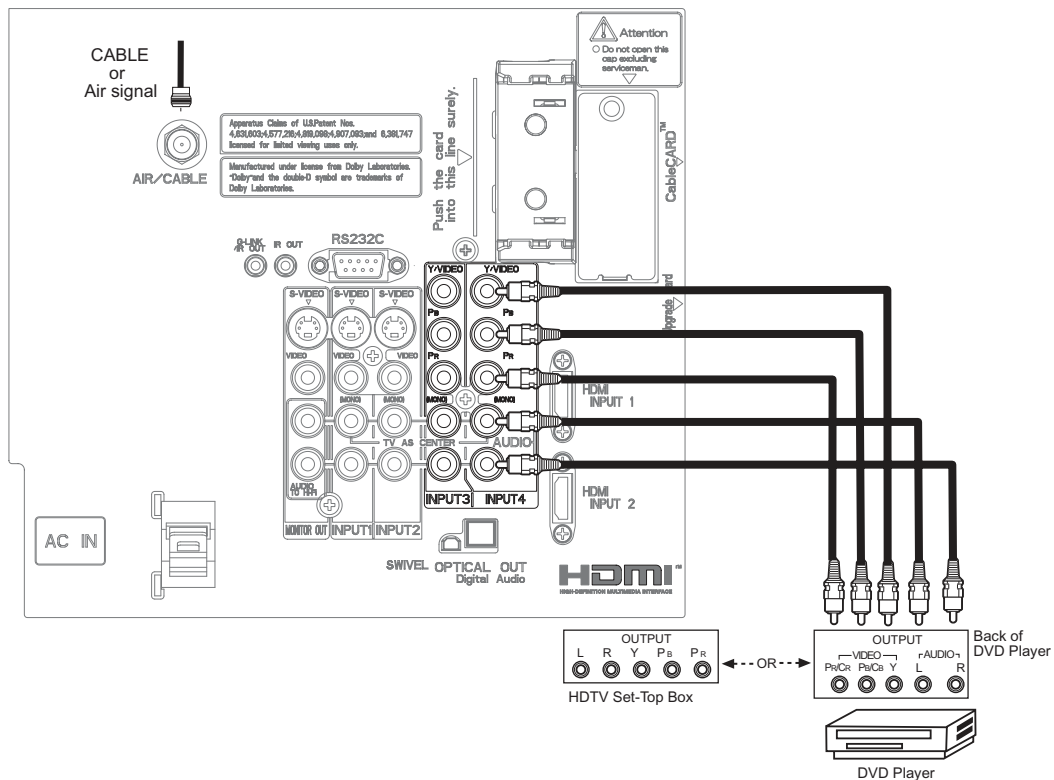

First time use

Connecting External Audio/Video Devices

CONNECTING A VIDEO AND MONAURAL AUDIO SOURCE TO INPUT 1 ~ INPUT 5

1. Connect the cable from the VIDEO OUT of the VCR or the laserdisc player to the INPUT (VIDEO) jack, as shown on the Rear Panel on the right.
2. Connect the cable from the AUDIO OUT of the VCR or the laserdisc player to the INPUT (MONO)/L(AUDIO) jack.
3. Press the INPUTS button, then select INPUT 2 from the INPUTS menu to view the program from the VCR or the laserdisc player.
4. Select CABLE or AIR from the INPUTS menu to return to the previous channel.
(For INPUT 5 please see page 14 for reference).

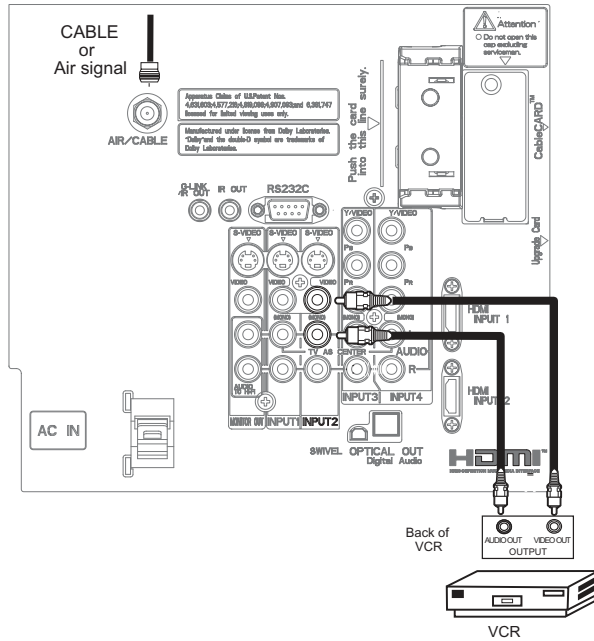

CONNECTING AN EXTERNAL AUDIO AMPLIFIER

To monitor the audio level of the Plasma TV to an external audio amplifier, connect the system as shown on the right. The "OPTICAL OUT" from the Rear Panel is a fixed output. The Volume of the amplifier is controlled by the amplifier, not by the Plasma Television. The OPTICAL OUT terminal outputs all audio sources with Optical IN capability.

1. Connect an optical cable from the Optical out to the Optical input of a separate Stereo System Amplifier as shown on the Rear Panel on the right.

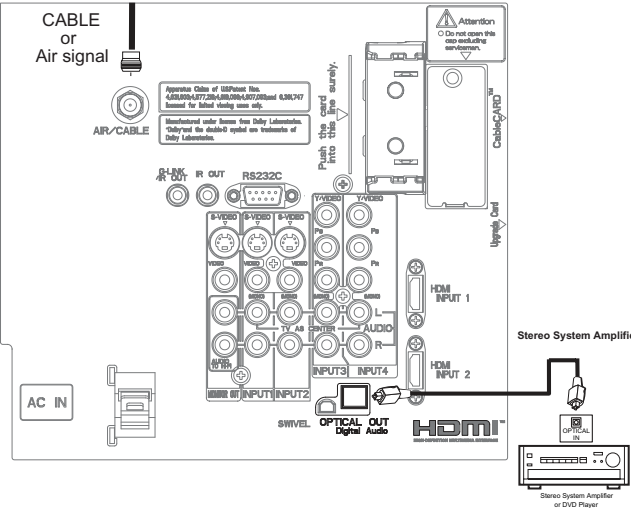

CONNECTING MONITOR OUT

The MONITOR OUT terminal outputs video and audio of CABLE/AIR and INPUTS 1, 2, 3, 4 and 5. It does not output component and HDMI video.

1. Connecting S-Video:
Connect the cable from the S-VIDEO OUT of the Rear Panel to the INPUT (S-VIDEO) jack, of the VCR or Laserdisc player.
- Connecting Video:
Connect the cable from the VIDEO INPUT of the VCR or the laserdisc player to the VIDEO out jack on the TV Rear Panel.
 2. Connect the cable from the AUDIO IN R of the VCR or the laserdisc player to the OUTPUT (AUDIO/R) jack on the TV Rear Panel.
 3. Connect the cable from the AUDIO IN L of the VCR or the laserdisc player to the OUTPUT (AUDIO/L) jack on the TV Rear Panel.

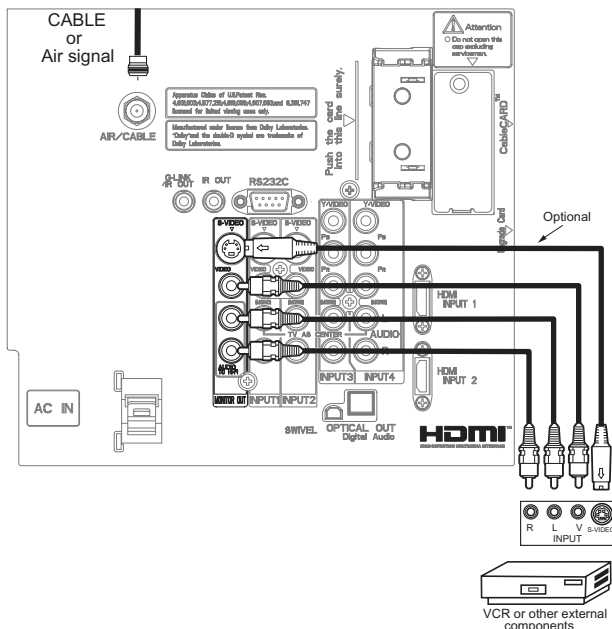

NOTE: When making video connections, connect S-Video only or Video only. If both are connected, S-Video takes priority.

First time use

Connecting External Video Sources

Your HITACHI Plasma Television is equipped with an AV Network feature. This feature helps to control your external Audio/Video equipment (VCR, Set Top Box, DVD, etc.). Once this is setup, it allows your IR Blaster cable to control your equipment using your HITACHI Plasma TV Remote Control. You can use your HITACHI remote control to control the Audio/Video equipment command without the equipment's remote control.

The Plasma Television Rear Panel has 2 IR Out jacks. Each IR Blaster cable can connect up to 2 external Audio/Video components. Therefore, you can connect the Plasma Television with up to four components. Please see the following example of an AV Network setup between your Hitachi Plasma Television and external Audio/Video equipment (VCR and DVD Player).

CONNECTING EXTERNAL AUDIO/VIDEO COMPONENTS TO IR OUT FOR AV NETWORK

1. Connect your external Audio/Video components to the Rear Panel shown below.
2. Connect the IR Blaster cable to the IR OUT terminal of the Rear Panel.
3. Place the IR Blaster in front of the infrared sensor of the external components you wish to control.

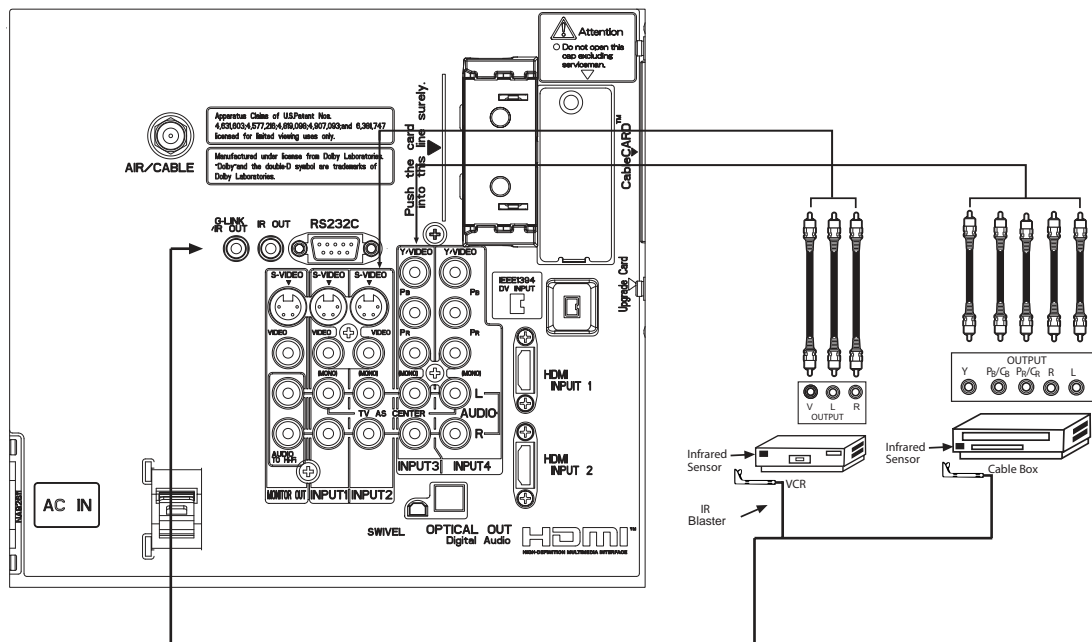

4. ACCESS THE AV NET SETUP WIZARD
Press the MENU button.
5. Use the CURSOR PAD ▼ or channel scroll down to highlight SETUP.
6. Press the SELECT or CURSOR PAD ► button to select.
7. Use the CURSOR PAD ▼ or channel scroll to highlight the SET AV NET features then press the SELECT button.
8. Follow the Setup procedure on pages 68-75.

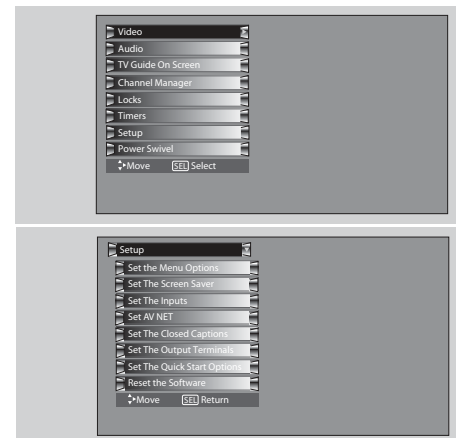

- NOTE:**
1. The Rear Panel has two IR OUT terminals which can control up to a total of four external components.
 2. The IR Blaster must be placed in front of the external components infrared sensor for the AV Network to work. Double-sided mounting tape may be used to hold the IR Blaster in place.
 3. The correct codes must be chosen for each of the Audio/Video components for the AV Network to function properly.

Connecting External Video Sources

Your HITACHI Plasma Television is equipped with a G-LINK feature. This connection is necessary for the TV Guide On Screen™ system to work with your cable box to receive program listings and to enable VCR recording features. Once you setup the G-LINK (IR Blaster) connector, then you can use your HITACHI Plasma TV Remote Control and the TV Guide On Screen system to control your cable box and VCR recording features.

The Plasma Television Rear Panel has IR OUT/G-LINK terminals. One IR Blaster cable can connect up to 2 external Audio/Video components. Please see the following example of a G-LINK setup between your HITACHI Plasma Television and external Audio/Video equipment (VCR and Cable box).

CONNECTING THE CABLE BOX/VCR TO G-LINK FOR TV GUIDE ON SCREEN™ SYSTEM

1. Connect your external Audio/Video components to the Rear Panel shown below.
2. Connect the IR Blaster cable to the IR OUT/G-LINK output terminal of the Rear Panel.
3. Place the IR Blaster in front of the infrared sensor of the external components you want to control.

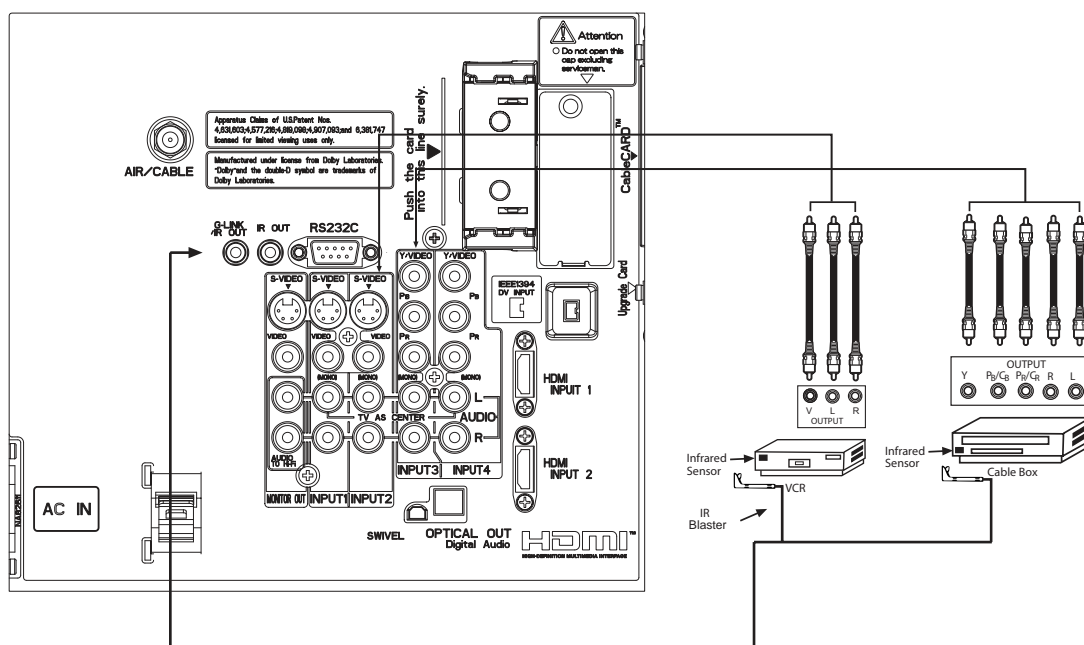

4. To access the TV Guide On-Screen™ system, press the MENU button.
5. Use the CURSOR PAD ▼ or channel scroll down to highlight TV GUIDE ON SCREEN.
6. Press the SELECT or CURSOR PAD ► button to select.
7. Follow the Setup procedure on pages 53-55.

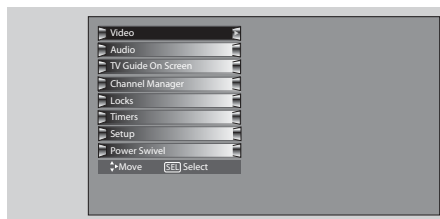

NOTE: 1. The G-LINK connection is not necessary for IEEE1394 equipped devices, such as a D-VHS.
 2. The IR Blaster must be placed in front of the external components infrared sensor for the AV Network to work.
 3. G-LINK connections are available on both IR OUT terminals.

Connecting External Video Sources

First time use

CONNECTING A COMPONENT SOURCE WITH DIGITAL INTERFACE CAPABILITY TO IEEE1394 TERMINALS.

1. Connect the IEEE1394 cable from the output of the component with IEEE1394 capability, such as a Digital VCR or AVHD (External Hard Drive) Digital Recorder, to the IEEE1394 input terminals shown below. IEEE 1394 allows the plasma television and the external device to communicate with one another. When using IEEE1394 connections, you enable video and audio digital data exchange between a compatible device. This connection also enables you to control basic equipment functions (such as VCR play, rewind, fast forward, stop, etc.) from your TV On-Screen Display.
2. Press the INPUTS button on the Remote Control.
3. Select the IEEE1394 option (see page 31).

NOTE: 1. With IEEE1394 connection, video and audio will be received by the TV. It will enable you to control the D-VHS from the TV IEEE1394 menu (see page 31).
 2. The IEEE1394 interface contains the copy protection standard called 5C or Digital Transmission Content Protection (DTCP).

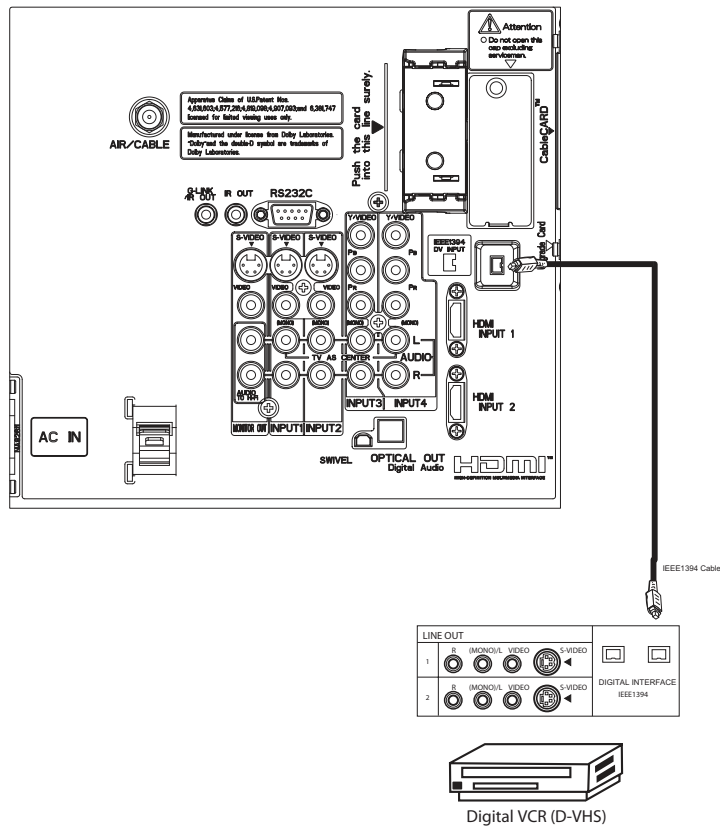

The Remote Control

In addition to controlling all the functions on your HITACHI Plasma TV, the new remote control is designed to operate different types of VCRs, CATV (Cable TV) converters, set-top-box, satellite receiver, DVD players, and other audio/video equipment with one touch. Basic operation keys are grouped together in one area.

To operate your Plasma TV, point the remote control at the remote sensor of the television and select the TV by pressing the ◀ or ▶ button of the Source Access on the remote. The TV mode indicator will blink, indicating that the remote will now control your television.

To operate your VCR, point the remote at the remote sensor of the VCR and select PVR by pressing the ◀ or ▶ button of the Source Access on the remote. The PVR mode indicator will blink, indicating that the remote will now control your VCR (see page 39 for instructions on how to program the remote to control your VCR).

To operate your PVR (Personal Video Recorder), point the remote at the remote sensor of the PVR and select PVR by pressing the ◀ or ▶ button of the Source Access on the remote. The PVR mode indicator will blink, indicating that the remote will now control your PVR (see page 39 for instruction on how to program the remote to control your PVR).

To operate your cable box, point the remote at the remote sensor of the cable box and select the CABLE (CBL) by pressing the ◀ or ▶ button of the Source Access on the remote. The CBL mode indicator will blink, indicating that the remote will now control your cable box (see page 36 for instructions on how to program the remote to control your cable box).

To operate your set-top-box or satellite receiver point the remote at the remote sensor of the set-top-box and select the SET-TOP-BOX (STB) by pressing the ◀ or ▶ button of the Source Access on the remote. If you have a satellite receiver, use this button to program your satellite receiver. The STB mode indicator will blink, indicating that the remote will now control your set-top-box (see page 37 for instructions on how to program the remote to control your set-top-box).

To operate your DVD player, point the remote at the remote sensor of the DVD player and select DVD by pressing the ◀ or ▶ button of the Source Access on the remote. The DVD mode indicator will blink, indicating that the remote will now control your DVD Player (see page 38 for instruction on how to program the remote to control your DVD player).

To operate additional audio equipment, point the remote at the remote sensor of the component you wish to control and select AMP by pressing the ◀ or ▶ button of the Source Access on the remote. The AMP mode indicator will blink, indicating that the remote will now control your audio equipment (see page 40 for instructions on how to program the remote to control additional Audio/Video equipment).

There are two modes of lighting the Remote Control buttons. They are the Automatic and Manual modes.

AUTOMATIC MODE (Optional mode)

In Automatic mode, if any button is pressed (including the LIGHT button), the illumination will light for 4 seconds.

MANUAL MODE (Default mode)

In Manual mode, the illumination will only work when the LIGHT button is pressed. When the LIGHT button is pressed, the illumination will light for 8 seconds. During the illumination, if the LIGHT button is pressed, the illumination will turn off.

CHANGING LIGHTING MODES (Automatic to Manual/Manual to Automatic)

1. Place the Remote Control in TV Mode by using the SOURCE ACCESS ◀ and ▶ buttons. The TV mode indicator will blink 3 times to confirm the remote control mode.
2. Press and hold the LIGHT button for 10 seconds. After releasing the LIGHT button, the TV mode indicator will blink 3 times to confirm the mode switch.

NOTE: When you press any remote control button, the buttons will light up. The illumination will light a few seconds during this time. The buttons will appear to light if the room is dark.

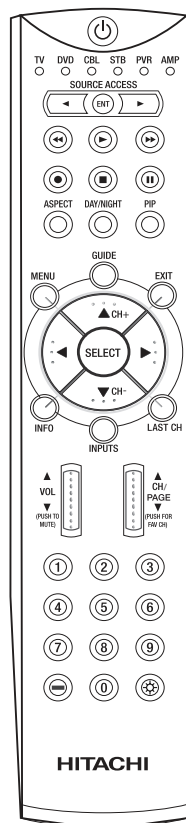

How to Use the Remote to Control Your TV

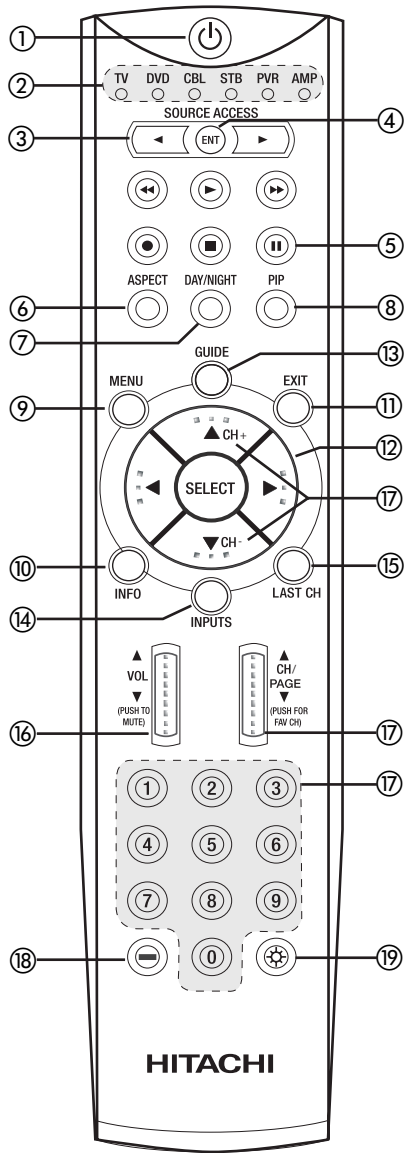

- 1 POWER button**
Press this button to turn the TV set on or off when the remote is in TV mode. (See page 25 for instructions on how to set the remote control to TV mode.)
- 2 MODE Indicator**
Turns on or blinks to show remote control mode.
- 3 SOURCE ACCESS (◀ or ▶) buttons**
Press these buttons to select remote control mode.
- 4 SOURCE ACCESS (ENT) button**
Hold down this button while entering your device code to program the remote (see pages 36-41). You can also use this button in an optional Input access feature (see page 41).
- 5 PAUSE button**
Press the PAUSE button to freeze the picture. Press the EXIT button to return the picture to motion. Press the PAUSE button repeatedly to cycle through the three different freeze modes (see page 35).

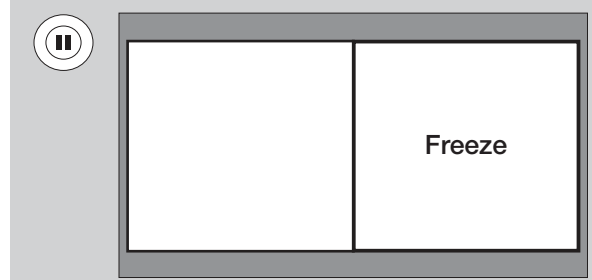
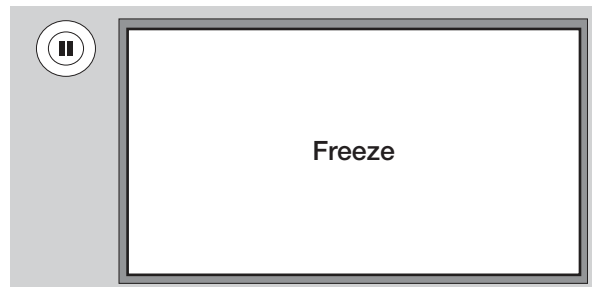

How to Use the Remote to Control Your TV

⑥ ASPECT button

Press this button to quickly change the picture format ASPECT ratio. Depending on the input signal format received, the picture format ratio allows you to adjust the images through the following options.

4:3 STANDARD

Use this aspect mode to display conventional (4:3) images. Side panels (gray areas) are placed to the left and right of the image to preserve the original aspect ratio of the source. Note: Use this mode for only 15% of your total viewing time to prevent uneven aging of the phosphors. Phosphors in the lighted area of the picture will age more rapidly than the gray areas.

4:3 EXPANDED

Use this aspect mode to display conventional (4:3) sources by linearly increasing image expansion from the center towards the edges of the display area in order to fill it.

4:3 ZOOM1/ZOOM2

Use these aspect modes to zoom in on conventional (4:3) sources.

16:9 STANDARD 1

Use this aspect mode to display 16:9 sources like HDTV and DVD's preserving the original 16:9 aspect ratio showing 95% of the size.

16:9 STANDARD 2

Use this aspect mode to display 16:9 sources like HDTV and DVD's preserving the original 16:9 aspect ratio showing 100% of the size.

16:9 ZOOM

Use this aspect to Zoom-in once while in 16:9 aspect.

- Antenna-Analog Channel
- S-Video/Video Input (Auto Aspect: Off)
- HDMI-480i/480p Input (Auto Aspect: Off)
- Component-480i/480p Input (Auto Aspect: Off)

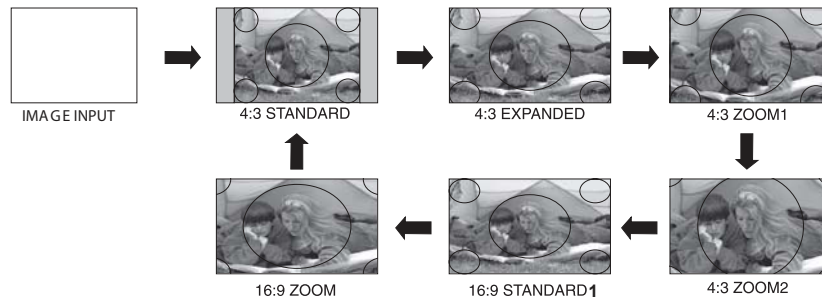

Note: Please see Appendix A on page 98.

- Antenna-Digital Channel (4:3)
- S-Video/Video 4:3/Letter Input (Auto Aspect: On)
- HDMI-480i/480p 4:3/Letter Input (Auto Aspect: On)
- Component-480i/480p 4:3/Letter Input (Auto Aspect: On)
- IEEE1394 (4:3) (Only HDX models)

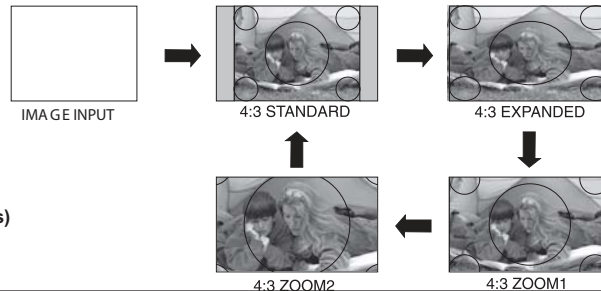

Note: Please see Appendix A on page 98.

- S-Video/Video 16:9 Input (Auto Aspect: On)
- HDMI-480i/480p 16:9 Input (Auto Aspect: On)
- Component-480i/480p 16:9 Input (Auto Aspect: On)

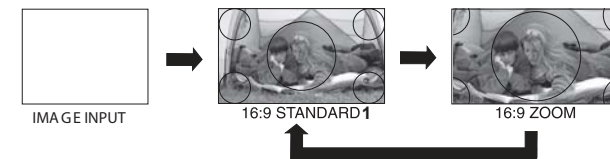

Note: Please see Appendix A on page 98.

- Antenna-Digital Channel (16:9)
- HDMI-720p/1080i Input
- Component-720p/1080i Input
- IEEE1394 (16:9) (Only HDX models)

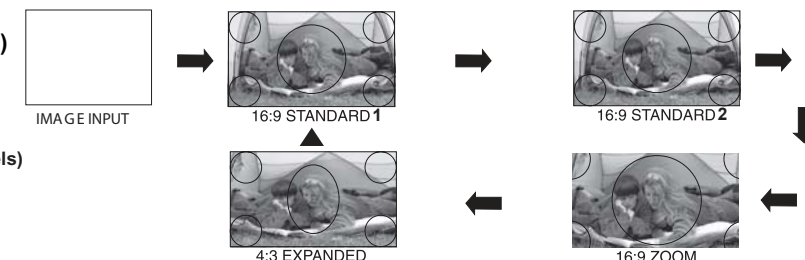

Note: Please see Appendix A on page 98.

- NOTE:
1. The Aspect Style in all five video inputs have independent Aspect Style setting.
 2. Vertical position adjustments are directly available when you choose 4:3 EXPANDED/ZOOM1/ZOOM2 or 16:9 ZOOM aspect style (see also page 50).
 3. When displaying 16:9 STANDARD 2 it may appear lines at the edge of the picture this is normal operation of the TV.

How to Use the Remote to Control Your TV

⑦ DAY/NIGHT button

Press this button to toggle between Day(Normal), Day(Dynamic) and Night picture mode settings. Select Day modes for day time viewing with more brightness and contrast to compete with room light. Select Night for nighttime viewing with less brightness and contrast for amore detailed picture (see page 47 for settings changes).

NOTE: For automatic DAY/NIGHT picture mode settings, see page 65.

⑧ PICTURE-IN-PICTURE button

See separate section on pages 33-34 for a description.

⑨ MENU button

The MENU button will start the On-Screen Display.

⑩ INFO button

Press this button when you want to check the channel being received, the picture source, if the channel has stereo (ST) or second audio program (SAP), the time, CHANNEL ID and if the TIMER is set.

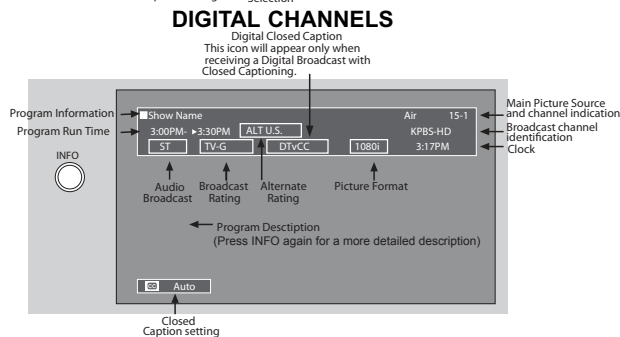
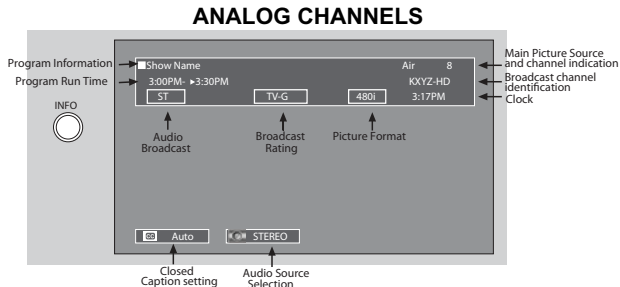

When an S-VIDEO Input is connected to INPUT 1



NOTE: 1. The Sleep Timer info will show momentarily after releasing INFO button.
2. The Aspect setting will not be shown if the channel is locked.

When a Component Video: Y-PbPr Input is connected to INPUT 3

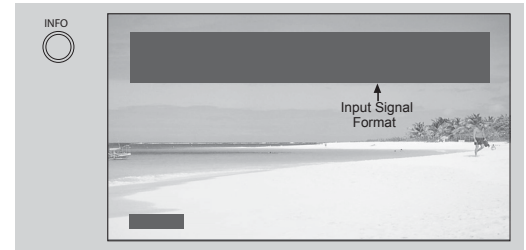

⑪ EXIT button

This button will exit all On-Screen Displays.

⑫ CURSOR PAD/SELECT button

All the On-Screen Display features can be set or adjusted by using the CURSOR PAD, except for numeric entries. The CURSOR PAD will highlight functions or adjust and set different features. Press the CURSOR PAD toward desired direction and press the SELECT button to select.

⑬ GUIDE button

Press this button to access the TV Guide On Screen™ interactive display (see page 53). Press this button to access the Channel Guide of the (CBL), and (SAT/STB) while in (CBL)(SAT/STB) mode.

⑭ INPUTS button

When the remote control is in TV mode, press this button to access the INPUTS menu. Use the CURSOR PAD and SELECT button to select the inputs that are being used. Pressing the INPUTS button repeatedly will also cycle through the Inputs menu items. Then press the SELECT button to select.

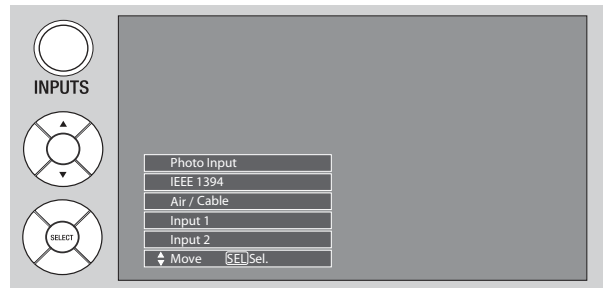

- INPUT 1** Select to choose INPUT 1.
- INPUT 2** Select to choose INPUT 2.
- INPUT 3** Select to choose INPUT 3.
- INPUT 4** Select to choose INPUT 4.
- INPUT 5** Select to choose INPUT 5.
- AIR / CABLE** Select between Cable or Air signal.
- PHOTO INPUT** Select to access your pictures from a digital camera, USB memory or memory card USB drive connected to the Photo Input in the side panel of the Plasma TV (see pages 29-30).
- IEEE1394** Select to choose the IEEE1394 Input only for HDX models (see page 31).

How to Use the Remote to Control Your TV

PHOTO INPUT

This feature is useful for viewing digital still pictures from your digital camera, USB Drive or memory cards USB drive using the Photo Input in the left side panel of the TV.

1. Press the INPUTS button to cycle through the INPUTS selections until the PHOTO INPUT is selected. Press the SELECT button or CURSOR PAD ►.

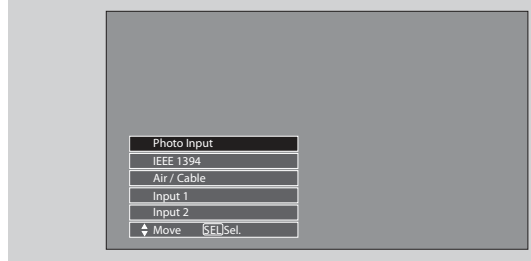

2. Press the CURSOR PAD ◀ or ▶ to access the next or previous photo.

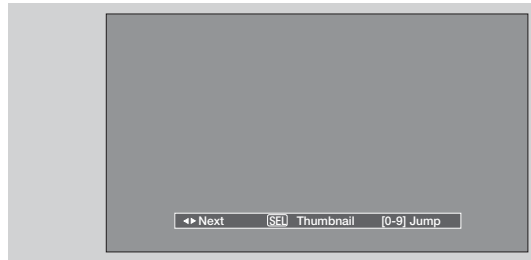

3. Press the SELECT button to view THUMBNAIL.
4. Use the CURSOR PAD buttons ▲, ▼, ◀ or ▶ and the SELECT button to navigate and select individual chosen photos.

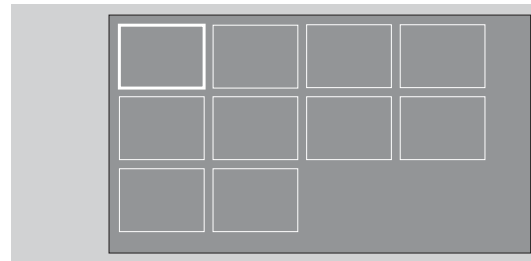

5. Press the picture number to jump from picture to picture.



6. Press the INFO button to access PHOTO Input menu and to view Photo information.
7. Press the CURSOR PAD ▲ or ▼ and the SELECT button to navigate and select the PHOTO Input menu.

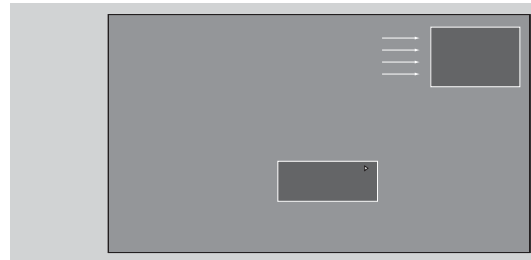

- NOTES:**
1. Contrast will decrease automatically if stationary images such as digital still photos are left on the screen for more than 3 minutes.
 2. The maximum number of digital Photos that can be displayed is 999.
 3. Press INFO button to show Picture Numbers in Thumbnail view, plus other information in individual photos.
 4. Digital photos recorded on a DVD-RAM disc may not work with this Photo Input.
 5. Certain types of digital cameras may not work with this Photo Input.
 6. Digital cameras with low battery power may not properly display your photos in this input.
 7. The screen may show "Input device not detected" if the digital camera's large capacity memory is fully loaded, or because of slow access time on some digital cameras. Please wait 1 or 2 minutes before checking your Photo Input connections.

How to Use the Remote to Control Your TV

ROTATE

Select this menu item to rotate selected photos either clockwise (CURSOR PAD ►) and counterclockwise (CURSOR PAD ◀).

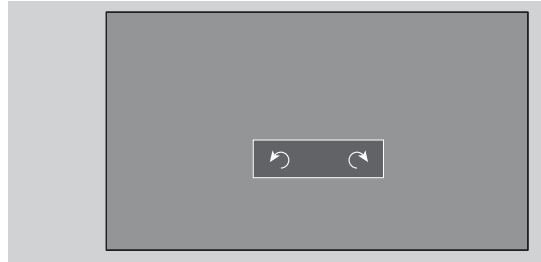

SLIDESHOW

Select this menu item to start a slideshow of the digital photos. While the Interval sub menu is highlighted, press the SELECT button to cycle through the interval time from 5, 10 and 30 seconds. Press the SELECT button to stop on a chosen picture of the slideshow. After 30 seconds, the slideshow will resume or press the SELECT button again to continue with the slideshow.

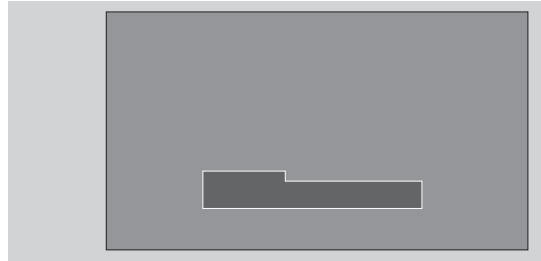

DEVICE

Select this menu item to select the Photo Input Device Drive when using a USB Drive device. Use the CURSOR PAD ◀ or ► to select Device Drive. Press the INFO button to highlight a device, then press the SELECT button or CURSOR PAD ► to access it. Use the CURSOR PAD ◀ or ► to choose the device to read.

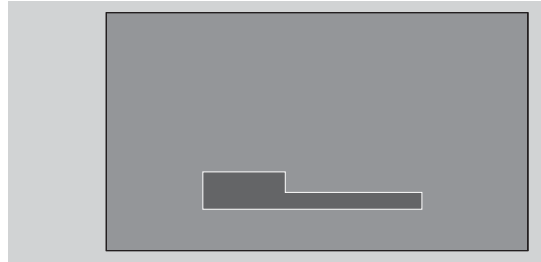

- NOTES:**
1. Automatic contrast reduction also applies during SLIDESHOW, then press any button to continue.
 2. Photo file names modified on a computer should be 8 characters (Ex. ABCD1234.jpg). 1st character: letters; 2nd to 4th: letters or numbers; 5th to 8th: numbers. Photo files should be first placed on a sub directory name with 8 characters (Ex. 123ABCDE). 1st to 3rd: number; 4th to 8th: letters. The sub directory then should be placed on a main directory with a "dcim" file name format.
 3. Supported image types are up to 3072 x 2304; JPEG format should conform with DCF Standard (Design rule for Camera File System).
 4. This TV set displays only digital pictures from digital cameras which meet DCF Standard. Pictures that were copied, edited or modified on a computer may not be displayed on the TV set.

How to Use the Remote to Control Your TV

IEEE1394 (ONLY HDX MODELS)

Use this function to control your devices with digital interface capabilities.

When an IEEE1394 device is not connected

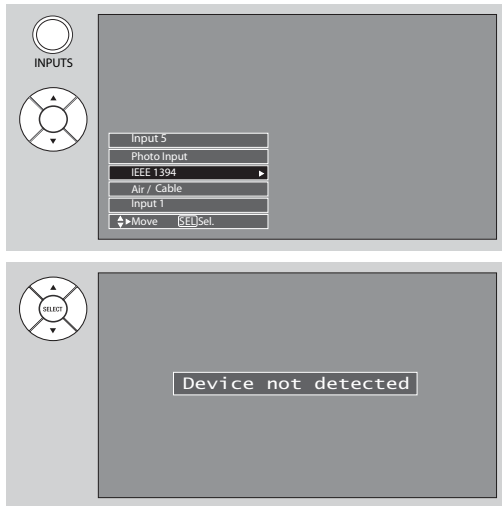

When an IEEE1394 device is connected

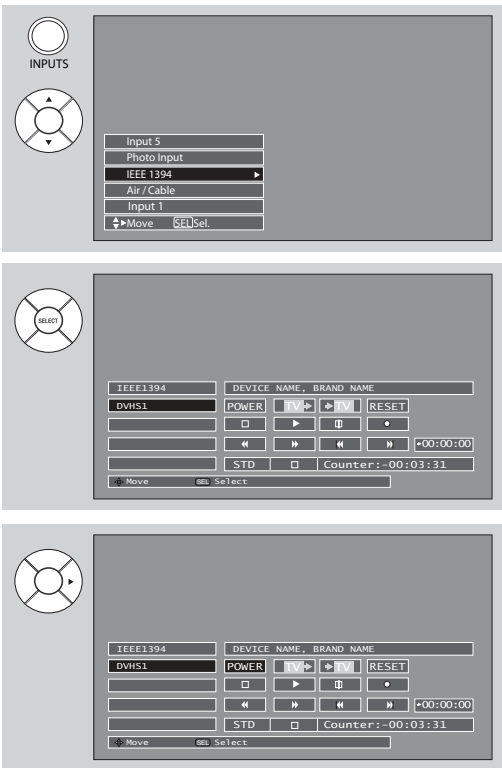

1. Press INPUT button, CURSOR PAD and SELECT button to select IEEE 1394.
2. Use CURSOR PAD ► to select connected device (example D-VHS1).
3. Use CURSOR PAD cursors to highlight POWER.
4. Press the SELECT button to power on the device.
5. Use CURSOR PAD cursors to select D-VHS operation.
6. Press down on the CURSOR PAD to enable the selected operation.
7. Use CURSOR PAD cursors to highlight the TV IN/OUT operation.
8. Press the SELECT button to select:
TV IN is DVHS
TV OUT is Air / Cable

NOTES:

1. The digital device will be automatically recognized if properly connected.
2. Four (4) IEEE1394 devices can be listed on the menu, but only one device at a time can be used. If a fifth device is connected, it will replace the first device on the menu list.
3. The On-Screen display will not disappear until the EXIT button is pressed.
4. Not all devices with IEEE1394 capability are compatible with this TV. Any compatibility problems with other manufacturers devices should be brought to the attention of those manufacturers.
5. TV IN/OUT functions are not available when D-VHS is in playback or recording.
6. Digital channels may contain Copy Control Information (CCI). When using a CableCARD, this CCI data will prevent recording of some programs depending on its content value.

How to Use the Remote to Control Your TV

- ⑮ **LAST CHANNEL (LAST CH) button**
Press this button to toggle between the current and last channel viewed.
- ⑯ **VOLUME (VOL) WHEEL, MUTE button**
Use the VOL WHEEL (▲ or ▼) until you obtain the desired sound level.

To reduce the sound to one half of normal volume (SOFT MUTE) to answer the telephone, etc., press the VOL wheel down. Press the VOL wheel again to turn the sound off completely (MUTE). To restore the sound, press the VOL wheel one more time or VOL Up (▲).

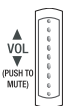

Closed Captioning will display automatically when MUTE/SOFT MUTE is on and Closed Caption is set to AUTO (see page 76).

When the TV power is turned off at a volume level 31 or greater, the volume level will default to 30 when the TV is turned on. However, if it is set to a level 30 or less, the volume level will be at the level it was set when the TV is turned ON.

- ⑰ **CHANNEL (CH) WHEEL/CHANNEL SELECTOR buttons**

The CHANNEL wheel or the CHANNEL SELECTOR buttons are used to select channels, lock access code, etc. Use the CHANNEL WHEEL (▲ or ▼) to select the desired channel. Use the CHANNEL SELECTOR buttons to enter one, two, or three numbers to select channels. Enter "0" first for channels 1 to 9, or simply press the single digit channel you wish to tune then wait a few seconds for the TV to tune. For Digital Channels, use the CHANNEL SELECTOR buttons with the (-) DASH button. Channel selection may also be performed by CHANNEL WHEEL up (▲), CHANNEL WHEEL down (▼) or CURSOR up (▲ CH+) & Cursor down (▼ CH-).

When using the Cursor up or down (▲ CH+ or ▼ CH-) to change channel it will operate same as the CHANNEL WHEEL except for the (FAV) channel setting. The cursor up or down can only change channels; but to activate the (FAV) channels it has to be activated from the CHANNEL WHEEL only.

Press the channel (CH) wheel to switch to Favorite (FAV) channel mode. You will know you are in Favorite Channel mode when (FAV) is displayed and the displayed channel is GREEN. Press it again to return to your regular tuned channels. You can add any channel to your favorite channel list by pressing and holding down the Channel (CH) wheel until the displayed channel turns from WHITE to highlighted GREEN. You can also delete a channel from your favorite channel list by pressing and holding down the Channel (CH) wheel until the displayed channel turns highlighted GREEN to WHITE.



- ⑱ **(-) DASH button**
Use the (-) DASH button with the CHANNEL SELECTOR buttons to enter Digital Channels that have subchannel numbers indicated by (-) DASH (example 15-1).
- ⑲ **BACKLIGHT button**
Press this button to light up and illuminate the buttons of the remote control.

Picture-in-Picture (PIP)

Your HITACHI Plasma TV incorporates one Tuner technology designed for improved viewing enjoyment. This feature allows you to view Digital Channels and Video inputs on both the main picture and sub picture simultaneously, with separate control. When a Digital channel is viewed in the main picture, the Digital or Analog channel can not be viewed in the sub picture. Please see table for PIP availability.

To select between main picture and PIP sub picture, use the CURSOR PAD button the remote. The Green highlighted channel display will move with every press of the CURSOR PAD buttons.

The Picture-in-Picture feature is convenient when you want to watch more than one program at the same time. You can watch a TV program while viewing other programs from any of the video inputs.

Use connection at right to view VCR program as a sub-picture while viewing another program as main picture (CABLE/AIR Digital channel).

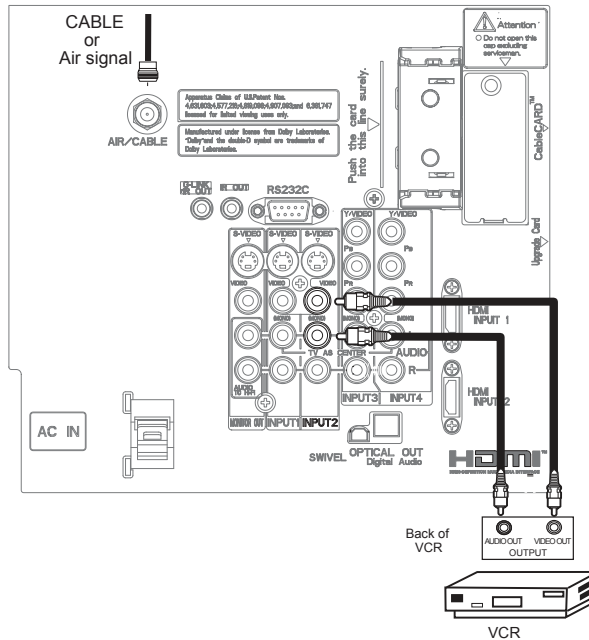

① PIP button

Press the PIP button and a sub-picture will appear in one of the four different modes (POP, PIP, or SPLIT), depending on the INPUT signal. To change the PIP mode, use the PIP button to cycle through the three different modes.

SPLIT MODE PICTURE-IN-PICTURE

Split Mode PIP displays the main picture and sub-picture evenly on the screen.



Main Picture

Sub Picture

POP MODE PICTURE-IN-PICTURE

POP Mode PIP displays the sub-picture outside of the main picture. Use the CURSOR PAD (▲ or ▼) to move the sub-picture. This feature is not available with a 1080i/720p signal. Please refer to the PICTURE-IN-PICTURE MODES Table (see page 34).

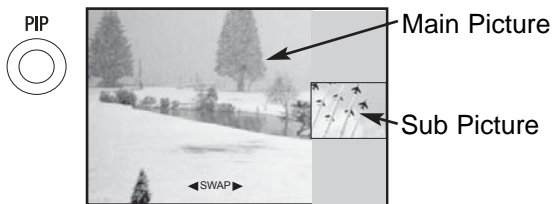

Main Picture

Sub Picture

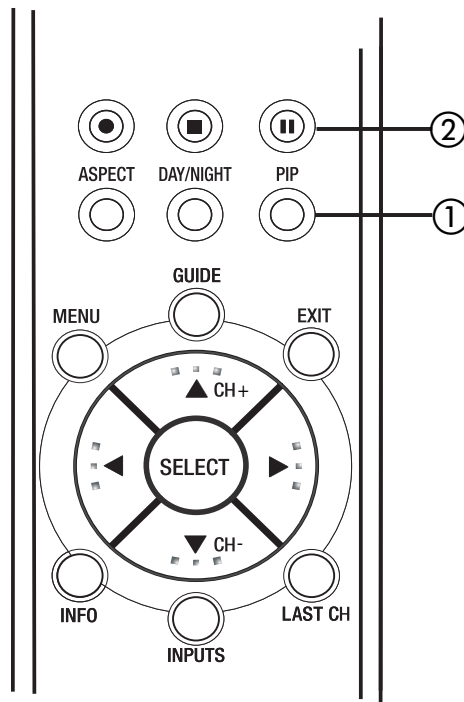

NOTE : 1. Press the CURSOR PAD (◀ or ▶) to enable the sub-picture sound.

Picture-In-Picture (PIP)

PIP MODE PICTURE-IN-PICTURE

Select CABLE/AIR or INPUT 1~5 from the INPUTS menu. Select a channel that has a 1080i/720p signal. To prevent a pattern burn, occasionally move the sub-picture using the CURSOR PAD.



PIP Specifications Table

PIP Mode	Sub Picture		Digital Channel						Component/Composite/S-IN/HDMI						
			1080i		720p		480p		1080i		720p		480p		
			16x9	16x9	16x9	4x3	16x9	4x3	16x9	16x9	16x9	4x3	16x9	4x3	
POP	Digital Ch. (Air or Cable)	1080i 16x9	-	-	-	-	-	-	-	-	-	-	-	-	-
		720p 16x9	-	-	-	-	-	-	-	-	-	-	-	-	-
		480p 16x9	-	-	-	-	-	-	-	-	-	-	-	-	-
		480p 4x3	-	-	-	-	-	-	Yes	Yes	Yes	Yes	Yes	Yes	Yes
		480i 16x9	-	-	-	-	-	-	-	-	-	-	-	-	-
		480i 4x3	-	-	-	-	-	-	Yes	Yes	Yes	Yes	Yes	Yes	Yes
	Component Composite S-IN HDMI	1080i 16x9	-	-	-	-	-	-	-	-	-	-	-	-	-
		720p 16x9	-	-	-	-	-	-	-	-	-	-	-	-	-
		480p 16x9	Yes ¹	Yes ¹	Yes ¹	Yes ¹	Yes ¹	Yes ¹	-	-	-	-	-	-	-
		480p 4x3	Yes	Yes	Yes	Yes	Yes	Yes	-	-	-	-	-	-	-
		480i 16x9	Yes ¹	Yes ¹	Yes ¹	Yes ¹	Yes ¹	Yes ¹	-	-	-	-	-	-	-
		480i 4x3	Yes	Yes	Yes	Yes	Yes	Yes	-	-	-	-	-	-	-
PIP 16x9	Digital Ch. (Air or Cable)	1080i 16x9	-	-	-	-	-	-	Yes	Yes	Yes ²	-	Yes ²	-	
		720p 16x9	-	-	-	-	-	-	Yes	Yes	Yes ²	-	Yes ²	-	
		480p 16x9	-	-	-	-	-	-	Yes	Yes	Yes ²	-	Yes ²	-	
		480p 4x3	-	-	-	-	-	-	-	-	-	-	-	-	
		480i 16x9	-	-	-	-	-	-	Yes	Yes	Yes ²	-	Yes ²	-	
		480i 4x3	-	-	-	-	-	-	-	-	-	-	-	-	
	Component Composite S-IN HDMI	1080i 16x9	Yes	Yes	Yes	-	Yes	-	-	-	-	-	-	-	
		720p 16x9	Yes	Yes	Yes	-	Yes	-	-	-	-	-	-	-	
		480p 16x9	Yes ²	Yes ²	Yes ²	-	Yes ²	-	-	-	-	-	-	-	
		480p 4x3	-	-	-	-	-	-	-	-	-	-	-	-	
		480i 16x9	Yes ²	Yes ²	Yes ²	-	Yes ²	-	-	-	-	-	-	-	
		480i 4x3	-	-	-	-	-	-	-	-	-	-	-	-	
PIP 4x3	Digital Ch. (Air or Cable)	1080i 16x9	-	-	-	-	-	-	-	-	Yes ¹	Yes	Yes ¹	Yes	
		720p 16x9	-	-	-	-	-	-	-	-	Yes ¹	Yes	Yes ¹	Yes	
		480p 16x9	-	-	-	-	-	-	-	-	Yes ¹	Yes	Yes ¹	Yes	
		480p 4x3	-	-	-	-	-	-	-	-	-	-	-	-	
		480i 16x9	-	-	-	-	-	-	-	-	Yes ¹	Yes	Yes ¹	Yes	
		480i 4x3	-	-	-	-	-	-	-	-	-	-	-	-	
	Component Composite S-IN HDMI	1080i 16x9	-	-	-	Yes	-	Yes	-	-	-	-	-	-	
		720p 16x9	-	-	-	Yes	-	Yes	-	-	-	-	-	-	
		480p 16x9	-	-	-	Yes ²	-	Yes ²	-	-	-	-	-	-	
		480p 4x3	-	-	-	-	-	-	-	-	-	-	-	-	
		480i 16x9	-	-	-	Yes ²	-	Yes ²	-	-	-	-	-	-	
		480i 4x3	-	-	-	-	-	-	-	-	-	-	-	-	
SPLIT	Digital Ch. (Air or Cable)	1080i 16x9	-	-	-	-	-	-	Yes	Yes	Yes	Yes	Yes	Yes	
		720p 16x9	-	-	-	-	-	-	Yes	Yes	Yes	Yes	Yes	Yes	
		480p 16x9	-	-	-	-	-	-	Yes	Yes	Yes	Yes	Yes	Yes	
		480p 4x3	-	-	-	-	-	-	Yes	Yes	Yes	Yes	Yes	Yes	
		480i 16x9	-	-	-	-	-	-	Yes	Yes	Yes	Yes	Yes	Yes	
		480i 4x3	-	-	-	-	-	-	Yes	Yes	Yes	Yes	Yes	Yes	
	Component Composite S-IN HDMI	1080i 16x9	Yes	Yes	Yes	Yes	Yes	Yes	-	-	-	-	-	-	
		720p 16x9	Yes	Yes	Yes	Yes	Yes	Yes	-	-	-	-	-	-	
		480p 16x9	Yes	Yes	Yes	Yes	Yes	Yes	-	-	-	-	-	-	
		480p 4x3	Yes	Yes	Yes	Yes	Yes	Yes	-	-	-	-	-	-	
		480i 16x9	Yes	Yes	Yes	Yes	Yes	Yes	-	-	-	-	-	-	
		480i 4x3	Yes	Yes	Yes	Yes	Yes	Yes	-	-	-	-	-	-	
STROBE (4pix)	Digital Ch. (Air or Cable)	1080i 16x9	Yes	-	-	-	-	-	-	-	-	-	-	-	
		720p 16x9	-	Yes	-	-	-	-	-	-	-	-	-	-	
		480p 16x9	-	-	Yes	-	-	-	-	-	-	-	-	-	
		480p 4x3	-	-	-	Yes	-	-	-	-	-	-	-	-	
		480i 16x9	-	-	-	-	Yes	-	-	-	-	-	-	-	
		480i 4x3	-	-	-	-	-	Yes	-	-	-	-	-	-	
	Component Composite S-IN HDMI	1080i 16x9	-	-	-	-	-	-	Yes	-	-	-	-	-	
		720p 16x9	-	-	-	-	-	-	-	Yes	-	-	-	-	
		480p 16x9	-	-	-	-	-	-	-	-	Yes	-	-	-	
		480p 4x3	-	-	-	-	-	-	-	-	-	Yes	-	-	
		480i 16x9	-	-	-	-	-	-	-	-	-	-	Yes	-	
		480i 4x3	-	-	-	-	-	-	-	-	-	-	-	Yes	

Yes¹: Auto Aspect OFF
 Yes²: Auto Aspect ON
 (-): Not available

Picture-In-Picture (PIP)

② PAUSE button

If you wish to freeze the sub-picture, press the PAUSE button. This is convenient when trying to write down the address for a mail order company, recording statistics for a sporting event, etc. To return the picture to motion, press the EXIT button. Press the PAUSE button repeatedly to toggle between FREEZE modes (Main Freeze, SPLIT and STROBE).

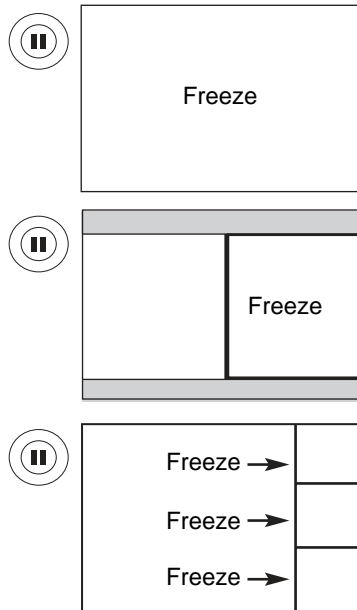

MAIN FREEZE

Press the PAUSE button to freeze one frame of the picture you are currently viewing and the frozen frame will show in the Main Picture. Press the EXIT button to return to normal viewing. This feature is useful for freezing a picture frame with addresses.



SPLIT FREEZE

Press the PAUSE button to freeze the picture you are currently viewing (only the right sub-picture will freeze). Press the EXIT button to return to normal viewing.

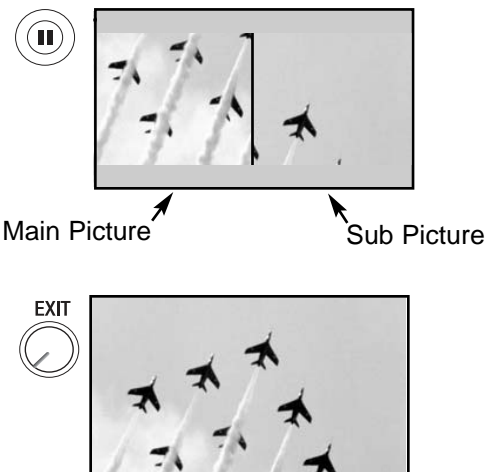

STROBE FREEZE

Press the PAUSE button to freeze three frames of the picture you are currently viewing (only the 3 sub-pictures will freeze). Press the EXIT button to return to normal viewing. This feature is useful for viewing a moving picture that has many details, for example, a close play in a sporting event or a golf swing.

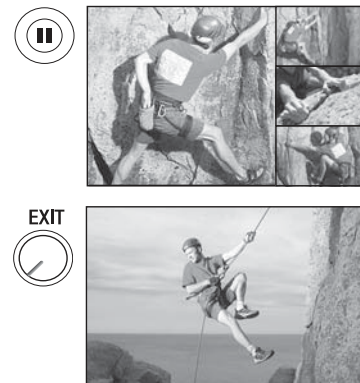

NOTE: 1. The default FREEZE mode is the MAIN freeze followed by the SPLIT freeze and then the STROBE freeze. The last FREEZE mode you selected before you pressed the EXIT button will be the one that comes up after pressing the PAUSE button again.
2. Each freeze frame in Strobe Freeze is delayed about 0.1 (1/10) second.

The Remote Control for Cable Box Functions

Operating the precoded function for your cable box.

This remote is designed to operate different types of cable boxes. You must first program the remote to match the remote system of your cable box (refer to pages 42-43 for pre-codes).

1. Turn ON your cable box.
2. Aim the remote control at the front of your cable box.
3. To switch to Cable (CBL) pre-coded mode, use the SOURCE ACCESS buttons (◀ or ▶) on the remote control to position the LED light to the corresponding selection.
4. Hold down the ENT button on the remote and enter the four digit preset code that matches your cable box as shown on pages 42-43. Release the ENT button. The indicator light will flash 3 times if the code was accepted.
5. Aim the remote at the cable box and press the POWER button. The remote will turn off your cable box when the correct four digit preset code is entered. When this occurs, the remote control is programmed for your cable box. If the cable box does not turn off, try a different four digit preset code.
6. The remote will now control your Cable box.

NOTE: 1. If your cable box cannot be operated after performing the above procedures, your cable box code has not been precoded into the remote.
 2. In the unlikely event that your cable box cannot be operated after performing the above procedures, please consult your cable box operating guide.
 3. The remote control will remember the codes you have programmed until the batteries are removed from the remote control. After replacing the batteries repeat the entire programming procedure as stated above.

- ① **PRECODED CABLE BOX buttons**
These buttons transmit the chosen precoded cable codes.
- ② **EXCLUSIVE TV buttons**
These buttons are for operating the TV.

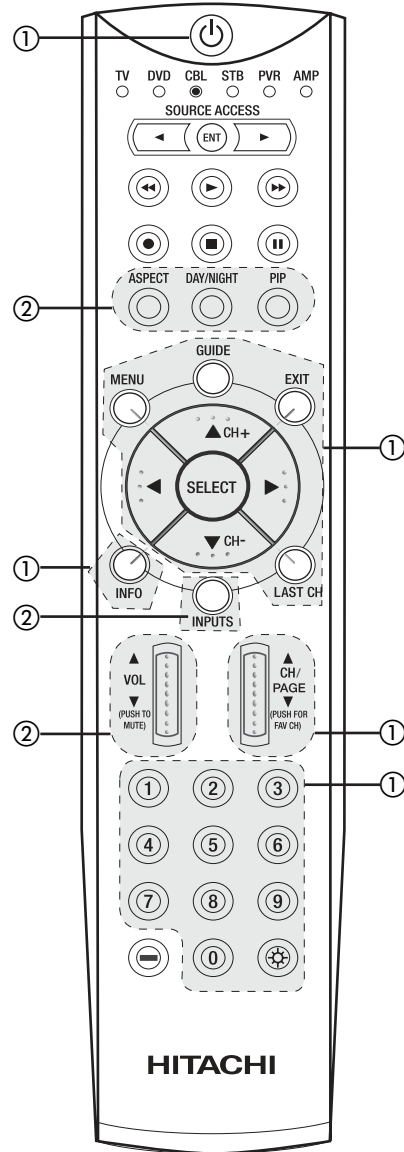

MY CABLE BOX CODE IS: _____

NOTE: Refer to instruction manual of the Cable Box for operation of the buttons exclusively for the Cable Box.

The Remote Control for Set-Top-Box/Satellite Receiver Functions

Operating the precoded function for your set-top-box/satellite receiver.

This remote is designed to operate different types of set-top-box/satellite systems. You must first program the remote to match the remote system of your set-top-box/satellite systems (refer to pages 42-43 for pre-codes).

1. Turn ON your set-top-box/satellite systems.
2. Aim the remote control at the front of your set-top-box/satellite systems.
3. To switch to set-top-box/satellite (STB) pre-coded mode, use the SOURCE ACCESS buttons (◀ or ▶) on the remote control to position the LED light to the corresponding selection.
4. Hold down the ENT button on the remote and enter the four digit preset code that matches your set-top-box/satellite receiver as shown on page 42-43. Release the ENT button. The indicator light will flash 3 times if the code was accepted.
5. Aim the remote at the set-top-box/satellite receiver and press the POWER button. The remote will turn off your set-top-box/satellite receiver when the correct four digit preset code is entered. When this occurs, the remote control is programmed for your set-top-box/satellite receiver. If the set-top-box/satellite receiver does not turn off, try a different four digit preset code.
6. The remote will now control your set-top-box/satellite receiver.

NOTE: 1. If your set-top-box/satellite receiver cannot be operated after performing the above procedures, your set-top-box/satellite receiver code has not been precoded into the remote.

2. In the unlikely event that your set-top-box/satellite receiver cannot be operated after performing the above procedures, please consult your set-top-box/satellite receiver operating guide.

3. The remote control will remember the codes you have programmed until the batteries are removed from the remote control. After replacing the batteries repeat the entire programming procedure as stated above.

- ① **PRECODED SET-TOP-BOX/SATELLITE RECEIVER buttons**
These buttons transmit the chosen pre-coded set-top-box/satellite codes.
- ② **EXCLUSIVE TV buttons**
These buttons are for operating the TV.

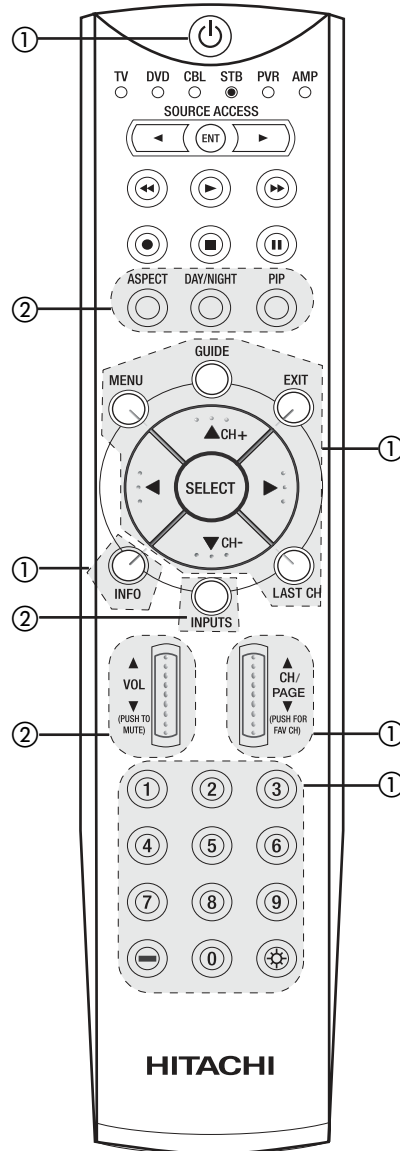

MY Satellite RECEIVER/ SET-TOP-BOX CODE IS: _____

NOTE: Refer to instruction manual of the Set-Top-Box/Satellite Receiver for operation of the buttons exclusively for the Set-Top-Box/Satellite Receiver.

The Remote Control for DVD Functions

Operating the precoded function for your DVD player.

This remote is designed to operate different types of DVD players. You must first program the remote to match the remote system of your DVD player (refer to pages 42-43 for pre-codes).

1. Turn ON your DVD player.
2. Aim the remote control at the front of your DVD player.
3. To switch to DVD pre-coded mode, use the SOURCE ACCESS buttons (◀ or ▶) on the remote control to position the LED light to the corresponding selection.
4. Hold down the ENT button on the remote and enter the four digit preset code that matches your DVD player, as shown on pages 42-43. Release the ENT button. The indicator light will flash 3 times if the code was accepted.
5. Aim the remote at the DVD player and press the POWER button. The remote will turn off your DVD player when the correct four digit preset code is entered. When this occurs, the remote control is programmed for your DVD player. If the DVD player does not turn off, try a different four digit preset code.
6. The remote will now control your DVD player.
7. You will need to set the display type of your DVD player to 16:9 widescreen.

NOTE: 1. If your DVD player cannot be operated after performing the above procedures, your DVD player code has not been precoded into the remote.
 2. In the unlikely event that your DVD player cannot be operated after performing the above procedures, please consult your DVD player operating guide.
 3. The remote control will remember the codes you have programmed until the batteries are removed from the remote control. After replacing the batteries repeat the entire programming procedure as stated above.

- ① **PRECODED DVD Buttons**
 These buttons transmit the chosen precoded DVD codes.
- ② **EXCLUSIVE TV Buttons**
 These buttons are for operating the TV.

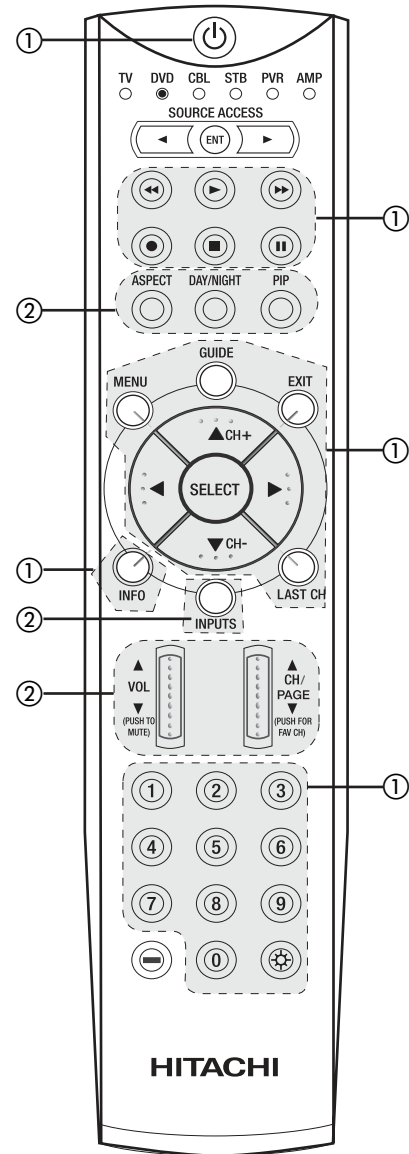

MY DVD PLAYER CODE IS: _____

NOTE: Refer to instruction manual of the DVD Player for operation of the buttons exclusively for the DVD Player.

The Remote for VCR/PVR Functions

Operating the precoded function for your VCR/PVR (Personal Video Recorder).

This remote is designed to operate different types of VCRs/PVRs. You must first program the remote to match the remote system of your VCR/PVR (refer to pages 42-43 for pre-codes).

1. Turn ON your VCR/PVR.
2. Aim the remote control at the front of your VCR/PVR.
3. To switch to VCR/PVR pre-coded mode, use the SOURCE ACCESS buttons (◀ or ▶) on the remote control to position the LED light to the corresponding selection.
4. Hold down the ENT button on the remote and enter the four digit preset code that matches your VCR/PVR, as shown on pages 42-43. Release the ENT button. The indicator light will flash 3 times if the code was accepted.
5. Aim the remote at the VCR/PVR and press the POWER button. The remote will turn off your PVR when the correct four digit preset code is entered. When this occurs, the remote control is programmed for your VCR/PVR. If the VCR/PVR does not turn off, try a different four digit preset code.
6. The remote will now control your VCR/PVR.

NOTE: 1. If your VCR/PVR cannot be operated after performing the above procedures, your VCR/PVR code has not been precoded into the remote.

2. In the unlikely event that your VCR/PVR cannot be operated after performing the above procedures, please consult your VCR/PVR operating guide.

3. The remote control will remember the codes you have programmed until the batteries are removed from the remote control. After replacing the batteries repeat the entire programming procedure as stated above.

- ① **PRECODED VCR/PVR Buttons**
These buttons transmit the chosen precoded VCR/PVR codes.
- ② **EXCLUSIVE TV Buttons**
These buttons are for operating the TV.

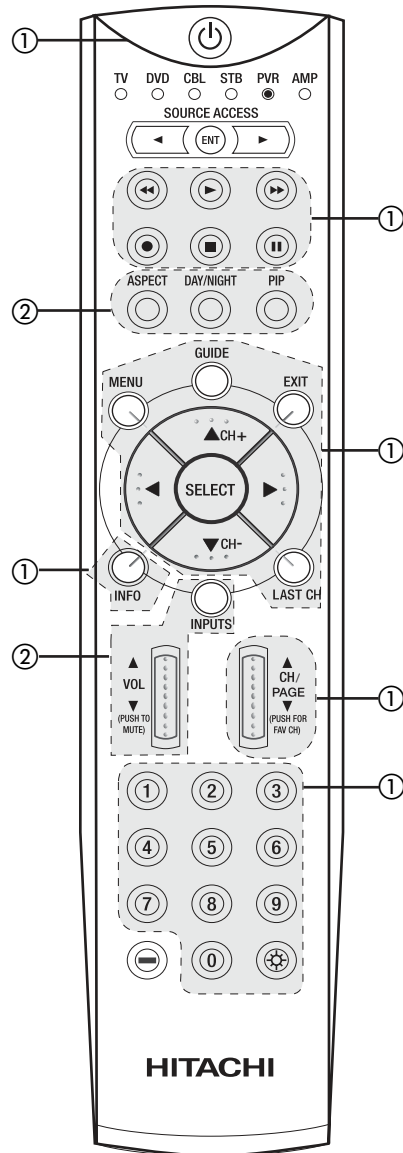

MY VCR/PVR CODE IS: _____

NOTE: Refer to instruction manual of the VCR/PVR for operation of the buttons exclusively for the VCR/PVR.

The Remote Control for Additional Audio Equipment

Operating the precoded function for your Audio component.

This remote is designed to operate different types of Audio component. You must first program the remote to match the remote system of your Audio component (refer to pages 42-43 for pre-codes).

1. Turn ON your Audio component you wish to control with the Remote.
2. Aim the remote control at the front of your Audio component.
3. To switch to Audio (AMP) component pre-coded mode, use the SOURCE ACCESS buttons (◀ or ▶) on the remote control to position the LED light to the corresponding selection.
4. Hold down the ENT button on the remote and enter the four digit preset code that matches your Audio component, as shown on pages 42-43. Release the ENT button. The indicator light will flash 3 times if the code was accepted.
5. Aim the remote at the Audio component and press the POWER button. The remote will turn off your Audio component when the correct four digit preset code is entered. When this occurs, the remote control is programmed for your Audio component. If the Audio component does not turn off, try a different four digit preset code.
6. The remote will now control your Audio component.
7. Repeat steps 1 - 6 if you wish to program the remote to control another Audio component.

NOTE:

1. If your Audio component cannot be operated after performing the above procedures, your Audio component code has not been precoded into the remote.
2. In the unlikely event that your Audio component cannot be operated after performing the above procedures, please consult your Audio component operating guide.
3. The remote control will remember the codes you have programmed until the batteries are removed from the remote control. After replacing the batteries repeat the entire programming procedure as stated above.

- ① **PRECODED AUDIO Buttons**
These buttons transmit the chosen precoded Audio component codes.
- ② **EXCLUSIVE TV Buttons**
These buttons are for operating the TV.

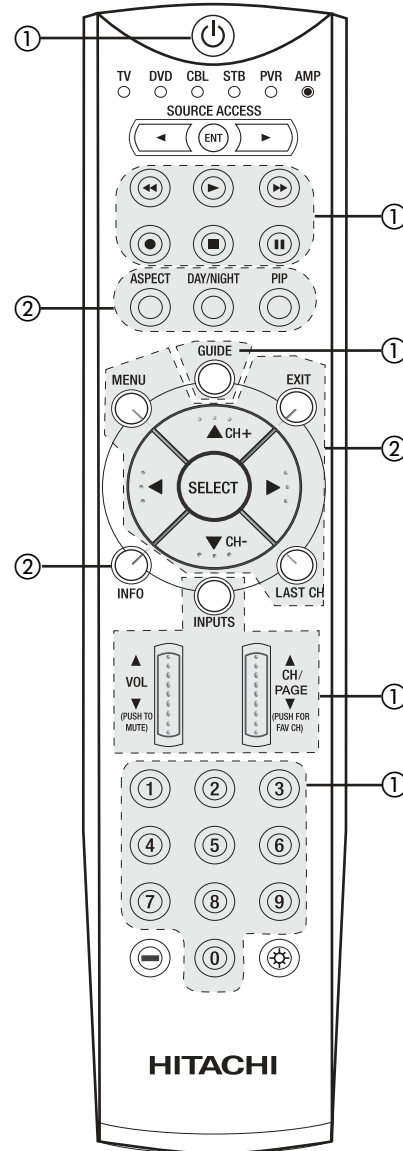

MY AUDIO COMPONENT CODE IS: _____

NOTE: Refer to instruction manual of the VCR/PVR for operation of the buttons exclusively for the VCR/PVR.

How to Use the ENT Button

INPUT ACCESS

This optional feature allows the user of the remote control to setup it's ENTER (ENT) button to access the specified input of the TV. Setup for this feature is applicable to the remote control's normal mode only and only applies to the DVD, CBL, STB, PVR and AMP modes.

1. Select the desired device mode (DVD, CBL, STB, PVR, or AMP) by using your SOURCE ACCESS buttons (◀ or ▶) to position the LED indicator to the corresponding selection.
2. Hold down the ENTER (ENT) button on the remote and enter the four digit preset code that matches your device as shown on pages 42-43.
3. Then enter the assigned input number (1-5) that the device is related to.
4. Release ENTER (ENT) button.
5. If done correctly, the device LED indicator will flash 3 times to confirm proper setup.
6. The remote will now control the desired device.
7. Pressing the ENTER (ENT) button will now access the video input (1-5) of the desired device.

SETUP EXAMPLE (Hitachi DVD with precode 0573 connected to INPUT 1 of the TV)

- ① Select DVD mode by using your SOURCE ACCESS buttons (◀ or ▶) to position the LED indicator to DVD.
- ② Hold down the ENTER (ENT) button and press the numbers 0, 5, 7 and 3.
- ③ Then press the number 1 for the assigned input number of the DVD player.
- ④ Release ENTER (ENT) button.
- ⑤ If done correctly, the device LED indicator will flash 3 times to confirm proper setup.
- ⑥ The remote will now control the DVD player.
- ⑦ Press the ENTER (ENT) button to instantly access the video input of your DVD on Input 1.

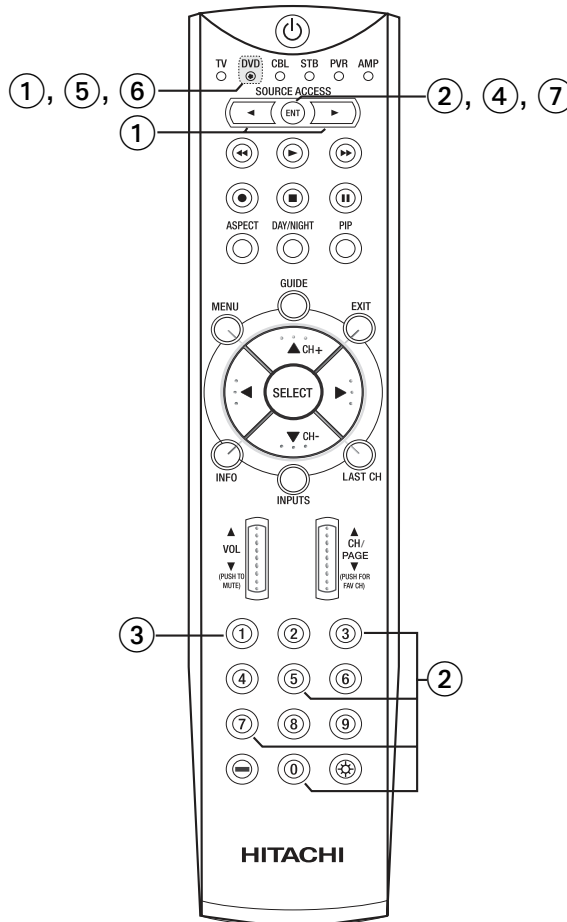

NOTE: 1. This feature is optional
2. Assigned input numbers can be used more than once if applicable.

Remote Control Codes

VCR BRANDCODE

ABS1972
 Admiral0048, 0209
 Adventura0000
 Aiko0278
 Aiwa0000, 0037, 0307
 Akai0041, 0061, 0106
 Alienware1972
 America Action0278
 American High0035
 Asha0240
 Audiovox0037, 0278
 Beaumark0240
 Bell & Howell0104
 Broksonic0121, 0184,
0002, 0209, 0479
 CCE0072, 0278
 Calix0037
 Canon0035
 Carver0081
 Cinerall0278
 Citizen0278, 0037
 Colt0072
 Craig0037, 0072,
0047, 0240, 0271
 Curtis Mathes0035, 0041,
0060, 0162
 CyberPower1972
 Cybernex0240
 Daewoo0278, 0045, 0561
 Dell1972
 Denon0042
 Durabrand0039, 0038
 Dynatech0000
 Electrohome0037
 Electrophonic0037
 Emerex0032
 Emerson0037, 0184, 000, 0121,
 0043, 0209, 0002, 0278, 0061,
 ..0208, 0212, 0479, 0561, 1593
 Fisher0104, 0047, 0066
 Fuji0033, 0035
 Funai0000, 1593
 GE0035, 0060, 0240,
0202, 0761
 Garrard0000
 Gateway1972
 Go Video0432, 0526
 GoldStar0037, 0038
 Gradiente0000, 0008
 HI-Q0047
 HP1972
 Harley Davidson0000
 Harman/Kardon0038, 0081
 Harwood0072
 Headquarter0046
 Hewlett Packard1972
 Hitachi 0000, 0041, 0042, 0105
 Howard Computers1972
 Hughes Network Systems 0042
 iBuy Power1972
 JVC0067, 0041, 0008
 Jensen0041
 KEC0037, 0278
 KLH0072
 Kenwood0041, 0067, 0038
 Kodak0035, 0037
 LG0037
 LXI0037
 Lloyd's0000, 0208
 Logik0072
 MEI0035
 MGA0043, 0240, 0061
 MGN Technology0240
 MTC0000, 0240
 Magnasonic0593
 Magnavox0035, 0081, 0563,
 0000, 0039, 0593
 Magnin0240
 Marantz0081, 0035

Marta0037
 Matsushita0035, 0162, 1162
 Media Center PC1972
 Memorex0035, 0162, 0037,
0048, 0039, 0047, 0240,
0000, 0104, 0209, 0046,
 ..0307, 0479, 1037, 1162, 1262
 Microsoft1972
 Mind1972
 Minolta0042, 0105
 Mitsubishi0061, 0043, 0067
 Motorola0035, 0048
 Multitech0000, 0072
 NEC0038, 0041, 0067, 0104
 Nikko0037
 Noblex0240
 Northgate1972
 Olympus0035
 Optimus0593, 1062, 0162,
0037, 0048, 0104, 0432,
1048, 1162, 1262
 Optonica0062
 Orion0184, 0209, 0002, 0479
 Panasonic0162, 1062, 0035,
0616, 1162, 1262
 Penney0035, 0037, 0240, 0042,
0038
 Pentax0042, 0105
 Philco0035, 0209, 0479, 0561
 Philips0081, 0035, 0618,
1081, 1181, 0062
 Pilot0037
 Pioneer0067
 Polk Audio0081
 Profitronic0240
 Proscan0060, 0202, 0761
 Protec0072
 Pulsar0039
 Quarter0046
 Quartz0046
 Quasar0035, 0162, 1162
 RCA0060, 0240, 0042, 0105,
0106, 0202, 0761, 0880
 Radio Shack0000, 1037
 Radix0037
 Randex0037
 Realistic0035, 0037, 0048,
0047, 0000, 0104, 0046,
0062, 0066
 ReplayTV0614, 0616
 Runco0039
 STS0042
 Samsung0045, 0240, 0432
 Sanky0039, 0048
 Sansui0000, 0067, 0209,
0041, 0479, 1479, 0271
 Sanyo0047, 0240, 0104, 0046
 Scott0184, 0045, 0121,
0043, 0210, 0212
 Sears0035, 0037, 0047, 0000,
 0042, 0104, 1237, 0046, 0066,
0105
 Semp0045
 Sharp0048, 0848, 0062
 Shintom0072
 Shogun0240
 Singer0072
 Sonic Blue0614, 0616
 Sony0035, 0032, 0000,
0033, 0636, 1032, 1972
 Sylvania0035, 0081, 0000,
0043, 0593, 1593
 Symphonic0000, 0593, 1593
 Systemax1972
 TMK0240, 0208
 Tagar Systems1972
 Tatung0041
 Teac0000, 0041
 Technics0035, 0162
 Teknika0000, 0035, 0037

Thomas0000
 Tivo0618, 0636, 1503
 Toshiba0045, 0043, 0066,
0210, 0212, 0366, 0845,
1008, 1145, 1503, 1972
 Totevision0037, 0240
 Touch1972
 Unitech0240
 Vector0045
 Vector Research0038
 Video Concepts0045, 0061
 Videomagic0037
 Videosonic0240
 Viewsonic1972
 Wards 0060, 0062, 0035, 0048,
0047, 0081, 0240, 0000,
0042, 0072, 0212
 White Westinghouse0072, 0209
 XR-10000072, 0000, 0035
 Yamaha0038
 ZT Group1972
 Zenith 0039, 0000, 0209, 0033,
0479, 1479

DVD BRANDCODE

AMW0872
 Aiwa0641
 Allegro0869
 Apex Digital0672, 0717, 0755,
 0794, 0796, 0797, 1004, 1020,
 ..1056, 1061, 1100, 1915, 1937
 Audiovox0790, 1072
 Axion1072
 Blaupunkt0717
 Blue Parade0571
 Brooksonic0695
 CAVS1057
 CineVision0876, 0869
 Classic1917
 Coby1086
 Curtis Mathes1087
 CyberHome0816, 1023, 1024
 DVD20000521
 Daewoo0784, 0705,
0833, 0869, 1918
 Denon0490, 0634
 Dual1068, 1085
 Emerson0591, 0675
 Enterprise0591
 Fisher0670
 Funai0675
 GE0522, 0717, 0815
 GPX0699, 0769
 Gateway1073
 Go Video0744, 0715, 0783,
0833, 0869, 1075
 Gradiente0651
 Greenhill0717
 Grundig0705
 Harman/Kardon0702
 Hitachi0573, 0664, 0695
 Hiteker0672
 IRT0783
 Initial0717
 Integra0627
 Hiteker0672
 JBL0702
 JVC0623, 0558, 0867, 1901
 KLH0717, 0790, 1020
 Kawasaki0790
 Kenwood0490, 0534
 Koss0651
 Lasonic0798
 Lite-On1058
 Magnavox0503, 0675,
1914, 1976
 Marantz0539
 Memorex0695
 Microsoft0522

Mintek0717, 0839
 Mitsubishi0521, 1521
 Nesa0717
 Norcent1003, 0872
 Onkyo0627, 0503
 Oritron0651
 Panasonic0490
 Philco0790
 Philips0503, 0539, 0646, 0854
 Pioneer0525, 0571, 1902
 Polaroid1061, 1086
 Polk Audio0539
 Proscan0522
 Qwestar0651
 RCA0522, 0571, 0717,
0790, 0822, 1974
 Recco0698
 Rio0869
 Rotel0623
 Rowa0823
 Sampo0698, 0752
 Samsung0490, 0573,
0820, 0744, 1075
 Sansui0695
 Sanyo0670, 0695, 0873
 Semp0503
 Sharp0630, 0752
 Shinsonic0533, 0839
 Sonic Blue0869
 Sony0533
 Sylvania0675
 Symphonic0675
 TYT0705
 Teac0790
 Technics0490
 Theta Digital0571
 Tivo1996
 Toshiba0503, 0695, 1045,
1988, 1996, 2006
 TreDEX0799, 0803
 US Logic0839
 Urban Concepts0503
 Venturer0790
 XBox0522
 Yamaha0490, 0545, 0539
 Zenith0591, 0503, 0869

CABLE BRANDCODE

ABC0003, 0008, 0011, 0013,
0014, 0017
 Allegro0153, 0315
 Americast0899
 Antronix022
 Archer022, 0153, 0797
 Bell & Howel0014
 Bell South0899
 Cabletenna0022
 Cableview0022
 Century0153
 Citizen0153, 0315
 ClearMax0883
 Clearmaster0883
 Colour Voice0025, 0031
 Comtronics0040
 Contec0019
 Coolmax0883
 Digi0637
 Director0476
 Dumont0637
 Emerson0797
 Everquest0015, 0040
 Focus0400
 Garrard0153
 Gemini0015, 0797
 General Instrument 0003, 0011,
0476, 0276, 0810
 GoldStar0040, 0144
 Goodmind0797
 Hamlin 0009, 0020, 0034, 0273
 Hitachi0011

Remote Control Codes

Jasco0015, 0153, 0315
 Jerrold 0003, 0011, 0012,
 0014, 0015, 0024, 0276, 0476,
0810
 Memorex0000
 Motorola 0276, 0476, 0810,
1106, 1254, 1376
 Movie Time0063
 Multivision0012
 NSC0063
 Novaplex0618
 Oak0019
 Optimus0021
 Pace0237, 1877
 Panasonic.....0000, 0021, 0107
 Panther0637
 Paragon0000
 Philips0305, 0317
 Pioneer0023, 0025, 0031, 0153,
0144, 0533, 0877, 1877
 Popular Mechanics0400
 Pulsar0000
 Quasar0000
 RCA0021
 RadioShack ..0015, 0315, 0797,
0883
 Recoton0400
 Regal0020, 0273, 0279
 Rembrandt0011
 Runco0000
 SL Marx0040
 Samsung0040, 0144
 Scientific Atlanta ...0877, 0008,
0017, 0477, 1877
 Signal0015, 0040
 Signature0011
 Sony1006
 Sprucer0021
 Starcom0003, 0015
 Stargate0015, 0040, 0797
 Starquest0015
 Supercable0276
 Supermax0883
 TFC0310
 TV860063
 Tandy0258
 TeleCaption0221
 Television0040
 Timeless0040
 Tocom0012, 0013
 Torx0003
 Toshiba0000
 Tristar0883
 Tusa0015
 Unika0022, 0153
 Universal0022, 0153, 0191
 V20883
 ViewMaster0883
 Viewstar0063, 0258
 Vision0883
 Vortex View0883
 Zenith ..0000, 0054, 0525, 0899
 Zentek0400

SATELLITE BRAND (Set-Top-Box)CODE
 AlphaStar0772
 Amway0043, 0075
 Astro Industries.....0095
 BSR0095
 Cable Innovations.....0554
 Capetronic0095
 Century0856
 Channel Master0018, 0212
 Chapparral0053, 0209, 0216
 Conifer0004
 Crossdigital1109
 Curtis Mathes061
 DX Antenna0041
 DirecTV0392, 0566, 0639,

.....1639, 1142, 0247, 0749,
1749, 0724, 0819, 1856,
1076, 1109, 0099, 1052,
 ..1053, 1054, 1442, 1443, 1444
 Dish Network System1005,
 0775, 1170
 DishPro1005, 0775
 Drake0018, 0064, 0245
 EchoStar1005, 0775, 0148,
0269, 0280, 1170
 Expressvu0775
 GE0566
 GOI0775
 General Instrument0869,
0547, 0554
 Gradiente0856
 HTS0775
 Hitachi0819
 homecable0238
 Hughes Network Systems 1142,
 ..0749, 1749, 1442, 1443, 1444
 Hytek0095
 IQ0210
 IQ Prism0210
 Innova0099
 Intersat0043
 JVC0775, 1170
 Janeil0152
 Legend0269
 Macom0018, 0061
 Magnavox0724, 0722
 Memorex0724, 0269
 Mitsubishi0749
 Motorola0869
 Netsat0099
 Next Level.....0869
 Norsat0004
 Pace0455
 Panasonic.....0247, 0701, 0152
 Paysat0724
 Philips 1142, 0749, 0724, 1076,
0722, 1749, 0856, 0099
 Pico0075
 Proscan0392, 0566
 RCA0392, 0566, 0855, 0143
 Radioshack.....0869, 0554
 Ramsey0075
 Realistic0052
 SKY0856, 1856, 0099
 STS0041, 0210
 Samsung1276, 1109
 Sony0639, 1639
 Star Choice.....0869
 Star Trak.....0180, 0421, 0547
 Strong0421
 Tivo1142, 1442, 1443, 1444
 Toshiba0749, 1749, 0790,
0061, 0082, 1052, 1053,
 ..1054, 1285, 1286, 1287, 1289
 Town & Country0547
 Uniden0724, 0722, 0052, 0074,
0076, 0238, 0370, 0554
 Zenith ..0856, 1856, 0061, 0064

AMPLIFIER BRANDCODE
 Aiwa0406
 Bose0674
 Carver0269
 Curtis Mathes0300
 Denon0160
 Durabrand.....1561
 GE0078
 Harman/Kardon0892
 JVC0331
 Left Coast0892
 Lenox1561
 Linn0269
 Luxman0165
 Magnavox0269
 Marantz0269, 0321, 0892

NEC0264
 Nakamichi0321
 Optimus0395, 0300
 Parasonic.....0308, 0521
 Parasound0246
 Philips0269, 0892
 Pioneer0013, 0300
 Polk Audio0269, 0892
 RCA0300
 Realistic0395
 Sansui0321
 Shure0264
 Sony0815, 0689, 0220
 Soundesign0078, 0211
 Technics0308, 0521
 Toshiba0353
 Victor0331
 Wards0013, 0078, 0211
 Yamaha0354, 0133

RECEIVER BRAND (Amplifier) CODE

ADC0531
 Aiwa...1405, 0121, 0158, 0189,
 0405
 Anam1074, 1609
 Arcam1120
 Audiotronic1189
 Bose0639, 1229, 1253
 Capetronic0531
 Carver1189, 0042, 0189
 Casio0195
 Clarinette0195
 Coby1263
 Compaq1136
 Curtis Mathes0080
 Dell1383
 Denon0004, 1360
 Fisher0042
 Garrard0463
 Glory Horse1263
 Harman/Kardon0891, 0110,
 0189
 Hewlett Packard1181
 Hitachi0228
 Integra0135
 JBL0110
 JVC0074, 1263
 KLH1428
 Kenwood1313, 1570, 1569,
0027, 0042, 0186, 0239
 LXI0181
 Linn0189
 Lloyd's.....0195
 MCS0039
 Magnavox1189, 1269, 0189,
 0195, 0391, 0531
 Marantz1189, 0039, 0189, 1269
 Mitsubishi1393
 Modulaire0195
 Musicmagic.....1089
 Nakamichi0097
 Onkyo0135, 0842
 Optimus1023, 0042, 0080,
0177, 0181, 0186, 0219,
 ..0531, 0670, 0738, 0801, 1074
 Panasonic1518, 0039, 0309,
 0367
 Penney0195
 Philips1189, 1269, 0189,
0391, 1120
 Pioneer1023, 0014, 0080,
0150, 0244, 0531, 0630
 Polk Audio.....0189
 Proscan1254
 Quasar0039
 RCA1023, 1254, 0080,
0531, 1074, 1609
 Radio Shack1263
 Realistic0181, 0195

Rio1383
 Sansui0189
 Sanyo0801, 1251
 Scott0163, 0322
 Sharp0186
 Sharper Image1263
 Sherwood0491, 0502
 Sonic Blue1383
 Sony ..1058, 1441, 1759, 0158,
0474, 1349, 1406, 1442
 Soundesign0670
 Stereophonics1023
 Sunfire1313
 Teac0463, 1074
 Technics1308, 1518,
0039, 0309
 Thorens1189
 Toshiba1572
 Victor0074
 Wards .0014, 0080, 0158, 0189
 Yamaha0176, 0186, 1176
 Yorx0195
 Zenith0857

AUDIO BRANDCODE

Aiwa0010, 0159
 AudioSource0351
 Cambridge Soundworks ...0351
 Carver0351
 Fisher0052
 Fosgate0259
 Harmon/Kardon0477
 JBL0477
 JVC0073
 KLH0351
 Magnavox0325
 Nikko0376
 Paramount Pictures 0317, 0351
 RCA0056
 SSI0317
 Sansui0325
 Schneider0376
 Sony0010, 0576
 Soundesign0376
 Yorx0376

SET TOP BOX BRAND ..CODE

Panasonic1120
 Pioneer1010
 Princeton.....0113, 0295
 Samsung1190
 Sensory Science1126
 Sharp1010
 Sony0639

PERSONAL VIDEO

RECORDER BRAND.....CODE

Panasonic0616
 Philips0618
 ReplayTV0614, 0616
 SonicBlue0614, 0616
 Sony0636
 Tivo0618, 0636

The Simple Remote Control

HITACHI has provided a second remote control for your convenience. The Simple Remote Control has the basic features that are most often used (Only for HDX models).

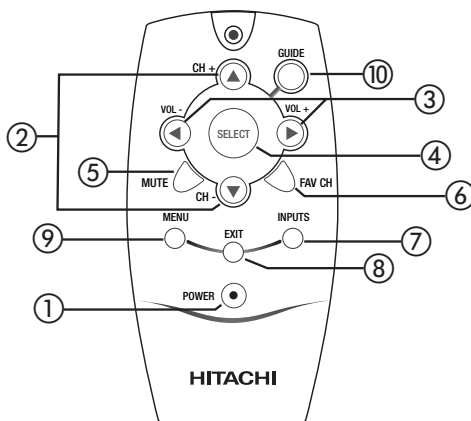

- ① **POWER button**
Press Power button to turn the Plasma Television ON or OFF.
- ② **CH+ (▲) and CH- (▼)**
Press the CH+ (▲) up or CH- (▼) down buttons to select desired channel or to navigate the on screen display features when in **GUIDE** mode.
- ③ **VOL- (◀) and VOL+ (▶)**
Press the VOL- (◀) down or VOL+ (▶) up buttons to select desired sound level or to navigate the on screen display features when in **GUIDE** mode.
- ④ **SELECT button**
Press SELECT button to Select when in MENU and **GUIDE** mode.
- ⑤ **MUTE button**
To reduce the sound to one half of normal volume (SOFT MUTE) to answer the telephone, etc., press the MUTE button. Press the MUTE button again to turn the sound off completely (MUTE). To restore the sound, press the MUTE button one more time, or press the VOLUME Up (▶) button.
- ⑥ **FAV CH button**
Press FAV CH button to access your favorite channels.
- ⑦ **INPUTS button**
Pressing the INPUTS button repeatedly will cycle through the input items (see example on page 28).
- ⑧ **EXIT button**
When in MENU mode, this button will exit all On-Screen Displays.
- ⑨ **MENU button**
Press the MENU button to start the On-Screen Display.
- ⑩ **GUIDE button**
Press this button to access the TV Guide On-Screen™ system. (See complete explanation and example on page 53.)

NOTE: The Simple Remote cannot be programmed to control external components.

On-Screen Display

1. Press MENU on the remote control to display the different features on your HITACHI Plasma TV.
2. Use the CURSOR PAD (buttons ▲, ▼, ◀ and ▶) or CHANNEL WHEEL to navigate to a different menu item.
3. Press EXIT on the remote control to quickly exit from a menu.

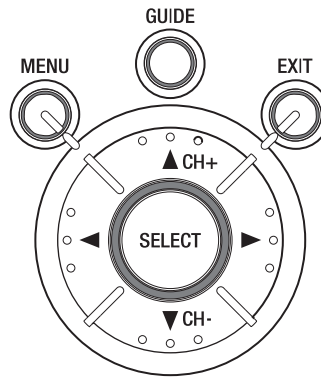

This part of the screen shows which selections are available.

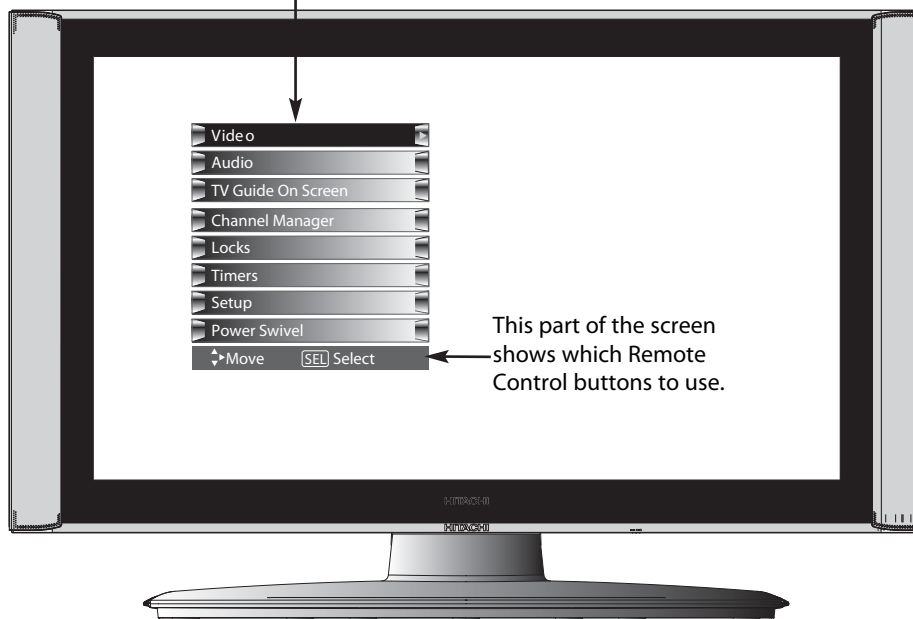

This part of the screen shows which Remote Control buttons to use.

Video

Picture Mode	Select between 3 pictures modes; Day (Dynamic), Day (Normal) and Night.
White Level*	Adjust picture white level.
Black Level**	Adjust picture black level.
Color	Adjust color.
Tint	Adjust tint.
Sharpness	Adjust sharpness.
Color Temperature	Set this to High for less intense color with more blue, set to Medium for natural color, set to Standard for standard colors or Black and White for more reddish color.
Black Enhancement	Enhance picture brightness in light scenes.
Contrast Mode	Use this function to choose between 2 Contrast Mode settings.
Noise Reduction	Reduces conspicuous noise in the picture.
Auto Movie Mode	Turn On/Off the 3:2 Pulldown detection feature.

Color Management	Adjust and balance individual colors to make either deeper or more pure according to preference.
Color Decoding	Adjust the percentage of Red, Green and Color according to preference.
Auto Color	The AUTO COLOR function automatically monitors and adjusts the color to maintain constant color levels even after a program or channel changes. It also maintains natural flesh tones while preserving fidelity of background colors.
White Balance	Use this function to adjust the dark end (Cutoff) and bright end (drive) of the White background.
Black Side Panel	Set the gray side bars On/Off when watching 4:3 signals in standard mode.
Aspect	Choose the picture format aspect ratio.
Reset Video Settings	Choose to Reset Video Settings to factory settings.

* and ** For HDX Model Only (HDT models use typical Contrast and Brightness Level Controls).

On-Screen Display

Audio

Treble	Adjust the treble.
Bass	Adjust the bass.
Balance	Adjust the balance.
Surround	Select Surround settings (Off, Wide, Normal)
Bass Boost	Select Bass Boost option ON or OFF.
Audio Source	Select between three Audio Sources.
Internal Speakers	Select internal or external speakers.
Auto Noise Cancel	Eliminates the noise between stations.
Perfect Volume	Adjust volume in fixed setting.
Loudness	Adjust Loudness.
Language	Select Language options if available.
Digital Output	Select Optical Output options.
DRC	Select Dynamic Range Compression to ON or OFF.

NOTE: The Language, Digital Output, and the Dynamic Range Compression feature of the Audio OSD are only available for Digital channels.

TV Guide On Screen

TV Guide On Screen Set, Control and navigate the system

Channel Manager

Signal Meter	Access Signal Meter.
Auto Channel Scan	Set Auto Channel Scan.
Channel List	Set Channel List.

Locks

Change Access Code	Change Lock access code.
Engage Lock	Choose to lock channel, and/or Side panel.
Movie Ratings	Block various types of movies and video types based on motion picture ratings.
TV Ratings	Block various types of movies and television programming based on a parental guide ratings.
Canadian Ratings (ENG)	Block various types of movies and television programming based on the Canadian ratings system.
Canadian Ratings (FRN)	Block various types of movies and television programming based on the Canadian French ratings system.
Alternate Ratings U.S.	Ratings system for DTV Signal to block various types of programs

Timers

Set the Clock	Set Clock Settings.
Set Sleep Timer	Set Sleep Timer intervals (30 min. intervals, 00:30-3:00).
Set Day/Night Timer	Set Day/Night picture mode settings.

Setup

Set The Menu Options	Choose English, French, or Spanish text and Background.
Set The Screen Saver	Select Screen Saver options to prevent screen burn.
Set The Inputs	Label Video Inputs, VCR, DVD, etc.
Set The AV Net *	Set AV NET Wizard
Set The Closed Captions	Feature to display dialogue/text.
Set The Output Terminals	Set Output source options.
CableCARD Information	Access important CableCARD and Diagnostics info.
Set The Quick Start Options	Select the TV Quick Start Up options.
Reset The Software	Select to upgrade TV software.

Power Swivel

Unlocked	Power Swivel enabled. Control the motorized Table Top Stand
Locked	Power Swivel disabled.

NOTE: 1. The Signal Meter feature of the Channel Manager OSD is only available for Digital channels.
 2. The CableCARD information feature of the Setup OSD is only available when a CableCARD from your cable operator is installed in the rear panel of the TV.
 3. Power Swivel feature is only available when Table Top Stand is connected.

* Only HDX model

Real OSD Appearance for HDT/HDX model is as shown below:

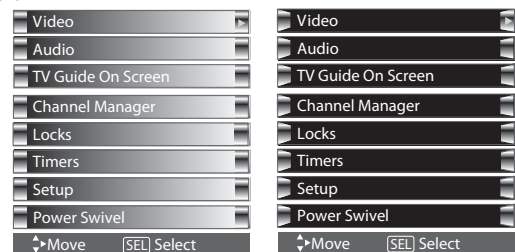

HDT

HDX

Video

Select VIDEO to adjust picture settings and improve picture quality. You can independently customize each of the Video Inputs to your preference to increase viewing performance and pleasure depending upon the video program being viewed. If RESET is selected, only the selected input will reset to initial conditions.

Picture Mode

Use this function to choose from automatic picture settings to optimize your TV's performance.

1. Use the **CURSOR** buttons ◀ or ▶ to highlight and select **PICTURE MODE** settings (Day-Normal, Day-Dynamic or Night).
2. Then press the **SELECT** button to set the mode and return to the Video menu or press **EXIT** to quit menu.
3. There are 3 Picture Modes available for the customer Day (Dynamic) , Day (Normal) and Night mode. Day (Dynamic) is the original factory preset mode , this can be changed by adjusting any video setting to your desire conditions. Day (Normal) can be used as a second video setting for daytime viewing. Night is set to watch programing during nighttime.

1. Use the **CURSOR PAD** ▲ or ▼ or CHANNEL WHEEL to highlight the function to be adjusted.
2. Press the **SELECT** button or the CURSOR PAD ▶ to select the function settings.
3. Press the **CURSOR PAD** ◀ or ▶ to adjust the function.
4. Press **MENU** to return to main menu.
5. Press **EXIT** to quit menu.

Contrast*

Use this function to change the contrast between black and white levels in the picture.

Brightness*

Use this function to adjust overall picture brightness.

White Level**

Use this function to change the white level in the picture.

Black Level**

Use this function to change the black level in the picture.

Color

Use this function to adjust the level of color in the picture.

Tint

Use this function to adjust flesh tones so they appear natural.

Sharpness

Use this function to adjust the amount of fine detail in the picture.

* HDT models only/ ** HDX models only

Example : HDX model video menu.

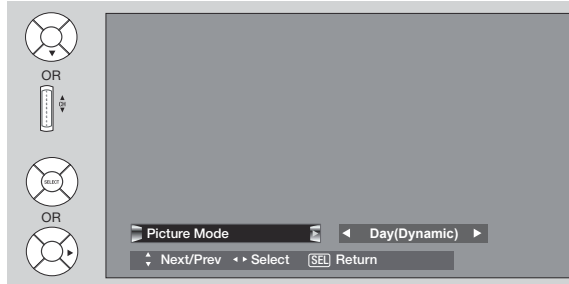
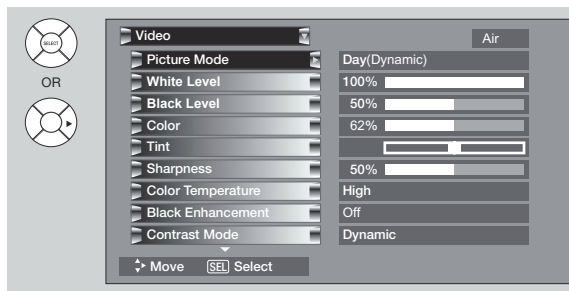

Example : HDT model video menu.

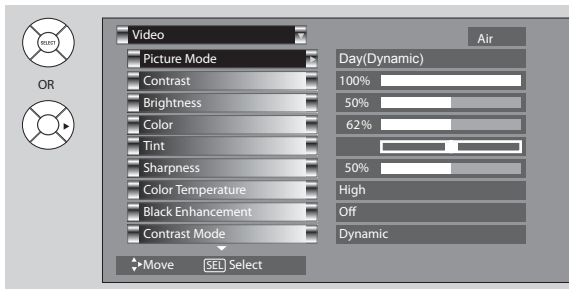
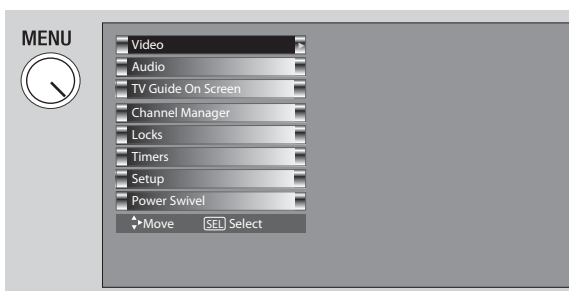

Video

Color Temperature

Set this to High for cooler color with more blue, set to Medium for more natural color, set to Standard for accurate color or set to Black/White for more reddish color (B/W only for HDX models).

Black Enhancement

Use this function to enhance the shadow detail in dark scenes using the settings off, low, middle and high.

- NOTE:** 1. If **CONTRAST** is selected, you are adjusting **CONTRAST**. The additional menu items **BRIGHTNESS**, **COLOR**, **TINT**, and **SHARPNESS** can be selected and adjusted in the same manner.
2. It may be necessary to adjust **TINT** to obtain optimum picture quality when using the **COMPONENT VIDEO Y-PbPr** input jacks.
3. **CABLE** and **AIR** share a Video setting. Also, each of the video inputs have their own independent settings.

Contrast Mode

Use this function to choose between 2 Contrast Mode settings. Set to Dynamic for darker images more in the level of Black, set to Normal for a balanced White to Black level.

Noise Reduction

The **NOISE REDUCTION** function automatically reduces conspicuous noise in the picture without degrading picture quality. Set **NOISE REDUCTION** to **OFF** if the TV experiences picture blocking.

Auto Movie Mode

The **AUTO MOVIE MODE** function turn ON or OFF the 3:2 PULLDOWN DETECTION SPECIAL FEATURE. Theatrical movies are shot on film at 24 frames or still pictures per second, instead of 30 frames or 60 fields like video. When film is transferred to video for television viewing, the disparity between the two frame rates must be reconciled. This involves a process known as 3:2 pulldown.

When **AUTO MOVIE MODE** is turned ON from the VIDEO menu, your Hitachi Plasma Television will activate the circuitry for this special feature to improve video performance when watching film based sources.

- NOTE:** 1. When using a Progressive Scan Component or HDMI Input (480p or 720p), **AUTO MOVIE MODE** will not be available
2. All Video settings are independent of each other based on it's input (Cable/Air, Input 1-5).

Color Management

Use this function to adjust and balance the listed individual colors to make them either deeper or more pure depending on the user's preference. Adjust the GAIN settings to make the color brighter (+) or darker (-). Adjust the PHASE settings to make the colors deeper (+) or normal (-) to match real life colors.

1. Use **CURSOR PAD ▲** or **▼** or **CHANNEL WHEEL** to
2. Press the **SELECT** button or **CURSOR PAD ►** to select Set User Colors setting. When the function has a "✓" in the box called "Set User Colors", it is ON.
3. Press the **CURSOR PAD ◀, ▶, ▼, ▲** and **SELECT** button to highlight and adjust individual colors.
4. Use the **CURSOR PAD ▲** and **▼** to highlight and select "Reset" then press the **SELECT** button to return all colors to default settings.

NOTE: When the Set User Colors box is not checked, the listed colors will be grayed out.

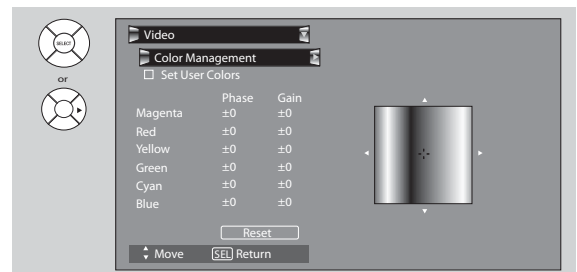
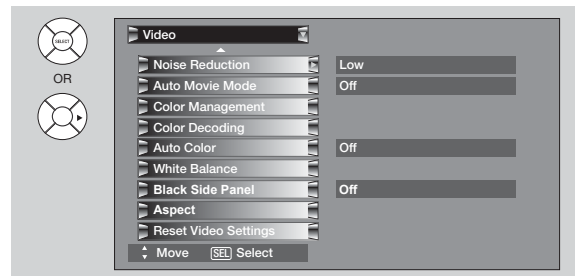

Video

Color Decoding

Use this function to adjust and balance the percentage of Red, Green and Color according to the user's preference in each of the four color temperature settings. Use TINT to adjust flesh tones so they appear natural.

1. Use **CURSOR PAD** ▲ or ▼ or **CHANNEL WHEEL** to highlight functions.
2. Press the **CURSOR PAD** ◀, ▶, ▲ or ▼ and **SELECT** button to highlight and adjust individual colors.

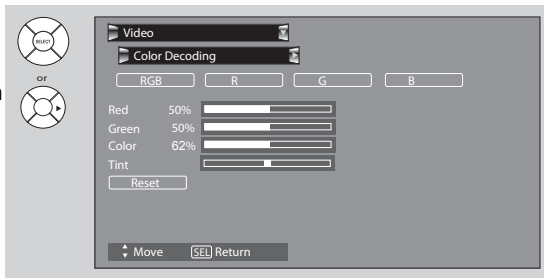

NOTE: The Red and Green adjustments will apply for each color temperature.

Auto Color

The **Auto Color** function automatically monitors and adjusts the color to maintain constant color levels even after a program or channel changes. It also maintains natural flesh tones while preserving fidelity of background colors.

NOTE: When receiving Antenna Digital Channel or using Component input, Auto Color will not be available (grayed out).

White Balance

Use the **CUTOFF** functions to adjust the color temperature of the dark areas of the picture.
Use the **DRIVE** functions to adjust the color temperature of the bright areas of the picture.

1. Use the **CURSOR PAD** ▲ or ▼ or **CHANNEL WHEEL** to highlight the choice.
2. Press the **CURSOR PAD** ◀ or ▶ to adjust.
3. Press the **EXIT** button to quit or select **White Balance** to return to the previous **MENU**.

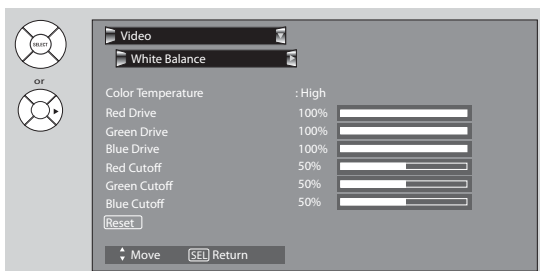

Black Side Panel

The **BLACK SIDE PANEL** function turns the gray side bars on/off when watching 4:3 signals in Standard mode or use of the PIP modes.

1. Press the **CURSOR PAD** ◀ or ▶ to set to ON or OFF.
2. Press **EXIT** to quit menu or select **BLACK SIDE PANEL** to return to the previous menu.

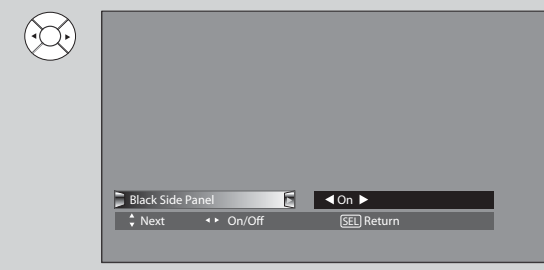
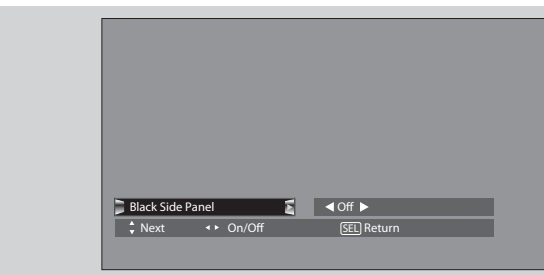

NOTE: To prevent uneven aging when watching 4:3 signal, turn off the **BLACK SIDE PANEL**. It is recommended to watch 4:3 signal with gray side bar.

Video

Aspect

Use this function to select the Picture Format Aspect Ratio.

Auto Aspect

Automatically adjust the Aspect Ratio depending on the input signal to fill the screen.

Mode

Manually select the Aspect Ratio.

Vertical Position

This function allows you to select when aspect style is either 4:3 EXPANDED/ZOOM1/ZOOM2 or 16:9 ZOOM. Vertical position can be changed with these modes.

For example, it will be useful for centering the picture area at both the top and bottom of the picture with 480i/480p signal. Adjustable range is -10 (video center is toward bottom of screen) to +10 (video is toward top of screen).

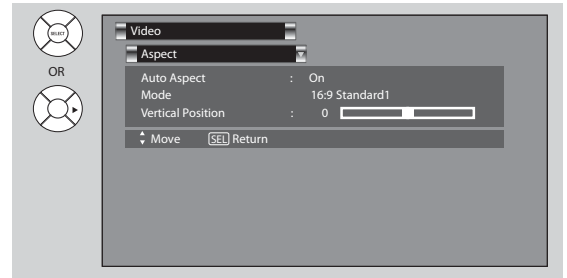

1. Use the **CURSOR PAD ▲** or **▼** to select menu item.
2. Press the **CURSOR PAD ◀** or **▶** to adjust the function.
3. Press the EXIT to quit the MENU, or select ASPECT to return to the main menu.

NOTE: Vertical Position will not be available in 4:3 Standard and 16:9 Standard modes.

Reset Video Settings

This function allows you to Reset the Video Menu Settings of the present input and return it to the Day-Dynamic VIDEO mode.

1. Use CURSOR PAD ▲, ▼ or CHANNEL WHEEL buttons to highlight functions.
2. Press the SELECT button or CURSOR PAD ▶ to select Reset Video Settings.
3. Use the CURSOR PAD ▼ to access at the Reset softkey.
4. Press the SELECT button to Reset the Video Settings.

You can customize each of the Video Inputs to your preference to increase viewing performance and pleasure, depending upon the video program being viewed. If RESET is selected, only the selected Input will reset to the initial conditions as explained above.

If RESET is selected in Input 1, only Input 1 will return to factory conditions.

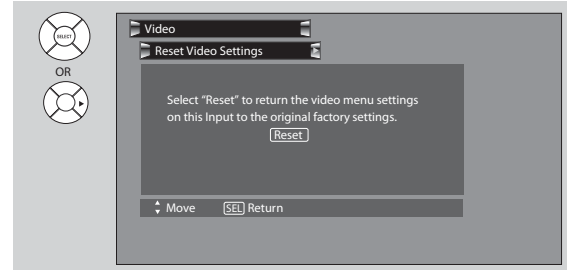
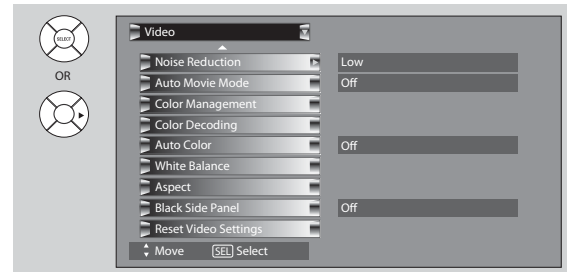

Audio

Select AUDIO to adjust the TV to your preference and to improve the sound quality.

1. Press CURSOR PAD ▲ or ▼ to select menu item.
2. Press CURSOR PAD ◀ or ▶ to adjust the function.
3. Press EXIT to quit the MENU, or select AUDIO to return to the main menu.

NOTE: If **TREBLE** is selected you are adjusting **treble**. The additional menu items **Bass** and **Balance** can be selected and adjusted in the same manner.

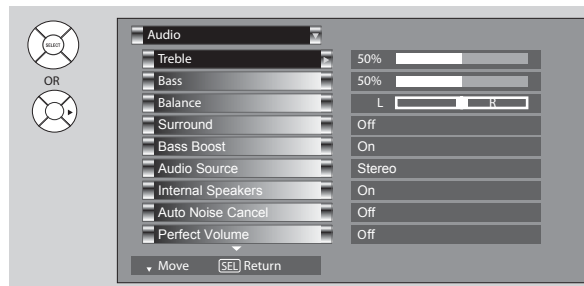
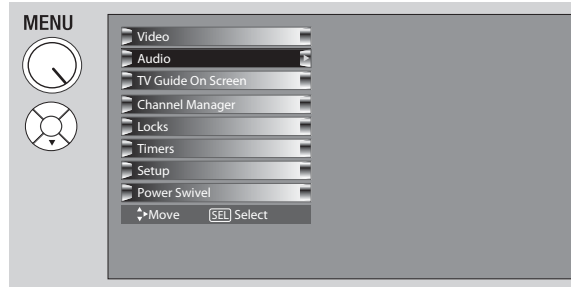

Treble

This function controls the high frequency audio to all speakers.

Bass

This function controls the low frequency audio to all speakers.

Balance

This function will control the left to right balance of the Plasma TV internal speakers.

Surround

Surround sound is the concept of expanding the spatial imaging of audio from one dimension (Mono/Left-Right) to two or three dimensions. This is often done to create a more realistic audio environment.

- 1.- Use cursor ▲ or ▼ to highlight surround option.
- 2.- Use cursor ◀ or ▶ to select Off, Normal or Wide.

Off : turns off the surround sound effect.

Normal Surround : Provides the surround effect by locating two or more speakers to the rear of the listener.

Wide Surround : Reproduce much better quality 5 channel sound signals from ordinary stereo contents comparing with normal surround technology. Wide surround enable users to enjoy sound playback in wide surround virtual area like 5 channel contents with ordinary stereo contents.

Bass Boost

This function allows to enhance the low frequency audio performance of your speaker system.

Audio

Audio Source

Multi-Channel Television Sound will allow you to select **STEREO** (a stereo broadcast), **MONO** (monaural sound) used when receiving a weak stereo broadcast or **SECOND AUDIO PROG (SAP)** which may be a secondary language, weather report, etc.

Internal Speakers

This function is useful when setting up the external speakers.

ON	Select this feature if using the internal speakers only.
TV as Center	Select this feature when setting up external speakers from a separate stereo system. The TV's speakers will work as the center speaker.
OFF	Select this feature if you prefer to use only speakers from a separate stereo system.

Auto Noise Cancel

This function eliminates the noise between stations. If a channel is tuned and is noisy, this function will automatically eliminate the audio for that channel.

Perfect Volume

This function will automatically adjust volume so each channel and input has the same average volume level.

Loudness

Set this function to ON to emphasize bass and treble at low volume levels.

Language

Some programs transmit more than one DTV language option. Most will have English as a default language. The language function will allow you to select up to 4 language options (if available).

Digital Output

This function allows you to select between Dolby® Digital and PCM.



Dolby® Digital - Select this feature if the TV is connected to an amplifier/receiver with a Dolby® Digital only decoder; it will provide six independent soundtrack channels through the optical output jack (Digital Audio).

NOTE: *Manufactured under license from Dolby Laboratories. "Dolby" and the double-D symbol are trademarks of Dolby Laboratories.

PCM - Select this feature if the TV is connected to an amplifier/receiver with a PCM only decoder; it will provide two independent soundtrack channels through the optical output jack (Digital Audio).

DRC

Dynamic Range Compression - Use this function to compress the range of sound volume. By compressing the range of sound volume, it is possible not only to suppress the output of loud sound at night but also to raise the volume of low sound. The default setting is ON.

Use the CURSOR PAD ◀ or ▶ to select the chosen options.

NOTE: The functions Language, Digital Output and DRC are only available when viewing digital programs.

Use the functions at right if your TV is connected to an amplifier/receiver with optical digital input with Dolby Digital or PCM decoder capabilities.

NOTE: 1.- The DRC control affects only Dolby Digital signals decoded internally by the TV.
2.- DRC does not affect the Dolby Digital bitstream available at the digital audio output.

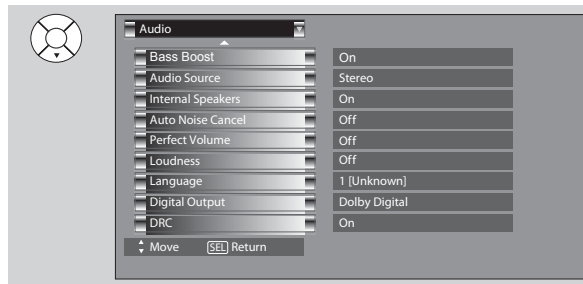
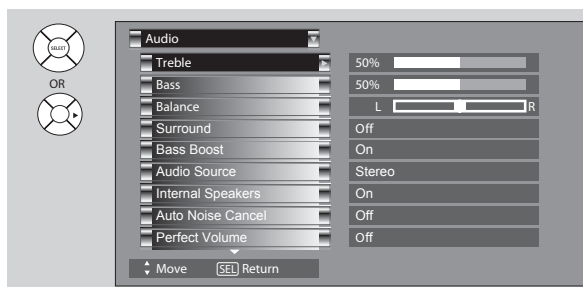

TV Guide On Screen

TV Guide On Screen

The TV Guide On-Screen system is a built-in feature that provides a channel lineup and program listings in your area. Once the setup process is complete, the program listings are automatically updated several times a day.

If using a VCR, you must first setup the Plasma TV as shown on Page 23.

To Setup the TV Guide On Screen System:

1. Press the MENU button. Use the CURSOR PAD ▼ to highlight TV GUIDE ON SCREEN, then press the SELECT button.

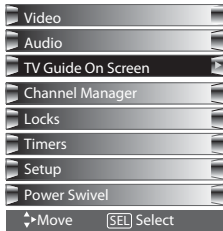

Note: Pressing the GUIDE button also allows you immediate access to this feature.

2. Press the SELECT button to continue.

Setup Procedure:

Screen 1: Select which country your TV is located in: Use the CURSOR PAD ▲ and ▼ to highlight your TV location (USA or CANADA), then press the SELECT button to continue.

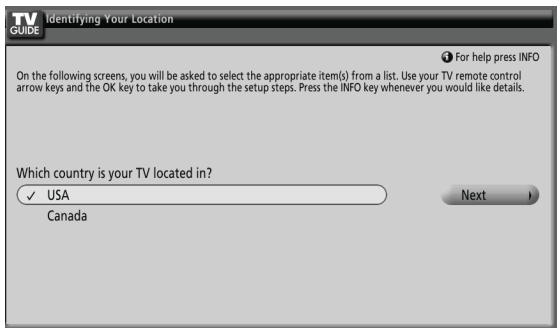

Screen 2: Enter the zip code (USA) or postal code (Canada):

Use the Numeric buttons and the CURSOR PAD ▲ and ▼ for letter entries to enter the ZIP code (USA) or postal code (CANADA) of your location.



*For USA is a 5 digit ZIP CODE

**For CANADA is a 6 digit ZIP CODE

Screen 3:

Please select which service(s) you would like your TV Guide On Screen™ to support (Check all that apply):

Use the CURSOR PAD ▲ and ▼ to highlight your choice, then press the SELECT button then select Next :

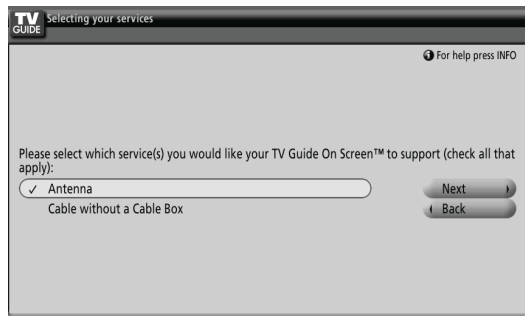

Screen 4:

Are the above settings correct ?

Use the CURSOR PAD ▲ and ▼ to highlight your choice, then press the SELECT button then select Next :

*If all setting are correct please select Yes to continue.

*If a setting is wrong please select No to modify.

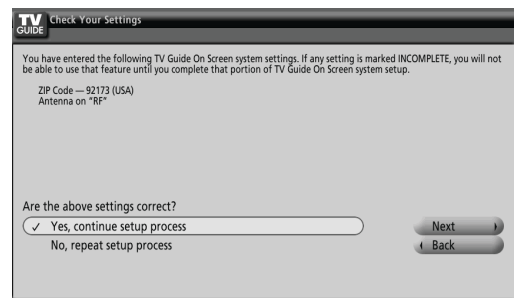

TV Guide On Screen

Screen 5:

Would you like to use the TV Guide On Screen system to control recording with your VCR?
 Use the CURSOR PAD ▲ and ▼ to highlight your choice, then press the SELECT button then next.
 If YES: Please see Screen 6.
 If NO: Please see Screen 12.

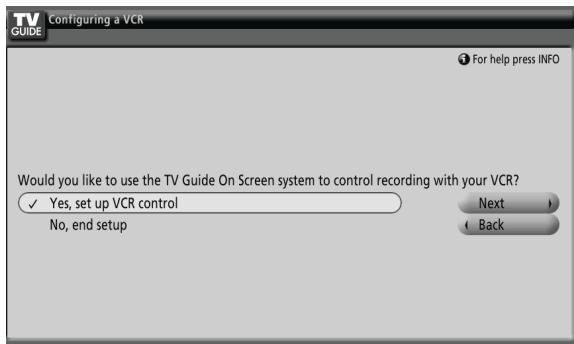

Screen 6:

The screen will show the correct way to setup the VCR with the G-Link. Please confirm the connections (see page 23). Press SELECT button to continue.

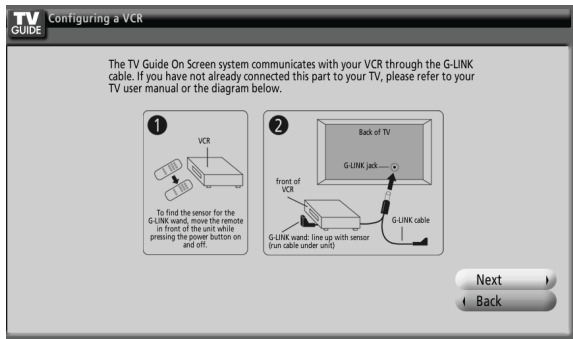

Screen 7:

What brand of VCR is connected to this TV ?
 Use the CURSOR PAD ▲ and ▼ to highlight your choice, then press the SELECT button to continue.

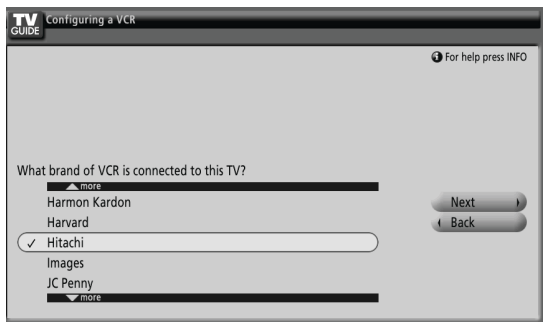

Screen 8:

This screen shows the steps that you need to follow to make the correct setup of your VCR with the G-LINK. Please check your connection (see Page 23). Press the SELECT button to continue.

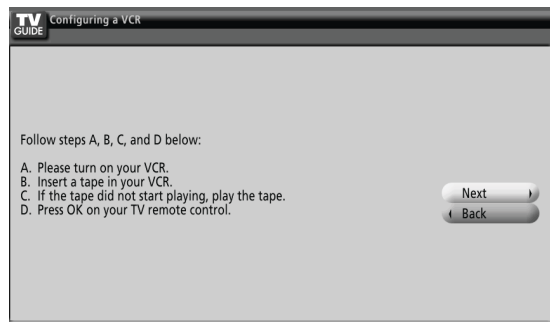

Screen 9:

Now the TV GUIDE will send the code to control the VCR through the G-Link connection.



Screen 10:

Did your VCR stop playback of the TAPE ?
 If Yes then go to screen 11
 If No the TV Guide will try a different code and return to screen 9.
 If you like to Test this test code again one more time



TV Guide On Screen

Screen 11:

Are the settings correct ?

If Yes the TV Guide setup is complete, then press SELECT button to continue.

If No please make the necessary changes in order to complete the TV Guide setup procedure.

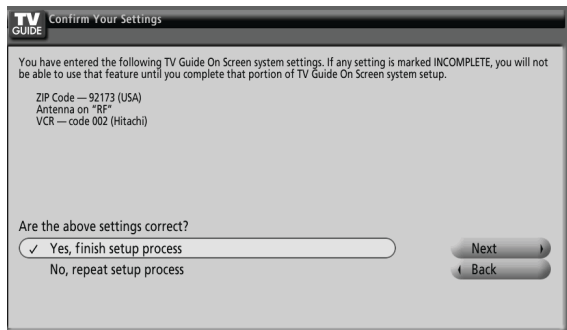

Screen 12:

This shows that the setup procedure is complete
Use the CURSOR PAD ▲ and ▼ to highlight Next
or if you are like to make changes select Back ;
Then press SELECT button to continue or finish.

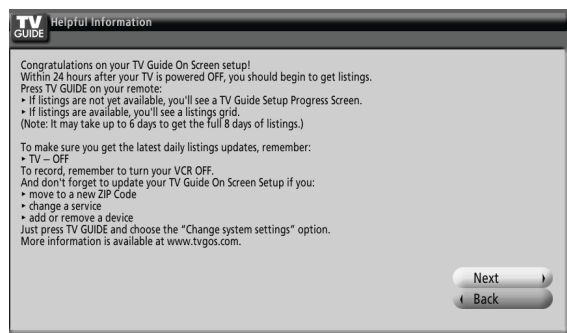

Screen 13:

When a CODE for a VCR is not accepted then the following message will appear. Check the setup as mentioned then select Next.

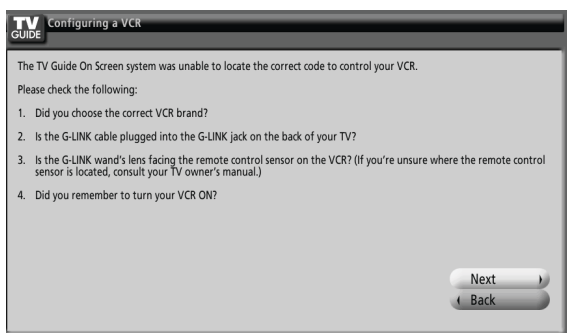

Screen 14:

None of the Hitachi codes appeared to control your VCR. What would you like to do now ?

- 1.- Try VCR configuration again to repeat the setup.
- 2.- Try alternate remote codes to see other code alternatives that may solve the problem.
- 3.- Skip this step , will finish the TV Guide setup ; but will show an incomplete setup for your VCR.

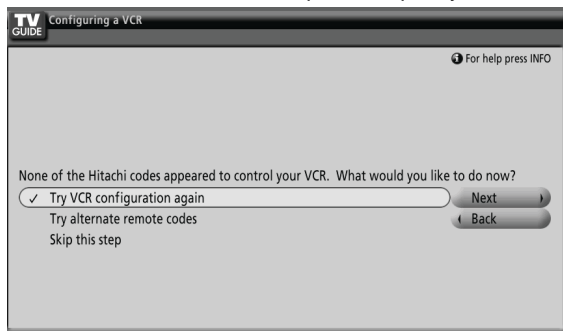

NOTE: 1. The Plasma TV should be in standby mode in order to continually receive updated program listings from your cable company.
2. If using a Cable box, please leave it ON to continually receive updated program listings from your cable company.

For using and navigating the TV Guide On Screen System please refer to the TV Guide Instruction Book.

Channel Manager

Channel Manager

Select **CHANNEL MANAGER** to set your Antenna options, run Auto Channel Scan, Check Signal Meter and Set Channel List.

1. Press CURSOR PAD ▲, ▼ or CHANNEL WHEEL buttons to highlight function.
2. Press the SELECT button or CURSOR PAD ► to select.

Signal Meter

Select **SIGNAL METER** when using an indoor or outdoor antenna. This feature will show the signal strength and peak values of the Antenna signal to help you adjust your antenna to optimize signal reception.

Use the **CURSOR PADS** and the **SELECT** button to highlight and select **CLOSE** to exit.

NOTE: The Signal Meter will not be available (grayed out) when watching analog channels.

Auto Channel Scan

This feature will automatically store active Analog and Digital channels in Auto Channel Scan memory.

1. Use the **CURSOR** buttons ◀ or ▶ to highlight AIR, CABLE (1) or CABLE(2) source.
2. Press the **CURSOR** buttons ◀ or ▶ to highlight the **START** or **RESET** option.
3. Press the **SELECT** button to select.

- NOTE:**
1. When a CableCARD is installed, Auto Channel Scan will not be available since channels will be fixed based on what was agreed upon by you and your cable operator.
 2. If certain channels are poor or not possible in cable(1) mode, set cable source to cable(2) by using the CURSOR buttons ◀ or ▶.

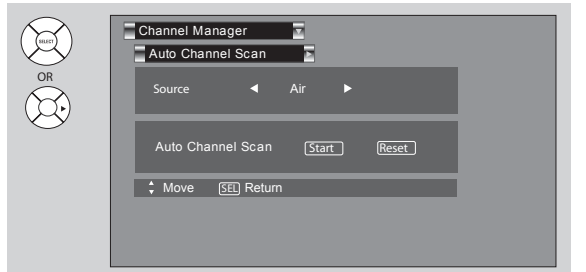
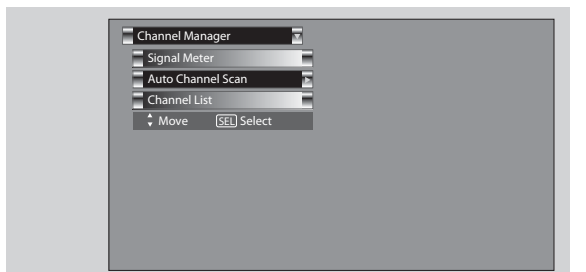
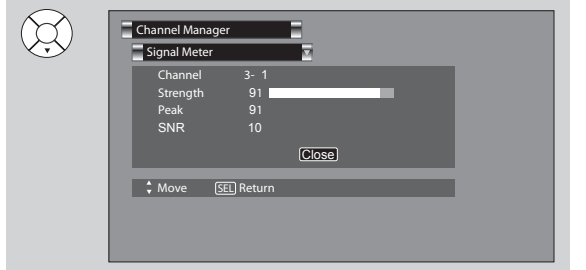
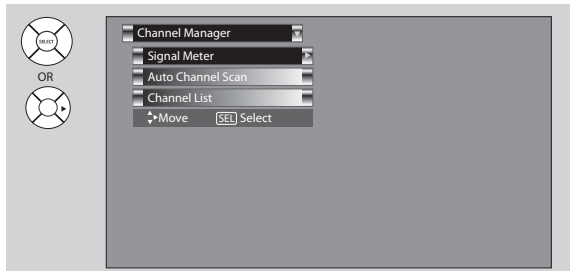
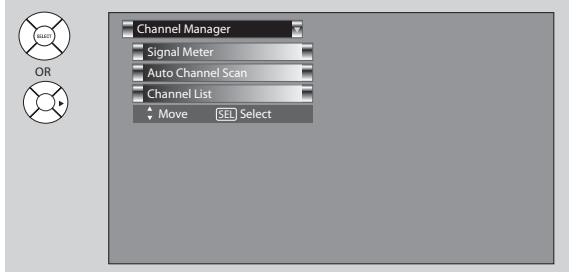

Channel Manager

Channel List

This function allows you to review which channels are labeled **(CH ID)**, which have been added to **CHANNEL MEMORY (SCAN)**, which are protected by **LOCK** and which are your **FAVORITE (FAV) CHANNELS**.

1. Use the **CURSOR PAD** to navigate the Channel List.
2. Press the **SELECT** button to select **ON** or **OFF** on the **SCAN** and **LOCK** columns.
3. To select **LOCK** column, input the access code.
(Default access code: 0000)
4. Press the **CHANNEL WHEEL** button to set or remove the **FAVORITE** channel settings.
5. Press the **EXIT** button to return to normal viewing.

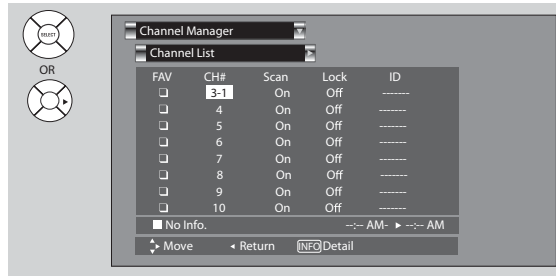
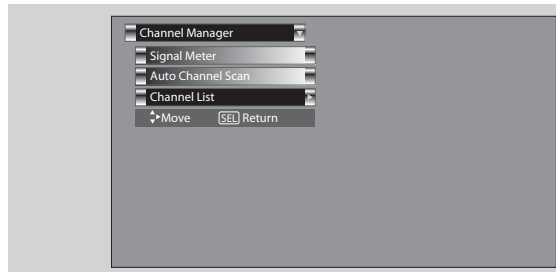

NOTE: 1. When a CableCARD is installed, the Channel List will be dependent on channels agreed upon by you and your cable operator.
2. The Channel List cannot be updated by only changing the cable source. Auto Channel Scan must be performed for the Channel List to be updated.

Locks

Locks

This function will block out the picture and sound of the selected channel or video input.

The code to enter the Locks feature is a four digit access code number. The factory preset code is **0000**. Use the **NUMBER** buttons to enter the access code.

1. Use the **CURSOR PAD ▲, ▼** or **CHANNEL WHEEL** buttons to highlight the desired function in the **LOCKS** menu.
2. Press the **SELECT** button to select.

Change Access Code

1. To change the **ACCESS CODE NUMBER**, select **CHANGE ACCESS CODE** to change the factory preset code (**0000**) to your preference.

If you forget your **ACCESS CODE NUMBER**, use the factory code **7777** to erase your key number. This will reset the access code number back to the factory preset (**0000**).

2. Enter a new four digit number.
3. Press **EXIT** to quit the menu.

Engage Lock

When **ENGAGE LOCK** is selected, **SET CHANNEL LOCK** and **SET FRONT PANEL LOCK** can be set individually.

When **SET CHANNEL LOCK** is turned on, the picture and sound for the chosen channel will be blocked out.

When **FRONT PANEL LOCK** is turned on, all buttons on the Front Panel will be deactivated, except the **POWER** button.

When **MOVIE RATINGS** is selected, you can block various types of movies and video tapes based on motion picture ratings. Picture-in-Picture will also be blocked automatically (see page 59).

When **TV RATINGS** is selected, various types of television programming based on a parental guide ratings will be blocked. Picture-in-Picture will also be blocked automatically (see page 60).

Use **CANADIAN RATINGS** to block various types of movies and television programs based on the two rating systems used in Canada that you feel may be inappropriate due to its content (see pages 61-62).

Use **ALTERNATE RATINGS (U.S.)** to block various types of movies and television programs based on ratings systems used in U.S. that you feel may be inappropriate due to its content (see page 63).

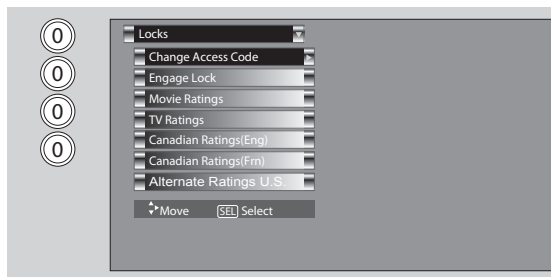
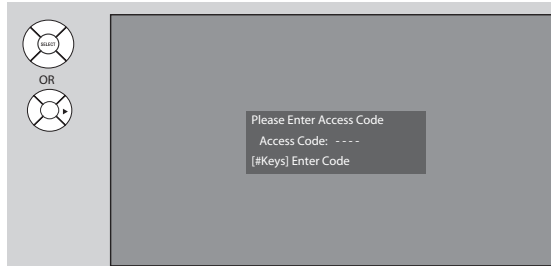

NOTE:

The **ALTERNATE RATINGS (U.S.)** option is available for Digital Channels only.

Locks

Movie Ratings

Use Movie Ratings to prevent viewing of any movie that you feel may be inappropriate due to its content.

1. Use the CURSOR PAD ▲, ▼ or CHANNEL WHEEL buttons to select the **MOVIE RATING** category that you want to block.
2. Press **SELECT** to block the **MOVIE RATING** that you have selected. Once rating is selected, for example PG-13, all movies rated PG-13 and higher (R, NC-17, and X) will be blocked.
3. Press **EXIT** to quit the menu or select **MOVIE RATING** to return to the previous menu.

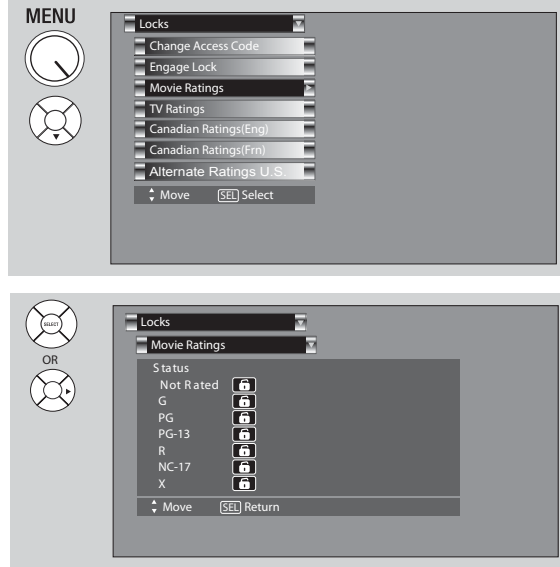

Motion Picture Ratings Table

NOT RATED	Contains no rating. Not Rated (NR) and Not Applicable (NA) programs. Movie has not been rated or ratings do not apply.
G	General audiences. All ages admitted.
PG	Parental guidance suggested. Some material may not be suitable for children.
PG-13	Parents strongly cautioned. Some material may be inappropriate for children under 13.
R	Restricted. Under 17 requires accompanying parent or adult guardian.
NC-17	No one 17 and under admitted.
X	Adults only

- NOTE:**
1. A movie rating is dependent upon the movie that is viewed. If the movie does not carry a rating, the TV will not block it.
 2. Blocking **NOT RATED** programs may block emergency programming, sports, news, public service announcements, religious programs and weather.
 3. If a CableCARD is installed, your cable operator may provide an Emergency Alert System (EAS) message in the event of a local or national emergency with the purpose of alerting the general public. When you receive such messages, the Television will immediately tune to an EAS channel as directed by the EAS message. Please be advised that if the EAS channel is blocked using the LOCKS feature, you will not be able to tune to that channel.

Locks

TV Ratings

Use **TV RATINGS** to prevent the viewing of any TV program that you feel may be inappropriate due to its content.

1. Use the **CURSOR PAD ▲, ▼** or **CHANNEL WHEEL** buttons to select the **TV RATING** category that you want to block.
2. Press **SELECT** to block the **TV RATING** that you have selected.
3. Press **EXIT** to quit the menu or select **TV RATING** to return to the previous menu.

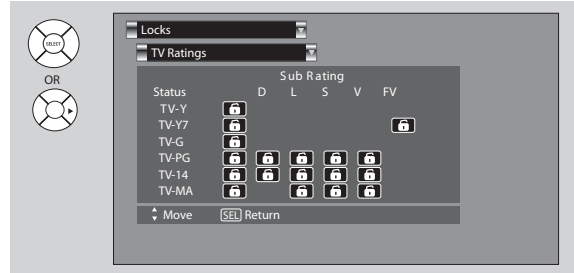
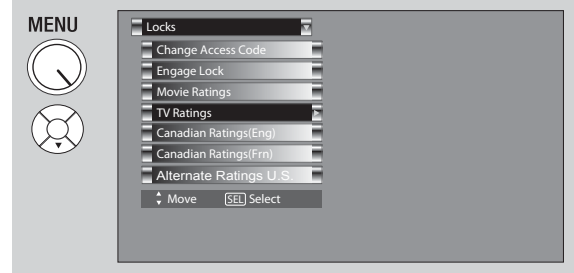

TV Parental Guide Ratings Table

TV-Y	All children. The themes and elements in this program are specifically designed for a very young audience, including children from ages 2-6.
TV-Y7	Directed to older children. Themes and elements in this program may include mild physical or comedic violence, or may frighten children under the age of 7.
TV-G	General audience. It contains little or no violence, no strong language, and little or no sexual dialogue or situations.
TV-PG	Parental guidance suggested. The program may contain infrequent coarse language, limited violence, some suggestive sexual dialogue and situations.
TV-14	Parents strongly cautioned. This program may contain sophisticated themes, intense sexual situation, more intense violence and intensely suggestive dialogue.
TV-MA	Mature audiences only. This program may contain mature themes, indecent language, graphic violence, and explicit sexual content.
FV	Fantasy Violence
V	Violence
S	Sexual Situation
L	Adult Language
D	Sexually Suggestive Dialogue

- NOTE:**
1. If you Block **TV-14D**, you will still permit **TV-MA** programs; If you block **TV-14V**, you will automatically block **TV-MAV** programs, but you will still permit **TV-MALS** programs. This means that the TV will block violence in **TV-14** and higher (**TV-MA**), but not language and sex.
 2. TV program ratings are dependent on the broadcaster. If the program is not rated, the TV will not block it.
 3. If a CableCARD is installed, your cable operator may provide an Emergency Alert System (EAS) message in the event of a local or national emergency with the purpose of alerting the general public. When you receive such messages, the Television will immediately tune to an EAS channel as directed by the EAS message. Please be advised that if the EAS channel is blocked using the **LOCKS** feature, you will not be able to tune to that channel.

Locks

Canadian Ratings (Eng)

Use **CANADIAN RATINGS (ENG)** to block any type of movie and television program in Canada that you feel might be inappropriate in its content.

1. Use the **CURSOR PAD ▲, ▼** or **CHANNEL WHEEL** buttons to select the **CANADIAN RATINGS (ENG)** category that you want to block.
2. Press **SELECT** to block the **CANADIAN RATINGS (ENG)** that you have selected. Once rating is selected, for example **C8+**, all movies and television programs rated **C8+** and higher (**G, PG, 14+** and **18+**) will be blocked automatically.
3. Press **EXIT** to quit the menu or select **CANADIAN RATINGS (ENG)** to return to the previous menu.

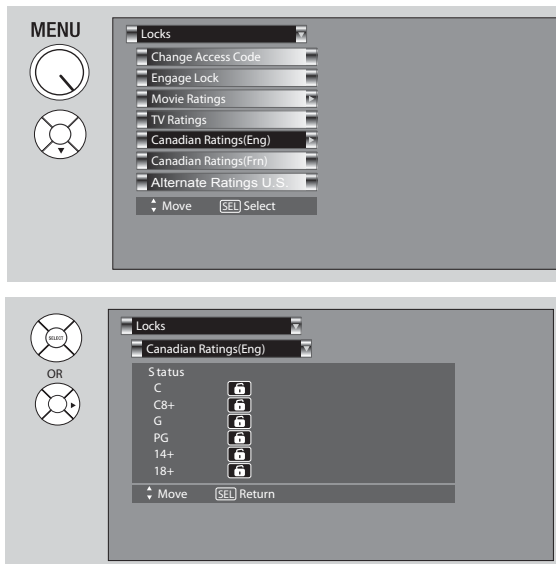

Canadian Ratings English Table

C	Programming intended for children under age 8 - Violence Guidelines: Careful attention is paid to themes, which could threaten children's sense of security and well-being. There will be no realistic scenes of violence. Depictions of aggressive behaviour will be infrequent and limited to portrayals that are clearly imaginary, comedic or unrealistic in nature. Other Content Guidelines: There will be no offensive language, nudity or sexual content.
C8+	Programming generally considered acceptable for children 8 years and over to watch on their own - Violence Guidelines: Violence will not be portrayed as the preferred, acceptable, or only way to resolve conflict; or encourage children to imitate dangerous acts which they may see on television. Any realistic depictions of violence will be infrequent, discreet, of low intensity and will show the consequences of the acts. Other Content Guidelines: There will be no profanity, nudity or sexual content.
G	General Audience - Violence Guidelines: Will contain very little violence, either physical or verbal or emotional. Will be sensitive to themes which could frighten a younger child, will not depict realistic scenes of violence which minimize or gloss over the effects of violent acts. Other Content Guidelines: There may be some inoffensive slang, no profanity and no nudity.
PG	Parental Guidance - Programming intended for a general audience but which may not be suitable for younger children. Parents may consider some content inappropriate for unsupervised viewing by children ages 8-13. Violence Guidelines: Depictions of conflict and/or aggression will be limited and moderate; may include physical, fantasy, or supernatural violence. Other Content Guidelines: May contain infrequent mild profanity, or mildly suggestive language. Could also contain brief scenes of nudity.
14+	Programming contains themes or content which may not be suitable for viewers under the age of 14 - Parents are strongly cautioned to exercise discretion in permitting viewing by pre-teens and early teens. Violence Guidelines: May contain intense scenes of violence. Could deal with mature themes and societal issues in a realistic fashion. Other Content Guidelines: May contain scenes of nudity and/or sexual activity. There could be frequent use of profanity.
18+	Adult - Violence Guidelines: May contain violence integral to the development of the plot, character or theme, intended for adult audiences. Other Content Guidelines: May contain graphic language and explicit portrayals of nudity and/or sex.

Locks

Canadian Ratings (Frn)

Use **CANADIAN RATINGS (FRN)** to block Canadian French programs according to various program ratings that you feel might be inappropriate in its content.

1. Use the **CURSOR PAD ▲, ▼** or **CHANNEL WHEEL buttons** to select the **CANADIAN RATINGS (FRN)** category that you want to block.
2. Press **SELECT** to block the **CANADIAN RATINGS (FRN)** that you have selected. Once rating is selected, for example **8 ANS+**, all movies and television programs rated **8 ANS+** and higher will be blocked automatically.
3. Press **EXIT** to quit the menu or select **CANADIAN RATINGS (FRN)** to return to the previous menu.

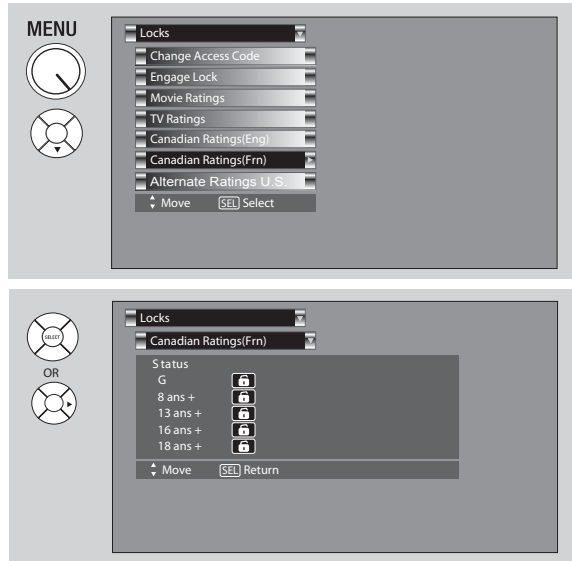

Canadian Ratings French Chart

G	General - Programming intended for audiences of all ages. Contains no violence, or the violence content is minimal or is depicted appropriately with humor or caricature or in an unrealistic manner.
8 ans +	8 + General - Not recommended for young children - Programming intended for a broad audience but contains light or occasional violence that could disturb young children. Viewing with an adult is therefore recommended for young children (under the age of 8) who cannot differentiate between real and imaginary portrayals.
13 ans +	Programming may not be suitable for children under the age of 13 - Contains either a few violent scenes or one or more sufficiently violent scenes to affect them. Viewing with an adult is therefore strongly recommended for children under 13.
16 ans +	Programming is not suitable for children under the age of 16 - Contains frequent scenes of violence or intense violence.
18 ans +	Programming restricted to adults - Contains constant violence or scenes of extreme violence.

Locks

Alternate Ratings U.S.

Use Alternate Ratings to prevent viewing of any movie or program that you feel may be inappropriate due to its content. This feature will be available only for ATSC Digital signal. In case only NTSC analog signal is received this feature will be unavailable (grayed out).

In order to set the Alternate Ratings the ATSC Digital channel received must include Alternate Ratings data. To see if the channel has Alternate Ratings, press the INFO key on the R/C. See fig. (1) for reference.

Once the TV has received Alternate Ratings data, the Alternate Ratings US in the lock menu will become available.

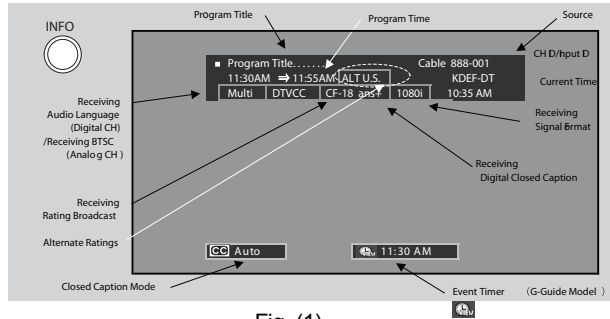
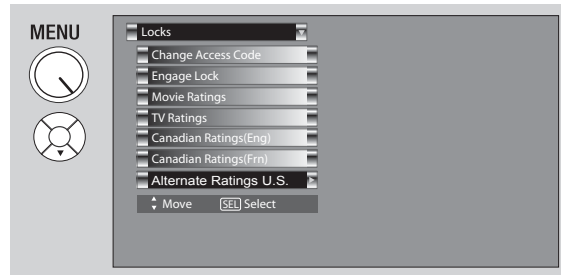
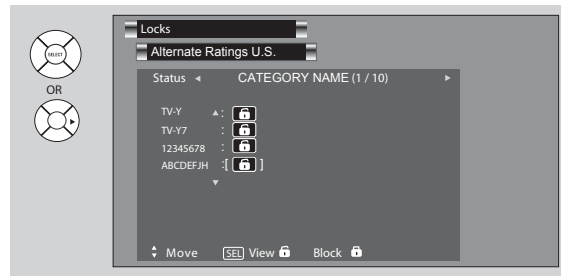

Fig. (1)

1. Use the CURSOR buttons ▼ or ▲ to select the **ALTERNATE RATING** category that you want to block.



2. Press **SELECT** to block the **ALTERNATE RATING** that you have selected. Once rating is selected, for example PG-13, all movies rated PG-13 and higher (R, NC-17 and X) will be blocked.



3. Press **EXIT** to quit the menu or select **ALTERNATE RATINGS** to return to the previous menu.

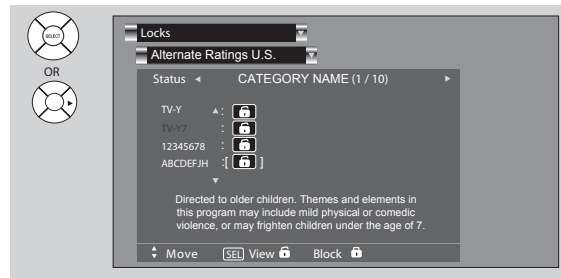

Alternate Ratings (Example Only) :

G	General audiences. All ages admitted.
PG	Parental guidance suggested. Some material may not be suitable for children.
PG-13	Parents strongly cautioned. Some material may be inappropriate for children under 13.
R	Restricted. Under 17 requires accompanying parent or adult guardian.
NC-17	No one 17 and under admitted.
X	Adults only
Y	Adults only

NOTE: In some cases the OSD will show the function name as " Alternate Ratings U.S. " or "Downloaded Ratings ", in both cases the operation is the same only name is different.

Timers

Timers

Select **TIMERS** to set your Clock, Sleep Timer and Day/Night Timer.

1. Use the **CURSOR** buttons ▲ or ▼ or **CHANNEL WHEEL** to highlight the function to be adjusted.
2. Press the **SELECT** button to select.

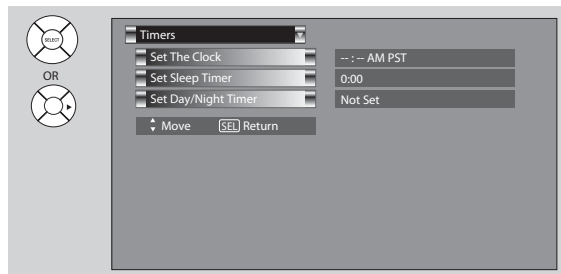
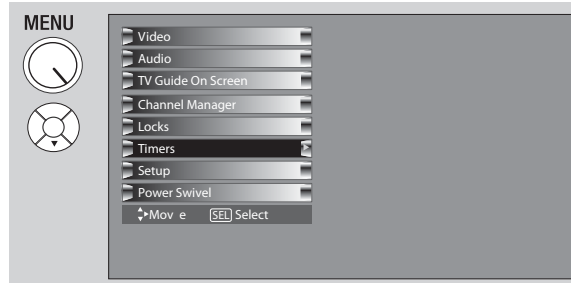

Set The Clock

The Clock must be adjusted before you can use the **DAY/NIGHT TIMER** feature.

1. Use the **CURSOR PAD** ◀, ▶, ▲, ▼ or **CHANNEL WHEEL** buttons to highlight the chosen **TIME ZONE** settings.
2. Press the **SELECT** button to select. If you observe daylight savings, use **CURSOR PAD** to highlight **DAYLIGHT SAVING CORRECTION** and press the **SELECT** button to select.
3. Use the **CURSOR PAD** ◀, ▶, ▲, ▼ or **CHANNEL WHEEL** buttons to highlight the **CURRENT TIME** hour and minute), **AM** or **PM**, **MONTH**, **DAY**, and **YEAR**.
4. Use the **CURSOR PAD** ▲, ▼ to adjust settings.
5. Press the **SELECT** button to set the **TIME AND DATE**.
6. Press **EXIT** to quit the menu or select **SET THE CLOCK** to return to the previous menu.

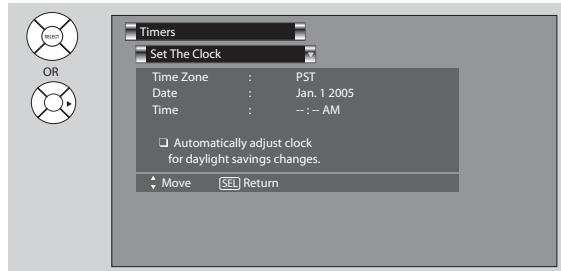
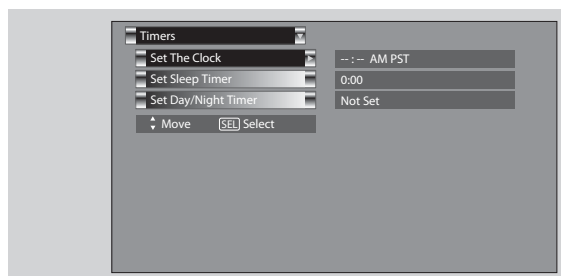

- NOTE:**
1. When **AUTOMATICALLY ADJUST CLOCK FOR DAYLIGHT SAVING CHANGES** is checked , the TV will automatically calculate the clock adjustment for Daylight Saving.
 2. When the CableCARD is used, the TV will **SET THE CLOCK** automatically and also when the TV Guide On Screen system setup process is complete. In this case the Set The Clock feature will not be available (grayed out).
 3. The TV counts electrical pulses for regulating the **TIMERS**. When the power cord is unplugged then plugged in quickly, the clock is stopped momentarily and the **TIME** indication will become slow.

Timers

Set Sleep Timer

Select this feature to set your **SLEEP TIMER** from 30 minutes to 3 hours (30 minute increments).

1. Press the **CURSOR PAD** ► repeatedly to set your Timer from **0:00**, **0:30**, **1:00**, **1:30**, **2:00**, **2:30** and **3:00**.

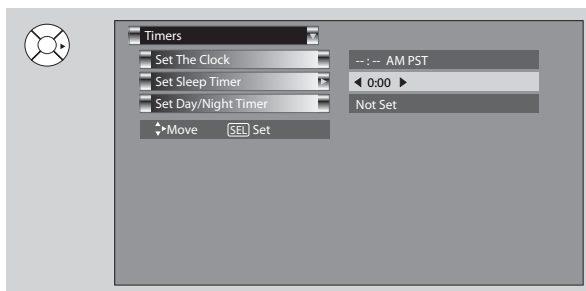
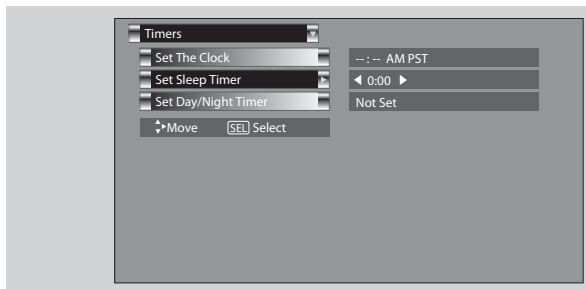

Set Day/Night Timer

Select this feature to activate and set your TV's **DAY/NIGHT PICTURE MODE** automatically. This feature is not available until the clock is set.

1. Use the **CURSOR PADS** to highlight **SET DAY/NIGHT TIMER** settings.
2. Press the **SELECT** button to select.
3. Use the **CURSOR PADS** to select **DAY MODE ON** and to set its **TIMER**.
4. Use the **CURSOR PADS** to select **DAY MODE OFF** and to set its **TIMER**.
5. Press **EXIT** to quit the menu or select **SET DAY/NIGHT TIMER** to return to the previous menu.

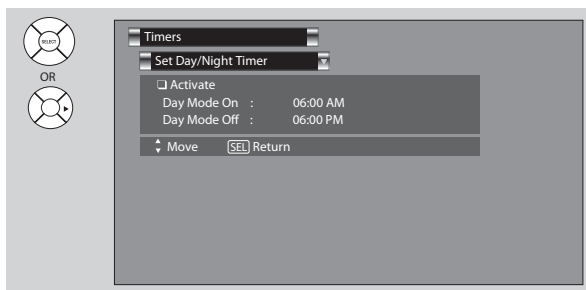
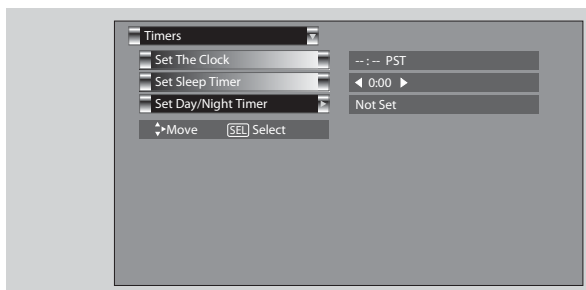

Setup

Select **SETUP** when setting your TV up for the first time.

1. Use the **CURSOR PAD** ▲, ▼, ◀ or ▶ to select the sub-menu of your choice.
2. Press the **SELECT** button to select.

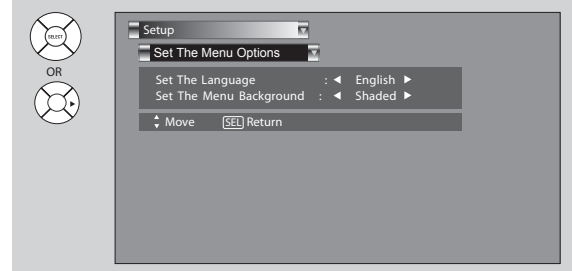
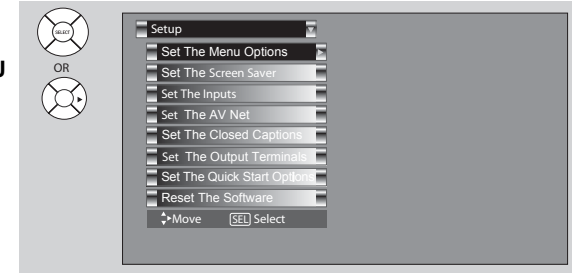
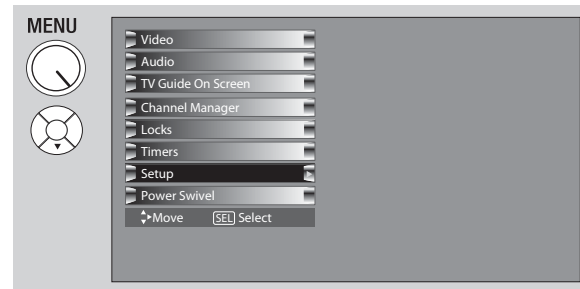
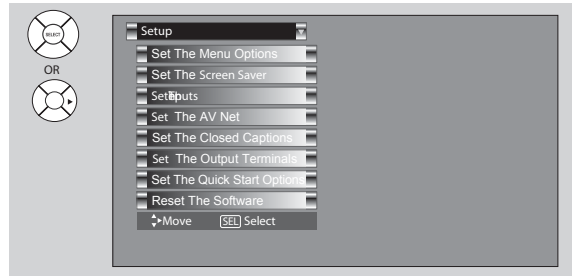
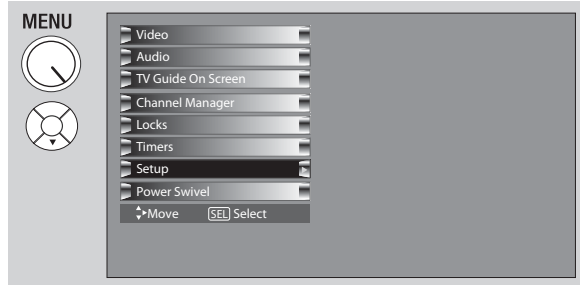

Set The Menu Options

Setup the Language and background of the Menu OSD.

Set The Language

This feature will allow you to select any one of three different languages for all on-screen displays.

1. Use the **CURSOR PAD** ◀ or ▶ to select the language of your choice.
2. Press **EXIT** to quit menu or select **SET THE MENU OPTIONS** to return to previous menu.

Setup

Set the Menu Background

This function allows you to choose from two menu backgrounds.

1. Use the **CURSOR PAD ▲** or **▼** to highlight **SET THE MENU BACKGROUND (SHADED OR SOLID)** of your choice. Use the **CURSOR PAD ◀** or **▶** to select shaded or solid.
2. Select **SOLID** for a black background (no picture can be seen behind menu screen), select **SHADED** and a light background is visible.
3. Press **EXIT** to quit menu or select **MENU PREFERENCE** to return to previous menu.

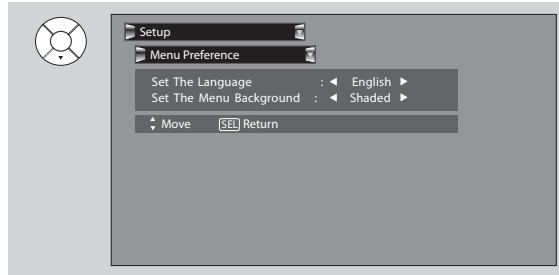

Screen Saver

Continuous on-screen displays such as video games, stock market quotations, computer generated graphics, and other fixed (non-moving) patterns can cause permanent damage to the Plasma Television. Use the SCREEN SAVER feature to hide screen burn.

1. Use **CURSOR PAD ▲** or **▼** to highlight Screen Saver's Main Picture Moving and Image Power options.
2. Use the **CURSOR PAD ◀** or **▶** to select your choices.

Option 1

The whole picture will shift every 2 minutes by one pixel.

Option 2

The whole picture will shift every 10 minutes by one pixel.

Option 3

The whole picture will shift every 20 minutes by one pixel.

Image Power

This function allows you to choose power consumption reduction based on 3 levels (min., medium and max).

Screen Wipe

If pattern mark occurs, use Screen Wipe (White Field Signal) for at least 10 minutes to refresh any damage that may have occurred from a pattern mark. Screen Wipe can resolve pattern mark to a certain degree, if caution is not used, permanent damage may occur. Use the cursor pad **▲** or **▼** to highlight Screen Wipe.

Press the **SELECT** button to start.

Press the **EXIT** button to return to normal viewing.

Automatic Power Saving

Use this feature to turn power off automatically when a video input signal is not detected in 15 seconds.

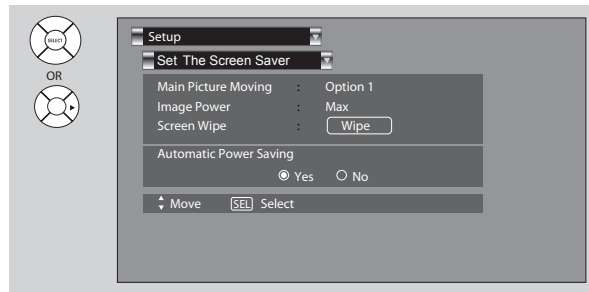
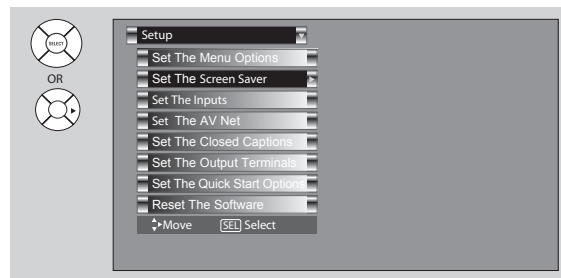

NOTE: This feature is only available in INPUT 1-5.

Setup

Set The Inputs

Use this feature to give a name to any of the five video inputs.

1. Press the **CURSOR PAD ▲** or **▼** to highlight the video inputs.
2. Press the **CURSOR PAD ◀** or **▶** to select your choices.

Note: The inputs labeled *Gray out (Skip) or Hide (Skip)* are disabled in the **INPUTS** selection.

INPUT 4 Auto Link

Use this function to automatically turn the TV on and tune to INPUT 4 when it detects a video signal to INPUT 4.

1. Use the **CURSOR PAD ▲, ▼, ◀** or **▶** to highlight and select the **AUTO LINK** setting of your choice.

- Auto

When **AUTO** is selected, the TV will turn on and switch to INPUT 4 automatically, when the INPUT 4 input device is turned on. This is convenient when you want to watch a movie with your VCR, laserdisc player or DVD player.

- Remote

When **REMOTE** is selected, the TV will turn on and switch to INPUT 4 automatically when the INPUT 4 input device is turned on and the VCR, laserdisc, or DVD play button on your remote control is pressed. This is convenient when you want to record a movie with your VCR and watch it later.

- Off

Select **OFF** to disable this function.

2. Press **EXIT** to quit menu or select **SET THE INPUTS** to return to previous menu.

NOTE: 1. Once the TV has been turned on using the **AUTO LINK** feature, it must be reset before **AUTO LINK** is used again. To do this, turn your VCR, laserdisc, or DVD player OFF. This feature is now reset and will turn on your TV as described above.
2. When using **REMOTE** mode, any remote control button will substitute for your video input device play button. However, intended operation is for use with your VCR, laserdisc, or DVD play button.
3. If no remote control button is pressed after the TV is turned on by **AUTO LINK**, the TV will automatically turn off after three hours.

Set AV Net (only HDX model)

Use this feature to control your external Audio/Video equipment using your HITACHI Plasma TV Remote Control. The IR Blaster cable must be properly connected for the AV NET feature to work.

1. Press the **MENU** button.
2. Use the **CURSOR PAD ▼** or **CHANNEL WHEEL** to highlight **SETUP**.
3. Press the **SELECT** button to select.
4. Use the **CURSOR PAD ▼** or **CHANNEL WHEEL** to highlight **SET AV NET** feature.
5. Press the **SELECT** button to select.

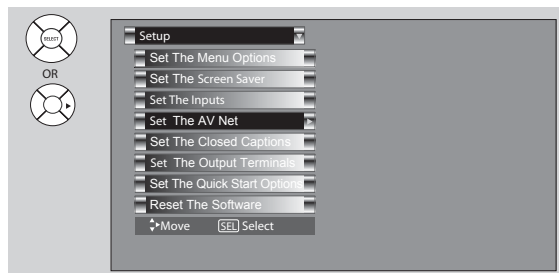
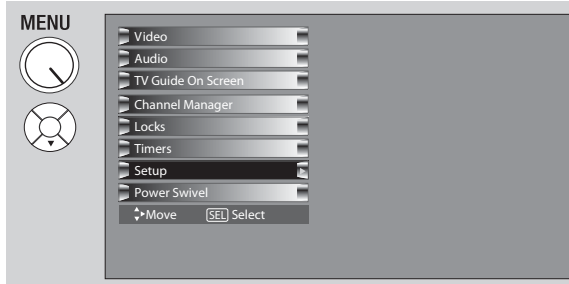
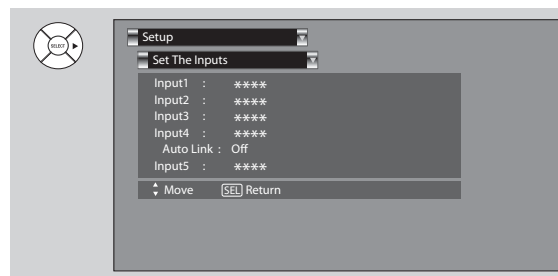
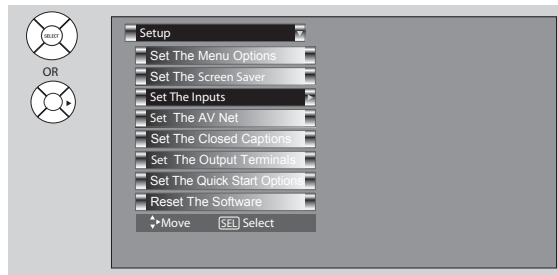

AV NET SETUP WIZARD (Example: A/V RECEIVER Setup)

1. Press the SELECT button to start the SETUP WIZARD.



2. Use the CURSOR PAD ▲ or ▼ to highlight YES or NO.
3. Press the SELECT button to select "YES". (Select YES to setup an A/V Receiver or NO to setup other devices).
4. Use the CURSOR PAD ◀, ▶, ▲ and ▼ to highlight NEXT, then press the SELECT button to move on to the next SETUP screen.

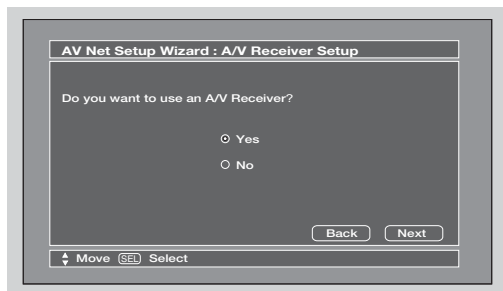

5. Use the CURSOR PAD ◀ or ▶ to choose the brand name of your A/V Receiver.
6. Use the CURSOR PAD ◀, ▶, ▲ and ▼ to highlight NEXT, then press the SELECT button to move on to the next SETUP screen.

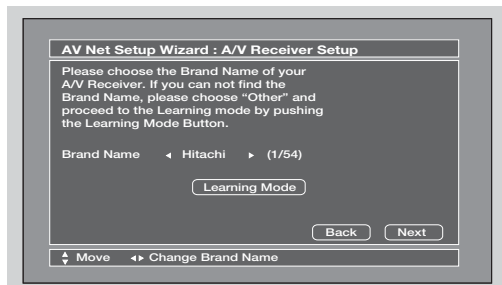

7. Use the CURSOR PAD ◀ or ▶ to choose the preset IR Code.
8. Use the CURSOR PAD ▼ to highlight the "POWER" Test button. These On-screen buttons are called "Soft Keys".
9. Press the SELECT button to pass the Power command through the IR Mouse and onto the A/V Receiver (Repeat steps 7 to 9 until finding the IR code that will power up the A/V Receiver. If the A/V Receiver turns ON, then you have found the correct preset IR code).

10. Use the CURSOR PAD ◀, ▶, ▲ and ▼ to highlight NEXT, then press the SELECT button to move on to the next SETUP screen.

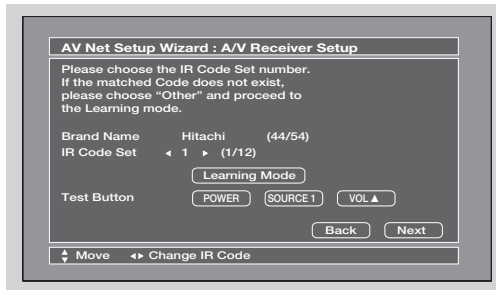

11. Use the CURSOR PAD ◀ or ▶ to select the TV Input that connects to the video and audio output of the A/V Receiver.
12. Use the CURSOR PAD ◀, ▶, ▲ and ▼ to highlight NEXT, then press the SELECT button to move on to the next SETUP screen.



13. Use the CURSOR PAD ◀ or ▶ to select the A/V Receiver Source if you have connected the Monitor Out and Optical Out to the A/V receiver. Select " Not Connected " if not used.
14. Use the CURSOR PAD ◀, ▶, ▲ and ▼ to highlight NEXT, then press the SELECT button to move on to the next SETUP screen.



- If you would like to label your A/V Receiver Source, use the CURSOR PAD ◀ or ▶ to highlight “ Yes “ then press the SELECT button to continue. Selecting “ No “ will bypass the Source labeling.

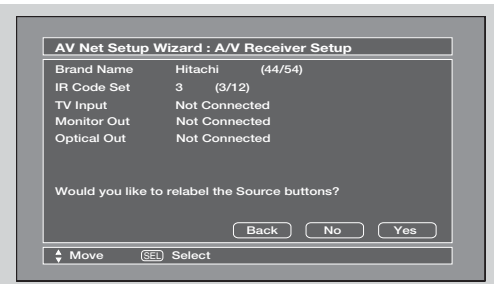

- Use the CURSOR PAD ▲ or ▼ to select your A/V Receiver Sources.
- Use the CURSOR PAD ◀ or ▶ to label your A/V Receiver Sources.
- Use the CURSOR PAD ◀, ▶, ▲ and ▼ to highlight NEXT, then press the SELECT button to move on to the next SETUP screen.

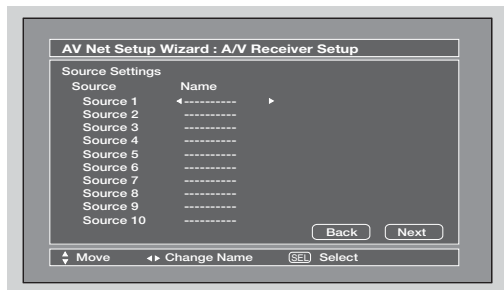

- Confirm all settings, then press the SELECT button to move on to the next SETUP screen.



- Press SELECT to setup another device or use the CURSOR PAD ◀ or ▶ to highlight “ No thanks, I’m done “, then press the SELECT button to exit the AV NET SETUP.



AV NET SETUP WIZARD (Example: DVD Setup)

- Press the SELECT button to start the SETUP WIZARD.



- Use the CURSOR PAD ▲ or ▼ to highlight NO.
- Press the SELECT button to select. (Select NO to setup other devices).
- Use the CURSOR PAD ◀, ▶, ▲ and ▼ to highlight NEXT, then press the SELECT button to move on to the next SETUP screen.

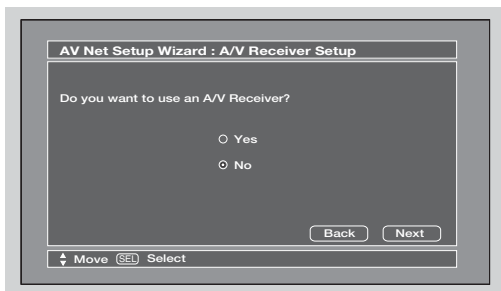

- Use the CURSOR PAD ◀, ▶, ▲ and ▼ to highlight the device. (Example : DVD Setup).
- Press the SELECT button to select.
- Use the CURSOR PAD ◀, ▶, ▲ and ▼ to highlight NEXT, then press the SELECT button to move on to the next SETUP screen.



8. Use the CURSOR PAD ◀ or ▶ to choose the brand name of your DVD.
9. Press the CURSOR PAD ▼ to highlight the IR CODE Set, then use the CURSOR PAD ◀ or ▶ to choose the preset IR Code.
10. Use the CURSOR PAD ▼ to highlight the “POWER” Test button.
These On-screen buttons are called “Soft Keys”.
11. Press the SELECT button to pass the Power command through the IR Mouse and onto the DVD.
(Repeat steps 9 to 11 until finding the IR code that will power up the A/V Receiver. If the DVD turns ON, then you have found the correct preset IR code).
12. Use the CURSOR PAD ◀, ▶, ▲ and ▼ to highlight NEXT, then press the SELECT button to move on to the next SETUP screen.

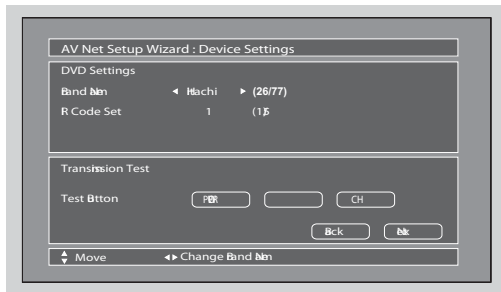

13. Use the CURSOR PAD ◀ or ▶ to select the TV Input that connects to the video and audio output of the DVD.
14. Use the CURSOR PAD ◀, ▶, ▲ and ▼ to highlight NEXT, then press the SELECT button to move on to the next SETUP screen.

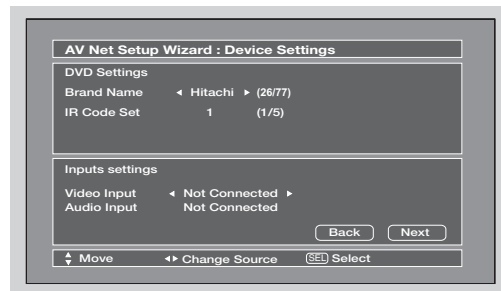

15. Confirm all settings, then press the SELECT button to move on to the next SETUP screen.



16. Press the SELECT button to select YES to Setup another device. Press the CURSOR PAD ◀ or ▶ to highlight “No thanks, I'm done”, then press the SELECT button to exit the AV NET SETUP.



Learning Mode

This function of the AV NET allows the user to use equipment that is not supported by the AV NET codes. After programming your equipment to the AV NET and the Soft Keys do not work, you can manually “LEARN” each one by completing the Learning Mode. The Learning Mode will transfer any remote control button IR code of your equipment to the “Soft Keys” of your AV NET.

Learning Mode (Example: A/V Receiver Setup)

1. Press the SELECT button to start the SETUP WIZARD.



2. Use the CURSOR PAD ▲ or ▼ to highlight YES.
3. Press the SELECT button to select.
4. Use the CURSOR PAD ◀, ▶, ▲ and ▼ to highlight NEXT, then press the SELECT button to move on to the next SETUP screen.

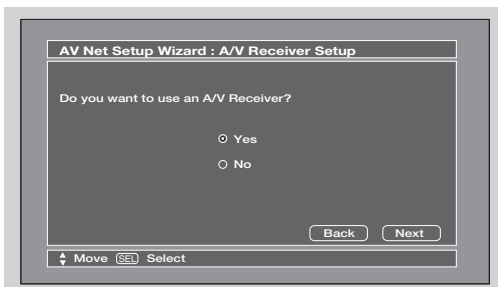

Setup

- Use the CURSOR PAD ◀ or ▶ to select "Other" from brand name choices.
- Use the CURSOR PAD ▲ or ▼ to highlight "Learning Mode" then press the SELECT button.

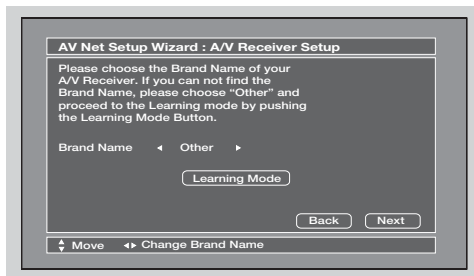

- Use the CURSOR PAD ◀, ▶, ▲ and ▼ to select the Soft Key to learn (Ex. VOL ▲), then press the SELECT button.

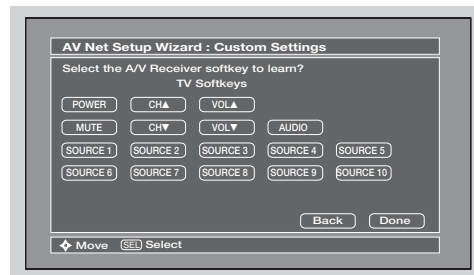

- Press and hold the VOL ▲ button of your A/V Receiver remote control while pointing directly at the learning AV NET sensor of the Plasma TV (located at the lower right corner of the screen) at a distance of 3.2 feet or 1 meter maximum.

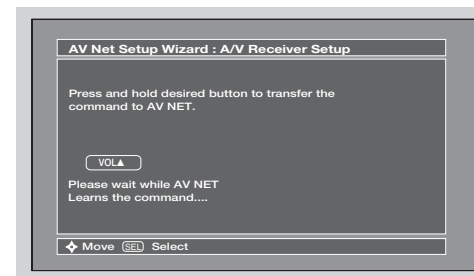

- If the IR code transfer was not completed, the screen below appears. Repeat step 8 to try again.

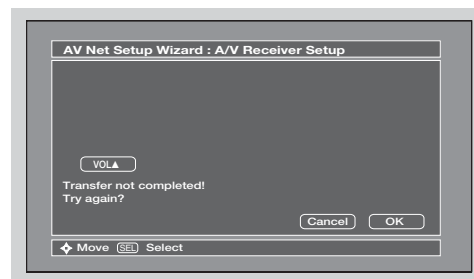

- If the IR code transfer was successful, the screen below appears, then select "OK" to continue setup.

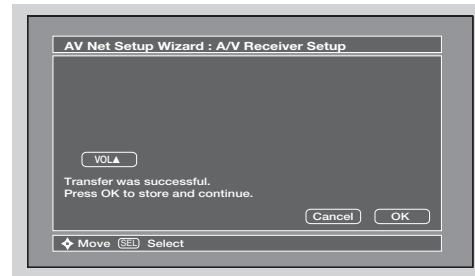

- Select another Soft Key to learn or select DONE to move on to the next screen.

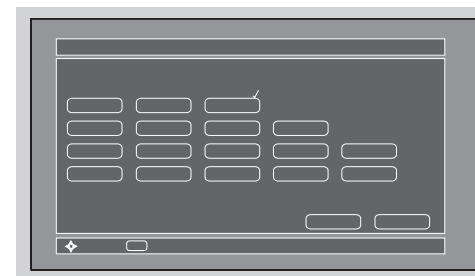

- Select the Test button VOL ▲ to check the response of the device to this command.
- Use the CURSOR PAD ◀, ▶, ▲ and ▼ to highlight NEXT, then press the SELECT button to move on to the next SETUP screen.

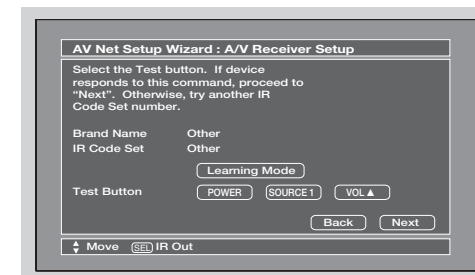

- Use the CURSOR PAD ◀ or ▶ to select the TV Input that connects to the video and audio output of the A/V Receiver.
- Use the CURSOR PAD ◀, ▶, ▲ and ▼ to highlight NEXT, then press the SELECT button to move on to the next SETUP screen.

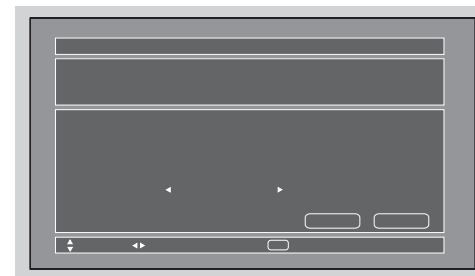

- Use the CURSOR PAD ◀ or ▶ to select the A/V Receiver Source if you have connected the Monitor Out and Optical Out to the A/V Receiver. Select "Not Connected" if not used.
- Use the CURSOR PAD ◀, ▶, ▲ and ▼ to highlight NEXT, then press the SELECT button to move on to the next step.

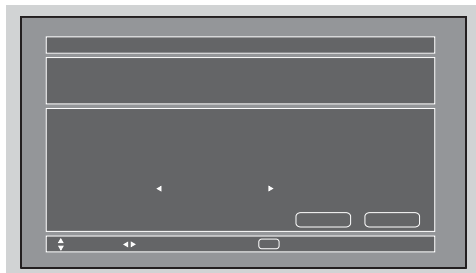

- If you would like to label your A/V Receiver Source, use the CURSOR PAD ◀ or ▶ to highlight "Yes", then press the SELECT button to continue. Selecting "No" will bypass the Source Labeling.

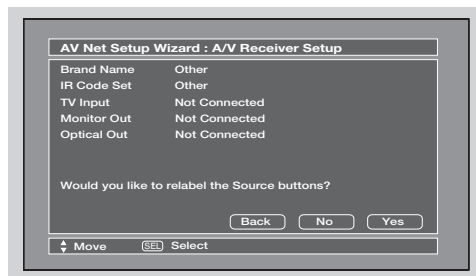

- Use the CURSOR PAD ▲ or ▼ to select your A/V Receiver Sources.
- Use the CURSOR PAD ◀ or ▶ to label your A/V Receiver Sources.
- Use the CURSOR PAD ◀, ▶, ▲ and ▼ to highlight NEXT, then press the SELECT button to move on to the next SETUP screen.

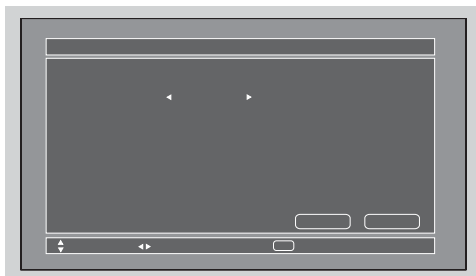

- Confirm all settings, then press the SELECT button to move on to the next SETUP screen.

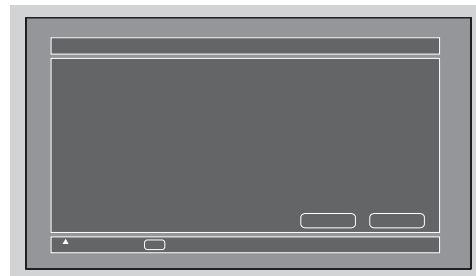

- Select "YES" to setup another device or select "No, thanks, I'm done" to exit the AV Net setup.

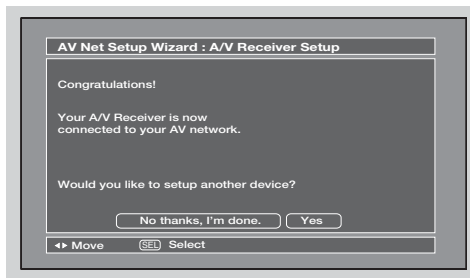

Learning Mode (Example: CUSTOM/DVD 3 Setup)

- Press the SELECT button to start the SETUP WIZARD.



- Use the CURSOR PAD ▲ or ▼ to highlight NO.
- Press the SELECT button to select "NO". (Select NO to setup other devices).
- Use the CURSOR PAD ◀, ▶, ▲ and ▼ to highlight NEXT, then press the SELECT button to move on to the next SETUP screen.

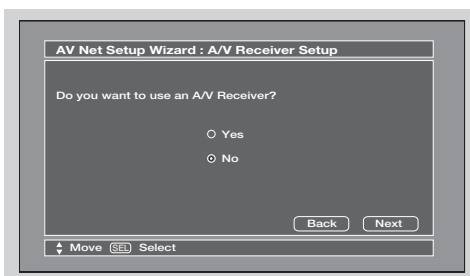

- CURSOR PAD ◀, ▶, ▲ and ▼ to highlight "Custom", then press the SELECT button to select.
- Select NEXT to continue.



Setup

- Use the CURSOR PAD ◀ or ▶ to choose the device you wish to learn. (Example: DVD 3)
- Select NEXT to continue.



- Select the DVD 3 softkey to learn. (Example: PLAY ▶ button).
- Select Done to continue.

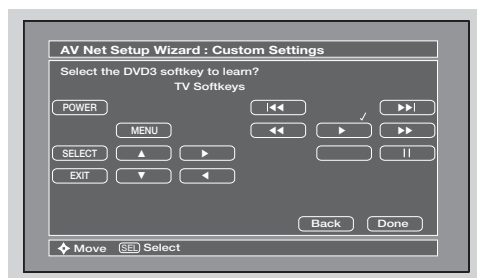

- Press and hold the ▶ “Play button” of the DVD remote control while pointing directly at the learning AV NET sensor of the Plasma TV (located at the lower right corner of the screen) at a distance of 3.2 feet or 1 meter maximum.

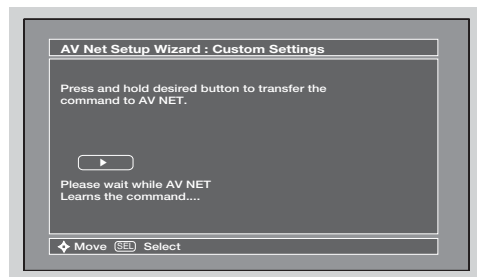

- If the IR Code transfer was successful, the screen below appears, then select “OK” to continue setup.



- Select another softkey to learn or select “DONE” to move on to the next screen.

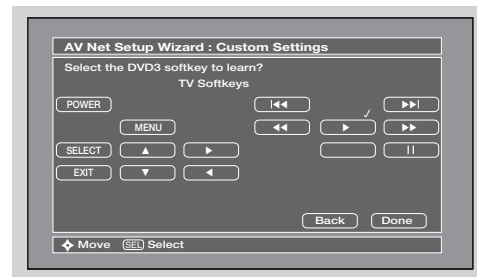

- Select the Test button ▶ “Play button” to check the response of the device to this command.
- Use the CURSOR PAD ◀, ▶, ▲ and ▼ to highlight NEXT, then press the SELECT button to move on to the next SETUP screen.

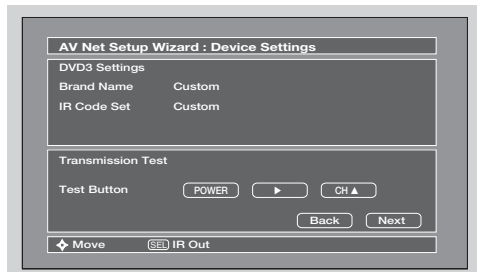

- Use the CURSOR PAD ◀ or ▶ to select the TV Input that connects to the video and audio output of the DVD.
- Use the CURSOR PAD ◀, ▶, ▲ and ▼ to highlight NEXT, then press the SELECT button to move on to the next SETUP screen.

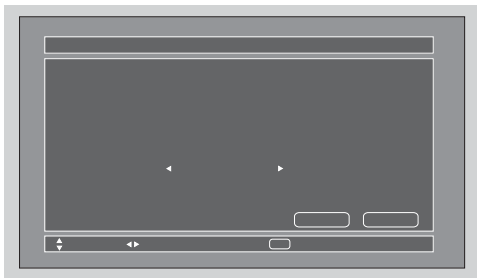

- Confirm all settings, then press the SELECT button to move on to the next SETUP screen.

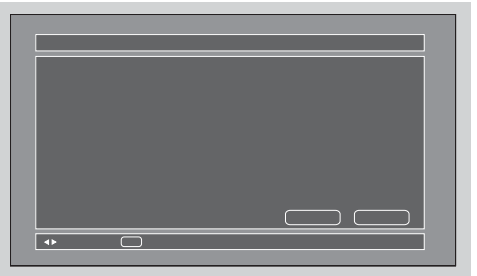

Setup





19. Continue with the normal procedures to setup TV Input, Monitor Out, Optical Out and the labeling of the source buttons.
20. Select "YES" to setup another device or select "No thanks, I'm done" to exit the AV NET setup.



- NOTE:**
1. After a successful AV NET setup to a chosen TV Input, the user can access soft key controls by selecting the device in the inputs menu.
 2. Each Device and Custom setting only accepts one device at a time. The second device/custom setup will give the user the options to either modify or delete the device.
 3. When setting up devices that have Monitor Out options (examples: A/V receiver, VCR), the Monitor Out and Audio Out will have default settings of TV Tuner out and Fixed respectively.
 4. Before changing or modifying the Video and Audio Inputs, both should be set to "Not Connected" to access available options.
 5. The device label will show on the Inputs menu until deleted or modified.
 6. The AV NET setup will have priority over the Input setup.
 7. For devices which have any or all of these functions, Play, Rewind, Fast Forward, Record, Stop and Pause, the Remote Control equivalent buttons may be used to perform these operations.

Set The Closed Captions

Closed Captions are the dialogue, narration, and/or sound effects of a television program or home video which are displayed on the TV screen. Your local TV program guide denotes these programs as **CC** or .

1. Use the **CURSOR PAD** , ,  and  to highlight and select the function to change.
2. Press **EXIT** to quit menu or select **SET THE CLOSED CAPTIONS** to return to the previous menu.

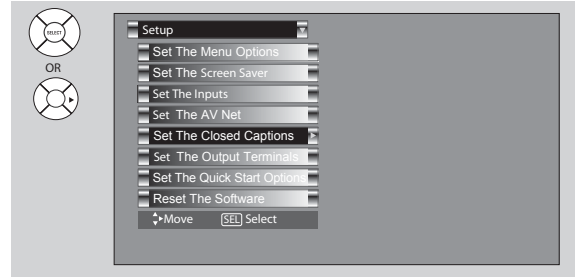

Caption Display:

ON/OFF will turn the **CC** display on or off.
AUTO will turn the **CC** display on when Mute/Soft Mute is on.

Analog Captions:

Set **CAPTIONS** for Analog programs. This function will help choose and set available mode and channel.

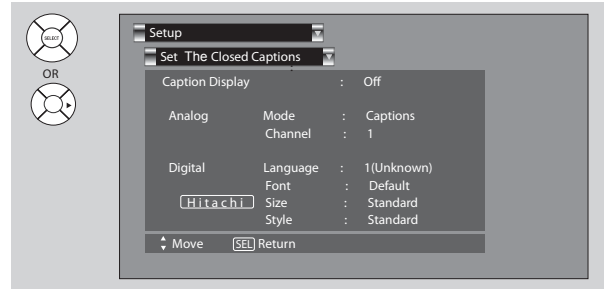

Caption Mode:

CAPTIONS is for the program you are viewing.





TEXT is for additional information such as news reports or a TV program guide. This information covers the entire screen and viewing the TV program is not possible. Text may not be available with every **CC** program.

Channel:

- 1 is used for the primary language (usually English).
- 2 is sometimes used for a second language (may vary by region).
- 3 is sometimes used for a third language (may vary by region).
- 4 is sometimes used for a fourth language (may vary by region).

Digital Captions

Set captions for digital programs. This function will help choose and set available language, font, size and style of digital captions.

1. Use the **CURSOR PAD** , ,  or  to highlight and select desired **DIGITAL CAPTIONS** feature.
2. Press **EXIT** to quit menu or select **SET CLOSED CAPTION** to return to the previous menu.

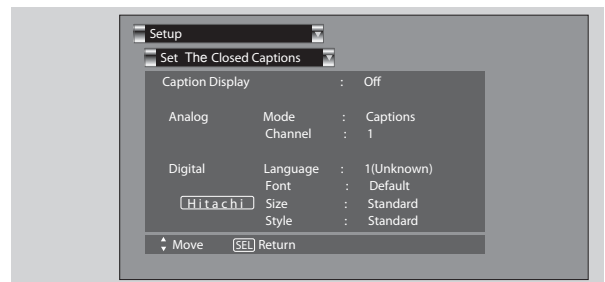

- NOTE:**
1. Some types of digital closed captions will not work with this TV.
 2. Caption Display will not work when viewing a 480p, 720p, or 1080i input via the **COMPONENT: Y-PbPr** inputs.
 3. Digital Captions Font Style are sometimes different from the Font Style of Analog Captions.
 4. Closed Caption and Digital Captions availability and content depends on the broadcaster. Closed Caption is available when Closed Caption icon is displayed on screen.
 5. Digital Captions will not be available (grayed out) when using analog channels.

Setup

Set The Output Terminals

This feature will select the source of the Output Terminal.

Video Out :

- Select **MONITOR** to output the audio and video signals of the chosen input source (**CABLE, AIR or INPUT 1-5**) to a VCR or other A/V device.
- Select **TV TUNER OUT** to output the audio and video signals of the last watched Antenna Source (**CABLE, AIR**).

Audio Out:

- Select **AUDIO OUT FIXED** to have the Audio at fixed volume.
- Select **AUDIO OUT VARIABLE** to have Audio volume that can be controlled by the Plasma TV Volume Up/Down.

Video Out	Audio Out	Use
Monitor	Fixed	To record currently viewed Video and Audio.
Monitor	Variable	When an external device like a monitor or Hi-Fi audio system is connected to the audio and video output of the TV. You can control the volume output by changing the volume of the TV.
TV Tuner Out	Fixed	To record currently viewed Video and Audio from either Cable or Air.

IR Out :

- Select **IR OUT NORMAL LENGTH** to pass remote control signal to IR Out Terminal as is and reach 2m (max) through provided IR Blaster CABLE.
- Select **IR OUT EXTENDED LENGTH** to process remote control signal to IR Out Terminal and reach 5m (max) through provided IR Blaster CABLE.

NOTE : Extended Length function is not available for some kinds of external components. For those components use Normal Length function, or point the remote control directly at the external components.

1. Use **CURSOR PAD ▲** or **▼** or **CHANNEL WHEEL** to highlight the function to change.
2. Use the **CURSOR PAD ◀** or **▶** to select the function.
3. Press **EXIT** to quit menu or select **SET THE OUTPUT TERMINALS** to return to previous menu.

NOTE: 1. When **TV TUNER OUT** is selected, **VARIABLE AUDIO OUT** will not be available (grayed out).
2. When using **MONITOR OUT** for recording, set the **VIDEO OUT** to **MONITOR**.

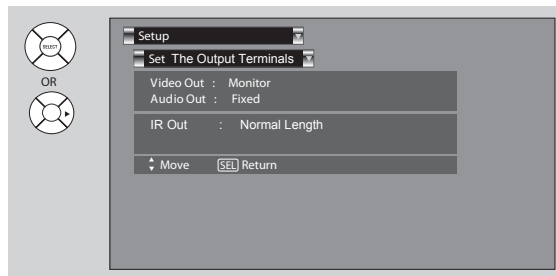

MONITOR: Available Monitor Out Signals

TV TUNER OUT: Available Monitor Out Signals

Input Mode			Monitor Out				
			S-Video	Video	L/R	HiFi	
ANT (Air or Cable)	Digital Channel	No Macrovision	S-Video	YES	YES	YES	YES
		Macrovision	S-Video	-	-	-	YES
	Analog Channel		Video	-	YES	YES	YES
Input 1	HDMI_1			-	-	-	YES
	S-Video_1			YES	YES	YES	YES
	Video_1			-	YES	YES	YES
Input 2	HDMI_2			-	-	-	YES
	S-Video_2			YES	YES	YES	YES
	Video_2			-	YES	YES	YES
Input 3	Y-PbPr_3			-	-	-	YES
	Video_3			-	YES	YES	YES
Input 4	Y-PbPr_4			-	-	-	YES
	Video_4			-	YES	YES	YES
Input 5	HDMI_5			-	-	-	YES
	Y-PbPr_5			-	-	-	YES
	Video_5			-	YES	YES	YES

Input Mode				Monitor Out (TV Tuner Out)			
				S-Video	Video	L/R	HiFi
ANT (Air or Cable)	Digital Channel	No Macrovision	S-Video	YES ANT	YES ANT	YES ANT	YES ANT
		Macrovision	S-Video	-	-	-	YES ANT
	Analog Channel		Video	-	YES ANT	YES ANT	YES ANT
Input 1	HDMI_1		Y-PbPr	YES ANT digital only	YES ANT	YES ANT	YES ANT
	S-Video_1						
	Video_1						
Input 2	HDMI_2		Y-PbPr	YES ANT digital only	YES ANT	YES ANT	YES ANT
	S-Video_2						
	Video_2						
Input 3	Y-PbPr_3			YES ANT digital only	YES ANT	YES ANT	YES ANT
	Video_3						
Input 4	Y-PbPr_4			YES ANT digital only	YES ANT	YES ANT	YES ANT
	Video_4						
Input 5	HDMI_5		Y-PbPr	YES ANT digital only	YES ANT	YES ANT	YES ANT
	Y-PbPr_5						
	Video_5						

Setup

CableCARD Information

After the CableCARD has been successfully installed, you can access CableCARD Information menu in the SETUP menu of the On-Screen Display.

Follow the instructions below to access the CableCARD Information menu.

1. Press the **MENU** button on the Remote Control to access the Main Menu screen.
2. Use the **CURSOR PAD ▼** to highlight **SETUP** in the Main Menu and press the **SELECT** button.
3. Use the **CURSOR PAD ▼** to highlight **CableCARD Information** and press the **SELECT** button.
4. To view the CableCARD ID and Host ID, use the **CURSOR PAD ▼** to highlight **CableCARD Info** and press the **SELECT** button.

NOTE: *The Diagnostics Info. window is for Service use only.*

THINGS TO CHECK WHEN USING THE CableCARD / CableCARD Services

1. Check that the CableCARD is properly inserted in the CableCARD slot.
2. Remove the CableCARD by pulling the CableCARD straight out.
3. Visually inspect the CableCARD to ensure all pin-holes are in good condition, with none blocked or damaged.
4. Make sure the CableCARD is re-inserted in the correct direction, then slowly push until it is fully seated in the slot.
5. When the CableCARD is installed, note all screen messages that appear (“CableCARD Installed”, “Acquiring Data”, “CableCARD is not Installed”). If the “CableCARD Installed” message does not appear when card is installed, check the TV’s card slot and CableCARD pins for obstructions or damage.
6. If problems still remain, please contact your Cable Service Provider.

NOTES:

1. *When a CableCARD is installed, Auto Channel scan will not be needed because the channel list is automatically loaded to the TV's channel memory.*
2. *The TV will take several minutes to detect and recognize the presence of the CableCARD. This process must be completed before any CableCARD information or Channel listings is accessed.*

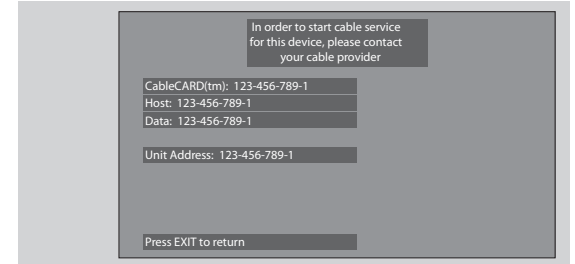
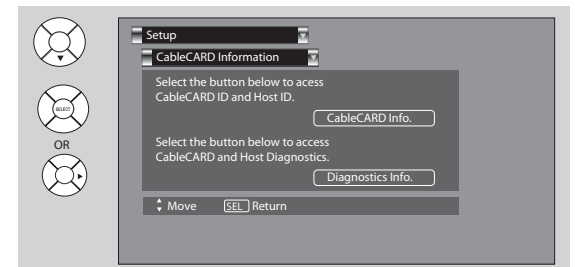
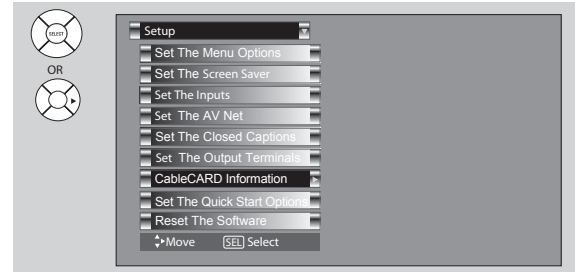
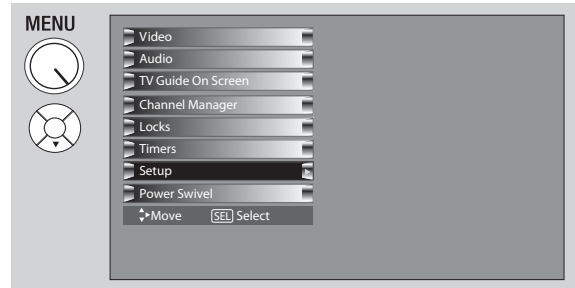

Setup

Set The Quick Start Options

This feature will select **QUICK START UP** options. Set this feature to **ON** to have the TV tune channels (both Analog and Digital) quickly when first turning the TV on. Set this feature to **OFF** to save electricity. Selecting **ON** for the **QUICK START UP** feature will activate the TV tuners circuits when the TV is in "standby mode" which is commonly referred to as "off". This will allow you to quickly tune to channels when first turning the TV on. Digital signals often change and this feature will monitor any changes and prepare the television to quickly present a picture. A small amount of electricity is used to continually monitor signals when this feature is selected.

This feature also sets the IEEE1394 function in Stand By-mode to ON or OFF. Certain digital devices have a power save feature, in which the device automatically power OFF when not in use (sleep mode). Only by setting the IEEE1394 function in Stand-By mode to ON, will the TV be able to control a device that is in sleep mode.

NOTE: 1. By turning on the IEEE1394 function, your TV will no longer be set for power saving Stand-By mode. The IEEE Stand-By function must be set to OFF to return your TV set to power saving Stand-By mode.

2. When setting the Quick Start option to ON the option of Reset TV Settings will not operate.

Reset The Software

This feature shows software information and easy upgrade procedure. This function allows the TV software to be upgraded by using a flash card (**MMC CARD**). If a future software upgrade is required for your TV, **HITACHI** will notify and provide you with a flash card. In order to receive written notification and the flash card, please complete and return the warranty card.

1. Insert **MMC CARD**
2. Press the **CURSOR PAD ▲** or **▼** to highlight **UPGRADE NOW**.
3. Press the **SELECT** button to select and start upgrading.
4. Unplug the AC power cord when the **UPGRADE** is complete.

NOTE: Any power interruption during the upgrade process will cancel the upgrade. When this happens, repeat the upgrade procedure.



HDX Models

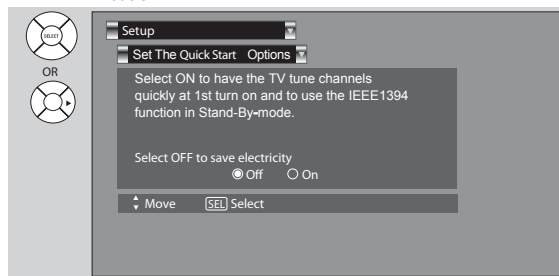

HDT Models

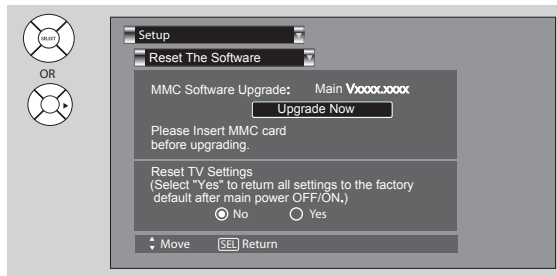
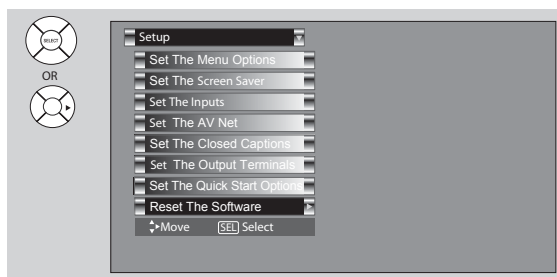
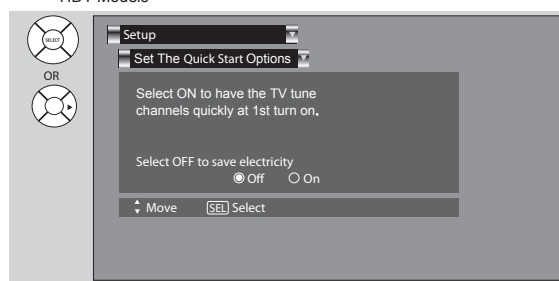

Setup

Reset TV Settings

This function allows you to Reset all TV Settings to the original factory settings on all modes during the next main power on/off.

1. Use CURSOR PAD ▲, ▼ to highlight functions.
2. Press the SELECT button or CURSOR PAD ► to select Reset The Software.
3. Use the CURSOR PAD ▼ to access the Reset TV Settings option.
4. Select the "YES" option to Reset ALL the TV Settings during the next main power on/off.

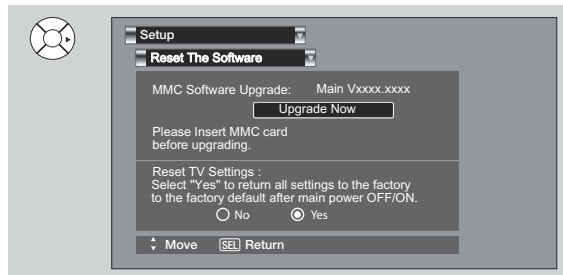

NOTE: If YES is selected, ALL TV MENU SETTINGS will be reset to the original factory settings on all modes during the next power on/off.

Power Swivel

This feature controls the motorized stand. It allows the customer to turn the plasma display left or right using the remote control. This feature is only available when the Table Top Stand is connected.

1. Use the CURSOR PAD ◀ or ▶ to unlock or lock the Power Swivel.
Exit the OSD menu system before controlling the motorized stand.
2. Press the CURSOR PAD ► to rotate the TV to the right.
3. Press the CURSOR PAD ◀ to rotate the TV to the left.
4. Release the CURSOR PAD to stop rotation.

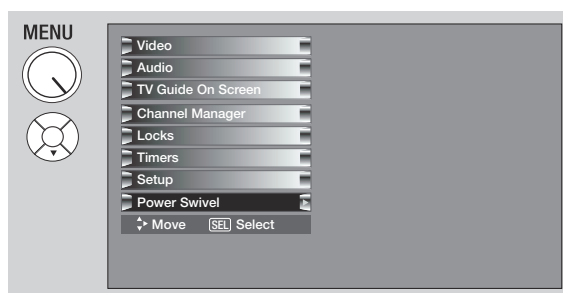

- NOTE:**
1. The Power Swivel has a maximum turning radius of 30° (left and right).
 2. Do not place any objects in the path of the monitor when using the power swivel feature.
 3. Before using the power swivel, please make sure that the path of the monitor is clear of any fingers, hands or any other body parts to avoid causing injury.
 4. When the Picture-In-Picture (PIP) or Freeze mode is ON, the Power Swivel is disabled.

Equipment Care and Troubleshooting

DO

Dust the screen and cabinet with a soft cloth.

Clean the screen with a soft cloth moistened in warm water and dry with a soft cloth. A mild soap may be used if the screen is extremely dirty.

Place your Plasma Television away from extreme heat, humidity, and extremely dusty places.

Remove the plug from the wall outlet if your Plasma Television will not be used for a long period of time, for instance, when you go on vacation.

DO NOT

Do not clean your screen with strong cleaners, polishes or a chemically treated cloth.

Do not place rubber or vinyl products or cellophane tape on your Plasma Television.

Avoid repeatedly touching the screen.

Do not subject the remote control to shocks such as dropping it on the floor, etc. This may cause damage to the precision parts.

Avoid placing the remote control in a high humidity place or getting it wet. Do not leave it on or near a heater. Excessive heat or moisture may cause the unit to fail.

When the batteries run down, remote control operation will become erratic or become unresponsive. Replace the old batteries with two new "AA" size batteries. Do not use an old battery with a new battery.

Exposing the screen to direct sunlight for a long period of time or heat may cause damage to the plasma screen.

TROUBLESHOOTING

Your **HITACHI** Plasma Television incorporates advanced power surge protection technology designed to protect against component or circuit damage due to external or internal voltage power surges.

IF YOUR TELEVISION SHOULD APPEAR TO HAVE A LOSS OF POWER, PLEASE FOLLOW THIS PROCEDURE:

1. Press the **POWER SWITCH (ON/OFF SWITCH)** once.
2. If there is still no power, wait 30 seconds and press the **POWER SWITCH** again.
3. If there is still no power, unplug the power cord from the wall. Wait 30 seconds and plug the power cord back in. Press the **POWER SWITCH** again.

This protective technology should provide for years of lasting entertainment from your **HITACHI** Plasma Television.

SYMPTOMS	CHECK THESE ITEMS AND TRY THESE ADJUSTMENTS											
	Be sure external connection is correct	Be sure power cord is plugged in	Be sure TV is switched "ON"	Try another channel (station trouble)	Check antenna connections (back of TV)	Check outside antenna	Check for local interference	Adjust Contrast control	Adjust Brightness control	Adjust Color control	Adjust Tint control	Adjust Volume control
No Picture, no sound	●	●	●	●	●	●						
Sound OK, picture poor	●			●	●	●	●	●				
Picture OK, sound poor	●			●	●	●	●					●
Picture blurred	●			●	●	●	●	●				
Lines or streaks in picture				●	●	●	●	●				
Poor reception on some channels				●	●	●	●	●				
Picture rolls vertically				●				●				
No color	●			●	●	●	●			●		
Poor color	●			●	●	●	●			●	●	

Reception Problems

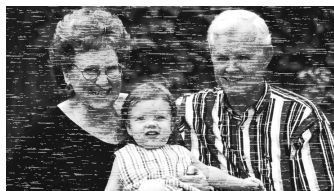

IGNITION NOISE:

Black spots or horizontal streaks may appear, picture may flutter or drift. Usually caused by interference from automobile ignition systems, neon lamps, electrical drills, and other electrical appliances.



GHOSTS:

Ghosts are caused by the television signal following two paths. One is the direct path and the other is reflected from tall buildings, hills or some other objects. Changing the direction or position of the antenna may improve reception. Ghosting may also be caused by defects in the antenna system such as unshielded leads or connecting several sets to the same antenna without using multiple antenna couplers.



SNOW:

If your receiver is located in the fringe area of a television station where the signal is weak, your picture may be marred by the appearance of small dots. When the signal is extremely weak, it may be necessary to install a special antenna to improve the picture.

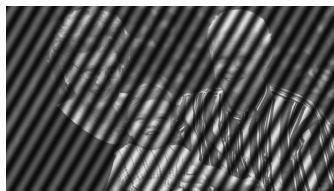

RADIO FREQUENCY INTERFERENCE:

• RADIO FREQUENCY INTERFERENCE:

The interference produces moving ripples or diagonal streaks, and in some cases, causes loss of contrast in the picture.

• PREVENTION OF AN OBSTACLE TO RADIO RECEIVERS

This television has been designed pursuant to the FCC class B Rules. This is to prevent a problem to Radio receivers. If this television causes a problem to Radio receivers, then take the following steps:

- Keep the television away from Radio.
- Adjust Radio antennas in order for the television not to receive interference.
- The antenna cable of Radio should be kept away from the television.
- Use a coaxial cable for antenna.

You can check if this television influences Radio receivers by turning off all other equipment other than the television. If you find a problem receiving Radio when using the television, check the instructions mentioned above.



BLOCK NOISE (DIGITAL INPUT):

Fuzzy blocks may appear in some area or the whole area of the screen. This is usually caused by interference from automobile ignition systems, neon lamps, electrical drills, ghosting of the image and weak signals.

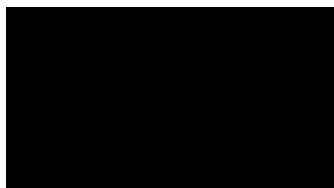

BLACK SCREEN:

When using an antenna, weak signals will display a black screen. It may be necessary to upgrade your antenna.

NOTE: The TV set can generate sound distortion in external devices such as a radio. Please separate radio equipment from the TV set to a considerable distance.

Troubleshooting

1. Plasma Television Troubleshooting

No.	Items	Notes
1	Buzzing sound from Plasma display panel.	A buzzing sound may be heard when the plasma television is turned on in a very quiet room. This is due to the plasma panel drive circuit when it is functioning. The buzzing sound is normal and is not a malfunction.
2	Infrared interference	Some infrared rays are emitted from the plasma television panel that might affect the operation of other infrared controlling equipment.
3	Bright and dark spots	High precision technology is used to manufacture the plasma television. But there maybe points that do not illuminate, points that are too bright, and points with color different from that of the periphery. Please note that this is not a malfunction.
4	Picture Image	In some cases, residual images may remain after the short term display of still images when the picture changes.
5	Display panel surface temperature is too high.	The plasma display panel display images by means of electrical discharges inside the panel. This may cause the temperature of the panel surface to increase. Please note that this is not a malfunction.
6	Plasma Surface	A reinforced glass filter is installed over the plasma panel surface. A strong impact to the front panel risk a danger of glass breakage.
7	Transportation	Please transport the plasma television in it's packing box and placed in an upright position. Do not transport the plasma television in a horizontal position. This increases the possibility of panel breakage and pixel failure.
8	Granular spots	When a screen is seen at point-blank range, a random fine grain may be visible in the dark areas of the picture.
9	High temperature environment	High temperature affect the electric discharge/luminescence characteristic of the PDP panel. Do not place the plasma television in high temperature environments.
10	Operation	Operating altitude: 800 to 1,114hPa (6,194ft to -2,484ft). Operating temperature: 41°F to 95°F.
11	Storage	Storage altitude: 300 to 1,114hPa (31,912ft to -2,484ft). Storage temperature: 5°F to 140°F
12	Power ON or OFF	Repeatedly turning the plasma television Power ON and OFF at short intervals may result in failure of the television.

2. TV Guide On-Screen™ System Frequently Asked Questions

My Guide listings disappeared after a power failure.

You should begin to receive listings again within 24 hours.

Some channel numbers in the Guide are incorrect.

You can correct them using Change Channel Display under Setup.

I have not received any Guide show listings.

Listings usually begin to appear within 24 hours after a successful Setup. It may take up to 5 days to receive a full 8 days of program listings.

- Check the connections between the TV, cable, antenna, and the IR cable if using a cable box.
- Verify Setup information under Change System Settings.
- Make sure the cable box is On, if applicable.
- Review Screen 4 and Screen 5 in the Initial Guide Setup section.

A show I set to Record did not occur.

- Make sure your recorder is turned Off before the recording begins.
- Make sure there is a tape or DVD in the VCR or DVD Recorder.
- Check the Schedule menu and verify that the show is listed before recording begins.
- Check the placement of the IR cable in front of your recorder.

The TV did not tune to a show I scheduled with the Reminder feature.

- Check the Schedule menu and verify that the show is listed.
- If you have a cable box, check the IR cable.

I set a show to Auto-Tune and it did not.

- Check the Schedule menu and verify that the show is listed as a Reminder.
- Highlight the show under Listings and do the following:
 - Press the Menu button on the remote.
 - Use the down arrow to highlight Edit Reminder, and press SELECT.
 - Verify the Auto-Tune option reads Yes.
- The TV must be On at the scheduled time for Auto-Tune.

I set a show with the Power On TV option and it did not.

- Check the Schedule menu and verify that the show is listed as a Reminder.
- Highlight the show under Listings and do the following:
 - Press the Menu button on the remote.
 - Use the down arrow to highlight Edit Reminder, and press SELECT.
 - Verify the Power On TV option reads Yes.
- The TV must be Off at the scheduled time for Power On TV.

Troubleshooting

TV Guide On-Screen™ Frequently asked questions continued

If I add a recorder or change my cable service, how do I change my Setup information?

- 1) Highlight the Setup Service in the Guide.
- 2) Use the down arrow to select Change System Settings.
- 3) Follow the on-screen instructions.

A show entry in the Guide reads “No Listing.” What does that mean?

Show information for that entry was not available during the last Guide information update (download). Show information is updated on a daily basis.

When I entered the Guide, I was asked to choose from more than one channel lineup. What should I do?

Select the lineup that most closely matches the one for your area. If after you choose the lineup, you want to make changes to:

- 1) Highlight the Setup Service in the Guide.
- 2) Use the down arrow to select Change Channel Display.
- 3) Follow the on-screen instructions.

What do the color for shows in the Listings and Search screens indicate?

Green=Sports; Dark Blue=Children's; Purple=Movies; Teal=Other Show

If I have a power outage, do I need to complete Setup again?

No; Setup information is stored in TV Guide On Screen.

Is Help available in the Guide? If so, how do I find it?

Yes. Highlight any of the 5 main Services (i.e., Listings, Schedule, Recordings, Setup, Search) and press the Info Button. An Expanded Info Box displays additional help information; press Info again to close the box.

Help is also available in a Panel Menu. Press the Info Button to display an Expanded Info Box; press Info again to close the box.

After some show titles, I have noticed from 1 to 4 stars (****). What does that mean?

These stars are a broadcast-industry rating system used to inform you of a show's quality. The more stars, the better the rating.

I have seen the word “download” in reference to the Guide. What does that mean?

A download sends channel and show information to a TV Guide On Screen device. A download happens at least once a day.

Can I set a Record or Remind event without highlighting a show title in the Guide?

Yes. TV Guide On Screen has a Manual Record and

Remind feature. Highlight Schedule and press menu. Choose the event type, press SELECT and then enter date, start and stop time, channel number, etc.

What do the frequencies for Record and Remind mean?

- **Once**—records/reminds the show one time
- **Daily** (manual only)—records/reminds the time, channel, and input combination Monday through Friday
- **Regularly**— records/reminds for the channel/time combination on any day of the week, on the same channel
- **Weekly**— records/reminds for the channel/time combination on a specific day of the week
- **Off** (not cancel)—keeps the show in the list but will not record/remind the show until the frequency is changed

How can I look for a specific show in the Guide?

Search lets you find shows by Category (HDTV, Movies, Sports, Children, Educational, News, Variety, Series), Keyword, or Alphabetical.



In the United States, TV GUIDE and other related marks are registered marks of Gemstar-TV Guide International, Inc. and/or one of its affiliates. In Canada, TV GUIDE is a registered mark of Transcontinental Inc., and is used under license by Gemstar-TV Guide International, Inc.

The TV Guide On Screen system is manufactured under license from Gemstar-TV Guide International, Inc. and/or one of its affiliates.

The TV Guide On Screen system is protected by one or more of the following issued United States patents 6,498,895; 6,418,556; 6,331,877; 6,239,794; 6,154,203; 5,940,073; 4,908,713; 4,751,578; 4,706,121.

Gemstar-TV Guide International Inc. and/or its related affiliates are not in any way liable for the accuracy or availability of the program schedule information or other data in the TV Guide On Screen system and cannot guarantee service availability in your area. In no event shall Gemstar-TV Guide International, Inc. and/or its related affiliates be liable for any damages in connection with the accuracy or availability of the program schedule information or other data in the TV Guide On Screen system.

AGENCY REGULATORY INFORMATION

Federal Communications Commission Notice

This equipment has been tested and found to comply with the limits for a Class B digital device, pursuant to Part 15 of the FCC Rules. These limits are designed to provide reasonable protection against harmful interference in a residential installation. This equipment generates, uses and can radiate radio frequency energy and if not installed and used in accordance with the instructions, may cause harmful interference to radio communications. However, there is no guarantee that interference will not occur in a particular installation. If this equipment does cause harmful interference to radio or television reception, which can be determined by turning the equipment off and on, the user is encouraged to try to correct the interference by one or more of the following measures:

- Reorient or relocate the receiving antenna.
- Increase the separation between the equipment and the receiver.
- Connect the equipment into an outlet on a circuit different from that to which the receiver is connected.
- Consult the dealer or an experienced radio/television technician for help.

FCC Information

This device complies with part 15 of the FCC Rules. Operation is subject to the following two conditions :
(1) This device may not cause harmful interference and (2) This device must accept any interference received, including interference that may cause undesired operation.

Modifications



The FCC requires the user to be notified that any changes or modifications made to this device that are not expressly approved by Hitachi America ,Ltd. Home Electronics Division may void the user's authority to operate the equipment.

Cables

Connections to this device must be made with shielded cables with metallic RFI/EMI connector hoods to maintain compliance with FCC Rules and Regulations.

Any cables that are supplied with the system must be replaced with identical cables in order to assure compliance with FCC rules. Order Hitachi spares as replacement cables.

Note

This Plasma Television receiver will display television closed captioning, ( or ), in accordance with paragraph 15.119 of the FCC rules.

INDUSTRY CANADA AGENCY REGULATORY INFORMATION

Cable Compatible Television Apparatus- Télévision câblocompatible, Canada.

Features and Specifications

Features:

- New Easy-to-Use On-Screen Menu Control (3 Language)
- Downloadable V-Chip
- New AV Network System Control (Only HDX models)
 - Control up to 4 components with one remote control.
 - 2 IR Blaster cables included
- Illuminated and Preprogrammed Remote Control
- Power Management: ON/OFF via signal detection
- Picture Enhancement
- Input Signal Identification
- CableCARD compatible - Contact your local cable operator for more information
- HDMI (High Definition Multimedia Interface)(High Bandwidth Digital Content Protection V1.1 Compatible)
- Photo Input (for your digital camera, USB drive or memory card USB drive)
-  Technology
- TV Guide On Screen™

Video:

- 1024 x 1080 Display Resolution (42")
- 1366 x 768 Display Resolution (55")
- ALiS (Alternate Lighting of Surfaces Technology)
- High-Contrast Pure-Color Glass Shield
- Wide Viewing Angle: More than 160°
- Color Temperature Presets: High, Standard, Medium and Black/White (HDX models only)
- Multiple Screen Fill Modes
(4:3 Standard/4:3 Expanded/4:3 Zoom 1/
4:3 Zoom 2/16:9 Standard1/Standard2/16:9 Zoom)¹
- 4MB 10-bit 3D Y/C Comb Filter
- Picture Modes :Day(Normal), Day(Dynamic) and Night

Inputs:

- Power Input AC 120V, 60Hz
- Power Consumption
 - Refer to rear panel at the back of the Plasma Monitor
- Antenna input impedance 75 Ohm
- Channel coverage 191ch.
 - VHF-Band 2 ~ 13
 - UHF-Band 14 ~ 69
 - CATV Mid Band A-5 ~ A-1
 - Super Band A-I
 - Hyper Band W+1 - W+28
 - Ultra Band W+29 - W+94
- Television System NTSC Standard
ATSC Standard (8 VSB, 64-QAM, 256-QAM)
- Video 1.0Vp-p, 75 Ohm
- S-Video
 - Luminance (Y) 1.0Vp-p, 75 Ohm
 - Chrominance (C) 0.286Vp-p, 75 Ohm
- Component Video
 - Luminance (Y) 1.0Vp-p, 75 Ohm
 - Chrominance (P_B/P_R) 0.7Vp-p, 75 Ohm
- Audio input Impedance 270k Ohm
- Average input level 470mVrms
- HDMI (19 PIN)

Outputs:

- Video 1.0Vp-p. 75 Ohm
- Audio 470mVrms, 1k Ohm
- Optical Out (Digital Audio) 1 Optical Connector

Audio:

- MTS Stereo/SAP
- Bass Boost
- Surround Sound
- 36W
- Soft Mute (50%)

Supplied Accessories:

- Remote Control
- Simple Remote Control (Only HDX models)
- Batteries (AA) (AAA: Only HDX models)
- 6' AC Power cord cable
- Table Top Stand (42" models only)
- IR Blaster Cables
- Power Swivel Cable (42" models only)
- Ferrite Core

Optional Accessories:

- For U.S. Models: Please access our website:
www.hitachi.us/tv

INPUTS/OUTPUTS

• Wideband Component Y, Pb,Pr	3
• Composite Video	5
• S-Video	2
• Antenna (RF)Inputs	1
• Audio Output	1
• Monitor Output	1
• Optical Output	1
• IR Blaster	2
• G-LINK	1
• CableCARD Slot	1
• Upgrade Card Slot	1
• Swivel Output	1
• HDMI	3
• Photo Input	1
• IEEE 1394/DV Inputs (HDX only)	1

SPECIFICATIONS

- Pixel Pitch 0.90(horiz.) x 0.485(vert.) mm.(42")
..... 0.90(horiz.) x 0.90(vert.) mm.(55")
- FCC class: B for Consumer Use
- Power Requirements: 108-132VAC, 60Hz

¹ Screen mode availability varies by input format

HDTV Televisions display HDTV only when an HDTV source is available.

All specifications, weights, and dimensions are subject to change without prior notice. Please access www.hitachi.com/tv for detailed specifications and dimensions for custom installations.

UltraVision Digital is a registered trademark of Hitachi Home Electronics (America), Inc.

 **montavista™**

COPYRIGHT © 1999-2006 MONTAVISTA SOFTWARE, INC. ALL RIGHTS RESERVED.

 **HDMI™** HDMI, the HDMI logo and High-Definition Multimedia Interface are trademarks or registered trademarks of HDMI Licensing LLC.

*Manufactured under license from Dolby Laboratories. "Dolby" and the double-D symbol are trademarks of Dolby Laboratories.

Set Dimensions

42 Inch Models (Includes Table Top Stand) Weight (lbs./kg): 88/39.8

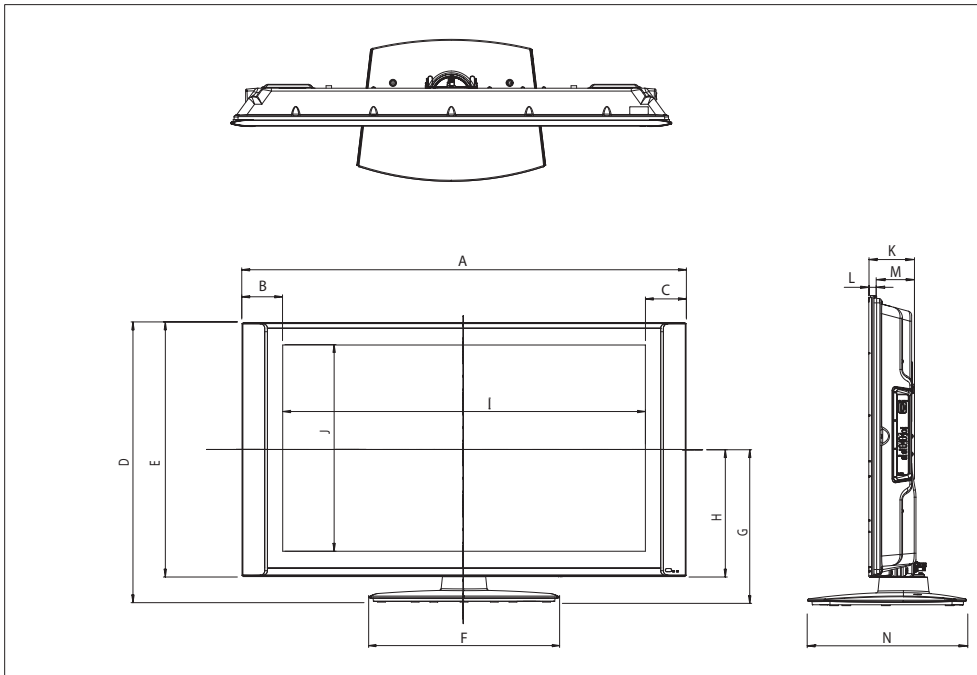

Units	A	B	C	D	E	F	G	H	I	J	K	L	M	N
Inches	44-5/8	4-1/8	4-1/8	28-1/16	25-1/2	19-1/8	15-1/2	12-15/16	36-7/16	20-11/16	4-1/4	11/16	3-9/16	14-3/8
MM	1134	104	104	713.2	648	485.3	393.2	328	926	526.6	108.5	18	90.5	365

55 Inch Models (Plasma Television Only) Weight (lbs./kg): 151/68.4

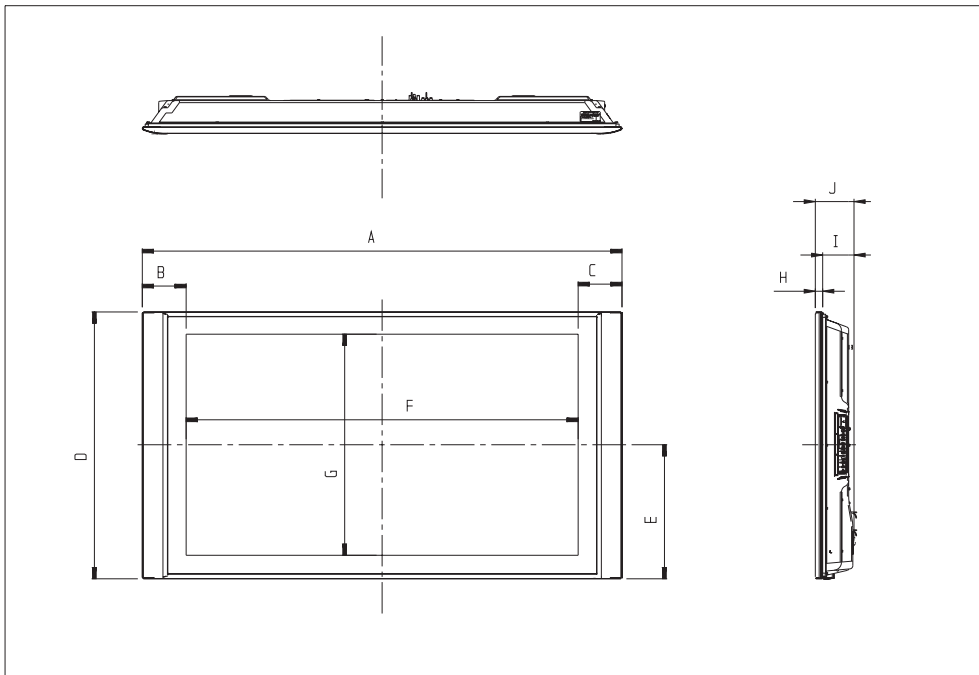

Units	A	B	C	D	E	F	G	H	I	J	K	L	M	N
Inches	59-7/16	5-7/16	5-7/16	33-1/16	16-5/8	48-9/16	27-3/8	11/16	3-1/2	4-3/16				
MM	1510	138	138	840	422	1234	696	24	94.9	118.9				

HITACHI

Inspire the Next

Service Hotline

To locate an authorized **HITACHI** service facility in the continental U.S.A. and Canada,

DIAL TOLL FREE

7 days a week, 24 hours a day

1-800-HITACHI

(1-800-448-2244)



HITACHI AMERICA, LTD.
HOME ELECTRONICS DIVISION

HITACHI has made every effort to assure you hours of trouble free operation from your unit. However, should you require service, a network of HITACHI Authorized Service Facilities has been established in all 50 states and Puerto Rico. Each facility will provide you with convenient and expedient assistance. Our service hotline operator will direct you to the HITACHI Authorized Service Facility nearest you. Just present proof of purchase and/or delivery receipts to the Hitachi Authorized Service Facility, and service will be rendered in accordance with the terms of the limited warranty as stated on your warranty card or operating guide.

Should you have any questions regarding warranty, service, operation, or technical assistance, please contact:

Hitachi America, LTD.
Home Electronics Division
900 Hitachi Way
Chula Vista, CA 91914-3556

HITACHI CANADA, LTD.
DIGITAL MEDIA DIVISION

Should you have any questions regarding warranty, service, operation, or technical assistance, please contact:

In Canada: 1-800-HITACHI (1-800-448-2244)

Monday – Friday (EST).....9:00am – 7:00pm
Saturday (EST)9:00am – 5:00pm

Look for your French Manual on the outside of the box. If the manual is missing, call **1-800-HITACHI (1-800-448-2244)** for a copy.

Pour de plus amples renseignements sur le service durant la période couverte par la garantie, sur le fonctionnement ou pour de l'assistance technique communiquez avec:

Au Canada: 1-800-HITACHI (1-800-448-2244)

Lundi - Vendredi L'EST9:00am – 7:00pm
Samedi L'EST.....9:00am – 5:00pm

La version français de votre manuel se trouve a l'exterieur de la boîte. Si le manuel est manquant, coposez le **1-800-HITACHI (1-800-448-2244)** pour obenir votre copie.

HITACHI CANADA, LTD.
2495 Meadowpine Blvd.
Mississauga, Ontario L5N 6C3

End User License Agreement for HITACHI DTV Software

END USER LICENSE AGREEMENT FOR HITACHI DTV SOFTWARE

IMPORTANT – READ CAREFULLY: This End User License Agreement for **HITACHI** DTV Software (this "Agreement") is a legal agreement between you ("you" or "your"), in your capacity as the owner of a **HITACHI** brand digital television (the "DTV"), and **HITACHI** America, Ltd., Ubiquitous Platform System Division ("**HITACHI**"). By using the DTV or the digital television software installed on the DTV (the "DTV Software") or any Upgrade (as defined below, and together with the DTV Software, the "Software"), you agree to be bound by the terms and conditions of this Agreement. **IF YOU DO NOT AGREE TO BE BOUND BY THIS LICENSE AGREEMENT, DO NOT USE THE DTV OR THE DTV SOFTWARE.**

1. **LICENSE GRANT.** **HITACHI** grants to you, for the life of the DTV, a non-exclusive, non-transferable, revocable license to install and use one copy of the Software on the DTV, subject to the following limitations and restrictions:
 - a. You may not share, duplicate, republish or redistribute the Software;
 - b. You may not resell, rent, lease, sublicense, gift, loan, assign or otherwise transfer the Software or any of your rights under this Agreement;
 - c. You may not modify, adapt, translate, reverse engineer, decompile, disassemble or make derivative works from the Software or use the Software in combination with any non-**Hitachi** software; and
 - d. You may not use the Software for any commercial purpose.
2. **VIOLATIONS; INDEMNITY.** You understand and agree that your use of the Software in any manner except as permitted under this Agreement could constitute a serious crime and could subject you to damages and an award to **HITACHI** of attorneys' fees in connection with your violation of this Agreement. You further understand that you may be held legally responsible for any copyright infringement or other violation of intellectual property rights caused or facilitated by your failure to abide by the terms of this Agreement. You agree to defend, indemnify and hold **HITACHI** and its parent and affiliate companies harmless from and against any and all liability resulting from any breach by you of this Agreement.
3. **INTELLECTUAL PROPERTY.** The Software is protected by federal copyright laws, international copyright treaties and other intellectual property laws and treaties. The Software is licensed, not sold, to you. All right, title and interest in and to the Software and any intellectual property associated therewith, including any accompanying printed materials, shall belong to **HITACHI** and its licensors and suppliers. Except as expressly provided herein, neither **HITACHI** nor any of its licensors or suppliers grants to you under this Agreement any express or implied right in or to any patents, copyrights, trademarks, trade secrets or other intellectual property. All right, title and interest in and to the intellectual property rights associated with any content that is accessible through use of the Software shall belong to the applicable content owners and may be protected by copyright or other intellectual property laws and treaties. This Agreement grants you no rights to use such content. Any rights of **HITACHI** not expressly granted to you hereunder are reserved expressly by Hitachi.
4. **SOFTWARE UPGRADES.** In the future, **HITACHI** may release or make available one or more upgrades to the DTV Software (each, an "Upgrade"). You understand and agree that if you decide to install or use any Upgrade, your installation and use of such Upgrade and/or any other software or intellectual property **HITACHI** may provide in connection therewith shall be governed by the terms and conditions of this Agreement, except to the extent that **HITACHI** provides different or supplementary license terms or conditions that accompany such Upgrade or other software or intellectual property. In the event **HITACHI** provides you with a "flash card" or other media to effect or facilitate an Upgrade, you understand and acknowledge that your failure to return such flash card or other media to **HITACHI** as **HITACHI** may require could result in **HITACHI** placing your name and your DTV's serial number on a "No Further Upgrades" list, which will prohibit you from receiving any subsequent Upgrades **HITACHI** may later release or make available. **IF YOU DO NOT AGREE WITH ALL THE TERMS AND CONDITIONS OF THIS AGREEMENT OR ALL THE TERMS AND CONDITIONS OF ANY DIFFERENT OR SUPPLEMENTARY LICENSE THAT MAY ACCOMPANY SUCH UPGRADE, (A) DO NOT USE ANY HITACHI-PROVIDED FLASH CARD OR OTHER MEDIA, (B) DO NOT INSTALL ANY HITACHI-PROVIDED UPGRADE SOFTWARE ON YOUR DTV, AND (C) PROMPTLY RETURN SUCH FLASH CARD OR OTHER MEDIA TO HITACHI.**
5. **EXPORT RESTRICTIONS.** **HITACHI** is licensing the Software for use within North America only. You agree that you will not export or re-export the Software. You specifically agree not to export or re-export the Software: (i) to any country to which the U.S. has embargoed or restricted the export of goods or services, which currently include, but are not necessarily limited to Cuba, Iran, Libya, North Korea, Sudan and Syria, or to any national of any such country, wherever located, who intends to transmit or transport the Software back to such country; (ii) to any person or entity who you know or have reason to know will utilize the Software in the design, development, or production of nuclear, chemical, or biological weapons; or (iii) to any person or entity who has been prohibited from participating in U.S. export transactions by any federal agency of the U.S. government. You warrant and represent that neither the U.S. Bureau of Industry and Security nor any other U.S. federal Agency has suspended, revoked, or denied your export privileges.
6. **NO WARRANTIES.** The software is provided to you in "as is" condition and **HITACHI** makes no warranties of any kind whatsoever regarding the software and, to the maximum extent permitted by law, hereby expressly disclaims all warranties of any kind whatsoever, express or implied, with respect to the software. All implied warranties, including without limitation, the implied warranties of non-infringement, merchantability and fitness for a particular purpose are hereby expressly disclaimed by **hitachi** to the maximum extent permitted by law.
7. **LIMITATION OF LIABILITY.** To the maximum extent permitted by applicable law, **HITACHI**, its licensors, suppliers, parent companies, affiliates, subsidiaries, employees and agents shall not under any circumstances be liable to you or any third parties for any damages of any nature arising in any way from this agreement, your use of the software or otherwise, whether indirect, special, incidental, consequential or otherwise, including, without limitation, any claims for lost profits, lost good will, lost data, business interruption, procurement of substitute goods or services, or expenditures made or committed for in reliance on the continuation of this agreement, even if advised in advance of the possibility of such damages.
8. **NO FAILURE OF ESSENTIAL PURPOSE.** You agree that neither **HITACHI'S** breach of this agreement nor its failure to repair a defect, error or bug in the software shall constitute a failure of the essential purpose of this agreement.
9. **CRYPTOGRAPHIC SOFTWARE.** The software contains software developed by the OpenSSL Project, including cryptographic software written by eric young (the "cryptographic software"). The cryptographic software is provided by the OpenSSL Project in "as is" condition and any express or implied warranties, including but not limited to, the implied warranties of merchantability and fitness for a particular purpose are hereby expressly disclaimed to the maximum extent permitted by law. In no event shall the OpenSSL Project, its contributors, **HITACHI** or any of its parent or affiliate companies be liable for any direct, indirect, incidental, special, exemplary, or consequential damages (including, but not limited to, procurement of substitute goods or services; loss of use, data, or profits; or business interruption) however caused and on any theory of liability, whether in contract, strict liability, or tort (including negligence or otherwise) arising in any way out of the use of the software or the cryptographic software, even if advised in advance of the possibility of such damages.
10. **TERMINATION.** **HITACHI** may terminate this Agreement immediately at any time by providing notice to you.
11. **GOVERNING LAW; SEVERABILITY.** This Agreement will be governed by the laws of the State of New York, and you consent to the exclusive jurisdiction and venue in the federal courts sitting in the Southern District of New York, unless no federal subject matter jurisdiction exists, in which case you consent to the exclusive jurisdiction and venue in the Borough of Manhattan, New York, USA.

End User License Agreements for Operating System Software

SOFTWARE LICENSE INFORMATION

Your **HITACHI** brand digital television (the “DTV”) uses certain open source operating system software (the “OS Software”) distributed pursuant to GNU GENERAL PUBLIC LICENSE Version 2 and GNU LESSER GENERAL PUBLIC LICENSE Version 2.1, each as defined and published by the Free Software Foundation, Inc.

The OS Software modules incorporated into the DTV are listed in the table below opposite the applicable GNU software license. Copies of such GNU software licenses are provided in the pages that follow.

Software Module	Applicable GNU Software License
Linux Kernel busybox dhcpcd ifupdown net-tool iptables libstdc++5	GNU GENERAL PUBLIC LICENSE Version 2
glibc libposixtime	GNU LESSER GENERAL PUBLIC LICENSE Version 2.1

For purposes of incorporating the OS Software into the DTV, Hitachi made certain modifications to the source code of the OS Software (collectively, the “Source Code Modifications”) in 2006. The Source Code Modifications also are distributed pursuant to the applicable GNU software licenses identified above.

THE OS SOFTWARE AND THE SOURCE CODE MODIFICATIONS ARE PROVIDED “AS IS” AND THE LICENSEE DISCLAIMS ANY AND ALL WARRANTIES OF ANY KIND, INCLUDING THE IMPLIED WARRANTY OF MERCHANTABILITY OR FITNESS FOR A PARTICULAR PURPOSE. See the GNU General Public License for additional terms and conditions.

If you would like to learn more about the Free Software Foundation or the GNU software project, please visit <http://www.fsf.org>. If you would like to request a copy of the Source Code Modifications from **HITACHI**, please send an email to the following address: tvsoftwaresupport@hhea.hitachi.com

End User License Agreement for Operating System Software

GNU GENERAL PUBLIC LICENSE Version 2, June 1991

Copyright © 1989, 1991 Free Software Foundation, Inc.

51 Franklin St, Fifth Floor, Boston, MA 02110-1301 USA

Everyone is permitted to copy and distribute verbatim copies of this license document, but changing it is not allowed.

Preamble

The licenses for most software are designed to take away your freedom to share and change it. By contrast, the GNU General Public License is intended to guarantee your freedom to share and change free software—to make sure the software is free for all its users. This General Public License applies to most of the Free Software Foundation's software and to any other program whose authors commit to using it. (Some other Free Software Foundation software is covered by the GNU Library General Public License instead.) You can apply it to your programs, too.

When we speak of free software, we are referring to freedom, not price. Our General Public Licenses are designed to make sure that you have the freedom to distribute copies of free software (and charge for this service if you wish), that you receive source code or can get it if you want it, that you can change the software or use pieces of it in new free programs; and that you know you can do these things.

To protect your rights, we need to make restrictions that forbid anyone to deny you these rights or to ask you to surrender the rights. These restrictions translate to certain responsibilities for you if you distribute copies of the software, or if you modify it.

For example, if you distribute copies of such a program, whether gratis or for a fee, you must give the recipients all the rights that you have. You must make sure that they, too, receive or can get the source code. And you must show them these terms so they know their rights.

We protect your rights with two steps: (1) copyright the software, and (2) offer you this license which gives you legal permission to copy, distribute and/or modify the software.

Also, for each author's protection and ours, we want to make certain that everyone understands that there is no warranty for this free software. If the software is modified by someone else and passed on, we want its recipients to know that what they have is not the original, so that any problems introduced by others will not reflect on the original authors' reputations.

Finally, any free program is threatened constantly by software patents. We wish to avoid the danger that redistributors of a free program will individually obtain patent licenses, in effect making the program proprietary. To prevent this, we have made it clear that any patent must be licensed for everyone's free use or not licensed at all.

The precise terms and conditions for copying, distribution and modification follow.

GNU GENERAL PUBLIC LICENSE TERMS AND CONDITIONS FOR COPYING, DISTRIBUTION AND MODIFICATION

0. This License applies to any program or other work which contains a notice placed by the copyright holder saying it may be distributed under the terms of this General Public License. The "Program", below, refers to any such program or work, and a "work based on the Program" means either the Program or any derivative work under copyright law: that is to say, a work containing the Program or a portion of it, either verbatim or with modifications and/or translated into another language.

(Hereinafter, translation is included without limitation in the term "modification".) Each licensee is addressed as "you".

Activities other than copying, distribution and modification are not covered by this License; they are outside its scope. The act of running the Program is not restricted, and the output from the Program is covered only if its contents constitute a work based on the Program (independent of having been made by running the Program). Whether that is true depends on what the Program does.

1. You may copy and distribute verbatim copies of the Program's source code as you receive it, in any medium, provided that you conspicuously and appropriately publish on each copy an appropriate copyright notice and disclaimer of warranty; keep intact all the notices that refer to this License and to the absence of any warranty; and give any other recipients of the Program a copy of this License along with the Program.

You may charge a fee for the physical act of transferring a copy, and you may at your option offer warranty protection in exchange for a fee.

2. You may modify your copy or copies of the Program or any portion of it, thus forming a work based on the Program, and copy and distribute such modifications or work under the terms of Section 1 above, provided that you also meet all of these conditions:

- a) You must cause the modified files to carry prominent notices stating that you changed the files and the date of any change.
- b) You must cause any work that you distribute or publish, that in whole or in part contains or is derived from the Program or any part thereof, to be licensed as a whole at no charge to all third parties under the terms of this License.
- c) If the modified program normally reads commands interactively when run, you must cause it, when started running for such interactive use in the most ordinary way, to print or display an announcement including an appropriate copyright notice and a notice that there is no warranty (or else, saying that you provide a warranty) and that users may redistribute the program under these conditions, and telling the user how to view a copy of this License. (Exception: if the Program itself is interactive but does not normally print such an announcement, your work based on the Program is not required to print an announcement.)

These requirements apply to the modified work as a whole. If identifiable sections of that work are not derived from the Program, and can be reasonably considered independent and separate works in themselves, then this License, and its terms, do not apply to those sections when you distribute them as separate works. But when you distribute the same sections as part of a whole which is a work based on the Program, the distribution of the whole must be on the terms of this License, whose permissions for other licensees extend to the entire whole, and thus to each and every part regardless of who wrote it.

Thus, it is not the intent of this section to claim rights or contest your rights to work written entirely by you; rather, the intent is to exercise the right to control the distribution of derivative or collective works based on the Program.

End User License Agreement for Operating System Software

In addition, mere aggregation of another work not based on the Program with the Program (or with a work based on the Program) on a volume of a storage or distribution medium does not bring the other work under the scope of this License.

3. You may copy and distribute the Program (or a work based on it, under Section 2) in object code or executable form under the terms of Sections 1 and 2 above provided that you also do one of the following:

- a) Accompany it with the complete corresponding machine-readable source code, which must be distributed under the terms of Sections 1 and 2 above on a medium customarily used for software interchange; or,
- b) Accompany it with a written offer, valid for at least three years, to give any third party, for a charge no more than your cost of physically performing source distribution, a complete machine-readable copy of the corresponding source code, to be distributed under the terms of Sections 1 and 2 above on a medium customarily used for software interchange; or,
- c) Accompany it with the information you received as to the offer to distribute corresponding source code. (This alternative is allowed only for noncommercial distribution and only if you received the program in object code or executable form with such an offer, in accord with Subsection b above.)

The source code for a work means the preferred form of the work for making modifications to it. For an executable work, complete source code means all the source code for all modules it contains, plus any associated interface definition files, plus the scripts used to control compilation and installation of the executable. However, as a special exception, the source code distributed need not include anything that is normally distributed (in either source or binary form) with the major components (compiler, kernel, and so on) of the operating system on which the executable runs, unless that component itself accompanies the executable.

If distribution of executable or object code is made by offering access to copy from a designated place, then offering equivalent access to copy the source code from the same place counts as distribution of the source code, even though third parties are not compelled to copy the source along with the object code.

4. You may not copy, modify, sublicense, or distribute the Program except as expressly provided under this License. Any attempt otherwise to copy, modify, sublicense or distribute the Program is void, and will automatically terminate your rights under this License. However, parties who have received copies, or rights, from you under this License will not have their licenses terminated so long as such parties remain in full compliance.

5. You are not required to accept this License, since you have not signed it. However, nothing else grants you permission to modify or distribute the Program or its derivative works. These actions are prohibited by law if you do not accept this License. Therefore, by modifying or distributing the Program (or any work based on the Program), you indicate your acceptance of this License to do so, and all its terms and conditions for copying, distributing or modifying the Program or works based on it.

6. Each time you redistribute the Program (or any work based on the Program), the recipient automatically receives a license from the original licensor to copy, distribute or modify the Program subject to these terms and conditions. You may not impose any further restrictions on the recipients' exercise of the rights granted herein. You are not responsible for enforcing compliance by third parties to this License.

7. If, as a consequence of a court judgment or allegation of patent infringement or for any other reason (not limited to patent issues), conditions are imposed on you (whether by court order, agreement or otherwise) that contradict the conditions of this License, they do not excuse you from the conditions of this License. If you cannot distribute so as to satisfy simultaneously your obligations under this License and any other pertinent obligations, then as a consequence you may not distribute the Program at all.

For example, if a patent license would not permit royalty-free redistribution of the Program by all those who receive copies directly or indirectly through you, then the only way you could satisfy both it and this License would be to refrain entirely from distribution of the Program. If any portion of this section is held invalid or unenforceable under any particular circumstance, the balance of the section is intended to apply and the section as a whole is intended to apply in other circumstances.

It is not the purpose of this section to induce you to infringe any patents or other property right claims or to contest validity of any such claims; this section has the sole purpose of protecting the integrity of the free software distribution system, which is implemented by public license practices. Many people have made generous contributions to the wide range of software distributed through that system in reliance on consistent application of that system; it is up to the author/donor to decide if he or she is willing to distribute software through any other system and a licensee cannot impose that choice.

This section is intended to make thoroughly clear what is believed to be a consequence of the rest of this License.

8. If the distribution and/or use of the Program is restricted in certain countries either by patents or by copyrighted interfaces, the original copyright holder who places the Program under this License may add an explicit geographical distribution limitation excluding those countries, so that distribution is permitted only in or among countries not thus excluded. In such case, this License incorporates the limitation as if written in the body of this License.

9. The Free Software Foundation may publish revised and/or new versions of the General Public License from time to time. Such new versions will be similar in spirit to the present version, but may differ in detail to address new problems or concerns.

Each version is given a distinguishing version number. If the Program specifies a version number of this License which applies to it and "any later version", you have the option of following the terms and conditions either of that version or of any later version published by the Free Software Foundation. If the Program does not specify a version number of this License, you may choose any version ever published by the Free Software Foundation.

10. If you wish to incorporate parts of the Program into other free programs whose distribution conditions are different, write to the author to ask for permission. For software which is copyrighted by the Free Software Foundation, write to the Free Software Foundation; we sometimes make exceptions for this. Our decision will be guided by the two goals of preserving the free status of all derivatives of our free software and of promoting the sharing and reuse of software generally.

NO WARRANTY

11. BECAUSE THE PROGRAM IS LICENSED FREE OF CHARGE, THERE IS NO WARRANTY FOR THE PROGRAM, TO THE EXTENT PERMITTED BY APPLICABLE LAW. EXCEPT WHEN OTHERWISE STATED IN WRITING THE COPYRIGHT HOLDERS AND/OR OTHER PARTIES PROVIDE THE PROGRAM "AS IS" WITHOUT WARRANTY OF ANY KIND, EITHER EXPRESSED OR IMPLIED, INCLUDING, BUT NOT LIMITED

End User License Agreement for Operating System Software

TO, THE IMPLIED WARRANTIES OF MERCHANTABILITY AND FITNESS FOR A PARTICULAR PURPOSE. THE ENTIRE RISK AS TO THE QUALITY AND PERFORMANCE OF THE PROGRAM IS WITH YOU. SHOULD THE PROGRAM PROVE DEFECTIVE, YOU ASSUME THE COST OF ALL NECESSARY SERVICING, REPAIR OR CORRECTION.

12. IN NO EVENT UNLESS REQUIRED BY APPLICABLE LAW OR AGREED TO IN WRITING WILL ANY COPYRIGHT HOLDER, OR ANY OTHER PARTY WHO MAY MODIFY AND/OR REDISTRIBUTE THE PROGRAM AS PERMITTED ABOVE, BE LIABLE TO YOU FOR DAMAGES, INCLUDING ANY GENERAL, SPECIAL, INCIDENTAL OR CONSEQUENTIAL DAMAGES ARISING OUT OF THE USE OR INABILITY TO USE THE PROGRAM (INCLUDING BUT NOT LIMITED TO LOSS OF DATA OR DATA BEING RENDERED INACCURATE OR LOSSES SUSTAINED BY YOU OR THIRD PARTIES OR A FAILURE OF THE PROGRAM TO OPERATE WITH ANY OTHER PROGRAMS), EVEN IF SUCH HOLDER OR OTHER PARTY HAS BEEN ADVISED OF THE POSSIBILITY OF SUCH DAMAGES.

END OF TERMS AND CONDITIONS

How to Apply These Terms to Your New Programs

If you develop a new program, and you want it to be of the greatest possible use to the public, the best way to achieve this is to make it free software which everyone can redistribute and change under these terms.

To do so, attach the following notices to the program. It is safest to attach them to the start of each source file to most effectively convey the exclusion of warranty; and each file should have at least the "copyright" line and a pointer to where the full notice is found.

```
<one line to give the program's name and a brief idea of what it does.>
Copyright © <year> <name of author>
```

This program is free software; you can redistribute it and/or modify it under the terms of the GNU General Public License as published by the Free Software Foundation; either version 2 of the License, or (at your option) any later version.

This program is distributed in the hope that it will be useful, but WITHOUT ANY WARRANTY; without even the implied warranty of MERCHANTABILITY or FITNESS FOR A PARTICULAR PURPOSE. See the GNU General Public License for more details.

You should have received a copy of the GNU General Public License along with this program; if not, write to the Free Software Foundation, Inc., 51 Franklin St, Fifth Floor, Boston, MA 02110-1301 USA

Also add information on how to contact you by electronic and paper mail.

If the program is interactive, make it output a short notice like this when it starts in an interactive mode:

```
Gnomovision version 69, Copyright © year name of author
Gnomovision comes with ABSOLUTELY NO WARRANTY;
for details type `show w'. This is free software, and you are
welcome to redistribute it under certain conditions; type `show
c' for details.
```

The hypothetical commands `show w' and `show c' should show the appropriate parts of the General Public License. Of course, the commands you use may be called something other than `show w' and `show c'; they could even be mouse-clicks or menu items--whatever suits your program.

You should also get your employer (if you work as a programmer) or your school, if any, to sign a "copyright disclaimer" for the program, if necessary. Here is a sample; alter the names:

Yoyodyne, Inc., hereby disclaims all copyright interest in the program `Gnomovision' (which makes passes at compilers) written by James Hacker.

<signature of Ty Coon>, 1 April 1989
Ty Coon, President of Vice

This General Public License does not permit incorporating your program into proprietary programs. If your program is a subroutine library, you may consider it more useful to permit linking proprietary applications with the library. If this is what you want to do, use the GNU Library General Public License instead of this License.

End User License Agreement for Operating System Software

GNU LESSER GENERAL PUBLIC LICENSE Version 2.1, February 1999

Copyright © 1991, 1999 Free Software Foundation, Inc. 51 Franklin St, Fifth Floor, Boston, MA 02110-1301 USA
Everyone is permitted to copy and distribute verbatim copies of this license document, but changing it is not allowed.

[This is the first released version of the Lesser GPL. It also counts as the successor of the GNU Library Public License, version 2, hence the version number 2.1.]

Preamble

The licenses for most software are designed to take away your freedom to share and change it. By contrast, the GNU General Public Licenses are intended to guarantee your freedom to share and change free software—to make sure the software is free for all its users.

This license, the Lesser General Public License, applies to some specially designated software packages—typically libraries—of the Free Software Foundation and other authors who decide to use it. You can use it too, but we suggest you first think carefully about whether this license or the ordinary General Public License is the better strategy to use in any particular case, based on the explanations below.

When we speak of free software, we are referring to freedom of use, not price. Our General Public Licenses are designed to make sure that you have the freedom to distribute copies of free software (and charge for this service if you wish); that you receive source code or can get it if you want it; that you can change the software and use pieces of it in new free programs; and that you are informed that you can do these things.

To protect your rights, we need to make restrictions that forbid distributors to deny you these rights or to ask you to surrender these rights. These restrictions translate to certain responsibilities for you if you distribute copies of the library or if you modify it.

For example, if you distribute copies of the library, whether gratis or for a fee, you must give the recipients all the rights that we gave you. You must make sure that they, too, receive or can get the source code. If you link other code with the library, you must provide complete object files to the recipients, so that they can relink them with the library after making changes to the library and recompiling it. And you must show them these terms so they know their rights.

We protect your rights with a two-step method: (1) we copyright the library, and (2) we offer you this license, which gives you legal permission to copy, distribute and/or modify the library.

To protect each distributor, we want to make it very clear that there is no warranty for the free library. Also, if the library is modified by someone else and passed on, the recipients should know that what they have is not the original version, so that the original author's reputation will not be affected by problems that might be introduced by others.

Finally, software patents pose a constant threat to the existence of any free program. We wish to make sure that a company cannot effectively restrict the users of a free program by obtaining a restrictive license from a patent holder. Therefore, we insist that any patent license obtained for a version of the library must be consistent with the full freedom of use specified in this license.

Most GNU software, including some libraries, is covered by the ordinary GNU General Public License. This license, the GNU Lesser General Public License, applies to certain designated libraries, and is quite different from the ordinary General Public License. We use this license for certain libraries in order to permit linking those libraries into non-free programs.

When a program is linked with a library, whether statically or using a shared library, the combination of the two is legally speaking a combined work, a derivative of the original library. The ordinary General Public License therefore permits such linking only if the entire combination fits its criteria of freedom. The Lesser General Public License permits more lax criteria for linking other code with the library.

We call this license the "Lesser" General Public License because it does Less to protect the user's freedom than the ordinary General Public License. It also provides other free software developers Less of an advantage over competing non-free programs. These disadvantages are the reason we use the ordinary General Public License for many libraries. However, the Lesser license provides advantages in certain special circumstances.

For example, on rare occasions, there may be a special need to encourage the widest possible use of a certain library, so that it becomes a de-facto standard. To achieve this, non-free programs must be allowed to use the library. A more frequent case is that a free library does the same job as widely used non-free libraries. In this case, there is little to gain by limiting the free library to free software only, so we use the Lesser General Public License.

In other cases, permission to use a particular library in non-free programs enables a greater number of people to use a large body of free software. For example, permission to use the GNU C Library in non-free programs enables many more people to use the whole GNU operating system, as well as its variant, the GNU/Linux operating system.

Although the Lesser General Public License is Less protective of the users' freedom, it does ensure that the user of a program that is linked with the Library has the freedom and the wherewithal to run that program using a modified version of the Library.

The precise terms and conditions for copying, distribution and modification follow. Pay close attention to the difference between a "work based on the library" and a "work that uses the library". The former contains code derived from the library, whereas the latter must be combined with the library in order to run.

GNU LESSER GENERAL PUBLIC LICENSE TERMS AND CONDITIONS FOR COPYING, DISTRIBUTION AND MODIFICATION

0. This License Agreement applies to any software library or other program which contains a notice placed by the copyright holder or other authorized party saying it may be distributed under the terms of this Lesser General Public License (also called "this License"). Each licensee is addressed as "you".

A "library" means a collection of software functions and/or data prepared so as to be conveniently linked with application programs (which use some of those functions and data) to form executables.

The "Library", below, refers to any such software library or work which has been distributed under these terms. A "work based on the Library" means either the Library or any derivative work under copyright law: that is to say, a work containing the Library or a portion of it, either verbatim or with modifications and/or translated

End User License Agreement for Operating System Software

straightforwardly into another language. (Hereinafter, translation is included without limitation in the term "modification".)

"Source code" for a work means the preferred form of the work for making modifications to it. For a library, complete source code means all the source code for all modules it contains, plus any associated interface definition files, plus the scripts used to control compilation and installation of the library.

Activities other than copying, distribution and modification are not covered by this License; they are outside its scope. The act of running a program using the Library is not restricted, and output from such a program is covered only if its contents constitute a work based on the Library (independent of the use of the Library in a tool for writing it). Whether that is true depends on what the Library does and what the program that uses the Library does.

1. You may copy and distribute verbatim copies of the Library's complete source code as you receive it, in any medium, provided that you conspicuously and appropriately publish on each copy an appropriate copyright notice and disclaimer of warranty; keep intact all the notices that refer to this License and to the absence of any warranty; and distribute a copy of this License along with the Library.

You may charge a fee for the physical act of transferring a copy, and you may at your option offer warranty protection in exchange for a fee.

2. You may modify your copy or copies of the Library or any portion of it, thus forming a work based on the Library, and copy and distribute such modifications or work under the terms of Section 1 above, provided that you also meet all of these conditions:

- a) The modified work must itself be a software library.
- b) You must cause the files modified to carry prominent notices stating that you changed the files and the date of any change.
- c) You must cause the whole of the work to be licensed at no charge to all third parties under the terms of this License.
- d) If a facility in the modified Library refers to a function or a table of data to be supplied by an application program that uses the facility, other than as an argument passed when the facility is invoked, then you must make a good faith effort to ensure that, in the event an application does not supply such function or table, the facility still operates, and performs whatever part of its purpose remains meaningful. (For example, a function in a library to compute square roots has a purpose that is entirely well-defined independent of the application. Therefore, Subsection 2d requires that any application-supplied function or table used by this function must be optional: if the application does not supply it, the square root function must still compute square roots.)

These requirements apply to the modified work as a whole. If identifiable sections of that work are not derived from the Library, and can be reasonably considered independent and separate works in themselves, then this License, and its terms, do not apply to those sections when you distribute them as separate works. But when you distribute the same sections as part of a whole which is a work based on the Library, the distribution of the whole must be on the terms of this License, whose permissions for other licensees extend to the entire whole, and thus to each and every part regardless of who wrote it.

Thus, it is not the intent of this section to claim rights or contest your rights to work written entirely by you; rather, the intent is

to exercise the right to control the distribution of derivative or collective works based on the Library.

In addition, mere aggregation of another work not based on the Library with the Library (or with a work based on the Library) on a volume of a storage or distribution medium does not bring the other work under the scope of this License.

3. You may opt to apply the terms of the ordinary GNU General Public License instead of this License to a given copy of the Library. To do this, you must alter all the notices that refer to this License, so that they refer to the ordinary GNU General Public License, version 2, instead of to this License. (If a newer version than version 2 of the ordinary GNU General Public License has appeared, then you can specify that version instead if you wish.) Do not make any other change in these notices.

Once this change is made in a given copy, it is irreversible for that copy, so the ordinary GNU General Public License applies to all subsequent copies and derivative works made from that copy.

This option is useful when you wish to copy part of the code of the Library into a program that is not a library.

4. You may copy and distribute the Library (or a portion or derivative of it, under Section 2) in object code or executable form under the terms of Sections 1 and 2 above provided that you accompany it with the complete corresponding machine-readable source code, which must be distributed under the terms of Sections 1 and 2 above on a medium customarily used for software interchange.

If distribution of object code is made by offering access to copy from a designated place, then offering equivalent access to copy the source code from the same place satisfies the requirement to distribute the source code, even though third parties are not compelled to copy the source along with the object code.

5. A program that contains no derivative of any portion of the Library, but is designed to work with the Library by being compiled or linked with it, is called a "work that uses the Library". Such a work, in isolation, is not a derivative work of the Library, and therefore falls outside the scope of this License.

However, linking a "work that uses the Library" with the Library creates an executable that is a derivative of the Library (because it contains portions of the Library), rather than a "work that uses the library". The executable is therefore covered by this License. Section 6 states terms for distribution of such executables.

When a "work that uses the Library" uses material from a header file that is part of the Library, the object code for the work may be a derivative work of the Library even though the source code is not. Whether this is true is especially significant if the work can be linked without the Library, or if the work is itself a library. The threshold for this to be true is not precisely defined by law.

If such an object file uses only numerical parameters, data structure layouts and accessors, and small macros and small inline functions (ten lines or less in length), then the use of the object file is unrestricted, regardless of whether it is legally a derivative work. (Executables containing this object code plus portions of the Library will still fall under Section 6.)

Otherwise, if the work is a derivative of the Library, you may distribute the object code for the work under the terms of Section 6. Any executables containing that work also fall under Section 6, whether or not they are linked directly with the Library itself.

6. As an exception to the Sections above, you may also combine or link a "work that uses the Library" with the Library to produce

End User License Agreement for Operating System Software

a work containing portions of the Library, and distribute that work under terms of your choice, provided that the terms permit modification of the work for the customer's own use and reverse engineering for debugging such modifications.

You must give prominent notice with each copy of the work that the Library is used in it and that the Library and its use are covered by this License. You must supply a copy of this License. If the work during execution displays copyright notices, you must include the copyright notice for the Library among them, as well as a reference directing the user to the copy of this License. Also, you must do one of these things:

- a) Accompany the work with the complete corresponding machine-readable source code for the Library including whatever changes were used in the work (which must be distributed under Sections 1 and 2 above); and, if the work is an executable linked with the Library, with the complete machine-readable "work that uses the Library", as object code and/or source code, so that the user can modify the Library and then relink to produce a modified executable containing the modified Library. (It is understood that the user who changes the contents of definitions files in the Library will not necessarily be able to recompile the application to use the modified definitions.)
- b) Use a suitable shared library mechanism for linking with the Library. A suitable mechanism is one that (1) uses at run time a copy of the library already present on the user's computer system, rather than copying library functions into the executable, and (2) will operate properly with a modified version of the library, if the user installs one, as long as the modified version is interface-compatible with the version that the work was made with.
- c) Accompany the work with a written offer, valid for at least three years, to give the same user the materials specified in Subsection 6a, above, for a charge no more than the cost of performing this distribution.
- d) If distribution of the work is made by offering access to copy from a designated place, offer equivalent access to copy the above specified materials from the same place.
- e) Verify that the user has already received a copy of these materials or that you have already sent this user a copy.

For an executable, the required form of the "work that uses the Library" must include any data and utility programs needed for reproducing the executable from it. However, as a special exception, the materials to be distributed need not include anything that is normally distributed (in either source or binary form) with the major components (compiler, kernel, and so on) of the operating system on which the executable runs, unless that component itself accompanies the executable.

It may happen that this requirement contradicts the license restrictions of other proprietary libraries that do not normally accompany the operating system. Such a contradiction means you cannot use both them and the Library together in an executable that you distribute.

7. You may place library facilities that are a work based on the Library side-by-side in a single library together with other library facilities not covered by this License, and distribute such a combined library, provided that the separate distribution of the work based on the Library and of the other library facilities is otherwise permitted, and provided that you do these two things:

- a) Accompany the combined library with a copy of the same work based on the Library, uncombined with any other library facilities. This must be distributed under the terms of

the Sections above.

- b) Give prominent notice with the combined library of the fact that part of it is a work based on the Library, and explaining where to find the accompanying uncombined form of the same work.

8. You may not copy, modify, sublicense, link with, or distribute the Library except as expressly provided under this License. Any attempt otherwise to copy, modify, sublicense, link with, or distribute the Library is void, and will automatically terminate your rights under this License. However, parties who have received copies, or rights, from you under this License will not have their licenses terminated so long as such parties remain in full compliance.

9. You are not required to accept this License, since you have not signed it. However, nothing else grants you permission to modify or distribute the Library or its derivative works. These actions are prohibited by law if you do not accept this License. Therefore, by modifying or distributing the Library (or any work based on the Library), you indicate your acceptance of this License to do so, and all its terms and conditions for copying, distributing or modifying the Library or works based on it.

10. Each time you redistribute the Library (or any work based on the Library), the recipient automatically receives a license from the original licensor to copy, distribute, link with or modify the Library subject to these terms and conditions. You may not impose any further restrictions on the recipients' exercise of the rights granted herein. You are not responsible for enforcing compliance by third parties with this License.

11. If, as a consequence of a court judgment or allegation of patent infringement or for any other reason (not limited to patent issues), conditions are imposed on you (whether by court order, agreement or otherwise) that contradict the conditions of this License, they do not excuse you from the conditions of this License. If you cannot distribute so as to satisfy simultaneously your obligations under this License and any other pertinent obligations, then as a consequence you may not distribute the Library at all. For example, if a patent license would not permit royalty-free redistribution of the Library by all those who receive copies directly or indirectly through you, then the only way you could satisfy both it and this License would be to refrain entirely from distribution of the Library.

If any portion of this section is held invalid or unenforceable under any particular circumstance, the balance of the section is intended to apply, and the section as a whole is intended to apply in other circumstances.

It is not the purpose of this section to induce you to infringe any patents or other property right claims or to contest validity of any such claims; this section has the sole purpose of protecting the integrity of the free software distribution system which is implemented by public license practices. Many people have made generous contributions to the wide range of software distributed through that system in reliance on consistent application of that system; it is up to the author/donor to decide if he or she is willing to distribute software through any other system and a licensee cannot impose that choice.

This section is intended to make thoroughly clear what is believed to be a consequence of the rest of this License.

12. If the distribution and/or use of the Library is restricted in certain countries either by patents or by copyrighted interfaces, the original copyright holder who places the Library under this License may add an explicit geographical distribution limitation excluding those countries, so that distribution is permitted only in

End User License Agreement for Operating System Software

or among countries not thus excluded. In such case, this License incorporates the limitation as if written in the body of this License.

13. The Free Software Foundation may publish revised and/or new versions of the Lesser General Public License from time to time. Such new versions will be similar in spirit to the present version, but may differ in detail to address new problems or concerns. Each version is given a distinguishing version number. If the Library specifies a version number of this License which applies to it and "any later version", you have the option of following the terms and conditions either of that version or of any later version published by the Free Software Foundation. If the Library does not specify a license version number, you may choose any version ever published by the Free Software Foundation.

14. If you wish to incorporate parts of the Library into other free programs whose distribution conditions are incompatible with these, write to the author to ask for permission. For software which is copyrighted by the Free Software Foundation, write to the Free Software Foundation; we sometimes make exceptions for this. Our decision will be guided by the two goals of preserving the free status of all derivatives of our free software and of promoting the sharing and reuse of software generally.

NO WARRANTY

15. BECAUSE THE LIBRARY IS LICENSED FREE OF CHARGE, THERE IS NO WARRANTY FOR THE LIBRARY, TO THE EXTENT PERMITTED BY APPLICABLE LAW. EXCEPT WHEN OTHERWISE STATED IN WRITING THE COPYRIGHT HOLDERS AND/OR OTHER PARTIES PROVIDE THE LIBRARY "AS IS" WITHOUT WARRANTY OF ANY KIND, EITHER EXPRESSED OR IMPLIED, INCLUDING, BUT NOT LIMITED TO, THE IMPLIED WARRANTIES OF MERCHANTABILITY AND FITNESS FOR A PARTICULAR PURPOSE. THE ENTIRE RISK AS TO THE QUALITY AND PERFORMANCE OF THE LIBRARY IS WITH YOU. SHOULD THE LIBRARY PROVE DEFECTIVE, YOU ASSUME THE COST OF ALL NECESSARY SERVICING, REPAIR OR CORRECTION.

16. IN NO EVENT UNLESS REQUIRED BY APPLICABLE LAW OR AGREED TO IN WRITING WILL ANY COPYRIGHT HOLDER, OR ANY OTHER PARTY WHO MAY MODIFY AND/OR REDISTRIBUTE THE LIBRARY AS PERMITTED ABOVE, BE LIABLE TO YOU FOR DAMAGES, INCLUDING ANY GENERAL, SPECIAL, INCIDENTAL OR CONSEQUENTIAL DAMAGES ARISING OUT OF THE USE OR INABILITY TO USE THE LIBRARY (INCLUDING BUT NOT LIMITED TO LOSS OF DATA OR DATA BEING RENDERED INACCURATE OR LOSSES SUSTAINED BY YOU OR THIRD PARTIES OR A FAILURE OF THE LIBRARY TO OPERATE WITH ANY OTHER SOFTWARE), EVEN IF SUCH HOLDER OR OTHER PARTY HAS BEEN ADVISED OF THE POSSIBILITY OF SUCH DAMAGES.

END OF TERMS AND CONDITIONS

How to Apply These Terms to Your New Libraries

If you develop a new library, and you want it to be of the greatest possible use to the public, we recommend making it free software that everyone can redistribute and change. You can do so by permitting redistribution under these terms (or, alternatively, under the terms of the ordinary General Public License).

To apply these terms, attach the following notices to the library. It is safest to attach them to the start of each source file to most effectively convey the exclusion of warranty; and each file should have at least the "copyright" line and a pointer to where the full notice is found.

<one line to give the library's name and a brief idea of what it does.>

Copyright © <year> <name of author>

This library is free software; you can redistribute it and/or modify it under the terms of the GNU Lesser General Public License as published by the Free Software Foundation; either version 2.1 of the License, or (at your option) any later version.

This library is distributed in the hope that it will be useful, but WITHOUT ANY WARRANTY; without even the implied warranty of MERCHANTABILITY or FITNESS FOR A PARTICULAR PURPOSE. See the GNU Lesser General Public License for more details.

You should have received a copy of the GNU Lesser General Public License along with this library; if not, write to the Free Software Foundation, Inc., 51 Franklin St, Fifth Floor, Boston, MA 02110-1301 USA

Also add information on how to contact you by electronic and paper mail.

You should also get your employer (if you work as a programmer) or your school, if any, to sign a "copyright disclaimer" for the library, if necessary. Here is a sample; alter the names: Yoyodyne, Inc., hereby disclaims all copyright interest in the library 'Frob' (a library for tweaking knobs) written by James Random Hacker.

<signature of Ty Coon>, 1 April 1990
Ty Coon, President of Vice

That's all there is to it!

Appendixes

Appendix A:

Picture Format for Each Input Source

Aspect Specifications

Yes: Selectable

No: Un-Selectable

Input Signal			Auto Aspect	Aspect Video ID	Aspect							
					16:9 Standard 1	16:9 Standard 2	16:9 Zoom	4:3 Standard	4:3 Expanded	4:3 Zoom 1	4:3 Zoom 2	
ANT Analog	Video	NTSC	No	4x3	Yes	No	Yes	Yes	Yes	Yes	Yes	
ANT Digital	Y C _B C _R	480p	No	16x9	Yes	No	Yes	No	Yes	No	No	
		480i	No	4x3	No	No	No	Yes	Yes	Yes	Yes	
	Y P _B P _R	1080i/720p	No	16x9	Yes	Yes	Yes	No	Yes	No	No	
Input 1	HDMI	1080i/720p	No	16x9	Yes	Yes	Yes	No	Yes	No	No	
			Auto ON	16x9	Yes Initial	No	Yes	No	No	No	No	No
				Letter	No	No	No	Yes	Yes	Yes Initial	Yes	Yes
				4x3	No	No	No	Yes	Yes Initial	Yes	Yes	Yes
				No Info	Yes	No	Yes	Yes	Yes	Yes	Yes	Yes
			Auto OFF	No	Yes	No	Yes	Yes	Yes	Yes	Yes	Yes
			Video S-Video	NTSC	Auto ON	16x9	Yes Initial	No	Yes	No	No	No
	Letter	No				No	No	Yes	Yes	Yes Initial	Yes	
	4x3	No				No	No	Yes	Yes Initial	Yes	Yes	
	No ID	Yes				No	Yes	Yes	Yes	Yes	Yes	
	Auto OFF	No				Yes	No	Yes	Yes	Yes	Yes	Yes
	Auto OFF	No				Yes	No	Yes	Yes	Yes	Yes	Yes
	Input 2	HDMI	1080i/720p	No	16x9	Yes	Yes	Yes	No	Yes	No	No
Auto ON				16x9	Yes Initial	No	Yes	No	No	No	No	
				Letter	No	No	No	Yes	Yes	Yes Initial	Yes	
				4x3	No	No	No	Yes	Yes Initial	Yes	Yes	
				No Info	Yes	No	Yes	Yes	Yes	Yes	Yes	
Auto OFF				No	Yes	No	Yes	Yes	Yes	Yes	Yes	
Video S-Video				NTSC	Auto ON	16x9	Yes Initial	No	Yes	No	No	No
		Letter	No			No	No	Yes	Yes	Yes Initial	Yes	
		4x3	No			No	No	Yes	Yes Initial	Yes	Yes	
		No ID	Yes			No	Yes	Yes	Yes	Yes	Yes	
		Auto OFF	No			Yes	No	Yes	Yes	Yes	Yes	Yes
		Auto OFF	No			Yes	No	Yes	Yes	Yes	Yes	Yes
Input 3		Y P _B P _R	1080i/720p	No	16x9	Yes	Yes	Yes	No	Yes	No	No
	Auto ON			16x9	Yes Initial	No	Yes	No	No	No	No	
				Letter	No	No	No	Yes	Yes	Yes Initial	Yes	
				4x3	No	No	No	Yes	Yes Initial	Yes	Yes	
				No ID	Yes	No	Yes	Yes	Yes	Yes	Yes	
	Auto OFF			No	Yes	No	Yes	Yes	Yes	Yes	Yes	
	No Signal			No	No	No	No	No	No	No	No	
	Video	NTSC	Auto ON	16x9	Yes Initial	No	Yes	No	No	No	No	
				Letter	No	No	No	Yes	Yes	Yes Initial	Yes	
				4x3	No	No	No	Yes	Yes Initial	Yes	Yes	
				No ID	Yes	No	Yes	Yes	Yes	Yes	Yes	
				Auto OFF	No	Yes	No	Yes	Yes	Yes	Yes	Yes
				Auto OFF	No	Yes	No	Yes	Yes	Yes	Yes	Yes

Appendixes

Aspect Specifications

(Continuation)

Yes : Selectable No : Un - Selectable

Input Signal			Auto Aspect	Aspect Video ID	Aspect							
					16:9 Standard 1	16:9 Standard 2	16:9 Zoom	4:3 Standard	4:3 Expanded	4:3 Zoom 1	4:3 Zoom 2	
Input 4	YP _B P _R	1080i/720p	No	16x9	Yes	Yes	Yes	No	Yes	No	No	
		480p 480i	Auto ON	16x9	Yes Initial	No	Yes	No	No	No	No	
				Letter	No	No	No	Yes	Yes	Yes Initial	Yes	
				4x3	No	No	No	Yes	Yes Initial	Yes	Yes	
				No ID	Yes	No	Yes	Yes	Yes	Yes	Yes	
		Auto OFF	No									
	No Signal	No	No									
	Video	NTSC	Auto ON	16x9	Yes Initial	No	Yes	No	No	No	No	
				Letter	No	No	No	Yes	Yes	Yes Initial	Yes	
				4x3	No	No	No	Yes	Yes Initial	Yes	Yes	
				No ID	Yes	No	Yes	Yes	Yes	Yes	Yes	
				Auto OFF	No							
	Input 5	HDMI	1080i/720p	No	16x9	Yes	Yes	Yes	No	Yes	No	No
			480p 480i	Auto ON	16x9	Yes Initial	No	Yes	No	No	No	No
Letter					No	No	No	Yes	Yes	Yes Initial	Yes	
4x3						No	No	Yes	Yes Initial	Yes	Yes	
No Info					Yes	No	Yes	Yes	Yes	Yes	Yes	
Auto OFF		Yes	No	Yes	Yes	Yes	Yes	Yes				
YP _B P _R		1080i/720p	No	16x9	Yes	Yes	Yes	No	Yes	No	No	
		480p 480i	Auto ON	16x9	Yes Initial	No	Yes	No	No	No	No	
				Letter	No	No	No	Yes	Yes	Yes Initial	Yes	
				4x3	No	No	No	Yes	Yes Initial	Yes	Yes	
				No ID	Yes	No	Yes	Yes	Yes	Yes	Yes	
		Auto OFF	No									
No Signal		No	No									
Video		NTSC	Auto ON	16x9	Yes Initial		Yes	No	No	No	No	
				Letter	No	No	No	Yes	Yes	Yes Initial	Yes	
				4x3	No	No		Yes	Yes Initial	Yes	Yes	
				No ID	Yes	No	Yes	Yes	Yes	Yes	Yes	
				Auto OFF	No							
IEEE1394 Digital		YC _B C _R	480p	No	16x9	Yes		Yes		Yes		
			480i	No	4x3	No			Yes	Yes	Yes	Yes
	YP _B P _R	1080i/720p	No	16x9	Yes	Yes	Yes		Yes			
	-	-	No	1394DV	No			Yes	Yes	Yes	Yes	

Index

A

Accessories, 4
Antennas (Connecting), 7
Aspect Ratio, 27, 50
Audio
 Bass Boost 51
Audio Settings 52
Audio Source 52
Auto Noise Cancel 52
A/V Network 68-75

B

Balance 51
Bass 51
Black Enhancement 48
Black Side Panel 49
Brightness 47

C

CableCARD 78
Caution and Safety Tips 2-3
Channel Manager 56-57
 Auto Channel Scan 56
Clock 64
Closed Captions
 Captions 76
Color Temperature 48
Color 47
Contrast 47
Contrast Mode 48

E

External Video Source 18-24

F

Favorite Channel 32
Freeze 26, 35

H

HDMI 16, 19

I

Input Setup 28, 68

L

Language
 Menu Language 66
Locks
 Change Access Code 58
 Channel Lock 58
 Front Panel Lock 58
 Movie Ratings 59
 TV Ratings 60
 TV Ratings (Canadian - English) 61

TV Ratings (Canadian - French) 62
Alternate Ratings U.S. 63

M

Menu Preference
 Language 66
 Background 67
Monitor Out 77

N

Noise Cancel 52

P

Perfect Volume 52
Photo Input 29
Picture Mode 47
Picture-in-Picture (PIP) 33-35
Power Swivel 5, 8, 80

R

Remote Control
 Functions 25-32
 Programming Codes 42-43
 Installing Batteries 4

S

Screen Saver 67
Sharpness 47
Speakers 51
 Connecting External Speakers 21
 Internal 52
Split Mode 33
Surround 51

T

Timers 65
Tint 47
Treble 51
TV Guide On Screen™ 53-55

V

Video Settings 47-50

W

White Balance 49

Service Information

When you call HITACHI SERVICE HOTLINE they will require some information related to the TV MODEL NAME and SERIAL # in order to give you the proper support. This information is located on the back of the TV and also on the RIGHT SIDE of your TV set. Please follow the next steps to find this information and then provide to SERVICE.

- 1 Look on the right side of the TV.
- 2 Locate the LABEL where it shows the information related to MODEL NAME and SERIAL #.
- 3 HITACHI Service Department will require this information in order to give you the proper support regarding your questions.

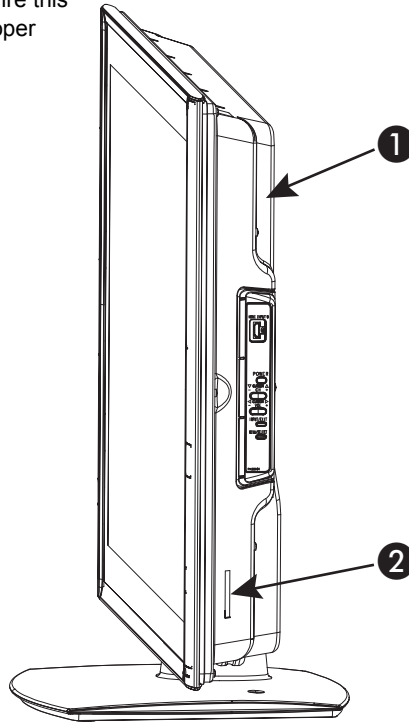

Notes

HITACHI

Inspire the Next