

LED LCD HDTV

OWNER'S GUIDE

Model: **49E30/49E301/49E30A**
49" Class (48.50" Diag.)

Serial No. _____

CONGRATULATIONS

Thank you for purchasing this Hitachi product.
Please read these instructions carefully.

For additional assistance please call Toll Free 800.HITACHI (800.448.2244)
or visit our website at www.hitachi.us/tv.
Keep this Owner's Guide for future reference.

Record the model name and serial number of your LCD Television for future reference.
This information is located on the back of the television.



| | | |
|--|---|---|
|  | CAUTION RISK OF ELECTRIC SHOCK DO NOT OPEN |  |
| CAUTION: TO REDUCE THE RISK OF ELECTRIC SHOCK, DO NOT REMOVE COVER (OR BACK). NO USER-SERVICEABLE PARTS INSIDE. REFER SERVICING TO QUALIFIED SERVICE PERSONNEL. | | |



The lightning flash with arrowhead symbol, within an equilateral triangle is intended to alert the user to the presence of uninsulated dangerous voltage within the product's enclosure that may be of sufficient magnitude to constitute a risk of electric shock.



The exclamation point within an equilateral triangle is intended to alert the user to the presence of important operating and maintenance (servicing) instructions in the literature accompanying the appliance.

| |
|--|
| WARNING: TO PREVENT FIRE OR SHOCK HAZARD, DO NOT EXPOSE THIS APPLIANCE TO RAIN OR MOISTURE. TO PREVENT THE SPREAD OF FIRE, KEEP CANDLES OR OPEN FLAMES AWAY FROM THIS PRODUCT AT ALL TIMES. |
| CAUTION: TO PREVENT ELECTRIC SHOCK, DO NOT USE THIS TELEVISION'S AC PLUG WITH AN EXTENSION CORD, RECEPTACLE OR OTHER OUTLET UNLESS THE BLADES CAN BE FULLY INSERTED TO PREVENT BLADE EXPOSURE |

LEAD NOTICE

This product contains lead. Dispose of this product in accordance with applicable environmental laws. For product recycling and disposal information, contact your local government agency or www.eRecycle.org (in California), the Electronic Industries Alliance at www.ecyclingcentral.com (in the U.S.) or the Electronic Product Stewardship Canada at www.epsc.ca (in Canada).

This equipment is a Class II or double insulated electrical appliance. It has been designed in such a way that it does not require a safety connection to electrical earth.

WARNING: This equipment has been tested and found to comply with the limits for a Class B digital device, pursuant to Part 15 of the FCC Rules. These limits are designed to provide reasonable protection against harmful interference in a residential installation. This equipment generates, uses and can radiate radio frequency energy and, if not installed and used in accordance with the instructions, may cause harmful interference to radio communications. However, there is no guarantee that interference will not occur in a particular installation. If this equipment does cause harmful interference to radio or television reception, which can be determined by turning the equipment off and on, the user is encouraged to try to correct the interference by one or more of the following measures:

- Reorient or relocate the receiving antenna.
- Increase the separation between the equipment and receiver.
- Connect the equipment to an outlet on a circuit different from that to which the receiver is connected.
- Consult the dealer or an experienced radio/TV technician for help.

CAUTION: Changes or modifications not expressly approved by the party responsible for compliance with the FCC Rules could void the user's authority to operate this equipment.

This Television receiver will display television closed captioning, ( or ), and provides text-to-speech audio, in accordance with FCC rules.

The examples used throughout this manual are based on the 49E30 model. 49E301 have identical features except where noted where noted in this manual.

Location of the required Marking

The rating sheet and the safety caution are on the rear of the unit.

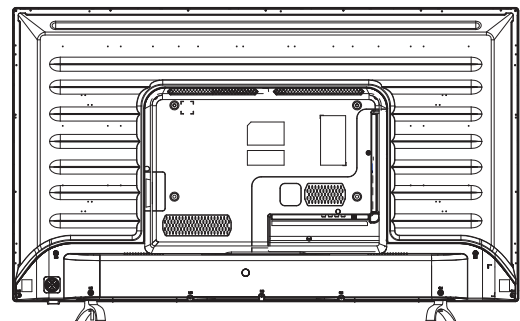

Declaration of Conformity

This device complies with part 15 of the FCC Rules. Operation is subject to the following two conditions:

- (1) This device may not cause harmful interference and
- (2) This device must accept any interference received, including interference that may cause undesired operation.

For questions regarding this declaration, contact:

©Hitachi America, Ltd.
2420 Fenton Street, Suite 200
Chula Vista, CA 91914-3556
ATTN: Customer Relations

IMPORTANT SAFETY INSTRUCTIONS

- 1) Read these instructions.
- 2) Keep these instructions.
- 3) Heed all warnings.
- 4) Follow all instructions.
- 5) Do not use this apparatus near water.
- 6) Clean only with dry cloth.
- 7) Do not block any ventilation openings. Install in accordance with the manufacturer's instructions.
- 8) Do not install near any heat sources such as radiators, heat registers, stoves, or other apparatus (including amplifiers) that produce heat.
- 9) Do not defeat the safety purpose of the polarized or grounding-type plug. A polarized plug has two blades with one wider than the other. A grounding type plug has two blades and a third grounding prong. The wide blade or the third prong are provided for your safety. If the provided plug does not fit into your outlet, consult an electrician for replacement of the obsolete outlet.
- 10) Protect the power cord from being walked on or pinched particularly at plugs, convenience receptacles, and the point where they exit from the apparatus.
- 11) Only use attachments/accessories specified by the manufacturer.
- 12) Use only with cart, stand, tripod, bracket, or table specified by the manufacturer, or sold with the apparatus. When a cart is used, use caution when moving the cart/apparatus combination to avoid injury from tip-over.
- 13) Unplug this apparatus during lightning storms or when unused for long periods of time.
- 14) Refer all servicing to qualified service personnel. Servicing is required when the apparatus has been damaged in any way, such as power-supply cord or plug is damaged, liquid has been spilled or objects have fallen into the apparatus, the apparatus has been exposed to rain or moisture, does not operate normally, or has been dropped.
- 15) Apparatus should not be exposed to dripping or splashing, and objects filled with liquids, such as vases, should not be placed on the apparatus.
- 16) An outside antenna system should not be located in the vicinity of overhead power lines or other electric light or power circuits, or where it can fall into such power lines or circuits. When installing an outside antenna system, extreme care should be taken to keep from touching such power lines or circuits, as contact with them might be fatal.
- 17) Do not overload wall outlets and extension cords, as this can result in a risk of fire or electric shock.
- 18) Do not push objects through any openings in this unit, as they may touch dangerous voltage points or short out parts that could result in fire or electric shock. Never spill or spray any type of liquid into the unit.
- 19) If an outside antenna or cable system is connected to the unit, be sure the antenna or cable system is grounded to provide some protection against voltage surges and built-up static charges, Section 810 of the National Electrical Code, ANSI/NFPA 70, provides information with respect to proper grounding of the mast and supporting structure, grounding of the lead-in wire to an antenna discharge unit, size of grounding conductors, location of antenna discharge unit, connection to grounding electrodes, and requirements for the grounding electrode.
- 20) When replacement parts are required, be sure the service technician uses replacement parts specified by the manufacturer or those that have the same characteristics as the original part.
Unauthorized substitutions may result in fire, electric shock or other hazards.
- 21) Upon completion of any service or repairs to this unit, ask the service technician to perform safety checks to determine that the unit is in proper operating condition.
- 22) When you connect the product to other equipment, turn off the power and unplug all of the equipment from the wall outlet. Failure to do so may cause an electric shock and serious personal injury. Read the owner's manual of the other equipment carefully and follow the instructions when making any connections.



S3125A

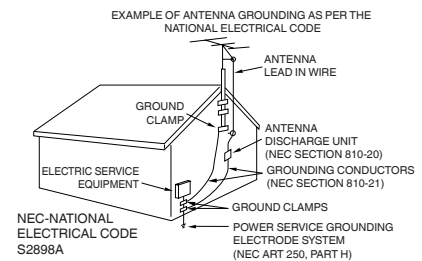

IMPORTANT SAFETY INSTRUCTIONS (continued)

- 23) Do not allow the product to output distorted sound for an extended period of time. It may cause speaker overheating and fire.
- 24) This reminder is provided to call the cable TV system installer's attention to Article 820-40 of the NEC that provides guidelines for proper grounding and, in particular, specifies that the cable ground shall be connected to the grounding system of the building, as close to the point of cable entry as practical.
- 25) The mains plug is used as the disconnect and shall remain readily operable.

WARNING: Never place a television set in an unstable location. A television set may fall and cause, serious personal injury or death. Many injuries, particularly to children, can be avoided by taking simple precautions such as:

- Use cabinets or stands recommended by the manufacturer of the television set.
- Only use furniture that can safely support the television set.
- Ensure the television set is not overhanging the edge of the supporting furniture.
- Do not place the television set on tall furniture (for example, cupboards or bookcases) without anchoring both the furniture and the television set to a suitable support.
- Do not place the television set on cloth or other materials that may be located between the television set and supporting furniture.
- Educate children about the dangers of climbing on furniture to reach the television set or its controls.

If your existing television set is being retained and relocated, observe the above precautions.

CONDENSATION

Moisture will form in the operating section of the unit if the unit is brought from cool surroundings into a warm room or if the temperature of the room rises suddenly. When this happens, unit's performance will be impaired. To prevent this, let the unit stand in its new surroundings for about an hour before switching it on, or make sure that the room temperature rises gradually. Condensation may also form during the summer if the unit is exposed to the breeze from an air conditioner. In such cases, change the location of the unit.

HOW TO HANDLE THE LCD PANEL

- Do not press hard or jolt the LCD panel. It may cause the LCD panel glass to break and injury may occur.
- If the LCD panel is broken, make absolutely sure that you do not touch the liquid in the panel. This may cause skin inflammation. If the liquid gets in your mouth, immediately gargle and consult with your doctor. Also, if the liquid gets in your eyes or touches your skin, consult with your doctor after rinsing for at least 15 minutes or longer in clean water.

Possible Adverse Effects on LCD Panel: If a fixed (non-moving) pattern remains on the LCD Panel for long periods of time, the image can become permanently engrained in the LCD Panel and cause subtle but permanent ghost images. This type of damage is NOT COVERED BY YOUR WARRANTY. Never leave your LCD Panel on for long periods of time while it is displaying the following formats or images:

- Fixed Images, such as stock tickers, video game patterns, TV station logos, and websites.
- Special Formats that do not use the entire screen. For example, viewing letterbox style (16:9) media on a normal (4:3) display (black bars at top and bottom of screen); or viewing normal style (4:3) media on a widescreen (16:9) display (black bars on left and right sides of screen).

The following symptoms are not signs of malfunction but technical limitation. Therefore we disclaim any responsibility for these symptoms.

- LCD Panels are manufactured using an extremely high level of precision technology, however sometimes parts of the screen may be missing picture elements or have luminous spots.
This is not a sign of a malfunction.
- Do not install the LCD Panel near electronic equipment that produces electromagnetic waves. Some equipment placed too near this unit may cause interference.
- Effect on infrared devices – There may be interference while using infrared devices such as infrared cordless headphones.

Power source

This television is designed to operate on 120 volts 60 Hz, AC current. Insert the power cord into a 120 volts 60 Hz outlet. To prevent electric shock, do not use the television's (AC) plug with an extension cord, receptacle, or other outlet unless the blades can be fully inserted to prevent blade exposure. Never connect the television to direct current or anything other than the specified voltage.

Warning

To reduce the risk of fire or electric shock, do not expose this apparatus to rain or moisture.

Caution

Never remove the back cover of the television as this can expose you to very high voltages and other hazards. If the television does not operate properly, unplug the television and call your authorized dealer or service center. Adjust only those controls that are covered in the instructions, as improper changes or modifications not expressly approved by Hitachi could void the user's warranty.

CHILD SAFETY NOTICE

CHILD SAFETY:

It Makes A Difference How and Where
You Use Your Flat Panel Display

Congratulations on your purchase!

As you enjoy your new product, please keep these safety tips on mind:



HITACHI CARES!

- The consumer electronics industry is committed to making home entertainment enjoyable and safe.
- Please note the American Academy of Pediatrics discourages television viewing for children younger than two years of age.
- The home theater entertainment experience is a growing trend and larger flat displays are popular purchases. However, flat panel displays are not always supported on the proper stands or installed according to the manufacturer's recommendations.
- Flat Panel displays that are inappropriately situated on dresser, bookcases, shelves, desks, speakers, chest or carts may fall over and cause injury.

TUNE INTO SAFETY

- One size does NOT fit all. Follow the manufacturer's recommendations for the safe installation and use of your flat panel display.
- Carefully read and understand all enclosed instructions for proper use of this product.
- Don't allow children to climb on or play with furniture and television sets.
- Don't place flat panel displays on furniture that can easily be used as steps, such as a chest of drawers.
- Remember that children can become excited while watching a program, especially on a "larger than life" flat panel display. Care should be taken to place or install the display where it cannot be pushed, pulled over, or knocked down.
- Care should be taken to route all cords and cables connected to the flat panel display so that they cannot be pulled or grabbed by curious children.

WALL MOUNTING: IF YOU DECIDE TO WALL MOUNT YOUR FLAT PANEL DISPLAY, ALWAYS:

- Use a mount that has been recommended by the display manufacturer and/or listed by an independent laboratory (such as UL, CSA, ETL).
- Follow all instructions supplied by the display and wall mount manufacturers.
- If you have any doubts about your ability to safely install your flat panel display, contact your retailer about professional installation.
- Make sure that the wall where you are mounting the display is appropriate.
- Some wall mounts are not designed to be mounted to walls with steel studs or old cinder block construction.
- If you are unsure, contact a professional installer.
- A minimum of two people are required for installation. Flat panel displays can be heavy.



 **CEA**
Consumer Electronics Association
www.CE.org/safety

SAFETY PRECAUTIONS

The unit emits heat when in operation. Do not place any covers or blankets on the unit, this may cause overheating. Do not block ventilation holes, or set up near radiators. Do not place in direct sunlight. When placing on a shelf leave 4 inches (10 cm) free space around the entire unit.

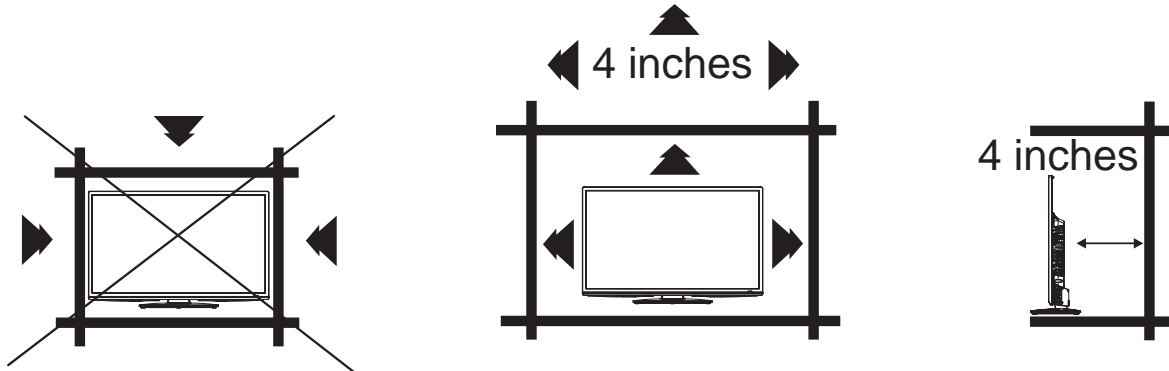

Notes when mounting the TV on a wall

If the unit is to be mounted on the wall, contact the retailer where you purchased the TV for advice, and have the equipment professionally installed. Incomplete or improper installation may cause injury to you, and/or damage to the TV.

The screws M6 thread type should be used. The insertion length must be within 10-12 mm.

If the insertion length is less than 10 mm the weight can not be maintained.

If the insertion length is more than 12 mm a space is created between the Wall Mount Bracket and the Television.

(Insertion Length) = (Screw Length) - (Washers Thickness) - (Mounting Bracket Thickness)

Securing to a Wall

1 Use metallic wire, screw and clamp (not provided) on the rear of the TV as shown below.

2 Keep the TV 4 inches away from the wall, except when mounted using the wall mount bracket, and secure to the wall as shown below:

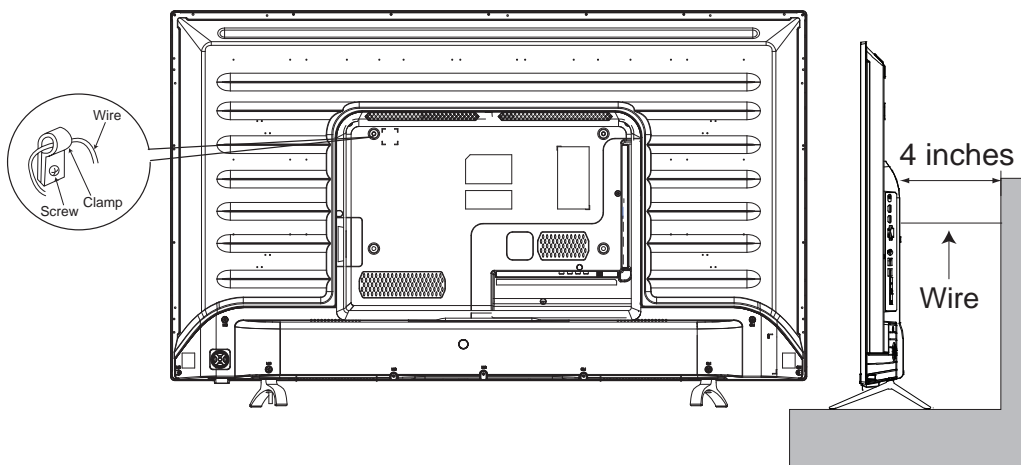

NOTICE FOR TV CABINET

If the unit is placed on a cabinet smaller than the length of the unit, it could result in instability and the unit may tumble over, making a risk of personal, possibly fatal injury. Also, this would seriously damage the product. Accordingly, Hitachi accepts no responsibility or liability for any injuries or property damage resulting from the improper installation.

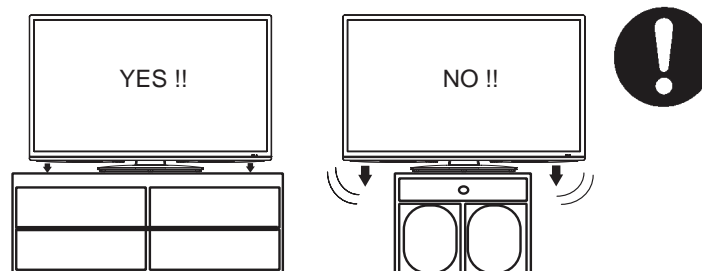

How to attach the stand

NOTE:

- Assure the AC cord is not connected to an AC outlet.
- Before beginning this process, make sure that you have a clean, safe, and cushioned space to work at to avoid any damage to the unit.
- Do not touch or press the LCD screen, the glass might break under pressure.

- 1 Carefully place the TV screen face-down on a clean, cushioned surface.
- 2 Insert and secure the stands (R and L) with 2 screws (supplied) each side as shown in Figure 1.

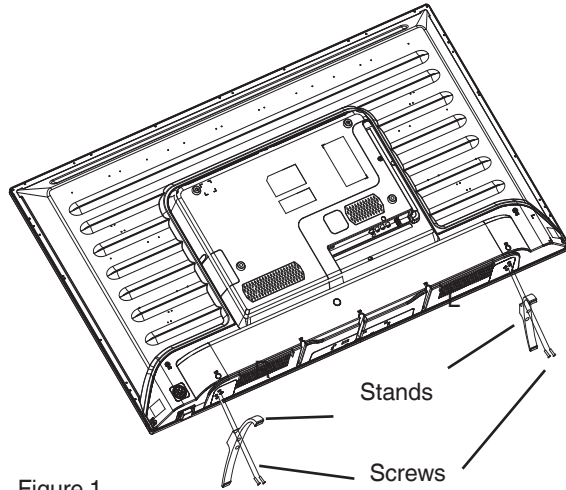
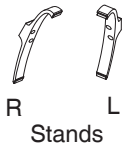

Figure 1

- Be sure to follow the above instructions. Insufficient tightening or incorrect installation of the stand will not support your TV correctly, and could result in damage or injury from tip-over.

How to remove the stand

When you transport this product, remove the stand and pack it flat against the back of the unit in the carton. To remove the stand, perform the above steps in reverse order.

When you mount the TV on the wall, remove both stands (R and L). To disconnect the stand remove the screws from the bottom of TV.

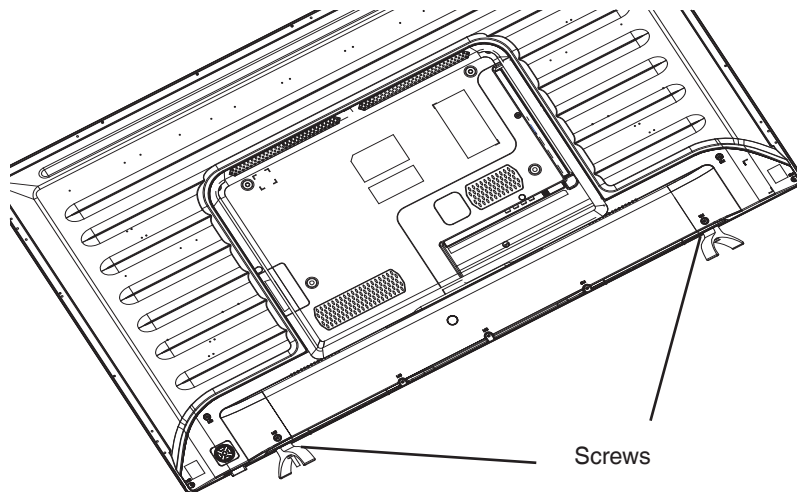

Contents

| | |
|--|----|
| Chapter 1: Introduction | |
| Precautions..... | 2 |
| IMPORTANT SAFETY INSTRUCTIONS..... | 3 |
| CHILD SAFETY NOTICE..... | 5 |
| SAFETY PRECAUTIONS..... | 6 |
| How to attach the stand..... | 7 |
| How to remove the stand..... | 7 |
| Location of controls..... | 9 |
| Remote Control Functions..... | 10 |
| Features..... | 11 |
| Battery Precautions..... | 12 |
| Antenna connections..... | 13 |
| Cable TV connections..... | 13 |
| Chapter 2: TV Operation | |
| Starting setup..... | 14 |
| TV operation..... | 14 |
| Quick guide for menu operation..... | 15 |
| Convenience functions..... | 16 |
| Channels setup..... | 19 |
| Labeling channels..... | 20 |
| Setting the Parental Control..... | 20 |
| Closed Caption..... | 22 |
| CC options..... | 23 |
| Aspect Switching..... | 23 |
| JPEG Viewer..... | 24 |
| Chapter 3: Addition Information | |
| Reception disturbances..... | 25 |
| Troubleshooting..... | 26 |
| Specifications..... | 27 |
| LIMITED WARRANTY..... | 28 |

Chapter 1

TV Control Keys

Introduction

The TV control keys are multi-function buttons that help navigate or operate the TV without a remote control.

1. **⏻ / MENU** button
 - A. Press to power ON the TV from Stand by mode.
 - B. When the TV is ON:
 1. Press to display the control menu OSD (On-screen Display).
 2. Press to select OK.
 3. Press and hold for more than 2 seconds to set the TV to standby.
2. **CH.+ / CH.-** buttons
 - A. Press to change the channel.
 - B. Press to navigate up / down while in the OSD.
3. **VOL.+ / VOL.-** buttons
 - A. Press to change the volume level.
 - B. Press to navigate right / left while in the OSD.

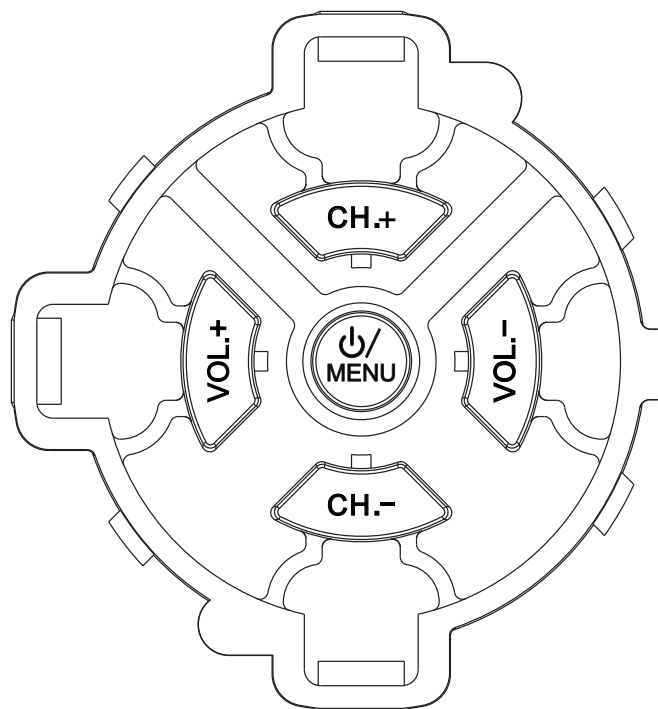

Remote control



| | |
|------------------|---|
| | Press to turn the TV's power on/off. |
| INPUT | Calls the input source selection menu. |
| 0-9 | (Numeric buttons) Use to enter channel numbers. |
| — | Use to enter a digital channel with a sub-channel. Enter the main channel, then press dash (—), enter the sub-channel, and then press OK to confirm your entry. |
| GUIDE | Press to display the electric program guide. |
| MENU | Press to call the main menu OSD or press to return to the previous menu. |
| EXIT | Press to exit the On-Screen menu. |
| | (Cursor Up/Down/Left/Right buttons) Use to navigate and select menu functions. |
| OK | Press to confirm or select functions for the On-Screen menu. |
| ZOOM +/- | Press to call the ASPECT selection OSD. |
| SLEEP +/- | Repeatedly press to set the sleep timer from 5 to 240 minutes. To cancel the sleep timer, press SLEEP until "Off" appears. |
| P.MODE | Press to call the Picture Mode on-screen display menu. |
| RETURN | Return to the previous channel in TV mode. |
| VOL +/- | (Volume UP/DOWN) Increase or decrease the TV's volume. |
| INFO | Press to display information about the TV status. |
| MUTE | (MUTE) Reduces the TV's volumes to its minimum level. Press again to restore the volume. |
| CH▼/▲ | Press to change the channel of the TV. |
| FAV | Press to access the Favorite Channel list. |
| USB | Press to go to the Multimedia page. |
| MTS | Press to change the audio language. |
| C.C. | Press to set Closed Caption to "CC Off", "CC On Mute" or "CC On". |
| | (Previous) Press to select the previous chapter |
| | (Play/Pause) Press to start, pause or resume viewing. |
| | (Stop) Press to stop viewing. |
| | (Next) Press to select the next chapter. |

Features

HDTV

Unique space saving design LED LCD HDTV.

Picture Performance

- Long Life LED Backlight

Convenience

- USB Input (JPEG Photo Viewer, Software Updates)
- Sleep Timer (5-240 min)

Audio Performance

- Dolby® Digital/MTS Stereo/SAP

* The terms HDMI and HDMI High-Definition Multimedia Interface, and the HDMI Logo are trademarks or registered trademarks of HDMI Licensing LLC in the United States and other countries.

* Manufactured under license from Dolby Laboratories. Dolby, Dolby Audio and the double-D symbol are trademarks of Dolby Laboratories.

Inputs / Outputs

USB



USB

This input can be used to connect a USB device.

HDMI 1/2/3 →

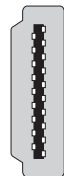

HDMI1 /HDMI2/HDMI3 (ARC)

The HDMI inputs receives digital audio and video from an HDMI device.

AV IN

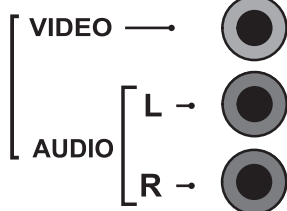

AV (VIDEO) IN

This input is used to connect a range of equipment such as DVD players, or satellite receivers to the AV input. To use the AV input connect the device's video output to the TV's Video input.

The AUDIO IN (L & R) input use RCA audio cables to connect the audio output for the AV input to the TV.

LINE OUT



LINE OUT (Fixed)

Use a 3.5mm stereo to RCA audio cable to connect your TV to a compatible audio receiver.

OPTICAL →



DIGITAL AUDIO OUT: OPTICAL

This output can be used to connect a compatible digital audio receiver.

AIR/CABLE →



AIR/CABLE IN

This input is used to connect to an external antenna (AIR) or to a cable (CABLE) output.

BATTERY PRECAUTIONS

These precautions should be followed when using batteries.

- Use only the size and type of batteries specified.
- Be sure to follow the correct polarity when installing the batteries as indicated in the battery compartment. Reversed batteries may cause damage to the device.
- Do not mix different types of batteries together (e.g. Alkaline, Carbon-zinc or Rechargeable) or old batteries with fresh ones.
- If the device is not to be used for a long period of time, remove the batteries to prevent damage or injury from possible battery leakage.
- Do not try to recharge batteries not intended to be recharged; they can overheat and rupture. (Follow battery manufacturer's directions.)
- Please use caution when inserting batteries to avoid battery damage. If the spring terminal in the remote control remains in contact with a side of a damaged battery it can cause a short circuit. Never use damaged batteries as they can become very hot and are dangerous.

Before using the remote control, batteries must first be installed.

Use two "AAA" size batteries. The batteries may last approximately one year depending on how much the remote control is used. For best performance, it is recommended that batteries should be replaced on a yearly basis or when the remote operation becomes erratic. Do not mix old and new batteries or batteries of different types.

WARNING: The batteries (battery pack or batteries installed) shall not be exposed to excessive heat such as sunshine, fire or the like.
: Attention should be drawn to environmental aspects of battery disposal. Dispose of the batteries in accordance with local environmental laws.

HOW TO INSTALL BATTERIES

1. Open the battery compartment cover.
2. Install two "AAA" batteries (supplied).

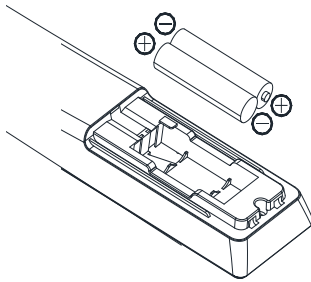

3. Replace the battery compartment cover.

Antenna connections

If you are using an indoor or outdoor antenna, follow the instructions below that correspond to your antenna system. If you are using a Cable TV service, see Cable TV connections.

Combination VHF/UHF Antenna (Single 75 ohm cable)

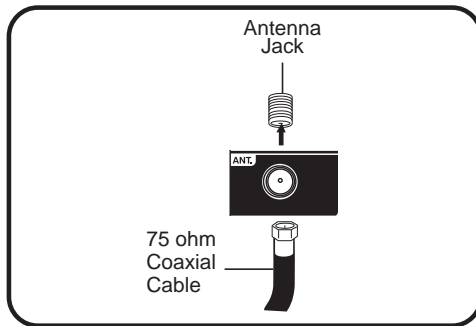

Connect the 75 ohm cable from the combination VHF/UHF antenna to the Antenna Jack.

Cable TV connections

This TV has an extended tuning range and can tune most cable channels without using a Cable TV Converter box. Some cable companies offer “premium pay channels” where the signal is scrambled. Descrambling these signals for normal viewing requires the use of a descrambler device which is generally provided by the Cable TV company.

For subscribers to basic Cable TV service

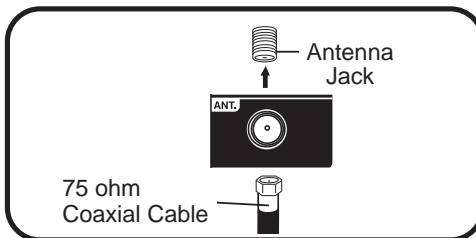

For basic Cable TV service not requiring a Converter/Descrambler box, connect the 75 ohm Coaxial Cable directly to the Antenna Jack on the back of the TV.

For subscribers to scrambled Cable TV service

If you subscribe to a Cable TV service which requires the use of a Converter/Descrambler box, connect the incoming 75 ohm Coaxial Cable to the Converter/Descrambler box. Using another 75 ohm Coaxial Cable, connect the output jack of the Converter/Descrambler box to the Antenna Jack on the TV. Follow the connections shown below. Set the TV to the output channel of the Converter/Descrambler box (usually channel 3 or 4) and use the Converter/Descrambler box to select channels.

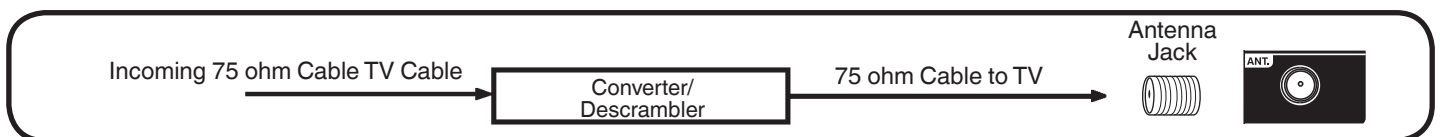

For subscribers to unscrambled Cable TV service with scrambled premium channels

If you subscribe to a Cable TV service in which basic channels are unscrambled and premium channels require the use of a Converter/Descrambler box, you may wish to use a signal Splitter and an A/B Switch box (available from the Cable TV company or an electronics supply store). Follow the connections shown below. With the switch in the “A” position, you can directly tune any non-scrambled channels on your TV. With the switch in the “B” position, tune your TV to the output of the Converter/Descrambler box (usually channel 3 or 4) and use the Converter/Descrambler box to tune scrambled channels.

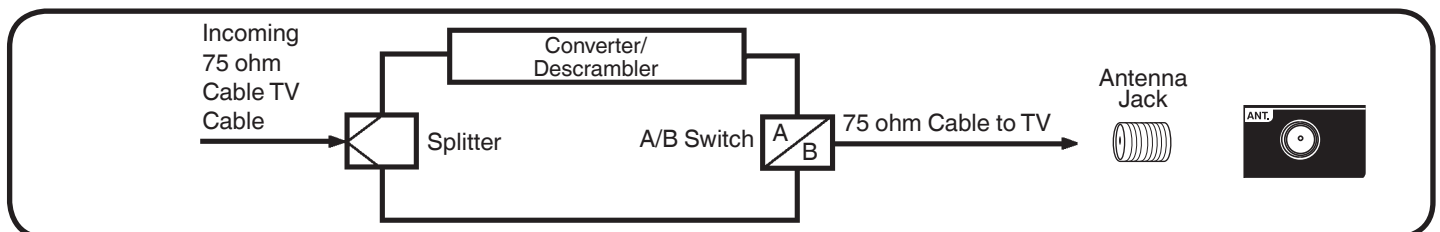

Chapter 2

Starting setup

The Setup Wizard appears the first time you turn on the TV, and assists you to specify the Air/Cable setting, and program your channels automatically.

IMPORTANT: Make sure that the antenna or cable TV system connection is made.

1 To turn on the TV, press **⏻**. It may take approx. 10 seconds for a picture to appear on screen. The Initial Setup Wizard begins.



3 Select your "TV Mode" by pressing **◀** or **▶** to select "Home" or "Store".

NOTE:

Home mode will remember customized user settings in TV. Store mode is intended for in-store display and resets user settings each time TV is turned off.

4 Press **▶** or **OK** to go to the next step.

5 Press **◀** or **▶** to select your menu language, then press **▼** or **OK**. Press **▶** or **OK** to go to the next step.

6 Press **◀** or **▶** to select your time zone, then press **▼** or **OK**.
 • In the rare event that you live within broadcast range of two stations in two different time zones, the TV may recognize the wrong station for the auto clock set.

7 Press **◀** or **▶** to select daylight saving time on or off, then press **▼** or **OK**.

8 Press **◀** or **▶** to your desired time format, then press **▼** or **OK**.

9 Press **▶** or **OK** to go to the next step.

10 Press **◀** or **▶** to select the signal type that you using, then press **▼** or **OK**.

11 Press **▶** or **OK** to go to the next step.

12 Auto Channel Scan will begin. After the scan is completed, a TV channel appears on the screen.

- Depending on the reception condition, it may take up to 30 minutes to complete scanning channels. Please allow the process to complete without interruption.

NOTE:

- If you press **EXIT** during the "Auto Channel Scan" process, the Auto Channel Scan will stop and the TV will change to the normal view. When you make a menu selection, your changes occur immediately. You do not have to press **EXIT** to see your changes.

TV Operation

TV operation

1 To turn on the TV, press **⏻**. It may take approx. 10 seconds for a picture to appear on screen.

2 Adjust the volume level by pressing **VOL (VOLUME) +** or **-**. The volume level will be indicated on the screen by a volume bar. If the volume increases, the number of bars also increases. If the volume decreases, the number of bars also decreases.

3 Set the Source option to the appropriate selection (see "Air/Cable selection" on page 19).

4 Press the **Direct Channel Selection Buttons (0-9, -)** to select the channel.

TO SELECT ANALOG CHANNELS

- 1-9: Press **1-9** as needed. Example, to select channel 2, press **2**, then press **OK**.
- 10-99: Press the 2 digits in order. Example, to select channel 12, press **1, 2**, then press **OK**.
- 100-135: Press the 3 digits in order. Example, to select channel 120, press **1, 2, 0**, then press **OK**.

TO SELECT DIGITAL CHANNELS

Press the first digits, then press the **-** button followed by the remaining number.

Example: To select channel 15-1, press **1, 5, -, 1**, then press **OK**.

- If a channel is selected with only audio content, "Audio Only" will be displayed on the screen.
- If a channel is selected with a weak digital signal, "No Signal" will be displayed on the screen.
- The same program may be available on either an analog channel or a digital channel. You may choose to watch either format.

VHF/UHF/CABLE CHANNELS

| Air | Cable |
|--------------|--|
| VHF 2-13 | VHF 2-13 |
| UHF 14-69 | STD/HRC/IRC 14-36 (A) (W) 37-59 (AA) (WW) 60-85 (AAA) (ZZZ) 86-94 (86) (94) 95-99 (A-5) (A-1) 100-135 (100) (135) 01 (4A) |

NOTE:

- If a channel with no broadcast is selected, the sound will automatically be muted.
- It may take a few seconds for a digital channel picture to appear on screen after being selected.
- To direct tune to a digital channel that is not stored in the channel list enter the first digits followed by **-** and press **OK**. For example if you want to select channel **15-2**, press **1, 5, -** then press **OK**.

To select the video input source

To view a signal from another device connected to your TV, such as a VCR player, press **INPUT**, then press **▲** or **▼** to select the desired input, then press **OK**.

CH ^/∨

Press and release **CH ^/∨**. The TV automatically stops at the next channel.

For proper operation, before selecting channels, they should be set into the memory. See "Channels setup" on page 19.

INFO

Press **INFO** to display the current information on the screen.

When the TV receives a digital signal, the digital information will appear.



- Channel number
- Channel label (if preset)
- Parental Control
- Program guide
- Resolution
- DTV Signal condition
- Broadcast program name
- Close Caption Display
- Current date and time
- Audio language

Press **INFO** again to clear the display.

MUTE

Press **MUTE** to switch off the sound. The TV's sound will be silenced and MUTE icon will appear on the screen. The sound can be switched back on by pressing this button again or by pressing the **VOL (VOLUME) +** or **-** buttons.

SLEEP

To set the TV to turn off automatically after a preset amount of time, press **SLEEP** on the remote control. The clock will change for each press of the **SLEEP** button (Off, 5 min, 10 min, ..., 240 min).

To confirm the sleep timer setting, press **SLEEP** and the remaining time will be displayed for a few seconds. To cancel the sleep timer, press **SLEEP** repeatedly.

Quick guide for menu operation

Example: Select Menu Language.

- 1 Press **INPUT** to select TV mode.
- 2 Press **MENU**. The TV menu screen will appear.



- 3 Press **◀** or **▶** to select "Setup", then press **▼**.
- 4 Press **▲** or **▼** to select "Menu Language", then press **◀** or **▶** to select the desired language.
- 5 Press **EXIT** to return to the normal screen.

NOTE:

- On the following pages, the menu can be called in the same way described above, by pressing the **MENU** button.
- If no buttons are pressed for more than about 15 seconds (depending on your setting), the TV will return to normal viewing automatically.
- During TV or external input mode, if there is no signal reception, the TV will change to standby after approx. 15 minutes.

Convenience functions

You can change the default settings by pressing the **MENU** button on your remote, then select the one of the icons at the top of the menu - follow the On-Screen prompts to set your preferences.

| Icon | Selected Items | Setup hint |
|------------------|---|--|
| Video | Picture Mode | |
| | Standard | Standard picture quality |
| | Dynamic | Bright and dynamic picture |
| | Movie | Soft edge picture setting |
| | ECO | Setting optimized to save energy. |
| | Custom | Your personal preferences |
| | Brightness | You can adjust the picture quality to your preference. • Available only when you selected "Custom". |
| | Contrast | |
| | Color | |
| | Tint | |
| | Sharpness | |
| | Color Temperature | Cool (Bluish) / Standard (Neutral) / Warm (Reddish) |
| | Advanced Settings | |
| | Aspect Ratio | See page 23. |
| Noise Reduction | Set the level of decreasing noise included in the video signal. Off/Low/Middle / High | |
| Dynamic contrast | Use this feature to change the black level automatically according to the brightness of an image. The black level will become dark in a dark scene. Off / On | |
| HDMI Mode | Select Video mode for general use (i.e. with a STB, BD Player, DVD Player, or Game Console). Select Graphic mode for use with a PC. Auto/Video/Graphic | |

Convenience functions

| Icon | Selected Items | Setup hint |
|-------|--|---|
| Audio | | |
| | Sound Mode | |
| | Standard / Music / Movie / Sports/ Custom | You can choose a basic sound mode to your preference. |
| | Treble | This function controls the high frequency audio to the speakers. • Available only when you selected "Custom". |
| | Bass | This function controls the low frequency audio to the speakers. • Available only when you selected "Custom". |
| | Balance | Adjust the left and right sound channel volume. |
| | MTS | |
| | Stereo / SAP / Mono | The multi-channel TV sound (MTS) feature provides high-fidelity stereo sound. MTS also can transmit a second audio program (SAP) containing a second language or other audio information. This item is valid only when the analog broadcast. |
| | Audio Language | |
| | English / French / Spanish | When two or more audio languages are included in a digital signal, you can select one of the audio languages. (This function is available only for digital broadcasts.) |
| | Digital Output | |
| | Raw / PCM | Select the format for your digital audio output. If you have connected an amplifier / receiver to the digital audio jack on your TV. |
| | Surround Sound | |
| | Off / On | The dynamic presence and sound created offers a thoroughly enjoyable listening experience. |
| | Perfect Volume | |
| | Off / On | Volume level is adjusted automatically to lower volume of loud scenes and to raise volume of quieter scenes. |
| Time | | |
| | Sleep Timer | |
| | Off / 5 / 10 / 15 / 30 / 60 / 90 / 120 / 180 / 240 min | Sleep Timer switches the TV to standby after a defined period of time. To cancel the Sleep Timer, set to "Off". |
| | Time Zone | Select your local time zone for auto clock feature. You can select Newfoundland, Atlantic, Eastern, Central, Mountain, Pacific, Alaska and Hawaii. |
| | Daylight Savings | |
| | Off / On | If you want to activate Daylight Saving Time, select "On". |
| | Time Format | |
| | 12-hour / 24-hour | Select the time format. |
| | Auto Clock | |
| | On/Off | The Auto Clock function will automatically set the built-in clock (Year, Month, Day and Time) when the TV is connected to an antenna or cable TV system and it is turned off. As the TV searches for a receivable station in your area and it receives a broadcast signal for Auto Clock, the Auto Clock needs several minutes to set itself. |
| | Clock | Use the ▲/▼/◀/▶ buttons to set the clock. • Available only when you selected "Time Mode" to "On". |

Convenience functions

| Icon | Selected Items | Setup hint |
|-------------------|---|---|
| Setup | Menu Language | |
| | English / Español | You can choose from two different languages English and Español (Spanish) for the OSD (on-screen displays). Select the language you prefer first, then proceed with the other menu options. |
| | OSD Timeout | |
| | 5 / 15 / 30 / 45 / 60 Sec. | You can set the display time of OSD Menu. |
| | Closed Caption | See page 22. |
| | Input Label | |
| | Default / Antenna / Cable / Satellite / DTV / DVD / Blu-ray / HD-DVD / XBOX / Wii / PS3 / Game / Computer / VCR / DV / Custom (10 characters) | The Input Label feature allows you to label each input source for your TV. You can select a label from a default value or input by yourself with ▲/▼ (alphabet select) / ◀/▶ (select character / position). |
| | Other Settings | |
| | Audio Only | |
| | Off / On | You can turn off the picture on your TV and listen to the programs audio only. To exit audio only mode, press any buttons (except VOL (VOLUME) +/- , MUTE and POWER) on your remote control or unit. |
| | TV Location | |
| | Home / Store | Select location of TV, "Home" or "Store". |
| | About Your TV | Display customer support information. |
| | Reset | |
| | No / Yes | Select "Yes", then press SELECT. Restore Video, Audio (except "Audio Language"), Time (Sleep Timer, Time Format and Auto Sleep only) and Setup (except "Menu Language") settings to the default factory settings. |
| | Setup Wizard | See page 14. |
| | HDMI - CEC | |
| | CEC Enable | Select "On" to enable CEC features. |
| | Device Auto Power Off | When the user turns off the TV, all active CEC enabled devices on the HDMI input will go to Standby. |
| | TV Auto Power On | Pushing the "Play" button on the CEC enabled device will command the device to play, turn the TV on, and the HDMI input, that the device is connected to, will become the active input device for the TV. |
| | ARC | To enable the audio through an AV receiver using HDMI (ARC) |
| | Device Lists | Display devices that are connected to TV. |
| | Connect | To make a connection to a device shown on the device list. |
| | Root Menu | To access the device menu. |
| | Voice Guidance | |
| | Voice Guidance | Select "On" to enable Voice Guidance features. |
| | Volume | Select your preferred volume. (Low/Middle/High) |
| Speed | Select your preferred speed. (Low/Middle/High) | |
| Pitch | Select your preferred pitch. (Low/Middle/High) | |
| Video Description | Video Description enables audio-narrated descriptions of key visual elements of the program. Turn "On" to enable this feature. Note: This feature is only available for the TV input and is only available on select programs. | |
| Lock | See page 20. | |
| Channels | See page 19. (Only accessible in theTV input.) | |

Channels setup

This TV is equipped with a Channel List feature which allows channels to skip up or down to the next channel set into the Channel List, skipping over unwanted channels. Before selecting channels, they must be scanned into the TV's Channel List.

Air/Cable selection

- 1 Select "Channels" ⇒ "Source".
- 2 Press ◀ or ▶ to select "Air" or "Cable".

Air - VHF/UHF channels
Cable - CABLE TV channels



NOTE:

- It may take a few seconds for a digital channel picture to appear on screen after being selected.

Auto Channel Scan

- 1 Select "Channels" ⇒ "Auto Channel Scan", then press ▶ or OK.



- 2 In the confirmation window, press ▶ to select "Yes", then press OK. The TV will begin scanning all the channels available in your area.
 - It may take from 15 minutes to 30 minutes to complete channel scan.
 - Depending on the reception condition the progress bar may not advance for several minutes, please be patient.
 - If you press **MENU** while scanning, the channel scan will stop.

NOTE:

- If you are unsure of the digital channels available in your area, you may visit www.antennaweb.org to receive a list based on your address or zip code. If you require further assistance you may call our toll-free customer service line at 800.HITACHI (800.448.2244) (USA/CANADA).
- New channels may be added to your area periodically, it is recommended to perform the "Auto Channel Scan" procedure regularly.

- 3 The new channels will be added into the channel list.

Channel Manager

You can select the channel that you want to skip.

- 1 Select "Channels" ⇒ "View/Skip", then press ▶ or OK.
- 2 Press ▲ or ▼ to select the channel that you want to skip.



- 3 Press OK to assign ✓ mark for unwanted channel.
- 4 Repeat steps 2 - 3 for other channels you want to skip.

Labeling channels

Channel labels appear with the channel number display each time you turn on the TV, select a channel, or press **DISPLAY**.

You can choose any 7 characters to identify a channel.

To create channel labels

- 1 Select "Channels" ⇒ "Channel Label".
- 2 Press ◀ or ▶ to select a channel you want to label, then press ▼ to select "Channel Label". Then press ▶ or **OK**.



- 3 Press ▲ or ▼ repeatedly until the character you want appears in the first space.

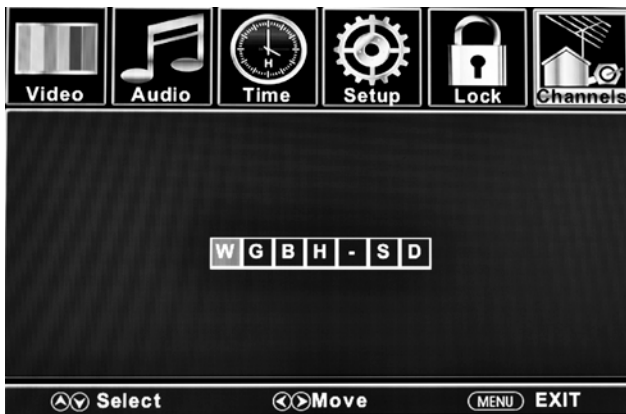

If the character which you desire appears, press ▶. You can move back or forward by pressing the ◀ or ▶. Repeat this step to enter the rest of the characters, then press **OK**.

- 4 Repeat steps 2-3 for other channels. You can assign a label to each channel.
- 5 When you finish inputting the label name, press **EXIT** to return to normal viewing.

NOTE:

- The channel labels will be reset after "Auto Channel Scan" on page 19.

Setting the Parental Control

An age limitation can be set to restrict children from viewing or hearing violent scenes or pictures that you may choose to exclude. The restriction applies to "TV", "Movie", "Canada English Rating" and "Canada French Rating" if this data is transmitted. You may set this restriction separately. To use the Parental Control function, you must register a password.

To enter a password

- 1 Select "Lock", then press ▼.
- 2 Press **0000** using **Direct Channel Selection Buttons (0-9)**. (This is default password.)



"*" appears instead of the number.

NOTE:

- If you forget your password, use the factory password **7777**, you can then gain access to change your password if necessary.
- To avoid forgetting the password, write it down and keep in a safe place.

How to enter the Parental Control menu

- 1 Select "Lock" menu, then press ▼.
- 2 Use **Direct Channel Selection Buttons (0-9)** to enter your password.

To Lock the connected devices

- 1 In the Locks menu, press ▲ or ▼ to select "Parental Control", then press ◀ or ▶ to set to "On".
- 2 Press ▲ or ▼ to select "Input Block", then press ▶ or **OK**.



- 3 Press ▲ or ▼ to select which input will be blocked, then press ◀ or ▶ to select "Block".

To set the Parental Control

- 1 In the Lock menu, press ▲ or ▼ to select "Parental Control" then press ◀ or ▶ to set to "On".
- 2 Press ▲ or ▼ to select "US Rating", then press ▶ or OK.
- 3 Press ▲ or ▼ to select which rating will be used, then press ◀/▶ or OK. Each rating below will appear.

TV

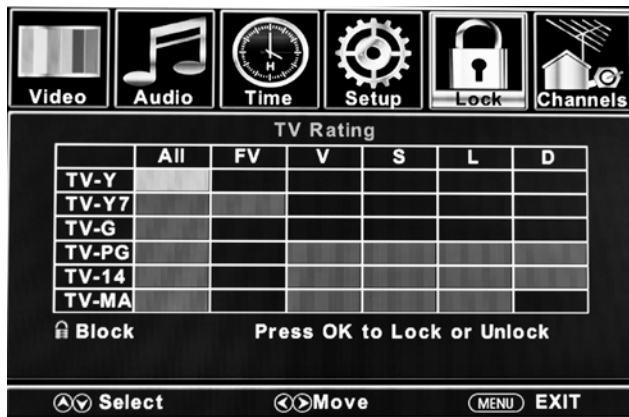

You can set the rating using age level and genre.

Age:

- TV-Y : All children
- TV-Y7 : 7 years old and above
- TV-G : General audience
- TV-PG : Parental guidance
- TV-14 : 14 years old and above
- TV-MA : 17 years old and above

Genre:

- FV : Fantasy Violence
- D : Dialogue
- L : Language
- S : Sex
- V : Violence

Press ▲/▼ to select the desired rating, then press **SELECT**.

Movie

- Off : None
- G : All ages
- PG : Parental guidance
- PG-13 : Parental guidance less than 13 years old
- R : Under 17 years old parental guidance suggested
- NC-17 : 17 years old and above
- X : Adult only

Press ◀/▶ to select the desired rating.

- 4 Press **EXIT** to return to normal viewing. Parental Control function is activated now.

Canadian rating systems

- 1 In the Lock menu, press ▲ or ▼ to select "Parental Control" then press ◀ or ▶ to set to "On".
- 2 Press ▲ or ▼ to select "Canada Rating", then press ▶ or OK.
- 3 Press ▲ or ▼ to select "Canada English" or "Canada French", then press ◀ or ▶ to select the desired rating.



Canada English ratings

You can set the rating using age level.

- Off : Exempt
- C : Programming intended for children under age 8
- C8+ : Programming generally considered acceptable for children 8 years and over to watch on their own
- G : General Audience
- PG : Parental Guidance
- 14+ : Programming contains themes or content which may not be suitable for viewers under the age of 14
- 18+ : Adult

Canada French ratings

- Off : Exempt programming
- G : General: All ages and children, contains minimal direct violence, but may be integrated into the plot in a humorous or unrealistic manner.
- 8ans+ : General but inadvisable for young children: May be viewed by a wide public audience, but could contain scenes disturbing to children under 8 who cannot distinguish between imaginary and real situations. Recommended for viewing with parent.
- 13ans+ : Over 13 years: Could contain scenes of frequent violent scenes and therefore recommended for viewing with parent.
- 16ans+ : Over 16 years: Could contain frequent violent scenes and intense violence.
- 18ans+ : Over 18 years: Only for adult viewing. Could contain frequent violent scenes and extreme violence.

- 4 Press **EXIT** to return to normal viewing. Parental Control function is activated now.

NOTE:

- The Parental Control function is activated only on programs and input sources that include a rating signal.

To change the password

- 1 In the Lock menu, press ▲ or ▼ to select “Change Password”, then press ► or **OK**.
- 2 Enter your old password using **Direct Channel Selection Buttons (0-9)**.
- 3 Enter your new password using **Direct Channel Selection Buttons (0-9)**.
- 4 Enter the new password again to confirm.
Your new password is now registered.

Downloading the additional Parental Control rating system (Region 5)

As a supplement to the standard Parental Control rating system, your television is able to download an additional rating system, if such a system becomes available in the future.

To download the additional Parental Control rating system (when available)

- 1 In the Lock menu, press ▲ or ▼ to select “Parental Control” then press ◀ or ▶ to set to “On”.
- 2 Press ▲ or ▼ to select “Region 5”, then press ► or **OK**.
- 3 If the TV is not storing the additional rating system, the TV will begin downloading it, which may take some time to be completed.
- 4 Set your preferred content rating limits for the additional rating system.

NOTE:

- The TV can download an additional rating system only when receiving a digital signal that carries the Region 5 rating information.
- When you download the additional rating system, it may take some time for the download to occur.
- The Parental Control rating information and system are not determined or controlled by the TV.
- The standard Parental Control rating system is available whether your TV is receiving a digital signal or not, and will block both analog and digital programs.
To set the restriction level using the standard Parental Control rating system, select “US Rating” in step 2.
- The downloadable Parental Control rating system is an evolving technology, and availability, content, and format may vary.

To clear the Region 5

- 1 In the Lock menu, press ▲ or ▼ to select “Parental Control” then press ◀ or ▶ to set to “On”.
- 2 Press ▲ or ▼ to select “Reset Region 5”, then press ► or **OK**. The confirmation window will appear.
- 3 Press ► to select “Yes”, then press **OK**.
Your Region 5 will clear.

Closed Caption

WHAT IS CLOSED CAPTIONING?

This television has the capability to decode and display Closed Captioned television programs. Closed Captioning will display text on the screen for hearing impaired viewers.

Captions: This Closed Caption mode will display text on the screen in English or another language. Generally, Closed Captions in English are transmitted on CC1 and Closed Captions in other languages are transmitted on CC2.

Text: The Text Closed Caption mode will usually fill 1/2 of the screen with a programming schedule or other information.

- 1 Select “Setup” ⇒ “Closed Caption”, then press ► or **OK**.
- 2 Press ◀ or ▶ to set “CC Mode” to “CC On” or “CC On Mute”.
CC On: Captions will be displayed on the screen.
CC On Mute: Only when you press **MUTE**, captions will be displayed.
CC Off: Captions will not be displayed on the screen.
- 3 Press ▲ or ▼ to select “Analog CC” or “Digital CC”.
When you select “Analog CC”, you can choose from CC1~4, Text1~4.
When you select “Digital CC”, you can choose from Service1~6 and Off.
- 4 Press ◀ or ▶ to select the desired Closed Caption mode for both Digital and Analog Captions.

NOTE:

- Depending on the broadcast signal, some Analog Captions will function with a Digital broadcast signal. This prevents two types of captions from overlapping.
- #### NOTE:
- If text is not available in your viewing area, a black rectangle may appear on-screen. If this happens, set the CC Setting to “CC Off”.
 - When selecting Closed Captions, the captioning will appear after approx. 10 seconds.
 - Misspellings or unusual characters may occasionally appear during Closed Captioning.
This is normal with Closed Captioning, especially with live programs. This is because during live programs, captions are also entered live. These transmissions do not allow time for editing.
 - When Captions are being displayed, on-screen displays, such as volume may be seen but may interfere with Closed Captions.
 - Some cable systems and copy protection systems may interfere with the Closed Captioned signal.
 - If using an indoor antenna or if TV reception is very poor, the closed caption may not appear or may appear with strange characters or misspelled words. In this case, adjust the antenna for better reception or use an outdoor antenna.

CC options

When you have selected “Custom” as the display method, you can adjust the various setting listed below.

This feature is designed to customize Digital Caption only.

- 1 Select “Setup” ⇒ “Closed Caption”, then press ► or **OK**.
- 2 Press ◀ or ▶ to set “CC Mode” to “CC On” or “CC On Mute”.
- 3 Select “Option”, then press ► or **OK**.
- 4 Press ▲ or ▼ to select “Mode”, then press ► or **OK**.
- 5 Press ◀ or ▶ to set the “Mode” Preset to “Custom”.
- 6 Press ▲ or ▼ to select the desired item, then press ◀ or ▶ to change the setting.



You can select from among the following items and parameters.

Font: Style

Select display font style.

Font Size:

Select display font size.

Font Edge Style.

Select display font edge style.

Font Edge Color:

Select display font edge color.

FG Color:

Select foreground color.

BG Color:

Select background color.

FG Opacity:

Select foreground opacity level.

BG Opacity:

Select background opacity level.

NOTE:

- You cannot set both “FG Color” and “BG Color” as the same color.
- You cannot set both “FG Opacity” and “BG Opacity” to “Transparent”.

Aspect Switching

You can change the picture size being displayed — Wide, Cinema, Normal and Point to Point.

Selecting the picture size

- 1 Select “Video” ⇒ “Advanced Settings” ⇒ “Aspect”.
- 2 Press ◀ or ▶ to select the desired aspect ratio, as described below.

NOTE:

- Selectable aspect ratios may vary depending on the input source or broadcast signal.
- You can select the desired size of the picture being displayed by pressing **ZOOM +/-** on the remote control.

Wide

Displays the picture at the maximum size.

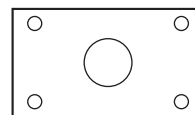

Cinema (for letter box programs)

The entire picture is uniformly enlarged—it is stretched the same amount both wider and taller (retains its original proportion). The top and bottom edges of the picture may be hidden.

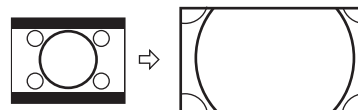

Normal

Displays the picture according to the incoming signal.

Point to Point (for Graphic Mode only)

Detects the resolution of the signal of the image and it will be shown on the screen with same amount of pixels.

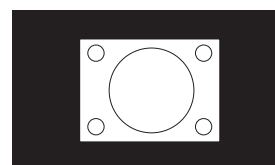

JPEG Viewer

You can enjoy viewing pictures from your USB storage device.

- 1 Connect the USB storage device into the USB Input terminal.
- 2 Press **INPUT** and press **▲** or **▼** to select "USB", then press **OK**.

NOTE:

- Do not disconnect a USB storage device while it is being accessed. Doing so can damage the device or the files stored on the device. You can safely connect or disconnect the USB storage device when the TV is not in USB mode.
- Back up all the data in the USB storage device in case if data was lost due to unexpected accident. We do not assume any liability for the losses by misuse or malfunction.
- Not all USB storage devices are compatible with this TV.
- The character that exceeds the display area is not displayed.
- Do not use a USB extension cable.
- Playable files are JPEG (.jpg/.jpeg).

USB Browser

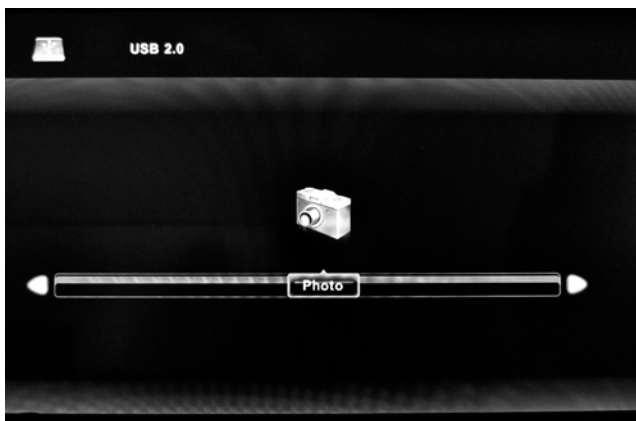

File Selection

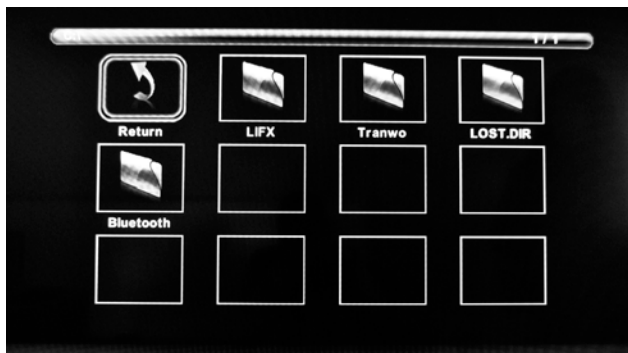

NOTE:

- The content will change in accordance with each media setting screen.

Playback files

- 1 Press **OK** to select Photo.
- 2 Press **OK** to select "C".
- 3 Select a folder or file using the **▲/▼/◀/▶** buttons and then start photo viewing with **OK**.

Chapter 3

Reception disturbances

Addition Information



IGNITION NOISE:

Black spots or horizontal streaks may appear, picture may flutter or drift. Usually caused by interference from automobile ignition systems, neon lamps, electrical drills, and other electrical appliances.



GHOSTS:

Ghosts are caused by the television signal following two paths. One is the direct path and the other is reflected from tall buildings, hills or some other objects. Changing the direction or position of the antenna may improve reception. Ghosting may also be caused by defects in the antenna system such as unshielded leads or connecting several sets to the same antenna without using multiple antenna couplers.



SNOW:

If your receiver is located in the fringe area of a television station where the signal is weak, your picture may be marred by the appearance of small dots. When the signal is extremely weak, it may be necessary to install a special antenna to improve the picture.

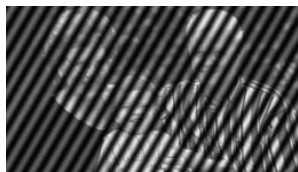

RADIO FREQUENCY INTERFERENCE:

The interference produces moving ripples or diagonal streaks, and in some cases, causes loss of contrast in the picture.

- Keep the television away from Radio.
- Adjust Radio antennas in order for the television not to receive interference.
- The antenna cable of Radio should be kept away from the television.
- Use a coaxial cable for antenna.
- You can check if this television influences Radio receivers by turning off all other equipment other than the television. If you find a problem receiving Radio when using the television, check the instructions mentioned above.



BLOCK NOISE or FREEZE (DIGITAL INPUT):

Fuzzy blocks may appear in some area or the whole area of the screen. This is usually caused by interference from automobile ignition systems, neon lamps, electrical drills, ghosting of the image and lost or weak receiving signals.

NOTE:

- The TV set can generate sound distortion in external devices such as a radio. Please separate radio equipment from the TV set to a considerable distance.

Troubleshooting

Use the following checklist for troubleshooting if you have problems with your TV. Consult your local dealer or service outlet if problems persist. Be sure all connections are properly made when using with other units.

| SYMPTOMS | POSSIBLE SOLUTIONS |
|----------------------------------|---|
| TV does not operate. | <ul style="list-style-type: none"> • Make sure the power cord is plugged in. • Try another AC outlet. • Power is off, check fuse or circuit breaker. • Unplug unit for an hour, then plug it back in. |
| Poor sound or no sound. | <ul style="list-style-type: none"> • Station or Cable TV experiencing problems, tune to another station. • Check sound adjustments (Volume or Mute). • Check for sources of possible interference. • Check for audio language setting. |
| Poor picture or no picture. | <ul style="list-style-type: none"> • Station or Cable TV experiencing problems, tune to another station. • Make sure channels are set into memory. • Check antenna or Cable TV connections, adjust antenna. • Check for sources of possible interference. • Check picture control adjustments. |
| Poor reception on some channels. | <ul style="list-style-type: none"> • Station or Cable TV experiencing problems, tune to another station. • Make sure channels are set into memory. • Station is weak, adjust antenna to receive desired station. • Check for sources of possible interference. |
| Poor color or no color. | <ul style="list-style-type: none"> • Station or Cable TV experiencing problems, tune to another station. • Make sure channels are set into memory. • Check picture control adjustments. • Check antenna or Cable TV connections, adjust antenna. • Check for sources of possible interference. |
| Picture wobbles or drifts. | <ul style="list-style-type: none"> • Station or Cable TV experiencing problems, tune to another station. • Make sure channels are set into memory. • Cable TV company is scrambling signal. • Adjust antenna. |

| SYMPTOMS | POSSIBLE SOLUTIONS |
|--|---|
| Digital broadcasting screen problem. | <ul style="list-style-type: none"> • Check digital signal strength. |
| No CATV reception. | <ul style="list-style-type: none"> • Check all Cable TV connections. • Set Source menu option to the Cable mode. • Station or Cable TV system problems, try another station. |
| Horizontal or diagonal bars on screen. | <ul style="list-style-type: none"> • Check antenna connections, adjust or re-direct antenna. • Check for sources of possible interference. |
| No reception above channel 13. | <ul style="list-style-type: none"> • Make sure the appropriate Source (Air or Cable) has been selected. • If using antenna, check UHF antenna connections. |
| No Remote operation. | <ul style="list-style-type: none"> • Batteries are weak, dead or inserted incorrectly. • Remote is out of range, move closer to TV (within 15 feet). • Make sure Remote is aimed at sensor. • Confirm there are no obstructions between the Remote and the TV. • Make sure the power cord is plugged in. |
| TV shuts off. | <ul style="list-style-type: none"> • Sleep Timer is set. • Power interrupted. |
| Closed Caption is not activated. | <ul style="list-style-type: none"> • TV station experiencing problems or program tuned is not closed captioned. Try another channel. • Check Cable TV connection or VHF/UHF antenna, reposition or rotate antenna. • Set Closed Caption Decoder in the menu. |
| TV is not shown in your language. | <ul style="list-style-type: none"> • Select proper language in the menu options. |

If the problem cannot be solved with the suggested procedures, contact 800.HITACHI (800.448.2244).

For your safety, never try to repair the product yourself.

Specifications

| | |
|-----------------------|--|
| Model | 49E30 / 49E301 / 49E30A |
| Panel size | 49" class / 48.50" Diagonal (1232.0 mm) |
| Display method | Transmission TFT color LCD panel |
| Number of Pixels | 1920 (H) × 1080 (V) |
| Broadcasting system | US system M ATSC standard (8VSB), QAM |
| Receiving channels | VHF 2-13 UHF 14-69 CATV 14-36 (A)-(W) 37-59 (AA)-(WW) 60-85 (AAA)-(ZZZ) 86-94 (86)-(94) 95-99 (A-5)-(A-1) 100-135 (100)-(135) 01 (4A) |
| Tuner type | Frequency synthesized |
| Inputs | Video: 1.0 V (p-p), 75 ohms Audio: 2Vrms Max. HDMI: HDMI compliant (type A connector) HDCP compliant E-EDID compliant Suggested scan rates: 480i, 480p, 720p, 1080i, 1080p HDMI Audio: 2-channel PCM 32/44.1/48 kHz sampling frequency 16/20/24 bits per sample Antenna: VHF/UHF In 75 ohms coaxial |
| Outputs | Audio: 0.2 V (p-p), 75 ohms terminated Digital audio: Optical |
| Speakers | Integrated speakers (Bottom side) |
| Audio output power | 8.0W + 8.0W (THD 10%) |
| Power supply | AC 120V, 60Hz |
| Power consumption | Operation: 120W Standby: ≤0.5W |
| Weight | 24.3 lbs (11.0kg) |
| Dimensions | Width: 43 11/16" (1108.4mm) Height: 27 3/16" (690.4mm) Depth: 8 5/8" (218.7 mm) |
| Operating temperature | 5°C - 40°C |
| Operating humidity | Less than 80% RH |
| Accessories | Remote control Batteries (AAA) × 2 Stand x 2 (R, L), Stand Screws x 4 Owner's Guide Quick Start Guide |

- Designs and specifications are subject to change without notice.
- For information on our other products, please visit our website at www.hitachi.us

800.HITACHI
(800.448.2244)

Monday ~ Friday
9:00 am - 6:00 pm EST

www.hitachi.us/tv



Sincere - Prompt - Efficient

HITACHI
Inspire the Next

HITACHI AMERICA, LTD., DIGITAL MEDIA DIVISION

HITACHI has made every effort to assure you enjoy trouble free operation from your Hitachi product. Should you require service assistance with **OPERATIONAL, HOOK UP, TECHNICAL ASSISTANCE OR WARRANTY SERVICE SUPPORT**, please contact one of our knowledgeable Customer Service Advocates at **800.HITACHI (800.448.2244)**.

Please be prepared to submit proof of purchase and/or delivery receipts to your 800.HITACHI Customer Service Representative. Warranty coverage will be provided in accordance with the provisions of your Limited Warranty (see the Limited Warranty page in this operating guide).

Pour de plus amples renseignements sur le service durant la période couverte par la garantie, sur le fonctionnement ou pour de l'assistance technique communiquez avec:

Au Canada: 800.HITACHI (800.448.2244)

Lundi ~ Vendredi 9:00 am - 6:00 pm HNE

Hitachi America, Ltd., Digital Media Division
Customer Service Support
P.O. Box 99652
Troy, MI 48099

customerservice.ce@hal.hitachi.com

HITACHI

Inspire the Next

Congratulations on your purchase of a new Hitachi display product!

LIMITED WARRANTY:

Hitachi America, Ltd. warrants this Hitachi display product (the "Product") in accordance with the following terms and conditions:

Limited Parts and Labor Warranty: The Product is warranted to be free from defects in materials and workmanship beginning on the date of purchase by the original end user purchaser (the "Purchaser") and continuing for the duration of the applicable time periods specified below. If the Product is found to be defective, Hitachi will repair or replace (at Hitachi's option) defective parts at no charge, subject to the conditions of this Limited Warranty. If the Purchaser rejects, refuses or otherwise does not accept Hitachi's offer to repair or replace such defective parts under this Limited Warranty, this Limited Warranty shall be void and of no further force or effect. This Limited Warranty extends to the Purchaser only and is not transferable, and such Purchaser must provide a dated sales receipt his or her evidencing the purchase of the Product to qualify for parts or service under this Limited Warranty. The original owner must notify Hitachi of a defect claim by calling 800-HITACHI during the applicable Limited Warranty period for this Limited Warranty to be effective. This Limited Warranty is valid only in the U.S.A., Canada and Puerto Rico.

PARTS: The Limited Warranty period for parts is 1 year from the date of original purchase. During the Limited Warranty period for parts, Hitachi will replace defective parts with new or rebuilt parts (at Hitachi's option) at no charge for such parts. Any replacement part will be warranted for the remainder of the original warranty period applicable to the part replaced. **LABOR:** The Limited Warranty period for labor is 1 year from the date of original purchase. During the Limited Warranty period for labor, Hitachi will repair or replace (at Hitachi's option) defective parts without charge for labor. **SERVICE LOCATION:** In-home warranty service, which includes either in-home repair or free pick-up and delivery (at Hitachi's option), applies to all Hitachi products except: (i) 43-inch and smaller LCD Flat Panel Televisions; (ii) Products located outside the U.S.A., Canada or Puerto Rico; and (iii) Products located more than seventy-five (75) driving miles from Hitachi's nearest Authorized Service Facility. If the foregoing clauses (i), (ii), or (iii) apply, then the Purchaser will be responsible for bringing/delivering the Product to a Hitachi Authorized Service Facility and, following warranty service, retrieving the Product from such Authorized Service Facility.

IMPORTANT: Before using or installing your Product, please complete this form and attach your sales receipt and retain them for your records. This will help facilitate proper warranty coverage.

MODEL NO.:

SERIAL NO.:

DEALER NAME:

DATE OF PURCHASE:

DEALER ADDRESS:

CITY:

STATE / PROVINCE:

WARRANTY LIMITATIONS. This Hitachi Limited Warranty DOES NOT COVER: A. Any Product that has been modified or repaired in a manner not previously authorized by Hitachi in writing. B. Any Product, whose serial number has been removed, altered, replaced, defaced or rendered illegible. C. Any defect, malfunction, or failure caused by or resulting from improper or unauthorized service, maintenance or repair. D. Damage resulting from abuse, misuse, mishandling, neglect or damage caused by exposure to hostile operating environments such as areas containing dust and/ or smoke. E. Damage caused by power surges, accidents, natural disasters or any other events or circumstances outside Hitachi's control. F. Any Product used in any manner inconsistent with the acceptable set-up, usage, safety or installation configurations identified in the Product's Operating Guide. G. Any Product used for purposes or applications, or subjected to operating conditions, other than those identified as acceptable in the Product's Operating Guide. H. Product repairs (including any product whose case has been opened), or part replacements provided or installed, by any person other than an Authorized Hitachi Service Facility Representative. I. Improper uncrating, set-up or installation or any mis-adjustments caused by user-operated controls. J. Any labor or costs associated with removing the Product from a custom cabinet or other specialized product installation that impedes direct and immediate removal of the Product from the owner's premises (must be arranged and paid by the owner). K. Product cabinets, cabinet parts, knobs, batteries, accessories, or any third party's branded hardware or peripheral devices, including any software incorporated therein, whether or not included within the Product's original packaging. L. Product screens that have been cleaned by any method other than as specified in the Product's Operating Guide. M. Normal usage, degraded brightness caused by backlight aging and/or cell defects or ordinary wear and tear, including, without limitation, scratches or marks on the Product's screen, cabinet or the appearance of bright or dark screen pixels. N. Any Product returned for service that is damaged due to improper packaging, mishandling or shipping. (IMPORTANT: When shipping any Product to a Hitachi Authorized Service Facility, Product owner must package it securely in the original shipping container or its equivalent to prevent damage. The Product must be returned with the shipping charges prepaid and proof of purchases included in the shipping container. Failure to properly package such product during such shipment will void all warranties.) O. Any Product purchased or serviced outside the U.S.A., Canada and Puerto Rico. P. Any Product that has been used for commercial purposes.

NO PERSON, AGENT, DISTRIBUTOR, DEALER, SERVICE FACILITY, OR COMPANY IS AUTHORIZED TO CHANGE, MODIFY OR AMEND THE TERMS OF THIS LIMITED WARRANTY IN ANY MANNER WHATSOEVER. EXCEPT AS PROVIDED IN THIS LIMITED WARRANTY, HITACHI MAKES NO EXPRESS WARRANTY REGARDING THIS HITACHI PRODUCT. FURTHER, ALL IMPLIED WARRANTIES RELATING TO ANY PORTION OF THIS PRODUCT, INCLUDING ANY IMPLIED WARRANTY OF MERCHANTABILITY OR FITNESS FOR A PARTICULAR PURPOSE, ARE HEREBY EXPRESSLY DISCLAIMED BY HITACHI TO THE MAXIMUM EXTENT PERMITTED BY APPLICABLE LAW. HITACHI SHALL NOT BE LIABLE TO THE PURCHASER OR TO ANY OTHER PERSON FOR ANY INCIDENTAL OR CONSEQUENTIAL DAMAGES OR LOSS OF PROFIT OR PRODUCT RESULTING FROM ANY DEFECT IN, OR MALFUNCTION OR FAILURE OF, THIS HITACHI PRODUCT. BECAUSE SOME JURISDICTIONS DO NOT ALLOW LIMITATIONS OR EXCLUSIONS OF CERTAIN IMPLIED WARRANTIES, OR THE EXCLUSION OF INCIDENTAL OR CONSEQUENTIAL DAMAGES, THE ABOVE LIMITATIONS MAY NOT APPLY TO YOU. THIS LIMITED WARRANTY CONFERS SPECIFIC LEGAL RIGHTS, INCLUDING CERTAIN OTHER RIGHTS THAT MAY VARY DEPENDING ON YOUR JURISDICTION. THIS LIMITED WARRANTY SHALL BE GOVERNED BY AND CONSTRUED IN ACCORDANCE WITH THE LAWS OF THE JURISDICTION OF THE PRODUCT OWNER'S RESIDENCE.

