

HITACHI

Inspire the Next



Audio Video Center

This Audio Video Center is intended to be use with Hitachi Ultra Thin monitors that includes remote controls. This AVC08U does not include a remote control.

- Audio Video Center with ATSC/NTSC/QAM tuning.
- Selectable Upscaling to 1080i/1080p High Definition Output (HDMI).
- (3) HDMI™ (V.1.3a with CEC) Input, (2) Composite Video Inputs, (2) Component Video Inputs.

Operating Guide

Model Name
AVC08U

READ THE ENCLOSED INSTRUCTIONS CAREFULLY.
KEEP THIS OPERATING GUIDE FOR FUTURE REFERENCE.
Record the serial number of your A/V Center for future reference.
SERIAL NO. _____

This serial number is located on the bottom side of the unit

ANY QUESTION ABOUT THIS PRODUCT PLEASE CONTACT 800-HITACHI



CONTENTS

IMPORTANT SAFETY INSTRUCTIONS	02
INTRODUCTION	04
About This Manual.....	04
Trademark Credits.....	04
Software.....	04
Features.....	04
SAFETY PRECAUTIONS	05
Explanation of the Symbols.....	05
Cleaning and Maintenance.....	08
QUICK START GUIDE	09
1. Supplied Accessories	09
2. Connect your A/V Center to the UT Monitor	09
3. Antenna Connection.....	10
4. Power On.....	10
COMPONENT NAMES	11
Main Unit.....	11
Remote Control.....	12
PREPARATION	13
Remote Control Battery Installation.....	13
Handling the Remote Control	13
Main Unit Installation	13
CONNECTION	14
1. Connect your Equipment to the A/V Center.....	14
Connecting to Equipment Having HDMI or DVI Output Terminals	14
Connecting to Equipment Having YPbPr Components Output Terminals.....	15
Connecting to Equipment Having Video Output Terminals.....	15
Connecting to Equipment Having an Audio Digital Input Terminal	16
2. Connect your A/V Center to the UT Monitor	16
3. Connect the Power Plug into the Wall Socket	17
BASIC OPERATION	18
Power On/Off.....	18
Volume Up/Down.....	19
Mute.....	19
Channel Selector/Favorite Channel.....	19
Input Switching	20
Input Signal Screen Display.....	20
SETUP OPERATION	21
How to Use the Remote to Control your External Devices	21
Remote Control Codes	25

How to Use the On-Screen Display (OSD) System...	27
Select Language.....	27
ON-SCREEN DISPLAY	28
Main Menu List	28
Audio/Video.....	29
Channel Manager.....	30
Locks	31
Timers	34
Setup.....	35
TROUBLESHOOTING	37
About LCD Display Technology	37
When the Following Messages Appear on the Screen	37
Symptom and Checklist.....	37
PRODUCT SPECIFICATIONS	39
Dimensions.....	39
Signal Input.....	40
Recommended Signal List.....	40
SERVICE INFORMATION	41
LIMITED WARRANTY	42
END USER LICENSE AGREEMENT	43

IMPORTANT SAFETY INSTRUCTIONS

SAFETY POINTS YOU SHOULD KNOW ABOUT YOUR HITACHI AUDIO VIDEO CENTER

Our reputation has been built on the quality, performance, and ease of service of Hitachi products.

Safety is also foremost in our minds in the design of these units. To help you operate these products properly, this section illustrates safety tips which will be of benefit to you. Please read it carefully and apply the knowledge you obtain from it to the proper operation of your Hitachi Audio Video Center.

Please fill out your warranty card and mail it to Hitachi. This will enable Hitachi to notify you promptly in the improbable event that a safety problem should be discovered in your product model. Model and serial numbers are indicated underneath the product.

CAUTION

RISK OF ELECTRIC SHOCK

DO NOT OPEN

CAUTION: TO REDUCE THE RISK OF ELECTRIC SHOCK, DO NOT REMOVE COVER (OR BACK). NO USER SERVICEABLE PARTS INSIDE. REFER SERVICING TO QUALIFIED SERVICE PERSONNEL.



The lightning flash with arrowhead symbol, within an equilateral triangle, is intended to alert the user to the presence of uninsulated "dangerous voltage" within the product's enclosure that may be of a sufficient magnitude to constitute a risk of electric shock to a person.



The exclamation point within an equilateral triangle, is intended to alert the user to the presence of important operating and maintenance (servicing) instructions in the literature accompanying the appliance.

READ BEFORE OPERATING EQUIPMENT

Follow all warnings and instructions marked on this Audio Video Center.

1. Read these instructions.
2. Keep these instructions.
3. Heed all warnings.
4. Follow all instructions.
5. Do not use this apparatus near water.
6. Clean only with a dry cloth.
7. Do not block any ventilation openings. Install in accordance with the manufacturer's instructions.
8. Do not install near any heat sources such as radiators, heat registers, stoves, or other apparatus (including amplifiers) that produce heat.
9. Do not defeat the safety purpose of the polarized or grounding-type plug. A polarized plug has two blades with one wider than the other. A grounding type plug has two blades and a third grounding prong. The wide blade or the third prong are provided for your safety. If the provided plug does not fit into your outlet, consult an electrician for replacement of the obsolete outlet.
10. Protect the power cord from being walked on or pinched particularly at plugs, convenience receptacles, and the point where they exit from the apparatus.
11. Only use the attachments/accessories specified by the manufacturer.
12. Use only with the cart, stand, tripod, bracket, or table specified by the manufacturer, or sold with the apparatus. When a cart is used, use caution when moving the cart/apparatus combination to avoid injury from tip-over.
13. Unplug this apparatus during lightning storms or when unused for long periods of time.
14. Refer all servicing to qualified service personnel. Servicing is required when the apparatus has been damaged in any way, such as power-supply cord or plug is damaged, liquid has been spilled or objects have fallen into the apparatus, the apparatus has been exposed to rain or moisture, does not operate normally, or has been dropped.



15. Monitors, Televisions and Audio Video Centers are designed to comply with the recommended safety standards for tilt and stability. Do not apply excessive pulling force to the front, or top, of the cabinet which could cause the product to overturn resulting in product damage and/or personal injury.
16. Follow instructions for wall, shelf or ceiling mounting as recommended by the manufacturer.
17. An outdoor antenna should not be located in the vicinity of overhead power lines or other electrical circuits.
18. If an outside antenna is connected to the A/V Center and the monitor be sure the antenna system is grounded so as to provide some protection against voltage surges and built up static charges. Section 810 of the National Electric Code, ANSI/NFPA No. 70-1984, provides information with respect to proper grounding for the mast and supporting structure, grounding of the lead-in wire to an antenna discharge unit, size of grounding connectors, location of antenna discharge unit, connection to grounding electrodes and requirements for the grounding electrode.

NOTE

To the CATV system installer: This reminder is provided to call the CATV system installer's attention to Article 820-44 of the NEC that provides guidelines for proper grounding and, in particular, specifies that the cable ground shall be connected to the grounding system of the building, as close to the point of cable entry as practical.

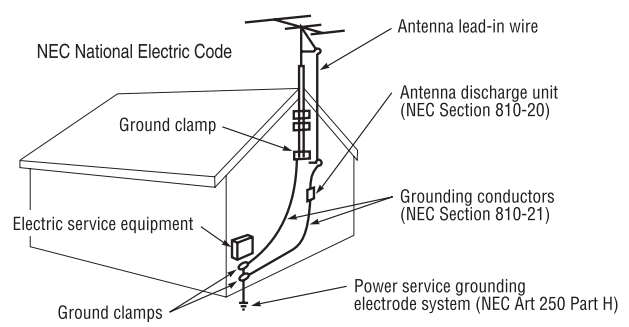

IMPORTANT SAFETY INSTRUCTIONS (continued)

Warning



- To reduce the risk of fire or electric shock, do not expose this apparatus to rain or moisture.
- The A/V Center should not be exposed to dripping or splashing and objects filled with liquids, such as vases, should not be placed on the A/V Center.
- The mains plug is used as the disconnect device and shall remain readily operable.

If problems occur during installation or operation of the product, before calling for technical support or service technicians, please read "TROUBLESHOOTING" (37 ~ 38) to determine the symptoms.

If serious problems occur (such as smoke or an abnormal odor from the unit), turn off the main power, unplug the power cord, and then, contact 800-HITACHI immediately.

Lead Notice

This product contains lead. Dispose of this product in accordance with applicable environmental laws. For product recycling and disposal information, contact your local government agency or www.eRecycle.org (in California), the Electronic Industries Alliance at www.eiae.org (in the US) or the Electronic Product Stewardship Canada at www.epsc.ca (in Canada). **FOR MORE INFORMATION, CALL 800-HITACHI.**

FEDERAL COMMUNICATIONS COMMISSION NOTICE

This equipment has been tested and found to comply with the limits for a Class B digital device, pursuant to Part 15 of the FCC Rules. These limits are designed to provide reasonable protection against harmful interference in a residential installation. This equipment generates, uses and can radiate radio frequency energy and if not installed and used in accordance with the instructions, may cause harmful interference to radio communications. However, there is no guarantee that interference will not occur in a particular installation. If this equipment does cause harmful interference to radio or television reception, which can be determined by turning the equipment off and on, the user is encouraged to try to correct the interference by one or more of the following measures:

- If the Audio Video Center is connected with a Monitor or TV Receiver, reorient or relocate the receiving antenna.
- Increase the separation between the equipment and the receiver.
- Connect the equipment into an outlet on a circuit different from that to which the receiver is connected.
- Consult the dealer or an experienced radio/television technician for help.

This device complies with FCC Rules. Operation is subject to the following two conditions :

(1) This device may not cause harmful interference and (2) This device must accept any interference received, including interference that may cause undesired operation.

Modifications

The FCC requires the user to be notified that any changes or modifications made to this device that are not expressly approved by Hitachi Home Electronics (America), Inc. may void the user's authority to operate the equipment.



Cables

Connections to this device must be made with shielded cables with metallic RFI/EMI connector hoods to maintain compliance with FCC Rules and Regulations. Any cables that are supplied with the system must be replaced with identical cables in order to assure compliance with FCC rules. Order Hitachi spares as replacement cables.

INDUSTRY CANADA AGENCY REGULATORY INFORMATION

Cable Compatible Television Apparatus- Télévision câblcompatible, Canada.

Notes on Closed Captions

This A/V Center will display television closed captioning, ( or ), in accordance with paragraph 15.119 and 15.122 of the FCC rules.

INTRODUCTION

Thank you for purchasing the Hitachi Audio Video Center. We hope that you will enjoy the outstanding performance of this product.

This Audio Video Center has been designed to comply with international standards. However, it could cause personal injury and property damage if improperly handled. In order to prevent potential danger and obtain maximum benefit from your set, please read this operating guide carefully before operating this product and observe the following instructions when installing, operating, and cleaning the product. To ensure proper operation, please read and follow ALL the instructions, especially the "IMPORTANT SAFETY INSTRUCTIONS" and "SAFETY PRECAUTIONS".

Keep this manual for future reference and record the serial number of your set in the space provided on the front cover page of this manual.

About This Manual

- The information in this manual is subject to change without notice.
- This manual has been produced with the utmost care. If you have any comments or questions regarding this manual, please contact your local dealer or our Customer Service Center.
- Before operating the set, please fully understand the prerequisites such as specifications or constraints for the hardware and software. Hitachi is not responsible and accept no liability for any loss, damage or injury as a result of misuse.
- Reproduction, copying, utilization, modification and/or transmission in whole or in part of this manual are prohibited except by prior written consent.
- All other products and company names used in this manual are trademarks or registered trademarks of their respective owners.

Trademark Credits

- VESA is a registered trademark of the Video Electronics Standard Association.
- **HDMI** HIGH-DEFINITION MULTIMEDIA INTERFACE HDMI, the HDMI logo and High-Definition Multimedia Interface are trademarks or registered trademarks of HDMI Licensing LLC.
- **DOLBY** DIGITAL Manufactured under license from Dolby Laboratories. "Dolby" and the double-D symbol are trademarks of Dolby Laboratories.

Even if no special note has been made of company or product trademarks, these trademarks have been fully respected.

Software

It is illegal for you to alter, decompile, disassemble, decrypt, or otherwise reverse-engineer the software installed in this product.

Features



- Audio Video Center with ATSC/NTSC/8VSB/QAM Tuning
- Upscaling to 1080i / 1080p High Definition Output
 - Provides superior uncompressed digital video and audio quality in a simple, user-friendly HDMI connector.
 - HDMI (V.1.3a, Supporting Deep Color, x.v.Color™, Auto Lip Sync, CEC with HDCP Copy Protection.)
- Dolby Digital Optical output
- User-friendly on screen control
- Terrestrial Cable, Analog and Digital Tuner
- 3-language On-Screen Display (English, French, and Spanish)
- Parental Locks (Downloadable V-Chip)
- Closed Caption Decoder
- Memory by Input
- Discrete IR Codes
- Sleep Timer



SAFETY PRECAUTIONS





For your safety, please read the following precautions carefully before using this product. Improper use would cause serious personal injury and/or damage to your property or the product.

Explanation of the Symbols

The following are the symbols used in this manual and affixed to the unit itself. Please fully understand the meanings of the symbols before reading the instructions in this section.

 WARNING	Never ignore the instruction. There are risks of serious or fatal injury to the user.
 CAUTION	Do not ignore the instruction. There are risks of personal injury and/or property damage.

Other Symbols	
	The triangle with illustration is intended to alert the users that there are risks of fire, explosion, or high temperature if the product is handled improperly. Each illustration within the triangle specifies the contents in detail. (The figure on the left is an example.)
	The circle with diagonal line and illustration indicates a prohibited action (the symbol to the left indicates that dismantling is prohibited).
	This symbol indicates a compulsory action. The contents are clearly indicated in or adjacent to an illustration (the symbol to the left indicates that the power plug should be disconnected from the power outlet).

 WARNING	
There is a risk of fire, electric shock, or serious injury.	
<p>■ If serious problems occur, unplug the power cord immediately.</p> <p>Serious problems such as:</p> <ul style="list-style-type: none"> • Smoke, abnormal odor or noise emitted from the product. • No picture, no sound or distorted picture on the display. • Foreign matter (such as water, metals etc.) entered the unit. <p>Do not continue using the product under these abnormal conditions. Turn off the main power, unplug the power cord, and contact 800-HITACHI immediately.</p> <p>For your safety, never try to repair the product yourself.</p>	 Disconnect the plug from the power outlet.
<p>■ Do not allow liquids or any foreign matter (such as metals or flammable items) to enter the unit.</p> <ul style="list-style-type: none"> • If this does occur, turn off the main power, unplug the power cord, and contact 800-HITACHI immediately. • Exercise special caution when young children are around the unit. 	
<p>■ Do not remove covers, or modify the product.</p> <ul style="list-style-type: none"> • High-voltage components are installed inside of the unit. Removing covers can expose you to high-voltage electric shock, and other hazardous conditions. • Contact 800-HITACHI to perform servicing such as inspection, adjustment or repair work. 	  Do not dismantle.

SAFETY PRECAUTIONS (continued)

WARNING

There is a risk of fire, electric shock or serious injury.

■ **Install the unit in a proper location where it does not expose anyone to danger.**

- If you bump against the edges of the unit, you could be injured.



■ **Do not rest weight on top of the unit.**

Objects such as

- Liquid containers (vase, fish tank, flowerpot, cosmetics or liquid medicine).
- If water or any liquid spills onto the unit, it may cause short-circuiting and result in fire or electric shock. If this occurs, turn off the main power, unplug the power cord, and contact **800-HITACHI** immediately.
- Do not rest anything heavy on top of the unit.
- Do not climb on or hang from the unit.
- Do not allow your pets to get on top of the unit



■ **Do not install the unit in an unsuitable location.**

- This could cause a malfunction or in extreme cases danger of electric shock. Locations where high moisture is likely, such as bathrooms or shower rooms, close to windows, or outside where rain, snow or other inclement conditions could occur, should be avoided. Please also avoid installing the unit in a location where fumes from hot springs could come into contact with it.



■ **Unplug the unit in the event of a lightning storm.**

- To reduce the risk of electric shock, do not touch the product when lightning occurs.



Disconnect the plug from the power outlet.

■ **Do not do anything that may damage the power cord.**

- Do not damage, modify, twist, forcibly bend, heat, or pull excessively on the power cord.
- Do not place heavy objects (including the unit itself) on top of the power cord.
- If the power cord is damaged, contact **800-HITACHI** for repairs or exchange.



■ **Use only with designated power supply voltage.**

- To prevent the risk of fire and electric shock, operate the product only with the power supply voltage indicated on the unit.



■ **Be careful not to drop or allow any impact to affect the unit.**

- Take extra care while moving the unit.
- In the event that you drop the unit or the cabinet is damaged, turn off the main power, unplug the power cord and contact **800-HITACHI** immediately.
- Continuing use of the product under the above conditions may cause fire or electric shock.



■ **Clean dust or metals from on or around the pins of the power plug regularly.**

- Continuing use of the product under the above conditions may cause fire or electric shock.
- Always unplug the power cord first, then clean the pins using a dry cloth.



■ **Do not place the unit on an unstable surface.**











Unstable surfaces such as:

- Tilted surface or shaky shelving, table, stand or trolley.
- If the unit falls down, this could cause personal injury.



SAFETY PRECAUTIONS (continued)

CAUTION

<p>■ Do not place or use the unit in a dusty location.</p> <ul style="list-style-type: none"> • This could cause a malfunction. 	
<p>■ Do not cover or block any ventilation holes on the product.</p> <p>The unit would overheat and this could cause fire or damage to the product which may shorten its service lifetime.</p> <ul style="list-style-type: none"> • Install the product in accordance with the instructions in this manual. • Do not place the unit with the ventilation side downward. • Do not install the unit on carpeting or bedding. • Do not cover the unit with table cloths etc. 	
<p>■ Observe the anti-tumble measures described in this manual.</p> <ul style="list-style-type: none"> • If the unit tumbles over, there is a risk of personal, possibly fatal injury. Also, this would damage the product seriously. 	
<p>■ Do not install the unit near medical devices.</p> <ul style="list-style-type: none"> • To prevent malfunction of medical devices, do not use the product and medical devices in the same room. 	
<p>■ Disconnect all of the external connection cables and detach the anti-tumble measures before moving the unit.</p> <ul style="list-style-type: none"> • Otherwise fire, electric shock or personal injury may result. 	
<p>■ Connect the power plug securely.</p> <ul style="list-style-type: none"> • Improper connection will cause overheating and may result in fire. • Do not touch the pins of the plug while connecting it to the wall socket. This could cause electric shock. • If the plug is not suitable for the wall socket, contact your dealer for replacement. 	 
<p>■ Do not handle the power cord with wet hands.</p> <ul style="list-style-type: none"> • This could result in electric shock. 	
<p>■ Do not pull the cord when you unplug the power cord.</p> <ul style="list-style-type: none"> • This may damage the cord and could result in fire or electric shock. • Grip the plug when disconnecting it. 	
<p>■ Unplug the power cord when you do not intend to use the product for long periods of time.</p>	
<p>■ Handle the batteries properly.</p> <ul style="list-style-type: none"> • Improper or incorrect use of the batteries may cause corrosion or battery leakage, which could cause fire, personal injury or damage to property. • Use only the types of batteries which are indicated in this manual. • Do not replace batteries with used ones. • Install the batteries correctly by observing the polarity (+ and -) indications on the battery compartment. • Do not dispose of used batteries as domestic waste. Dispose of them in accordance with the local regulations. 	

SAFETY PRECAUTIONS (continued)

CAUTION

■ Do not install the unit in locations where it will be subjected to high temperature.

This could damage the cabinet or components of the product.

- Do not install near any heat sources such as radiators, heating grilles, stoves, or other apparatus that produce heat.
- Keep the unit out of direct sunlight. Otherwise the resulting increase in temperature of the unit may cause a malfunction.



■ Viewing Advice(when using together with UT Monitors)

- The lighting of the environment in which the product is used should be appropriate. Too bright/dark environments are not good for your eyes.
- Take time to relax your eyes occasionally.
- When you use the product, view from a distance equal to 3 to 7 times the height of the screen. This is the best viewing distance in order to protect your eyes against eyestrain. Example: (3X)= approx: 1.5m (4'), (7X)= approx: 3.5m (9').
- Adjust the volume to an appropriate level, especially during night time.

■ Transporting the product

- When the product needs to be transported due to moving or repair, use the carton box and buffer material that came with the product.



■ Keep radios away from the unit while in use.

The unit is designed to meet the international EMI standards to prevent radio interference. However, the unit may generate noise in the radio.

- If noise is heard on the radio, please try the following actions.
 - Adjust the direction of the radio antenna in order not to receive interference from the unit.
 - Keep the radio away from the unit.



■ Infrared communication devices

- Infrared communication devices such as cordless microphones or cordless headphones may not operate properly around the unit. This is because of communication failure. Please note that this is not a malfunction.

■ When you dispose of the product at the end of its service lifetime, follow the regulations in your residential area.

- For more information, contact the local authority or the dealer where you purchased the product.

Cleaning and Maintenance

Please make sure to unplug the power cord before cleaning the unit.

■ How to clean the cabinet of the unit.

- The following may cause cracking, deformation and peeling of paint.
 - Do not wipe the cabinet with benzene, thinners and other chemical products.
 - Do not spray volatile solutions such as insecticide over the cabinet.
 - Do not leave the cabinet in prolonged contact with plastic or rubber materials.
- Do not use a chemical cloth, cleaner or wax. Depending on the ingredients, these may cause cracking and deformation.
- Use a lint-free cloth (e.g. cloth for cleaning glasses) to clean the cabinet and control panel of the unit. In case of the excessive dirt, wipe with a soft cloth moistened with a diluted neutral detergent solution and then wipe with a soft and dry cloth.
- Never use the following detergents. They could cause cracking, discoloration and scratching.
 - Acidic/alkaline detergents, alcoholic detergents, abrasive cleaners, soap powder, OA cleaner, car wax, glass cleaner, etc.

QUICK START GUIDE

For more information on connecting and using your A/V Center, please be sure to read all instructions in this user manual.

1 Supplied Accessories

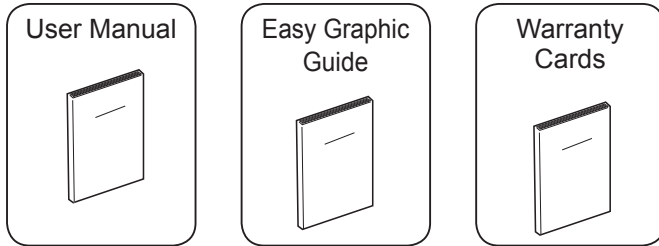

NOTE

The A/V Center is intended to be used with Hitachi LCD UT Monitors that include remote controls. **The A/V Center does not include a remote control.**

2 Connect your Audio Video Center to the UT Monitor

The **A/V Center HDMI output terminal (AV Out)** is connected to the UT Monitor. Only one cable is used to transmit all video/audio/control signals, thus facilitating an easy connection. Moreover, the digital signals can produce high quality data without any degradation.

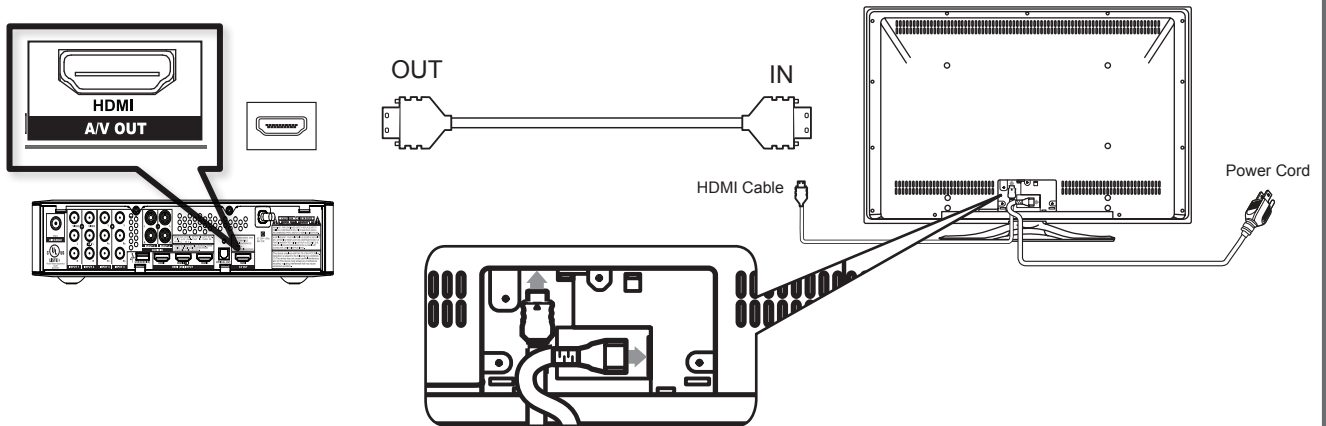

NOTE

Please be sure to insert completely all HDMI cables when connecting to avoid abnormal picture. Remember to attached the UT Monitor supplied cushion around the HDMI cable and secure with clamps to avoid disconnection.

Please refer to the UT Monitor Operating Guide for more details.

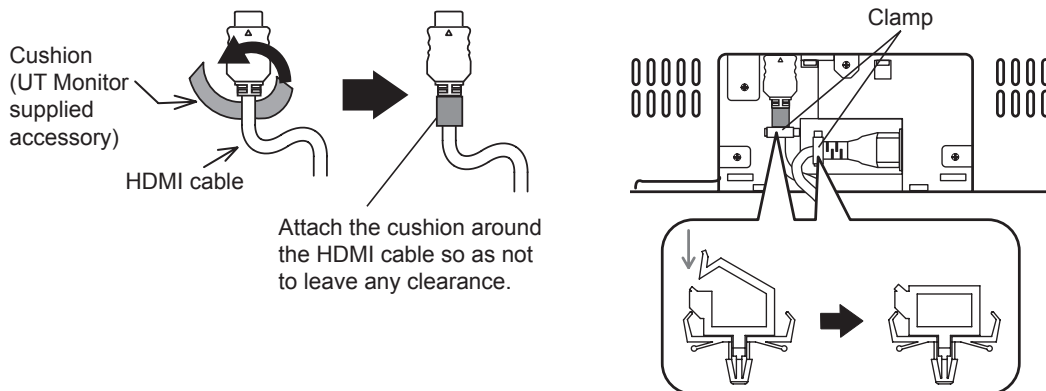

3 Antenna Connection

Unless your A/V Center is connected to a cable TV system or to a centralized antenna system, a good outdoor color TV antenna is recommended for best performance. However, if you are located in an exceptionally good signal area that is free from interference and multiple image ghosts, an indoor antenna may be sufficient.

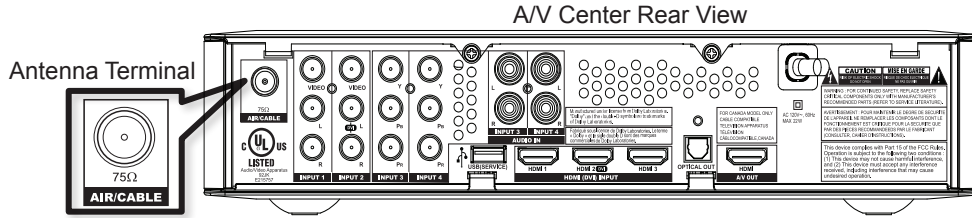

a) VHF (75-Ohm) antenna/CATV (Cable TV)

When using a 75-Ohm coaxial cable system, connect CATV coaxial cable to the AIR/CABLE (75-Ohm) terminal. Or if you have an antenna, connect the coaxial cable to the same AIR/CABLE terminal.



b) VHF (300-Ohm) antenna/UHF antenna

When using a 300-Ohm twin lead from an outdoor antenna, connect the VHF or UHF antenna leads to screws of the VHF or UHF adapter. Plug the adapter into the antenna terminal on the A/V Center.

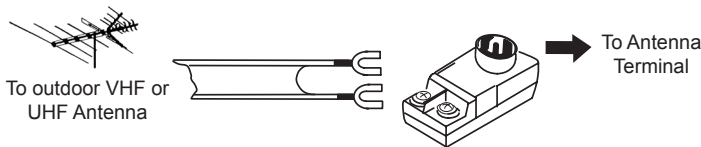

c) When both VHF and UHF antennas are connected

Attach an optional antenna cable mixer to the TV antenna terminal, and connect the cables to the antenna mixer. Consult your dealer or service store for the antenna mixer

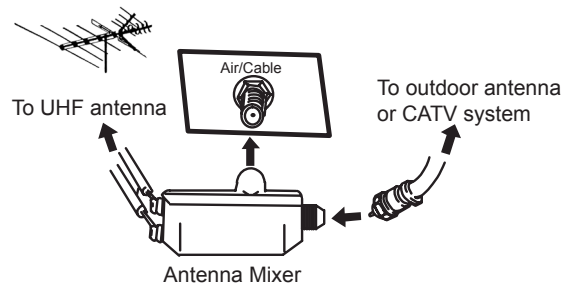

4 Power On...

1) Connect the plug into the wall socket after all other connections are completed.

CAUTION

Ensure that end of the power cord is easily accessible.

2) Hitachi A/V Center is provided with a Power Off/On button on Front Panel and you can Turn it ON by pushing this button, however Hitachi A/V Center is intended to be used with Hitachi UT Monitors ;A/V Center and Monitor are connected by a "HDMI CEC" connection and A/V Center will turn On/ Off following Monitor condition.

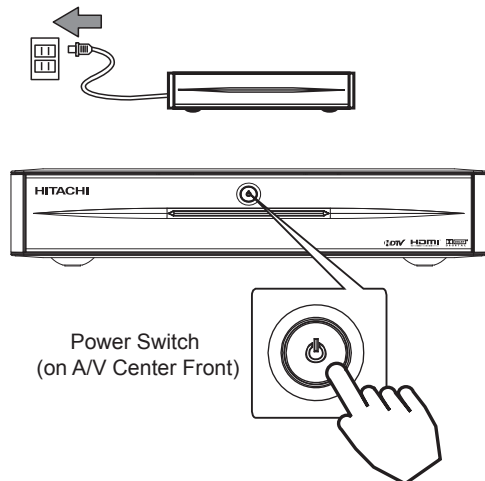

COMPONENT NAMES

Main Unit

Front Panel

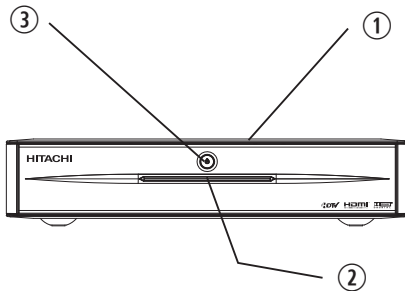

- ① Cabinet
- ② Indicating Lamp
- ③ Power Off/On button

Rear Panel

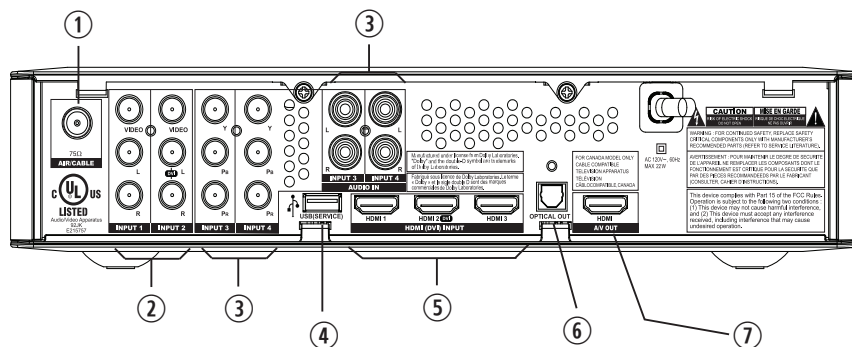

- ① **Antenna Input**
To switch between Cable and Air input, go to the Channel Manager option to change the signal source CABLE or AIR.
- ② **Audio/Video inputs 1 and 2 (Composite)**
INPUT-1 and 2 provide composite Video jacks for connecting equipment with this capability, such as a DVD player, Game Console or Camcorders.
- ③ **Audio/Video inputs 3 and 4 (Y-P_BP_R Components)**
INPUTS 3 and 4 provide Y-P_BP_R and Audio jacks for connecting equipment with this capability, such as a DVD player or Satellite Receiver.
- ⑤ **HDMI Inputs1 and 3, HDMI 2/DVI Input**
Use the HDMI input for your external devices such as Satellite Receiver or DVD players equipped with an HDMI output to assure that pristine high-definition images retain the highest video quality from the source all the way to your monitor screen.

NOTE

- The HDMI input is not intended for use with personal computers.
- Only DTV formats such as 1080p, 1080i, 720p, 480i and 480p are available for HDMI input..

NOTE

- Your component outputs may be labeled Y, B-Y, and R-Y. In this case, connect the components B-Y output to the P_B input and the components R-Y output to the P_R input.
- Your component outputs may be labeled Y-CB_{CR}. In this case, connect the component CB output to the P_B input and the component CR output to the P_R input.
- It may be necessary to adjust TINT to obtain optimum picture quality when using the Y-PBPR inputs .

⑥ **Optical Output**
This jack provides Digital Audio Output for your audio device that is Dolby® Digital and PCM compatible, such as an audio amplifier.

NOTE

- *Manufactured under license from Dolby Laboratories. "Dolby" and the double-D symbol are trademarks of Dolby Laboratories.

- ④ **USB Port(For S/W Upgrade only)**
This slot is for future software upgrades. Hitachi will notify you if a software upgrade is required for your A/V Center. In order to receive written notification, please complete and return your warranty card.
- ⑦ **HDMI Output(To UT Monitor)**
The **A/V Center HDMI output** terminal (AV Out) is connected to the UT Monitor. Only one cable is used to transmit all video/audio/control signals, thus facilitating an easy connection. Moreover, the digital signals can produce high quality data without any degradation.

*Please refer to [14](#)~[16](#) for detailed information regarding the connections.

COMPONENT NAMES (continued)

Remote Control(Included with UT LCD Monitors)

In addition to controlling all of the functions on your Hitachi UT LCD Monitor and A/V Center, the new remote control is designed to operate different types of devices, such as, DVD players, Cable Boxes, Set-Top-Boxes, Satellite Receivers, VCR's, PVR's and AVR's. The remote control must be programmed to control the chosen device. Please refer to pages 21~24 for external device programming setup.

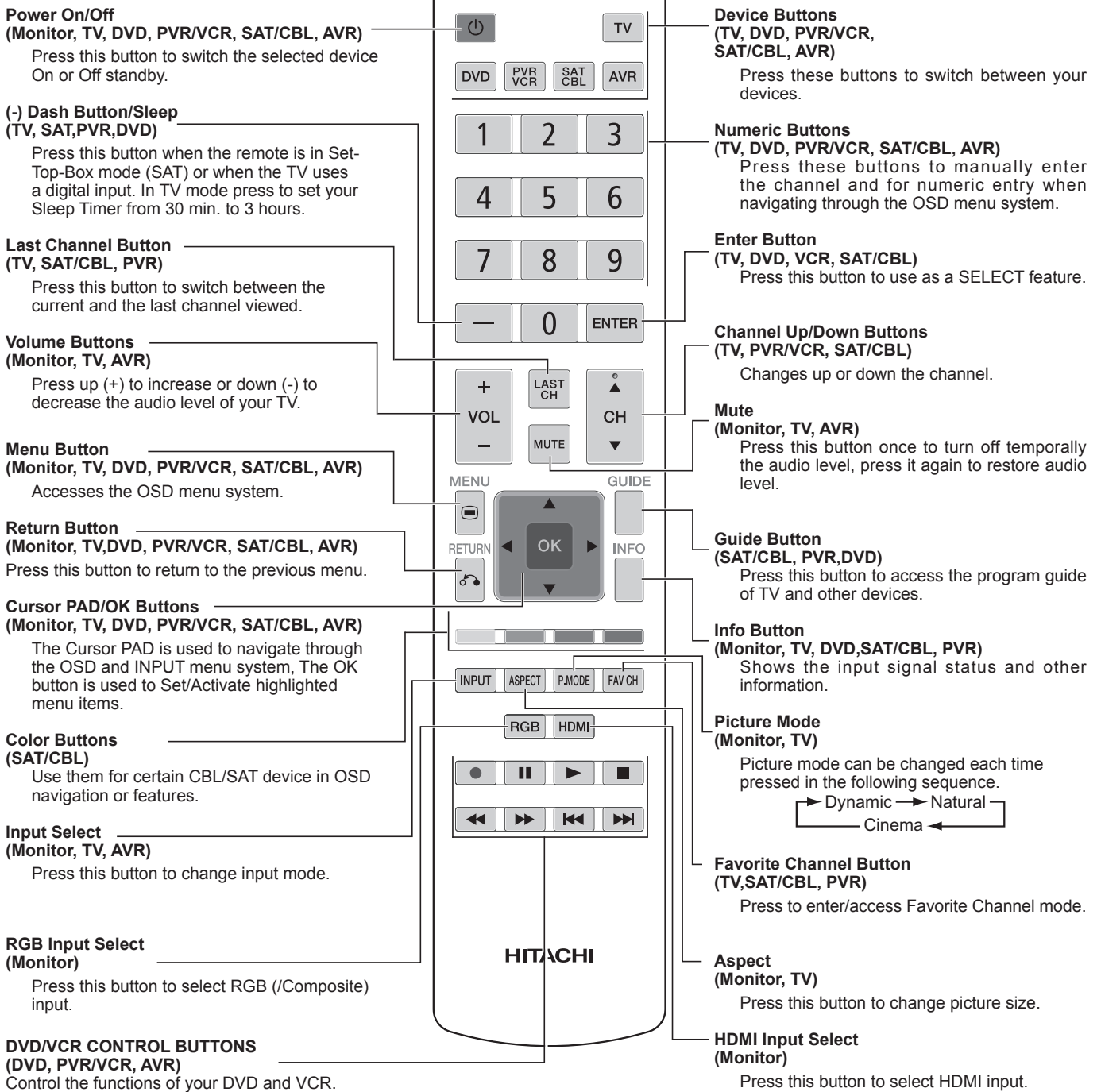

LEGENDS

TV - Television

DVD- Digital Video Disc Player

AVR - Audio/Video Receiver

VCR - Video Cassete Recorder

SAT - Satellite Receiver

PVR - Personal Video Recorder

CBL - Cable Box

NOTE

- Pressing any button will illuminate the backlight for 4 seconds.
- TV Mode is used for LCD Monitor when equipped with Hitachi A/V Center and Monitor is used as a TV.
- For the Record button there is a feature for safety; so this key have to be press twice in order to start recording.

PREPARATION

Remote Control Battery Installation

The remote control operates on 2 "AAA" batteries.

1. Open the battery compartment cover

- Push and pull open the battery compartment cover on the backside in the direction of the arrow, and remove the cover.

2. Install the batteries

- Install 2 "AAA" batteries (included) making sure the polarities match the indication inside the compartment.

3. Close the battery compartment cover

- Make sure the tabs rest in the corresponding holes and push down the compartment cover until it clicks shut.

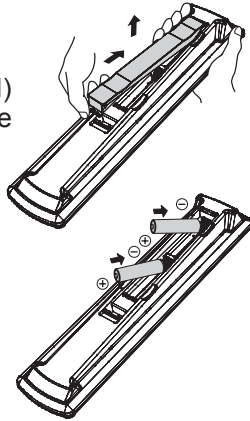

Handling the Remote Control

Use the remote control within a distance of about 5m (16') from the front of the unit's remote control sensor and within an angle of about 30 degrees on both sides.

NOTE Aim the Remote Control to the Monitor IR sensor, Monitor will transmit the commands to the A/V Center through their HDMI connection.

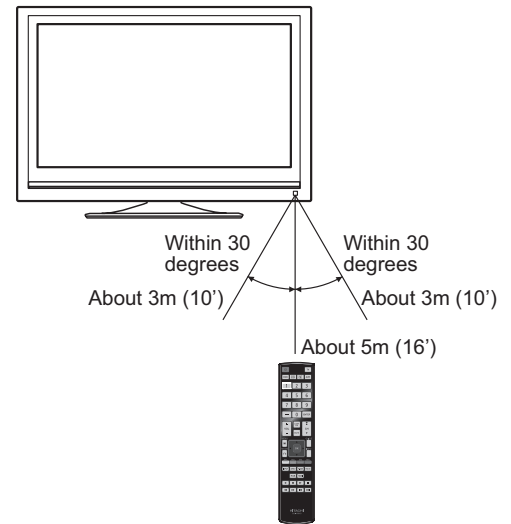

CAUTION

Risk of corrosion or battery leakage. Tampering with batteries may result in physical injury and/or property damage including fire.

- Never mix used and new batteries in the device.
- Replace all the batteries in the device at the same time.
- Remove the batteries if the remote control is not going to be used for an extended period of time.

To avoid possible malfunction, read the following instructions and handle the remote control correctly.

- Do not drop or allow impact to affect the remote control.
- Do not spill water or any liquid on the remote control.
- Do not place the remote control on a wet surface.
- Do not place the remote control under direct sunlight or near sources of excessive heat.

Main Unit Installation

Please leave adequate space around the unit in order to avoid increasing the internal temperature. Make sure not to block any ventilation holes. Do not install the unit in a small space such as inside a cabinet, closet or box without adequate ventilation. Leave at least 10cm (4") of clearance from each side of the unit and from the top of the unit to ceiling.

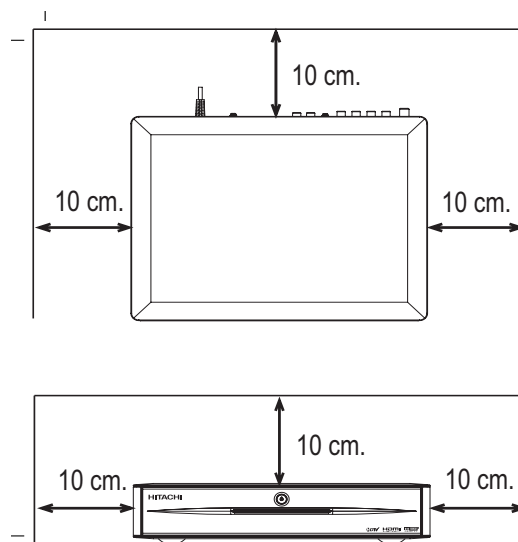

CONNECTION

The unit is suitable for various kinds of connections. Make a connection in the following steps. Be sure to turn off the main power first when connecting external equipment.

1. Connect your Equipment to the Audio Video Center(A/V Center).
2. Connect your A/V Center to the UT Monitor.
3. Connect the A/V Center power plug to the wall socket.

NOTE

Do not connect the power plug to the wall socket until all other connections are completed.

1. Connect your Equipment to the A/V Center

Connecting to Equipment Having HDMI or DVI Output Terminals

The **A/V Center HDMI** Input terminals can be connected to devices with HDMI output. If the external device has a DVI output, this can be connected to the HDMI 2 input terminal using the HDMI-DVI cable. If the HDMI-DVI cable is used, connect the audio signal to the Input 2 Audio terminals.

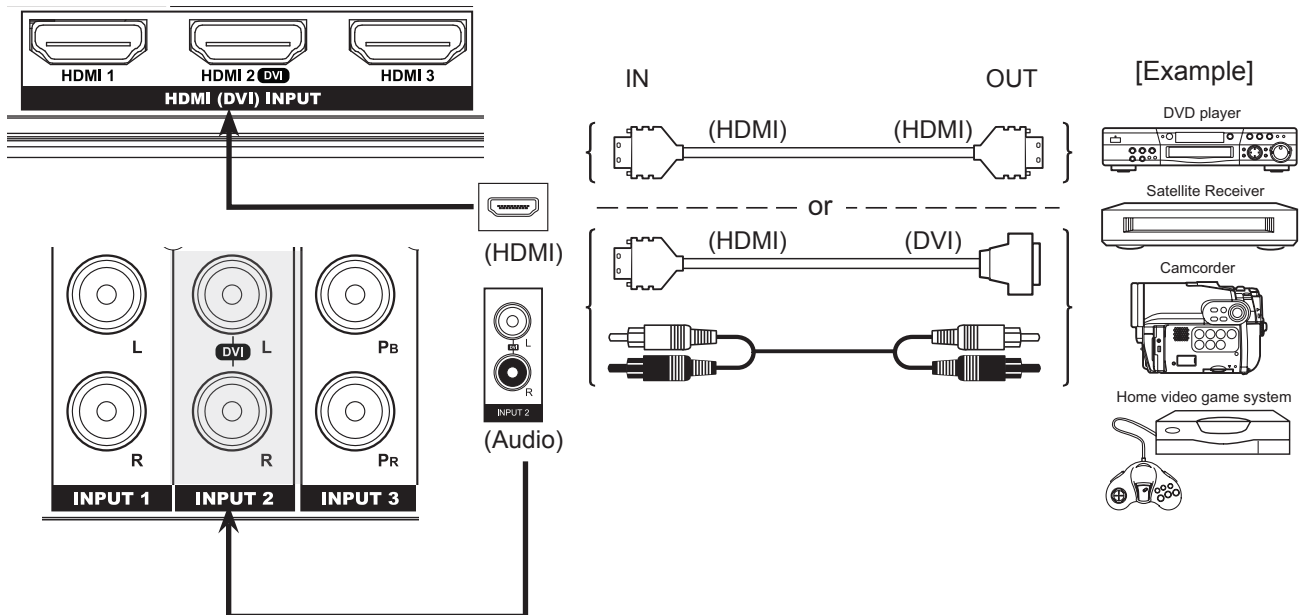

HDMI-Interfaced System

With “**HDMI-CEC**” function, you can interface the connected equipment through the HDMI terminal automatically if the connected equipment meets an industry standard “HDMI CEC (Consumer Electronics Control)”. Please check if the connected equipment supports HDMI CEC before using this function.

Information

The HDMI (High Definition Multimedia Interface) is a multimedia I/O (Input/Output) interface. Only one cable is used to transmit all video/audio/control signals, thus facilitating easy connection. Moreover, the digital signals can produce high quality data without any degradation.

If your external device has an HDMI terminal, HDMI connection is recommended for higher quality picture and sound.

NOTE

Please be sure to insert completely all HDMI or DVI cables when connecting to avoid abnormal picture. Make sure that the video and audio terminals are connected to the same external device. For details of the output format of an external device, refer to "Recommended Signal List" on **40**.

CONNECTION (continued)

1. Connect your Equipment to the A/V Center (continued)

Connecting to Equipment Having a YPbPr Component Output Terminals

The **A/V Center YPbPr** Input 3 and 4 terminals can be connected to devices equipped with YPbPr or YCbCr terminals output. Connect the Y, PB/CB, PR/CR from the Y, PB/CB, PR/CR OUT of the device to the INPUT 3 or 4 YPBPR jacks. Connect the AUDIO OUT signal to the Input 3 and 4 AUDIO IN terminals respectively.

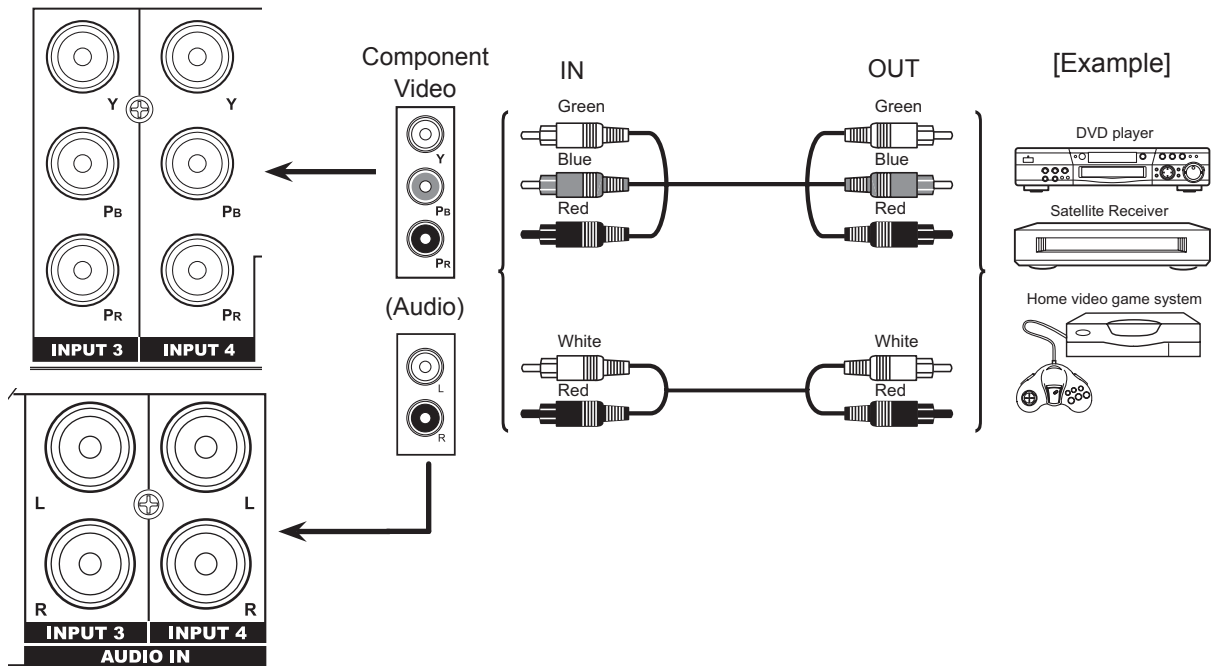

Connecting to Equipment Having Video Output Terminals

The **A/V Center Video Composite** Input 1 and 2 terminals can be connected to devices equipped with standard Video terminals output.

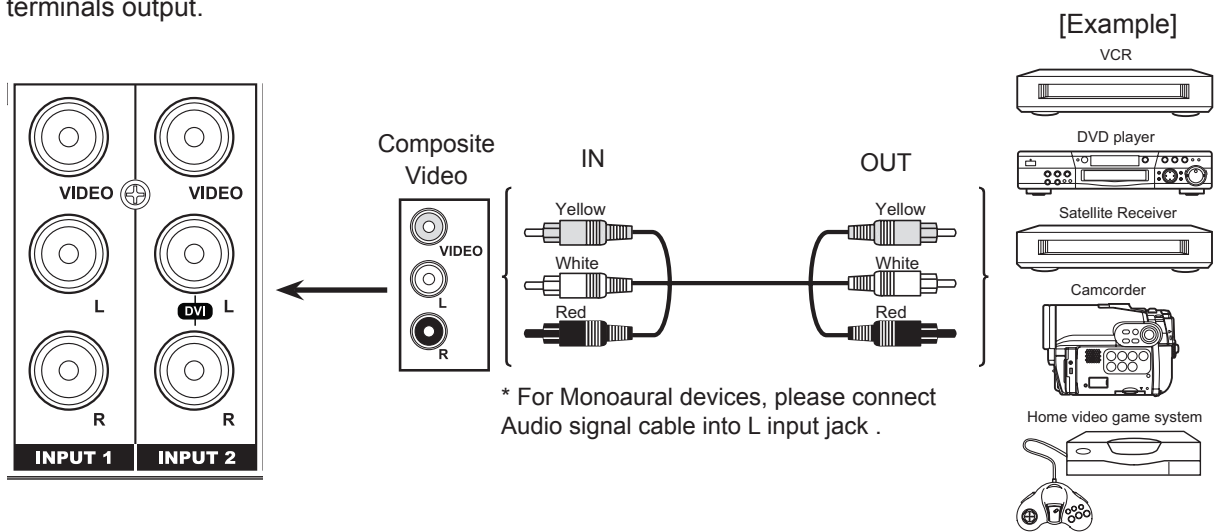

* For Monoaural devices, please connect Audio signal cable into L input jack .

NOTE

Please be sure to insert completely all cables when connecting to avoid abnormal picture and sound. Make sure that the video and audio terminals are connected to the same external device. Cable plugs are often color-coded. Match colors of plugs and terminals, i.e. connect red to red, white to white, etc. For details of the output format of an external device, refer to "Recommended Signal List" on **40**.

CONNECTION (continued)

1. Connect your Equipment to the A/V Center (continued)

Connecting to Equipment Having a Audio Digital Input Terminal

The **A/V Center “OPTICAL OUT”** Audio terminal can be connected to devices equipped with Optical Input capabilities such as Audio Amplifiers Systems. The “OPTICAL OUT” from the A/V Center Rear Panel is a fixed output. The Volume of the amplifier is controlled by the amplifier, not by the A/V Center Unit. The OPTICAL OUT terminal outputs all audio sources.

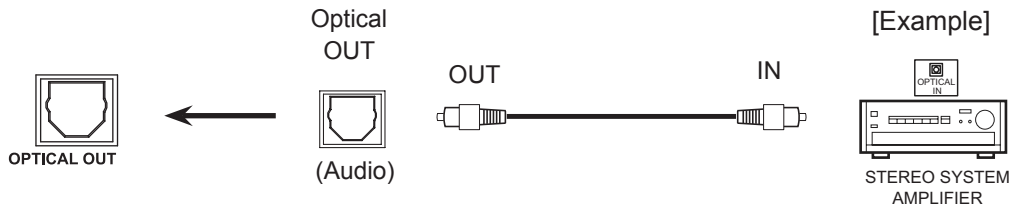

2. Connect your Audio Video Center to the UT Monitor

The **A/V Center HDMI output** terminal (AV Out) is connected to the UT Monitor. Only one cable is used to transmit all video/audio/control signals, thus facilitating an easy connection. Moreover, the digital signals can produce high quality data without any degradation.

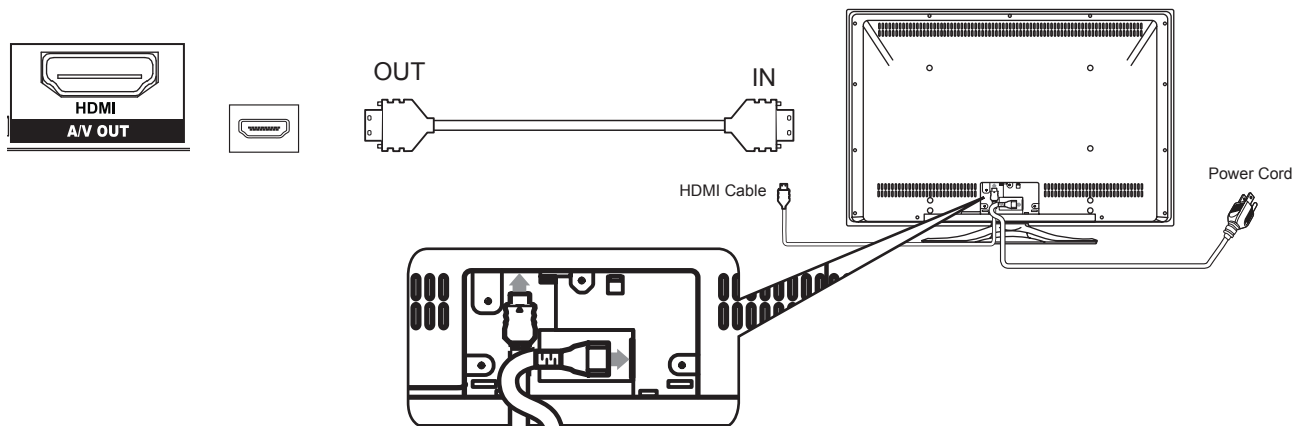

CONNECTION (continued)

3. Connect the A/V Center Power Plug to the Wall Socket

Connect the power cord after completing all other connections.

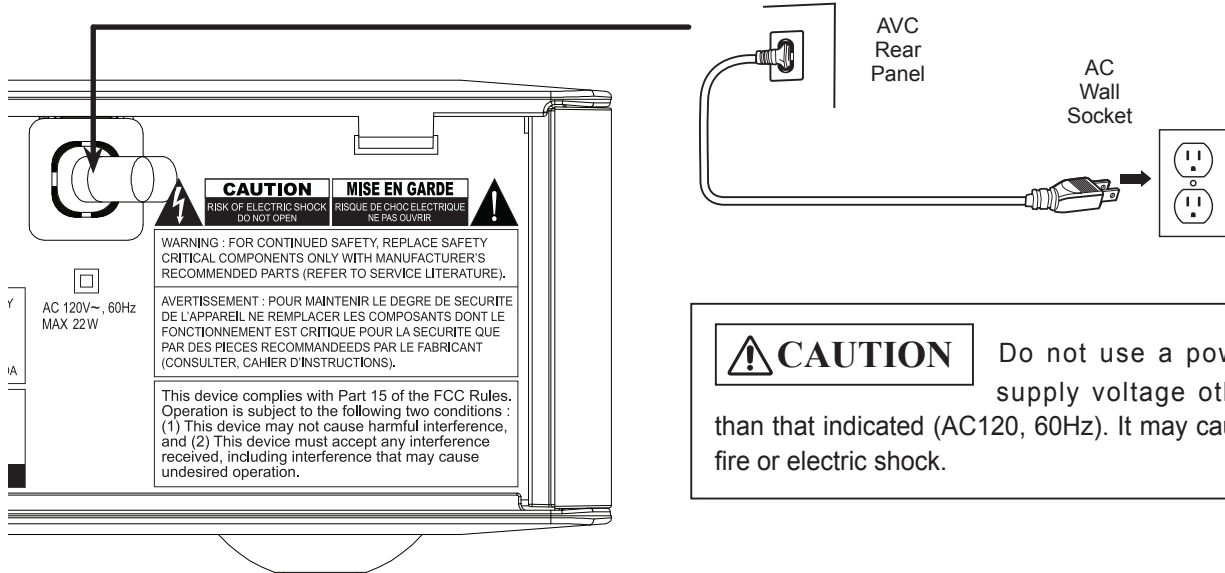

BASIC OPERATION

Power On/Off

Turn On the power of the unit.

• To turn On the power to the unit:

1. Press the **Power Switch** on the A/V Center front or press the Power (On/Off) button on the remote control.
 - The Indicating Lamp turns Blue.
 - The image will display on UT Monitor screen.

• To turn Off the power to the unit:

1. Press the Power (On/Off) button on the remote control.
 - The image disappears from the UT Monitor screen. The Indicating Lamp turns **Red** (Standby mode).
2. Unplug the AC cord from the wall outlet to completely turn Off the power to the unit. The Indicating Lamp turns off.

NOTE

- Due HDMI-CEC function pressing the power on/off button on the remote control will power down both the UT Monitor and the A/V Center.

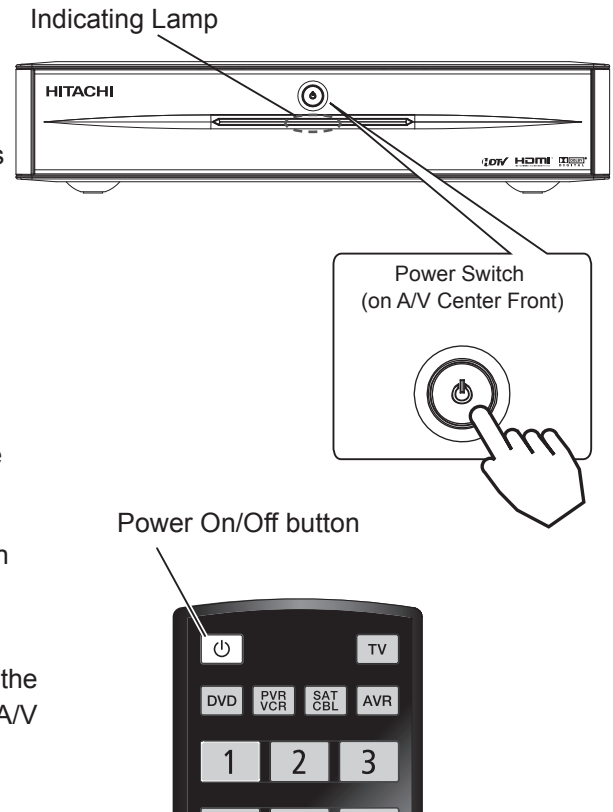

The Indicating Lamp Status

Indicating Lamp	Power Status
Off	Off
Red	Standby mode
Blue	On

NOTE

- If the image does not appear on the UT Monitor screen at all, or if there is any problem with it, see "TROUBLESHOOTING" on [37]~[38]. This may help you to solve the problems.
- After turning On, it takes about 6 seconds until the A/V Center starts up. Please note that buttons on the remote control and the unit (such as the Power button) do not work during this period of time.
- If power is interrupted during use of the unit, to avoid sudden surges of electricity when the power comes back on, unplug AC cord before leaving home.

BASIC OPERATION (continued)

Volume Up/Down

1. To increase the sound volume, press the **Volume Up** button on the remote control or control panel.
 - The Volume Indicator value on the screen will shift to the right.
2. To decrease the sound volume, press the **Volume Down** button on the remote control or control panel.
 - The Volume Indicator value on the screen will shift to the left.

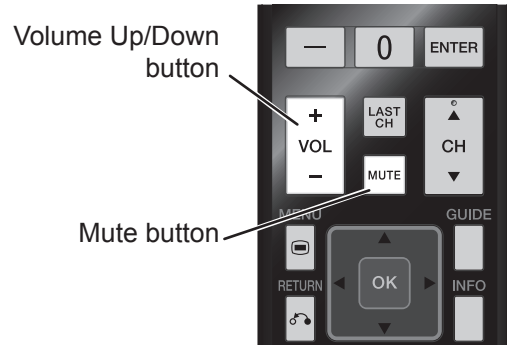

Mute

1. To mute sounds, press the **MUTE** button on the remote control.
 - The sound of the unit is temporarily turned Off.
 - The color of the Volume Indicator will turn into **grey** while muting the volume.
2. To turn the sound back on, press the **MUTE** button again, or press the **Volume Up** button on either the remote control or control panel.
 - The color of the Volume Indicator will turn back to **blue**.

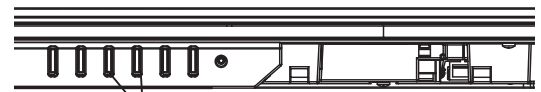

Volume Up/Down button On UT Monitor

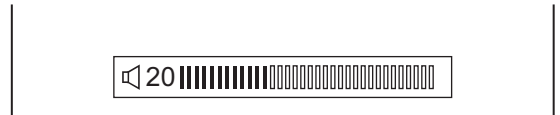

NOTE

- You can decrease the volume by pressing the **Volume Down** button while the sound is muted.

Channel Selector/Favorite Channel

The CHANNEL SELECTOR buttons are used to select channels, lock access code, etc. Use the CHANNEL SELECTOR buttons to enter one, two, or three numbers to select channels. Enter 0 first for channels 1 to 9, or simply press the single digit channel you wish to tune then press the OK button for the TV to tune. Channel selection may also be performed by CHANNEL (CH) UP (▲) or CHANNEL (CH) DOWN (▼).

Press the FAV CH button to switch to Favorite (FAV) channel mode. You will know you are in Favorite Channel mode when (FAV) is displayed and the displayed channel is GREEN. Press it again to return to your regular tuned channels. You can add or delete any channel to your Favorite channel list by pressing FAV CH button on A/V Center/Setup/Channel List menu.

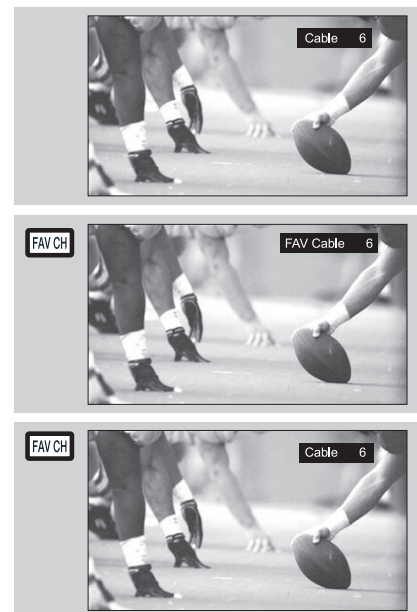

BASIC OPERATION (continued)

Input Switching

Press the button **INPUT** to access the INPUTS menu. Use the CURSOR and OK buttons to scroll and select the inputs that are being used. Pressing the INPUT button repeatedly will also cycle through the Inputs menu items. Then press the **◀▶** and **OK** buttons to select.

- AIR/CABLE Select between Air or Cable signal.
- INPUT 1 Select to choose Input 1.
- INPUT 2 Select to choose Input 2.
- INPUT 3 Select to choose Component Input 3.
- INPUT 4 Select to choose Component Input 4.
- HDMI 1 Select to choose HDMI 1 Input.
- HDMI 2/DVI Select to choose HDMI 2/DVI Input.
- HDMI 3 Select to choose Side HDMI Input.

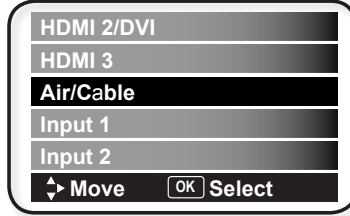

Input Select button

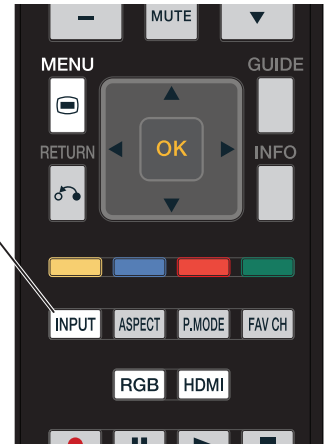

ENGLISH

Input Signal Screen Display

The input signal status can be displayed on the screen by pressing the **INFO** button on the remote control.

- The display will go out in approximately 6 seconds.

HDMI mode

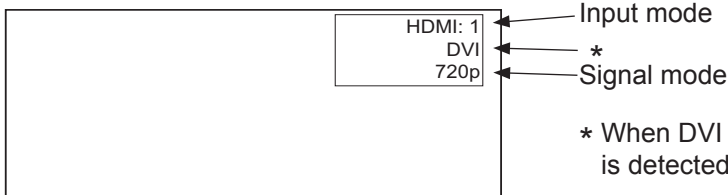

YPbPr Component mode

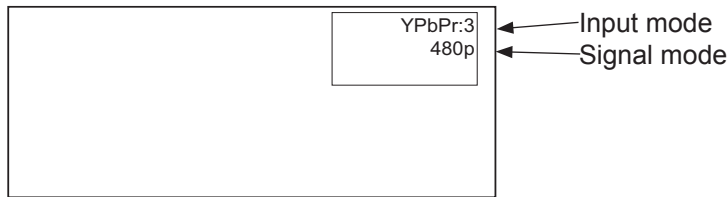

Video Composite mode



Air/Cable mode

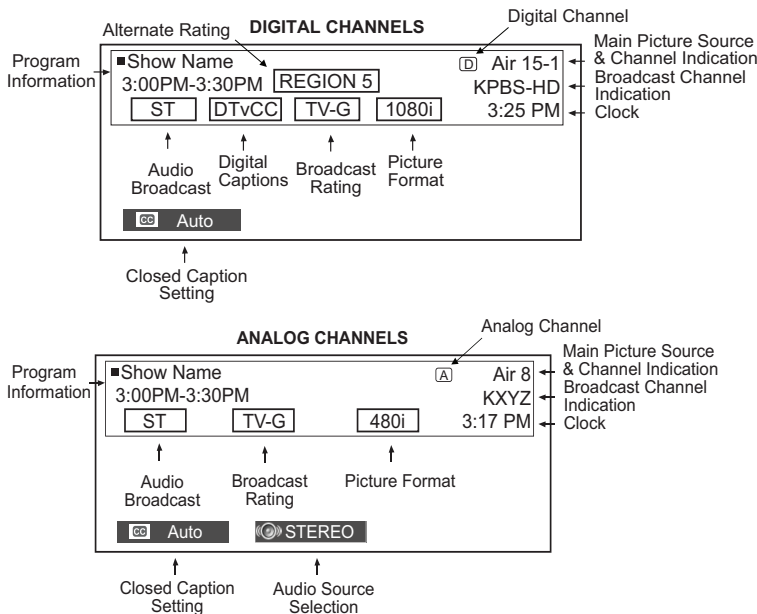

NOTE

- For Digital Channels press the INFO button again for a more detailed description of program.
- Press the INFO button again to return to normal viewing.
- The Aspect setting will not be shown if the channel is locked.

SETUP OPERATION

How to Use the Remote to Control your External Devices

OPERATING THE PRECODED FUNCTIONS FOR YOUR EXTERNAL DEVICES.

The new remote control is designed to operate different types of VCRs, cable boxes, set-top-boxes, satellite receivers, DVD players, and other audio/video equipment. You must first program the remote to match the remote system of your external equipment (refer to pages 25 ~ 26 for precodes).

EXTERNAL DEVICE CONTROL SETUP PROCEDURE

1. Turn on your external device.
2. Select the desired device mode DVD, PVR/VCR, SAT/CBL or AVR by pressing the corresponding device button.
3. Hold down the device button (DVD, PVR/VCR, SAT/CBL or AVR) on the remote and enter the four digit preset code that matches your device as shown on pages 25 ~ 26.
4. Release the device button.
5. If done correctly, the device LED indicator will blink 3 times to confirm proper setup.
6. The remote will now control the desired device.

SETUP EXAMPLE (Hitachi Cable Box with precode 0003)

1. Turn ON your Cable box.
2. Select Cable mode by using your SAT/CBL button to position the LED indicator on SAT/CBL.
3. Hold down the SAT/CBL button on the remote and press the numbers 0, 0, 0 and 3.
4. Release the SAT/CBL button.
5. The indicator light will flash 3 times if the code was accepted.
6. Aim the remote at the cable box and press the POWER button. The remote will turn off your cable box when the correct four digit preset code is entered. When this occurs, the remote control is programmed for your cable box. If the cable box does not turn off, try a different four digit preset code.
7. The remote will now control your Cable box.

Repeat the same procedure for your set-top-box or satellite receiver (select SAT/CBL), your DVD (select DVD), your VCR/PVR(select VCR/PVR), or your AVR (select AVR).

NOTE

- If your external device cannot be operated after performing the above procedures, your external device code has not been precoded into the remote.
- In the unlikely event that your external device cannot be operated after performing the above procedures, please consult your external device operating guide.
- The remote control will remember the codes you have programmed even after the batteries are removed from the remote control. To reset all programmed codes to factory default place remote control in TV mode, then press and hold TV mode key and enter "9", "8", "1" in sequence.
- Depending of your UT Monitor model your remote control could have or not Backlight function.

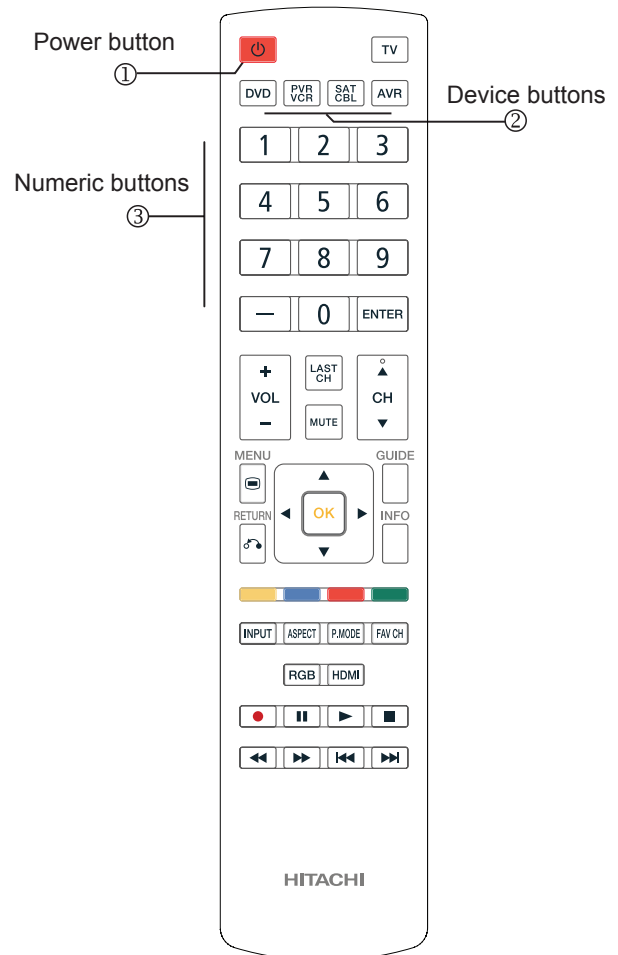

Remote Control Backlight Feature

When you press any remote control button, the buttons will light up. The illumination will light a few seconds during this time. The buttons will appear to light if the room is dark.

Disabling Remote Control Backlight Feature

1. Place the RC in TV mode.
2. Press and HOLD the TV mode key.
3. While holding the TV mode key enter ASPECT, MUTE in sequence.
4. To re-enable the backlight feature do steps 1~3 again (these steps toggle the Backlight Feature on and off, default is ON).

SETUP OPERATION (continued)

How to Use the Remote to Control your External Devices

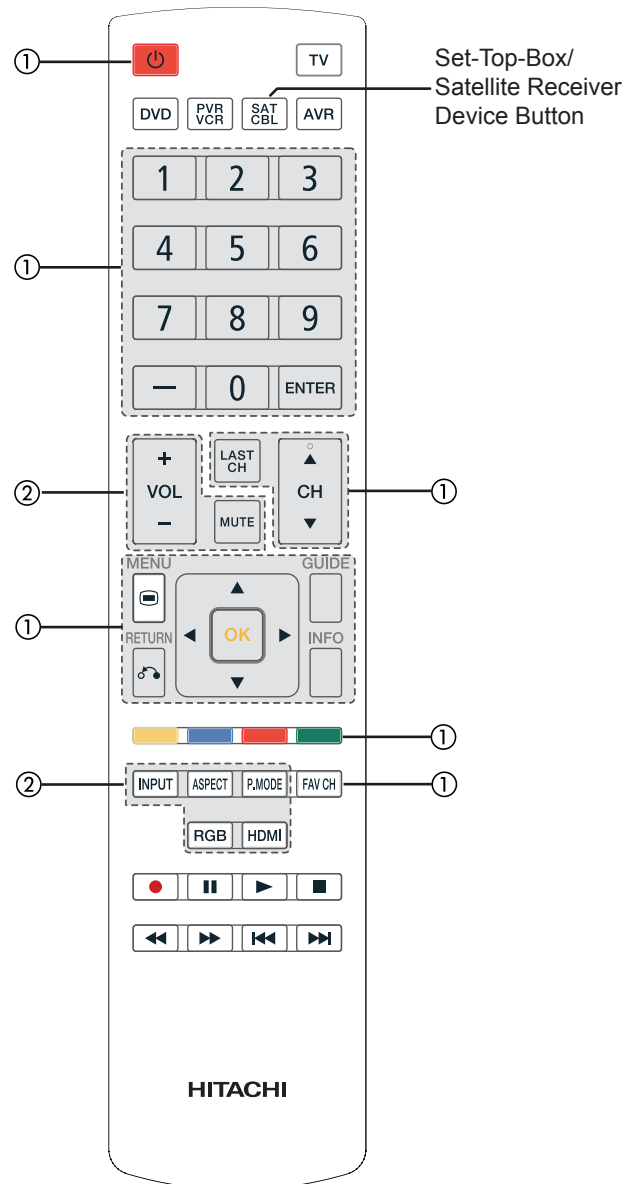
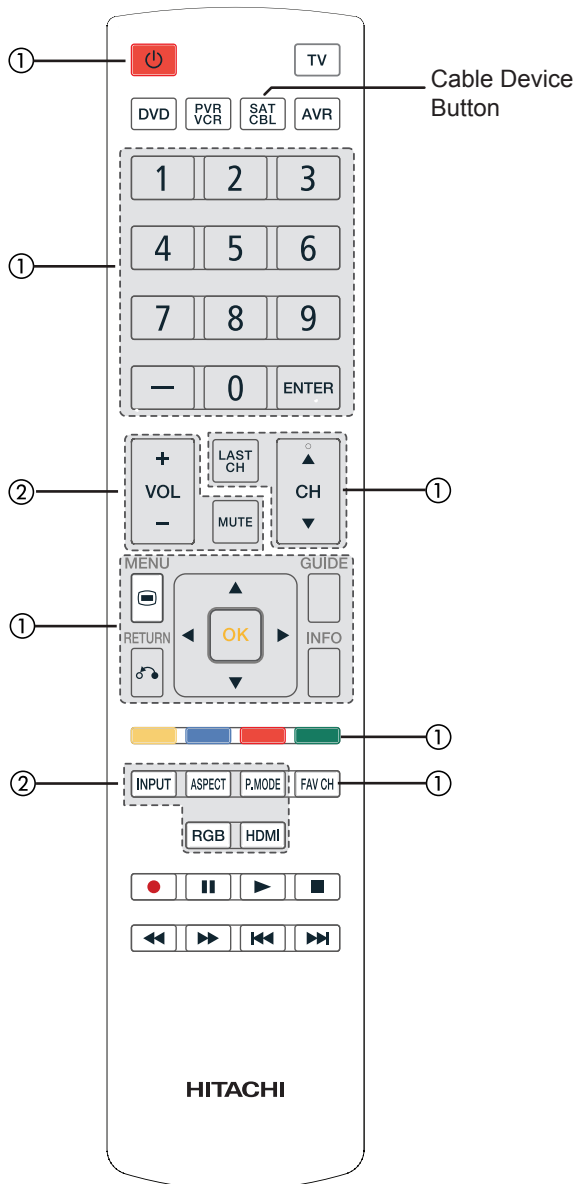

MY CABLE BOX CODE IS: _____

MY SET-TOP-BOX/SATELLITE RECEIVER CODE IS: _____

NOTE

• Refer to the operating guide of the Cable Box for operation of the buttons exclusively for the Cable Box.

NOTE

• Refer to the operating guide of the Set-Top-Box/Satellite Receiver for operation of the buttons exclusively for the Set-Top-Box/Satellite Receiver.

① PRECODED CABLE BOX buttons

These buttons transmit the chosen precoded cable codes :

- Power
- Cursor & OK
- Number PAD
- Menu
- Info
- Enter
- Return
- Channel Up & Down
- Fav CH
- Guide
- Dash(-)
- Color Buttons
- Last CH

② EXCLUSIVE TV mode (Monitor) buttons

These buttons are for operating the TV :

- P. Mode
- HDMI
- Input
- Aspect
- Vol Up & Down
- RGB
- Mute

① PRECODED SET-TOP-BOX/SATELLITE buttons

These buttons transmit the chosen precoded STB/Satellite codes :

- Power
- Cursor & OK
- Number PAD
- Menu
- Info
- Enter
- Return
- Channel Up & Down
- Fav CH
- Guide
- Dash(-)
- Color Buttons
- Last CH

② EXCLUSIVE TV mode (Monitor) buttons

These buttons are for operating the TV :

- P. Mode
- HDMI
- Input
- Aspect
- Vol Up & Down
- RGB
- Mute

SETUP OPERATION (continued)

How to Use the Remote to Control your External Devices

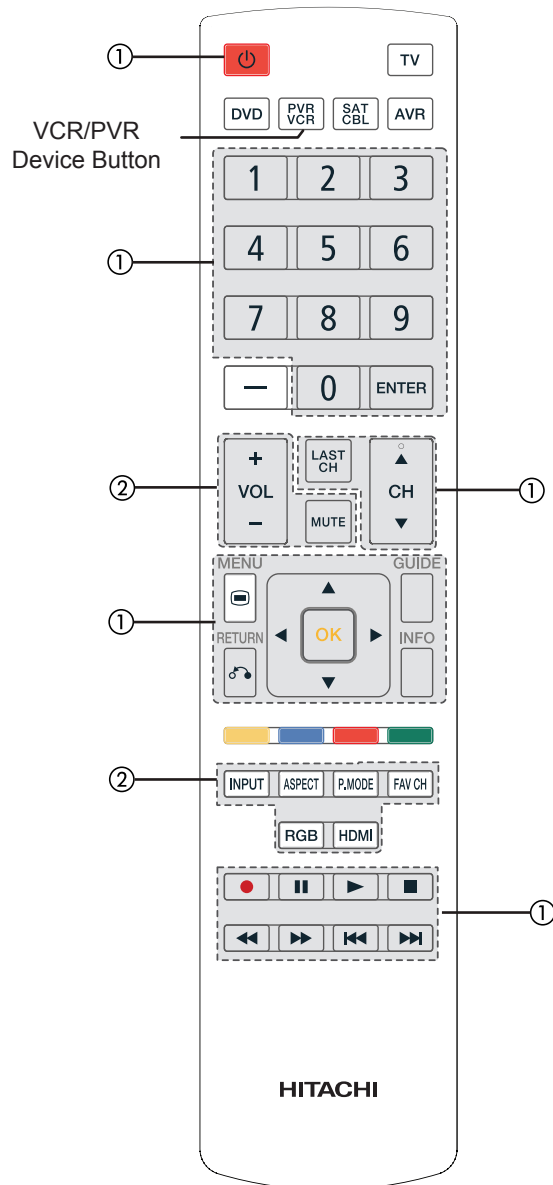
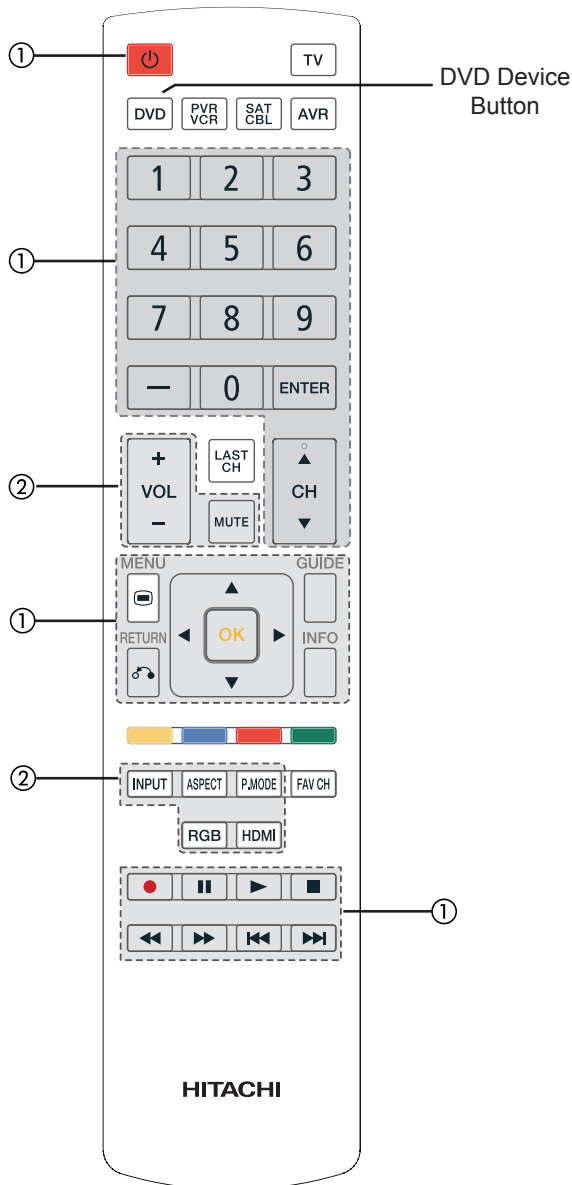

MY DVD PLAYER CODE IS: _____

MY VCR/PVR CODE IS: _____

NOTE

• Refer to the operating guide of the DVD Player for operation of the buttons exclusively for the DVD Player.

NOTE

• Refer to the operating guide of the VCR/PVR for operation of the buttons exclusively for the VCR/PVR.

① **PRECODED DVD buttons**

These buttons transmit the chosen precoded DVD codes :

- Power
- Cursor & OK
- Play, Stop, Pause, RWD, FWD, Skip
- Menu
- Info
- Return
- Number PAD
- Guide
- Dash(-)
- Enter

② **EXCLUSIVE TV mode (Monitor) buttons**

These buttons are for operating the TV :

- P. Mode
- Aspect
- RGB
- HDMI
- Vol Up & Down
- Mute
- Input

① **PRECODED VCR/PVR buttons**

These buttons transmit the chosen precoded VCR/PVR codes :

- Power
- Cursor & OK
- Record
- Menu
- Channel Up & Down
- Play, Stop, Pause, RWD, FWD, Skip
- Return
- Number PAD
- Info
- Last CH
- Guide
- FAV CH
- (FWD, RWD)

② **EXCLUSIVE TV mode (Monitor) buttons**

These buttons are for operating the TV :

- P. Mode
- Aspect
- RGB
- HDMI
- Vol Up & Down
- Mute
- Input

SETUP OPERATION (continued)

How to Use the Remote to Control your External Devices

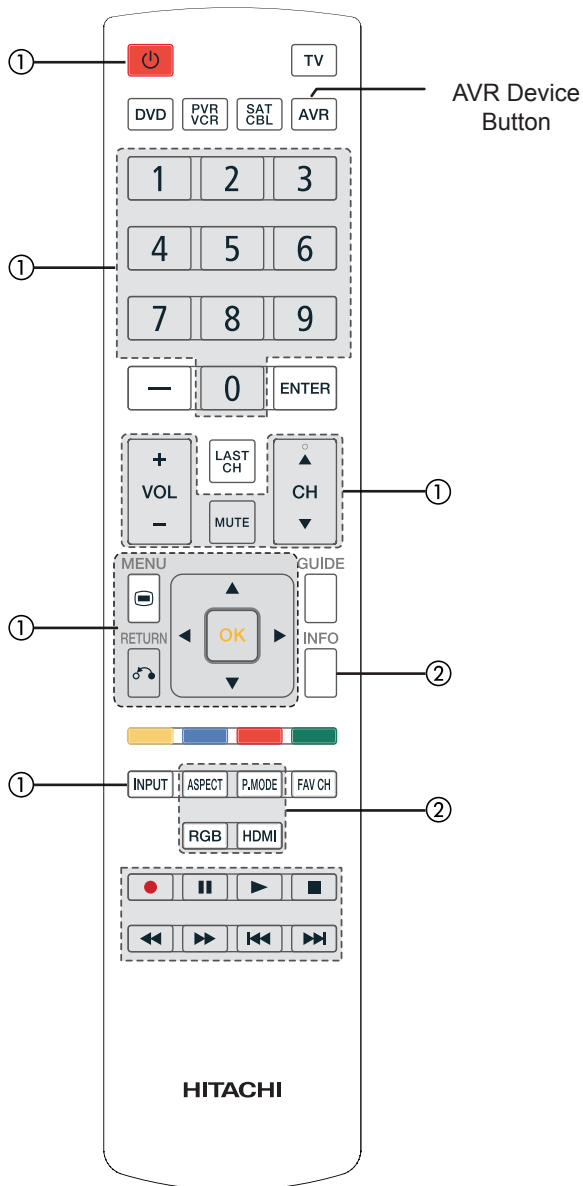

MY AUDIO/VIDEO RECEIVER (AVR) CODE IS: _____

NOTE

- Refer to the operating guide of the AVR for operation of the buttons exclusively for the AVR.

① PRECODED AVR buttons

These buttons transmit the chosen precoded cable codes :

- Power
- Channel Up & Down
- Input
- Number PAD
- Vol Up & Down
- Mute
- Cursor PAD
- Menu
- Return

② EXCLUSIVE TV mode buttons

These buttons are for operating the TV :









- P. Mode
- HDMI
- Info
- Aspect
- RGB

SETUP OPERATION

How to Use the On-Screen Display (OSD) System

You can use the On-Screen Display system to access the various kinds of the features and functions of your A/V Center.

• Basic Operation

1. Press the  button on the remote control or the Menu button on the control panel underneath the UT monitor. The **Main Menu** is displayed on the screen as shown on the right.
2. To select the A/V Center menu, press the  button.
The A/V Center item will be highlighted in Yellow.
3. Press the  button to set your selection.
The A/V Center unit menu page will be displayed on the screen.
4. Use the  button to choose the item on the menu page.
Press the  button to set your selection.
5. Use the  button to adjust the item values or choose options.
Press the  button to set your selection.
6. To exit from the menu, press the  or the  button.

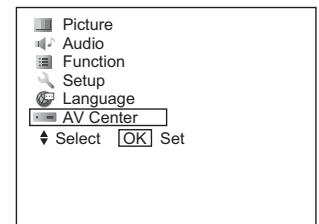
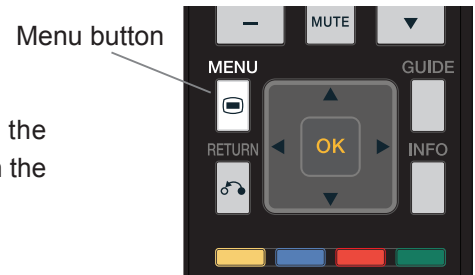

<Main Menu>

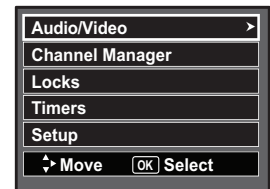

<A/V Center Menu>



UT Monitor
Control panel
Menu button



NOTE

- The OSD menu screen will be closed automatically when no operation has been made for about one minute.
- If the item on the menu is shown in gray, it means that it cannot be selected or adjusted.
- In order to appear A/V Center menu on Main Menu, A/V Center Control need to be activated on Funcion/HDMI Control menu.

Select Language

Select the language from the list so that the OSD menu can be displayed in the selected language. The default setting is English (US).

• How to set Language

1. Enter the “**Language**” menu from the Main Menu.
2. Select your preferred language from the list using the  button.
The selected item will be highlighted in Yellow.
3. Press the  button to set your selection.
The mark on the left turns into a double circle when the selection is fixed.
4. Press the  button to exit from the entire OSD menu.

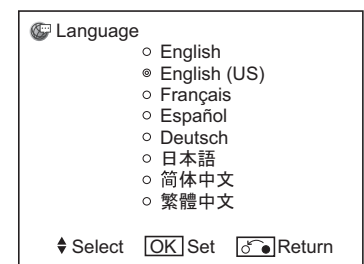

NOTE

- When the Language is set on Main Menu the A/V Center menu automatically set to that language, please note that English, Spanish and French are supported by A/V Center.

On-Screen Display

This part of the screen shows which selections are available.



Main Menu List

	Menu		Page
Audio/Video	Video Resolution	Select between 2 resolution modes.	29
	Auto Movie Mode	Adjust to make the moving image smooth.	29
	3D Comb Filter	Reduce the color blurring to reproduce purer color.	29
	Audio Source	Select between 3 Audio Sources.	29
	Audio Language	Select Language options if available.	29
	Digital Output	Select Optical Output options.	29
	DRC	Select Dynamic Range Compression to ON or OFF.	29
	Lyp Sync	Synchronizes audio with video signal on digital and analog sources.	29

NOTE

- “3D Comb Filter” is only available to Composite Inputs and Analog Channels.
- “Audio Language”, “Digital Output” and the “DRC” are only available for Digital Channels.
- “Auto Movie Mode” and “Lyp Sync” can be stored for each of inputs.

	Menu		Page
Channel Manager	Signal Meter	Access Signal Meter.	30
	Auto Channel Scan	Set Auto Channel Scan.	30
	Channel List	Set Channel List.	30

NOTE

- “Signal Meter” is only available for Digital Channels..

	Menu		Page
Locks	Change Access Code	Change Lock access code.	31
	Movie Ratings	Block various types of movies and video types based on motion picture ratings.	31
	TV Ratings	Block various types of movies and television programming based on a parental guide ratings.	31
	Canadian Ratings (ENG)	Block various types of movies and television programming based on the Canadian ratings system.	31
	Canadian Ratings(FRN)	Block various types of movies and television programming based on the Canadian French ratings system.	31
	Region 5	Ratings system for DTV Signal to block various types of programs.	31

NOTE

- “Region 5” is only available for Digital Channels..

	Menu		Page
Timers	Set The Clock	Set Clock Settings.	34
	Set Sleep Timer	Set Sleep Timer intervals (30 min. intervals, 00:30-3:00).	34

	Menu		Page
Setup	Set The OSD & Panel Options	Choose OSD Contrast. and Side Panel Color.	35
	Set The Inputs	Label Video Inputs, VCR, DVD, etc	35
	Set The Closed Captions	Feature to display dialogue/text and change its appearance.	35
	Reset The Software	Select to upgrade A/V Center software	36

On-Screen Display (continued)

Audio/Video



You can adjust some settings of the display and audio condition.

Select "Audio/Video" from Menu list.

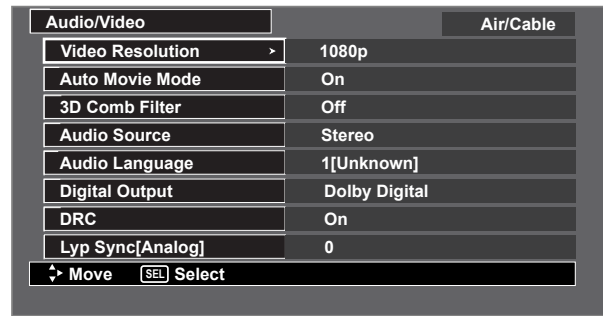

OR



Selected Items		Setup hint
Video Resolution	1080p	You can make the selection for A/V Center output resolution, depending of your preference.
	1080i	
Auto Movie Mode	On	On: Automatically identifies if it is a movie and faithfully reproduces the original film images.
	Off	Off: Set to Off if the image does not look natural.
3D Comb Filter	On	This reduces the dot and color blurring in minute scales so that it can reproduce purer color.
	Off	
Audio Source	Stereo	Multi-Channel Television Sound will allow you to select STEREO (a stereo broadcast), MONO (monaural sound) used when receiving a weak stereo broadcast or SECOND AUDIO PROG (SAP) which may be a secondary language, weather report, etc.
	Mono	
	SAP	
Audio Language	1[English] 2~4[Others]	Some programs transmit more than one DTV language option. Most will have English as a default language. The language function will allow you to select up to 4 language options (if available).
Digital Output	*Dolby®Digital 	This function allows you to select between Dolby®Digital and PCM. This setting is fed into Optical Output. Dolby®Digital Select this feature if the TV is connected to an amplifier/receiver with a Dolby®Digital only decoder; it will provide six independent soundtrack channels through the optical output jack (Digital Audio). PCM Select this feature if the TV is connected to an amplifier/receiver with a PCM only decoder; it will provide two independent soundtrack channels through the optical output jack (Digital Audio).
	PCM	
DRC	On	Dynamic Range Compression.- Use this function to compress the range of sound volume. By compressing the range of sound volume, it is possible not only to suppress the output of loud sound at night but also to raise the volume of low sound. The default setting is ON.
	Off	
Lyp Sync	-2~+5	Selecting this feature will allow you to synchronize the audio with the picture signal. AUTO option automatically synchronize the audio and picture, if result is not satisfactory, please use the  button to synchronize the picture and the audio signal manually. The default value is set to 0.

NOTE

*Manufactured under license from Dolby Laboratories. "Dolby" and the double-D symbol are trademarks of Dolby Laboratories.

On-Screen Display (continued)

Channel Manager

Select CHANNEL MANAGER to set your Antenna options, run Auto Channel Scan, Check Signal Meter and Set Channel List. Select "Channel Manager" from Menu list.

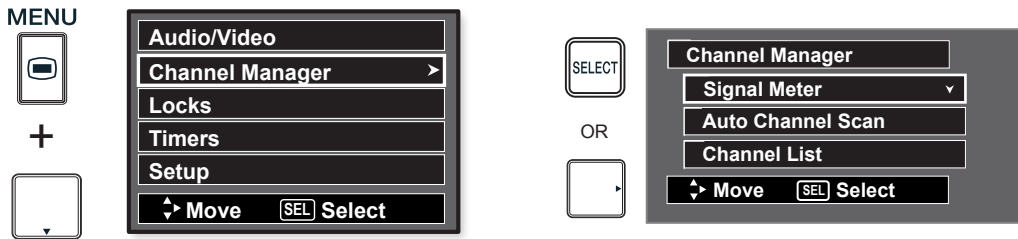

Selected Items	Setup hint
Signal Meter*	Select SIGNAL METER when using an indoor or outdoor antenna. This feature will show the signal strength and peak values of the Antenna signal to help you adjust your antenna to optimize signal reception.
Auto Channel Scan	This feature will automatically store active Analog and Digital channels in Auto Channel Scan memory. 1.-Use the button to highlight AIR or CABLE source. 2.-Then use the and buttons to highlight and select the START or RESET option.
Channel List**	This function allows you to review which channels are labeled (ID), which have been added to CHANNEL MEMORY (SKIP), which are protected by LOCK and which are your FAVORITE (FAV) CHANNELS. 1.-Use the button to navigate the Channel List. 2.-Use the button to select ON or OFF on the SCAN and LOCK columns. 3.-To select LOCK column, input the access code.(Default access code: 0000). 4.-Press the FAV CH button to set or remove the FAVORITE settings.

NOTE

- *The Signal Meter will not be available (grayed out) when watching analog channels.
- **The Channel List cannot be updated by only changing the cable source. Auto Channel Scan must be performed for the Channel List to be updated.

IMPORTANT NOTICE

United States federal law requires broadcasters to stop transmitting analog (non-digital) television signals after February 17, 2009. Accordingly, this TV's analog tuner will not be capable of receiving over-the-air analog television broadcasts after such analog broadcasts are no longer available.

After February 17, 2009, this TV's analog tuner will continue to work with compatible cable and satellite TV systems, gaming consoles, VCRs, DVD players and other similar products.

Both before and after February 17, 2009, this TV's digital tuner will receive available over-the-air digital television broadcasts using an antenna and other digital television broadcasts using compatible cable, satellite or other digital television system connections. Please review this Operating Guide for further information regarding such connections.

Hitachi supports the DTV transition and as a member of the DTV Transition Coalition urges consumers to visit these web sites for interactive guides and further detailed information:

- www.dtvtransition.org
- www.myceknowhow.com
- www.dtv2009.gov
- www.youtube.com

On-Screen Display (continued)

Locks

This function will block out the picture and sound of the selected channel

Select "Locks" from the Menu list.



1. Use the button to select the RATING CATEGORY (MOVIE, TV, etc.) that you want to block.
2. Use the button to block the RATING that you have selected.

Selected Items	Setup hint
Change Access Code	Select CHANGE ACCESS CODE to change the factory preset code (0000) to your preference. If you forget your ACCESS CODE NUMBER, use the factory code 7777 to erase your key number. This will reset the access code number back to the factory preset (0000).
Movie Ratings	Use Movie Ratings to prevent viewing of any movie that you feel may be inappropriate due to its content (see page 32).
TV Ratings	Use TV Ratings to prevent viewing of any TV program that you feel may be inappropriate due to its content(see page 32).
Canadian Ratings(Eng)	Use CANADIAN RATINGS (ENG) to block any type of movie and television program in Canada that you feel might be inappropriate in its content (see page 32).
Canadian Ratings(Frn)	Use CANADIAN RATINGS (FRN) to block Canadian French programs according to various program ratings that you feel might be inappropriate in its content (see page 33).
Region 5*	Use REGION 5 to block various types of movies and television pograms based on ratings systems used in U.S. that you feel may be inappropriate due to its content (see page 33). Due Region 5 ratings are downloaded from broadcaster signal, they are not fixed, UPDATE function will let you receive latest rating data.

NOTE

- *The REGION 5 option will operate for Digital Channels(ATSC) only.

On-Screen Display (continued)

Locks(continued)

Motion Picture Ratings Table

NOT RATED	Contains no rating. Not Rated (NR) and Not Applicable (NA) programs. Movie has not been rated or ratings do not apply.
G	General audiences. All ages admitted.
PG	Parental guidance suggested. Some material may not be suitable for children.
PG-13	Parents strongly cautioned. Some material may be inappropriate for children under 13.
R	Restricted. Under 17 requires accompanying parent or adult guardian.
NC-17	No one 17 and under admitted.
X	Adults only

NOTE ➤

- A movie rating is dependent upon the movie that is viewed. If the movie does not carry a rating, the TV will not block it.
- Blocking NOT RATED programs may block emergency programming, sports, news, public service announcements, religious programs and weather.

TV Parental Guide Ratings Table

TV-Y	All children. The themes and elements in this program are specifically designed for a very young audience, including children from ages 2-6.
TV-Y7	Directed to older children. Themes and elements in this program may include mild physical or comedic violence, or may frighten children under the age of 7.
TV-G	General audience. It contains little or no violence, no strong language, and little or no sexual dialogue or situations.
TV-PG	Parental guidance suggested. The program may contain infrequent coarse language, limited violence, some suggestive sexual dialogue and situations.
TV-14	Parents strongly cautioned. This program may contain sophisticated themes, intense sexual situation, more intense violence and intensely suggestive dialogue.
TV-MA	Mature audiences only. This program may contain mature themes, indecent language, graphic violence, and explicit sexual content.

FV: Fantasy/Cartoon Violence V: Violence S: Sexual Situation L: Adult Language D: Sexually Suggestive Dialogue

NOTE ➤

- If you Block TV-14D, you will still permit TV-MA programs; If you block TV-14V, you will automatically block TV-MAV programs, but you will still permit TV-MALS programs. This means that the TV will block violence in TV-14 and higher (TV-MA), but not language and sex.
- TV program ratings are dependent on the broadcaster. If the program is not rated, the TV will not block it.

Canadian Ratings English Table

C	Programming intended for children under age 8 - Violence Guidelines; Careful attention is paid to themes, which could threaten children's sense of security and well-being. There will be no realistic scenes of violence. Depictions of aggressive behaviour will be infrequent and limited to portrayals that are clearly imaginary, comedic or unrealistic in nature. Other Content Guidelines: There will be no offensive language, nudity or sexual content.
C8+	Programming generally considered acceptable for children 8 years and over to watch on their own - Violence Guidelines: Violence will not be portrayed as the preferred, acceptable, or only way to resolve conflict; or encourage children to imitate dangerous acts which they may see on television. Any realistic depictions of violence will be infrequent, discreet, of low intensity and will show the consequences of the acts. Other Content Guidelines: There will be no profanity, nudity or sexual content.
G	General Audience - Violence Guidelines: Will contain very little violence, either physical or verbal or emotional. Will be sensitive to themes which could frighten a younger child, will not depict realistic scenes of violence which minimize or gloss over the effects of violent acts. Other Content Guidelines: There may be some inoffensive slang, no profanity and no nudity.
PG	Parental Guidance - Programming intended for a general audience but which may not be suitable for younger children. Parents may consider some content inappropriate for unsupervised viewing by children ages 8-13. Violence Guidelines: Depictions of conflict and/or aggression will be limited and moderate; may include physical, fantasy, or supernatural violence. Other Content Guidelines: May contain infrequent mild profanity, or mildly suggestive language. Could also contain brief scenes of nudity.
14+	Programming contains themes or content which may not be suitable for viewers under the age of 14 - Parents are strongly cautioned to exercise discretion in permitting viewing by pre-teens and early teens. Violence Guidelines: May contain intense scenes of violence. Could deal with mature themes and societal issues in a realistic fashion. Other Content Guidelines: May contain scenes of nudity and/or sexual activity. There could be frequent use of profanity.
18+	Adult - Violence Guidelines: May contain violence integral to the development of the plot, character or theme, intended for adult audiences. Other Content Guidelines: May contain graphic language and explicit portrayals of nudity and/or sex.

On-Screen Display (continued)

Locks (continued)

Canadian Ratings French Chart

G	General - Programming intended for audiences of all ages. Contains no violence, or the violence content is minimal or is depicted appropriately with humor or caricature or in an unrealistic manner.
8 ans+	8 + General - Not recommended for young children - Programming intended for a broad audience but contains light or occasional violence that could disturb young children. Viewing with an adult is therefore recommended for young children (under the age of 8) who cannot differentiate between real and imaginary portrayals.
13 ans+	Programming may not be suitable for children under the age of 13 - Contains either a few violent scenes or one or more sufficiently violent scenes to affect them. Viewing with an adult is therefore strongly recommended for children under 13.
16 ans+	Programming is not suitable for children under the age of 16 - Contains frequent scenes of violence or intense violence.
18 ans+	Programming restricted to adults - Contains constant violence or scenes of extreme violence.

Region 5 Alternate Ratings (Example Only)

G	General audiences. All ages admitted.
PG	Parental guidance suggested. Some material may not be suitable for children.
PG-13	Parents strongly cautioned. Some material may be inappropriate for children under 13.
R	Restricted. Under 17 requires accompanying parent or adult guardian.
NC-17	No one 17 and under admitted.
X	Adults only.
Y	Adults only.

NOTE

- In order to set the Region 5 Ratings the ATSC Digital channel received must include Region 5 Ratings data. To see if the channel has Region 5 Ratings, press the INFO key on the R/C. See fig. (1) below for reference.
- Once the TV has received Region 5 Ratings data, the Region 5 option in the lock menu will display the data.

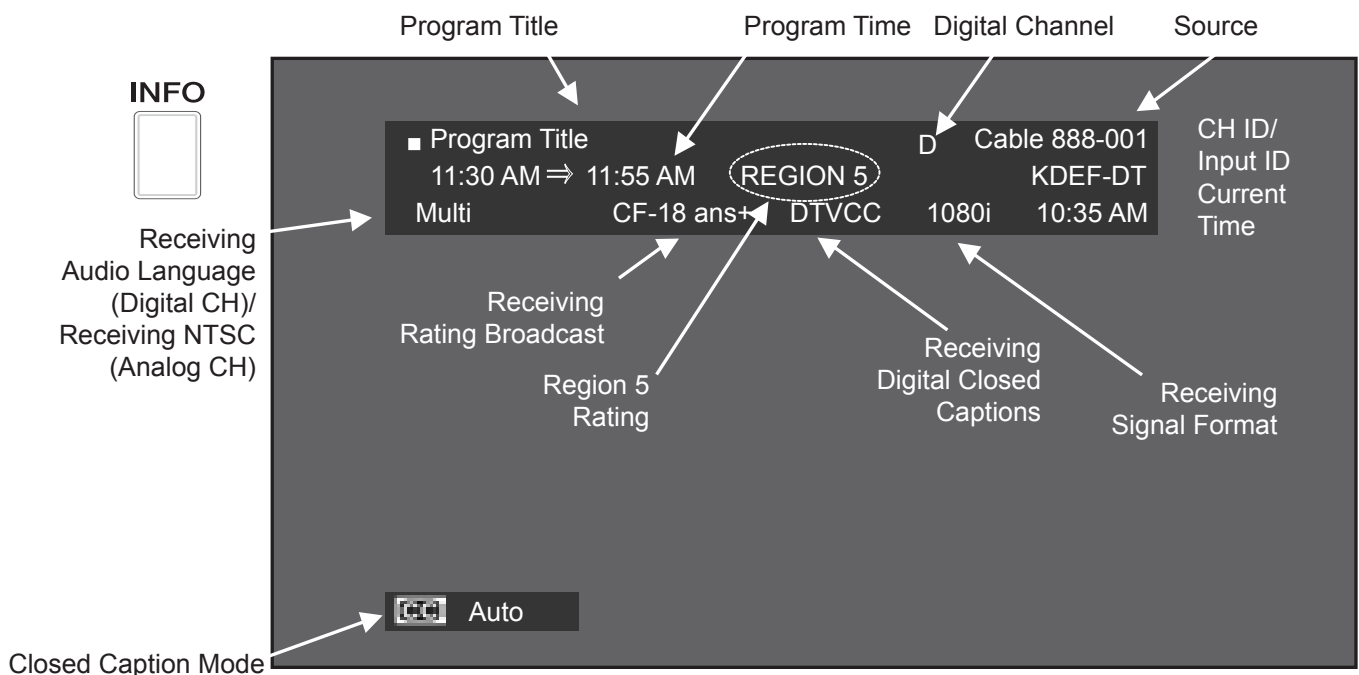
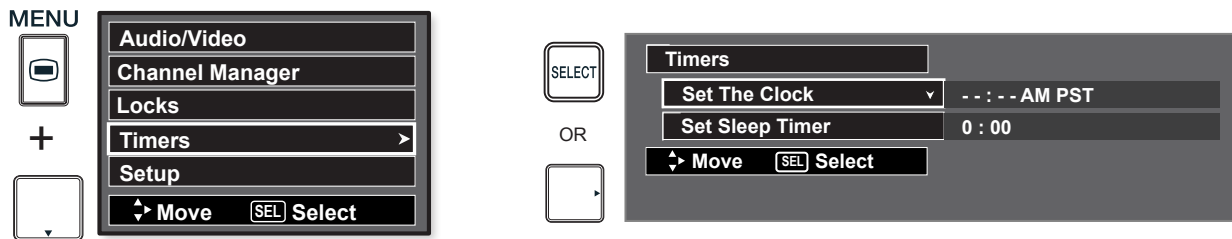







Fig. (1) Channel Information

On-Screen Display (continued)

Timers

Select TIMERS to set your Clock and the Sleep Timer
 Select "Timers" from the Menu list.



Selected Items	Setup hint
Set The Clock*	Use the  button to highlight and setup the TIME ZONE settings. If you observe daylight savings, use the  button to highlight the DAYLIGHT SAVING CORRECTION checkbox and the  button to activate it. Use the  button to highlight and setup the CURRENT TIME (hour and minute), AM or PM, MONTH, DAY, and YEAR.
Set Sleep Timer**	Select this feature to set your SLEEP TIMER from 30 minutes to 3 hours (30 minute increments). Use the  button repeatedly to set your Timer from 0:00, 0:30, 1:00, 1:30, 2:00, 2:30 and 3:00.

NOTE

- *When AUTOMATICALLY ADJUST CLOCK FOR DAYLIGHT SAVING CHANGES is checked ✓, the TV will automatically calculate the clock adjustment for Daylight Saving.
- **The Sleep Timer info will show for 30 seconds before the TV turns off.
- Dash Button(-) can be used also to activate Sleep Timer.

On-Screen Display (continued)

Setup

Select SETUP when setting your TV up for the first time.
Select "Setup" from the Menu list.



Selected Items		Setup hint
Set The OSD & Panel Options	OSD Contrast	<p>"OSD Contrast" allows you to change the contrast of OSD based on 4 levels (min, low, medium and max).</p> <ul style="list-style-type: none"> Use the button to highlight and setup the option of your choice. Select MAX , MEDIUM, LOW or MIN depending of your choice of contrast between letters/frame and background.
	Side Panel Color	<p>The "Side Panel Color" function turns the black side bars from black to gray when watching 4:3 signals in Standard mode.</p>
Set The Inputs		<p>Use this feature to give a name to any of the seven video inputs. Select Game Name when playing with a Video game system to avoid delay between picture and user control of the game machine.</p>
Set The Closed Captions	Analog Captions	<p>Closed Captions are the dialogue, narration, and/or sound effects of a television program or home video which are displayed on the TV screen. Your local TV program guide denotes these programs as or .</p> <p>Analog Captions are for Analog programs.</p> <p>Caption Mode: CAPTIONS is for the program you are viewing. TEXT is for additional information such as news reports or a TV program guide. This information covers the entire screen and viewing the TV program is not possible. Text may not be available with every program.</p>
	Digital Captions	<p>Channel: 1 is used for the primary language (usually English). 2,3,4 are sometimes used for a others languages(may vary by region).</p> <p>Digital Captions are for digital programs. This function will help choose and set available language, font, size, color and background style of digital captions.</p>

NOTE

- Some types of digital closed captions will not work with this A/V Center.
- Caption Display will not work when viewing a 480i, 480p, 720p or 1080i input via the COMPONENT: Y-PBPR or HDMI inputs .
- Closed Caption and Digital Captions availability and content depends on the broadcaster. Closed Caption is available when Closed Caption icon is displayed on screen.
- Digital Captions language will not be available (grayed out) when using analog channels.

On-Screen Display (continued)

Setup (continued)

Selected Items	Setup hint
Reset The Software	<p>This feature shows software information and easy upgrade procedure. This function allows the TV software to be upgraded by using a USB flash drive. If a future software upgrade is required for your TV, HITACHI will notify and provide proper instructions to get this upgrade. In order to receive written notification, please complete and return the warranty card.</p> <ol style="list-style-type: none">1.-Insert the USB flash drive.2.-Press the <input type="button" value="OK"/> button to select UPGRADE NOW and start upgrading.3.-Unplug the AC power cord when the UPGRADE is complete.

NOTE

- Any power interruption during the upgrade process will cancel the upgrade. When this happens, repeat the upgrade procedure.
- For further information about A/V Center software upgrade procedure, please contact 800-HITACHI or visits us on the web: www.hitachi.us/tv

TROUBLESHOOTING

About LCD Display Technology

The following are common phenomena occurring when viewing LCD display devices due to its characteristics. Please note that these are not malfunctions.

• Defective Spots on Panel

The LCD panel is manufactured with high-precision technology. However, there might be some spots that are not illuminated, or are brighter than others, or are in different colors, etc.

• Surface on Panel

The LCD panel displays images by the fluorescent lamps internally. This can raise the temperature of the display surface.

In addition, do not allow any heavy impact to the front of the panel because the LCD panel is made of high precision glass.

• Use Under Low Temperature Conditions

Because of the structural characteristics of the LCD panel, the response speed of the LCD panel becomes slower when the ambient temperature becomes too low. In some cases, this may result in a residual image.

The residual image will disappear of its own accord as the temperature rises again to a normal level.

Before calling a service technician, check the following tables first. If the problem cannot be solved with the suggested procedures, contact **800-HITACHI**. For your safety, NEVER try to repair the product yourself.

When the Following Messages Appear on the Screen





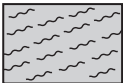











Message	Condition / Action	Page
Power Save	This message comes from UT Monitor not A/V Center, indicates Monitor is in Power Save Mode(example: if you turn off only A/V Center and Power Save Mode is activated on UT Monitor). The indicating lamp lights in orange on UT Monitor.	
No Sync. Signal	The unit cannot detect any signals from any input terminals. <ul style="list-style-type: none"> • Check if the cable is connected correctly and firmly. • Check if the power of any external equipment is ON. • Check if the input selection matches the connection terminal. 	14 ~ 17
Weak Signal or Channel not available.	This shows the selected channel is not available. <ul style="list-style-type: none"> • Check the signal meter. 	30

Symptom and Checklist

Symptoms		Checklist	Page
• No picture - no sound		<ul style="list-style-type: none"> • Check if the power of the A/V Center and UT Monitor or external equipment is ON. • Check the connection of the power cord and/or other cables. • Check if the correct mode is selected. • Check if the UT Monitor is in "Standby mode" or "Power Save mode". • Adjust the values in "Picture" and "Audio" on UT Monitor menu". 	14 ~ 17 29
• Multiple images-normal sound		<ul style="list-style-type: none"> • Check the connections to external equipment. 	14 ~ 17
• Intermittent interference		<ul style="list-style-type: none"> • Check if the source of interference is shielded correctly. • Move these kinds of electrical devices away from the unit. 	

TROUBLESHOOTING (continued)

Symptom and Checklist (continued)

Symptoms	Checklist	Page
<ul style="list-style-type: none"> Normal picture, but no sound 	<ul style="list-style-type: none"> Check the volume level. Check audio settings on HDMI source must be set to PCM. Check if the  button has been pressed or not. Check the connections to external equipment. Check if input signal is HDMI or DVI by pressing the  button, remember DVI must be connected on HDMI 2 and audio must be input by separate. 	<p> </p>
<ul style="list-style-type: none"> No picture - normal sound 	<ul style="list-style-type: none"> Check the level of "Brightness" and "Contrast" in UT Monitor "Picture Menu". 	
<ul style="list-style-type: none"> The remote control does not work. 	<ul style="list-style-type: none"> Check if the batteries are installed correctly. The batteries might be exhausted. Replace them with new ones. Remove all obstructions from in front of the sensor window on the unit. 	<p></p>
<ul style="list-style-type: none"> Picture Freeze and/or the buttons on both the remote control and control panel do not work. 	<ul style="list-style-type: none"> Unplug and connect after 5 minutes the power cord or turn Main switch Off and On after 5 minutes both A/V Center and UT Monitor. Hold down the Reset button on the UT Monitor control panel for over a second. 	
<ul style="list-style-type: none"> Normal picture but no color-normal sound 	<ul style="list-style-type: none"> Check the connections to external equipment. 	<p></p>
<ul style="list-style-type: none"> No picture UT Monitor Indicating lamp → Off 	<ul style="list-style-type: none"> Check if the power cord is plugged into the socket securely for UT Monitor. Check if the main switch is on for UT Monitor. 	<p></p>
<ul style="list-style-type: none"> No picture UT Indicating lamp → Orange It means that UT monitor is in "Power Save mode". 	<ul style="list-style-type: none"> Check if the A/V Center to UT Monitor cable is connected correctly and securely. Check if the power of the A/V Center is ON. Refer to "When the Following Messages Appears on the Screen". 	<p> </p>
<ul style="list-style-type: none"> No picture UT Monitor indicating lamp → Green 	<ul style="list-style-type: none"> Check if the signal cable is connected correctly and securely. Check if the A/V Center to UT Monitor cable is connected correctly and securely. Adjust the level of Brightness and Contrast lower. 	<p></p>
<ul style="list-style-type: none"> The top of the unit and surface of the panel heat up. 	<ul style="list-style-type: none"> This may occur if you use the unit for a long time. Turn off the main power to the unit for a while. Please note that this is not a malfunction. 	
<ul style="list-style-type: none"> Some screen display aspects are not possible. 	<ul style="list-style-type: none"> Check the signal status by pressing the  button on the remote control. The available screen display aspect is different depending on the current signal status. 	<p></p>
<ul style="list-style-type: none"> Image cannot be displayed from HDMI input. 	<ul style="list-style-type: none"> Check if the cables are connected correctly. Turn off A/V Center and HDMI source, then turn A/V Center on first then HDMI source. Check the output format of the equipment. (Please refer to "CONNECTION" and "Recommended Signal List".) 	<p></p>
<ul style="list-style-type: none"> Some digital programming looks blurry during fast changing scenes.. 	<ul style="list-style-type: none"> This is normal and its due regular digital compression scheme, please note this is not a malfunction. 	
<ul style="list-style-type: none"> Turns Off by itself 	<ul style="list-style-type: none"> Check or ensure Timer settings are not activated. 	<p></p>
<ul style="list-style-type: none"> Picture may "block" or freeze when watching a digital channel. 	<ul style="list-style-type: none"> Check signal strength and noise levels under "Signal Meter" 	<p></p>
<ul style="list-style-type: none"> No sound from TV Optical Out when using HDMI devices 	<ul style="list-style-type: none"> Change Digital Output selection. As an option, use audio optical output from HDMI source device directly to separate Audio Amplifier 	<p></p>
<ul style="list-style-type: none"> Picture flickers during channel change w/using HDMI Set Top Boxes 	<ul style="list-style-type: none"> This is normal operation from the source switching delay itself. It's not an indicator of a TV malfunction. 	

PRODUCT SPECIFICATIONS

SPECIFICATION			
A/V Center dimensions		231(D) x 297(W) x 66(H) mm or less 9 1/16(D) x 11 11/16(W) x 2 9/16(H) in	
Net weight		2.2 kg/ 4.85 lbs	
Ambient conditions	Temperature	Operating : 0°C to 40°C, Storage : -15°C to 60°C	
	Relative humidity	Operating : 20% to 80%, Storage : 20% to 90% (non-condensing)	
Power supply		AC120V, 60Hz	
Power consumption/ at standby		22 W, 0.26 A/< 0.5 W	
FCC Class		B for Consumer Use	
Input Terminals	1 Integrated Tuner		NTSC/ATSC/8VSB/64QAM/256QAM
	2 Composite Video and L/R Audio	Video	Composite 1.0 +/- 0.2 Vp-p Input Impedance: 75 Ohm +/- 10%
		Audio	470 mVrms, Max.: 2 Vrms or less Input Impedance: 270KOhm or more
	2 Component Video and L/R Audio	Video	Luminance (Y): 1.0 +/- 0.2 Vp-p PBPR: 0.7 +/-0.14 Vp-p
	3 HDMI V.1.3a		Resolution: 480i/480p/720p/1080i/1080p (Deep Color, x.v.Color™, Lip Sync, CEC, HDCP (High Bandwidth Digital Content Protection))
	USB 1.1		For S/W Upgrade only
Output Terminals	1 HDMI V.1.3a		Resolution: 1080i/1080p (Deep Color,x.v.Color™, Lip Sync, CEC, HDCP (High Bandwidth Digital Content Protection))
	Digital Audio		Optical
Front Key	Power On/Of switch	Yes	
	Power Indicator LED	2 LED's: StandBy (Red) / On (Blue)	

Dimensions

Units: mm (inches)

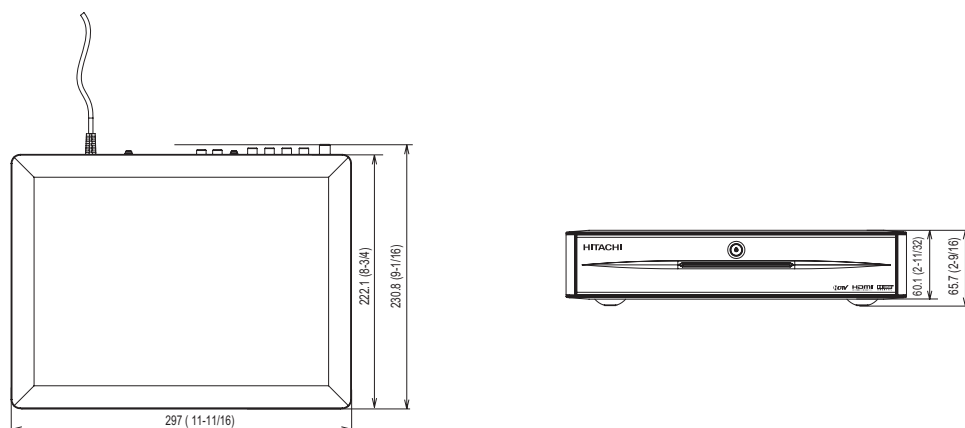

PRODUCT SPECIFICATIONS (continued)

Signal Input

HDMI connector pin specifications

Pin	Input signal	Pin	Input signal
1	TMDS Data2+	11	TMDS Clock Shield
2	TMDS Data2 Shield	12	TMDS Clock-
3	TMDS Data2-	13	CEC
4	TMDS Data1+	14	Reserved(N.C. on device)
5	TMDS Data1 Shield	15	SCL
6	TMDS Data1-	16	SDA
7	TMDS Data0+	17	DDC/CEC Ground
8	TMDS Data0 Shield	18	+5V Power
9	TMDS Data0-	19	Hot Plug Detect
10	TMDS Clock+		

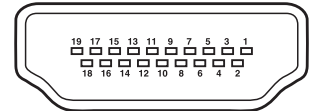

Recommended Signal List

With HDMI input

No.	Signal mode		
	Signal Name	Resolution	Vertical frequency (Hz)
1	VGA	640 X 480	59.94
3	480i	720(1440) X 480	59.94
5	480p	720 X 480	59.94
6	1080i/59.94	1920 X 1080	59.94
7	1080i/60	1920 X 1080	60.00
8	720p/59.94	1280 X 720	59.94
9	720p/60	1280 X 720	60.00
10	1080p/59.94	1920 X 1080	59.94
11	1080p/60	1920 X 1080	60.00
12	1080p/24	1920 X 1080	24.00

With Component input

With Composite input

480i(525i) @59.94/60Hz	-NTSC
480p(525p) @59.94/60Hz	480i(525i) @59.94Hz
1080i(1125i) @59.94/60Hz	
720p(750p) @59.94/60Hz	

SERVICE INFORMATION

800.HITACHI
(800.448.2244)

Operational, hook up and
warranty questions for your product.

Monday ~ Sunday
8:00 am - 8:30 pm CST

www.hitachi.us/tv



Sincere - Prompt - Efficient

HITACHI
Inspire the Next

HITACHI HOME ELECTRONICS (AMERICA), INC.

HITACHI has made every effort to assure you hours of trouble free operation from your Hitachi product. Should you require service assistance with **OPERATIONAL, HOOK UP, TECHNICAL ASSISTANCE OR WARRANTY SUPPORT**, please contact our Support Hotline at **800.HITACHI (800.448.2244)**.

Our Support Hotline will provide you with the assistance you need and if necessary the location of the nearest Authorized Service Facility in your area. Please present proof of purchase and/or delivery receipts to the Hitachi Authorized Service Facility and service will be rendered in accordance with the terms of the limited warranty as stated on your warranty card or operating guide.

**Hitachi Home Electronics
(America), Inc.**
Customer Service Support
PO Box 3900
Peoria, IL 61612
customerservice.ce@hhea.hitachi.com

HITACHI HOME ELECTRONICS (CANADA)

Should you have any questions regarding warranty, service, operation or technical assistance, please contact:

In Canada: 800.HITACHI (800.448.2244)

Monday~ Friday 9:00 am – 7:00 pm EST
Saturday 9:00 am – 5:00 pm EST

Pour de plus amples renseignements sur le service durant la période couverte par la garantie, sur le fonctionnement ou pour de l'assistance technique communiquez avec:

Au Canada: 800.HITACHI (800.448.2244)

Lundi~ Vendredi 9:00 am – 7:00 pm L'EST
Samedi 9:00 am – 5:00 pm L'EST

Hitachi Home Electronics (Canada)
Customer Service Support
PO Box 3900
Peoria, IL 61612

Customer Record

The MODEL NAME and SERIAL NUMBER of this product is located underneath the set. Please follow the next steps to find this information and then record it in the space provided below for use in case you call 800.HITACHI, they will require this information in order to give you the proper support.

- ① Look on the **BOTTOM** side of the set
- ② Locate the label where it shows the information related to **MODEL NAME** and **SERIAL #**.
- ③ 800.HITACHI will require this information in order to give you the proper support regarding your questions.

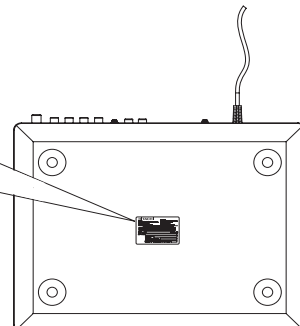
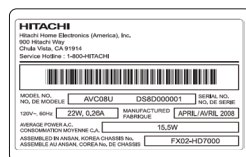

Model Name _____

Serial Number _____

LIMITED WARRANTY

Congratulations on your purchase of a new Hitachi display product.
Register your product online at www.hitachi.us/tv or mail the included warranty registration card:

LIMITED WARRANTY
Hitachi Home Electronics (America), Inc. warrants this product in accordance with the terms and conditions applicable to the Products identified below:

Conditions of Hitachi Limited Warranty
This Hitachi display product (the "Product") is warranted to be free from defects in materials and workmanship beginning on the date of purchase by the original owner and continuing for the duration of the applicable time periods specified below. If the Product is found to be defective, Hitachi will repair or replace (at Hitachi's option) defective parts at no charge, subject to the conditions of this Limited Warranty. If the original owner rejects, refuses or otherwise does not accept Hitachi's offer to repair or replace such defective parts under this Limited Warranty, this Limited Warranty shall be void and of no further force or effect. This Limited Warranty extends to the original owner only and is not transferable, and such owner must provide a dated sales receipt for the Product to qualify for parts or service under this Limited Warranty. The original owner must notify Hitachi of a defect claim during the applicable Limited Warranty period for this Limited Warranty to be effective. This Limited Warranty is valid only in the U.S.A. and Puerto Rico.

LCD Flat Panel Televisions
LCD Flat Panel Monitors
Plasma Televisions
Plasma Monitors
Audio Video Center

PARTS: The Limited Warranty period for parts is 1 year from the date of original purchase. During the Limited Warranty period for parts, Hitachi will replace defective parts with new or rebuilt parts (at Hitachi's option) at no charge for such parts. Any replacement part will be warranted for the remainder of the original warranty period applicable to the part replaced.

LABOR: The Limited Warranty period for labor is 1 years from the date of original purchase. During the Limited Warranty period for labor, Hitachi will repair or replace (at Hitachi's option) defective parts without charge for labor.

SERVICE LOCATION: In-home warranty service, which includes either in-home repair or free pick-up and delivery (at Hitachi's option), applies to all Products except: (i) 26-inch and smaller LCD Flat Panel Televisions or LCD Flat Panel Monitors; (ii) Products located outside the U.S.A. or Puerto Rico; (iii) Products located more than seventy-five (75) driving miles from Hitachi's nearest Authorized Service Facility. If the foregoing clauses (i), (ii), (iii) apply, then the Product owner will be responsible for bringing/delivering the Product to a Hitachi Authorized Service Facility and, following warranty service, retrieving the Product from such Authorized Service Facility.



Hitachi is a proud supporter of the Certified Service Center program. Businesses who display the CSC certification mark have demonstrated that they operate in accordance with the high standards of professionalism prescribed by the Consortium for Certified Service Centers.

800-HITACHI (800-448-2244)

Please call 800-HITACHI (800-448-2244) for operational, hook up, warranty questions or the location of your nearest Hitachi Authorized Service Facility or Parts Distributor.

Visit our website and register your product online:

Hitachi's website features a wealth of information on Hitachi products and technologies, as well as downloadable operating guides and other useful information.

To register your new Hitachi display product online, go to:
www.hitachi.us/tv Support and Contact/Warranty Registration

IMPORTANT:

Before using or installing your Product, please complete this form and attach your sales receipt and retain them for your records. This will help facilitate proper warranty coverage.

MODEL NO.	SERIAL NO.
DEALER NAME	DATE OF PURCHASE
DEALER ADDRESS	
CITY	STATE

Warranty Limitations

This Hitachi Limited Warranty does not cover:

- A. Any Product that has been modified or repaired in a manner not previously authorized by Hitachi in writing.
- B. Any Product whose serial number has been removed, altered, replaced, defaced or rendered illegible.
- C. Any defect, malfunction, or failure caused by or resulting from improper or unauthorized service, maintenance or repair.
- D. Damage resulting from abuse, misuse, mishandling, neglect or damage caused by exposure to hostile operating environments such as areas containing dust and/or smoke.
- E. Damage caused by power surges, accidents, natural disasters or any other events or circumstances outside Hitachi's control.
- F. Any Product used in any manner inconsistent with the acceptable set-up, usage, safety or installation configurations identified in the Product's Operating Guide.
- G. Any Product used for purposes or applications, or subjected to operating conditions, other than those identified as acceptable in the Product's Operating Guide.
- H. Product repairs (including any product whose case has been opened), or part replacements provided or installed, by any person other than an Authorized Hitachi Service Facility Representative.
- I. Improper uncrating, set-up or installation or any misadjustments caused by user-operated controls.
- J. Any labor or costs associated with removing the Product from a custom cabinet or other specialized product installation that impedes direct and immediate removal of the Product from the owner's premises (must be arranged and paid by the owner).
- K. Product cabinets, cabinet parts, knobs, batteries or accessories.
- L. Product screens that have been cleaned by any method other than as specified in the Product's Operating Guide.
- M. Normal usage, degraded brightness caused by backlight aging and/or cell defects or ordinary wear and tear, including, without limitation, scratches or marks on the Product's screen, cabinet or the appearance of bright or dark screen pixels.
- N. Any Product returned for service that is damaged due to improper packaging, mishandling or shipping. (IMPORTANT: When shipping any Product to a Hitachi Authorized Service Centers, Product owner must package it securely in the original shipping container or its equivalent to prevent damage. The Product must be returned with the shipping charges prepaid and proof of purchases included in the shipping container. Failure to properly package such product during such shipment will void all warranties.)
- O. Any Product purchased or serviced outside the United States of America and Puerto Rico.
- P. Any Product that has been used for commercial purposes.

NO PERSON, AGENT, DISTRIBUTOR, DEALER, SERVICE FACILITY, OR COMPANY IS AUTHORIZED TO CHANGE, MODIFY OR AMEND THE TERMS OF THIS LIMITED WARRANTY IN ANY MANNER WHATSOEVER. EXCEPT AS PROVIDED IN THIS LIMITED WARRANTY, HITACHI MAKES NO EXPRESS WARRANTY REGARDING THIS HITACHI PRODUCT. FURTHER, ALL IMPLIED WARRANTIES RELATING TO ANY PORTION OF THIS PRODUCT, INCLUDING ANY WARRANTY OF MERCHANTABILITY OR FITNESS FOR A PARTICULAR PURPOSE, ARE LIMITED TO THE DURATION SPECIFIED UNDER THIS LIMITED WARRANTY. HITACHI SHALL NOT BE LIABLE TO THE PURCHASER OR TO ANY OTHER PERSON FOR ANY INCIDENTAL OR CONSEQUENTIAL DAMAGES OR LOSS OF PROFIT OR PRODUCT RESULTING FROM ANY DEFECT IN, OR MALFUNCTION OR FAILURE OF, THIS HITACHI PRODUCT. BECAUSE SOME STATES DO NOT ALLOW LIMITATIONS ON HOW LONG AN IMPLIED WARRANTY LASTS, OR THE EXCLUSION OF INCIDENTAL OR CONSEQUENTIAL DAMAGES, THE ABOVE LIMITATIONS MAY NOT APPLY TO YOU. THIS LIMITED WARRANTY CONFERS SPECIFIC LEGAL RIGHTS, INCLUDING CERTAIN OTHER RIGHTS THAT MAY VARY DEPENDING ON YOUR JURISDICTION.

END USER LICENSE AGREEMENT FOR HITACHI SOFTWARE

END USER LICENSE AGREEMENT FOR HITACHI SOFTWARE

IMPORTANT – READ CAREFULLY: This End User License Agreement for **HITACHI** Software (this “Agreement”) is a legal agreement between you (“you” or “your”), in your capacity as the owner of a **HITACHI** brand display product (the “Product”), and **HITACHI** Home Electronics (America), Inc. (“**HITACHI**”). By using the Product or the **HITACHI** software installed on the Product (the “**HITACHI** Software”) or any Upgrade (as defined below, and together with the **HITACHI** Software, the “Software”), you agree to be bound by the terms and conditions of this Agreement. IF YOU DO NOT AGREE TO BE BOUND BY THIS LICENSE AGREEMENT, DO NOT USE THE PRODUCT OR THE SOFTWARE.

1. **LICENSE GRANT.** **HITACHI** grants to you, for the life of the Product, a non-exclusive, non-transferable, revocable license to install and use one copy of the Software on the Product, subject to the following limitations and restrictions:
 - a. You may not share, duplicate, republish or redistribute the Software;
 - b. You may not resell, rent, lease, sublicense, gift, loan, as sign or otherwise transfer the Software or any of your rights under this Agreement;
 - c. You may not modify, adapt, translate, reverse engineer, decompile, disassemble or make derivative works from the Software or use the Software in combination with any non-Hitachi software; and
 - d. You may not use the Software for any commercial purpose.
2. **VIOLATIONS; INDEMNITY.** You understand and agree that your use of the Software in any manner except as permitted under this Agreement could constitute a serious crime and could subject you to damages and an award to **HITACHI** of attorneys’ fees in connection with your violation of this Agreement. You further understand that you may be held legally responsible for any copyright infringement or other violation of intellectual property rights caused or facilitated by your failure to abide by the terms of this Agreement. You agree to defend, indemnify and hold **HITACHI** and its parent and affiliate companies harmless from and against any and all liability resulting from any breach by you of this Agreement.
3. **INTELLECTUAL PROPERTY.** The Software is protected by federal copyright laws, international copyright treaties and other intellectual property laws and treaties. The Software is licensed, not sold, to you. All right, title and interest in and to the Software and any intellectual property associated therewith, including any accompanying printed materials, shall belong to **HITACHI** and its licensors and suppliers. Except as expressly provided herein, neither **HITACHI** nor any of its licensors or suppliers grants to you under this Agreement any express or implied right in or to any patents, copyrights, trademarks, trade secrets or other intellectual property. All right, title and interest in and to the intellectual property rights associated with any content that is accessible through use of the Software shall belong to the applicable content owners and may be protected by copyright or other intellectual property laws and treaties. This Agreement grants you no rights to use such content. Any rights of **HITACHI** not expressly granted to you hereunder are reserved expressly by Hitachi.
4. **SOFTWARE UPGRADES.** In the future, **HITACHI** may release or make available one or more upgrades to the **HITACHI** Software (each, an “Upgrade”). You understand and agree that if you decide to install or use any Upgrade, your installation and use of such Upgrade and/or any other software or intellectual property **HITACHI** may provide in connection therewith shall be governed by the terms and conditions of this Agreement, except to the extent that **HITACHI** provides different or supplementary license terms or conditions that accompany such Upgrade or other software or intellectual property. In the event **HITACHI** provides you with a “flash card” or other media to effect or facilitate an Upgrade, you understand and acknowledge that your failure to return such flash card or other media to **HITACHI** as **HITACHI** may require could result in **HITACHI** placing your name and your Product’s serial number on a “No Further Upgrades” list, which will prohibit you from receiving any subsequent Upgrades **HITACHI** may later release or make available. IF YOU DO NOT AGREE WITH ALL THE TERMS AND CONDITIONS OF THIS AGREEMENT OR ALL THE TERMS AND CONDITIONS OF ANY DIFFERENT OR SUPPLEMENTARY LICENSE THAT MAY ACCOMPANY SUCH UPGRADE, (A) DO NOT USE ANY **HITACHI**-PROVIDED FLASH CARD OR OTHER MEDIA, (B) DO NOT PERFORM INSTALL ANY **HITACHI**-PROVIDED UPGRADE SOFTWARE ON YOUR PRODUCT, AND (C) PROMPTLY RETURN SUCH FLASH CARD OR OTHER MEDIA TO **HITACHI**.
5. **EXPORT RESTRICTIONS.** **HITACHI** is licensing the Software for use within North America only. You agree that you will not export or re-export the Software. You specifically agree not to export or reexport the Software: (i) to any country to which the U.S. has embargoed or restricted the export of goods or services, which currently include, but are not necessarily limited to Cuba, Iran, Libya, North Korea, Sudan and Syria, or to any national of any such country, wherever located, who intends to transmit or transport the Software back to such country; (ii) to any person or entity who you know or have reason to know will utilize the Software in the design, development, or production of nuclear, chemical, or biological weapons; or (iii) to any person or entity who has been prohibited from participating in U.S. export transactions by any federal agency of the U.S. government. You warrant and represent that neither the U.S. Bureau of Industry and Security nor any other U.S federal Agency has suspended, revoked, or denied your export privileges.
6. **NO WARRANTIES.** The software is provided to you in “as is” condition and **HITACHI** makes no warranties of any kind whatsoever regarding the software and, to the maximum extent permitted by law, hereby expressly disclaims all warranties of any kind whatsoever, express or implied, with respect to the software. All implied warranties, including without limitation, the implied warranties of non-infringement, merchantability and fitness for a particular purpose are hereby expressly disclaimed by **HITACHI** to the maximum extent permitted by law.
7. **LIMITATION OF LIABILITY.** To the maximum extent permitted by applicable law, **HITACHI**, its licensors, suppliers, parent companies, affiliates, subsidiaries, employees and agents shall not under any circumstances be liable to you or any third parties for any damages of any nature arising in any way from this agreement, your use of the software or otherwise, whether indirect, special, incidental, consequential or otherwise, including, without limitation, any claims for lost profits, lost good will, lost data, business interruption, procurement of substitute goods or services, or expenditures made or committed for in reliance on the continuation of this agreement, even if advised in advance of the possibility of such damages.
8. **NO FAILURE OF ESSENTIAL PURPOSE.** You agree that neither **HITACHI’S** breach of this agreement nor its failure to repair a defect, error or bug in the software shall constitute a failure of the essential purpose of this agreement.
9. **CRYPTOGRAPHIC SOFTWARE.** The software contains software developed by the OpenSSL Project, including cryptographic software written by Eric Young (the “cryptographic software”). The cryptographic software is provided by the OpenSSL Project in “as is” condition and any express or implied warranties, including but not limited to, the implied warranties of merchantability and fitness for a particular purpose are hereby expressly disclaimed to the maximum extent permitted by law. In no event shall the OpenSSL Project, its contributors, **HITACHI** or any of its parent or affiliate companies be liable for any direct, indirect, incidental, special, exemplary, or consequential damages (including, but not limited to, procurement of substitute goods or services; loss of use, data, or profits; or business interruption) however caused and on any theory of liability, whether in contract, strict liability, or tort (including negligence or otherwise) arising in any way out of the use of the software or the cryptographic software, even if advised in advance of the possibility of such damages.
10. **TERMINATION.** **HITACHI** may terminate this Agreement immediately at any time by providing notice to you.
11. **GOVERNING LAW; SEVERABILITY.** This Agreement will be governed by the laws of the State of New York, and you consent to the exclusive jurisdiction and venue in the federal courts sitting in the Southern District of New York, unless no federal subject matter jurisdiction exists, in which case you consent to the exclusive jurisdiction and venue in the Borough of Manhattan, New York, USA.