

HITACHI

Inspire the Next

Instruction Manual



DZ-GX3300A/DZ-GX3200A
DZ-GX3100A/DZ-BX37A/DZ-BX35A

DVD-RAM DVD-RW

DVD-R +RW

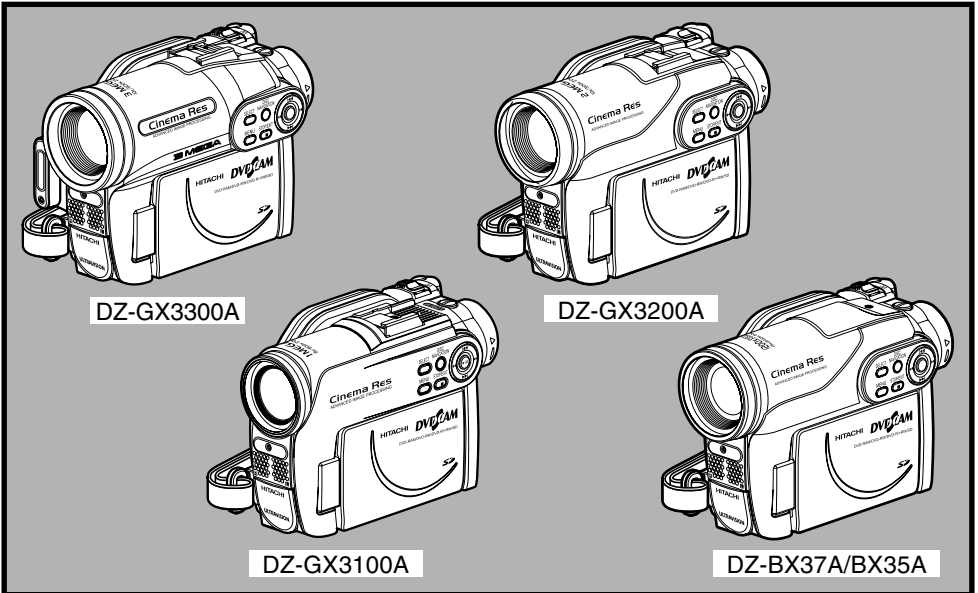

Instruction manual

To obtain the best performance and ensure years of trouble-free use, please read this instruction manual completely.

Mode d'emploi

Des performances optimales et un fonctionnement à long terme seront assurés en appliquant les présentes instructions après avoir entièrement lu ce mode d'emploi.

Manual de instrucciones

Para obtener el mejor funcionamiento y asegurar muchos años de utilización exenta de problemas, lea todo este manual de instrucciones.

English

Español

Français

Important Information

For Your Safety

The power switch turns the DVD video camera/recorder on and off, leaving the date/time feature unaffected. If the camera/recorder is to be left unattended for a long period of time, turn it off.

WARNING: TO PREVENT FIRE OR SHOCK HAZARD, DO NOT EXPOSE THIS UNIT TO RAIN OR MOISTURE.

WARNING: TO PREVENT FIRE OR SHOCK HAZARD, USE THE RECOMMENDED ACCESSORIES ONLY.



WARNING: TO PREVENT FIRE OR SHOCK HAZARD, BE SURE TO USE THE SPECIFIED AC ADAPTER/CHARGER (DZ-ACS3).

The DVD video camera/recorder and AC adapter/charger have the following caution marks.



CAUTION

**RISK OF ELECTRIC SHOCK
DO NOT OPEN**



CAUTION: TO REDUCE THE RISK OF ELECTRIC SHOCK, DO NOT OPEN. NO USER-SERVICEABLE PARTS INSIDE. REFER SERVICING TO QUALIFIED SERVICE PERSONNEL.

Identifications of caution marks



This symbol warns the user that uninsulated voltage within the unit may have sufficient magnitude to cause electric shock. Therefore, it is dangerous to make any kind of contact with any inside part of this unit.



This symbol alerts the user that important literature concerning the operation and maintenance of this unit has been included. Therefore, it should be read carefully to avoid any problems.

Precautions

WARNING: Many television programs and films are copyrighted. In certain circumstances, copyright law may apply to private in-home videotaping of copyrighted materials.

This Class B digital apparatus complies with Canadian ICES-003.

The liquid crystal display (LCD) panel is made by highly precise technology. More than 99.99% of its picture elements (pixels) are effective, but some (less than 0.01%) may appear as colored bright dots. This does not indicate a fault as the LCD panel stretches the limits of current technology.

**CLASS 1
LASER PRODUCT**

CAUTION

This product contains a laser diode of higher class than 1. To ensure continued safety, do not remove any covers or attempt to gain access to the inside of the product. Refer all servicing to qualified personnel.

Warning: This device complies with Part 15 of the FCC Rules. Operation is subject to the following two conditions: (1) This device may not cause harmful interference, and (2) this device must accept any interference received, including interference that may cause undesired operation.

Note: This equipment has been tested and found to comply with the limits for a Class B digital device, pursuant to Part 15 of the FCC Rules. These limits are designed to provide reasonable protection against harmful interference in a residential installation. This equipment generates, uses, and can radiate radio frequency energy and, if not installed and used in accordance with the instructions, may cause harmful interference to radio communications. However, there is no guarantee that interference will not occur in a particular installation. If this equipment does cause harmful interference to radio or television reception, which can be determined by turning the equipment off and on, the user is encouraged to try to correct by one or more of the following measures:

- Reorient or relocate the receiving antenna.
- Increase the separation between the equipment and receiver.
- Connect the equipment into an outlet on a circuit different from that to which the receiver is connected.
- Consult the dealer or an experienced radio/TV technician for help.

Caution to the user: Changes or modifications not expressly approved by the manufacturer void the user's authority to operate the equipment.

Microsoft®, Windows®, Windows® Me, Windows® 2000 Professional, and Windows® XP are registered trademarks of Microsoft Corporation.

Intel®, Pentium® Processor, and Celeron® Processor are registered trademarks of Intel Corporation. Macintosh is a trademark of Apple Computer, Inc.

IBM® and PC/AT® are registered trademarks of International Business Machines Corporation.

Manufactured under license from Dolby Laboratories.

“Dolby” and the double-D symbol are trademarks of Dolby Laboratories.

Other company names and product names listed are trademarks or brand names belonging to each individual company.

SD logo is a trademark.

IMPORTANT SAFETY INSTRUCTIONS

In addition to the careful attention devoted to quality standards in the manufacture of your video product, safety is a major factor in the design of every instrument. But, safety is your responsibility too.

This page lists important information that will help to assure your enjoyment and proper use of DVD video camera/recorder and accessory equipment.

- 1** Read these instructions.
- 2** Keep these instructions.
- 3** Heed all warnings.
- 4** Follow all instructions.
- 5** Do not use this apparatus near water.
- 6** Clean only with dry cloth.
- 7** Do not block any ventilation openings. Install in accordance with the manufacturer's instructions.
- 8** Do not install near any heat sources such as radiators, heat registers, stoves, or other apparatus (including amplifiers) that produce heat.
- 9** Protect the power cord from being walked on or pinched particularly at plugs, convenience receptacles, and the point where they exit from the apparatus.
- 10** Only use attachments/accessories specified by the manufacturer.
- 11** Use only with the cart, stand, tripod, bracket, or table specified by the manufacturer, or sold with the apparatus. When a cart is used, use caution when moving the cart/apparatus combination to avoid injury from tip-over.

S3125A
- 12** Unplug this apparatus during lightning storms or when unused for long periods of time.
- 13** Refer all servicing to qualified service personnel. Servicing is required when the apparatus has been damaged in any way, such as power-supply cord or plug is damaged, liquid has been spilled or objects have fallen into the apparatus, the apparatus has been exposed to rain or moisture, does not operate normally, or has been dropped.
- 14** The apparatus shall not be exposed to dripping or splashing and that no objects filled with liquids, such as vases, shall be placed on the apparatus.
- 15** The equipment (AC Adapter/Charger) shall be used near the socket-outlet and shall be easily accessible.

Cautions When Using

Handle the liquid crystal display (LCD) with care:

- The LCD is a very delicate display device: Do not press its surface with force, hit it or prick it with a sharp object.
- If you push the LCD surface, unevenness in display may occur. If unevenness does not disappear soon, turn the DVD video camera/recorder off, wait for a few moments, and then turn it on again.
- Do not place the DVD video camera/recorder with the open LCD screen down.
- Close the LCD monitor when not using the DVD video camera/recorder.

Liquid crystal display (LCD) and viewfinder:

- The LCD screen and viewfinder are the products of highly precise technology. Among the total number of pixels (approx. 120,000 pixels for LCD monitor and equivalent to approx. 200,000 pixels for viewfinder), 0.01% or less pixels may be missing (black dots) or may remain lit as colored dots (red, blue, green). This shows the limitations of the current technology, and does not indicate a fault that will interfere with recording.
- The LCD screen and viewfinder will be slightly dimmer than usual when the DVD video camera/recorder is at low temperature, as in cold areas, or immediately after power is turned on. Normal brightness will be restored when the temperature inside the DVD video camera/recorder rises.

Hold the DVD video camera/recorder correctly:

- Do not hold the viewfinder or LCD monitor when lifting the DVD video camera/recorder: The viewfinder or LCD monitor could detach and the DVD video camera/recorder may fall.

Do not subject the DVD video camera/recorder to impact:

- This DVD video camera/recorder is a precision machine. Take great care that you do not strike it against a hard object or let it fall.
- When using a tripod, firmly secure the DVD video camera/recorder on it. Do not use the DVD video camera/recorder with a tripod in a place where it is subject to severe vibrations or impact.

No sand or dust!

- Fine sand or dust entering the DVD video camera/recorder or AC adapter/charger could cause malfunctions or defects.

No water or oil!

- Water or oil entering the DVD video camera/recorder or AC adapter/charger could cause electric shock, malfunctions or defects.

Heat on surface of product:

- The surfaces of the DVD video camera/recorder, AC adapter/charger and battery will be slightly warm, but this does not indicate a fault.

Screen on connected TV:

- Never leave the disc navigation screen, still image or camera image displayed on your TV to which the DVD video camera/recorder is connected: Doing so could result in displayed image retention or phosphor degradation of TV screen.

Be careful of ambient temperature:

- Using the DVD video camera/recorder in a place where the temperature is over 104°F (40°C) or under 32°F (0°C) will result in abnormal recording/playback.
- Take care that the temperature of this DVD video camera/recorder, when connected to PC does not rise excessively (reference for usage: approx. 30 minutes at about 86°F (30°C)).
- Do not leave the DVD video camera/recorder on beach sand or in a closed vehicle where the temperature is very high for a long time: This could cause malfunctions.

Do not point directly at the sun:

- If direct sunlight strikes the lens or viewfinder, the DVD video camera/recorder could malfunction or a fire could occur.
- Do not leave the DVD video camera/recorder with the LCD screen exposed to direct sunlight: This could cause malfunctions.

Do not use the DVD video camera/recorder near TV or radio:

- This could cause noise to appear on the TV screen or in radio broadcasts.

Do not use the DVD video camera/recorder near strong radio waves or magnetism:

- If the DVD video camera/recorder is used near strong radio waves or magnetism, such as near a radio wave tower or electric appliances, noise could enter video and audio that are being recorded. During playback of normally recorded video and audio, noise may also be present in picture and sound.
At worst the DVD video camera/recorder could malfunction.

Do not expose the DVD video camera/recorder to soot or steam:

- Thick soot or steam could damage the DVD video camera/recorder case or cause malfunctions.

Do not use the DVD video camera/recorder near corrosive gas:

- If the DVD video camera/recorder is used in a place where there is dense exhaust gas generated by gasoline or diesel engine, corrosive gas such as hydrogen sulfide, or sulfur such as in a hot spring area, the external or internal terminals could corrode, which would disable normal operation, or the battery connecting terminals could corrode, so power will not turn on.

Do not use the DVD video camera/recorder near ultrasonic humidifier:

- With some water in humidifier, calcium and other chemicals dissolved in water could scatter in the air, and white particles could adhere to the optical head of the DVD video camera/recorder, which could cause it to operate abnormally.

Do not expose the DVD video camera/recorder to insecticide:

- Insecticide entering the DVD video camera/recorder could dirty the lens in laser pickup block, and in such a case the DVD video camera/recorder might not operate normally. Turn the DVD video camera/recorder off and cover it with vinyl sheet, etc. before using insecticide.

Do not use a generally available 8 cm CD lens cleaner:

- Cleaning the lens is not necessary when using this DVD video camera/recorder in the usual way.
- Using 8 cm CD lens cleaner could cause this DVD video camera/recorder to be faulty.
- If you have to clean the lens, use a Hitachi Maxell cleaner that is exclusively for 8 cm DVD discs.

Be careful of moisture condensation:

- When you move the DVD video camera/recorder between places where the difference in temperatures is great – such as entering a lodge from a ski slope or going out of a cooled room or vehicle – condensation (vapor in air warmed or cooled to water droplets) could occur on the lens and/or inside the DVD video camera/recorder. If condensation occurs, do not open the cover of disc or card insertion block if possible. If condensation occurs on the lens, wipe it off with a soft, dry cloth. Even if the external surface of DVD video camera/recorder has dried, condensation may remain inside: Turn the DVD video camera/recorder off and leave it in a dry place for at least 1 – 2 hours before using it again.

Do not use the DVD video camera/recorder for a long uninterrupted period of time:

- This DVD video camera/recorder cannot be used for a long time continuously as a surveillance camera/monitor. If you use it for a long continuous period of time, the temperature of DVD video camera/recorder could exceed the limit and the recording/playback operation may slow down or other faults could occur. If this happens, turn it off and wait for a while before using it again.

Do not turn the DVD video camera/recorder off while the ACCESS/PC indicator or CARD ACCESS indicator is lit or blinking:

- The ACCESS/PC or CARD ACCESS indicator is lit or blinking to show that data is being written to disc or card, or being read from it. At this time, do not do any of the following, so as not to damage the data:
 - Remove battery
 - Disconnect AC adapter/charger
 - Plug or unplug PC connection cable
 - Remove disc or card
 - Subject DVD video camera/recorder to severe vibrations or impact
 - Violently open or close the LCD monitor

The ACCESS/PC indicator will light for a while after recording is finished. While it is lit, do not subject the DVD video camera/recorder to any vibration or impact, and do not disconnect the battery or AC adapter/charger.

If you turn the DVD video camera/recorder off while the ACCESS/PC or CARD ACCESS indicator is lit or blinking, turn it on again with the disc or card loaded in it: Repair of the disc or card will be executed automatically (see page 133).

ACCESS/PC indicator

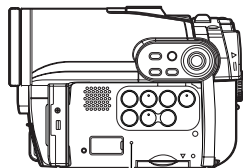
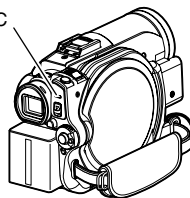

CARD ACCESS indicator

Do not wipe the DVD video camera/recorder case with benzene or thinner:

- The coating of case could peel off or the case surface could deteriorate.
- When using a chemical cleaning cloth, follow the instructions.

Also read the instructions attached with optional accessories:

- For optional accessories, observe the cautions and follow instruction manuals attached.

The battery provided has not been charged at time of purchase:

- Charge it before using the DVD video camera/recorder (see page 27).
- The battery will discharge as time passes. (The battery is produced so that it discharges on its own in order to protect its characteristics.)

Disc cannot be inserted or removed unless a charged battery or AC adapter/charger is connected to the DVD video camera/recorder.

Be sure to set the power switch to “OFF” when turning the DVD video camera/recorder off:

- Disconnecting the battery or AC adapter/charger while the DVD video camera/recorder is being powered could cause a fault.

Cautions When Storing

Do not leave the DVD video camera/recorder in a place where the temperature is very high for a long period of time:

- The temperature inside a closed vehicle or trunk can become very high in a hot season. If you leave the DVD video camera/recorder in such a place, it could malfunction or the case could be damaged. Also, do not expose the DVD video camera/recorder to direct sunlight or place it near a heater.

Do not store the DVD video camera/recorder in a place where the humidity is high or in a dusty place:

- Dust entering the DVD video camera/recorder could cause malfunctions. If the humidity is high, the lens could be moldy, and the DVD video camera/recorder could become inoperable. It is recommended that you put the DVD video camera/recorder with desiccant in a box when storing it in a closet, etc.

Do not store the DVD video camera/recorder in a place subject to strong magnetism or intense vibrations:

- This could cause malfunctions.

Detach the battery from the DVD video camera/recorder and store it in a cool place:

- Leaving the battery attached or storing it at high temperature could shorten its life.

Suggestions and Restrictions

Make a trial recording:

- Always make a trial recording before doing actual recording to make sure that recording is normal. The data that have not been stored normally because of a defect in the DVD video camera/recorder cannot be restored.

It is recommended that you use DVD-RAM disc from which recorded contents can be deleted for trial recording.

Do not use the DVD video camera/recorder for professional applications:

- This DVD video camera/recorder is designed and produced for home-use recording and playback.

The recorded contents cannot be compensated for:

- Hitachi cannot compensate for any damages caused when recording is not made normally or recorded contents cannot be played back because of a defect in the DVD video camera/recorder, disc or card. Also, Hitachi cannot be responsible for your recorded video and audio.
- If you or a third party make a mistake when handling this DVD video camera/recorder, disc, card, etc., the recorded contents may be lost. We cannot be responsible for compensation for damage due to loss of recorded contents.

Copyright:

- Data recorded on the disc or card in this DVD video camera/recorder using other digital/analog media or devices are protected by the copyright act and cannot be used without permission of the owner of copyright, except for personal enjoyment. Be aware that recording is restricted for some demonstrations, performances and exhibitions, even for personal enjoyment.

CLEANING

Be sure to set the power switch to "OFF" before cleaning this DVD video camera/recorder.

● Cleaning LCD screen and camera lens

Use dry, soft cloth to wipe dirt off. When cleaning the LCD screen, be careful not to use force, scratch it, or subject it to impact: Doing such could cause a defect in the screen, result in display unevenness, or damage the LCD monitor.

● If dust adheres to the viewfinder lens, remove it using a cotton swab, etc.

Do not rub the lens with force: Doing so could scratch the lens.

HANDLING DISCS

● Using discs

Discs are very delicate recording media. Carefully read the following cautions and observe them:

- Always use a brand new disc when recording important material.
- Be sure not to touch the recording surface of disc, or dirty or scratch it.
- **If there is dust, scratch, dirt on disc or if it is warped**, the following phenomena may occur:
 - Block noise in playback image
 - Momentary stop of playback image
 - Sound interrupted during playback, or abnormal sound
 - Blue thumbnail display* (Fig. 1)
 - Disc cannot correctly be recognized
 - Disc cannot be initialized
 - Delay between video and audio



Block noise

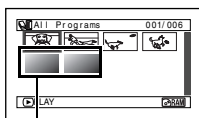

Fig. 1

Even if disc is normal, the above phenomena may occasionally occur. While the ACCESS/PC indicator is lit, do not subject disc to vibrations or impact, and avoid using DVD video camera/recorder at extremely high or low temperatures, or in environment where condensation is likely to occur.

● Do not use benzene or thinner to clean DVD video camera/recorder case

The coating of case could peel off or the case could deteriorate. Wipe off dirt on the case with a moist cloth which has been completely wrung out. When using chemical cleaning cloth, follow instructions for use.

- When recording images, the DVD video camera/recorder may avoid the portions of disc where recording is not possible, due to dust, scratches, etc. [It will pause ●II at such a portion and automatically restart recording (●REC).]

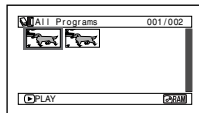

(Recording one scene may produce multiple thumbnails.)

- This will cause recording to be interrupted for several seconds to several minutes, and multiple thumbnails will be created by one recording session as shown above. In this case, the recordable time on disc will decrease.
- Be careful when removing the disc since the metal of removal slot of DVD video camera/recorder, and disc itself, may be hot.

● Storing discs

- When storing disc, replace it in the plastic case in which it was purchased.
- Be careful that no condensation occurs on disc.
- Do not place disc in following places:
 - Direct sunlight for a long time
 - Where humidity is high or in dusty place
 - While there is heat from a heater, etc.

DISC CLEANING

Use the disc cleaning cloth provided to lightly wipe off any dirt adhering to the disc as shown in the figure. Do not wipe the disc with force: Doing so could cause scratches.

Never use solvent (thinner, water, antistat or detergent) for cleaning.

Lightly wash the dirty cleaning cloth with detergent: The dirt removal capacity of the cloth will improve (rinse the cloth well with water so that no detergent remains).



Use the disc cleaning cloth to clean from inner to outer edges in axial direction.

Read This First

To guide you, we have included following five chapters.

- The section on “Setups” explains how to set up the DVD video camera/recorder, battery, and set the date/time.
- The section on “Basic Techniques” explains the basic operation of this DVD video camera/recorder – recording of movies, still images, external input, and playback of recorded images.
- The section on “Disc Navigation” explains editing with Disc Navigation: Refer to this section when finalizing DVD-RW/DVD-R/+RW disc and initializing DVD-RAM/DVD-RW/+RW disc.
- The section on “Connecting to PC” explains the contents of provided CD-ROM (DZ-GX3300A/GX3200A/GX3100A/BX37A) and how to install the software included.
- “Subsidiary Information” includes an introduction to products sold separately, and troubleshooting.

We want this manual to be as helpful as possible, so it includes two easy ways to find the information you need:

- A quick index for the information you use most often.
- A detailed table of contents directing you to specific information quickly (see pages 12 – 14).

Get to know your DVD video camera/recorder by using this manual, and get to know Hitachi. We appreciate your business.

Quick Index

Available Discs	24
Recording Movie	41
Playing Back	69
Functions Available with Disc Navigation.....	76
Connecting to a TV	106
Connecting to PC.....	112

With this DVD video camera/recorder you can view the picture being recorded or the playback picture whether on the LCD monitor or in the viewfinder. Opening or closing the LCD monitor switches the picture to appear on the LCD monitor or in the viewfinder.

It is possible to switch the language in the on-screen display of this DVD video camera/recorder (see page 34).

About This Manual

● Displays in this manual

Understand that the displays are different from those you will actually see in the viewfinder or on the LCD screen.

● Notation of cancel button

Press the STOP/EXIT button to stop your operation midway, or return the menu screen to the preceding one. The expression “press the ■ button” will be used in this text.

● , , , , and marks beside headings

Some functions of this DVD video camera/recorder are unavailable with disc or card used. Refer to the marks at right above each function to identify whether the disc or card is compatible with the function. Refer to these marks and identify the functions and operation to match the disc or card you use.

● Illustrations in this manual

Although the external appearances of DZ-GX3300A/GX3200A/GX3100A/BX37A/BX35A are different, the method of operating these models is identical.

The illustrations of DZ-GX3300A are used for the explanation in this text.

Recording (Dubbing) Images.....	109
RECORDING (DUBBING) IMAGES FROM OTHER VIDEO DEVICE.....	109
RECORDING (DUBBING) IMAGES ON OTHER VIDEO DEVICES.....	111

Connecting to PC (DZ-GX3300A/GX3200A/GX3100A/ BX37A)



Software Provided	112
Requirements of available PC	113
Installing Software	114
Connecting to PC via PC Connection Cable .	117
USING DISC IN DVD DRIVE BUILT INTO PC..	119
BEFORE TERMINATING PC CONNECTION (UNPLUGGING PC CONNECTION CABLE)/ CHANGING OVER POWER SWITCH	120
Using Software	121
[When using Windows]	
USING IMAGEMIXER 3	121
VIEWING IMAGES RECORDED ON DISC USING PC.....	121
CREATING DVD-VIDEO USING IMAGES RECORDED ON DISC	123
[When using Macintosh]	
USING PIXE VRF BROWSER EX AND IMAGEMIXER VCD/DVD2.....	126
IMPORTING IMAGES RECORDED ON DVD- RAM/DVD-RW/DVD-R INTO PC TO CREATE A DVD-VIDEO (DVD-RW/DVD-R)	126
Viewing Images recorded on Disc using PC..	129
Uninstalling Software	130
Cautions when connecting DVD video camera/ recorder to PC	131

Subsidiary Information

Introduction to Optional Accessories	132
CAMERA ACCESSORIES	132
POWER SUPPLY	132
Trouble Messages	133
Troubleshooting	139
System Reset	147
Major Specifications.....	148
SIZE AND QUALITY OF PHOTOS	152
RECORDABLE STILLS (PHOTOS) ON CARD.	153
To Order in the United States	154
To Order in the Canada	154
Index	155
Be sure to read the following before opening the package of CD-ROM.....	157

Checking Provided Accessories

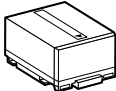
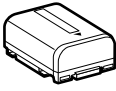
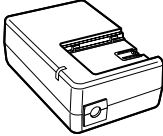
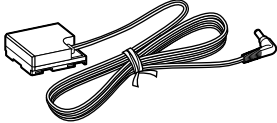
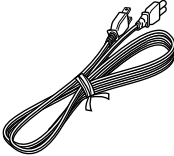
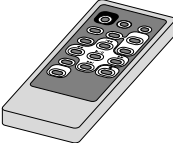
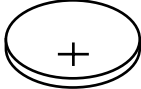
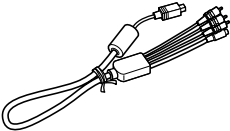
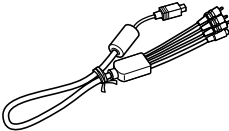
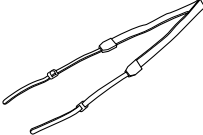
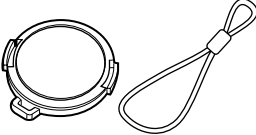
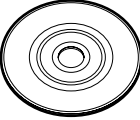
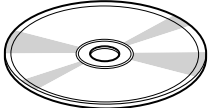
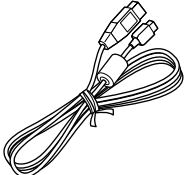
Make sure that you have all the following accessories in package:

<p>Battery (model DZ-BP14SW): For DZ-GX3300A/GX3200A only. Portable power supply for this DVD video camera/recorder. Charge it before use.</p> 	<p>Battery (model DZ-BP7S): For DZ-GX3100A/BX37A/BX35A only. Portable power supply for this DVD video camera/recorder. Charge it before use.</p> 	<p>AC adapter/charger (model DZ-ACS3): Used to power the DVD video camera/recorder from AC outlet, or charge battery.</p> 
<p>DC power cord: When powering the DVD video camera/recorder from household AC outlet, use this cord to connect the DVD video camera/recorder and AC adapter/charger.</p> 	<p>Power cable: Connect between household AC outlet and AC adapter/charger.</p> 	<p>Infrared remote control (model DZ-RM4W): Use to control the DVD video camera/recorder from a distance. For DZ-GX3300A/GX3200A/BX37A only.</p> 
<p>Lithium battery (model CR2032): To power the remote control. For DZ-GX3300A/GX3200A/BX37A only.</p> <p>WARNING: Keep this battery away from children. If swallowed, consult a physician immediately for emergency treatment.</p> 	<p>AV/S input/output cable: Used when viewing the picture played back on the DVD video camera/recorder on TV screen, or input or output video from/to another video device. For DZ-GX3300A/GX3200A/GX3100A.</p> 	<p>AV/S output cable: Used when viewing the picture played back on the DVD video camera/recorder on TV screen, or output video to another video device. For DZ-BX37A/BX35A only.</p> 
<p>Shoulder strap: Attach to the DVD video camera/recorder to hang it from shoulder.</p> 	<p>Lens cap and lens cap string: Attach the lens cap when not recording, to protect the lens.</p> 	<p>Single-sided 8 cm DVD-R disc: To record videos (movies) on this DVD video camera/recorder. For DZ-GX3300A/GX3200A only.</p> 
<p>Software CD-ROM: Use this CD-ROM when connecting the DVD video camera/recorder to PC. For DZ-GX3300A/GX3200A/GX3100A/BX37A only.</p> 	<p>PC connection cable: Use this cable when connecting the DVD video camera/recorder to PC. For DZ-GX3300A/GX3200A/GX3100A/BX37A only.</p> 	<p>Disc cleaning cloth: Always use this to clean discs.</p> 

Names of Parts

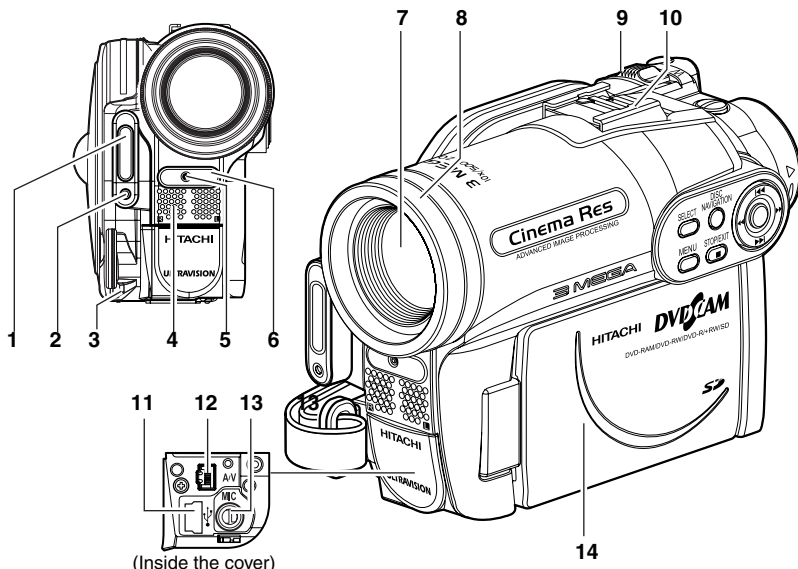

(Inside the cover)

- 1 Flash (for DZ-GX3300A only) (p. 56)**
- 2 Light receiving sensor (for DZ-GX3300A only)**
This sensor controls the amount of light to be emitted from the built-in flash. Take care not to block with hand, etc. during recording.
- 3 Lens cap string attachment hole (p. 21)**
- 4 Stereo microphone**
Take care that the microphone is not blocked by a hand, etc., during recording.
- 5 Recording indicator (p. 35)**
The red indicator will light during recording.
- 6 Infrared receiver (for DZ-GX3300A/GX3200A/BX37A only) (p. 22)**
When the remote control is used to operate the DVD video camera/recorder, this receiver will receive the infrared signal.
- 7 Optical 10× zoom lens (for DZ-GX3300A/GX3200A only)**
Optical 15× zoom lens (for DZ-GX3100A only)
Optical 25× zoom lens (for DZ-BX37A/BX35A only) (p. 51)
- 8 Lens hood (for DZ-GX3300A/GX3200A/BX37A/BX35A only) (p. 52)**
Always remove this lens hood when using the optional tele-conversion or wide-conversion lens.
- 9 Zoom lever (p. 51)**
Push the lever to the T side for telephoto, or to the W side for wide-angle.
- 10 Accessory shoe (for DZ-GX3300A/GX3200A only) (p. 56)**
The optional video flash can be attached here. (See the instruction manual of device to be attached for details.)
- 11 PC connection terminal (TO PC) (for DZ-GX3300A/GX3200A/GX3100A/BX37A only) (p. 117)**
- 12 AV input/output jack (p. 106)**
- 13 External microphone jack (for DZ-GX3300A/GX3200A/GX3100A only) (p. 66)**
- 14 Wide-screen color liquid crystal display (inside) (p. 32)**

Although the external appearances of DZ-GX3300A, DZ-GX3200A, DZ-GX3100A, DZ-BX37A and DZ-BX35A are different, the method of operating these models is identical. DZ-GX3300A illustrations are used in this manual.

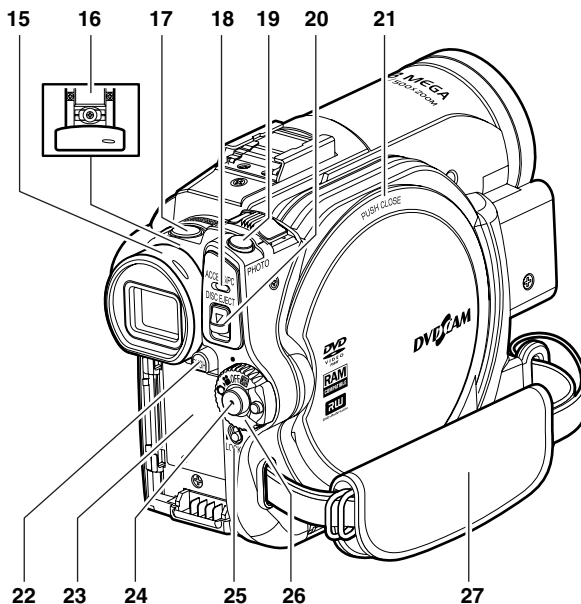

15 Viewfinder (p. 32)

16 Diopter control (p. 32)

To adjust the focus of image appearing in the viewfinder. (Pull out the viewfinder.)

17 SLEEP/RESTART button (p. 43)

To switch the sleep/restart status between ON and OFF.

**18 ACCESS/PC indicator
(for DZ-GX3300A/GX3200A/GX3100A/
BX37A only)**

**ACCESS indicator (for DZ-BX35A only)
(p. 7, 41, 42)**

Will blink or light when the disc in DVD video camera/recorder is accessed (write or read is executed) or the DVD video camera/recorder is connected to PC.

19 PHOTO button (p. 42)

20 DISC EJECT button (p. 38)

Press down and release this button to open the cover of disc insertion block.

21 Disc insertion block (p. 38)

22 BATTERY EJECT button (p. 28)

Press this button when removing the battery.

23 Battery attachment platform (p. 28)

24 Record button (REC) (p. 41)

25 LOCK switch (p. 41)

It is recommended that you set the LOCK switch to  (to the upper position) to prevent the power switch in the "ON" position from accidentally moving to "OFF".

26 Power switch (p. 31)

27 Hand strap (p. 20)

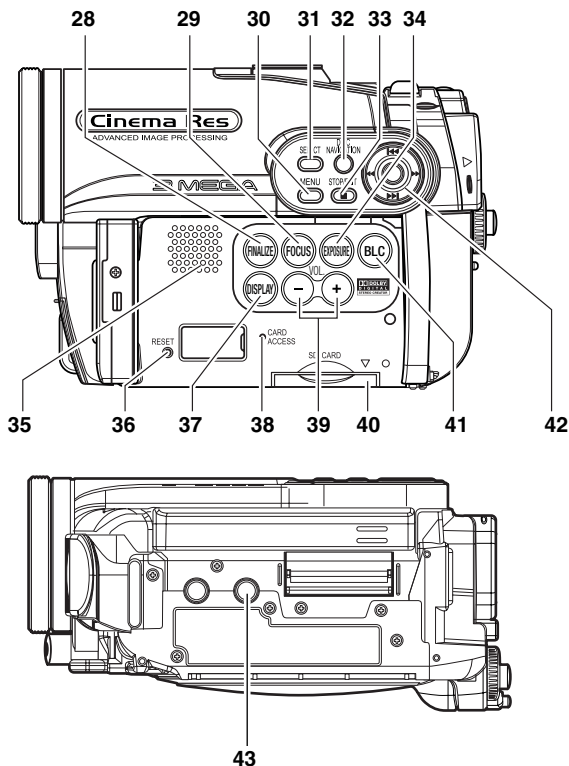

28 FINALIZE button (p. 102)

Press this button to finalize the recorded DVD-RW/DVD-R/+RW.

29 FOCUS button (p. 53)

To switch between manual focus and auto-focus.

30 MENU button (p. 49, 80)

Press this button to display the menu for setting camera functions and Disc Navigation.

31 SELECT button (p. 75)

32 DISC NAVIGATION button (p. 67)

33 STOP/EXIT button (p. 11, 49, 70)

To end playback or cancel setting of menu.

34 EXPOSURE button (p. 55)

Press this button to adjust the exposure.

35 Speaker (p. 70)

36 RESET button (p. 147)

To reset all settings to defaults (status when the DVD video camera/recorder was shipped from the factory).

37 DISPLAY (Screen display) button (p. 47, 74)

Press this button to display the details of image being played back or camera setting status, or switch the display off.

38 CARD ACCESS indicator (p. 7, 42)

39 Volume control buttons (VOL)/

⊖ ⊕ buttons (p. 53, 55, 70)

To adjust the volume of sound from speaker, etc.

40 Card insertion block (p. 40)

41 BLC (backlight compensation) button (p. 55)

Press this button when subject is being lighted from rear.

42 ◀◀ / ▶▶ / ◀◀ / ▶▶ / ▶ / || buttons (p. 33, 49, 70)

Use these buttons to select a scene or menu item, and then press the center (▶/||) to play back the scene, or designate an option from the menu.

43 Tripod threaded hole

Used to attach the DVD video camera/recorder to a tripod.

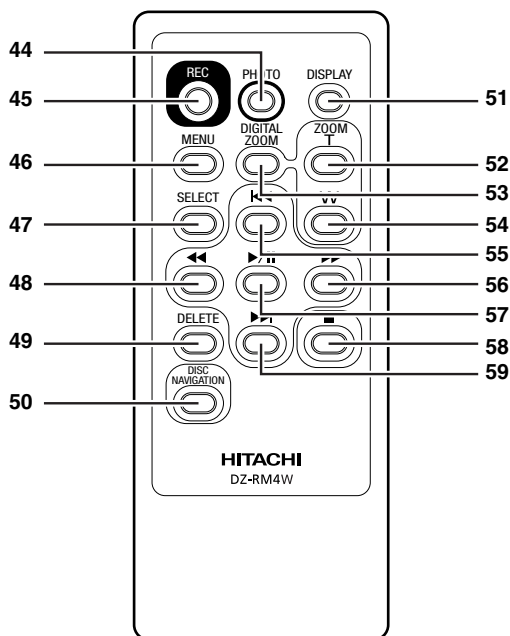

44 PHOTO button (p. 42)

45 REC button (p. 41)

46 MENU button (p. 33, 57, 80)

47 SELECT button (p. 75)

48 Reverse search button (p. 71)

49 DELETE button (p. 79)

50 DISC NAVIGATION button (p. 67)

52 ZOOM T button (p. 51)

53 DIGITAL ZOOM button (p. 51)

54 ZOOM W button (p. 51)

55 Reverse skip button (p. 72)

56 Forward search button (p. 71)

57 Play/pause button (p. 70)

58 Stop button (p. 11, 49, 70)

59 Forward skip button (p. 72)

* The buttons on remote control will function the same as those on DVD video camera/recorder.

Setups

This section explains preparations for recording – setting up the DVD video camera/recorder and battery.

Demonstration Function

This DVD video camera/recorder is equipped with a demonstration function. The default at purchase time is “Auto”, which will automatically start the demonstration approx. three minutes after the DVD video camera/recorder is turned on. Refer to “CHANGING SETTING OF DEMONSTRATION” on page 35 if you wish to view the demonstration immediately or change the setting to “Off”.



Setting Up the DVD Video Camera/Recorder

HOLDING DVD VIDEO CAMERA/RECORDER

Insert your right hand from the bottom of DVD video camera/recorder up to the base of your thumb. Put your hand in a position where you can easily operate the REC button and the Zoom lever. Adjust the length of hand strap so that the DVD video camera/recorder is stable when you press the REC button with your thumb.

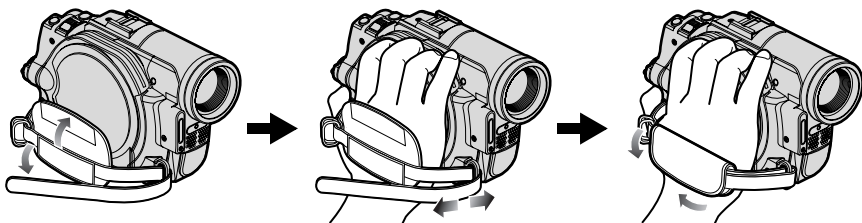

ATTACHING SHOULDER STRAP

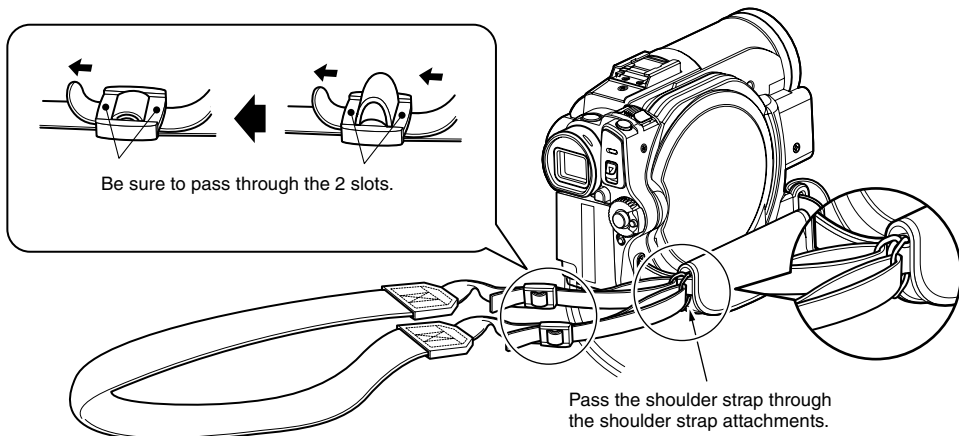

ATTACHING LENS CAP

- 1 Attach the shorter end of lens cap string to the lens cap.
- 2 Attach the longer end of lens cap string to the attachment hole of DVD video camera/recorder.
- 3 Push the both sides of cap inward and attach it over the lens.

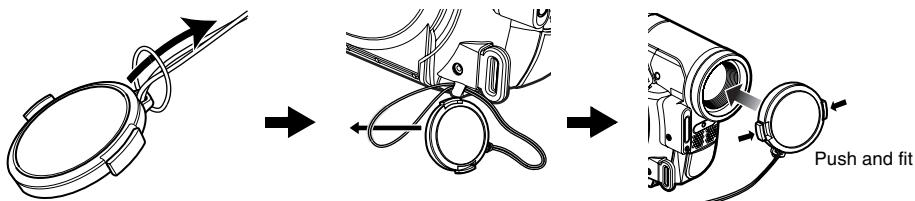
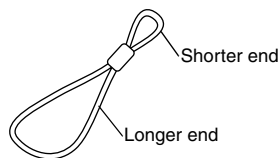

Note:

- Always keep the lens cap on when not using the DVD video camera/recorder, to protect the lens.
- When recording, attach the lens cap to the hand strap by hooking the tab inside the cap onto strap for comfortable shooting.

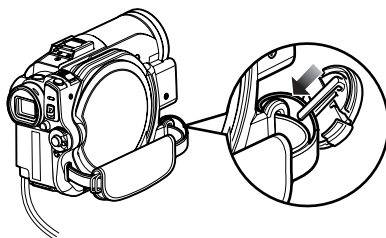

INSERTING BATTERY INTO REMOTE CONTROL

Insert the provided lithium battery into remote control.

- 1 While inserting a fine rod into the hole marked PUSH, pull the battery holder out forward.
- 2 Insert the lithium battery with the positive ⊕ terminal facing down.
- 3 Slide the cover to close it.

Note:

The life of lithium battery is approximately one year. If the battery is discharged, no operation is possible with remote control: Replace the battery.

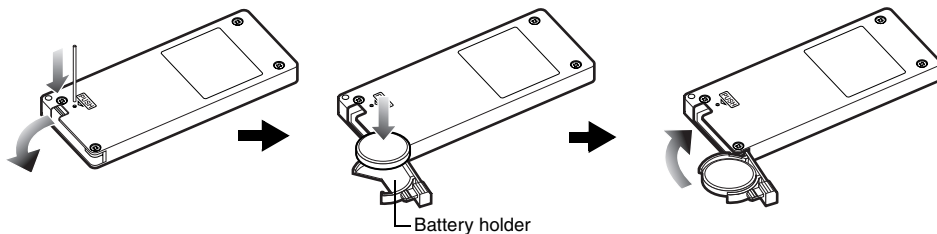

REMOVING BATTERY FROM REMOTE CONTROL

- 1 While pushing the battery holder, slide the battery out.

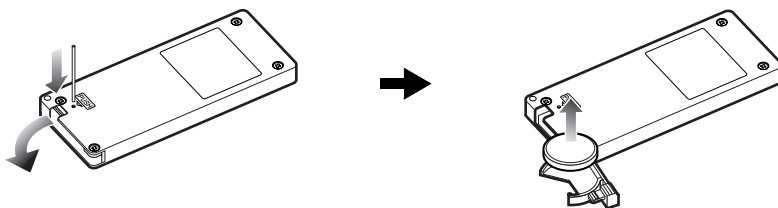

Warning:

- KEEP THE BATTERY AWAY FROM CHILDREN AND PETS.
- IF SWALLOWED, CONSULT A PHYSICIAN IMMEDIATELY FOR EMERGENCY TREATMENT.
- BATTERY MAY EXPLODE IF NOT HANDLED PROPERLY. DO NOT RECHARGE, DISASSEMBLE OR DISPOSE OF IN FIRE.

Note:

- Replace the battery with a Hitachi Maxell, Sony, Panasonic, Sanyo, Toshiba CR2032, or Duracell DL2032. Use of another battery may present a risk of fire or explosion.
- Dispose of battery safely in accordance with local laws. Do not dispose of in fire.
- Do not short circuit the battery.
- Do not hold the battery with the metallic tweezers.
- Keep the battery in a dark, cool, dry place.

● Using remote Control

Point the remote control to the infrared receiver on the DVD video camera/recorder. The remote controllable distance is up to 16 feet (5 m).

Note:

- When using the remote control, make sure that the infrared receiver on DVD video camera/recorder is not exposed to direct sunlight or any intense light. If the infrared receiver is subject to light stronger than the infrared light from remote control, the DVD video camera/recorder cannot be operated by remote control.
- If there is an obstacle between the remote control and infrared receiver on DVD video camera/recorder, remote control may not be possible.
- The DVD video camera/recorder uses the "VCR2" remote control code of Hitachi VCRs. If you use a Hitachi VCR, etc. with remote control code set to "VCR2", a VCR placed near the DVD video camera/recorder will also be operated by the remote control: To prevent this, change the remote control code of the VCR.
- The remote control (DZ-RM4W) and lithium battery (CR2032) are supplied only with the DZ-GX3300A/GX3200A/BX37A.

Discs and Cards

The following table lists the storage media (discs and cards) that can be used on this DVD video camera/recorder and the functions which are available with them:

Function	Media					
	DVD-RAM	DVD-RW (VR mode)	DVD-RW (VF mode)	DVD-R	+RW	SD memory card
To record video (p. 41)	●	●	●	●	●	—
To record photo (p. 42)	●	—	—	—	—	●
To delete image just recorded (p. 70)	●	●	—	—	●	●
To select image and delete it (p. 79)	●	●	—	—	—	●
To edit image (p. 80 – 81)	●	●	—	—	—	—
To play on other DVD players and DVD recorders (p. 102)	∴*1	∴*1*2	●*2	●*2	∴*1*2	—*3
To use new disc or new card without formatting	●*4	—	—	●	—	●*4
To initialize and reuse (p. 99)	●	●	●	—	●	●
To additionally record on finalized disc	—	●	●*5	—	●*5	—
To edit copied video on PC *9	●*6	●*6*7	●*6*7	●*6*7	●*6*7*8	●
To playback video on PC *9	●*6	●*6*7	●*6*7	●*6*7	●*6*7*8	●
To create DVD video using PC *9	—	—	●*6	●*6	—	—

●: Functions available; —: Not available

*1: Playable on devices that conform to either 8 cm DVD-RAM, 8 cm DVD-RW (VR mode) or 8cm +RW.

*2: Must be finalized. Cannot be played on some DVD players or DVD recorders.

*3: Some DVD devices conform to SD memory card.

*4: When media that are sold "formatted" are used. If the initialization format differs, the media can be initialized on this DVD video camera/recorder and then used.

*5: To additionally record, the finalized disc must be unfinalized.





*6: The provided software is used.

*7: Finalize the disc when editing/playback on PC.

*8: The software for Macintosh provided with this DVD video camera/recorder is not compatible with a +RW.

*9: DZ-BX35A cannot be connected to a PC.

AVAILABLE DISCS

Usable discs and logos		Function
DVD-RAM Ver. 2.1 (8 cm)		Allows you to delete unnecessary scenes or edit scenes. Also allows you to record photos.
DVD-RW [Ver1.1 (8 cm) 2x speed (2x/1x)]		Allows you to choose the VR mode for deleting unnecessary scenes or editing scenes, or the VF mode in which deletion or editing is not possible, but high compatibility with DVD players is provided *1.
DVD-R [for General Ver. 2.0 (8 cm)]		Provides high compatibility with DVD players *1. No deletion or editing is possible.
+RW Ver. 1.2 (8 cm)		Provides high compatibility with DVD players but does not need to be finalized *2. Scenes can be deleted immediately after being recorded.

*1: Playback on all DVD players is not guaranteed. The disc must be finalized before being played back on a DVD player.

*2: Playback on all DVD players is not guaranteed.

This DVD video camera/recorder can use only the 8-cm bare discs not packed in a square cartridge, square caddy case or round DVD holder. The discs in a square cartridge, square caddy case or round DVD holder can be used if they are removed from the package, but take great care not to dirty or scratch the bare disc.

Note:

- It is recommended that you use Hitachi Maxell HG type single-sided discs, since their compatibility with this DVD video camera/recorder has been confirmed. When using an HG type double-sided disc, take great care with handling it. Using a disc other than these discs may not allow the DVD video camera/recorder to deliver optimum performance.

INFORMATION ON DVD-R DISC

For optimum recording on DVD-R disc, this DVD video camera/recorder writes control data to the disc in order to automatically make adjustments when it is inserted and ejected accompanying recording. If the disc has no area to be written for adjustment, recording may not be possible. To prevent this, do not insert or eject a DVD-R disc accompanying recording more than 100 times. This DVD video camera/recorder cannot record a DVD-R in the VR mode.

NOTES ON FINALIZATION:

- Do not insert a DVD-RW (VF-mode)/DVD-R disc recorded on this DVD video camera/recorder but not finalized, into a recordable device, such as a DVD recorder: The recorded data may be damaged (except for devices that allow playback of a DVD-RW (VF-mode)/DVD-R disc not finalized on this DVD video camera/recorder).**
- Use only DZ-GX3300A/GX3200A/GX3100A/BX37A/BX35A to record on or finalize a DVD-RW (VF-mode)/DVD-R/+RW disc recorded on this DVD video camera/recorder but not finalized: Using any other device could damage the data recorded on the disc.
- DVD-RW/DVD-R/+RW discs edited and finalized on PC or those finalized on another DVD recorder may not be playable on this DVD video camera/recorder, depending on the editing software used or recorded status of DVD-RW/DVD-R/+RW disc.
- If you insert a DVD-R disc recorded on this DVD video camera/recorder or a DVD video camera/recorder other than DZ-GX3300A/GX3200A/GX3100A/BX37A/BX35A and not finalized, the Disc Navigation screen will automatically start, and no recording can be done on the disc nor can it be finalized.
- Do not insert a DVD-R that was recorded by a DVD recorder manufactured by a company other than Hitachi, and which has not been finalized, in this DVD video camera/recorder: Doing so will make the disc unusable.

EXAMPLES OF DISCS THAT CANNOT BE USED ON THIS DVD VIDEO CAMERA/RECORDER:

- CD-RW
- CD
- CD-R
- CD-ROM
- DVD-R (4.7 GB) for Authoring Ver. 2.0
- DVD-R (double-layered)
- DVD+R
- DVD-ROM
- DVD-Video
- Discs other than those with diameter of 8 cm

AVAILABLE CARDS

SD memory card can be used on this DVD video camera/recorder.

When using an exclusive adapter, a miniSD memory card can be used in the same way as an SD memory card. No multimedia card can be used.

● Handling card

- Do not use cards other than the designated ones.
- Be sure to perform trial recording before recording vital images.
- Do not touch the card terminal or allow it to touch metal.
- Do not paste anything other than exclusive label on label pasting portion.
- Do not subject card to impact, bend or drop it.
- Do not disassemble card or modify it.
- Do not expose card to water.
- Do not use or store card in the following places:
 - Where the temperature is high, such as in vehicle at high temperatures, under burning sun or near a heater
 - Where humidity is high, or in dusty place
- When the erasure prevention switch is locked, no recording, deletion or editing will be possible on the card: Only playback will be possible.

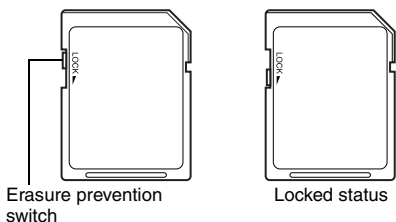
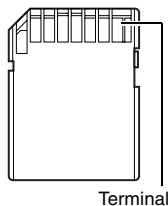

COMMON CAUTIONS FOR DISC AND CARD

- It is recommended that you create a backup file for valuable data on hard disk of PC.
- Do not do the following, or the data on disc or card may be damaged or lost:
 - Do not remove the disc or card or turn DVD video camera/recorder off during reading or writing of data
 - Do not use DVD video camera/recorder in a place subject to static electricity or electrical noise
 - Do not have printing done at a print lab or DPE service
 - Do not leave a +RW unused in the DVD video camera/recorder for a long time

Note:

- This DVD video camera/recorder can play back image data recorded on other digital cameras conforming to the DCF (Design rule for Camera File system) standard. The range of image data playable on this DVD video camera/recorder is that with pixels from 80 horizontal × 60 vertical to 4000 horizontal × 3000 vertical.
- DCF is an integrated image file format of digital cameras: Image files can be used on all digital devices conforming to DCF.
- Image data edited on PC and certain types of image data may not be visible on this DVD video camera/recorder.
- The image data recorded on another device may not be playable on this DVD video camera/recorder.

● Note when transferring or discarding discs and memory cards:

“Formatting” or “deletion” using the functions of DVD video camera/recorder or PC will change only the file control information: It will not completely delete the data on disc or memory card.

When transferring or discarding a disc or memory card, it is recommended that you physically destroy it or use deletion exclusive software (generally available) to completely delete the data on it. It is user's responsibility to control the data on disc and memory card.

Preparations for Power Supply

USING DVD VIDEO CAMERA/RECORDER WITH AC ADAPTER/CHARGER

It is recommended that you use the AC adapter/charger to power the DVD video camera/recorder from household AC outlet when you perform settings on it, play back or edit images, or use it indoors.

Note:

Be sure to use the specified AC adapter/charger (DZ-ACS3) to power the DVD video camera/recorder. Using other AC adapter/chargers could cause electric shock or result in fire.

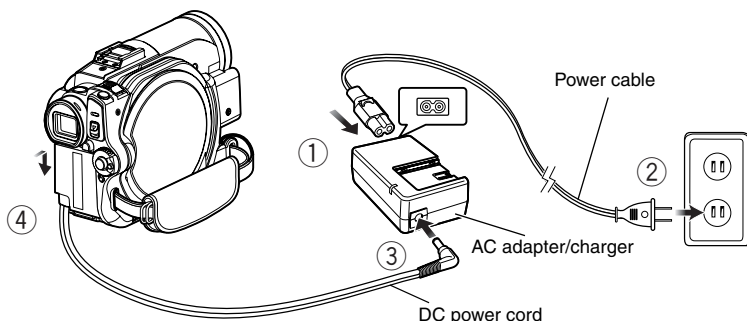

- 1** Connect the power cable to AC adapter/charger.
- 2** Plug the power cable into AC outlet.
- 3** Plug one end of DC power cord into the DC output jack on AC adapter/charger.
- 4** Attach the other end of DC power cord to the battery attachment platform on DVD video camera/recorder.
Use the same procedure as that for battery when attaching and detaching the DC power cord: See page 28.

Setting Up the Battery

The DZ-BP14SW battery provided with DZ-GX3300A/GX3200A or DZ-BP7S battery provided with DZ-GX3100A/BX37A/BX35A has not been charged at purchase time: Charge it before using the DVD video camera/recorder.

Note:

- Be sure to use the DZ-BP14S, DZ-BP7S, DZ-BP14SW (optional) or DZ-BP7SW (optional, unavailable for DZ-GX3300A/GX3200A) battery for the DVD video camera/recorder: Using other batteries could cause the DVD video camera/recorder to malfunction, or result in fire.
- Be sure to use the DZ-ACS3 AC adapter/charger to charge the battery: Using other chargers could cause electric shock or fire.
- Charge the battery at temperatures of 50 – 86°F (10 – 30°C).
- If the CHARGE indicator does not light when the AC adapter/charger is plugged into AC outlet, unplug it from the AC outlet, wait a few moments, and then plug it into the AC outlet again. If the CHARGE indicator still does not light, the AC adapter/charger may be faulty. Unplug it from the AC outlet and consult your dealer.
- The AC adapter/charger can be used around the world. An AC plug adapter is required in some foreign countries. If you need one, purchase it from your local electronics distributor.

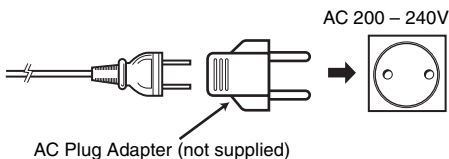

CHARGING BATTERY

Use the provided AC adapter/charger to charge the battery.

1 Connect the power cable to AC adapter/charger.

2 Plug the power cable into AC outlet.

3 Attach the battery to AC adapter/charger.

Note:

When charging a battery, unplug the DC power cord from the DC output jack on AC adapter/charger.

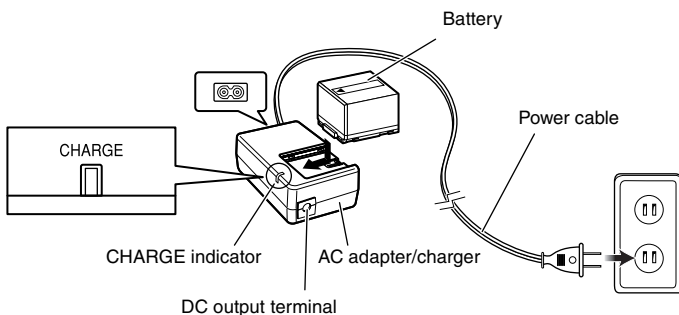

● Battery charged status

You can find out the charged status of battery by checking the CHARGE indicator on AC adapter/charger:

Charge status	CHARGE indicator
During charge	Lit
Charge complete	Goes out

Note:

See "Troubleshooting" on page 139 when the CHARGE indicator blinks.

● Reference for time required to charge battery (at approx. 77°F (25°C)):

DZ-BP14S (provided with DZ-GX3300A/GX3200A)/DZ-BP14SW (optional): Approx. 165 minutes

DZ-BP07PW (provided with DZ-GX3100A/BX37A/BX35A)/DZ-BP7SW (optional, unavailable for

DZ-GX3300A/GX3200A): Approx. 90 minutes

The charge time will vary depending on the remaining power level of battery.

ATTACHING BATTERY TO DVD VIDEO CAMERA/RECORDER

- 1 Fit the battery to the battery attachment platform on this DVD video camera/recorder and slide it downward until a click is heard.

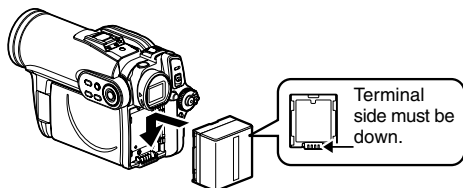

Note:

- Make sure that the battery is in the correct orientation.
- Make sure that the battery is securely attached: Incomplete attachment could cause the battery to fall, resulting in damage.

REMOVING BATTERY

After using the DVD video camera/recorder, remove the battery from it.

- 1 While holding down the BATTERY EJECT button, slide the battery upward to remove it.

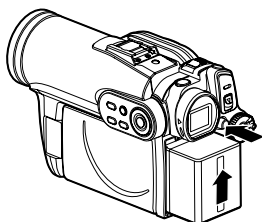

Note:

- For safety, be sure to turn the DVD video camera/recorder off before attaching or removing the battery.
- Be careful not to drop the removed battery.
- If the battery remains attached, minute level current will flow even if the DVD video camera/recorder is off, and the battery will discharge.
- Set the power switch to OFF before removing the battery.

● Continuously recordable time with fully charged battery (with no zoom operation, etc.)

See the following table as a reference for how long the DVD video camera/recorder can continuously be used with a fully charged battery:

With DZ-BP14S (provided with DZ-GX3300A/GX3200A)/DZ-BP14SW (optional)

Video mode		DZ-GX3300A	DZ-GX3200A	DZ-GX3100A	DZ-BX37A/ BX35A
XTRA*1	When using viewfinder	approx. 105 min	approx. 125 min	approx. 145 min	approx. 170 min
	When using LCD monitor	approx. 95 min	approx. 115 min	approx. 130 min	approx. 150 min
FINE	When using viewfinder	approx. 105 min	approx. 125 min	approx. 145 min	approx. 170 min
	When using LCD monitor	approx. 95 min	approx. 115 min	approx. 130 min	approx. 150 min
STD	When using viewfinder	approx. 115 min	approx. 140 min	approx. 170 min	approx. 210 min
	When using LCD monitor	approx. 105 min	approx. 125 min	approx. 145 min	approx. 170 min

With DZ-BP07PW (provided with DZ-GX3100A/BX37A/BX35A)/DZ-BP7SW*2 (optional)

Video mode		DZ-GX3100A	DZ-BX37A/BX35A
XTRA*1	When using viewfinder	approx. 70 min	approx. 85 min
	When using LCD monitor	approx. 65 min	approx. 75 min
FINE	When using viewfinder	approx. 70 min	approx. 85 min
	When using LCD monitor	approx. 65 min	approx. 75 min
STD	When using viewfinder	approx. 80 min	approx. 100 min
	When using LCD monitor	approx. 70 min	approx. 85 min

*1 The time is only for reference: It will vary depending on recording contents.

*2 Unavailable for DZ-GX3300A/GX3200A.

The reference for how long the DVD video camera/recorder can actually be used will be approx. 1/2 to 1/3 of the above time:

The continuously recordable time of DVD video camera/recorder in the above table shows the time available when the DVD video camera/recorder is in the recording mode without using any other function after recording is started. In actual recording, the battery will discharge 2 – 3 times faster than this reference, since the REC button and zoom are being operated, and playback is performed. Assume that the actually recordable time with a fully charged battery is between 1/2 and 1/3 of the above time, and prepare enough batteries to allow for the time you are planning to record on the DVD video camera/recorder.

The continuously recordable time may be less depending on the conditions when the DVD video camera/recorder is used (if recording and recording pause are repeated at short intervals, etc.).

Note that the battery discharges faster in cold places.

Note:

- See "Troubleshooting" on page 139 when charging is not possible.
- The charge time will vary depending on the battery remaining level.
- During and after charging, and when the DVD video camera/recorder is being used, the battery will be warm, but this does not indicate a fault.
- A battery cannot be charged while the DC power cord is connected to the DC output jack of AC adapter/charger: Unplug the DC power cord when charging a battery.
- Charge the battery at ambient temperature 50°F to 86°F (10°C to 30°C): Charging at temperatures other than this range could damage the battery.

BATTERY REMAINING LEVEL INDICATOR

When the battery is used to power the DVD video camera/recorder, the battery remaining level appears in the viewfinder or on the LCD screen as follows:

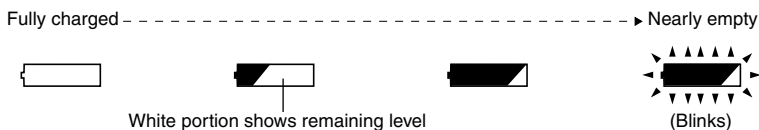

EFFICIENT USE OF BATTERY

- The battery will slightly discharge even if it is detached from the DVD video camera/recorder.
- If the battery is left attached to DVD video camera/recorder, it will consume a slight amount of power. Therefore, it is recommended that you charge the battery shortly before using the DVD video camera/recorder, usually on the day before you plan to use it.

When not using the DVD video camera/recorder for an extended period:

It is recommended that you fully charge the battery once a year, attach it to DVD video camera/recorder and use it up; then remove the battery and store it in a cool place again.

Battery life:

The battery life varies greatly depending on the ambient environment and how often the DVD video camera/recorder is used. If the usable time of DVD video camera/recorder with a fully charged battery is noticeably short, the battery is probably dead: Purchase a new one.

Power save and discharge of battery:

It is recommended that you turn the DVD video camera/recorder off in status other than recording, since even during recording pause battery power is consumed at the same level as during recording.

If, when you specify Power Save On, the recording pause status continues for approximately 5 minutes, the DVD video camera/recorder will automatically turn off. To set or release power save, see "TURNING DVD VIDEO CAMERA/RECORDER OFF AUTOMATICALLY (POWER SAVE)" on page 34.

Turning DVD Video Camera/Recorder On and Off

While holding down the gray button at the right of power switch, set the switch according to each recording function:

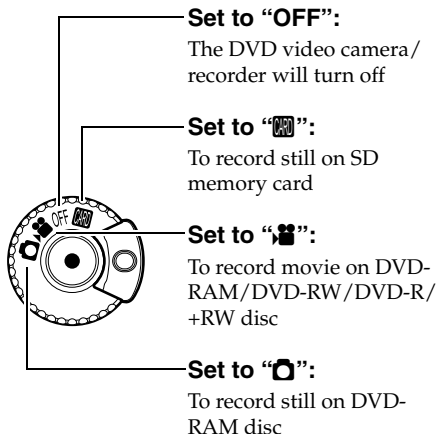

Note:

- Once you turn the DVD video camera/recorder on to let it recognize the disc, you can immediately record or play back by turning the DVD video camera/recorder on again. However, if a long time has elapsed after the disc was inserted, it will take some time for the DVD video camera/recorder to start because it must recognize the disc again (see "Troubleshooting" on page 139).
- It will take some time for the DVD video camera/recorder to display the Disc Navigation screen after power is turned on.
- When the DVD video camera/recorder is turned on, the self-diagnosis function will work and a message may appear. In this case, refer to "Trouble Messages" on page 133 and take corrective action.

Power ON status

During playback, set the power switch to "DVD" or "D" when using disc, or set it to "SD" when using card.

Turn the switch while holding down the gray button at the right of switch.

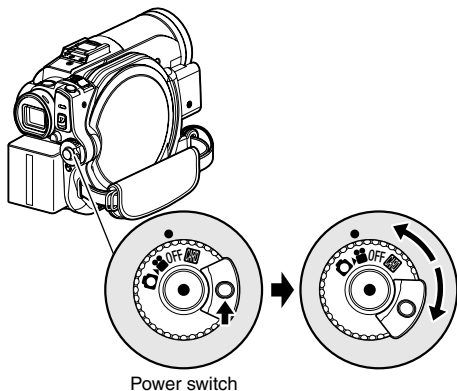

VIEWING IMAGE ON LCD MONITOR SCREEN

If you open the LCD monitor, you can monitor subject image on the LCD screen.

1 Open the LCD monitor.

The LCD monitor has a portion where you can hook your finger. Hook the finger there to open the monitor.

● Range where the LCD monitor can be moved

The LCD monitor can be opened up to approximately 90°.

If the LCD monitor is open 90°, it can be tilted with the screen down as much as 90°, and can also be tilted with screen up and turned up to 180° so the screen faces in the same direction as the lens.

If the LCD monitor is turned 180° so the screen faces in the same direction as the lens during recording, subject image will also appear in the viewfinder as a mirror image (left/right reversed).

Tilt the LCD monitor to adjust its vertical angle so that you can see the screen easily.

Note:

- If no image appears on LCD monitor screen, refer to “Troubleshooting” on page 139.
- If LCD monitor lights white, refer to page 58.
- Be sure to open the LCD monitor approximately 90° before changing its vertical angle.
- Do not record for a prolonged time with the LCD monitor turned approximately 180° in close contact with the DVD video camera/recorder body: Doing this could cause the DVD video camera/recorder and LCD monitor to become hot.

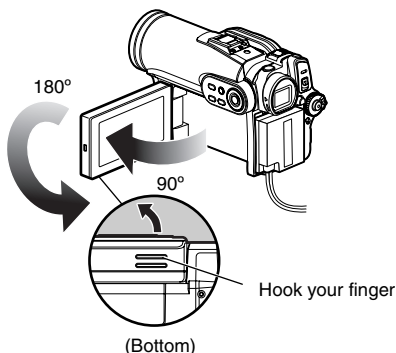

VIEWING SUBJECT THROUGH VIEWFINDER

1 Pull out the viewfinder.

2 Turn the diopter control knob to adjust the focus to suit your eyesight.

Note:

- If no image appears in viewfinder, refer to “Troubleshooting” on page 139.
- If the LCD monitor is opened approximately 90°, the viewfinder will be off: Turn the open LCD monitor 180° so that it faces the same direction as the lens; the image will appear in the viewfinder.
- Focusing will not be correct unless the viewfinder is pulled out.
- See “LCD/EVF Setup” (on page 37) if you wish to display images in the viewfinder regardless of whether you open or close the LCD monitor.

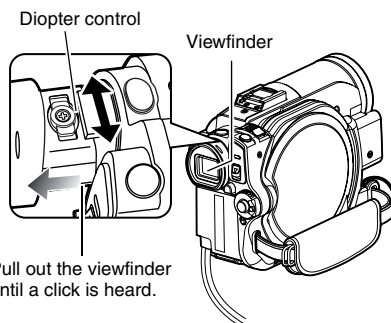

Setting Date and Time

Set the current date and time so that the date and time you make a recording can be recorded correctly.

The following procedure can also be used to correct the date and time you have already set.

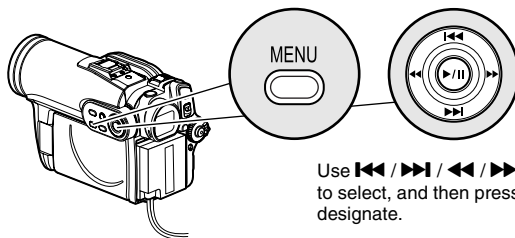

Use ◀◀ / ▶▶ / ◀ / ▶ buttons to select, and then press ▶/|| to designate.

1 Press the MENU button, use the ◀◀/▶▶/◀/▶ buttons to choose “Date Setup” and then “Date Set”.

2 Press the ▶▶ button.

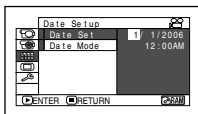

The figure for the month will be selected. [The digit that is highlighted first depends on the date display format (set up in Date Mode): The digit on the left end of the date display will be first highlighted.]

Note:

After setting the figure for the month, press the ▶▶ button to select the digit to be set. If you press the ▶/|| button after selecting the figure for the month, the screen for verifying the set date will appear instead of screen for setting day, year or time.

3 Press the ◀◀ or ▶▶ button to select the digit you want to set in sequence.

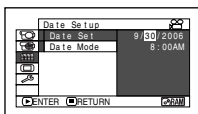

Press the ◀◀ or ▶▶ button to select the number for current date/time, and then repeat step 3 to set the current date and time.

Note:

To stop date/time setting midway, press the ■ button.

4 After setting the current date and time, press the ▶/|| button.

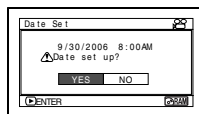

The screen for verifying the set date will appear.

5 If the displayed date and time are correct, press the ◀◀ button to choose “YES”, and then press the ▶/|| button.

The date and time will be set, and the DVD video camera/recorder will enter the recording pause status. Choosing “NO” will restore the menu screen.

CHANGING DISPLAY FORMAT OF DATE AND TIME

You can select one of three date display formats: month/day/year, day/month/year or year/month/day. Choose “Date Mode” on the “Date Setup” menu screen in procedure 1, and then set to the desired date display mode.

Note:

This DVD video camera/recorder incorporates a rechargeable battery to store the date and time in memory. If this built-in battery is exhausted, the date and time will be reset. To prevent this, connect the AC adapter/charger to DVD video camera/recorder every 6 months, and leave them for at least 24 hours with the DVD video camera/recorder turned off: The built-in battery will be charged.

Initial Settings

Press the MENU button, and then use **◀▶▶▶/◀▶▶▶▶/▶▶▶▶▶** to display the “Initial Setup” menu screen. See page 49 for detailed operation procedure. Press the MENU button again to exit setting.

SWITCHING OPERATING SOUND ON OR OFF (BEEP)

Select “On” or “Off”, and then press the **▶▶▶▶** button.

On: Beep will be heard

when the power switch is changed

over, the REC button is pressed in the Video mode, the SLEEP/START or EJECT button is pressed, etc.

Off: No beep is heard.

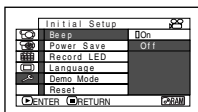

Note:

The “Beep” setting will be stored in memory even when the DVD video camera/recorder is turned off.

TURNING DVD VIDEO CAMERA/RECORDER OFF AUTOMATICALLY (POWER SAVE)

Select “On” or “Off”, and then press the **▶▶▶▶** button.

On: To engage power

save. If the DVD video camera/recorder is left in the recording pause status without being operated for 5 minutes, it will automatically turn off to prevent the battery from discharging needlessly.

Off: To cancel power save.

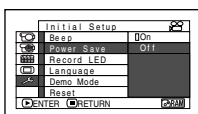

Note:

- To turn the DVD video camera/recorder on again from automatic off activated by the power save function, set the power switch to “OFF”, and then set it to “**▶▶▶▶**”, “**▶▶▶▶▶**” or “**▶▶▶▶▶▶**”.
- The Power Save setting will not appear in the on-screen information display.
- If the sleep/start standby status continues for 30 minutes, the DVD video camera/recorder will automatically turn off regardless of the Power Save setting.

CHANGING DISPLAY LANGUAGE (LANGUAGE)

You can change the language used to display the menu and information. The following shows that English is changed to French.

1 Press **▶▶▶▶** or **▶▶▶▶▶** with the screen shown on the right displayed: The “Language” screen will appear.

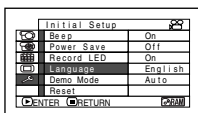

Note:

The language setting will be stored in memory even when the DVD video camera/recorder is turned off.

2 Choose “Français”, and then press **▶▶▶▶**. The display will change to French.

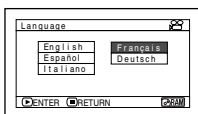

RESETTING MENU SETTINGS TO DEFAULTS (RESET)

You can restore menu settings to defaults (initial settings at the factory (p. 147)). (Note, however, that the date/time will not be reset.)

- 1 Choose "Reset" on the "Initial Setup" menu screen, and then press the ►/|| button.

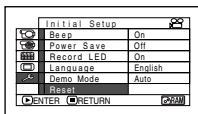

The screen for verifying reset will appear.

- 2 If you are sure that you wish to reset, use the ◀◀ button to choose "YES", and then press the ►/|| button.

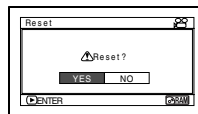

The setting items have now been reset to defaults.

Note:

To cancel resetting midway, choose "NO" on the screen for verification in step 2 or press the ■ button.

TURNING RECORD LED ON OR OFF (RECORD LED)

You can switch off the recording indicator on the front of DVD video camera/recorder even during recording.

Select "On" or "Off", and then press the ►/|| button.

- On: The recording indicator will light red to show that the DVD video camera/recorder is recording.
- Off: The recording indicator will not light even during recording.

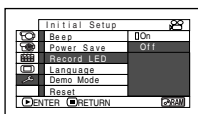

Note:

- The Record LED setting will not appear in the on-screen information display.
- The Record LED setting will be stored in memory even when the DVD video camera/recorder is turned off.
- Specify "Record LED: Off" when recording a subject behind a glass or water tank that reflects light: The reflected light of the recording indicator will not be recorded.
- Even if "Record LED Off" is specified, the recording indicator will light while the self-timer is counting down.

CHANGING SETTING OF DEMONSTRATION

- 1 Press the MENU button, choose "Initial Setup", "Demo Mode", and then press the ►/|| button.

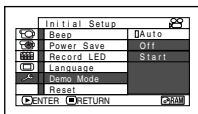

- 2 Press the ◀◀ or ▶▶ button to choose the desired option, and then press the ►/|| button.

- Auto: To start demonstration if the DVD video camera/recorder is inactive for approx. 3 minutes after it is turned on.
- Off: To set demonstration to off.
- Start: To start demonstration immediately.

- 3 Press the MENU button again to exit setting.

Note:

- Pressing the ■ (STOP/EXIT) or DISC NAVIGATION button will exit demonstration.
- If you choose "Auto", the demonstration will not start if a disc is loaded with the power switch set to "■" or "□", or a card is loaded with the power switch set to "■".
- The demonstration function will not work when the DVD video camera/recorder is connected to PC (DZ-GX3300A/GX3200A/GX3100A/BX37A only).
- While the demonstration is being given, the recording indicator will blink.

LCD/EVF Setup

ADJUSTING BRIGHTNESS OF LCD SCREEN (LCD BRIGHTNESS) AND VIEWFINDER (EVF BRIGHTNESS)

1 Press the MENU button, use the **◀◀/▶▶/◀◀/▶▶/▶▶/||** buttons to choose “LCD/EVF Adjust” on the “LCD/EVF Setup” menu screen, and then choose “LCD Brightness” or “EVF Brightness”.

The brightness adjustment bar will appear on the screen.

2 Use the **◀◀/▶▶** buttons for adjustment.

Press **◀◀**:

The screen becomes dimmer.

Press **▶▶**:

The screen becomes brighter.

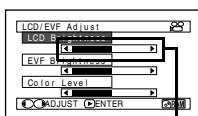

Brightness adjustment bar

3 Press the MENU button to end the setting.

Note:

The brightness setting will be stored in memory even after the DVD video camera/recorder is turned off.

ADJUSTING COLOR DENSITY (COLOR LEVEL)

You can adjust the color density of the LCD monitor screen and viewfinder.

- 1 Press the MENU button, use the **◀◀/▶▶/◀/▶/▶▶/▶▶** buttons to choose “LCD/EVF Adjust” on the “LCD/EVF Setup” menu screen, and then choose “Color Level”.

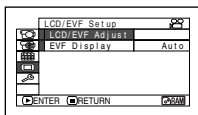

Note:

- The color setting will be stored in memory even after the DVD video camera/recorder is turned off.
- Even if the brightness or density of LCD monitor screen or viewfinder is changed, the brightness or density of the recorded image itself will not change.

The color density adjustment bar will appear on the screen.

- 2 Use the **◀◀/▶▶** buttons for adjustment.

Press **◀◀** :
For lighter color.
Press **▶▶** :
For denser color.

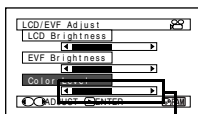

Color density adjustment bar

ALWAYS DISPLAYING IMAGE IN VIEWFINDER

- 1 Press the MENU button, use the **◀◀/▶▶/◀/▶/▶▶/▶▶** buttons to choose “EVF Display” on the “LCD/EVF Setup” menu screen.

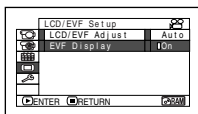

- 2 Choose “On” and decide it.

Auto: If the LCD monitor is open, no image will appear in the viewfinder.

On: Images will always appear in the viewfinder regardless of whether the LCD monitor is open/closed.

Note:

The setting on EVF Display will be stored in memory even after the DVD video camera/recorder is turned off.

Inserting and Removing Disc

- 1** Press down the DISC EJECT button once and release it.

A few moments after the ACCESS/PC indicator blinks, the cover of disc insertion block will open.

- 2** Gently open the cover by hand fully until it stops.

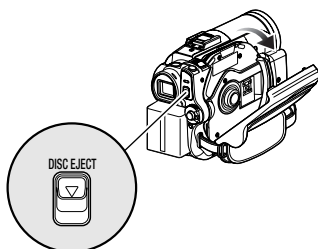

- 3** When inserting a disc:
Push the disc against the turntable at the center to lock it until a click is heard.

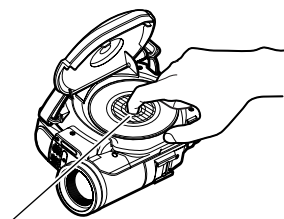

Push the shaded portion.

When removing the disc:
While pushing down the center portion of turntable, pick up the disc, holding its edge, to remove it.

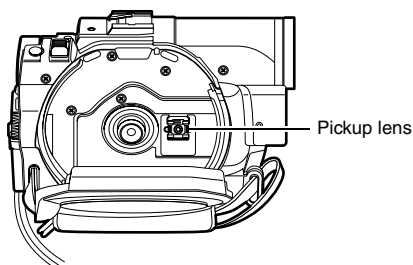
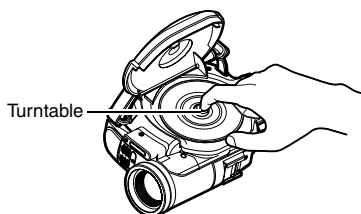

- Note that the recording surface of disc must face the inside of DVD video camera/recorder. When using a single-sided disc, the recording surface is the side without label.
- Never touch the disc recording surface or pickup lens. Touching the pickup lens could cause a fault.
- Use the disc cleaning cloth provided to wipe off any dirt adhering to the disc recording surface.
- Do not use a dirtied or scratched disc.

- 4** Push the section marked "PUSH CLOSE" on the cover of disc insertion block, to close the cover.

Then the DVD video camera/recorder will automatically recognize the disc: While the ACCESS/PC indicator is lit, do not cut off the power supply, and do not subject the DVD video camera/recorder to any vibrations or impact.

Note:

- If the cover of disc insertion block is open, the ACCESS/PC indicator will blink when an image is displayed on the LCD monitor screen: In this case, the DVD video camera/recorder will not turn off even if the power switch is set to "OFF". If the cover remains open after a while, the DVD video camera/recorder will automatically turn off.
- Disc cannot be inserted or removed unless a charged battery or AC adapter/charger is connected to the DVD video camera/recorder.
- If there is some delay before recording starts, refer to "Troubleshooting" on page 139.
- Do not close the cover if a disc is not properly loaded on the turntable.
- If a single-sided disc is inserted into DVD video camera/recorder with the printed label facing the inside, an error message will appear. Remove the disc and reinsert it with its recording side facing the inside. See "Trouble Messages" on page 133.
- Do not remove the battery or disconnect the AC adapter/charger during removal of the disc or until power is completely turned off: If you do, the disc cover will not open. If this happens, reattach the battery or AC adapter/charger, push down the DISC EJECT button once, and then release it.
- Do not insert anything other than the 8 cm DVD-RAM/DVD-RW/DVD-R/+RW disc into the disc insertion block: Doing so could cause malfunctions.
- When inserting or removing the disc, BE SURE NOT to look into the lens in laser pickup: Doing so could damage your eyesight.
- When the power switch is set to "OFF", the disc cannot be removed: To remove the disc, set the power switch to "OFF" or "OFF".

When using double-sided disc

Recording is possible on both sides of double-sided disc. However, when recording or playback on one side is finished, recording or playback will not move automatically to the other side. Remove the disc once from the DVD video camera/recorder, turn over the disc and insert it again for continued use.

The recording surfaces of double-sided disc are likely to become dirtied or scratched: Always make sure that there is no dirt or scratch on the recording surface facing the pickup lens, and then use the disc taking great care that it is not dirtied or scratched. Use the provided disc cleaning cloth to wipe off any dirt on disc (see page 10).

When using brand-new DVD-RW/+RW disc

When a disc is first loaded in the DVD video camera/recorder, the "Format Disc" screen will appear.

When recording on this DVD video camera/recorder:

Choose "Yes" on the "Format Disc" screen, and then press ►/||.

When using DVD-RW, choose the recording format (VR or VF mode), and then press the ►/|| button.

The disc will be formatted.

When recording data from PC:

While the "Format Disc" screen is displayed, choose "No" and then press ►/||, or press the ■ button.

However, if data from PC has not yet been recorded, the disc can be made usable on this DVD video camera/recorder. When inserting the disc into this DVD video camera/recorder, the same message will appear: If you wish to use it on this DVD video camera/recorder, choose "YES".

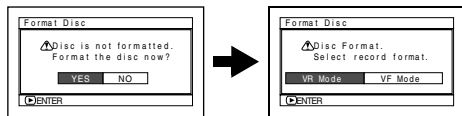

(When using DVD-RW)

Inserting and Removing Card

- 1 Open the LCD monitor.
- 2 Turn the DVD video camera/recorder off.
- 3 Open the cover of card insertion block.
- 4 **Inserting Card:**
Insert card with its terminal inward until it locks.
Removing Card:
Push the center of card edge.
The card will come out so that it can be held by fingers.

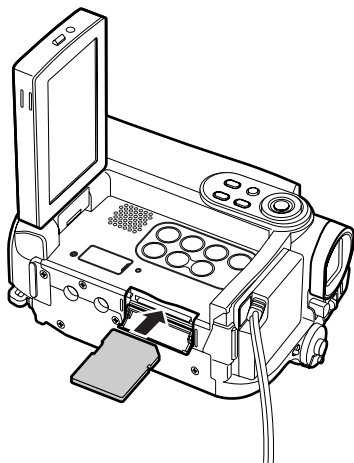

- 5 Close the cover of card insertion block.

Note:

- Always close the cover of card insertion block: Placing the DVD video camera/recorder on a desk, etc. with cover open could damage the cover.

Basic Techniques

This section explains about recording of movies and still images, and also basic settings on DVD video camera/recorder.

RAM RW VR RW VF R +RW

Recording Movie

Before You Begin

- Insert a recordable DVD-RAM/DVD-RW/DVD-R/+RW disc into this DVD video camera/recorder.

Pressing REC once will start recording; pressing it once again will temporarily stop recording.

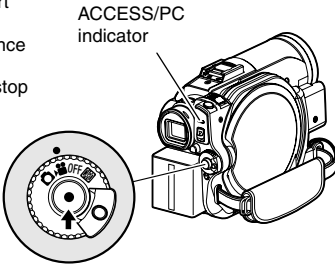

1 Remove the lens cap, and then point the DVD video camera/recorder at subject.

2 Turn the DVD camera/recorder on.

Set the power switch to “” to turn the DVD video camera/recorder on.

After the ACCESS/PC indicator goes out, perform the subsequent operation:

3 Check the subject on the screen (viewfinder or LCD).

When using the viewfinder, close the LCD monitor before pulling out the viewfinder.

4 Press the REC button.

The “” mark in the viewfinder or on the LCD screen will change to the “ REC” mark, and recording will start.

During recording, the recording indicator on the front of DVD video camera/recorder will light.

Pressing REC again during recording will set the DVD video camera/recorder to the recording pause status.

5 When recording is finished, turn the DVD video camera/recorder off.

Note:

- See “Troubleshooting” on page 139 when recording movie is not possible.
- See “Troubleshooting” on page 139 if it takes some time before recording is possible.
- See “Troubleshooting” on page 139 if the DVD video camera/recorder does not operate.
- See page 44 for on-screen information display.
- While the ACCESS/PC indicator is lit or blinking, do not turn the DVD video camera/recorder off, and take care not to subject it to any vibration: Doing so could cause an error in the recorded data, which could make it unplayable (see page 7).
- The minimum recordable time of movie is approximately 3 seconds.
- See page 35 for setting of Record LED (recording indicator) On/Off.
- For various functions available during recording, see “Setting Up Camera Functions” on page 57.
- Hitachi cannot be responsible for video and audio that cannot be recorded or edited because of any defect.
- The power switch can be changed over even during recording, but the operation will not be changed.
- It is recommended that you set the LOCK switch to (the upper position) to prevent the power switch in the “” position from accidentally moving to “” position.
- Each time the DVD video camera/recorder enters the recording pause status, the counter display will be reset to “0:00:00”.
- If, when using a +RW, one-time recording duration is short or you frequently switch the video quality, recording may not be possible even when the disc has remaining space.

Recording Stills

Note:

Recording of still images is possible on DVD-RAM disc and card.

ACCESS/PC
indicator

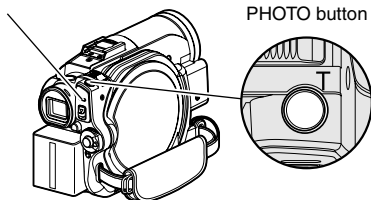
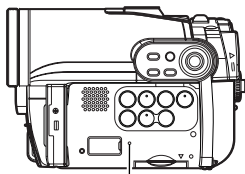

PHOTO button



CARD ACCESS indicator

1 Remove the lens cap, and then point the DVD video camera/recorder at subject.

2 Turn the DVD camera/recorder on.

When using DVD-RAM disc:

Set the power switch to “**ⓐ**”.

When using card:

Set the power switch to “**ⓑ**”.

After the ACCESS indicator goes out, perform the subsequent operation:

3 Check the subject on the screen (viewfinder or LCD).

When using the viewfinder, pull it out and close the LCD monitor.

4 Press the PHOTO button half way (half pressing).

The DVD video camera/recorder will automatically focus on the subject at the center of screen, and the “●||” indicator on screen will light in purple (the focus will not change when manual focus is chosen).

5 Press the PHOTO button all the way (full pressing).

The screen will be black, and then the recorded still will be displayed. When the “●||” mark appears, you can proceed with the next recording; while “DISC ACCESS” or “CARD ACCESS” is being displayed, you cannot proceed with the next recording.

Note:

- If you wish to record without locating a subject at the center of screen, first locate the subject at the center of screen, press the PHOTO button halfway down, determine the composition to be recorded, and then press the PHOTO button all the way down.
- If you press the PHOTO button all the way down at one stroke without pressing it half way, recording will be possible, but the focus may be incorrect.
- If focusing is difficult with auto focus, choose manual focus, and manually correct the focus before recording (see page 53).
- See “SIZE AND QUALITY OF PHOTOS” on page 152 for details of photos on card.
- See “Troubleshooting” on page 141 if recording photos is not possible.
- Shake of the DVD video camera/recorder may cause blur in recorded image.
- When holding the DVD video camera/recorder for recording, grasp it securely with both hands.
- When recording with higher zoom magnification, it is recommended that you secure the DVD video camera/recorder on a tripod.
- The range of screen in which recording is possible will be different for movie and still.
- There may be a difference between the image you see on the LCD screen or viewfinder and the recorded image.

Swift Restart of Recording (SLEEP/RESTART button)

If you press the SLEEP/RESTART button while in the recording pause status instead of turning the DVD video camera/recorder off, the status that recording is possible will be restored in approx. one second.

Setting to the sleep/restart standby status:

Press the SLEEP/RESTART button in the recording pause status.

The SLEEP/RESTART button will light, and the DVD video camera/recorder will enter the sleep/restart standby status.

In the following cases, pressing the SLEEP/RESTART button will not set the DVD video camera/recorder to the sleep/restart standby status:

- No disc or card is inserted into this DVD video camera/recorder.
- The loaded disc or card has no remaining free space.
- The Disc Navigation screen is being displayed.
- The power switch is set to "O" when using a DVD-RW/DVD-R/+RW.
- During playback.
- An unusable disc or card is loaded.

Restoring from sleep/restart standby status

Press the SLEEP/RESTART button that is lit: The DVD video camera/recorder will return to the recording pause status.

Pressing the REC or PHOTO button will also restore the DVD video camera/recorder to recording pause from the sleep/restart standby status.

The following operation will release the sleep/restart standby status:

- Press down the DISC EJECT button.
- Change over the power switch (O↔O).

Note:

- If you press the REC or PHOTO button while in the sleep/restart standby status, the sleep/restart status will be released, but recording of a video or photo will not start. To record, press the REC or PHOTO button again.
- After the DVD video camera/recorder is restored from the sleep/restart standby status, the zoom position will return to 1 to 1.5x. The settings on manual focus, exposure and rear lighting will also reset to the initial values.
- The DVD video camera/recorder in sleep/restart standby status consumes approx. half the power it does during ordinary recording, but the recordable duration in that status will be longer than standing by in the recording pause status.
- If the sleep/restart standby status continues more than 30 minutes, the DVD video camera/recorder will turn off regardless of the Power Save setting (leaving the DVD video camera/recorder in recording pause status for 5 minutes will also turn it off: Default).
- Setting the power switch to OFF in the sleep/restart standby status will turn the DVD video camera/recorder off.

SLEEP/RESTART button

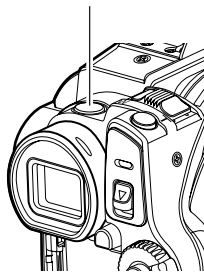

On-Screen Information

Various types of information will appear in the viewfinder or on the LCD screen during recording.

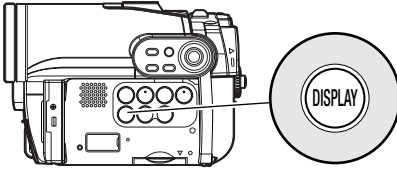





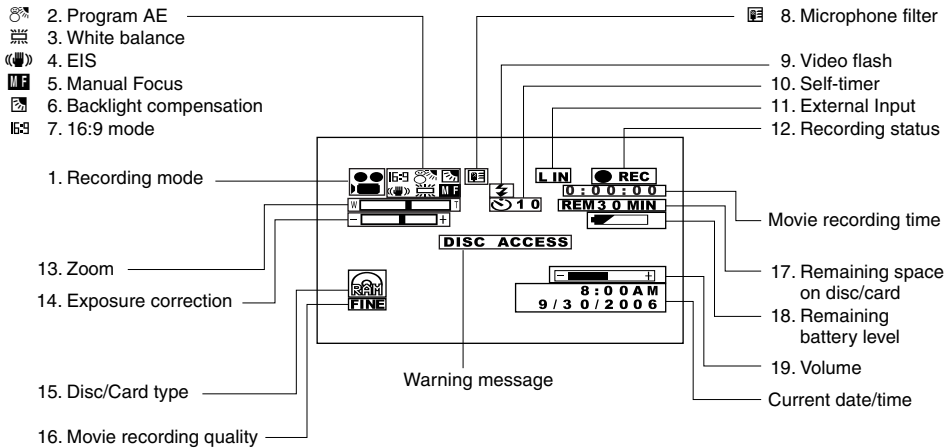

INFORMATION DISPLAY DURING RECORDING

See the next page for details.



The above screen is an example for explanation:
It is different from the actual display.





1. Recording mode (p. 41, 42, 65)

-  : Movie
-  : Still (Disc)
- *1 : External input still (field) (Disc)
- *1 : External input still (frame) (Disc)
-  : Still (Card)
- *1 : External input still (field) (Card)
- *1 : External input still (frame) (Card)

2. Program AE (only in movie recording mode) (p. 57)

- No display : Auto
-  : Sports
-  : Portrait
-  : Spotlight
-  : Sand & Snow
-  : Low Light



3. White balance (p. 58)

- No display : Auto
-  : Set
-  : Outdoor
-  : Indoor1
-  : Indoor2

4. Electronic image stabilizer (EIS)*2 (p. 60)

- No display : EIS OFF
-  : EIS ON

5. Manual focus (p. 53)

- No display : Autofocus
-  : (display in English or German): Manual focus
-  : (display in French or Italian): Manual focus
-  : (display in Spanish): Manual focus

6. Backlight compensation (p. 55)

- No display : Backlight compensation OFF
-  : Backlight compensation ON



7. 16:9 mode (only in movie recording mode) (p. 62)

- No display : 16:9 mode OFF
-  : 16:9 mode ON

8. Microphone filter (only in movie recording mode) (p. 60)

- No display : Microphone filter OFF
-  : Microphone filter ON

9. Video flash*3 [when Video Flash (sold separately) is attached] (only in still recording mode) (p. 56)

- No display : Emits light automatically
-  : Always emits light
-  : No light emission

10. Self-timer (only in still recording mode) (p. 65)

- No display : Self-timer OFF
-  : Self-timer ON
(countdown is from 10 seconds)



11. External Input (p. 65)*1

- L IN : AV input
- S IN : S-VIDEO input

12. Recording status

- REC : During recording
- II : During recording pause (lights in green)
When focus locks during photo recording (lights in purple)
- No display*4

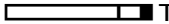













13. Zoom (p. 51)

- W  T
(Digital Zoom: Off)
- W  T
(Digital Zoom: 40×*5)
- W  T
(Digital Zoom: 500×*6 only in movie recording mode)

14. Exposure correction (p. 55)

- No display : Auto
-  + : Manual

15. Disc/Card type

	: DVD-RAM
	: DVD-RAM (write-protected)
	: DVD-RW (VR-mode/VF-mode)
	: Protected DVD-RW (VR-mode) disc
	: DVD-RW (VR-mode) disc finalized on this video camera/recorder
	: DVD-RW (VR-mode) disc finalized on a device other than this DVD video camera/recorder
	: Finalized DVD-RW (VF-mode) disc
	: DVD-R
	: DVD-R disc already finalized on this DVD video camera/recorder
	: DVD-R disc finalized on a device other than this DVD video camera/recorder
	: Includes DVD-R recorded on a Hitachi DVD video camera/recorder model older than DZ-GX3300A/GX3200A/GX3100A/BX37A/BX35A and not finalized.
	: +RW
	: Finalized +RW
	: SD memory card
	: Locked SD memory card

No display^{*7}

16. Movie recording quality (when using disc) (p. 61)

XTRA	: Best quality
FINE	: High quality
STD	: Standard quality

Still recording quality (when using card) (p. 64)

FINE	: High quality
NORM	: Standard quality
ECO	: Number of recordable stills is prioritized

17. Remaining space on disc/card^{*8}

REM XX	: Remaining recordable minutes
MIN ^{*9}	during movie recording
REM XX ^{*10}	: Number of remaining recordable still images during still recording

18. Remaining battery level (p. 30)

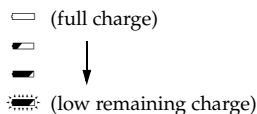

19. Volume (p. 70)



The volume can be adjusted during external input and playback.

*1 Not displayed on DZ-BX37A/BX35A.

*2 EIS cannot be used when recording photos on DZ-GX3300A/GX3200A/GX3100A.

*3 Displayed on DZ-GX3200A when the optional video flash is attached to it. Not displayed on DZ-GX3100A/BX37A/BX35A.

*4 When no disc or card is in the DVD video camera/recorder, or disc has not yet been initialized, a write-protected disc or locked card, or a disc or card with no remaining space, has been inserted.

*5 "60x" will appear on DZ-GX3100A; "100x" on DZ-BX37A/BX35A.

*6 "800x" will appear on DZ-GX3100A; "1,200x" on DZ-BX37A/BX35A.

*7 No display if no disc or card is loaded, or if a disc or card unusable on this DVD video camera/recorder is loaded.

*8 No remaining time or number will be displayed with a protected disc or locked card, or finalized DVD-RW (VF-mode)/DVD-R/+RW disc.

*9 In XTRA mode, possible recording time may be longer than the displayed time.

*10 The displayed number of recordable stills is for reference: This number may not decrease, depending on the recording conditions (not displayed with a DVD-RW/DVD-R/+RW disc).

● Switching the information display mode

You can switch the display mode of on-screen information:

Press the DISPLAY button.

The full and minimum display modes will alternate.

- **Full display mode:** All types of information will appear.
- **Minimum display mode:** The recording mode (see 1 on page 44) and recording status (see 12 on page 44) will appear. If the DVD video camera/recorder has warning information, a warning message will appear.

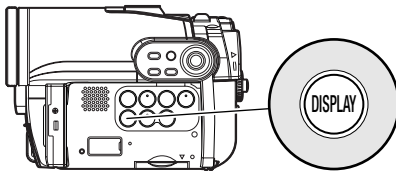

Note:

The DVD video camera/recorder does not record the date and time as a part of image. However, this information during recording will be recorded with image as data which can be checked on Disc Navigation screen during playback (see "INFORMATION DISPLAY DURING RECORDING" on page 44).

● Display when recording an image of yourself

When recording with the LCD screen facing the same direction as the lens, the operating status will appear: The battery remaining level will appear only when the remaining level is very low, and the display will blink.

The following operating status indicator will light or blink to give warning message to user. The message can be checked when returning the LCD monitor 180° to the original status from the status in which the LCD screen was facing the same direction as the lens.

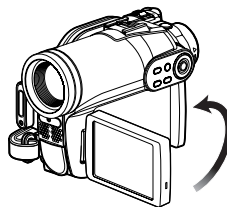





No warning/message (see page 44) will appear when recording with the LCD screen facing the same direction as the lens.

Instead, the following screen display symbols will blink to inform you of the operation status of DVD video camera/recorder.

When the LCD monitor is turned 180° from the position with the LCD screen facing the same direction as the lens, the warning/message can be checked.

● Interpreting symbols on LCD screen when recording with the screen facing the same direction as the lens:

Screen display symbol	Description
	<ul style="list-style-type: none"> • A write-protected disc is loaded. • A locked card is loaded.
	<ul style="list-style-type: none"> • An unusable card is loaded.
	<ul style="list-style-type: none"> • An attempt to record a still is being made with a DVD-RW/DVD-R/+RW disc used. • An unusable disc is loaded.
	<ul style="list-style-type: none"> • During recording (lights in red). • The remaining capacity on disc is approaching the limit 0 (blinks in red).
	<ul style="list-style-type: none"> • During recording pause (lights in green). • During focus lock (lights in purple). • The remaining capacity on disc or card is approaching the limit 0 (blinks in red). • There is no remaining capacity on disc or card (blinks in green). • An attempt to record a copy-guarded image is being made (blinks in green).

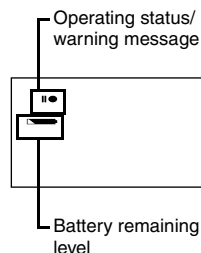

Note:

- If the LCD screen is set facing the same direction as the lens, the LCD screen will display a mirror image (left and right reversed).
- If the LCD screen is set facing the same direction as the lens, you can also view subject image in the viewfinder.
- Although you can switch to the manual focus, exposure and on-screen display modes even during recording with LCD screen facing the same direction as lens, they will not appear on the screen.
- When the LCD monitor is opened and turned 180° with the Program AE set to Low Light, the monitor screen will light white (see page 58).

Checking Flow of Menu

The following two on-screen menu modes are available with this DVD video camera/recorder:

- Full Menu: To display all menu items for experts
- Quick Menu: To display only the fundamental menu items for first timers

● Operating Menu

The Full Menu will appear if you press the MENU button.

You can use the **◀◀/▶▶/◀◀/▶▶** buttons on DVD video camera/recorder to select various setting options in Full Menu and designate them.

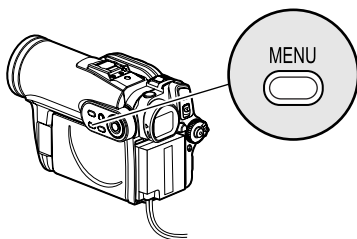

Press the MENU button.

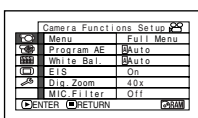

Press ▶▶ or ▶/||

The cursor to be chosen will move to the right.

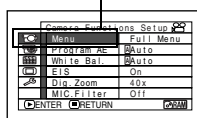
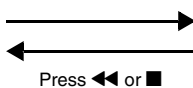

Press ▶▶ or ▶/||

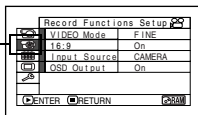

The cursor to be chosen will move down.

Press the ▶/|| button directly to choose an option from menu. To return to the screen one before, press the ■ button. Pressing the MENU button again will cause the Menu display to disappear.

Note:

- To display the Quick Menu, choose "Menu" -> "Quick Menu" on the Camera Functions Setup screen.

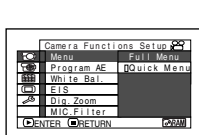

Press ▶▶ or ▶/||

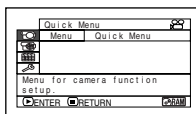

- Pressing the MENU button during recording will not display the menu.
- The menu screen will disappear when it is left for approx. one minute without any operation.

● Flow of Full Menu

■ The shaded menu item can also be set using the Quick Menu.
Refer to page indicated for details of each function.

Camera Functions Setup

Not displayed when external input is being selected.

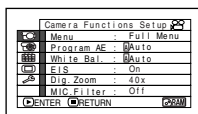

Menu (p. 49)

Program AE (p. 57)

White balance (p. 58)

EIS*1 (p. 60)

Digital zoom (p. 51)

Microphone filter*2 (p. 60)

Flash*3 (p. 56)

*1: Not displayed when DZ-GX3300A/GX3200A/GX3100A is in "☐" or "📷" status.

*2: Displayed only in "📷" status.

*3: Displayed when DZ-GX3300A is recording a photo (not displayed when the optional Video Flash is connected).

Record Functions Setup

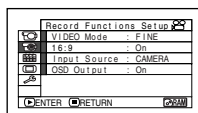

Movie quality*4 (p. 61)

16:9*5 (p. 62)

Input selection (p. 64)

External still input*6 (p. 65)

Self-timer*7 (p. 65)

On-screen information display output*8 (p. 66)

*4: Not displayed with DVD-RAM disc in "☐" status.

The quality mode is displayed in "📷" status. (p. 64)

*5: Not displayed in "☐" or "📷" status, or with external input.

*6: Displayed with DVD-RAM disc in "☐" status, or "📷", and input selection is set to external signal or S external signal.

*7: Displayed with DVD-RAM disc in "☐" status, or "📷" status.

*8: Displayed only when input selection is set to camera.

Date Setup

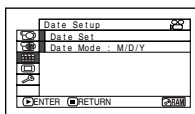

Date setting (p. 33)

Display format (p. 33)

LCD/EVF Setup

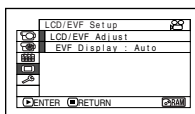

Adjust (p. 36)

EVF Display (p. 37)

Initial Setup

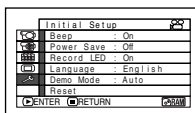

Beep (p. 34)

Power save (p. 34)

Recording LED (p. 35)

Language selection (p. 34)

Demo mode (p. 35)

Reset (p. 35)

Zooming

If you continue to hold the zoom lever on the “T” control side with Dig. Zoom specified, the digital zoom will be activated midway (when optical 10-power is exceeded on DZ-GX3300A/GX3200A, or optical 15-power is exceeded on DZ-GX3100A or optical 25-power is exceeded on DZ-BX37A/BX35A).

You can zoom up to 500-power on DZ-GX3300A/GX3200A; up to 800-power on DZ-GX3100A; up to 1,200-power on DZ-BX37A/BX35A.

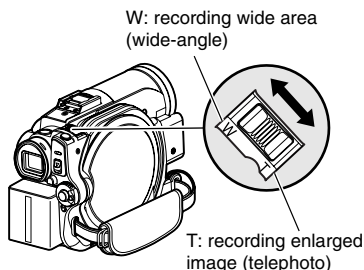

- 1 Press the MENU button, choose “Dig. Zoom” on the “Camera Functions Setup” menu screen, and then press the ►/|| button.
- 2 Choose the desired magnification, and then press the ►/|| button.
- 3 Press the MENU button to end the setting.

Moving the zoom lever will display the digital zoom bar.

Note:

- The digital zoom setting will be stored in memory even if the DVD video camera/recorder is turned off.
- You can also use the DIGITAL ZOOM button on remote control to switch the digital zoom setting: Pressing the button during movie recording will switch the setting between “Off”, “40x”^{*1}, and “500x”^{*2}; Pressing the button during photo recording will switch between “Off” and “40x”^{*1}.
- If you set zoom to “500x”^{*2} when recording photo, the digital zoom will be up to 40x^{*1}.
- When a subject is zoomed, it may be momentarily out of focus.
- When digital zoom is engaged, the image quality will be rougher.

*1 “60x” on DZ-GX3100A; “100x” on DZ-BX37A/BX35A.

*2 “800x” on DZ-GX3100A; “1,200x” on DZ-BX37A/BX35A.

MACRO RECORDING

Use the macro function when recording a small object from close-up position: You can shoot the subject as close as approximately 13/16” (2 cm) from the lens surface, magnifying the image to fill the screen.

- 1 Aim the DVD video camera/recorder at the subject, and press the zoom lever to “W” control side.

Note:

- Zoom can be used, but the subject may not be focused, depending on the distance to the subject. In this case, move the zoom to “W” control side to focus.
- The amount of light tends to be insufficient during macro recording: If the subject image is too dark, use additional lighting.

RECORDING SUBJECTS FOR STRONGER WIDE-ANGLE OR TELEPHOTO EFFECT

Use the tele-conversion lens or wide-conversion lens with the following filter diameter and thread pitch to record subjects for stronger telephoto or wide-angle effect:

Filter diameter: 37 mm for DZ-GX3300A; 34 mm for DZ-GX3200A/BX37A/BX35A; 30.5 mm for DZ-GX3100A

Thread pitch: 0.75 mm for DZ-GX3300A; 0.5 mm for DZ-GX3200A/GX3100A/BX37A/BX35A

When attaching the optional DZ-TL1 tele-conversion lens or DZ-WL1 wide-conversion lens, use the optional step-up ring: DZ-SR3437 for DZ-GX3200A/BX37A/BX35A, DZ-SR3037 for DZ-GX3100A (see page 132).

1 Remove the lens hood from DVD video camera/recorder, and attach the step-up ring over the lens.

When using the DZ-GX3100A, you need not remove the lens hood.

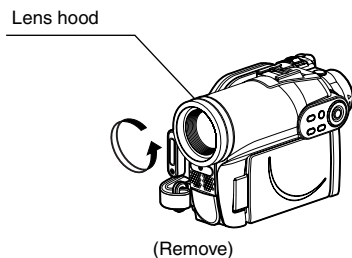

2 Remove the cap of conversion lens, and screw the lens into the thread of step-up ring.

When using the DZ-GX3300A, you need not use the step-up ring.

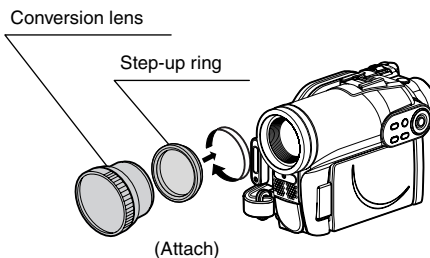

- Tele-conversion lens: For stronger telephoto effect
- Wide-conversion lens: For stronger wide-angle effect

Note:

- Be careful not to lose the removed lens hood.
- With DZ-TL1 tele-conversion lens, the focusing range at "T" (telephoto) control side is between approx. 16 feet (5 m) and infinite.
- When a conversion lens is attached, note that the four corners of screen will be slightly dim if you zoom in on a subject on the W control side (wide-angle side).
- When replacing the lens, take care not to drop the DVD video camera/recorder.
- Attaching the conversion lens will disable the function of the built-in flash (for DZ-GX3300A only): Specify "Flash: Off" (see page 56).
- If a generally available filter is attached, do not attach the removed lens hood.
- Some generally available conversion lenses may not be usable on this DVD video camera/recorder, depending on the lens maker.

Manually Focusing Subject

The DVD video camera/recorder usually focuses on a subject automatically (autofocus). You can also manually focus a subject depending on the recording conditions.

FOCUSING DURING RECORDING

Normally, the DVD video camera/recorder automatically focuses the subject (autofocus), but you can also manually focus a subject, depending on the recording conditions (manual focus).

Focusing range

You can switch the display mode of on-screen information:

- On T (tele) side: approximately 3.2 feet (1 m) from lens surface to infinity
- On W (wide) side: approximately 13/16" (2 cm) from lens surface to infinity

1 Press the FOCUS button during recording.

"MF" will appear on the screen.

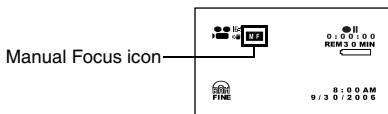

2 Press the zoom lever to "T" control side to zoom in on subject.

3 Use the ⊖ ⊕ buttons to adjust the focus, while viewing the image in the viewfinder or on the LCD screen.

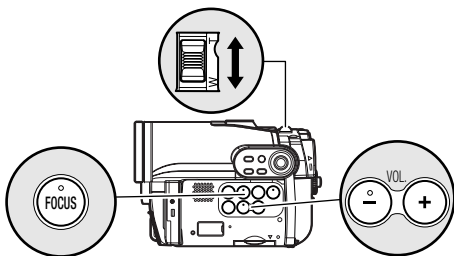

Adjust with ⊖ and ⊕ buttons

Note:

- Pressing FOCUS will alternate between manual focus and auto focus. With auto focus, no indication will appear on the screen.
- Be sure to zoom in on your subject before manually focusing on it. If you bring the subject into focus at the "W" control side, focus will be faulty when you turn the zoom lever to the "T" control side to zoom in on the subject.
- Manual focus is released when the DVD video camera/recorder is turned off. When you turn the DVD video camera/recorder on next time, auto focus will be restored.

Manually focus the following objects, which may not be automatically focused (see page 53):

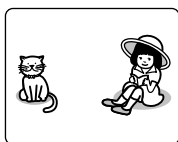

Objects not in the center of screen

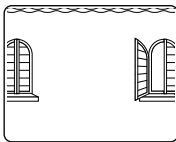

Objects with little variation in brightness, such as white wall

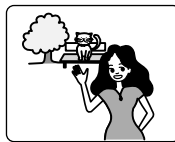

Objects that are far and near at the same time



Objects moving rapidly



Objects lit by neon sign, spotlight, etc. which glares or emits strong light



Dark objects



Object behind glass with water droplets, dirt on it



Night view

Adjusting Brightness of Image to be recorded (Exposure)

The DVD video camera/recorder usually adjusts the exposure automatically. You can also manually adjust the exposure depending on the recording conditions.

1 Press the EXPOSURE button during recording.

The exposure adjustment bar will appear on the screen.

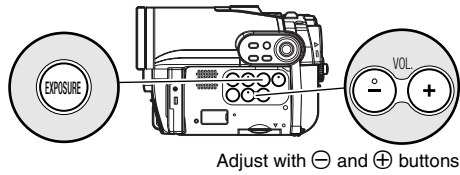
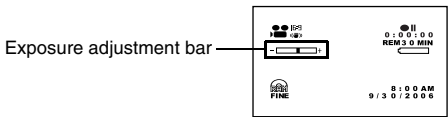

Adjust with ⊖ and ⊕ buttons

2 Use the ⊖ ⊕ buttons to adjust the exposure, while viewing the image in the viewfinder or on the LCD screen.

- Note:**
- Pressing EXPOSURE will alternate between manual adjustment and auto exposure. With auto exposure, no indication will appear on the screen.
 - The exposure setting will return to Auto when the DVD video camera/recorder is turned off.

Compensating for Backlight

When subject is lighted from rear, this function will compensate for lighting so that the subject is not too dark.

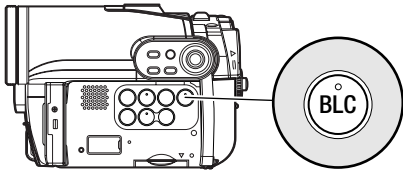

1 Press the BLC button during recording.

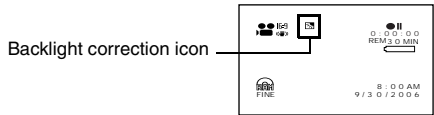

The backlight correction icon will appear.

- Note:**
- Pressing the BLC button will alternate between backlight setting between on and off.
 - The backlight setting will automatically return to "off" when the DVD video camera/recorder is turned off.

Built-in Video Flash (for DZ-GX3300A only)

When recording photos in a dark place, or if the subject is lit from rear, the DZ-GX3300A makes use of the built-in Video Flash for automatic brightening. The Video Flash can also be set to On where the light is always being emitted, or Off when you wish to record without using the flash even in a dark place.

Setting	On-screen display	Manner of emitting light
Auto	⚡ when the PHOTO button is pressed	Automatically emits light in dark place or in a spot lit from rear.
On	⚡	Always emits light regardless of brightness.
Off	⚡	No light emission.

1 Press the MENU button, and choose Flash from the Camera Functions Setup menu.

2 Choose the option for Flash and decide it.

3 Press the MENU button to end the setting.

* Displayed when using DZ-GX3300A to record photo (not displayed when the optional Video Flash is connected).

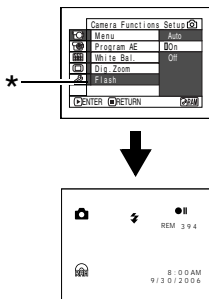

● Optional Video Flash (for DZ-GX3300A/GX3200A only)

See “Introduction to Optional Accessories” on page 132.

You can use the optional DZ-FLH3 Video Flash* (p. 132): Refer to the instruction manual of Video Flash for use.

* Unavailable for DZ-GX3100A/BX37A/BX35A.

Note:

- The built-in Video Flash setting will not change even when the DVD video camera/recorder is turned off. Unless recording is to be made with the fixed Flash setting, it is recommended to return it to “Auto” after recording with the “On” or “Off” setting, before turning the DVD video camera/recorder off.
- When recording dark subjects, the shutter speed will be slower, so don’t let the camera shake.

- However, dark subjects may not be in clear focus even if the Video Flash is used. It is recommended that you light a subject when recording in a dark place.
- The Video Flash built into DZ-GX3300A cannot be used when a conversion lens is attached: Specify “Flash: Off”
- The Video Flash automatically adjusts the amount of light emitted, but the light amount adjustment may be insufficient when a subject is too far away or too near.
- If you continuously record using the Flash, the Flash may not emit light or the amount of light may not be adjustable. After recording using the Flash, it is recommended that you wait for a few moments, before pressing the PHOTO button to record.
- The distance for the built-in Video Flash to adjust the appropriate amount of light will vary depending on the subject, but it is approximately 3.2 – 8.2 feet (1 – 2.5 m).
- When recording a close-up photo, specify Flash: Off. Using the flash too near subject could cause a whitish image.
- “⚡” will blink during charging of the battery for Video Flash.
- While “⚡” is flashing, the video flash will not emit light, though the DVD camera/recorder is recording.
- Do not use the Video Flash when approaching the human eye. Emitting light from Video Flash near human eye could damage the subject’s eyesight. Especially when recording a baby or small child, move the DVD video camera/recorder at least 3.2 feet (1 m) away.
- Do not use the Video Flash while pointing it at a driver in vehicle: Doing so could dazzle the driver, causing an accident.
- Do not use the Video Flash in a place where there is flammable or explosive gas: Doing so could cause fire or explosion.
- When the DZ-FLH3 is attached to DZ-GX3300A, the built-in video flash in DZ-GX3300A will not operate.

Setting Up Camera Functions

Before You Begin

- See page 49 for how to set.
- No menu screen appears with external input.

SELECTING SHOOTING MODE TO MATCH THE SUBJECT (SWITCHING PROGRAM AE MODE)

This DVD video camera/recorder automatically detects the status of subject and surrounding situation and records the optimum image: If you choose the shooting mode to match the recording conditions, clearer images will be recorded.

- 1 Press the MENU button, use the **◀◀/▶▶/▶▶/▶▶** buttons to choose "Program AE" on the "Camera Functions Setup" screen, and then press the **▶/||** button.

The options will appear on the right of "Program AE".

- 2 Use the **◀◀/▶▶/▶▶/▶▶** buttons to choose the desired option, and then press the **▶/||** button: The selected option will be set.

- 3 Press the MENU button to end the setting.

The menu screen will disappear.

Note:

- You can check the selected AE mode by the on-screen information display. However, nothing will appear in the Auto mode.
- The shooting mode set as above will be stored in memory even if the DVD video camera/recorder is turned off.
- When recording in a dark area, an after-image will appear when filming a moving subject or if camera shake occurs (it is therefore recommended that you use a tripod in such cases).
- If the Sports mode is used under a fluorescent light, the image may flicker: In this case, use the Auto mode for recording.

A Auto : The camera/recorder automatically judges the subject and surrounding environment for optimum recording.

🏏 Sports : Reduces blurring when recording rapidly moving subjects such as in golf or tennis.

👤 Portrait : Makes a subject, such as a person or a creature, stand out from a blurred background.

☀️ Spotlight : Prevents overexposure of subject portrait face, etc. when strong light strikes the subject, as in a wedding or on stage.

❄️ Sand & Snow : Prevents underexposure of subject portrait face, etc. in a place where reflection of light is intense, such as at the seaside in midsummer or on a ski slope.

📵 Low Light : Allows user to record in a dark place even with decreased lighting.

Turn the LCD monitor 180° during recording: The LCD monitor light can then be used for recording.

RECORDING DARK SUBJECTS USING LCD MONITOR LIGHT

When Program AE is set to Low Light, you can use the light from LCD monitor to record a subject.

1 Press the MENU button, and choose “Program AE” from the “Camera Functions Setup” menu.

2 Choose “Low Light”, and designate it.

3 Press the MENU button to end the setting.

4 Open the LCD monitor, turn it 180° so that it faces the same direction as the lens: The LCD monitor will light white.

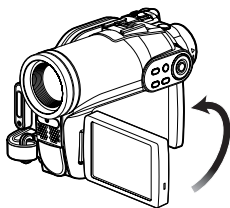

Note:

- Use the viewfinder to check the image to be recorded.
- The LCD monitor light allows you to record a subject up to 3.2 feet (1 m) even in a dark place.
- An after-image will appear when filming a moving subject or if camera shake occurs (it is recommended that you use a tripod).
- If a subject cannot be focused properly, manually adjust the focus (see page 53).

ADJUSTING COLOR (WHITE BALANCE)

This DVD video camera/recorder automatically adjusts the color of subject. Change the white balance setting depending on the recording conditions.

Mode	Setting content	On-screen display
Auto	White balance always automatically adjusted	None
Set	You can manually adjust white balance to match the light source or situation (p. 59)	
Outdoor	To record in fine weather	
Indoor 1	To record under incandescent light, halogen light or bulb-color type fluorescent light	
Indoor 2	To record under fluorescent light	

- 1 Press the MENU button, choose “White Bal.” on the “Camera Functions Setup” menu screen, and then press the **▶/||** button.
- 2 Choose the desired option, and then press the **▶/||** button.
- 3 Press the MENU button to end the setting.

Note:

- The white balance mode can be confirmed using the on-screen information.
- The white balance setting will be stored in memory even when the DVD video camera/recorder is turned off.
- Do not block the infrared sensor with hand, etc.

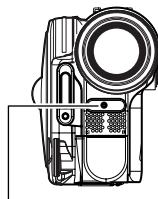



Infrared sensor block

- If a tele or wide-conversion lens is used, the auto white balance may not operate depending on the recording conditions. If this happens, set to the mode to match the recording conditions, or manually set the white balance.
- Be sure to remove the lens cap before turning the DVD video camera/recorder on: If the DVD video camera/recorder is turned on with the lens capped, the white balance will not work normally.

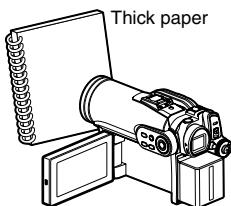

● Setting white balance manually

- 1 Point the DVD video camera/recorder at a white object so that it fills the screen. Use an object that is not transparent. If focus is not correct when the white object fills the screen, manually focus the object, referring to “Manually Focusing Subject” (see page 53).



- 2 Press the MENU button, choose “White Bal.”, “Set”, and then press the **▶/||** button.
- 3 Hold **▶/||** pressed until the “” indicator changes from blinking to a steady light. When the “” indicator lights, the white balance setting will be complete.
- 4 Press the **■** button to end the setting.

Note:

- The white balance set using the “Set” option will be stored in memory until it is re-set.
- Do not use a colored object when setting the white balance: The appropriate tint cannot be set.
- If “Input Source: LINE, S-LINE” has been specified, you cannot use the “Set” mode of white balance (p. 64).
- The setting on white balance “Set” may not be possible in a dark place. Also, the white balance cannot be set when the zoom bar is in the digital zoom range (p. 51). In such status, the “” indicator will remain blinking. Set the white balance in a bright place with “Dig. Zoom Off” specified.
- If the recording conditions have changed, re-set the white balance for appropriate colors.
- The setting will be stored in memory even when the DVD video camera/recorder is turned off: The “” indicator will blink when the DVD video camera/recorder is turned on next time. Re-set the white balance as needed.

USING THE ELECTRONIC IMAGE STABILIZER (EIS)

When you use zoom (see page 51) to record a magnified subject image, it will correct fuzziness in the recorded image.

- 1 Press the MENU button, choose "EIS" on the "Camera Functions Setup" menu screen, and then press the ►/|| button.
- 2 Choose the "On" or "Off", and then press the ►/|| button.
- 3 Press the MENU button to end the setting.

● Checking EIS On or Off

You can check EIS On or Off by the on-screen information display.

After recording with EIS set to "Off", it is recommended that you return the setting to "On" and then turn the DVD video camera/recorder off, unless you normally record with "Off" setting.

Note:

- The EIS setting will be stored in memory even when the DVD video camera/recorder is turned off.
- It is recommended that you specify "EIS Off" when using the DVD video camera/recorder on a desk or tripod.
- When "EIS On" is specified, there will be a slight difference between the actual movement and the movement on screen.
- Gross camera shake may not be entirely corrected even if "EIS On" is specified: Firmly hold the DVD video camera/recorder with both hands.
- EIS may not operate correctly when the tele or wide-conversion lens is used.
- EIS cannot be used when recording photos on DZ-GX3300A/GX3200A/GX3100A.

RECORDING SUBJECT USING LARGE MAGNIFICATION (DIGITAL ZOOM)

See page 51 for setting on digital zoom.

REDUCING WIND NOISE DURING RECORDING (MIC.FILTER)

When recording sound from the microphone built into this DVD video camera/recorder, you can reduce wind noise in recording.

If "MIC.Filter: ON" is specified, the low-frequency components in the sound picked up by microphone will be cut off during recording: This makes it easier to hear the target voice or sound during playback.

- 1 Press the MENU button, choose "MIC.Filter" on the "Camera Functions Setup" menu screen, and then press the ►/|| button.
- 2 Choose the desired option, and then press the ►/|| button.
- 3 Press the MENU button to end the setting.

Note:

- You can also use the on-screen display to confirm that the MIC.Filter has been set.
- The MIC.Filter setting will be stored in memory even when the DVD video camera/recorder is turned off.
- The MIC.Filter function will work only during movie recording.
- The microphone filter function works only with the built-in microphone: It will not function when using an external microphone (p. 66).

Setting Up Record Functions

RAM RW VR RW VF R +RW

SWITCHING MOVIE QUALITY (VIDEO MODE)

Choose the movie quality from "XTRA", "FINE", "STD".

It is recommended that you record critical subjects in the "XTRA" or "FINE" mode.

1 Press the MENU button, use the **◀◀/▶▶/▶▶/▶▶/▶▶/▶▶** buttons to choose "VIDEO Mode" on the "Record Functions Setup" menu screen, and then press the **▶▶/▶▶** button.

2 Choose the desired quality mode, and then press the **▶▶/▶▶** button.

3 Press the MENU button to end the setting.

Note:

- The movie quality setting will be stored in memory even when the DVD video camera/recorder is turned off.
- When using a DVD-RW (VF-mode)/DVD-R disc, the "VIDEO Mode" setting will not change even if the disc is replaced.
- When using DVD-RW (VF-mode)/DVD-R disc, you cannot switch the setting on movie quality or wide-screen mode while recording on the disc: The DVD video camera/recorder will be automatically set to the movie quality or wide-screen mode first used with the disc for recording.
- When using a DVD-RW (VF-mode)/DVD-R/+RW: You cannot specify the combination of "VIDEO Mode: STD" and "16:9 On". If you specify "16:9 On" and try to switch the VIDEO Mode to STD from XTRA or FINE, the screen will automatically switch to the 4:3 aspect ratio display.
- The movie quality setting is effective only during movie recording: The setting will not be displayed during recording of stills.

Block-like noise may appear in recorded image, or the outline of subject image is distorted under the recording conditions listed below. Pan the DVD video camera/recorder as slowly as possible. (Block noise is likely to appear in the "STD" mode):

- If there is a complicated pattern in background (as in following figure on left);
- If the DVD video camera/recorder is moved excessively or quickly;
- If subject is moving rapidly even when the DVD video camera/recorder is not moving.

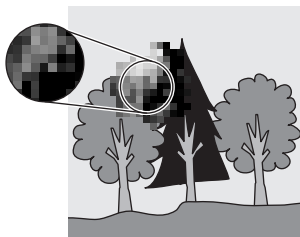

(Image when block-like noise occurs)



(Image without block-like noise)

SETTING TO WIDE TV SCREEN MODE (16:9 MODE)

When viewing recorded images later on a wide-screen TV (aspect ratio 16:9), specify wide-screen (16:9) mode "On": You can also record images with the aspect ratio changed (the aspect ratio with "Off" is 4:3).

The following figures compare the images displayed on LCD monitor and in viewfinder when the wide-screen mode is "on" and "off".

"16:9 On" specified
(aspect ratio 16:9)

"16:9 Off" specified
(aspect ratio 4:3)

When using DZ-GX3300A

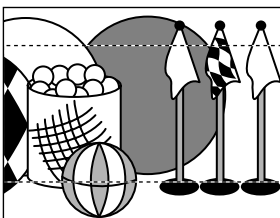
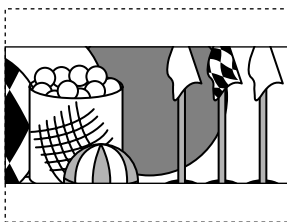

When using DZ-GX3200A/GX3100A/BX37A/BX35A

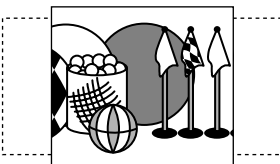
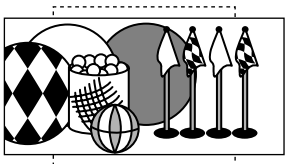

- 1** Press the MENU button, choose "16:9" on the "Record Setup Functions" menu screen, and then press the ►/|| button.
- 2** Choose "On", and then press the ►/|| button.
- 3** Press the MENU button to end the setting.

When viewing playback on an ordinary TV screen later, specify "16:9 Off": Recording with "16:9 On" specified will be played back on an ordinary TV with longer vertical direction of image.

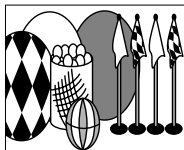

An image recorded with “16:9 On” specified will appear as follows:

Display on LCD monitor screen

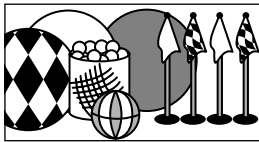

Display in viewfinder

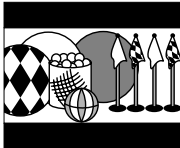

Images recorded with “16:9 Off” specified will appear as follows:

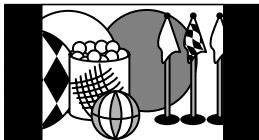

Display on LCD monitor screen

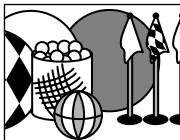

Display in viewfinder



Note:

- The 16:9 setting will be kept even after the DVD video camera/recorder is turned off.
- The 16:9 mode cannot be used with photo recording, external input*, S-VIDEO external input*.
- When using a DVD-RW (VF-mode)/DVD-R/+RW:
You cannot specify the combination of “VIDEO Mode: STD” and “16:9 On”. If you specify “16:9 On” and try to switch the VIDEO Mode to STD from XTRA or FINE, the screen will automatically switch to the 4:3-aspect ratio display.
- Once the DVD-RW (VF-mode)/DVD-R disc has been recorded in the wide-screen mode, you will not be able to switch to recording of external input* or S-VIDEO external input* using the same disc.
- When using DVD-RW (VF-mode)/DVD-R, switching between wide mode (16:9) and normal mode (4:3) will not be possible while using the same disc.
- Images recorded with “16:9 On” (aspect ratio 16:9) specified will be played back with the setting used during recording regardless of the 16:9 setting then being used.
- The 16:9 setting is not compatible with ID-1/ID-2**.
- To view images recorded at 16:9 setting, switch the aspect ratio of your TV: See TV instruction manual for this switching.
- When using a video selector, the TV may not automatically be switched to 16:9 mode.
- When the power switch is set to “” or “”, the aspect ratio of screen in recording pause will be 4:3 regardless of the setting on 16:9 wide mode.
- If you connect the DVD video camera/recorder with a disc recorded in wide mode to a TV with 4:3 display only and play it back, vertically long images will appear. To display 4:3 images, set “TV aspect type” (p. 105) to 4:3 and view the images.
- If you play back a +RW recorded in wide mode on a DVD recorder/player, etc., vertically long images will appear even on a wide-screen TV. In this case, change the setting on the DVD recorder/player, or set “TV aspect type” (p. 105) to 4:3 and view the images.

* The DZ-BX37A/BX35A cannot receive any externally input signal.

**This system records the aspect ratio (16:9, 4:3) information in void space between video signals.

SWITCHING QUALITY OF STILL IMAGE (QUALITY)

You can switch the still recording quality only when using card.

It is recommended that you use "FINE" when recording vital images (p. 152 "SIZE AND QUALITY OF PHOTOS").

- 1 Press the MENU button, use the **◀◀/▶▶/▶▶/▶▶/▶▶/▶▶** buttons to choose "Quality" on the "Record Functions Setup" menu screen, and then press the **▶▶/||** button.
- 2 Choose the option you want, and then press the **▶▶/||** button.

- 3 Press the MENU button to end the setting.

Note:

- The still quality setting will be stored in memory even when the DVD video camera/recorder is turned off.
- The quality of photos recorded on DVD-RAM is equivalent to "FINE" on card.

RAM RW VR RW VF R +RW CARD

RECEIVING IMAGE FROM ANOTHER DEVICE (INPUT SOURCE)

If you wish to input an image from another device to this DVD video camera/recorder, you must first switch the setting on the DVD video camera/recorder. Refer to the explanation starting from page 109 on how to connect the DVD video camera/recorder to other devices or record images input from them. The DZ-BX37A/BX35A cannot receive any externally input signal.

Setting	Content	On-screen display
CAMERA	Usually select this option	No display
LINE	To input image from another device	L IN
S LINE	To input S-VIDEO signal from another device	S IN

- 1 Press the MENU button, use the **◀◀/▶▶/▶▶/▶▶/▶▶/▶▶** buttons to choose "Input Source" on the "Record Functions Setup" menu screen, and then press the **▶▶/||** button.
- 2 Choose "LINE", and then press the **▶▶/||** button.





- 3 Press the MENU button to end the setting.

Note:
The "Input Source" setting will return to "CAMERA" whenever the DVD video camera/recorder is turned off.

SWITCHING EXTERNAL INPUT RECORDING METHOD (PHOTO INPUT)

When “Input Source: LINE or S LINE” is specified, you can record stills of externally input images on either a DVD-RAM disc or a card. The DVD video camera/recorder can record an external image with little movement by specifying “Frame”, but “Field” is recommended for recording image with movement.

The DZ-BX37A/BX35A cannot receive any externally input signal.

Recording format	Details of setting	On-screen display	
		DVD-RAM	card
Frame	Does not suit recording of frequently moving video subjects, despite high image quality. Frame suits recording of less moving video.		
Field	Suitable for recording of frequently moving video subjects.		

1 Press the MENU button, use the **◀◀/▶▶/▶▶/▶▶/▶▶/▶▶** buttons to choose “PHOTO Input” on the “Record Functions Setup” menu screen, and then press the **▶/||** button.

2 Select the desired option and then press the **▶/||** button.

3 Press the MENU button to end the setting.

Note:

- The PHOTO Input setting can be confirmed using the on-screen information.
- The PHOTO Input setting will be stored in memory even when the DVD video camera/recorder is turned off.
- Refer to “Recording (Dubbing) Images”, p. 109 to see how to connect the DVD video camera/recorder to another device.

SELF-TIMER

You can record photos using the self-timer function, as with ordinary cameras.

The self-timer function is valid only when recording photos (stills).

1 Press the MENU button, use the **◀◀/▶▶/▶▶/▶▶/▶▶/▶▶** buttons to choose “Self Timer” on the “Record Functions Setup” menu screen, and then press the **▶/||** button.

2 Select “On”, and then press the **▶/||** button.

The self-timer will be set.

3 Press the MENU button to end the setting.

4 Press the PHOTO button.

The recording indicator at the front of DVD video camera/recorder will blink.
The self-timer indicator will start to count down, and recording will commence approximately 10 seconds later.

Note:

- You can also check that self-timer has been set by reviewing the on-screen information.
- To release the self-timer mode, choose “Off” on the menu screen or turn DVD video camera/recorder off.
- To suspend self-timer, press the PHOTO button again before recording starts, or press the **■** button.

SETTING ON-SCREEN DISPLAY OUTPUT ON OR OFF (OSD OUTPUT)

If you connect this DVD video camera/recorder to a TV to view images on TV screen, you can switch off the on-screen information (displayed in the viewfinder or on the LCD screen) from the TV screen.

- 1 Press the MENU button, use the **◀◀/▶▶/▶▶/▶▶/▶▶/▶▶** buttons to choose "OSD Output" on the "Record Functions Setup" menu screen, and then press the **▶▶/▶▶** button.
- 2 Choose "On" or "Off", and press the **▶▶/▶▶** button.

Note:

- The "OSD Output" setting will be stored in memory even when the DVD video camera/recorder is turned off.
- Even if "Off" is chosen, the on-screen information will appear during playback. See page 74 for playback on-screen information display.
- Even after the on-screen information is removed from the TV screen, it will still appear in the viewfinder or on the LCD screen.
- The on-screen display output functions only when the input selection is set to camera: It cannot be set during external input.

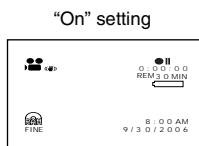

TV screen

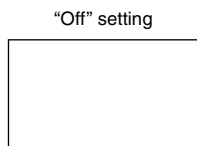

TV screen

Using External Microphone

Connect external microphone (generally available) to the external microphone jack of this DVD video camera/recorder. Clearer sound can be recorded. Turn on the switch on external microphone and start recording. For details on external microphone, see "Major Specifications" on page 148.

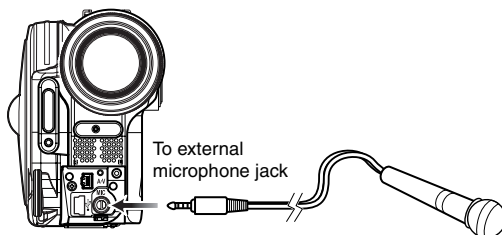

Note:

- Depending on the shape of its plug, an external microphone cannot be plugged in, while the cable is left plugged in the AV/S input/output terminal. Unplug the AV/S input/output cable to use the external microphone.
- This DVD video camera/recorder cannot use a plug-in power type microphone. (Power is not supplied from this DVD video camera/recorder.)
- Connecting an external microphone will switch off the built-in microphone.
- The DZ-BX37A/BX35A cannot use any external microphone.

Using Disc Navigation



STARTING OR TERMINATING DISC NAVIGATION

Disc Navigation is a tool for editing scenes recorded on this DVD video camera/recorder.

Here is an explanation of “scene” and “program”, so that you will be able to make most use of Disc Navigation function.

The screens in this instruction manual are basically those that will appear when DVD-RAM disc is used: Some items will not appear when DVD-RW/DVD-R/+RW disc or card is used, but the operation is the same.

Before You Begin

- Turn the DVD video camera/recorder on (p. 31).
- When using disc: Set the power switch to “” or “”.
- When using card: Set the power switch to “”.

1 Press the DISC NAVIGATION button.

The Disc Navigation screen (shown on page 68) will appear.

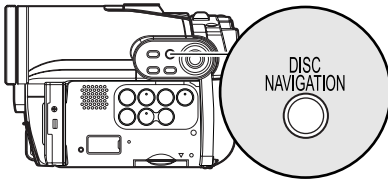

2 Press the DISC NAVIGATION button again.

Disc Navigation will be terminated and the DVD video camera/recorder will enter the recording pause status.

You can also press the  button to end Disc Navigation.

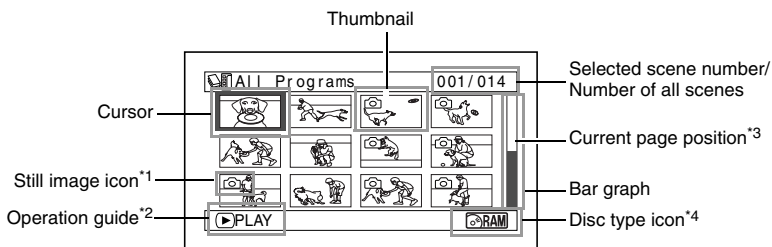

*1 No still icon will appear for card.

*2 The operation guide will vary depending on the operation status of DVD video camera/recorder.

*3 Appears when 13 scenes or more have been recorded.

*4 "RAM" will appear for card.

Icons to be displayed on thumbnail:

 Photo (p. 42)

 Skip (p. 83)

 Fade-in (p. 82)

 Fade-out (p. 82)

 Lock (p. 86)

Note:

- Pressing the DISPLAY button will display the recording date/time of the scene on which the cursor is placed in the space for operating guide. Pressing DISPLAY again will display the operating guide.
- If no disc or card is inserted, the Disc navigation screen cannot be displayed even by pressing the DISC NAVIGATION button.
- Each time Disc Navigation is started with a DVD-RW (VF-mode)/DVD-R disc inserted, message "Creating Thumbnail ..." will appear. After the message appears, the Disc Navigation screen will appear.
- If the following disc or card is inserted, the Disc Navigation screen will appear or some message will be displayed:
 - Write-protected disc
 - Finalized DVD-RW (VF-mode)/DVD-R/+RW disc
 - DVD-RW (VF-mode)/DVD-R recorded on a Hitachi DVD video camera/recorder model older than DZ-GX3300A/GX3200A/GX3100A/BX37A/BX35A
 - Locked card
- Do not leave the disc navigation screen displayed on TV to which the DVD video camera/recorder is connected: Doing so could damage the TV screen, possibly by burning.

PLAYING BACK FROM DISC NAVIGATION SCREEN

1 Press the DISC NAVIGATION button.

2 Use the **◀◀/▶▶/◀◀/▶▶** buttons to select the desired scene.

The selected scene will be framed: This is called a “cursor”.

3 Press the **▶/||** button.

Playback will start from the selected scene.

Note:

Pressing the **◀◀** or **▶▶** button will move the cursor to the preceding or following scene.

Pressing the **◀◀** or **▶▶** button will move to preceding or following page.

● When playback ends:

The DVD video camera/recorder will enter the playback pause status at the last image of last scene. Pressing the **■** or DISC NAVIGATION button will restore the Disc Navigation screen.

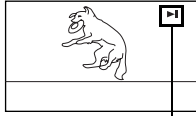

Playback pause

When the playback pause status continues for as long as 5 minutes, the Disc Navigation screen will automatically be restored.

Note:

- Press the **▶/||** button to temporarily stop playback. Pressing **▶/||** again will start from that point.
- If you press the **▶/||** button after playback of the last scene on disc finishes, playback will start again from the beginning of disc.
- Pressing the **■** button will always restore the Disc Navigation screen.
- When playing back photos on card, “Playback” will appear. In the case of a photo with a large number of pixels, it will take some time for the photo to appear.

● Playing back photos

A photo on DVD-RAM disc will be displayed for approx. 3 seconds. When playing back photos on card, playback will stop after each photo playback.

Before You Begin

- Insert a disc or card recorded on this DVD video camera/recorder (p. 41, 42).
- Turn the DVD video camera/recorder on (p. 31).

RAM RW VR RW VF R +RW CARD

PLAYING BACK LATEST RECORDED SCENE

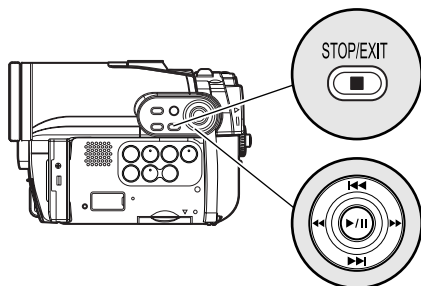

Use ◀◀ / ▶▶ / ◀◀ / ▶▶ to select, and then press ▶/|| to designate.

- 1 Press the ▶/|| button in the recording pause status.

The DVD video camera/recorder will enter the playback mode, and the scene you have recorded last will be played back. (For “scene”, see p. 67.)

When playback is finished, the DVD video camera/recorder will enter the pause status at the last image on disc.

If the playback pause status continues for as long as 5 minutes, the DVD video camera/recorder will automatically return to the recording pause status.

- 2 Press the ■ button.

Playback will stop, and recording pause status will be restored.

Note:

- If the LCD monitor is open during playback of movie, playback sound will be heard from the speaker. Adjust the sound volume using the volume control buttons (⊖, ⊕).
- To temporarily stop playback, press the ▶/|| button. Press the ▶/|| button again to restart playback.
- Even if you stop playback midway and immediately start recording again, the new image will be recorded after the last scene on disc or card (the previous images will not be overwritten).
- Image data edited on PC, etc., or the recorded image may not appear on this DVD video camera/recorder; also, the recorded sound may not play back, depending on the type of image data.
- Image data recorded on another DVD video camera/recorder or DVD recorder may not be played on this DVD video camera/recorder.
- Depending on the amount of data to be played back, it may take some time for the playback image to appear.
- Do not operate the power switch or remove the card while the ACCESS/PC or CARD ACCESS indicator is lit or blinking. Doing so may damage the card or the data on card.
- If a disc recorded is used at high temperatures, normal playback may be impossible: Turn the DVD video camera/recorder off once, wait until the ambient temperature becomes lower, and then operate it again.

RAM RW VR +RW CARD

DELETING LAST RECORDED SCENE

- 1 Press the MENU button during playback.

- 2 Choose “Edit”, “Delete Scene”, and then press ▶/||.

The screen for verifying deletion will appear.

- 3 Choose “YES”, and then press ▶/||.

The last recorded scene will be deleted, and the recording pause status will be restored.

Note:

- If you press the MENU button during playback using the Disc Navigation menu, “Delete Scene” will not appear.

RAM RW VR RW VF R +RW CARD

CAPTURING PHOTO

You can record an image displayed during playback of video as a photo on a card.

- 1 Press the MENU button at a scene you wish to capture during playback.
- 2 Choose "Edit", "PHOTO Capture", and then press ►/II.
The screen for verifying capture will appear.
- 3 Choose "YES", and then press ►/II.
The captured scene will be recorded on a card.

Note:

- You can also press PHOTO button for the scene you wish to capture in step 1: The screen for verifying capture will appear. Choose "YES", and then press ►/II: The scene will be recorded on a card.
- A captured photo is played back on the DVD video camera/recorder as follows:
When captured from a video recorded with 16:9 (wide mode) On specified:
Number of pixels (JPEG standard): 640 x 360



When captured from a video recorded with 16:9 (wide mode) Off specified:
Number of pixels (JPEG standard): 640 x 480



RAM RW VR RW VF R +RW CARD

PLAYBACK FROM START OF DISC OR CARD

Use the Disc Navigation function (p. 67) to play back from the start of disc or card.

RAM RW VR RW VF R +RW

SEARCH PLAYBACK OF MOVIE

During playback, press the ◀◀ or ▶▶ button and hold it: Search playback will start.

Hold down ▶▶ :

Scenes will be visually scanned forward.

Hold down ◀◀ :

Scenes will be visually scanned backward.

Release the ◀◀ or ▶▶ button when you find the desired image:

Normal playback will start from that point.

Note:

- If the temperature inside the DVD video camera/recorder rises, normal skip or search playback may not be possible: Turn the DVD video camera/recorder off, wait for a few moments, and then turn it on again.

RAM RW VR RW VF R +RW

FRAME ADVANCE/FRAME BACK/SLOW PLAYBACK OF MOVIE

During playback pause, press the ◀◀ or ▶▶ button: Frame advance, frame back or slow playback will start.

Press ▶▶ once:

Picture will advance one frame.

Press ◀◀ once:

Picture will go back one frame.

Hold down ▶▶ :

Forward slow playback.

Hold down ◀◀ :

Reverse slow playback.

After frame advance, frame back or slow playback, the DVD video camera/recorder will enter the playback pause status.

Note:

- In slow playback, a rapidly moving subject image may be distorted.
- The intervals for playing back frames in frame advance/frame back/slow playback are as follows:
Frame advance and forward slow: Approx. 0.03 seconds
Frame back and reverse slow: Approx. 0.5 seconds
- No sound will be heard during search playback or slow playback.

SKIP PLAYBACK OF MOVIE

During playback, press the **◀◀** or **▶▶** button to locate the start of desired scene.

Press **▶▶** once:

To skip to the first image of the scene following the one being played back, and start playback.

Press **◀◀** once:

To return to the first image of the scene being played back, and start playback.

Hold down **▶▶** :

To continuously locate the beginnings of scenes, starting from the scene following the scene being played back. When the desired image appears, release the button: Playback will start from that point.

Hold down **◀◀** :

To continuously locate the beginnings of scenes backward, starting from the scene preceding the scene currently being played back. When the desired image appears, release the button: Playback will start from that point.

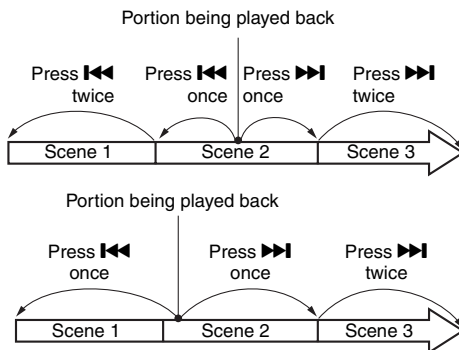

Pressing the **◀◀** button at a portion several seconds from the start of scene being played back will return to the start of the scene preceding that being played back.

Note:

- If you perform skip playback during playback pause, the DVD video camera/recorder will enter the playback pause status at the beginning of the located scene.
- Pressing the **▶▶** button in the last scene on disc will set the DVD video camera/recorder to the playback pause status at the last image.
- If the temperature inside the DVD video camera/recorder rises, normal skip or search playback may not be possible: Turn the DVD video camera/recorder off, wait for a few moments, and then turn it on again.

PLAYING BACK STILLS

Press the **◀◀** or **▶▶** button during playback to quickly play back stills in sequence.

Press **▶▶** once:

To display stills one by one forward.

Press **◀◀** once:

To display stills one by one backward.

[When using disc]

Releasing the **◀◀** or **▶▶** button will start continuous playback.

[When using card]

When the **◀◀** or **▶▶** button is released, the photo at that point will be displayed, and then the DVD video camera/recorder will enter the playback pause status.

Use the slide show function for continuous display (p. 105).

JUMPING TO SPECIFIED POINT (GO TO)

1 Press the MENU button during playback.

2 Choose the option (point you want to go to), and then press the **▶/||** button.

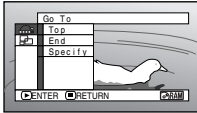

Top:

To go to the start, and enter playback pause.

End:

To go to the end of last scene, and enter playback pause.

Specify:

To go to a specified point and enter playback pause. See the following for details.

● Specifying the point to view

1 Choose "Specify" in step 2 above, and then press the **▶/||** button.

The screen for specifying the point to go to will appear.

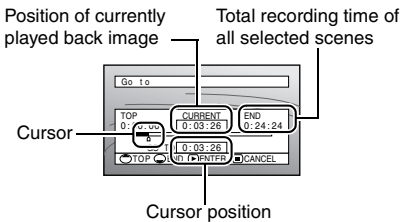

2 Use the **◀◀/▶▶/◀/▶** buttons to select the desired time of chosen point.

Press **◀◀** : To select the start.

Press **▶▶** : To select the end.

Press **◀** or **▶** :

- Press once:
To move the cursor in 10-second units (1-still units for card)
- Hold down:
To move the cursor in 1-minute units (10-still units for card)

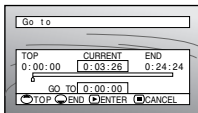

(When the start of scene is selected)

3 Press the **▶/||** button to enter the selection.

The DVD video camera/recorder will go to the specified point and enter the playback pause status.

Pressing **▶/||** again will start playback.

To cancel the "Go To" procedure midway, press the **■** button before going to the specified point.

Note:

- If multiple scenes are selected using the Disc Navigation function or SELECT button, choosing "Top" will jump to the beginning of selected scenes (p. 99).
- When multiple scenes are selected, the total time of selected scenes will appear in the "total recording time" display.
- With card, the number of stills will appear at the "TOP", "CURRENT", "END" and "GO TO" indicators.
- The cursor may not move at same-pitch intervals.

INFORMATION DISPLAY DURING PLAYBACK

Various types of information on recording will be superimposed on playback image you are viewing.

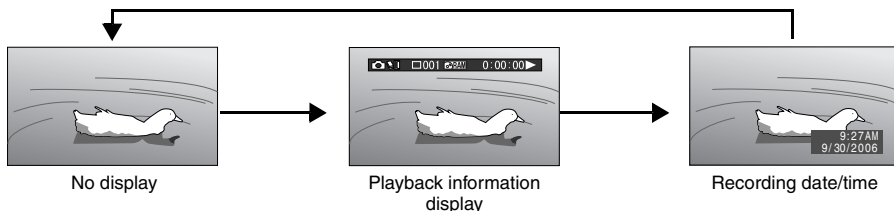

● Switching the information display mode

Press the DISPLAY button: You can switch the display mode of on-screen information.

When using disc:

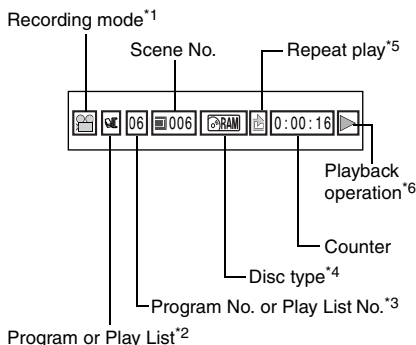

Program or Play List*2

When using card:

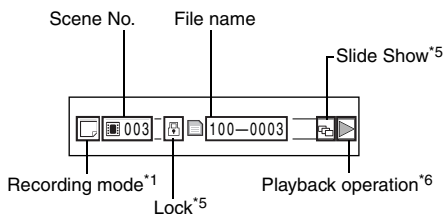

*1 (VIDEO) or (PHOTO) with disc;

Only (PHOTO) with card.

*2 Program or Play List.

*3 Number of program or play list being played back (not displayed when all programs are being played back).

*4 Refer to "Disc/Card type" on page 46.

*5 : Will appear when each function is specified "On".

*6 : Standard playback

: Playback pause

: Forward search playback

: Reverse search playback

: Forward skip playback

: Reverse skip playback

: Forward frame advance

: Reverse frame back

: Forward slow playback

: Reverse slow playback

Refer to "Playing Back" beginning on page 69 for how to operate.

The "" mark will appear on the first image on disc.

The "" mark will appear on the last image on disc.

- **Recording date/time display:** Shows the date/time when recording was started. Even when playback starts, the date/time display will not advance.

- **No display:** No information will appear. However, when the mode of playback operation is switched, the symbol will appear for approx. 3 seconds.

Note:

See page 89 and after for "Program", page 92 and after for "Play List".

SELECTING MULTIPLE SCENES

- 1 Press the DISC NAVIGATION button.
- 2 Use the **◀◀/▶▶/◀▶/▶▶** buttons to select the desired scene.
- 3 Press the SELECT button once:

The selected scene will be framed in red and yellow.

Repeat steps 2 and 3 to randomly select multiple scenes.

SELECTING CONSECUTIVE SCENES TOGETHER

- 1 Press the DISC NAVIGATION button.

- 2 Use the **◀◀/▶▶/◀▶/▶▶** buttons to point the cursor at the first scene in the range of scenes you want to select.

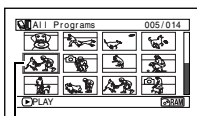

Yellow frame

- 3 Hold down the SELECT button for at least one second:

The selected scene will be doubly framed in yellow and blue.

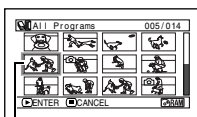

Double frames in yellow and blue

- 4 Use the **◀◀/▶▶/◀▶/▶▶** buttons to select the last scene in the range you want, and then press the **▶/||** button:

The thumbnails of scenes in the specified range will be framed in red, and then selected.

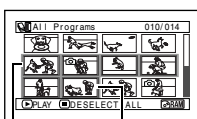

Red frame

When scenes up to this point are selected

Note:

- You can know the status of scenes from the colors of cursor and bargraph:

Cursor	Bar graph	Status of scenes
Yellow	Light blue	Current cursor position
Blue	Light blue	Range of scenes being selected
Red	Red	Scenes already selected

- Pressing the **▶/||** button after selecting scenes will play back only the selected scenes from the beginning of each.
- To cancel a selected scene, select the scene to be canceled, and then press the SELECT button. To cancel all selected scenes, press the **■** button.
- You can also select scenes in reverse from the last scene in the range.
- To release multiple selection, press the **■** or SELECT button before pressing the **▶/||** button in step 4.
- Up to 999 scenes can be selected for both disc and card.

FUNCTIONS AVAILABLE WITH DISC NAVIGATION

The Disc Navigation mode will allow a variety of further operations.

Available function	RAM	RW/VR	RW/VF	R	+RW	CARD	Contents	Reference page
Editing of scenes	●	●				▲*1	You can delete unnecessary scenes, combine scenes, or divide one scene.	79 – 81
Setting special effects to scenes	●	●					You can attach fade and skip to a scene, and change existing thumbnails.	82 – 84
Copy from disc to card	●						You can copy photos recorded on DVD-RAM disc to card.	85
Scene lock						●	You can lock any scene so that it will not be deleted by mistake: Essential scenes are thereby protected, and recording another still is possible.	86
Scene information display	●	●	●	●	●	●	You can display information on one scene or multiple scenes, such as image quality, recording time, etc.	88
Changing title	●	●					You can change the title of play list or program.	90, 98
Creation of play list	●	●					You can create an original movie by changing the combination of scenes.	92
Disc or Card initialization	●	●	●		●	●	You can initialize a DVD-RAM/DVD-RW/+RW disc or card so that it can be used on this DVD video camera/recorder.	99
Remaining display (Capacity)	●	●	●	●	●	●	The remaining recordable movie time or number of recordable stills is displayed.	100
Disc protection	●	●					You can protect the DVD-RAM/DVD-RW (VR-mode) disc to prevent deletion or editing by mistake.	100
Disc finalization		●*2	●	●	●		You can use this DVD video camera/recorder to finalize any DVD-RW/DVD-R/+RW disc recorded on it so that the disc can be viewed on DVD recorder/player, etc.	102
Unfinalizing disc			●		●		You can unfinalize a DVD-RW (VF-mode)/+RW that was finalized on this DVD video camera/recorder so that additional videos can be recorded on the disc.	103
Repeat play	●	●	●	●	●		You can repeatedly play back programs and scenes.	104
Slide show						●	You can play back stills continuously.	105

*1Only deletion is possible.

*2Additional recording can be made on a finalized DVD-RW (VR-mode).

Note:

Setting special effects to scenes (fade, skip, thumbnail) are unique to this DVD video camera/recorder. When a disc with any effects set on this DVD video camera/recorder is directly played back on a DVD recorder/player or read into PC, the set effect results will not be reflected in the playback or reading. To reflect the set effect results, connect both devices using the AV/S input/output cable and then perform recording (Dubbing, p. 109).

UNDERSTANDING FLOW OF DISC NAVIGATION MENU

Press the MENU button on the Disc Navigation screen: The menu screens for Disc Navigation and menu screens for disc and card will appear.

Shaded items will also appear in Quick Menu display mode (see page 49).

Refer to pages indicated for details of settings.

● When using DVD-RAM/DVD-RW (VR-mode) disc

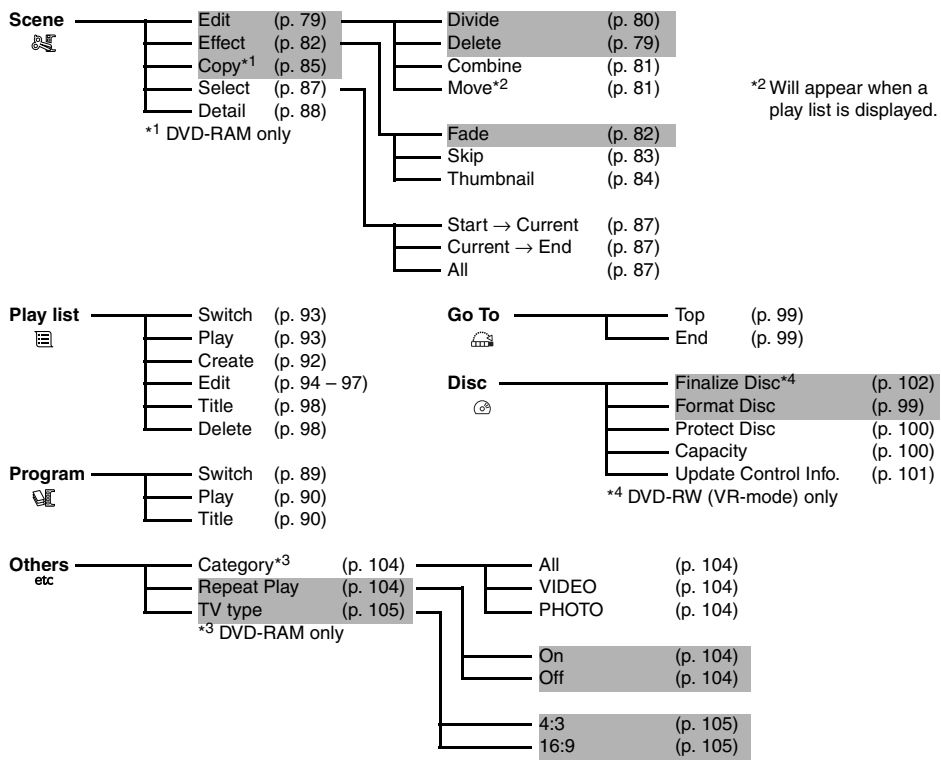

● When using DVD-RW (VF-mode)/DVD-R/+RW disc

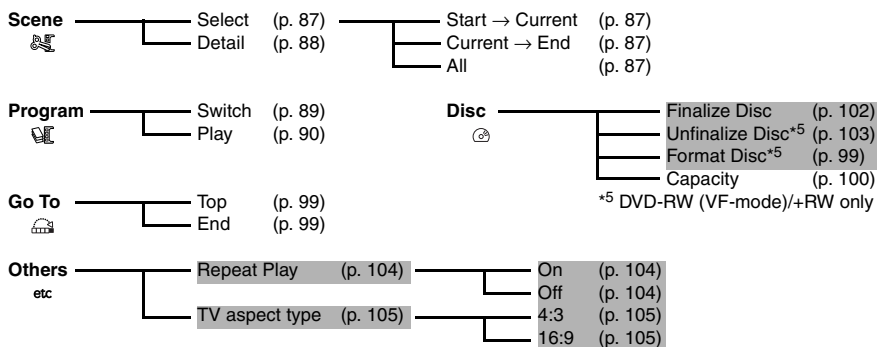

● When using card

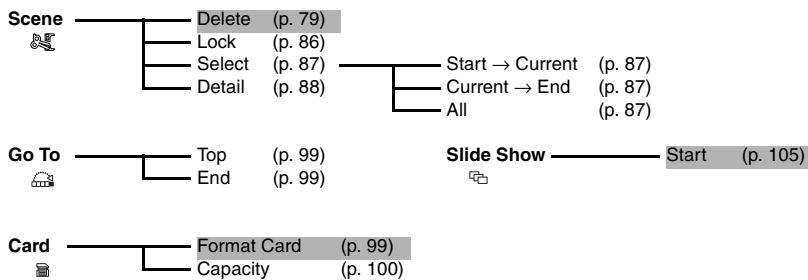

Scene

RAM

RW VR

CARD

DELETING SCENES (EDIT – DELETE)

You may want to delete unwanted scenes.

Scenes on DVD-RW (VF-mode)/DVD-R disc cannot be deleted, and menu item “Delete” will not appear with DVD-R disc.

When using +RW, no scene can be deleted from the Disc Navigation menu (see page 70).

1 Press the DISC NAVIGATION button.

2 Select the scene to be deleted.

3 Press the MENU button.

4 Choose “Scene”, “Edit”, “Delete”, and then press the ►/|| button.
When using card, choose “Scene”, “Delete”, and then press the ►/|| button.

5 The “Delete Scene” screen will appear: If you are sure you want to delete the selected scene, press the ►/|| button.

If you want to change the scene to be deleted, you can change it on this screen.

6 The screen for verifying deletion will appear: Choose “YES”, and then press the ►/|| button.

Choose “NO” to cancel deletion.
After Yes or No setting, the “Delete Scene” screen will be restored.
Repeat steps 5 and 6 to delete other scenes.

7 Press the ■ button to quit.

Note:

- If you point the cursor at the scene to be deleted on DISC NAVIGATION screen, and then press the DELETE button on remote control, the screen in step 5 will appear.
- To delete an unwanted part of a scene on DVD-RAM/ DVD-RW (VR-mode) disc, divide the scene first, and then delete the unnecessary part (see page 80).
- If you delete all data on disc or card, initializing the disc or card will be recommended (see page 99).
- If the time of deleted scenes (stills) is quite short, the remaining free space of disc may not increase in the disc or card remaining indicator.
- The locked scenes on card cannot be deleted (see page 86).

● Editing using submenu

Press the MENU button before pressing the ►/|| button in step 5 (see page 79): The submenu will appear.

Edit	—	Delete	To delete selected scenes
	—	Exit	To restore the Disc Navigation screen
Select	—	Start → Current	To select scenes from the start to the one that the cursor is on at the moment
	—	Current → End	To select scenes from the scene the cursor is on to the end
	—	All	To select all scenes
Go To	—	Top	To move the cursor to the first scene
	—	End	To move the cursor to the last scene

Pressing the ■ button will restore the screen in step 5.

Note:

Although the submenu screen will appear for each setting, some menu items may not appear, depending on the setting.

RAM RW VR

DIVIDING MOVIES (EDIT – DIVIDE)

You can divide a scene into two parts.

To delete unnecessary portion of scene, first divide the scene, and then delete the unnecessary portion.

1 Press the DISC NAVIGATION button.

2 Select the scene to be divided.

3 Press the MENU button.

4 Choose, “Scene”, “Edit”, “Divide” and then press the ►/|| button.

5 The “Divide Scene” screen will appear: If you are sure you want to divide the selected scene, press the ►/|| button: The selected scene will be played back.

If you want to change the scene to be divided, you can change it on this screen.

6 When you reach the point where you want to divide the scene, press the SELECT button.

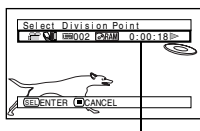

The status bar of scene being played back can be switched off or on by pressing the DISPLAY button

7 The screen for verifying division will appear: Choose “YES”, and then press the ►/|| button.

Choose “NO” to cancel division.

After division, the “Divide Scene” screen will be restored.

Repeat steps 5 – 7 to divide another scene.

8 Press the ■ button to quit.

Note:

- If you press the MENU button before pressing the ►/|| button in step 5, the submenu will appear.
- Search and frame advance are useful when designating division points.
- Combining scenes that were divided will restore the original scene (see page 81).
- If a special effect has been added to the original scene, the “IN” effect will be added to the first half of scene, and the “OUT” effect, to the latter half.
- The division point may drift before or after the designated point by approximately 0.5 seconds.
- Since a scene with a skip set cannot be played back, no division point can be specified: Release the skip for the scene before dividing it.
- If the division point is at a still, a message will appear, but no division will be made.
- If the division point is at the start or end of a scene, a message will appear, but no division will be made.
- A movie scene whose recording time is 0.5 seconds or less cannot be divided.
- If free space available on disc is insufficient, division will not be possible: Delete unnecessary scenes.

COMBINING MULTIPLE SCENES (EDIT – COMBINE)

If you have recorded numerous short scenes, combining them will be facilitated by the use of Disc Navigation.

Be sure to select consecutive multiple scenes. Combining scenes is possible only when “Category: All” is specified (p. 104). Stills cannot be combined.

1 Press the DISC NAVIGATION button.

2 Press the MENU button, choose “Scene”, “Edit”, “Combine”, and then press ►/||.

3 The “Combine Scenes” screen will appear: Point the cursor at the first scene to be combined, and then press the ►/|| button. The cursor will change to double frames of blue and yellow.

4 Use the ◀◀/▶▶/◀◀/▶▶ buttons to determine the range of scenes to be combined, point the cursor at the last scene, and then press the ►/|| button. The cursor will change to a red frame. The last scene will be double frames of red and yellow.

5 If you do not wish to change the scenes to be combined, press the ►/|| button. To change the scenes, press the ■ (STOP/EXIT) button to return the cursor to yellow, and then select the scenes to be combined again.

6 The screen for verifying combination will appear: Choose “YES”, and then press the ►/|| button.

The two images appearing on the verification screen are those of the first and last scenes to be combined.

Choose “NO” to cancel combination.

After Yes or No setting, the “Combine Scenes” screen will be restored.

The thumbnail of the first scene will appear in the combined scene.

Repeat steps 3 and 6 to combine other scenes.

7 Press the ■ button to quit.

Note:

- You can also select multiple scenes after step 1: Press the MENU button to continue the procedure of combination.
- If you press the MENU button before pressing the ►/|| button in step 3, the submenu will appear (see page 80).
- With fade effect, the “IN” effect of the first video in the selected range and the “OUT” effect on the last video will be attached to a combined scene.
- Scenes in different programs (different recording dates) cannot be combined: Create a play list first, and then combine such scenes on the play list.

ARRANGING ORDER OF SCENES (EDIT – MOVE)

You can arrange scenes within a play list by moving them to desired positions (p. 97). Create a play list first, and then arrange the scenes [“CREATING NEW PLAY LIST (CREATE)”, p. 92].

DIRECTING SCENES EFFECTIVELY (EFFECT – FADE)

You can add fading to the beginning and/or end of scene.
There are three types of special effects:

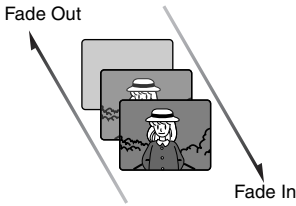

White:

Fades in from white screen
Fades out to white screen

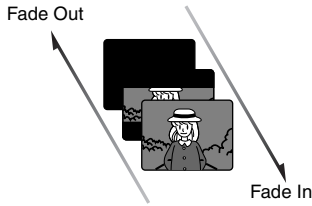

Wipe:

Fades in from black screen
to vertical direction of screen
Fades out from vertical
direction of screen to black
screen

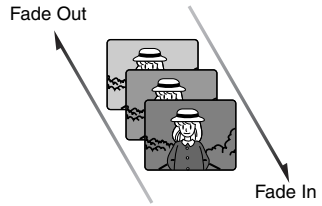

B/W:

Fades in from Black and
White screen to color screen
Fades out from color screen
to Black and White screen

- 1 Press the DISC NAVIGATION button.
 - 2 Select the scene for adding special effects.
 - 3 Press the MENU button.
 - 4 Choose, "Scene", "Effect", "Fade" and then press the ►/|| button.
 - 5 The "Fade" screen will appear: If you are sure you want to add the fade effect to the scene, press the ►/|| button.
- If you want to change the scene to which fade is added, you can change it on this screen.
- 6 Select the special effects for "IN" and/or "OUT", choose "Enter", and then press the ►/|| button.

You can use ◀◀/▶▶ to move the cursor to "IN", "OUT", "Enter" or "Cancel".
Use ◀/▶ to choose the effect to be added, and then press ►/|| to set the effect.
To cancel setting, choose "Cancel".
If you choose "Enter" and press ►/||, the "Fade" screen will be restored after a message appears.
Repeat steps 5 and 6 to add fade to other scenes.

- 7 Press the ■ button to quit.

The "▲" and/or "▼" icon(s) will appear in the scenes for which fade in and/or fade out have been set.

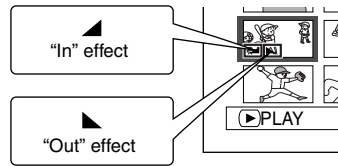

Note:

If a disc on which fade has been set on scene with this DVD video camera/recorder is played on a DVD reorder/player, or the scene is captured into a PC, the set fade will not be reflected (see Note on page 76).

PLAYING BACK BY SKIPPING SCENES (EFFECT – SKIP)

You can specify “Skip” for scenes you do not want to play back: The selected scenes will be skipped.

- 1 Press the DISC NAVIGATION button.
- 2 Select the scene to be skipped.
- 3 Press the MENU button.
- 4 Choose “Scene”, “Effect”, “Skip”, and then press the ►/|| button.
- 5 The “Set Skip” screen will appear: If you are sure you want to skip the selected scene, press the ►/|| button.

If you want to change the scene to be skipped, you can change it on this screen. After skip setting, the “Set Skip” screen will be restored.
Repeat step 5 to set skipping of other scenes.

- 6 Press the ■ button to quit.

A skip icon “≡” will appear in the thumbnail of any scene for which skipping has been set.

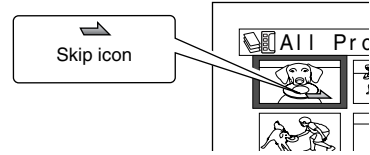

● Releasing Skip

Perform the same procedure as setting skip: The skip icon will disappear and skipping of the scene will be released.

Note:

- Multiple scenes can be selected for skipping (p. 75).
- If you press the MENU button before pressing the ►/|| button in step 5, the submenu screen will appear (p. 80).
- If a disc on which skip has been set on scene with this DVD video camera/recorder is played on a DVD reorder/player, or the scene is captured into a PC, the set skip will not be reflected (see Note on page 76).

CHANGING IMAGES FOR THUMBNAILS (EFFECT – THUMBNAIL)

Normally, the first image of the recorded scene is displayed as a thumbnail: You can choose another image of the scene for thumbnail. If you set a vivid image to thumbnail, you can know what you recorded from a glance at the Disc Navigation screen.

- 1 Press the DISC NAVIGATION button.
- 2 Select the thumbnail of the scene to be changed.
- 3 Press the MENU button.
- 4 Choose “Scene”, “Effect”, “Thumbnail”, and then press the ►/|| button.
- 5 The “Change Thumbnail” screen will appear: If you are sure you want to change the thumbnail of the selected scene, press the ►/|| button: The selected scene will be played back.

If you want to change the scene whose thumbnail is to be changed, you can change it on this screen.

- 6 When the image you want to use as the thumbnail of the scene appears, press the SELECT button.
- 7 The screen for verifying switching of thumbnail will appear: Choose “YES”, and then press the ►/|| button.

Choose “NO” to cancel switching of thumbnail.

After Yes or No setting, the “Change Thumbnail” screen will be restored.





Repeat steps 5 – 7 to change the other scenes.

- 8 Press the ■ button to quit.

Note:

- If you press the MENU button before pressing the ►/|| button in step 5, the submenu screen will appear (see page 80).
- A thumbnail of still cannot be changed.
- Since the scene to which skipping is set cannot be played back, you will not be able to change its thumbnail: Release the skip setting of the scene to change the thumbnail.
- If a disc on which thumbnail has been set with this DVD video camera/recorder is played on a DVD reorder/player, or the scene is captured into a PC, the set thumbnail will not be reflected (see Note on page 76).

COPYING STILLS ON DVD-RAM DISC TO CARD (COPY)

- 1** Set the power switch to “” or “”.
- 2** Press the DISC NAVIGATION button.
- 3** Select the still to be copied.
- 4** Press the MENU button.
- 5** Choose “Copy” on the “Scene” menu screen, and then press the  button.
- 6** The “Copy to card” screen will appear: If you are sure you want to copy the selected still, press the  button.

If you want to change the still to be copied, you can change it on this screen.

- 7** The screen for verifying copy will appear: Choose “YES”, and then press the  button.

Choose “NO” to cancel copy.
After Yes or No setting, the “Copy to card” screen will be restored.
Repeat steps 6 and 7 to copy other stills to card.

- 8** Press the  button to quit.

Note:

- No movie can be copied.
- If you press the MENU button before pressing the  button in step 6, the submenu screen will appear (p. 80).
- See “Category” (p. 104) to check the stills recorded on DVD-RAM disc.
- You can also select multiple scenes (p. 75).
- Even if all scenes, including movies, are selected to be copied, only stills will be copied.
- Data on card cannot be copied to disc.
- The quality of still copied from disc to card will be the same as when you recorded still on disc.
- Stills recorded on a device other than this DVD video camera/recorder may not be copied normally.

LOCKING SCENES ON CARD (LOCK)

You can lock each photo recorded on card so that it will not be deleted or edited by mistake.

- 1 Set the power switch to "CAM".
- 2 Press the DISC NAVIGATION button.
- 3 Select the scene to be locked.
- 4 Press the MENU button.
- 5 Choose "Lock" on the "Scene" menu screen, and then press the ►/|| button.
- 6 The "Lock Set" screen will appear: If you are sure you want to lock the selected scene, press the ►/|| button.

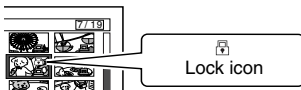

If you want to change the scene to be locked, you can change it on this screen.

After setting, the "Lock Set" screen will be restored.

Repeat step 6 to lock another scene.

- 7 Press the ■ button to quit.

The lock icon "🔒" will appear on any scene for which lock has been set.

● To unlock the scene:

Select the locked scene, and then use the same procedure as above to unlock the scene: The lock icon will disappear and locking will be released.

Note:

- If you press the MENU button before pressing the ►/|| button in step 6, the submenu screen will appear (p. 80).
- You can also select multiple scenes (p. 75).
- When initializing the card, the locked scenes will also be deleted.

SELECTING SCENES USING MENU SCREEN (SELECT)

You can use this “Select” function to select consecutive scenes at one time. This function is useful when there are numerous scenes.

- 1 Press the DISC NAVIGATION button.
- 2 Point the cursor at the first or last scene to be selected: When selecting all scenes, simply proceed with step 3.
- 3 Press the MENU button.

- 4 Choose “Select” on the “Scene” menu screen.
- 5 Choose “Start → Current”, “Current → End” or “All” and then press the ►/|| button.

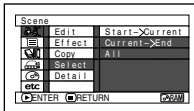

● Deselecting selected scenes

Deselecting scenes one by one:

While you are displaying the “All Programs” screen on which scenes have been selected, choose the scene to be deselected and then press the SELECT button.

Deselecting all the selected scenes at once:

While you are displaying the “All Programs” screen on which scenes have been selected, press the ■ button.

Note:

Up to 999 scenes can be selected.

DISPLAYING INFORMATION USING MENU SCREEN (DETAIL)

You can display various information for a scene: the recording mode, recording date/time and length, special effects and movie quality mode.

- 1 Press the DISC NAVIGATION button.
- 2 Select the scene whose information you wish to know.
- 3 Press the MENU button.
- 4 Choose "Scene", "Detail", and then press the ►/|| button.

The detailed information on the scene will appear.

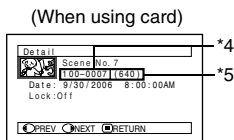
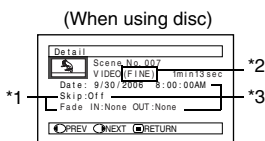

- *1 Not displayed with DVD-RW (VF-mode)/DVD-R/+RW disc.
- *2 Not displayed with DVD-RAM/DVD-RW/DVD-R/+RW recorded on another device (finalized).
- *3 Not displayed with a DVD-RAM/DVD-RW/DVD-R/+RW disc (finalized) that was recorded on another device.
- *4 May not appear if the loaded card does not comply with DCF.
- *5 Number of pixels on still in horizontal direction: This may not appear with a JPEG file that does not conform to this DVD video camera/recorder.

Note:

- DCF (Design rule for Camera File system) is a unified image file format for video cameras: Image files can be commonly used for all digital devices that conform to DCF.
- Pressing the ►► button will display information on the following scene; pressing the ◀◀ button will display information on the preceding scene.

- 5 Press the ■ button to quit.

Note:

- If multiple scenes have been selected, the total recording time of the selected scenes (total number in case of stills) will appear.

(When using disc)

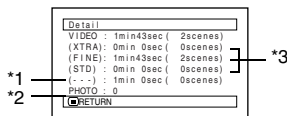

- *1 Number of scenes whose quality mode is unknown: This will appear when the disc has a scene recorded on a device other than this DVD video camera/recorder, only if the disc has a scene whose mode is unknown.
- *2 This will not appear with DVD-RW/DVD-R/+RW disc, since no still image can be recorded on it.
- *3 Not displayed with a DVD-RAM/DVD-RW/DVD-R/+RW disc (finalized) that was recorded on another device.

(When using card)

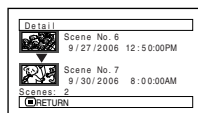

Program

WHAT IS “PROGRAM”?

Program refers to an assembly of scenes recorded on the same date regardless of whether they are movie or still.

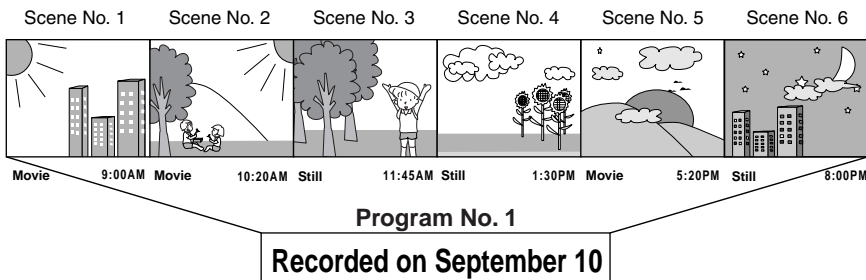

RAM RW VR RW VF R +RW

SWITCHING TO THUMBNAIL DISPLAY OF SPECIFIC DATE (SELECT)

Since the scenes recorded on this DVD video camera/recorder are collected as “programs” for each recording date, selecting a program will allow you to display only the scenes on a specific date.

- 1 Press the DISC NAVIGATION button.
- 2 Press the MENU button.
- 3 Use the **◀◀/▶▶/◀◀/▶▶/▶/||** buttons to choose “Select” on the “Program” menu screen, and then press the **▶/||** button.
- 4 Select the program to be displayed, and then press the **▶/||** button.

The Disc Navigation screen of the selected program will appear.

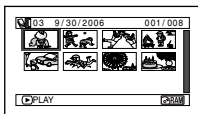
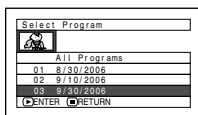

Note:

- Pressing the **■** button on the “Select Program” screen will restore the Disc Navigation screen.
- If a disc recorded on another device is loaded in this DVD video camera/recorder, the program may not be a collection of recordings on the same date.
- If you change the video quality or switch the wide mode with a +RW, multiple programs will be produced even if they are recorded on the same date.

PLAYING BACK PROGRAM (PLAY)

You can play back only the selected program.

- 1 Press the DISC NAVIGATION button.
- 2 Press the MENU button.
- 3 Use the **◀◀/▶▶/◀◀/▶▶/▶/||** buttons to choose "Play" on the "Program" menu screen, and then press the **▶/||** button.

- 4 Select the program to be played back, and then press the **▶/||** button.

Playback will start from the first scene of the selected program.

Note:

If "Repeat Play: On" is specified, the selected program will be repeatedly played back (PLAYING BACK SCENES REPEATEDLY (REPEAT PLAY), p. 104).

CHANGING TITLE OF PROGRAM (TITLE)

The recording date/time has initially been attached to any program. You can change the recording date/time to any desired title.

- 1 Press the DISC NAVIGATION button.
- 2 Press the MENU button.
- 3 Choose "Title" on the "Program" menu screen, and then press the **▶/||** button.
- 4 Select the program whose title you want to change, and then press the **▶/||** button.

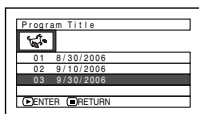

The screen for setting a title will appear.

- 5 Use **◀◀/▶▶/◀◀/▶▶** to select a letter, and then press the **▶/||** button: The selected letter will be entered.

Repeat this procedure to create a title.
Up to 20 characters can be input.

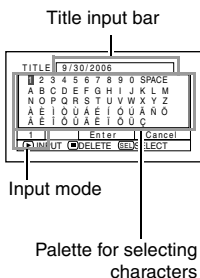

- 6 After entering the title, choose "Enter" and then press the **▶/||** button.

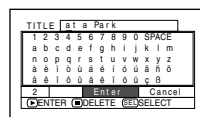

- 7 The screen for verifying the change in title will appear: Choose "YES", and then press the **▶/||** button.

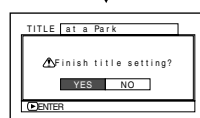

Choose "NO" to cancel changing of the title. After Yes or No setting, the Disc Navigation screen of the selected program will appear.

Play List

WHAT IS "PLAY LIST"?

You can create a play list on this DVD video camera/recorder by gathering your favorites from the recorded scenes.

Since the play list is not created by copying data, you will consume little of the disc capacity by making a play list. On the other hand, deleting scenes on play list will not increase the remaining disc capacity for recording.

Example:

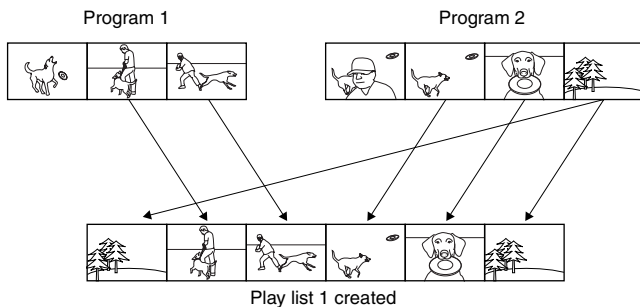

Play list of up to No. 99 can be created, and up to 999 scenes can be included in each play list of No. 1 to No. 99.

CREATING NEW PLAY LIST (CREATE)

- 1 Press the DISC NAVIGATION button.
- 2 Select the scenes to be programmed in a play list.
- 3 Press the MENU button.
- 4 Use the **◀◀/▶▶/◀◀/▶▶/▶/||** buttons to choose "Create" on the "PlayList" menu screen, and then press the **▶/||** button.
- 5 The scene select screen will appear: If the selected scenes on the play list are the ones you want, press the **▶/||** button.

If you want to change any of scenes you are registering, you can also use this screen (see pages 75 and 87).

- 6 When creation of a play list is complete, the created play list will appear on the Disc Navigation screen.

Note:

- You can also select multiple scenes (p. 75).
- Only the data on scenes is recorded on play list: If you create or delete play lists, the original scenes in programs will not be erased. Editing scenes on play list will not affect the scenes in programs.
- If the added scene had skip or fade setting, that information will also be added to the play list.
- You can add other scenes or remove unnecessary scenes to/from the create play list (see pages 94–96).
- The date/time when a play list was created will appear as the title for the play list. This title can later be changed (p. 98).
- If you press the MENU button before pressing **▶/||** in step 5, the submenu will appear (p. 80).
- If free space available on disc is insufficient, creation of new play list may not be possible: Delete unnecessary scenes.

SWITCHING TO DISPLAY OF EACH PLAY LIST (SELECT)

Select the desired one of multiple play lists: The Disc Navigation screen of the selected play list will appear.

- 1 Press the DISC NAVIGATION button.
- 2 Press the MENU button.
- 3 Use the **◀◀/▶▶/◀◀/▶▶/▶/||** buttons to choose "Select" on the "PlayList" menu screen, and then press the **▶/||** button.

- 4 Use the "Select Playlist" screen to select the play list you wish to display, and then press the **▶/||** button.

The Disc Navigation screen of the selected play list will be displayed.

Note:

To display the Disc Navigation screen showing all programs (all recorded scenes), choose "All Programs" on the "Switch PlayList" screen.

● Editing on play list

When making settings on play list, such as changing title, setting skip, adding fade, etc., use the same procedure for setting on program or scenes. Perform these settings, referring to the following reference pages:

Deleting scene,	p. 79
Changing thumbnail,	p. 84
Setting skip,	p. 83
Adding fade,	p. 82
Combining scenes,	p. 81
Dividing a scene,	p. 80
Copying to card,	p. 85
Changing title,	p. 90, 98
Arranging order of scenes (only on play list)	p. 97

PLAYING BACK A PLAY LIST (PLAY)

- 1 Press the DISC NAVIGATION button.
- 2 Press the MENU button.
- 3 Use the **◀◀/▶▶/◀◀/▶▶/▶/||** buttons to choose "Play" on the "PlayList" menu screen, and then press the **▶/||** button.
- 4 Use the "Start Playlist" screen to select the play list to be played back, and then press the **▶/||** button.

The selected play list will be played back from the first scene. To cancel playback midway, press the **■** button: The Disc navigation screen of the play list being played back will appear.

Note:

If "Repeat Play: On" is specified, the play list will be repeatedly played back (p. 104).

DELETING SCENES FROM PLAY LIST (EDITING PLAY LIST)

- 1 Press the DISC NAVIGATION button.
- 2 Display the editing screen of the play list to be edited.

Perform steps 2 – 4 on page 94.
- 3 Move the cursor to the play list in lower row, and place the cursor on the scene to be deleted.

- 4 Press the ►/|| button.

Repeat steps 3 and 4 to delete other scenes.

- 5 Press the ■ button: The screen for verifying exit will appear.

Note:

- You can also select multiple scenes (p. 75).
- Place the cursor on scene to be deleted, and then press the DELETE button on remote control: You can also delete the scene on the play list.

ADDING SCENES USING SUBMENU FOR EDITING (EDITING PLAY LIST)

You can use the menu screen to add scenes to a play list.

- 1 Press the DISC NAVIGATION button.
- 2 Display the editing screen of the play list to be edited.

Perform steps 2 – 4 on page 94.
- 3 From the play list in lower row, select the position where you wish to insert a scene.
- 4 Select the scenes to be added from the upper row.

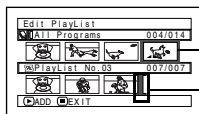

Scene to be added

Insertion position

- 5 Press the MENU button.

- 6 Choose "Add", and then press the ►/|| button.

Repeat steps 3 – 6 to add other scenes.

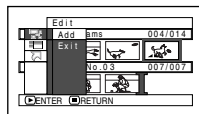

- 7 Press the ■ button: The screen for verifying exit will appear.

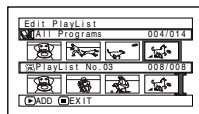

Note:

- The selected scenes will be added in the insertion position.
- You can also select multiple scenes (p. 75).

DELETING SCENES USING SUBMENU FOR EDITING (EDITING PLAY LIST)

You can delete scenes from play list on the editing screen.

- 1** Press the DISC NAVIGATION button.
- 2** Display the editing screen of the play list to be edited.
Perform steps 2 – 4 on page 94.
- 3** Move the cursor to the play list in lower row.
- 4** Select the scene to be deleted, and then press the MENU button.
- 5** Choose “Delete” on the “Edit” menu screen, and then press the ►/|| button.
Repeat steps 3 – 5 other scenes can be deleted.
- 6** Press the ■ button: The screen for verifying exit will appear.

Note:

- If all scenes on play list are deleted, the play list itself will also be deleted.
- You can also select multiple scenes (p. 75).

SELECTING SCENES USING SUBMENU FOR EDITING (EDITING PLAY LIST)

You can specify the range of scenes when adding or deleting consecutive multiple scenes to/from play list. This “Select” menu item is useful when selecting consecutive multiple scenes in items for adding or deleting scenes using menu on page 87.

- 1** Press the DISC NAVIGATION button.
- 2** Display the editing screen of the play list to be edited.
Perform steps 2 – 4 on page 94.
- 3** Specify the first or last scene of those you wish to select, and then press the MENU button.
To select all scenes, simply press the MENU button.
- 4** Use ◀◀/▶▶/◀◀/▶▶/▶/|| to choose “Start → Current”, “Current → End”, “All” on the “Select” menu screen, and then press the ►/|| button.
Note:
See page 87 for the status of scenes to be selected.
- 5** Press the ■ button: The screen for verifying exit will appear.

ARRANGING ORDER OF SCENES (MOVE)

When using DVD-RAM, you can move scenes only by specifying "Category: All".

- 1 Press the DISC NAVIGATION button.
- 2 Press the MENU button.
- 3 Use the **◀◀/▶▶/◀◀/▶▶/▶/||** buttons to choose "Select" on the "PlayList" menu screen, and then press the **▶/||** button. Select the play list to be edited, and then press the **▶/||** button.
- 4 Select the scene to be moved.

You can also select multiple scenes (see pages 75 and 87).

- 5 Press the MENU button.
- 6 Choose "Scene", "Edit", "Move", and then press the **▶/||** button.
- 7 The "Move Scene" screen will appear: If you are sure you want to move the scene, press the **▶/||** button.

If you want to change the scene selected in step 4, you can do it on this screen.

- 8 Move the "I" mark to the position where you wish to move the scene, and then press the **▶/||** button.

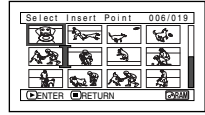

- 9 The screen for verifying move will appear: Choose "YES", and then press the **▶/||** button.

Choose "NO" to cancel move.

After Yes or No setting, the scene select screen will be restored.

Repeat steps 7 – 9 to move another scene.

- 10 Press the **■** button to quit.

Note:

- If you press the MENU button before pressing the **▶/||** button in step 7, the submenu screen will appear (p. 80).
- Only scenes on play list can be moved.
- When using DVD-RAM, scenes can be moved only when "Category: All" is specified (p. 104).

CHANGING TITLE OF PLAY LIST (TITLE)

The play lists have serial numbers in the order you have created them, along with the created dates/times: You can change this title at any time.

- 1 Press the DISC NAVIGATION button.
- 2 Press the MENU button.
- 3 Use the **◀◀/▶▶/◀◀/▶▶/▶/||** buttons to choose "Title" on the "PlayList" menu screen, and then press the **▶/||** button.
- 4 Use the "Playlist Title" screen to select the play list whose title you wish to change, and then press the **▶/||** button.

See "CHANGING TITLE OF PROGRAM (TITLE)" on page 90 for how to enter a title.

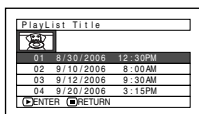

- 5 The screen for verifying exit will appear: Choose "YES" and then press the **▶/||** button.
- 6 Press the **■** button to quit.

After changing the title, the Disc Navigation screen on the play list whose title has been changed will appear.

Note:

The registered title can be changed at any time using the same procedure.

DELETING PLAY LIST (DELETE)

- 1 Press the DISC NAVIGATION button.
- 2 Press the MENU button.
- 3 Use the **◀◀/▶▶/◀◀/▶▶/▶/||** buttons to choose "Delete" on the "PlayList" menu screen, and then press the **▶/||** button.
- 4 Use the "Delete Playlist" screen to select the play list you wish to delete, and then press the **▶/||** button.
- 5 The screen for verifying deletion will appear: Choose "YES", and then press the **▶/||** button.

Choose "NO" to cancel deletion.
After Yes or No setting, the Disc Navigation screen of all programs will be restored.

Note:

- Even if you delete a play list, the original scenes stored on disc will not be deleted.
- If any play list is deleted, the number of play lists will automatically be revised. (For example, if the No. 2 play list is deleted, the No. 3 play list will become No. 2 play list.)

Go To

From the Disc Navigation screen, you can jump to the first scene or last scene, and playback will start from that point.

TOP (END)

- 1 Press the DISC NAVIGATION button.
- 2 Press the MENU button.
- 3 Use the **◀◀/▶▶/◀◀/▶▶/▶▶/||** buttons to choose "Top" or "End" on the "Go To" menu screen, and then press the **▶▶/||** button.
- 4 Press **▶▶/||** to start playback.

Disc or Card Management

INITIALIZING DISC OR CARD (FORMAT DISC. FORMAT CARD)

Initializing a DVD-RAM/DVD-RW/+RW disc or card will allow you to delete any recorded contents. Before using a DVD-RW/+RW on this video camera/recorder, you must format it.

Before You Begin

- Be sure to use the AC adapter/charger to power the DVD video camera/recorder for initialization. If the DVD video camera/recorder is turned off during initialization and the initialization is interrupted, incorrect initialization will result and the incorrectly initialized disc will be unusable.
- If you use a brand-new DVD-RW/+RW disc, message "Disc is not formatted" will appear: Initialize the disc, following the subsequent messages (p. 39).

- 1 Press the DISC NAVIGATION button.
- 2 Press the MENU button.
- 3 Use the **◀◀/▶▶/◀◀/▶▶/▶▶/||** buttons to choose "Format Disc" or "Format Card" on the "Disc" or "Card" menu screen, and then press the **▶▶/||** button.

The screen for verifying "Format Disc" or "Format Card" will appear.

- 4 Choose "YES", and then press the **▶▶/||** button.

When using DVD-RW, a screen for prompting you to choose the VF or VR mode will appear. Choose "NO" to cancel initialization.

Note:

- If you wish to delete all recorded contents, it is recommended that you use initialization, which will delete all the scenes in much less time than using the scene delete function.
- Initialization will delete all the recorded contents on disc or card: Be careful not to delete data by mistake.
- It may not be possible to initialize a disc with many scratches or dirt: Such a disc cannot be used (p. 9).
- This DVD video camera/recorder may not recognize some discs or cards that have been initialized on PC or a device other than this DVD video camera/recorder.
- If you attempt to initialize a disc or card in this DVD video camera/recorder when it is connected to PC via PC connection cable, the disc or card may not be initialized and may be unusable on this DVD video camera/recorder.
- If you choose the VR mode when initializing a finalized DVD-RW (VR-mode), the finalization will not be released. (The DVD-RW will be a finalized disc without any recorded data, and recording will be possible on it.)
Choosing the VF mode will release the finalization of the disc.

PROTECTING DISC FROM WRITING (PROTECT DISC)

You can protect a DVD-RAM/DVD-RW (VR-mode) disc in order to prevent recorded images from being erased or edited by mistake. Further recording will not be possible on protected disc until the protection is released.

- 1 Press the DISC NAVIGATION button.
- 2 Press the MENU button.
- 3 Use the **◀◀/▶▶/◀◀/▶▶/▶/||** buttons to choose "Protect Disc" on the "Disc" menu screen, and then press the **▶/||** button.
- 4 The screen for verifying protection will appear:

Choose "YES", and then press the **▶/||** button.

Choose "NO" to cancel protection.

After "YES" or "NO" setting, the Disc Navigation screen will be restored.

Note:

- To release disc protection, perform the same procedure as above: The screen for verifying the release of protection will appear. Choose "YES" to release the protection.
- If disc protection has been engaged on another device, it may not be releasable on this DVD video camera/recorder: Use the original device that protected the disc to release the protection.

VERIFYING REMAINING FREE SPACE ON DISC OR CARD (CAPACITY)

You can find out how long you will be able to record on one side of disc or on card.

- 1 Press the DISC NAVIGATION button.
- 2 Press the MENU button.
- 3 Use the **◀◀/▶▶/◀◀/▶▶/▶/||** buttons to choose "Capacity" on the "Disc" or "Card" menu screen, and then press the **▶/||** button.

- 4 Press the **■** button to quit.

The Disc Navigation screen will be restored.

Note:

With a write-protected disc or locked card, the remaining space will always be displayed as "0".

(When using disc)

(When using card)

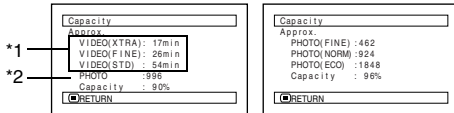

*1 With DVD-RW (VF-mode)/DVD-R disc: The quality mode first used for recording with disc will appear.

*2 With DVD-RW/DVD-R/+RW disc: This will not be displayed.

UPDATING CONTROL INFORMATION OF DVD-RAM/DVD-RW (VR-mode) DISC (UPDATE CONTROL INFO.)

Disc Navigation in this DVD video camera/recorder handles information on scenes, such as thumbnail, skip, fade, in a particular manner. If you use another device to edit a disc recorded on this DVD video camera/recorder, and then use the data again with Disc Navigation in this DVD video camera/recorder, the Disc Navigation may not appear normally. If this happens, use the Update Control Info function to update the data.

Before You Begin

- When using the AC adapter/charger to power the DVD video camera/recorder for updating control information, make sure that power is not turned off during updating: If the DVD video camera/recorder is turned off during updating and the updating is interrupted, the control information will not be updated correctly.

- 1 Press the DISC NAVIGATION button.
- 2 Press the MENU button.
- 3 Use the **◀◀/▶▶/◀◀/▶▶/▶/||** buttons to choose "Update Control Info." on the "Disc" menu screen, and then press the **▶/||** button.

The screen for verifying "Update Control Info." will appear.

- 4 Choose "YES", and then press the **▶/||** button.

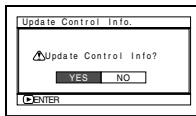

The message for proceeding will appear, and then the Disc Navigation menu screen will be restored.

A black screen may appear while the message for updating is displayed. Choose "NO" to cancel updating.

Note:

- It may take time to update the control information if the disc has many recorded scenes.
- Even if control information is updated, some discs will be unusable on Disc Navigation of this DVD video camera/recorder.

FINALIZING DVD-RW/DVD-R/+RW DISC (FINALIZE DISC)

Before You Begin

- Be sure to use the AC adapter/charger to power the DVD video camera/recorder when finalizing a DVD-RW/DVD-R disc. Finalization cannot be executed using a battery. If the DVD video camera/recorder is turned off during finalization and the finalization is interrupted, incorrect finalization will result, and at worst, the disc may be damaged.

If you want to play back a DVD-RW/DVD-R disc recorded on this DVD video camera/recorder, using a device conforming to 8 cm DVD disc – such as a DVD recorder/player, etc. – you must **finalize the disc on this DVD video camera/recorder**.

No further recording can be done on a finalized DVD-RW (VF-mode)/DVD-R/+RW. You can, however, unfinalize the DVD-RW (VF-mode)/+RW so that other scenes can be recorded on it. Additional recording is possible on a finalized DVD-RW (VR-mode): unfinalizing is not necessary.

- 1 Press the DISC NAVIGATION .
- 2 Press the MENU button.
- 3 Use the **◀◀/▶▶/◀◀/▶▶/▶/||** buttons to choose “Finalize Disc” on the “Disc” menu screen, and then press the **▶/||** button.

The disc will be finalized.

- 4 Choose “YES”, and then press the **▶/||** button. The message showing that the disc is being finalized will appear, and the disc will then be finalized.

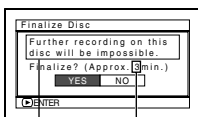

*1 Will vary depending on the recording time.

*2 Displayed only when a DVD-R is used.

- 5 When finalization is complete, the Disc Navigation screen of all programs will appear. **■** will appear on the Disc Navigation screen for a finalized disc.

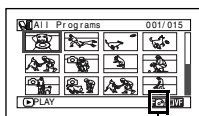

Finalized disc

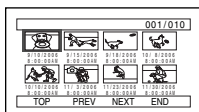

Screen when viewed on DVD recorder/player (DVD-RW (VF-mode)/DVD-R/+RW)

Note:

- Do not finalize a disc recorded on this DVD video camera/recorder using any other device.
- If the disc in the DVD video camera/recorder has already been finalized, you cannot choose “Finalize Disc”.
- The time required to finalize disc that appears on the “Finalize Disc” screen is only for reference.
- The shorter the recording time on disc, the longer it will take to finalize it.
- The second and later finalization will be faster with a disc which has previously been finalized.

● Using FINALIZE button to finalize a disc:

Press the FINALIZE button during recording pause: The screen shown in step 4 above will appear. Choose “YES”, and then press the **▶/||** button: Finalizing will start.

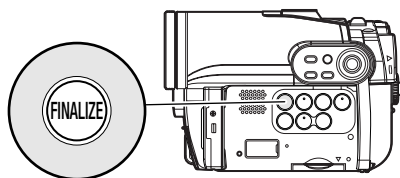

ADDITIONALLY RECORDING ON FINALIZED DVD-RW (VF-mode)+RW (DISC UNFINALIZE)

You can unfinalize the DVD-RW (VF-mode)/+RW finalized on this DVD video camera/recorder so that additional recording can be done on it.

- 1** Press the DISC NAVIGATION button.
- 2** Press the MENU button.
- 3** Use the **◀◀/▶▶/◀◀/▶▶/▶/||** buttons to choose “Unfinalize Disc” on the “Disc” menu screen, and then press the **▶/||** button. The screen for verifying unfinalization will appear.
- 4** Choose “YES”, and then press the **▶/||** button. The message showing that the disc is being unfinalized will appear, and the disc will then be unfinalized.

Others

DISPLAYING MOVIES OR STILLS INDEPENDENTLY (CATEGORY)

Scenes recorded on this DVD video camera/recorder will be displayed in the order of recording regardless of whether they are movies or stills. You can use the Disc Navigation screen to switch this display to stills only or movies only.

1 Press the DISC NAVIGATION button.

2 Press the MENU button.

3 Use the **◀◀/▶▶/◀◀/▶▶/▶▶/▶▶** buttons to choose "Category" on the "Others" menu screen, and then press the **▶▶/▶▶** button.

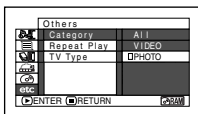

4 Specify the desired option for display, and then press the **▶▶/▶▶** button.

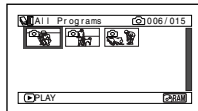

(When "PHOTO" is specified)

All: To display all scenes, movies or stills, in the order of recording.

VIDEO: To display only movies in the order of recording.

PHOTO: To display only photos in the order of recording.

When the Disc Navigation screen is finished, "Category: All" will be restored.

RAM RW VR RW VF R +RW

PLAYING BACK SCENES REPEATEDLY (REPEAT PLAY)

1 Press the DISC NAVIGATION button.

2 Press the MENU button.

3 Use the **◀◀/▶▶/◀◀/▶▶/▶▶/▶▶** buttons to choose "Repeat Play" on the "Others" menu screen, and then press the **▶▶/▶▶** button.

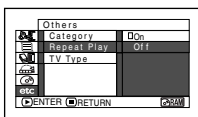

4 Choose "On", and then press the **▶▶/▶▶** button: Playback will start.

Choose "Off" to cancel Repeat Play setting.

● When Repeat Play is set:

If one scene has been specified: When playback of the last scene is finished, playback of all scenes will repeat from the first scene.

If the range for playback has been specified: Playback of the scenes in that range will repeat.

● To release Repeat Play

Use one of the following 3 methods to release:

- Choose "Off" in step 4 above.
- Turn the DVD video camera/recorder off once.
- Press the DISC EJECT button to remove the disc.

Note:

- Press the **■** button to terminate playback. However, the Repeat Play setting will not be canceled.
- Still images can also be played back repeatedly.
- Repeat playback will not function when playback is instructed from the recording pause status.

PLAYING BACK WIDE-MODE IMAGES ON 4:3 DISPLAY TV (TV type)

If you connect the DVD video camera/recorder with a disc recorded in wide mode to a TV with 4:3 display only and play it back, vertically long images will appear. You can specify "TV type: 4:3" to display 4:3 images on the TV.

- 1 Press the DISC NAVIGATION button.
- 2 Press the MENU button.
- 3 Use the **◀◀/▶▶/◀◀/▶▶/▶/||** buttons to choose "TV type" on the "Others" menu screen, and then press the **▶/||** button.
- 4 Choose "4:3", and then press the **▶/||** button.

CARD

SLIDE SHOW (CONTINUOUS PLAYBACK OF STILLS)

If you play back stills recorded on a card, the DVD video camera/recorder will enter the playback pause status after each still is played back.

Setting Slide Show allows you to continuously play back stills.

- 1 Press the DISC NAVIGATION button.
- 2 Press the MENU button.
- 3 Use the **◀◀/▶▶/◀◀/▶▶/▶/||** buttons to choose "Slide Show", "Start", and then press the **▶/||** button.

Note:

- With slide show, playback will start from the first photo on card regardless of the position of cursor or whether you attempt to select scenes.
- If you press the **■** button or turn the DVD video camera/recorder off, Slide Show will be canceled.

Start: To start a slide show

When playback is finished, the DVD video camera/recorder will enter the playback pause status at the final still.

Pressing the **■** button will restore the Disc Navigation screen.

Viewing on TV Screen

CONNECTING TO A TV

Use the provided AV/S input/output cable to connect the DVD video camera/recorder to a TV as follows:

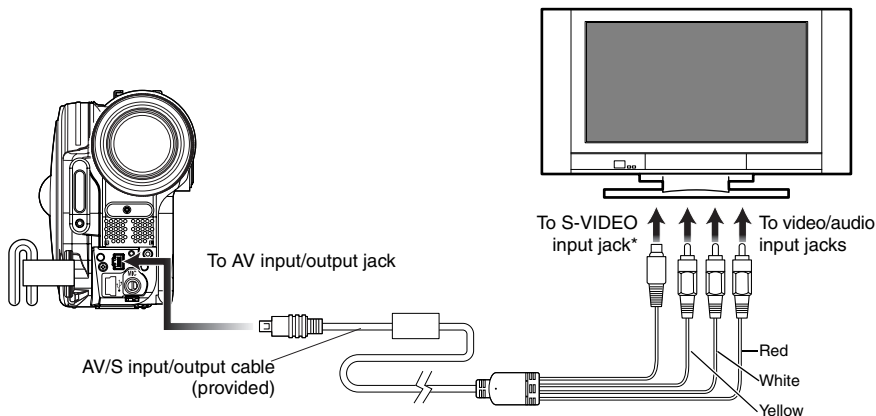

* If your TV has an S-VIDEO input jack, you can connect the S-VIDEO plug to it.

Note:

- Using S-VIDEO will deliver clearer playback status.
- Before connecting, make sure that the volume on TV is turned down: Forgetting this may cause howling from the TV speakers.
- Insert the AV/S input/output cable plugs into jacks straight: Obliquely inserting them could damage the jacks.

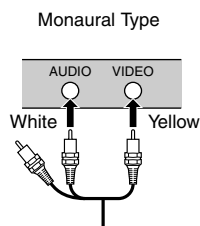
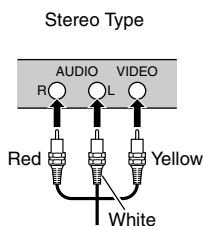
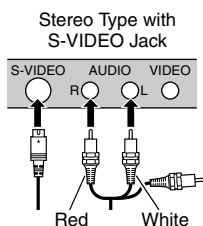

VIEWING ON TV SCREEN

- 1 Turn the TV on and set the input selector to "VCR" whichever applicable Video input.

Refer to the TV instruction manual for how to switch the TV input.

- 2 Turn the DVD video camera/recorder on.

The image that the DVD video camera/recorder is seeing will appear on the TV screen.

You can also monitor the image on the LCD screen or viewfinder of the DVD video camera/recorder.

- 3 Perform playback, recording or editing.

You can perform playback, editing or editing on Disc Navigation while checking on TV screen.

Note:

- Adjust the volume of sound on TV.
- The infrared remote control is useful when operating the DVD video camera/recorder while viewing an image on TV screen. However, if you use a Hitachi VCR, the remote control may inadvertently operate the VCR if it is near the DVD video camera/recorder. To prevent this, set the remote control code of the VCR to a position other than "VCR2".
- Information that the DVD video camera/recorder is recording will appear on the TV screen: You can also display only part of information or switch off the display. Refer to "SETTING ON-SCREEN DISPLAY OUTPUT ON OR OFF (OSD OUTPUT)" on page 66, and press the DISPLAY button to switch the display status.
- When copy-guarded disc is played back, no image will appear on TV screen.
- If you use TV with wide mode (aspect ratio 16:9) and set the TV to the wide mode, the entire Disc Navigation display may not be displayed on the TV screen. If this happens, release the wide mode setting on TV (see the TV instruction manual for releasing the wide mode).

Playback on DVD Recorder/Player

PLAYING BACK DVD-RAM/DVD-RW (VR-mode) DISC

You can use a DVD recorder or DVD player that conforms to DVD-RAM/DVD-RW (VR-mode) to play back 8 cm DVD-RAM/DVD-RW (VR-mode) discs recorded on this DVD video camera/recorder.

- 1 Insert the disc into the DVD recorder/player and play it back.

See the instruction manual for DVD recorder/player.

Note:

- When playing back disc on another device, the Disc Navigation display will be different from the one on this DVD video camera/recorder.
- Finalizing DVD-RW (VR-mode) may be necessary.
- Do not insert a DVD-RW (VR-mode) that was recorded on this DVD video camera/recorder into a device that does not conform to DVD-RW (VR-mode): Doing so may make the disc unusable.

PLAYING BACK DVD-RW (VF-mode)/DVD-R/+RW DISC

- 1 Finalize a recorded DVD-RW (VF-mode)/DVD-R disc.

You need to finalize a disc to play it back on DVD recorder/player: See page 102. No further data can be recorded on finalized disc.

Note:

Use this DVD video camera/recorder to finalize the DVD-R disc recorded on the DVD video camera/recorder.

- 2 Insert the disc into the DVD recorder/player and play it back.

See the instruction manual for DVD recorder/player.

Note:

- Do not insert a DVD-RW (VF-mode)/DVD-R disc that has not been finalized into any DVD recorder: The disc may be unusable (except for devices that allow playback of a DVD-R disc not finalized on this DVD video camera/recorder).
- Do not insert a DVD-RW (VF-mode)/DVD-R recorded on another DVD recorder and not finalized, in this DVD video camera/recorder: Doing so will make the disc unusable.
- A recorded +RW is automatically finalized when it is removed from the DVD video camera/recorder even if you do not use the Disc Navigation function to finalize it (p. 102) (auto-finalize). An auto-finalized +RW can be played back on a DVD recorder/player, etc., but no DVD video menu will appear. To display the DVD video menu on a DVD recorder/player, etc., finalize the +RW using the Disc Navigation function before playing it back on a DVD recorder/player, etc.
- A +RW with a shorter recording time may not be playable on a DVD recorder/player, etc. if it has been auto-finalized. In this case, use the Disc Navigation function to finalize the +RW.
- DVD-RW (VF-mode)/DVD-R/+RW discs recorded on this DVD video camera/recorder or other 8 cm DVD-RW (VF-mode)/DVD-R discs can be played back on other DVD recorder/players or other devices conforming to 8 cm DVD-RW (VF-mode)/DVD-R/+RW, but playback on all DVD recorder/players is not guaranteed.
- Playback may not be possible on some DVD recorder/players, or it may depend on the recorded status of DVD-RW (VF-mode)/DVD-R/+RW discs: In such cases, play back the DVD-RW (VF-mode)/DVD-R/+RW disc on this DVD video camera/recorder. Also, playback on DVD recorder/players may stop momentarily between scenes.

Recording (Dubbing) Images

Before You Begin

- Before connecting this DVD video camera/recorder to another device, be sure to turn both devices off.
- Insert a recordable disc*¹ or card*² into this DVD video camera/recorder (see pages 23 and 25).
- *¹ No photo can be recorded on DVD-RW/DVD-R/+RW.
- *² Only photos can be recorded: No video can be recorded.
- If you operate the DVD video camera/recorder connected to another device, always power the camera/recorder from AC outlet using the AC adapter/charger.
- If you use a Hitachi VCR, it will be operated by the remote control* provided with the DVD video camera/recorder. When recording an image from a Hitachi VCR, change the remote control code of the VCR to other than "VCR2".
- * The remote control is not provided with DZ-GX3100A/BX35A.
- No image can be recorded (dubbed) on the DZ-BX37A/BX35A from another video device.

RECORDING (DUBBING) IMAGES FROM OTHER VIDEO DEVICE

You can record (dub) images from other video devices to disc or card in this DVD video camera/recorder.

Use the AV/S input/output cable (provided) to connect the DVD video camera/recorder to the other video device as follows:

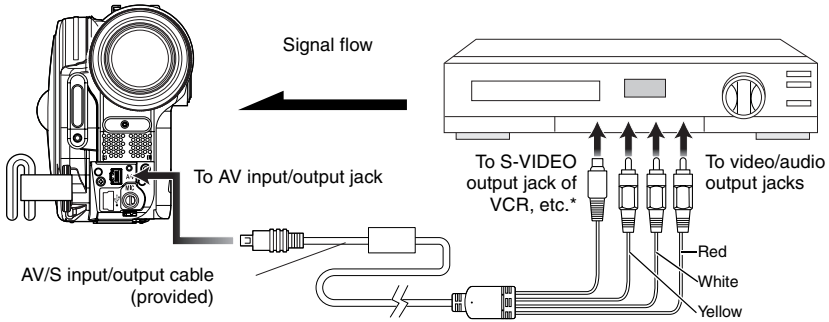

* If you are using DZ-GX3300A/GX3200A/GX3100A, and the connected AV device has an S-VIDEO output jack, you can connect the S-VIDEO jack of AV/S input/output cable.

- 1 Set the input source on the DVD video camera/recorder to "LINE (L IN)".

Switch the input referring to "Input Source" on page 64.

Choose "S LINE" to input S-VIDEO signal.

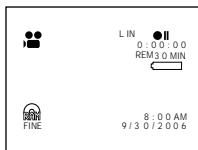

- 2 Turn on the connected device, and start playback.

The picture will appear on the LCD screen or viewfinder of this DVD video camera/recorder.

- 3 Press the REC button.

Recording will start on this DVD video camera/recorder.

The operation of this line-input recording is the same as for recording movie. Press the PHOTO button when recording a photo.

Note:

- With DZ-GX3300A/GX3200A/GX3100A, using S-VIDEO will enable you to record clearer images.
- Reduce the volume of external input sound heard from the built-in speaker: The loud volume may cause noise to enter the recorded image.
- The recorded contents can be played back in the same manner as when playing back camera images recorded on this DVD video camera/recorder.
- The "Input Source" setting will return to "CAMERA" whenever DVD video camera/recorder is turned off.
- Recording of most images is prohibited by the copy-guard signal to protect the copyright, except for images recorded on camcorders for personal enjoyment. "COPY PROTECTED" appears in these images: They cannot be recorded on this DVD video camera/recorder. Typical copyright protected images include those of DVD video, LD, recorded video tapes, some parts of digital satellite broadcasts, etc.
- If a video signal that cannot be read by this DVD video camera/recorder is present – even in images recorded on camcorder for personal enjoyment without copy-guard signal – the input image may not be recorded normally.
- If the input signal is interrupted by switching the channel on TV or switching the signal using video selector, normal recording cannot be performed.
- No "copy-once" image can be recorded on this DVD video camera/recorder even if a disc conforming to CPRM (Content Protection for Recordable Media) is used.
- When recorded images are played back on PC, black bands may appear at the top/bottom and on the left and right of screen.

RECORDING (DUBBING) IMAGES ON OTHER VIDEO DEVICES

You can record (dub) images played back on this DVD video camera/recorder, on other video devices.

Use the AV/S input/output cable (provided) to connect the DVD video camera/recorder to another video device as shown in the following figure:

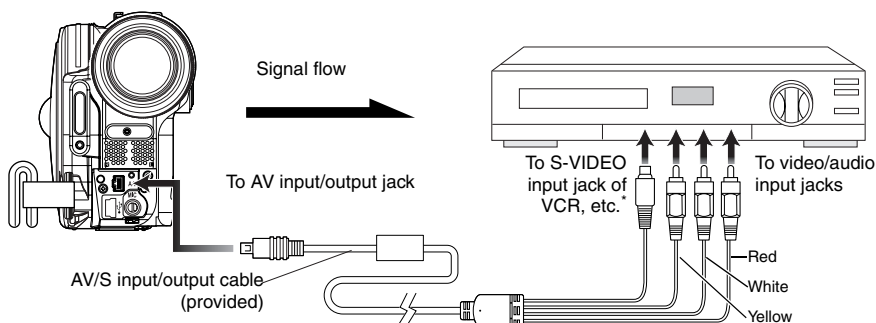

* If the video device to be connected has an S-VIDEO input jack, you can connect it to the DVD video camera/recorder.

- 1 Press the DISC NAVIGATION button.
- 2 Select a scene to be played back.
- 3 Set the channel of the connected video device to an external input.
- 4 Press the playback (▶/||) button on this DVD video camera/recorder and the record button on connected device: The DVD video camera/recorder will start playback and the recorded device will record (dub) it.

Note:

- Using S-VIDEO will enable you to record clearer images.
- Reduce the volume of external input sound heard from the built-in speaker: The loud volume may cause noise to enter the recorded image.
- It is recommended that you use Disc Navigation to create a play list including the scenes to be dubbed among the scenes recorded on this DVD video camera/recorder (p. 92).

Connecting to PC (DZ-GX3300A/ GX3200A/GX3100A/BX37A)

Software Provided

You can utilize on PC the videos and photos recorded on this DVD video camera/recorder, using the PC connection cable and software CD-ROM provided, or generally available software. The provided CD-ROM contains the following software for Windows and Macintosh:

Windows

ImageMixer 3

This allows you to import the images recorded on the DVD video camera/recorder into PC.

You can cut-edit imported images, add titles and BGM, and edit videos, i.e., attach image switching effect.

You can also create a DVD-Video (DVD-RW/DVD-R) and DVD-VR (DVD-RAM/DVD-RW) by importing the images recorded on the DVD video camera/recorder into PC.

Macintosh

Pixe VRF Browser EX

This allows you to import the images recorded on DVD-RAM/DVD-RW/DVD-R loaded in the DVD video camera/recorder into Macintosh as an MPEG file.

When importing an image, you can designate the import range.

ImageMixer VCD/DVD2

You can create a DVD-Video (DVD-RW/DVD-R) from the images imported into Macintosh using Pixe VRF Browser EX.

Note:

- The software for Macintosh provided with this DVD video camera/recorder is not compatible with a +RW.
- Finalize the DVD-RW/DVD-R recorded on the DVD video camera/recorder before using it on PC.
- You cannot create a DVD-VR (DVD-RAM/DVD-RW) on the Macintosh software.
- Since the audio format of the MPEG file imported into Macintosh using Pixe VRF Browser EX is AC3 audio, no audio will be played back even on QuickTime MPEG-2 playback component and only video is played back.
- The software provided with this DVD video camera/recorder cannot handle copyright-protected DVDs, such as CPRM and CSS.

The provided software can handle Japanese, English, German, French, Spanish, Italian and Chinese (simplified).

For explanation, this manual uses Windows XP screens for Windows and Mac OS X 10.4 screens for Macintosh.

Requirements of available PC

[When using Windows]

- OS: Windows® 2000 Professional SP3 or higher, XP Home Edition/XP Professional
* The provided software cannot be used on Windows® 98 or Windows® Me.
- Computer: IBM PC/AT compatible
- CPU: Intel® Pentium® III 800 MHz or higher (Pentium® 4, 1.7 GHz or higher is recommended)
* Operation is not guaranteed when the CPU is overlocked or dual CPU is used, or with a Pentium® compatible CPU other than those made by Intel® and AMD®.
- Memory: Windows 2000: At least 128 MB (256 MB or more is recommended)
Windows XP: At least 256 MB (512 MB or more is recommended)
- Free space on hard disk: At least 300 MB (needed to install the application)
When creating a disc or disc images, free space three times that of disc to be created will be required.
- Display that can show with at least 1024 × 768 pixels and 16 bits (High color)
- Graphics accelerator with VRAM of at least 4 MB, compatible with DirectX® 9.0c or higher
- USB: At least one unused port is necessary for this product (USB2.0 is recommended)

[When using Macintosh]

- OS: Mac OS X (10.2.8, 10.3.4-10.3.9, 10.4.1-10.4.3)
* The provided software cannot be used on Mac OS X Server.
- CPU: iMac G4, iMac G5, iBook G4, PowerBook G4, PowerMac G5, eMac series, Mac mini series or higher that is equipped with a USB2.0 port in standard
- Memory: At least 256 MB (512 MB or more is recommended)
- HDD: Free space needed for installation: Approx. 200 MB
Free space of at least 1 GB is needed on startup disc during running of application.
When creating a disc or disc images, free space three times that of disc to be created will be required.
- At least 1024 × 768 pixels, at least 32,000 colors (full-color is recommended)
- Environment where QuickTime 6 or higher can operate

The slot-in type drive of Mac is not compatible with an 8 cm disc: Be sure not to use the drive, since a disc inserted by mistake cannot be removed.

Note:

- You must have the administrator authority of the PC before installing software.
- Operation is not guaranteed in the following cases:
 - When connected via USB hub
 - Multiprocessor is not supported.
- Even when your PC satisfies the above conditions of available PC, malfunction may result or restriction in use may occur, depending on the combination of other software in PC or peripheral devices.
- Operation is not guaranteed when using your customized PC.
- Operation is not guaranteed on all PCs that satisfy the above recommended environment.

Installing Software

[When using Windows]

- 1 Turn the PC on.
If you have been using the PC, terminate all running software programs.
- 2 Insert the provided CD-ROM into the CD-ROM drive of PC.
The installer will automatically start, and the “Choose setting language” screen will automatically appear.
If the “Choose setting language” screen does not appear, use Windows My Computer or Explorer to open the drive in which the CD-ROM is located, and then double-click the setup.exe icon in it. (Extension “exe” may not appear depending on the PC used.)
- 3 Choose the language to be installed.
Choose the language used with ImageMixer 3, and then click “Next”.

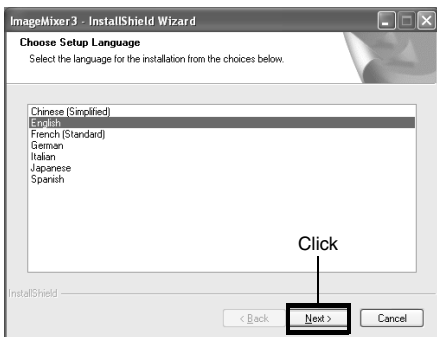

- 4 The “ImageMixer 3” installation screen will appear: Click “Next”.

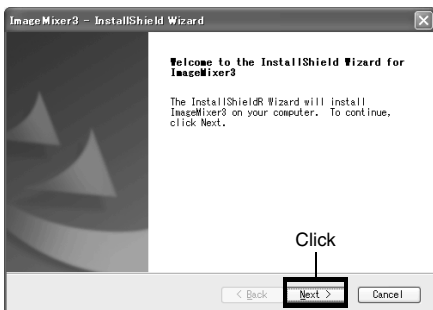

- 5 Checking license agreement:
Carefully read the license agreement: If you accept the contents, choose “I agree with all the items of the license agreement”, and then click “Next”.

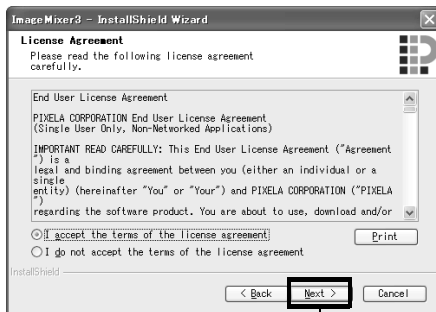

- 6 Choosing the installation destination:
If you do not wish to change the folder in which the software is installed, click “Next”.
If you wish to change the folder, click “Change”, designate the installation location, and then click “Next”.

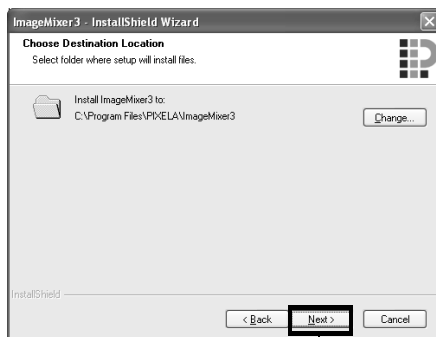

7 Choosing video system:

The screen for setting the video system will appear, and then click "Next".

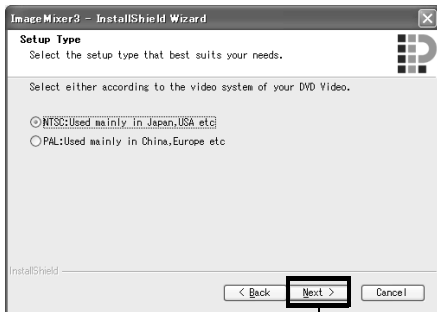

Click

8 Executing installation:

The setups for installation are now complete. Click "Install" to execute installation.



Click



Important information for customers who use Easy CD Creator 5 made by Roxio Corporation:

If ImageMixer 3 provided with this DVD video camera/recorder is installed, Easy CD Creator 5 may not operate normally. The screen shown below will appear after you click "Install":

If you are using Easy CD Creator 5, click "Yes", and do not install ImageMixer 3.

9 After installation is finished, the screen for prompting restart will appear: Click "Finish" to restart the PC.

After restart, remove the CD-ROM from the PC.

Installing the software is now complete.

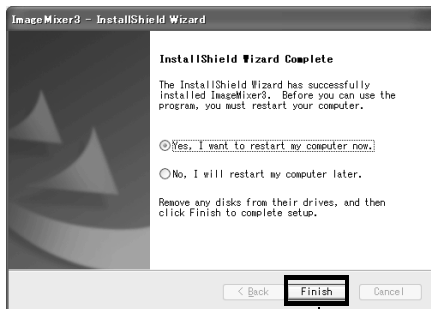

Click

Note:

- After installation is finished, the installation of Direct X may start depending on the PC used: In this case, follow the instructions on screen to install Direct X.

[When using Macintosh]

- 1 Turn the Macintosh on, and insert the provided CD-ROM into the CD-ROM drive of Macintosh.
- 2 Double-click the DVDCAM3000 icon displayed on desktop.
- 3 Double-click the icon of "ImageMixer for DVDCAM.pkg" displayed on screen. The installer will start: Click "Continue".
- 4 Checking license agreement: The license agreement screen will appear. Set the language to be used when installing the software, and then carefully read the license agreement: If you agree with the contents, choose "Continue". If you accept the license agreement, click "I agree".
 - * With the provided software for Macintosh, the language used with OS will automatically be installed.
- 5 Choosing the installation destination and type of installation: Follow the instructions on screen for operation: Installation will start.
- 6 After installation is finished, the screen for exit will appear: Click "Close". The screen for installation will close and installation will be complete: Remove the CD-ROM.

Setting language when installing



Click

Connecting to PC via PC Connection Cable

Use the provided PC connection cable to connect the DVD video camera/recorder to PC as shown below.

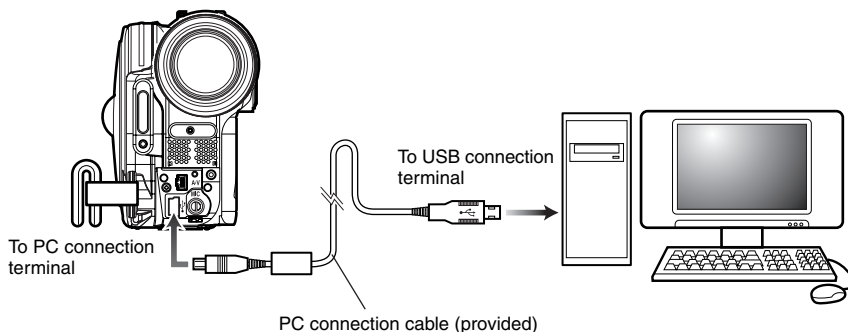

Note:



- The PC connection cable does not supply power to the DVD video camera/recorder: Use the AC adapter/charger to power the DVD video camera/recorder.
- Before connecting the DVD video camera/recorder to PC, disconnect any cables or camera accessories (external video flash, external microphone, etc.) other than the PC connection cable and AC adapter/charger.
- When connecting the DVD video camera/recorder to PC, the ACCESS/PC indicator will light green. While a disc is being accessed, the indicator will light or blink orange. While an SD memory card is being accessed, the CARD ACCESS indicator will light or blink red.
- When using Windows, the DVD video camera/recorder can be connected to a USB1.1 port of PC. However, since the data transfer speed is lower than when connecting to a USB2.0 port, lost frames may occur or the process may take more time.
- Read "Cautions when connecting DVD video camera/recorder to PC" on page 131.

The power switch of this DVD video camera/recorder has two modes: Disc mode when it is set to "📀" or "📷", and Card mode when it is set to "📄".

If you connect the DVD video camera/recorder to PC via PC connection cable, the PC will automatically recognize the DVD video camera/recorder. After recognition is finished, it may be prompted to restart the PC: In this case, follow the instruction and restart the PC.

When connecting the DVD video camera/recorder to PC, the DVD video camera/recorder will be recognized as a drive. The drive will appear on screen as follows:

[When using Windows]

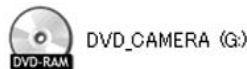

If the DVD video camera/recorder is connected to PC with its power switch set to “” or “”, it will be recognized as an optical disc drive, and a disc set in the DVD video camera/recorder can be accessed. (The shape of icon and drive name, such as G:, will depend on the software environment used.)

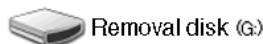

If the DVD video camera/recorder is connected to PC with its power switch set to “”, it will be recognized as a removal disk, and a card set in the DVD video camera/recorder can be accessed. (The drive name, such as G:, will depend on the software environment used.)



[When using Macintosh]

If the DVD video camera/recorder is connected to Macintosh USB port with the power switch set to “” or “”, it will be recognized as a removal drive, and the icon shown on the right will appear. (The shape of icon and drive name will depend on the software environment used.)



If the DVD video camera/recorder is connected to Macintosh USB port with the power switch set to “”, it will be recognized as a removal drive, and the icon shown on the right will appear.

Double-click this icon: The contents of card can be checked.

(The shape of icon and drive name will depend on the software environment used.)



The following operations are not possible on the DVD video camera/recorder while it is being connected to PC:

- Camera operation using operation buttons on DVD video camera/recorder
- Ejection of disc using DISC EJECT button on DVD video camera/recorder
- Power off using power switch

A disc loaded in the DVD video camera/recorder can be ejected by operating the PC.

- The disc and SD memory card can be replaced even though the DVD video camera/recorder is turned off or it is not connected.

● When removing disc

[When using Windows]

Use Windows Explorer or My Computer to choose the drive icon of DVD video camera/recorder.

→ Right-click the mouse.

→ Choose "Eject".

→ The cover of disc insertion block on DVD video camera/recorder will open.

Insert another disc and close the cover: The disc will be recognized.

[When using Macintosh]

Place the drive icon of this DVD video camera/recorder (displayed on desktop) in Trash Box: The cover of disc insertion block on DVD video camera/recorder will open. Load another disc and close the cover: The disc will be recognized.

● When removing SD memory card

[When using Windows]

Make sure that the SD memory card is not being accessed by the PC software on PC, and that the CARD ACCESS indicator on DVD video camera/recorder (see page 7) is not lit or blinking, and then remove the SD memory card from DVD video camera/recorder.

The CARD ACCESS indicator may be lit or blinking for a while after a file in PC is written to the SD memory card: Wait until the CARD ACCESS indicator goes out. It will sometimes take no less than a few minutes.

[When using Macintosh]

Drag the removal drive icon (displayed on desktop) and place it in Trash Box. After making sure that the icon disappears from desktop, remove the SD memory card from the card insertion slot of this DVD video camera/recorder.

Note:

- Do not use Explorer to operate any video files recorded on disc: Use the provided software. Do not use the PC to delete any photos recorded on a DVD-RAM.
- Disc and card cannot simultaneously be accessed.

USING DISC IN DVD DRIVE BUILT INTO PC

If you have a PC with the drive conforming to the disc used, and the application software, you can directly insert the disc into the drive to use it.

Whether a disc conforms to the DVD drive will depend on the DVD drive: Use a DVD drive that conforms to each disc.

Finalized DVD-RW/DVD-R/+RW discs can be used with DVD-ROM drive (reading only).

The slot-in type drive of Mac is not compatible with an 8 cm disc: Be sure not to use the drive, since a disc inserted by mistake cannot be removed.

Note:

- When writing images edited on PC to a brand-new DVD-RW, do not format the disc on DVD video camera/recorder.
- Some vertically installed and slot-in type drives on PC cannot accept an 8 cm disc.
- An adapter that converts 8 cm CD to 12 cm diameter (for 8 cm CD) cannot be used for any 8 cm DVD-RAM/8 cm DVD-RW/8cm DVD-R/8 cm +RW.
- If you use, on PC, a DVD-RW/DVD-R/+RW recorded on the DVD video camera/recorder, finalize it on the DVD video camera/recorder (see page 102).
- Some DVD-ROM drives cannot read a DVD-RW/DVD-R/+RW recorded on the DVD video camera/recorder.

BEFORE TERMINATING PC CONNECTION (UNPLUGGING PC CONNECTION CABLE)/CHANGING OVER POWER SWITCH

[When using Windows]

- 1 Before unplugging the PC connection cable from PC, terminate the application and then click the “Hardware Removal” icon on task tray at the bottom right of Windows screen.

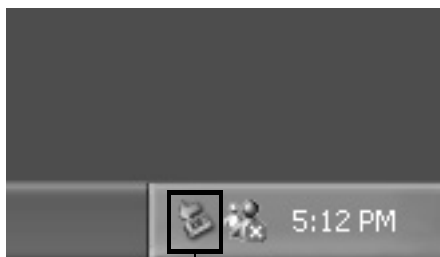

Click

[When using Macintosh]

When removing the DVD video camera/recorder from PC, choose the drive icon of DVD video camera/recorder (disc or card), and choose “Eject” in the “File” menu.

- 2 Choose “USB mass storage device”. The drive name (F:, etc.) will depend on the PC used.



- 3 A message showing that “hardware removal” is possible will appear.

Unplug the PC connection cable.

* If “hardware removal” results in error, terminate Windows® once, and then unplug the PC connection cable. When using Windows® 2000 Professional, installing Windows® 2000 SP3 or later may resolve the problem. Ask your PC manufacturer or Microsoft Corporation how to get Windows® 2000 SP3.

Using Software

See page 126 when using Macintosh.

[When using Windows]

USING IMAGEMIXER 3

ImageMixer 3 allows you to capture the images recorded on the DVD video camera/recorder into PC, edit the video file, and create a DVD-Video or DVD-VR using the video file.

The following shows the basic operation of ImageMixer 3.

Refer to the electronic instruction manual that can be read on PC for detailed instructions about ImageMixer 3: While ImageMixer 3 is being activated, click "Help" - "ImageMixer Help (F1)" to display this manual. See the electronic instruction manual for explanation on how to edit video files.

To start ImageMixer 3, double-click the ImageMixer 3 shortcut that was created when it was installed.

* If there is no ImageMixer 3 shortcut on desktop, choose [Start] - [Programs] or [All programs] - [PIXELA] - [ImageMixer 3] - [ImageMixer 3].

VIEWING IMAGES RECORDED ON DISC USING PC

* A DVD-RW/DVD-R/+RW recorded on this DVD video camera/recorder must be finalized on this DVD video camera/recorder.

1 Insert a disc whose recorded images you wish to play into the DVD video camera/recorder, and connect the DVD video camera/recorder to the USB port of PC.

2 Start ImageMixer 3.

When ImageMixer 3 starts up, the launcher shown below will appear: Click "Edit Video".



Click

3 Click "Edit new video".

4 The project setting screen will appear: Click "OK".



Click

It is not necessary change any setting when using PC to view the images recorded on disc.

- 5 The screen for choosing the device to be read will appear: Choose “Hitachi DVD CAM”. A list of devices that are built into or connected to PC will appear: Choose “Hitachi DVD CAM”, and then click “Import”.

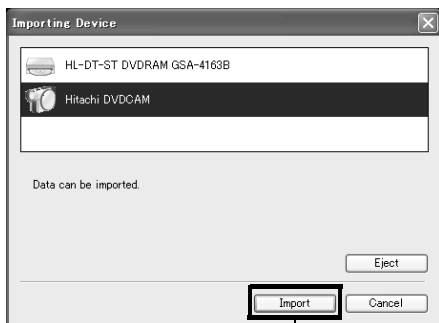

Click

- 6 Use the ImageMixer 3 Video Editor screen to select a title/chapter you wish to play back, and then click “Preview”. The image recorded on disc will appear. Select the title/chapter to be played back, and then click “Preview”: Playback will start.

Click the full-screen display button: A full-screen image will appear. To exit the full-screen display, double-click the screen. Click “Eject” button to play back the images on another disc. The cover of disc insertion block on DVD video camera/recorder will open: Remove the disc, and load another disc.



Click Full-screen display button

Note:

- When connecting the DVD video camera/recorder to a USB1.1 port of PC, the data transfer speed will be insufficient, which could result in lost frames.

CREATING DVD-VIDEO USING IMAGES RECORDED ON DISC

You can use the images recorded on the DVD video camera/recorder to create a disc that can be viewed on DVD recorders/players.

* A DVD-RW/DVD-R/+RW recorded on this DVD video camera/recorder must be finalized on this DVD video camera/recorder.

1 Insert a disc with the recorded images to be saved into the DVD video camera/recorder, and connect the DVD video camera/recorder to a USB port of PC.

2 Start ImageMixer 3.

When ImageMixer 3 starts up, the launcher shown below will appear: Click “Author DVD-Video”.

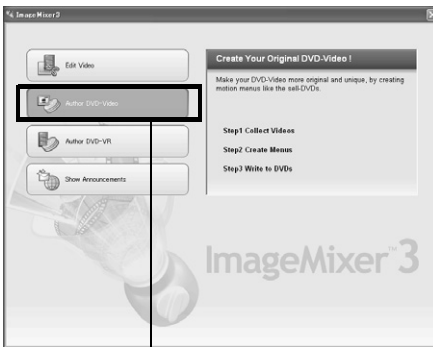

Click

3 Click “Create New DVD”.

4 Setting up project.

Set up a project. You can set up the designated save location of edited contents and image quality.

Be sure to choose “NTSC” for the video system.

The “PAL” system is used in Europe.

After setting up the project, click the “OK” button.

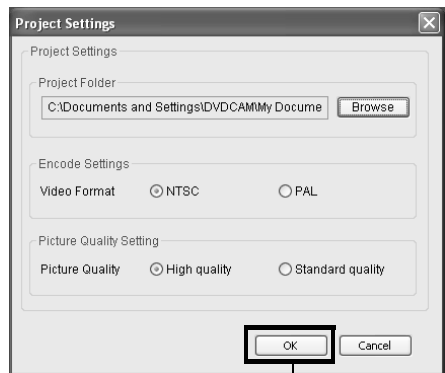

Click

5 The screen for choosing the device to be read will appear: Choose “Hitachi DVDCAM”. A list of devices that are built into or connected to PC will appear: Choose “Hitachi DVDCAM”, and then click “Import”.

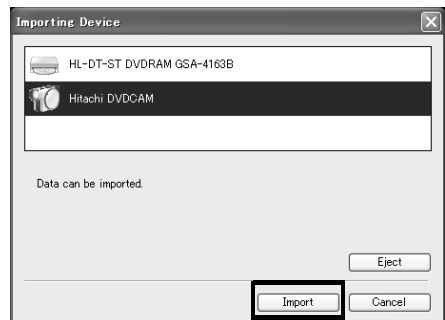

Click

- 6** Select the images from which you wish to create a DVD-Video, and then click “Import”. The image recorded on disc will appear. Select the chapter to be imported into PC, and then click “Import”: Importing into PC will start.

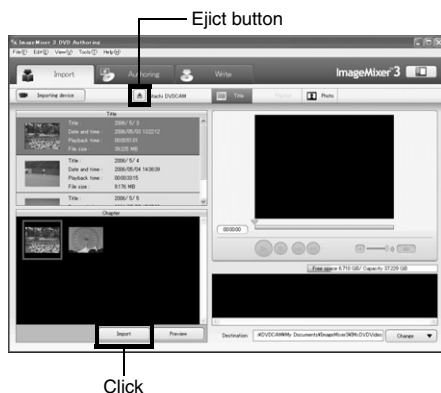

If you wish to import images on another disc after importing images on one disc, click the “Eject” button. The disc insertion block of DVD video camera/recorder will open: Remove the disc, insert the other disc whose recorded images you wish to import into the DVD video camera/recorder, and then close the disc insertion block. After a short while, the images on the disc will appear: Perform the same procedure to import the images. When the images on DVD-RW (VF-mode)/DVD-R/+RW are imported, the recording date/time will not appear.

Note:

- To import all chapters in the title at once, click “Select all” in the editing menu at the top of screen, and then click “Import”.



- To import multiple chapters, click the desired chapters while holding down the Ctrl key.

- 7** Click “Authoring” and create a DVD-Video menu. Clicking “Authoring” will display the editing screen of DVD-Video menu. The video file previously imported into PC will appear in “Source”. Choose the desired video file, and click “Add titles”: The video file will be registered. When using a video file imported into PC using ImageMixer 3, click “File” to choose the folder in which the video file will be stored.



Clicking “Theme” or “Set title menu” will allow you to change the design of DVD-Video menu. Choose the type of disc to be created (8 cm/12 cm/2-layer) using [Set] - [Configuration].

8 Click "Write" to create a DVD-Video.

Clicking "Write" will display the screen for writing.

Check "Create disc", perform setting for write, such as choosing DVD write drive, and then set a blank DVD-RW/DVD-R into the drive.

Clicking "Preview" will allow you to check any image of DVD to be created.

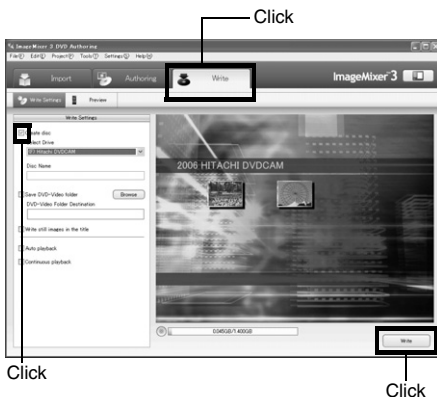

Click the "Write" button: The screen for setting write will appear. After checking the settings, click "OK": Writing will start.

When write is complete, the drive will open to eject the DVD: Creation of an original DVD is now finished.

Note:

- If you load a written DVD-RW in the write drive, the dialog "Are you sure you want to delete the content of disc?" will appear. Deleting the content of disc will erase all data on the disc: Carefully check the contents of disc. Choosing "Yes" will display the screen for choosing the disc erasure method: After checking it, click the "OK" button. Once the contents on disc have been deleted, the cover of disc insertion block on DVD video camera/recorder will open. Close the cover following the message instruction.
- If the disc contains a video file that does not conform to DVD-Video format, the video will be re-encoded, resulting in deterioration of image quality.
- If you execute "File" - "Save project", the halfway operation status can be saved as a project file. Reading in this saved project file will allow you to restart the operation from the saved status.
- A project file will be saved in the project folder that was set in step 4 on page 123, and the file name will be automatically attached.

[When using Macintosh]

USING PIXE VRF BROWSER EX AND IMAGEMIXER VCD/DVD2

Pixe VRF Browser EX allows you to import the images on DVD-RAM/DVD-RW/DVD-R recorded on the DVD video camera/recorder into PC as an MPEG file. ImageMixer VCD/DVD2 allows you to use the images imported by Pixe VRF Browser EX to create a DVD-Video (DVD-RW/DVD-R).

The following shows the basic operations of Pixe VRF Browser EX and ImageMixer VCD/DVD2. Refer to the electronic instruction manuals that can be read on PC for detailed instructions of Pixe VRF Browser EX and ImageMixer VCD/DVD2. See the electronic instruction manuals for the detailed use method of each software program.

For Pixe VRF Browser EX, click "Help" - "Pixe VRF Browser EX Help" while it is being started up.

For ImageMixer VCD/DVD2, click the question ? mark at the top right of the folder select screen.

To start Pixe VRF Browser EX and ImageMixer VCD/DVD2, double-click the "Pixe VRF Browser EX for DVDCAM" icon and "ImageMixer VCD/DVD2" icon in Macintosh HD (startup disk) - "Applications" - "ImageMixer for DVDCAM".

Note:

- The provided software cannot be used to burn a DVD-VR (DVD-RAM/DVD-RW): It is also incompatible with a +RW.

IMPORTING IMAGES RECORDED ON DVD-RAM/DVD-RW/DVD-R INTO PC TO CREATE A DVD-VIDEO (DVD-RW/DVD-R)

You can use the images recorded on the DVD video camera/recorder to create a disc that can be viewed on DVD recorders/players.

* Any DVD-RW/DVD-R/+RW recorded on this DVD video camera/recorder must be finalized.

1 Connect the DVD video camera/recorder with no disc loaded to a USB port of Macintosh.

- * If you connect the DVD video camera/recorder while a disc is loaded, you will have to remove the disc later.

2 Start Pixe VRF Browser EX and choose the drive.

Clicking the "Drive" icon will display the drive select screen. Choose "HITACHI DVD-RAM DZ-GBX3", and then click "OK". The cover of disc insertion block on DVD video camera/recorder will automatically open.

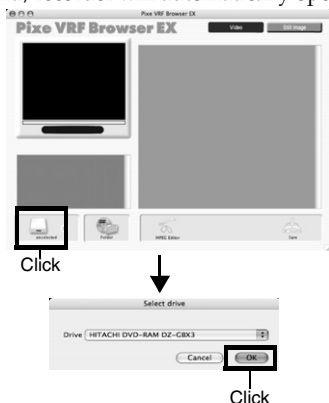

3 Set a disc.

Set a disc whose recorded video file you wish to import in the DVD video camera/recorder, close the cover of disc insertion block, and then click "OK".

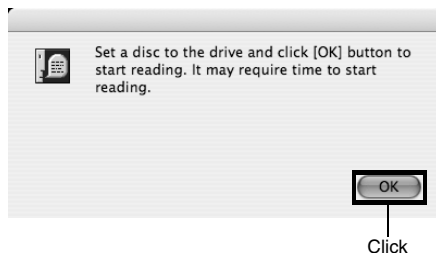

- 4** Select the video file to be imported and save it.
The scenes recorded on disc will appear. Select the scene to be imported into Macintosh and click “Save”: The save setting screen will appear.

Clicking “Save” after setting the save destination, etc. will start import into Macintosh.

If you wish to import the contents of another disc after importing is finished, click “Eject” on drive icons: The cover of disc insertion block on DVD video camera/recorder will open so that you can replace the disc. To import photos recorded on DVD-RAM, click the PHOTO button: The photos on disc will appear. Select the desired photo(s) and click “Save photo”.

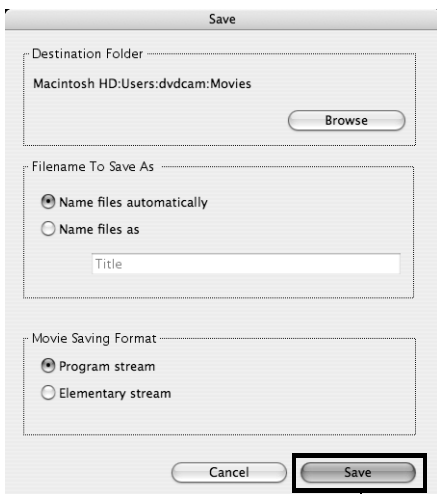

Click

When importing video files is complete, start ImageMixer VCD/DVD2 to create a DVD-Video using the imported files.

Note:

- When using images on ImageMixer VCD/DVD2, set the video saving format to “Program stream”.
- When importing the images on a DVD-RAM/DVD-RW (VR-mode), you can use the MPEG editor to designate the import range.
- When importing the images on a DVD-RW (VR-mode)/DVD-R, click the “Chapter” tab to select the image.
- If you double-click an MPEG file imported by Pixe VRF Browser EX on Finder, Pixe VRF Browser EX will start, but it cannot handle the imported MPEG file. Use the imported MPEG file on ImageMixer VCD/DVD2.

- 5** Start ImageMixer VCD/DVD2, and set up the files to be registered.
Start ImageMixer VCD/DVD2 and click the “DVD-Video” button.



Click

Note:

- No Video CD can be created or played back on this DVD video camera/recorder. And no writing to +RW/+R is possible when creating a DVD-Video.

- 6** Designate the folder in which the video file to be registered is stored.
Select the folder that you designated to save video files, and then click “Add”.

Click “Options” to choose the type of disc (8 cm or 12 cm) to create a DVD-Video.

Be sure to choose “NTSC” for the video system.
The “PAL” system is used in Europe.
After setting the option, click the “OK” button, and then click “Next”.



Click

Selecting save destination folder

7 Creating a DVD-Video menu:

Then edit the DVD-Video menu: You can set up the menu style, change the thumbnail to be displayed, and add a menu BGM.

After editing the menu screen, click “Next”.



Click

8 Checking playback:

The playback check screen will appear so that you can confirm the DVD images to be created. After playback check is finished, click “Next”.



Click

9 Writing to disc:

The screen for writing to disc will appear. Check “Create disc”, perform setting for write, e.g., choosing DVD write drive. Clicking the “Write” button will display the message “Set a blank media in DVD drive”. Set a blank DVD-RW/DVD-R into the drive, and then click “OK”.

The screen for setting write will appear: After checking the settings, click “OK”.



Click

Note:

- If you load a written DVD-RW in the write drive, a dialog “Are you sure you want to delete the contents of disc?” will appear. Deleting the content of disc will erase all data on the disc. Carefully check the content of disc. Once the contents on disc have been deleted, the cover of disc insertion block on DVD video camera/recorder will open. Close the cover following the message instruction.
- If the disc contains a video file that does not conform to DVD-Video format, the video will be re-encoded, resulting in deterioration of image quality.

Viewing Images recorded on Disc using PC

● Playing back DVD-RW (VF-mode)/DVD-R/+RW

You can use a DVD recorder/player to play back a DVD-RW (VF-mode)/DVD-R/+RW recorded and finalized on the DVD video camera/recorder.

1. Load the DVD-RW (VF-mode)/DVD-R/+RW to be played back in the DVD video camera/recorder.
2. Connect the DVD video camera/recorder to a USB port of Macintosh.
3. The DVD recorder/player will automatically start:
Start playback.

Note:

- When connecting the DVD video camera/recorder to Macintosh for playback on a DVD player, etc., the screen for setting the drive region code will appear: Set the region code that matches your local area.

● Playing back DVD-RAM/DVD-RW (VR-mode)

A DVD-RAM/DVD-RW (VR-mode) recorded on the DVD video camera/recorder cannot be played back, since the OS is not compatible with its playback. You can view images on Pixe VRF Browser EX, but no audio will be played back.

● Playing back MPEG files imported by Pixe VRF Browser EX

You can play back MPEG files imported into PC using Pixe VRF Browser EX, on the playback check screen of ImageMixer VCD/DVD2, after registering them on ImageMixer VCD/DVD2.

Since the audio format of the MPEG file imported into Macintosh using Pixe VRF Browser EX is AC3 audio, no audio will be played back even on QuickTime MPEG-2 playback component and only video is played back.

Note:

- Normal playback may not be possible depending on the disc recorded status.

● Handling photos

Photos are recorded on a DVD-RAM or SD memory card in this DVD video camera/recorder in JPEG format: Use the application that conforms to the JPEG images.

The following shows how to import photos into PC:

With DVD-RAM

You can use Pixe VRF Browser EX to import photos into PC. See steps 1-4 on page 126 and 127 for how to import using Pixe VRF Browser EX.

With SD memory card

Insert an SD memory card with photos recorded into the DVD video camera/recorder, and connect it to PC.

A removal drive icon will appear on desktop: Double-click the icon to display the contents on card.

The photos recorded on the DVD video camera/recorder are stored in "DCIM" - "100*HPNX1" folder on card: Drag and drop them to PC to import them.

*The number may be different if the card was recorded on another DCF conforming device.

Uninstalling Software

[When using Windows]

Use “Control Panel” to open “Add or Remove Applications”, choose the application to be uninstalled from the displayed list of applications, and then click the “Change/Remove” button.

Note:

- After uninstalling software, be sure to restart the PC.
- Administrator authority is required for uninstallation.

[When using Macintosh]

Manually move the following folders/files installed to Recycle Bin:

/Application/ImageMixer for DVDCAM
/User/Library/Preferences/IMxVCDDVD2Preference_HT
/User/Library/Preferences/ImageMixerVCDDVD2.plist
/User/Library/Preferences/com.PIXELA.Pixe VRF Browser EX for DVDCAM.plist
/Library/Receipts/ImageMixer for DVDCAM.pkg

Note:

- “User” will depend on the login user name.
- Administrator authority is required for uninstallation.

● PC Software Support Center number

PIXELA CORPORATION

+1-800-458-4029 (Toll-free)

+1-213-341-0163

URL:<http://www.pixela.co.jp/oem/hitachi/e/index.html>

Cautions when connecting DVD video camera/recorder to PC

Use the AC adapter/charger to power the DVD video camera/recorder when connecting it to PC:

The DVD video camera/recorder can also use a battery, but if the DVD video camera/recorder cuts off during data transfer, important recordings will be lost: If data is being written to disc, the disc will then be unusable.

Do not unplug cables while the disc in DVD video camera/recorder is being accessed from PC:

If the PC connection cable (provided) or power cable is unplugged while the ACCESS/PC or CARD ACCESS indicator is blinking, important recordings will be lost: If data is being written to disc, the disc will then be unusable.

Before connecting the DVD video camera/recorder to PC, disconnect any cables or camera accessories (external video flash, external microphone, etc.) other than the PC connection cable and AC adapter/charger.

Use a reference of approx. 30 minutes at approx. 86°F (30°C) or less for operation when connecting the DVD video camera/recorder to PC.

If the temperature of the DVD video camera/recorder is too high, writing or reading on the DVD video camera/recorder may be faulty. And note that, if an error occurs during writing to a DVD-R, the disc will no longer be usable.

Take care that the temperature of this DVD video camera/recorder is not too high.

Fade, skip or thumbnails set on the DVD video camera/recorder will not be reflected in the provided software.

If the DVD video camera/recorder is connected via USB hub or to a USB port on PC front panel or keyboard, the DVD video camera/recorder may not be recognized by PC: If this happens, connect the DVD video camera/recorder to a USB port on PC rear panel.

If the DVD video camera/recorder power is off, it cannot be connected to PC.

Do not use PC application to finalize a DVD-RW/DVD-R recorded on this DVD video camera/recorder: Doing so will make the disc unusable. The disc will become unusable.

Data may be readable or writable from/to the DVD video camera/recorder using software other than that provided with the DVD video camera/recorder, but Hitachi does not guarantee the operation.

If the PC is started from suspend (or sleep or standby) with the DVD video camera/recorder connected to the PC, the DVD video camera/recorder may not be recognized: Disconnect the DVD video camera/recorder from PC once, and restart the PC.

Multiple DVD video camera/recorders cannot be simultaneously connected to PC.

DVD discs created on the software provided with this DVD video camera/recorder can be played on DVD recorders/players, etc. that conform to each individual disc, but playback on all devices is not guaranteed. They may not be playable, depending on the playback device and/or disc recorded status.

Subsidiary Information

Introduction to Optional Accessories

CAMERA ACCESSORIES

Video flash (DZ-FLH3)*¹

Wide conversion lens (DZ-WL1)*²

Tele-conversion lens (DZ-TL1)*²

Step-up ring (DZ-SR3437 for DZ-GX3200A/BX37A/BX35A, DZ-SR3037 for DZ-GX3100A)

- When using camera accessories, be sure to read the instruction manuals for each accessory.

*¹ Unavailable for DZ-GX3100A/BX37A/BX35A.

*² You will need the optional step-up ring when attaching these lenses to the DZ-GX3200A/GX3100A/BX37A/BX35A.

With the DZ-GX3200A/BX37A/BX35A, be sure to remove the lens hood at the front of lens before attaching the lens.

POWER SUPPLY

Battery (DZ-BP7SW)*

Battery (DZ-BP14SW)

* Unavailable for DZ-GX3300A/GX3200A.

* Refer to the catalog for details.

* The models and specifications of the optional accessories shown on this page are subject to change, and their production may be discontinued.

Trouble Messages

A message may appear while you are operating the DVD video camera/recorder. If a message appears, refer to the following table and take appropriate corrective action. Messages are arranged in alphabetical order.

Message	Cause & Troubleshooting	Reference page
(1) Data error in a part of image file. Repair data now? (2) Found error in image file. Repair data now? (3) Data error in all image file. Repair all data now?	<p>It is possible that the system cannot normally complete writing of file when power is turned off for some reason during recording or editing (deleting, dividing or combining scenes, or creating play list). Selecting "YES" will automatically repair the video file, but even if "NO" is selected, the same message will appear when the DVD video camera/recorder is turned on next time. (Do not remove the disc while the DVD video camera/recorder is recognizing it: Ignoring this will deactivate the file repair function.) Follow the instructions on screen, taking note of the following cautions:</p> <ul style="list-style-type: none"> • Repair will normally be complete in several minutes, but it may take longer (up to one hour). • Be sure to use the AC adapter/charger to power the DVD video camera/recorder when repairing data: Repair is not possible using a battery. If a battery has been attached, turn the power switch off once, connect the AC adapter/charger, and then start repairing. • Data may not be repaired, depending on the timing when power was turned off. • Data may not be repaired normally if data recorded on another recorder is mixed in. • The repaired data may be different from the original recorded content because of partial deletion of defective portion. • Since the date/time for repair is added to the repaired data (only the corrected portion for partial repair), the original date/time information will be lost. • Since all movies, and then all stills, are repaired, the order of recorded contents will be lost in case of message (2) (3) only. • See *1 on page 138. 	—
(1) Disc is not formatted. Format the disc now? (2) Disc Format. Select record format. (Displayed only when DVD-RW is used.)	A DVD-RW/+RW that was initialized by PC and not initialized for camera use is inserted.	39
Auto finalizing... Please wait...	This message will appear with a +RW when it is removed after recording, or the last recorded scene was deleted. The auto-finalized +RW can be played back on a DVD recorder/player.	108
Cannot combine scene.	Unless consecutive scenes are selected, they cannot be combined.	81
Cannot combine scene of multiple programs. Create PlayList first, and then combine scenes.	Scenes in different programs (different recording dates) cannot be combined. Create a Playlist first, and then combine such scenes on the playlist.	81

Message	Cause & Troubleshooting	Reference page
Cannot combine. Deselect PHOTO scenes.	Select only movies and combine them.	81
Cannot combine. Select multiple scenes.	Select a range of at least 2 scenes to be combined, and then combine them.	81
Cannot delete scenes.	This may occur when scene that was edited for division, etc. is to be deleted. Combine the divided scenes, and then delete them.	79, 81
Cannot divide scene.	This message will appear when the scene is extremely short because division, etc. was repeated.	80
Cannot execute. Change display category to ALL.	This message will appear if you attempt to combine or move scenes with "Category: VIDEO or PHOTO" specified.	104
Cannot execute. Unselect multiple scenes.	Division or change in thumbnail was executed when multiple scenes were selected.	75
Cannot read disc. Check dirt/crack/both-sides contrary/inserted correctly.	Error occurred while the disc was being recognized. Make sure that there is no scratch or dirt on disc, that the surface/back of disc is not reversed, and that the disc is firmly pushed against the turntable. See *3 and *4 on page 139 for troubleshooting.	10, 38
CANNOT RECORD PHOTOS	<ul style="list-style-type: none"> This message will appear when the PHOTO button is pressed with the power switch set to "📷". You cannot record still image on DVD-RW/DVD-R/+RW disc (recordable of still images from PC). Use DVD-RAM disc to record still images. 	23, 152
CANNOT RECORD VIDEO	This message will appear when the REC button is pressed with the power switch set to "📹" or "📺".	42
Cannot replace thumbnail on PHOTO scenes.	The thumbnail of a still cannot be changed. Select a movie.	84
Cannot select any more scenes.	The maximum number of selectable scenes is 999.	87
CANNOT SLEEP MODE	The DVD video camera/recorder can enter the sleep/restart status only from the recording pause status. The following conditions apply: <ul style="list-style-type: none"> No disc or card is loaded. The disc or card has no remaining space. The power switch is set to "📷" with a DVD-RW (VF-mode)/DVD-R/+RW. 	43
CARD ALMOST FULL	Remaining space is only enough to record less than 10 stills. Delete unnecessary stills and try the card, or use another card.	79, 100, 153
Card error has occurred.	<ul style="list-style-type: none"> The card terminals may be dirty: Wipe off dirt, and try the card again, or use another card. Data other than still image may be included: Use another card. 	25
Card error has occurred. Format the card now?	Was the card formatted on PC? Was formatting interrupted midway? When using the card on this DVD video camera/recorder, choose "YES" and format it.	99

Message	Cause & Troubleshooting	Reference page
Card error has occurred. Formatting is not complete.	The card may be damaged: Use another card.	25
Card error has occurred. Keep card inside & restart.	Card error could have occurred during editing of scenes. Turn off the DVD video camera/recorder with the card being used inside, connect the AC adapter/charger, and then power the DVD video camera/recorder again.	26, 31
Card full.	Delete unnecessary stills and try the card, or use another card.	79, 153
	No more recording on this card can be done: Delete unnecessary stills or use another card.	
Card is not formatted. Format the card now?	Was the card formatted on PC? When using the card on this DVD video camera/recorder, choose "YES" and format it.	99
CHECK DISC	A disc unusable on this DVD video camera/recorder may have been inserted or the disc may be damaged. Make sure that the type of disc is correct, and make sure that the disc is not write-protected.	25, 100
Control Information Error.	Mismatch may occur between the recorded image and scene information. Update the control information.	101
	<ul style="list-style-type: none"> • Use another disc. • See *3 and *4 on page 139. 	—
COPY PROTECTED	The video signal input to this DVD video camera/recorder may be copy-guarded. Some prerecorded video materials, such as movies, are guarded against copying. Copy-guarded materials cannot be recorded on this DVD video camera/recorder.	110
DISC ACCESS	The recorded scene is being stored on disc.	41, 42
	This DVD video camera/recorder is verifying whether the correct disc has been inserted. Wait until the message disappears, and you can start to use the DVD video camera/recorder.	146
Disc error has occurred. Finalizing is not complete.	<ul style="list-style-type: none"> • Disc error occurred during finalizing, and finalizing failed. Replace the disc. • See *3 on page 139. 	102
Disc error has occurred. Format the disc now?	<ul style="list-style-type: none"> • Has the disc been initialized on PC? Has initializing the disc on PC been interrupted? Choose "YES" and initialize the disc when using it on this DVD video camera/recorder. Initializing the disc will erase all data on it. • See *2 on page 139. 	99
Disc error has occurred. Formatting is not complete.	The disc may be dirty. Remove the disc and wipe off fingerprints, dust, etc. before reusing it, or use another disc. This message may also appear if you insert a disc for which formatting was interrupted midway. In this case, use another disc.	10, 99

Message	Cause & Troubleshooting	Reference page
Disc error has occurred. Keep disc inside & restart.	Disc error could have occurred during editing of scenes. Turn off the DVD video camera/recorder with the disc being used in it, connect AC adapter/charger, and then power the DVD video camera/recorder again. Repair of scenes will be tried.	26
Disc error has occurred. Unfinalizing is not complete.	This message will appear when disc error occurred during unfinalization, and unfinalizing disc failed. Replace the disc.	103
Disc error has occurred.	<ul style="list-style-type: none"> • Use another disc. • See *3 and *4 on page 139. 	10, 24
	<ul style="list-style-type: none"> • Mismatch in recording information may be caused by editing done on some device other than this DVD video camera/recorder. Initialize the disc or use another disc. • Initializing the disc will erase all data on it. 	99
Disc full. Cannot execute.	Delete unnecessary scenes before using this disc, or use another disc.	79
Disc has no data.	This message will appear when an attempt is made to execute playback or editing on Disc Navigation with no scene recorded.	—
Disc has no PlayList.	Switching of play list was selected with no play list stored.	93
Disc includes protected scenes. Delete scenes?	The disc may be software protected from a device other than this DVD video camera/recorder. To release this case, use a device that has executed software-protect.	—
Disc is full. Cannot add control info.	The number of entered scenes has reached the limit that can be entered, so the control information for generating thumbnails cannot be added. Combine several scenes or delete them.	79, 81
Disc is not formatted. Format the disc now?	<ul style="list-style-type: none"> • Has the disc been initialized on a PC? Choose "YES" and initialize the disc when using it on this DVD video camera/recorder. Initialization will delete all data on the disc. • See *2 on page 139. 	99
Disc must be finalized before it can be played back on DVD player or DVD recorder.	<ul style="list-style-type: none"> • This message will appear if you remove a DVD-RW (VF-mode)/DVD-R that has not been finalized from the DVD video camera/recorder. • See *5 on page 139. 	108
Drive overheat. Please retry later.	The temperature inside the DVD video camera/recorder is too high, and reading or writing of the data on disc may not be performed normally. Turn the DVD video camera/recorder off and wait for a while. The temperature will be effectively decreased if the DVD video camera/recorder is placed in a well-ventilated spot.	31
DVD-R* Disc, 16:9 mode cannot be changed, when Video mode is STD.	With DVD-RW (VF-mode)/DVD-R/+RW disc, the setting of 16:9 mode will not be possible when the Video mode is STD. * "DVD-RW (VF)" will appear when using a DVD-RW (VF-mode), "+RW" will appear when using a +RW.	63
DVD-R* Disc, Input Source cannot be changed.	Once a DVD-RW (VF-mode)/DVD-R disc has been recorded in the 16:9 mode, the input source will not be changeable. * "DVD-RW (VF)" will appear when using a DVD-RW (VF-mode).	63

Message	Cause & Troubleshooting	Reference page
DVD-R* Disc, Video mode and 16:9 mode cannot be changed.	With DVD-RW (VF-mode)/DVD-R disc, the movie quality mode and 16:9 mode once used for recording cannot be changed. * "DVD-RW (VF)" will appear when using a DVD-RW (VF-mode).	63
DVD-RAM disc. Finalize is not required.	This message will appear if you press the FINALIZE button with a DVD-RAM loaded in this DVD video camera/recorder. No finalization is necessary for a DVD-RAM.	102
END OF DISC	The disc is full. You cannot record on this disc any more. Prepare another disc or delete unnecessary movie scenes from this disc.	79
Error occurred. Please replace disc or format disc.	<ul style="list-style-type: none"> Abnormality has occurred with the DVD-RAM/DVD-RW/+RW disc to be repaired. Initialize the disc before using it, or use the another disc. Initializing the disc will erase all data on it. See *2 on page 139. 	99
Error occurred. Please replace disc.	An abnormality occurred with a DVD-R disc to be repaired. Replace the disc.	—
Finalize may not be complete. Finalize again now?	This message will appear when power is supplied again and the disc is reinserted after power was shut off during finalization due to a power failure, etc. Choose "YES" if you wish to be sure finalizing is performed.	102
It is unrecordable on this card.	The inserted card cannot be used in this DVD video camera/recorder: Use another card.	25
JPEG files related to scenes are not found.	This message will appear when stills recorded on DVD-RAM disc using a device other than this DVD video camera/recorder are to be copied to card.	—
NO DISC	This message may appear when the DVD video camera/recorder or disc is moved from a cold place to a warm place. Condensation has occurred on the camera/recorder lens or DVD-RAM drive. Do not remove the disc; leave the DVD video camera/recorder turned off in a place as dry as possible for 1 – 2 hours.	6
	The disc has not been inserted. Insert it.	38
	The disc is not inserted correctly. Push the disc against the turntable at the center until a click is heard. See *3 and *4 on page 139.	38
	Is the disc surface/bottom reversed? Check the surface/bottom of disc, and reinsert it correctly.	38, 39
No more scenes. Playlist was deleted.	<ul style="list-style-type: none"> All scenes are deleted from the play list. Since a play list with no scenes cannot be supported by specifications, a play list from which all registered scenes have been deselected will be deleted. 	95, 96
Playlist over limit.	An attempt was made to create new play list or copy play list, even though limit specified for play lists in the video recording standard had already been stored.	92
Same scenes on Play List will be deleted. Delete scenes?	<ul style="list-style-type: none"> This will appear when scenes are to be deleted. When a play list exists on disc, an attempt to delete scenes in program will display this message. (This message will not appear if you deselect scenes from play list.) 	79

Message	Cause & Troubleshooting	Reference page
Scenes over limit. Cannot add scenes.	The number of scenes entered in play list has reached the limit that can be entered. Delete several scenes.	92, 96
Scenes over limit. Cannot divide scene.	The number of entered scenes has reached the limit that can be entered. Delete several scenes.	92, 96
Stop processing	The  button was pressed to stop processing of multiple scenes.	—
There was no scene which can be deleted.	This message will appear if you try to delete multiple scenes on Disc Navigation when all the selected scenes have been locked. Release the lock on scenes before executing deletion.	79, 86
The disc is finalized. Finalize is not required.	This message will appear if you press the FINALIZE button with a finalized DVD-RW/DVD-R/+RW loaded in this DVD video camera/recorder. Finalizing the disc is not necessary.	102
This disc cannot be used. Please replace disc.	A disc that cannot be used on this DVD video camera/recorder has been loaded. Check the type of disc.	25
This disc is recorded by the PAL system. Please replace disc.	This DVD video camera/recorder can use only discs recorded on the NTSC system. A disc recorded on the PAL system cannot be used on this DVD video camera/recorder.	—
UNFORMAT DISC	The disc is not initialized or it is damaged. If this message appears, be sure to initialize the disc on this DVD video camera/recorder before using it. Reinitializing even a disc used on this DVD video camera/recorder may be necessary (initializing will erase all recorded contents on disc). If this message appears, try to initialize the disc. If the same message still appears, the disc may be damaged: Use another disc.	99
	See *2 on page 139.	10
Use AC adapter/charger.	Finalization is not possible when the DVD video camera/recorder is powered by a battery: Use the AC adapter/charger for finalization.	26, 102
Use AC adapter/charger. Turn off power.	Scene cannot be repaired when the DVD video camera/recorder is powered by a battery. If the AC adapter/charger is unavailable in handy place, remove the disc, use the opposite side, or use another disc. To repair the removed disc, insert the disc into the DVD video camera/recorder afterwards, and connect the AC adapter/charger.	26
Write protected. Check card.	A card with the erase prevention switch locked is inserted: Unlock the switch.	25
Write protected. Check disc.	<ul style="list-style-type: none"> • A write-protected disc is inserted. • Release the write-protect using the Disc Navigation menu. 	100

*1

- This message may also appear when dirt adheres to disc. If this message appears when a recorded disc is recognized immediately after it is inserted, do not repair the disc; remove it and then use the provided disc cleaning cloth to clean off the dirt before using it.
- This message may also appear when condensation occurs. In this case, do not repair the disc; turn the DVD video camera/recorder off, wait until it dries out, and then turn it on again.

- If the repair message appears when you turn the DVD video camera/recorder on from off with a disc loaded after recording on it, choose repair.
- If the repair message appears when recording and playback are normally possible with another disc – and no condensation occurs and the disc is not dirty – choose repair.

*2

- This message may also appear when dirt adheres to disc. In this case, do not initialize the disc: Remove it and then use the provided disc cleaning cloth to clean off the dirt before using it.
- This message may also appear when condensation occurs. In this case, do not initialize the disc; turn the DVD video camera/recorder off, wait until it dries out, and then turn it on again.
- Initialization will delete all data on disc.

*3

- This message may also appear when dirt adheres to disc. Remove the disc and then use the provided disc cleaning cloth to clean off the dirt before using it.
- This message may also appear when condensation occurs. Wait until the DVD video camera/recorder dries out, and then turn it on again.

*4

- This message will appear when a single-sided disc is inserted in reverse. Reinsert the disc correctly. (Insert the disc with the label printed surface facing the outside.)

*5

- Do not insert a DVD-RW (VF-mode)/DVD-R disc that has not been finalized into any DVD recorder: The disc may be unusable (except for devices that allow playback of a DVD-R disc not finalized on this DVD video camera/recorder).

Troubleshooting

Check to see the following before asking for a repair. If the suggested solution still cannot restore the DVD video camera/recorder to normal, do not attempt to repair it yourself, but consult your dealer.

Power supplies

Symptom	Cause and Correction	Reference page
Battery cannot be charged.	Is the ambient temperature too low or too high? Charge the battery at 50 – 86°F (10 – 30°C).	27
	Is the battery abnormally hot? Remove the battery, leave it for a while to cool down, then charge it.	
	Is the DC power cord connected to AC adapter/charger? Unplug it.	
	Has the battery been unused for a long time? Remove the battery, and then reattach it. If the battery is still not charged, it may be dead: Purchase a new one. <ul style="list-style-type: none"> • If the battery does not charge after you try the above four procedures, it may be dead: Purchase a new battery. 	
Battery weakens fast.	Are you using the DVD video camera/recorder where the temperature is low? A fully charged battery (DZ-BP14S/DZ-BP07PW/DZ-BP14SW/DZ-BP7SW) may be discharged sooner than usual at low temperatures. Keep extra batteries on hand.	29
	Battery may be dead. The performance of battery will deteriorate if it is used for an extended period of time or frequently: Purchase a new battery.	30

Symptom	Cause and Correction	Reference page
The CHARGE indicator on AC adapter/charger is blinking.	Is the ambient temperature too low or too high? Charge the battery in environment where the temperature is 50 – 86°F (10 – 30°C). The battery has possibly discharged excessively. Continue charging: After a while, the battery will be charged to the specified voltage, and the CHARGE indicator will light. Then the battery charge will be completed normally.	27, 28
Power turns off immediately after being turned on.	Is battery charged? Charge it.	27
When power is turned on, the LCD screen will turn on and off.		
The ACCESS/PC indicator is blinking, even though nothing is displayed on LCD monitor screen.		
Power goes off unexpectedly.	Is Power Save set to “On”? If the powered DVD video camera/recorder is left for as long as 5 minutes without recording or playback with “Power Save: On” specified, it will automatically turn off to save battery power. To restart recording in this case, set the power switch to “OFF” and then set it to “  ”. You can also specify “Power Save: Off” to stop automatic power off.	34
Power cannot be turned off.	Detach the battery or AC adapter/charger once, and then press the RESET button of DVD video camera/recorder: Reattach a power supply to DVD video camera/recorder before turning it on again.	26, 28, 147
Even if the DVD video camera/recorder is off, opening the cover will cause the ACCESS indicator to blink.	The DVD video camera/recorder will automatically turn on to recognize a disc: Closing the cover will automatically turn the DVD video camera/recorder off.	39

During recording

Symptom	Cause and Correction	Reference page
Pressing the REC or PHOTO button will not start recording.	<ul style="list-style-type: none"> Is input image copy-guarded? Is a finalized disc in the DVD video camera/recorder? Is proper type of disc or card inserted? Is power switch set to match the recording medium? <ul style="list-style-type: none"> When using DVD-RAM disc. When using SD memory card: Set to "📷". Is the disc protected or the card locked? Does disc or card have remaining recording space? 	25, 31, 86, 100, 110
Recording starts but stops immediately.	Is disc scratched or does dirt or fingerprint adhere to it? Clean the disc. If there is still no improvement, replace the disc.	10
	Is some other AV device directly connected to the video/audio input/output jack of this DVD video camera/recorder? If the AV device is connected via several other devices, such as AV selector, the video signal may not be transmitted incorrectly. In such a case, reduce the number of devices through which the video signal is transmitted, or connect AV device directly.	109
	Are you attempting to record image from video game or PC? From some video games or PCs, image cannot be recorded on this DVD video camera/recorder.	—
LCD screen is hard to see.	Has brightness of LCD screen been adjusted? Stop recording and adjust the brightness.	36
	Is the DVD video camera/recorder being used outdoors? Use the viewfinder. When using LCD monitor, adjust its angle so that LCD screen is not exposed to direct sunlight.	32
Unevenness appears on LCD monitor screen.	Did you press the LCD monitor or the area around it? If the LCD monitor is pressed, some unevenness will occur. Release your hand and leave the LCD monitor for a while: Normal display will be restored.	—
Focus is not correct.	Is it difficult to use auto focus with your subject? Focus manually.	54
	Does "MF" appear? The DVD video camera/recorder is set to manual focus. Focus the subject manually, or release manual focus.	53
	Is the diopter control correctly adjusted if you are using the viewfinder as a monitor? Adjust the diopter control.	32
	In cases other than the above, set the power switch to "OFF", and then set it to "📷", "📹" or "📺" again.	31
An error message for repair appears.	Repair is only possible when the DVD video camera/recorder is powered by the AC adapter/charger. Remove the disc, and then insert another disc: The removed disc can later be repaired by connecting the AC adapter/charger.	26

During playback

Symptom	Cause and Correction	Reference page
Recognition of disc is not complete.	Is disc dirty? Use the provided disc cleaning cloth to clean it.	10
Pressing the playback button will not start playback.	Has the image been recorded by devices other than this DVD video camera/recorder? Playback of image recorded on devices other than this DVD video camera/recorder may be impossible on this DVD video camera/recorder.	70
	Has scene been edited on a device other than this DVD video camera/recorder? If a scene recorded on this DVD video camera/recorder is edited on a device other than this DVD video camera/recorder, playback may not be possible on this DVD video camera/recorder.	
No playback picture appears on TV screen.	Is TV input selector set correctly? Some TVs have multiple video input jacks. Check whether the correct input was selected on TV to match the connected jacks. If the DVD video camera/recorder is connected to VCR, set its input selector to "external input (LINE)".	107
	Is the DVD video camera/recorder connected to TV correctly? Check the connections.	106
Playback picture is momentarily interrupted.	Is disc scratched or does dirt or fingerprint adhere to it? Clean the disc.	10
Poor playback picture.	Was the image input from analog VCR (VHS, 8 mm) and recorded? The problem may be improved if a VCR equipped with TBC circuit is used for playback.	—
Playback picture is greatly distorted.	Was recording of external input made with "Frame" specified? Specify "Field" for "PHOTO Input" in record functions setup.	65
No sound	Is the TV volume control set correctly? Adjust TV volume control, and be sure to adjust the volume on TV.	107
Disc Navigation thumbnails do not appear.	Was the image recorded from AV input/output jack with interference? Record image with no noise or disturbance.	—

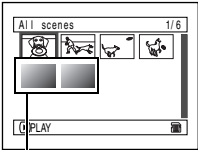
Symptom	Cause and Correction	Reference page
Photos on card cannot be played back.	<p>This DVD video camera/recorder can play back image data recorded on SD memory card in other digital cameras conforming to the DCF (Design rule for Camera File system) standard. The range of image data normally playable on this DVD video camera/recorder is that with pixels from 80 horizontal × 60 vertical to 4000 horizontal × 3000 vertical. If the pixel data is outside this range, blue thumbnails will appear (thumbnails* in the figure), meaning the image is unplayable.</p>  <p style="text-align: center;">* Fig. 1</p> <p>Even when the number of pixels is within the above range, playback may not be possible, depending on the recording status of the digital cameras used. DCF (Design rule for Camera File system) is an integrated image file format of digital cameras: Image files can be used on all digital devices conforming to DCF.</p>	—
It will take some time to play back photos on card.	When playing back a still, "Playback:" will appear: Stills with a large number of pixels will take some time to appear.	—

When the DVD video camera/recorder is connected to PC:

Symptom	Cause and Correction	Reference page
No drive icon appears on PC.	The DVD video camera/recorder is not turned on. Check the power supply.	31
	Turn PC off and then disconnect the PC connection cable. Turn PC on again, and then use the PC connection cable to connect the DVD video camera/recorder to PC.	—
	Make sure the PC connection cable is completely plugged into this DVD video camera/recorder.	—
Error occurs in playback of DVD video camera/recorder on PC.	If error occurs with USB connection, the transfer rate is not sufficient. It is recommended that you use a USB terminal conforming to USB2.0 when connecting the DVD video camera/recorder.	113
Application is not normally run on PC.	Turn the PC and DVD video camera/recorder off, and try again.	—
Error occurs during writing to disc.	The temperature of DVD video camera/recorder is too high due to continuous operation. Disconnect the DVD video camera/recorder from PC once, remove the disc from the DVD video camera/recorder, and then turn it off. After a few moments, connect them again and write to a brand-new disc.	—

Symptom	Cause and Correction	Reference page
Transfer of images stops.	Connect the DVD video camera/recorder to another USB terminal of PC. If your PC is a desktop type, it is recommended that you use USB terminal on the back of PC. If you are using USB2.0 extended card, it is also recommended that you install the newest version driver provided by each USB2.0 card maker.	—
	Is disc scratched or does dirt or fingerprint adhere to it? Clean the disc.	
DVD drive built into PC cannot be used after the provided software has been installed.	This problem may be solved if you update the DVD editing/creating software of your PC.	—
Error appears when starting DVD-ImageMixer 3.	Make sure that your PC display adapter (video card) conforms to DirectX9.0c.	113
Movies are not recognized by application in PC.	Make sure the power switch of this DVD video camera/recorder is set to "■" or "□".	31
The DISC EJECT button is not valid when the DVD video camera/recorder is connected to PC.	While the DVD video camera/recorder is connected to PC, use Explorer to right-click the DVD video camera/recorder drive icon and execute "Eject".	—
No sound is heard when an MPEG file imported into Macintosh is played back on Quick Time with an MPEG 2 playback component adopted.	Since an MPEG file imported into Macintosh using Pixe VRF Browser EX uses the audio format of AC3 audio, no audio will be played back even if the Quick Time MPEG-2 playback component is introduced: Only video will be played back. Use ImageMixer VCD/DVD2 for playback.	—
When the time stamp of file in DVD-RAM is viewed on PC, it is different from the actual recording time.	The file system of this DVD video camera/recorder is operated on Greenwich Mean Time (GMT), and time lag information has not been set. With Windows® as of January, 2006, the time stamp of file viewed on Explorer looks different from the actual recording time. The actual recording time will appear for date/time indication on playback screen.	—
It will take some time to save a video edited on the video editor of Image Mixer 3.	If you are editing a video file whose contents are different from those of project setting, it may take some time, since the entire video file must be re-encoded. Reconfirm the project setting.	—
"Hardware Removal" results in error.	Exit Windows® once, and then disconnect the DVD video camera/recorder. If your PC uses Windows® 2000 Professional, the problem may be solved if you install Windows® 2000 SP3 or later.	—
No USB HS (high speed) connection even when USB2.0 card is used.	Make sure that you have already installed the driver provided with the USB2.0 card. You will need to install the driver provided by USB2.0 card maker in order to operate the USB2.0 card at HS (high speed).	—

Miscellaneous

Symptom	Cause and Correction	Reference page
No DVD video camera/recorder operation.	Is a fully charged battery attached? Is the DVD video camera/recorder powered from AC outlet?	26, 27
Power does not come on, or no operation occurs by pressing button.	Execute system reset (press the RESET button).	147
	Has the DVD video camera/recorder been subjected to impact? The DVD video camera/recorder could be damaged. Consult your dealer.	—
The date and time are incorrect.	Has the DVD video camera/recorder been left unused for a long period of time? The internal backup memory battery may be discharged: Charge it.	33
Pressing the SLEEP/RESTART button will not set to the sleep/restart standby status.	<ul style="list-style-type: none"> • Is the proper disc or card loaded? • Does the disc or card have remaining free space? • Is the DVD video camera/recorder now playing back? • Is Disc Navigation screen displayed? 	43
No scene can be deleted.	Is the cursor placed on the scene to be deleted? If the selected scene (framed in red) exists, that scene will be deleted even if you use yellow cursor to select any scene. Check the colors of cursors and bar graph on the thumbnail screen.	75, 79
Disc cannot be removed. (Cover will not open.)	Did you detach the battery or AC adapter/charger before setting the power switch to "OFF"? Is the battery charged? Connect a charged battery or the AC adapter/charger, and then press the DISC EJECT button to remove the disc. Did the DVD video camera/recorder turn off because the battery remaining level ran out? Connect a charged battery or the AC adapter/charger, set the power switch to "OFF", and then press the DISC EJECT button to remove the disc.	38
DVD video camera/recorder cannot be operated from remote control.	Is the remote control pointed at the infrared receiver on DVD video camera/recorder? Point it at the infrared receiver to operate the DVD video camera/recorder.	22
	Is the infrared receiver on DVD video camera/recorder exposed to direct sunlight or strong fluorescent light, etc.? The remote control cannot operate the DVD video camera/recorder when strong light strikes the infrared receiver. Adjust the place or angle of the DVD video camera/recorder.	22
	Is there battery in the remote control? Also check the polarities of battery. The battery could be dead: Try replacing it.	21
	Is the DVD video camera/recorder powered? Turn it on.	31
Disc cover cannot be closed.	Is disc correctly inserted? Was disc inserted from wrong direction? Remove the disc and then reinsert it.	38
	Connect a fully charged battery or AC adapter/charger, and then turn the DVD video camera/recorder on.	26, 28

Symptom	Cause and Correction	Reference page
Operating sound is heard cyclically.	This sound is heard because the disc is cyclically operated and does not indicate a fault.	—
Some vibrations are felt or slight sound is heard from mechanism.	These vibrations or sound are caused by disc drive: This does not indicate a fault.	—
<ul style="list-style-type: none"> • No operation can be performed because the ACCESS/PC or CARD ACCESS indicator on this DVD video camera/recorder remains lit or blinking. • After disc or card is inserted, it takes some time until recording is possible. 	<p>In the following cases, it will take more time than usual until operation is possible:</p> <ul style="list-style-type: none"> • Immediately after a disc or card is reinserted. • When a long time has elapsed since the DVD video camera/recorder was turned off last. • When the temperature is greatly different from the status of previous recording. • When disc with scratches, dirt or fingerprints is inserted. • When disc is subject to severe vibrations. • When the battery or DC power cord was disconnected instead of following the correct procedure using power switch to turn the DVD video camera/recorder off. 	—
No image in viewfinder.	<p>Is LCD monitor open? No image will appear in viewfinder unless the LCD monitor is closed and securely locked to DVD video camera/recorder.</p>	—
No image appears on the LCD screen or in the viewfinder.	<ul style="list-style-type: none"> • Is DVD video camera/recorder connected to PC using PC connection cable? Unplug the PC connection cable. • Does DVD video camera/recorder stop at the end of the scene to which wipe-out was set and played back? Press the DISC NAVIGATION button. • Is the DVD video camera/recorder set to the sleep/restart status? 	—

System Reset

If the DVD video camera/recorder does not operate normally, perform "System Reset": The DVD video camera/recorder may recover to normal. "System Reset" will reset all settings to factory defaults. The date and time will also be reset: Set the date and time again before using the DVD video camera/recorder.

- 1 Set the power switch to "OFF" to turn the DVD video camera/recorder off.
Detach the battery or AC adapter/charger.
- 2 Use a fine tipped pen to hold down the reset button for several seconds.



All settings will be reset.

Note:

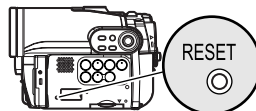
- Do not press the reset button with undue force.
- Do not press the RESET button with a disc loaded:
Doing so could erase the images recorded on the disc.



● List of setting items

	Item	Default	Setting method
Camera Functions Setup	Menu	Full Menu	p. 49
	Program AE	Auto	p. 57
	White Bal.	Auto	p. 58
	EIS	On	p. 60
	Dig.Zoom	40x*1	p. 51
	MIC.Filter	Off	p. 60
	Flash*2	Auto	p. 56
Record Functions Setup	VIDEO Mode	FINE	p. 61
	Quality	FINE	p. 64
	16:9	On	p. 62
	Input Source	CAMERA	p. 64
	PHOTO Input	Field	p. 65
	Self Timer	Off	p. 65
	OSD Output	On	p. 66
Date Setup	Date Set	1/1/2006 12:00AM	p. 33
	Date Mode	M/D/Y	p. 33
LCD/EVF Setup	LCD Brightness		p. 36
	EVF Brightness		p. 36
	Color Level		p. 37
	EVF Display	Auto	p. 37

	Item	Default	Setting method
Initial Setup	Beep	On	p. 34
	Power Save	Off	p. 34
	Record LED	On	p. 35
	Language	English	p. 34
	Demo Mode	Auto	p. 35

*1 "60x" will appear on DZ-GX3100A; "100x", on DZ-BX37A/BX35A.

*2 Not displayed on DZ-GX3300A when the optional video flash is attached to it. Not displayed on DZ-GX3200A/GX3100A/BX37A/BX35A.

- Some items will not appear depending on the disc or card inserted.

Major Specifications

CCD	DZ-GX3300A	:	1/3-inch interlaced
	DZ-GX3200A	:	1/3.6-inch interlaced
	DZ-GX3100A	:	1/5-inch interlaced
	DZ-BX37A/BX35A	:	1/6-inch interlaced
	Total number of pixels		
	DZ-GX3300A	approx.	3,310,000
	DZ-GX3200A	approx.	2,120,000
	DZ-GX3100A	approx.	1,330,000
	DZ-BX37A/BX35A	approx.	680,000
	Number of effective pixels		
	DZ-GX3300A	Movie:	approx. 2,180,000
		Movie:	approx. 1,640,000 (in wide mode)
	DZ-GX3200A	Still:	approx. 3,050,000
Movie:		approx. 1,230,000	
DZ-GX3100A	Still:	approx. 1,920,000	
	Movie:	approx. 690,000	
DZ-BX37A/BX35A	Still:	approx. 1,100,000	
	Movie:	approx. 340,000	
	Still:	approx. 340,000	

Lens		DZ-GX3300A : F1.8 – 3.0 f = 1/4" – 2-3/8" (6.1 – 61 mm) Filter diameter: 1-7/16" (37 mm) Thread pitch: 0.75 mm
		DZ-GX3200A : F1.8 – 2.2 f = 3/16" – 1-3/4" (4.5 – 45 mm) Filter diameter: 1-5/16" (34 mm) Thread pitch: 0.5 mm
		DZ-GX3100A : F1.2 – 2.8 f = 1/8" – 1-3/4" (3.0 – 45 mm) Filter diameter: 1-1/4" (30.5 mm) Thread pitch: 0.5 mm
		DZ-BX37A/BX35A : F1.8 – 3.2 f = 1/16" – 2-3/16" (2.2 – 55 mm) Filter diameter: 1-5/16" (34 mm) Thread pitch: 0.5 mm
Focus		Auto/Manual
Zoom		Optical 10× (DZ-GX3300A/DZ-GX3200A), Optical 15× (DZ-GX3100A), Optical 25× (DZ-BX37A/BX35A) 40× – 500× (DZ-GX3300A/GX3200A), 60× – 800× (DZ-GX3100A), 100× – 1,200× (DZ-BX37A/BX35A) with digital zoom added, 40× (DZ-GX3300A/GX3200A), 60× (DZ-GX3100A), 100× (DZ-BX37A/BX35A) for still
Required minimum illumination		0.3 lx in Low Light mode
Viewfinder		0.2-inch color (equivalent to approx. 200,000 pixels)
LCD monitor		2.7-inch color TFT (approx. 120,000 pixels)
Electronic image stabilizer		Electronic type
Shutter speed		1/4 – 1/4000 seconds (movie)
Self-timer recording		Still recording only
External microphone jack (Not equipped with DZ-BX37A/ BX35A)		ø3.5 mm stereo mini-jack: (a plug-in power type microphone cannot be used)
Recording mode		Movie (with sound) Still (with DVD-RAM disc, SD memory card)
Maximum recordable time (per side)	DVD-RAM/DVD-RW/ DVD-R/+RW disc	approx. 18 minutes (XTRA) approx. 30 minutes (FINE) approx. 60 minutes (STD)
Maximum number of recordable stills	DVD-RAM disc (per side)	DZ-GX3300A approx. 650 DZ-GX3200A/GX3100A/BX37A/BX35A approx. 999 External input approx. 999 If movies and stills are mixed on one disc, the recordable number will decrease.
	SD memory card (when using 32 MB card)	DZ-GX3300A approx. 18 (in FINE mode) DZ-GX3200A approx. 29 (in FINE mode) DZ-GX3100A approx. 45 (in FINE mode) DZ-BX37A/BX35A approx. 180 (in FINE mode) External input approx. 180 (in FINE mode) Varies depending on the recording quality and the type of card. (p. 153)

Recording format	DVD-RAM/DVD-RW (VR-mode) disc	<p>Movie:</p> <p>Conforming to DVD video recording (DVD-VR) format (Dolby Digital)</p> <p>Still (DVD-RAM only):</p> <p>Simultaneous recording, conforming to DVD video recording (DVD-VR) standard (720 × 480 pixels) and JPEG (DZ-GX3300A: 2,016×1,512 pixels, DZ-GX3200A: 1,600 × 1,200 pixels, DZ-GX3100A: 1,280 × 960 pixels, DZ-BX37A/BX35A: 640 × 480 pixels, External input: 640 × 480 pixels)</p>
	DVD-RW (VF-mode)/DVD-R disc	<p>Movie:</p> <p>Conforming to DVD video format (Dolby Digital)</p>
	+RW disc	<p>Movie: DVD+RW video format (Dolby Digital)</p>
	Card	<p>Still:</p> <p>Conforming to JPEG (DZ-GX3300A: 2,016×1,512 pixels, DZ-GX3200A: 1,600 × 1,200 pixels, DZ-GX3100A: 1,280 × 960 pixels, DZ-BX37A/BX35A: 640 × 480 pixels, External input: 640 × 480 pixels) standard</p>
Audio playback format		MPEG Audio layer 2, linear PCM, Dolby Digital
Recording medium		<p>8 cm DVD-RAM disc (conforming to DVD-RAM Ver. 2.1)</p> <p>8 cm DVD-RW disc (conforming to DVD-RW Ver. 1.1, 2x speed [2x/1x])</p> <p>8 cm DVD-R disc (conforming to DVD-R for General Ver. 2.0)</p> <p>8 cm +RW (conforming to +RW Ver. 1.2)</p> <p>SD memory card</p>
Jacks		<p>Video/audio input/output ×1 (DZ-BX37A/BX35A is provided with video/audio output × 1),</p> <p>External microphone input ×1 (Not equipped with DZ-BX37A/BX35A),</p> <p>PC connection terminal (connected to PC USB port) ×1 (Not equipped with DZ-BX35A)</p>
Battery system		Lithium-ion
Power consumption		<p>When recording with LCD monitor off (DVD-RAM disc used)</p> <p>DZ-GX3300A approx. 5.1W (in FINE mode)</p> <p>DZ-GX3200A approx. 4.4W (in FINE mode)</p> <p>DZ-GX3100A approx. 3.8W (in FINE mode)</p> <p>DZ-BX37A/BX35A approx. 3.2W (in FINE mode)</p>
Dimensions (W × H × D)		<p>DZ-GX3300A : approx. 1-7/8" × 3-9/16" × 5-3/16" (48 × 91 × 132 mm) (excluding projections)</p> <p>DZ-GX3200A : approx. 1-7/8" × 3-1/2" × 5-3/16" (48 × 89 × 132 mm) (excluding projections)</p> <p>DZ-GX3100A : approx. 1-7/8" × 3-3/8" × 4-3/4" (48 × 86 × 121 mm) (excluding projections)</p> <p>DZ-BX37A/BX35A : approx. 1-7/8" × 3-1/2" × 5-3/16" (48 × 89 × 131 mm) (excluding projections)</p>
Operating temperature (humidity)		<p>32 – 104°F (0 – 40°C) (less than 80%).</p> <p>32 – 86°F (0 – 30°C) when connected to PC</p>
Storage temperature		-4 – 140°F (-20 – 60°C)



Weight	DZ-GX3300A	approx. 470 g (without battery or disc)
	DZ-GX3200A	approx. 450 g (without battery or disc)
	DZ-GX3100A	approx. 420 g (without battery or disc)
	DZ-BX37A/BX35A	approx. 420 g (without battery or disc)
Total weight when recording	DZ-GX3300A	approx. 545 g
	DZ-GX3200A	approx. 525 g
	DZ-GX3100A	approx. 475 g
	DZ-BX37A/ BX35A	approx. 475 g
Provided accessories	AC adapter/charger, Battery, AV/S input/output cable (DZ-BX37A/BX35A is provided with AV/S output cable), Infrared remote control (not provided with DZ-GX3100A/BX35A), Lithium battery for remote control (not provided with DZ-GX3100A/BX35A), Lens cap, Lens cap string, Shoulder strap, Power cable, DC power cord, Software CD-ROM (not provided with DZ-BX35A), PC connection cable (not provided with DZ-BX35A), Single-sided 8 cm DVD-R disc (not provided with DZ-GX3100A/BX37A/BX35A), Disc cleaning cloth	

SIZE AND QUALITY OF PHOTOS



The following table shows the file size and quality of one still (JPEG) recorded on card:

Quality	File size					Application
	DZ-GX3300A	DZ-GX3200A	DZ-GX3100A	DZ-BX37A/ BX35A	External input DZ-GX3300A/ GX3200A/ GX3100A	
FINE	Approx. 1,600 KB	Approx. 1,024 KB	Approx. 640 KB	Approx. 160 KB	Approx. 160 KB	When image quality is prioritized
NORM	Approx. 1,200 KB	Approx. 768 KB	Approx. 480 KB	Approx. 120 KB	Approx. 120 KB	Standard quality
ECO	Approx. 800 KB	Approx. 512 KB	Approx. 320 KB	Approx. 80 KB	Approx. 80 KB	When number of stills is prioritized (quality will be slightly inferior)

Although still images are recorded on DVD-RAM disc only in the FINE mode, the quality mode can be chosen when recording stills on card (p. 64).

The file size of a photo recorded on DVD-RAM disc in “” status is equal to or larger than that recorded on card using the FINE quality in “”.

Note:

- No still can be recorded on DVD-RW/DVD-R/+RW disc.
- Since the file size is restricted in all quality modes when recording photos on card () , the quality of photos on card may be inferior to those recorded on DVD-RAM disc () .

RECORDABLE STILLS (PHOTOS) ON CARD

For DZ-GX3300A

Recording quality	Capacity					
	32 MB	64 MB	128MB	256 MB	512 MB	1 GB
FINE	Approx. 18	Approx. 38	Approx. 75	Approx. 150	Approx. 300	Approx. 600
NORM	Approx. 24	Approx. 50	Approx. 100	Approx. 200	Approx. 400	Approx. 800
ECO	Approx. 37	Approx. 75	Approx. 150	Approx. 300	Approx. 600	Approx. 1,200

For DZ-GX3200A

Recording quality	Capacity					
	32 MB	64 MB	128MB	256 MB	512 MB	1 GB
FINE	Approx. 29	Approx. 60	Approx. 120	Approx. 240	Approx. 480	Approx. 950
NORM	Approx. 38	Approx. 80	Approx. 160	Approx. 320	Approx. 650	Approx. 1,300
ECO	Approx. 58	Approx. 120	Approx. 240	Approx. 480	Approx. 950	Approx. 1,900

For DZ-GX3100A

Recording quality	Capacity					
	32 MB	64 MB	128MB	256 MB	512 MB	1 GB
FINE	Approx. 45	Approx. 95	Approx. 190	Approx. 380	Approx. 750	Approx. 1,500
NORM	Approx. 60	Approx. 120	Approx. 250	Approx. 500	Approx. 1,000	Approx. 2,000
ECO	Approx. 90	Approx. 190	Approx. 380	Approx. 760	Approx. 1,500	Approx. 3,000

For DZ-BX37A/BX35A

Recording quality	Capacity					
	32 MB	64 MB	128MB	256 MB	512 MB	1 GB
FINE	Approx. 180	Approx. 380	Approx. 750	Approx. 1,500	Approx. 3,000	Approx. 6,000
NORM	Approx. 240	Approx. 500	Approx. 1,000	Approx. 2,000	Approx. 4,000	Approx. 8,000
ECO	Approx. 370	Approx. 750	Approx. 1,500	Approx. 3,000	Approx. 6,000	Approx. 12,000

With external input (DZ-GX3300A/GX3200A/GX3100A)

Recording quality	Capacity					
	32 MB	64 MB	128MB	256 MB	512 MB	1 GB
FINE	Approx. 180	Approx. 380	Approx. 750	Approx. 1,500	Approx. 3,000	Approx. 6,000
NORM	Approx. 240	Approx. 500	Approx. 1,000	Approx. 2,000	Approx. 4,000	Approx. 8,000
ECO	Approx. 370	Approx. 750	Approx. 1,500	Approx. 3,000	Approx. 6,000	Approx. 12,000

(The numbers of recordable stills above are only for reference)

To Order in the United States

BY PHONE

**Service Hotline: 1-800-HITACHI
(1-800-448-2244)**

To Order in the Canada

**FOR AUTHORIZED HITACHI SERVICE
FACILITY IN CANADA**

Please consult the following telephone number
Service Direct: 1-800-HITACHI
(1-800-448-2244)

Choisissez les articles qui vous conviennent et
passez commande.

Service Direct: 1-800-HITACHI
(1-800-448-2244)

**TO ORDER ACCESSORIES
(Canada only)
BY PHONE**

**HITACHI CANADA LTD.
DIGITAL MEDIA DIVISION**

1-2495 Meadowpine Blvd.
Mississauga, Ontario
L5N 6C3

Service Direct: 1-800-HITACHI
(1-800-448-2244)

**POUR COMMANDER DES
ACCESSOIRES
(Canada seulement)
PAR TÉLÉPHONE**

**HITACHI CANADA LTD.
DIGITAL MEDIA DIVISION**

1-2495 Meadowpine Blvd.
Mississauga, Ontario
L5N 6C3

Service Direct: 1-800-HITACHI
(1-800-448-2244)

during business hours

Monday-Friday EST 9:00am – 7:00pm
Saturday EST 9:00am – 5:00pm

Durant les heures de bureau:

Lundi au vendredi 9:00am – 7:00pm (h.n.e)
Samedi 9:00am – 5:00pm (h.n.e)

DECLARATION OF CONFORMITY

with FCC Rules for Electromagnetic Compatibility

Products: DVD VIDEO CAMERA/RECORDER
Models: DZ-GX3300A/DZ-GX3200A/DZ-GX3100A/DZ-BX37A/DZ-BX35A
Trade Name: HITACHI

This device complies with part 15 of FCC Rules.

Operation is subject to the following two conditions: (1) this device may not cause harmful interference, and (2) this device must accept any interference received, including interference that may cause undesired operation.

Responsible Party: HITACHI AMERICA, LTD.
HOME ELECTRONICS DIVISION
900 Hitachi Way
Chula Vista, CA 91914-3556 U.S.A
Tel: 619-591-5200

Index

Numerics	
16:9	62
8 cm bare disc	24
A	
AC adapter/charger	26
ACCESS/PC indicator	41, 42
Add (edit)	95
All programs	89
Auto (program AE)	57
Autofocus	53
AV input/output jack	106
B	
Backlight correction	55
Battery	
Attaching to DVD video camera/recorder	28
Charging	27
Recordable time on DVD video camera/ recorder	29
Removing from DVD video camera/ recorder	28
Setting Up	27
BATTERY EJECT button	28
Black & White fade	82
Brightness	36
C	
Camera Functions Setup	50
Capacity	100
Card	
Available	25
Capacity	100, 153
Category	104
Format	99
Handling	25
Quality	64
CHARGE indicator	27
Cleaning	9
Color Level	37
Connecting to TV	106
Copy	85
Create	92
D	
Date and time	33
Date setup	33
Defaults	35
Delete (edit)	96
Delete (play list)	98
Delete (scene)	79, 95
Demo Mode	35
Detail (scene)	88
Dig. Zoom	51
Dioptr control	32
Disc	
Available	24
Finalize	102
Format	99
Handling	9
Protect	100
Update Control Info.	101
DISC EJECT button	38
Display	
Information LCD	44
Scenes information	88
Viewfinder	32
Divide	80
DVD player	108
DVD-R	24
DVD-RAM	24
DVD recorder	108
DVD-RW	24
E	
Edit (play List)	94
EIS	60
EXPOSURE button	55
Exposure control	55
External microphone jack	66
F	
Fade	82
FIELD (PHOTO Input)	65
FINALIZE button	102
Finalize Disc	102
FINE (VIDEO Mode)	61
FOCUS button	53
Format Disc	99
FRAME (PHOTO Input)	65
Frame advance/Frame back	71
Full Menu	49
G	
Go To (during playback)	73
Go To (on Disc Navigation)	99
H	
Hand strap	20
Howling	106
I	
Information display mode	44
Infrared receiver	22
Initial Setup	34
Input Source	64
L	
Language	34
Laser pickup block	38
Lens cap	21
Lens cap string attachment hole	21
Linear PCM	150
Lock	86
Lock switch	41
Low Light (Program AE)	58

M	
MENU button	49
MF	53
MIC.Filter	60
Move	97
O	
Optical 10x zoom lens	51
Optical 15x zoom lens	51
Optical 25x zoom lens	51
OSD Output	66
P	
PHOTO capture	71
PHOTO Input	65
Play (play list)	93
Play (program)	90
Play list	92
Add scenes	94
Add scenes (submenu)	95
Create	92
Delete	98
Delete scenes	95
Delete scenes (submenu)	96
Move	97
Play	93
Select scenes (submenu)	96
Switch	93
Title	98
Portrait (Program AE)	57
Power Save	34
Power switch	31
Program	89
Play	90
Switch	89
Title	90
Program AE	57
Protect Disc	100
Q	
Quality (Card)	64
Quick Menu	50
R	
Record button	41
Recording indicator	35
Remote control	21
Repeat Play	104
Reset	
settings	35
system	147
RESET button	147
+RW	24
S	
Sand & Snow (Program AE)	57
Scene	
Combine	81
Delete	79
Detail	88
Divide	80
Fade	82
Move	81, 97
Select	87
Skip	83
Searching for image	71
Select (Scene)	75
SELECT button	75
Self Timer	65
Shoulder Strap	20
Skip (Scene)	83
Skip playback	72
Slide Show	105
Sports (Program AE)	57
Spotlight (Program AE)	57
STD (VIDEO Mode)	61
Submenu	80
Switch (play list)	93
Switch (program)	89
T	
Tele-conversion lens	52
Thumbnail	68
Title (play list)	98
Title (program)	90
TV type	105
U	
Update Control Info.	101
V	
Video flash	56
VIDEO Mode	61
FINE	61
STD	61
XTRA	61
Video selector	63, 110
Vol. button	70
W	
White Bal.	58
White fade	82
Wide conversion lens	52
Wipe fade	82
X	
XTRA (VIDEO Mode)	61
Z	
Zoom lever	51

Be sure to read the following before opening the package of CD-ROM

This Agreement will take effect at the moment you open the package of the storage device (CD-ROM) provided with this product, if you agree to the terms herein.

If you do not accept the terms of this Agreement, immediately return the unopened package of storage medium and enclosed materials (printed matter, external package, and all others) to your dealer, or return only the package of storage medium to your dealer.

Consult your dealer for any refund on the unused product. However, if only the package of storage medium is returned, no refund is possible.

This License Agreement certifies that you were granted license in the past.

License Agreement

■ Grant of License

- Hitachi, Ltd. nonexclusively grants you the right to install this program in one computer and use it, but this right cannot be transferred to a third party.
- You can duplicate one copy of this program in a form readable on computer, but only for the purpose of backup, and under the condition that the display concerning the copyright remains in the original status.

■ Prohibition

- This program may not be used on network. If you wish to use it for multiple computers on network, you must obtain the right of use for each computer from Pixela Corporation.
- You may not let any third party use this program by granting reuse, transfer, lease, lending, etc.
- You may not modify, alter, decompile or deassemble all, or any part, of this program or its accessories. And you may not allow any third party do so.

■ Termination of Agreement

If you duplicate this program and its accessories without permission, or fail to comply with the above granting conditions, this agreement will automatically be terminated. In addition, Pixela Corporation may take legal action. When the agreement is terminated, you will be obliged to discard this program, its accessories and all duplicates, or return them to Pixela Corporation.

■ Guarantee and Immunity

This program and its accessories shall not, explicitly or implicitly, conform to the merchantability or compatibility for your specific purpose of use. Pixela Corporation does not guarantee that the functions of this program will meet your needs or this program will be free from interruption or error during its operation.

Under no circumstances will Pixela Corporation accept any responsibility for any direct or indirect losses or damages you may incur from using this program or activities relating to its use, or for any conflict occurring between you and a third party originating from, or relevant to, use of this program.

Warranty Limitations

The Limited Warranty provided by Hitachi does not cover:

- A. Cabinet (exterior finish items), Battery packs, Accessories, Lens Cleanings, Head Cleanings, DVD Disc Damage, Video Tape Damage, or Software Modifications.
- B. Any defect, malfunction, or failure caused by or resulting from improper service, maintenance, repair, use of DVD Cleaning Disks, use of Video Cleaning Cassettes, software, or from abuse, neglect, accident or any other cause beyond the control of Hitachi.
- C. Unpacking, set-up or installation, adjustment of customer operated controls, user instruction.
- D. Any product with Serial Numbers altered or removed.
- E. New products purchased or service performed outside of the continental United States or its possessions.
- F. Product used for a commercial or industrial purpose.

NO PERSON, AGENT, DISTRIBUTOR, DEALER, SERVICE FACILITY, OR COMPANY IS AUTHORIZED TO CHANGE, MODIFY, OR AMEND THE TERMS OF THIS LIMITED WARRANTY IN ANY MANNER OR FASHION WHATSOEVER, EXCEPT AND TO THE EXTENT PROVIDED IN THIS LIMITED WARRANTY. HITACHI MAKES NO EXPRESS WARRANTY REGARDING THIS HITACHI PRODUCT. FURTHER, ALL IMPLIED WARRANTIES RELATING TO ANY PORTION OF THIS PRODUCT, INCLUDING ANY WARRANTY OF MERCHANTABILITY OR FITNESS FOR A PARTICULAR PURPOSE, ARE LIMITED TO 90 DAYS FOR LABOR AND ONE YEAR FOR PARTS. THE DURATION OF THE APPLICABLE EXPRESS WARRANTY CONTAINED ABOVE. HITACHI SHALL NOT BE LIABLE TO THE PURCHASER OR TO ANY OTHER PERSON FOR ANY INCIDENTAL OR CONSEQUENTIAL DAMAGES OR LOSS OF PROFIT OF PRODUCT RESULTING FROM ANY DEFECT IN OR MALFUNCTION OR FAILURE OF THIS HITACHI PRODUCT. SOME STATES DO NOT ALLOW LIMITATIONS ON HOW LONG AN IMPLIED WARRANTY LASTS, OR THE EXCLUSION OF INCIDENTAL OR CONSEQUENTIAL DAMAGES, SO THE ABOVE LIMITATION MAY NOT APPLY TO YOU. THIS WARRANTY GIVES YOU SPECIFIC LEGAL RIGHTS AND YOU MAY ALSO HAVE OTHER RIGHTS WHICH VARY FROM STATE TO STATE.

Important Notice:

Retain your sales receipt for warranty purposes. Please complete the section below for your records as it may be needed in the event of loss.

Attach your sales receipt to this card.

DVD, VCR, Camcorder Products, AC Adapter Charger Limited Warranty Registration

(for your records)

Model No. _____

Serial No. _____

Date of Purchase _____

Dealer Name _____

Dealer Address _____

City _____

State _____

Zip _____

HITACHI

HITACHI

Hitachi America, Ltd.
Home Electronics Division

- *DVD Products*
- *VCR Products*
- *CAMCORDER Products*
- *AC ADAPTER CHARGER*

Conditions of Hitachi Limited Warranty

These Hitachi Products are warranted to be free of defects in parts and workmanship at the time of purchase by the original owner. If this product is found to be defective, Hitachi will repair or replace defective parts at no charge to the original owner. Parts used for replacement are warranted for the remainder of the original Limited Warranty period. For 90 days from the date of original purchase, Hitachi will provide labor for the repair or replacement of defective parts without charge, subject to the following conditions:

1. Owner must provide verification of the date of purchase when requesting Limited Warranty Service. (Dated Sales Receipt Required)
2. All repairs must be performed by a Hitachi Authorized Service Facility.
3. This warranty is valid only in the U.S.A.

LIMITED WARRANTY

Hitachi America, Ltd., Home Electronics Division ("Hitachi,") warrants this component in duration as stated below:

- **90 DAYS LABOR (Carry-in)**
- **1 YEAR PARTS (Except Battery)**

For information concerning repairs, operation, technical assistance or for referral to the location of your nearest Authorized Service Facility or Parts Distributor, call: 1-800-HITACHI (1-800-448-2244)

HITACHI AMERICA, LTD. HOME ELECTRONICS DIVISION

900 Hitachi Way
Chula Vista, CA 91914-3556
Tel: 1-800-HITACHI

**REGISTER YOUR HITACHI PRODUCT
ON-LINE AT HITACHI.COM/TV**

(Continued on reverse side)



REGISTER YOUR PRODUCT ON-LINE AT
HITACHI.COM/TV
OR MAIL IN TO ADDRESS ON THIS CARD.

HITACHI

“In order to allow Hitachi to better serve customer needs, please complete this card and return it to Hitachi America, Ltd., Home Electronics Division. Completion of this card is not required in order to validate your Hitachi limited warranty, but would assist us in developing better services and programs for our customers.”
(Please print or type)

Model No.

Serial No.

Date of purchase

Customer Name

Customer Address

City

State

Zip

()

Phone No.

Dealer name

Dealer address

City

State

Zip





Register your product on-line at hitachi.com/tv
or mail this portion to the following address



Attn:Warranty Department
Hitachi America, Ltd., Home Electronics Division
900 Hitachi Way
Chula Vista, CA 91914-3556

HITACHI CANADA LTD DIGITAL MEDIA DIVISION

HITACHI WARRANTY POLICY

HITACHI VIDEO PRODUCTS are guaranteed to be free from defects in workmanship and material. If any failure resulting from either workmanship or material defect should occur under normal and proper usage within the period stated hereunder from the original provable date of purchase, such failure should be repaired at no cost to the buyer, provided the defective product is brought to a HITACHI AUTHORIZED SERVICE CENTER in Canada.

IMPORTANT: KEEP THIS WARRANTY CARD AND ATTACH IT TO YOUR BILL OF SALE FOR FUTURE USE.

WARRANTY PERIOD - 1 YEAR PARTS AND LABOR

Where HITACHI service is not available, the purchaser must assume the responsibility and expense for the proper packing, shipping and all costs associated with the delivery to and from the closest HITACHI AUTHORIZED SERVICE CENTER. All goods returned to a HITACHI authorized service center must be shipped on a "PREPAID BASIS". To avoid any damage to the returned goods, please ensure that proper packaging procedures are followed. A short written description of the problem along with proof of warranty should accompany the product returned for repair. Only products under warranty will be returned on a no-charge basis to the customer. The customer is responsible for all transport costs if the product is no longer under warranty.

WARRANTY DOES NOT COVER:

- 1 Products received for repair without sales or delivery receipt showing date of purchase by the original customer.
- 2 Damages caused by incorrect use, carelessness, unauthorized alterations, improper storage or unauthorized repair or service.
- 3 Damage caused by fire, flood, lightning, acts of God, or other events beyond the control of Hitachi.
- 4 Products purchased and/or used outside Canada.
- 5 In transit damage claims, improper handling by carrier or post offices.
- 6 Products or parts thereof which have had serial numbers removed, altered or defaced.
- 7 Products used for commercial purposes or institutions.
- 8 Products used for rental.
- 9 Original installation (set-up), external adjustment and all normal maintenance needed such as cleaning of video head and lens pick-up, or any software modification or damage.
- 10 Products sold in Canada by any other organization which is not authorized by Hitachi Canada Ltd.
- 11 The replacement of video camera pickup element if the pick up element has been over-exposed to an intense source of light.
- 12 Batteries, earphone, antennas, accessories and external parts such as cabinet and knobs.

IMPORTANT: This warranty is in lieu of all other warranties, or agreements whether express or implied, and no person, dealer or company is authorized to change, modify, or extend its terms in any manner whatsoever.

HITACHI CANADA LTD

TERMES ET GARANTIE DES PRODUITS HITACHI

LES PRODUITS VIDÉO sont garantis contre tout défaut de matériel et de fabrication. Toute panne attribuable à de tels défauts sera réparée sans frais pourvu que la panne se soit produite lors d'un usage normal et au cours de la période de garantie ci-dessous qui court à partir de la date d'achat initiale et que l'appareil soit apporté à un CENTRE DE SERVICE AUTORISÉ HITACHI où l'appareil sera réparé sans frais.

IMPORTANT: CONSERVER CETTE CARTE DE GARANTIE AINSI QUE LA FACTURE D'ACHAT UTILISATION ULTÉRIEURE.

PÉRIODE DE GARANTIE: 1 AN PIÈCES ET MAIN-D'OEUVRE

En l'absence d'un centre de service HITACHI dans un rayon acceptable, l'acheteur doit assumer la responsabilité et les coûts pour un emballage adéquat, l'expédition ainsi que tous les coûts associés à la livraison de l'appareil au CENTRE DE SERVICE AUTORISÉ HITACHI le plus près. Toutes les dépenses encourues pour le transport ou la livraison à nos centres de service autorisés Hitachi sont aux frais de l'acheteur. Le produit doit être emballé adéquatement pour éviter les bris, tout en s'assurant d'y inclure une brève description du problème ainsi qu'une PREUVE validant la garantie. Seuls les produits encore couverts par la garantie seront retournés sans frais au consommateur.

CETTE GARANTIE NE S'APPLIQUE PAS DANS LES CAS SUIVANTS:

- 1 Produits reçus pour réparation sans preuve validant la garantie.
- 2 Dommages résultant de négligence, mauvais usage, réparation sans autorisation, entreposage inadéquat et de toute réparation effectuée par des centres de service non autorisés par Hitachi.
- 3 Dommages ou pertes échappant à tout contrôle de la part de Hitachi tel que: feu, inondation, foudre, etc.
- 4 Produits achetés et/ou utilisés à l'extérieur du Canada.
- 5 Dommages encourus suite à une mauvaise manipulation du transporteur ou de la poste.
- 6 Produits dont le numéro de série a été enlevé, retouché ou effacé.
- 7 Produits utilisés à des fins commerciales ou institutionnelles.
- 8 Produits utilisés pour la location.
- 9 Installation originale (réglage initial), réglage externe et tout entretien régulier tel que le nettoyage des têtes vidéo et de l'objectif ou toute modification ou tout dommage au logiciel.
- 10 Produits vendus au Canada par toute autre organisation qui n'est pas dûment autorisée par Hitachi Canada Ltd.
- 11 Le remplacement du tube de prise de vues sice dernier a été surexposé à une source de lumière intense.
- 12 Batteries, écouteurs, antennes, accessoires et toutes les parties externes telles que boutons et cabinet.

IMPORTANT: Cette garantie ne peut être modifiée par aucune autre garantie ou entente, écrite ou verbale. Aucune personne, marchand ou compagnie n'est autorisé à la changer, la modifier ou à en élargir les clauses d'aucune manière.

HITACHI CANADA LTD

HITACHI

VIDEO PRODUCT

PRODUIT VIDÉO

YOUR

VOTRE

WARRANTY

GARANTIE

HITACHI
Inspire the Next

HITACHI
Inspirer l'avenir

HITACHI CANADA LTD
DIGITAL MEDIA DIVISION

1-2495 Meadowpine Blvd., Mississauga, Ontario L5N 6C3 CANADA

IMPORTANT NOTICE: This warranty will not apply to product purchased outside of Canada OR sold by any organization other than HITACHI CANADA LTD

AVIS IMPORTANT: Notre garantie ne couvre pas les produits achetés à l'extérieur du Canada OU vendus par toute organisation autre que HITACHI CANADA LTD



IMPORTANT
REGISTER YOUR PRODUCT ON-LINE AT:
WWW.HITACHI.CA

IMPORTANT
ENREGISTREZ VOTRE PRODUIT EN-LIGNE À:
WWW. HITACHI.CA

HITACHI
Inspire the Next

"In order to allow Hitachi to better serve our customers' needs, please complete this card and return it to Hitachi Canada Ltd. Completion of this card is not required in order to validate your Hitachi limited warranty, but would assist us in developing better services and programs for our customers." (Please print or type)

« Afin de permettre à Hitachi de mieux répondre aux besoins de la clientèle, veuillez remplir cette carte et la retourner à Hitachi Canada Ltd. Il n'est pas nécessaire de remplir cette carte pour valider votre garantie limitée Hitachi; toutefois, elle nous aide à améliorer les services et programmes offerts à nos clients. » (En caractères d'imprimerie S.V.P.)

Model No. / N° de modèle Serial No. / N° de série Date of purchase / Date d'achat

Customer's first and last name / Prénom et nom du client

Customer's address - PO Box No. / Adresse ou casier postal du client

City / Ville Province Postal Code / Code postal

Telephone No. / N° de téléphone

Dealer's name / Nom du marchand Dealer's address / Adresse du marchand

City / Ville Province Postal Code / Code postal

What are the two most important factors that influenced your purchase decision?
Quels sont les deux facteurs les plus importants qui ont influencé votre décision d'achat?

How did you hear about this Hitachi, VIDEO PRODUCT?
Comment avez-vous pris connaissance des PRODUITS VIDÉO de Hitachi?

What other VIDEO PRODUCTS brands did you consider before selecting Hitachi?
Quelle autre marque de PRODUITS VIDÉO avez-vous envisagé d'acquies avant d'opter pour Hitachi?



Register your
product on-line at
Hitachi.ca or mail
to the address on
this card.

Enregistrez votre
produit en ligne à
Hitachi.ca ou par
la poste à
l'adresse indiquée
sur cette carte.



**ATT: WARRANTY DEPARTMENT
HITACHI CANADA LTD.
1-2495 MEADOW/PINE Blvd.,
MISSISSAUGA ON L5N 6C3**



DVDCAM PC Software Support Center

URL <http://dvdcam-pc.support.hitachi.ca/>

Support Center phone numbers for software provided:

Números de teléfono del Centro de soporte para el software suministrado:

Numéros de téléphone de l'Assistance Clientèle pour le logiciel fourni :

PIXELA CORPORATION

+1-800-458-4029 (Toll-free)

+1-213-341-0163

URL:<http://www.pixela.co.jp/oem/hitachi/e/index.html>

**HITACHI AMERICA, LTD.
HOME ELECTRONICS DIVISION**

900 Hitachi Way

Chula Vista, CA 91914-3556

Service Hotline: 1-800-HITACHI

(1-800-448-2244)

**HITACHI CANADA LTD.
DIGITAL MEDIA DIVISION**

1-2495 Meadowpine Blvd.

Mississauga, Ontario L5N 6C3

CANADA

Service Direct: 1-800-HITACHI

(1-800-448-2244)

<http://www.hitachi.ca/>

HITACHI
Inspire the Next
Hitachi, Ltd. Japan



This manual was printed
with soy based ink.