

HITACHI

Inspire the Next

Instruction Manual



MultiMediaCard™



DZ-MV550A
DZ-MV580A

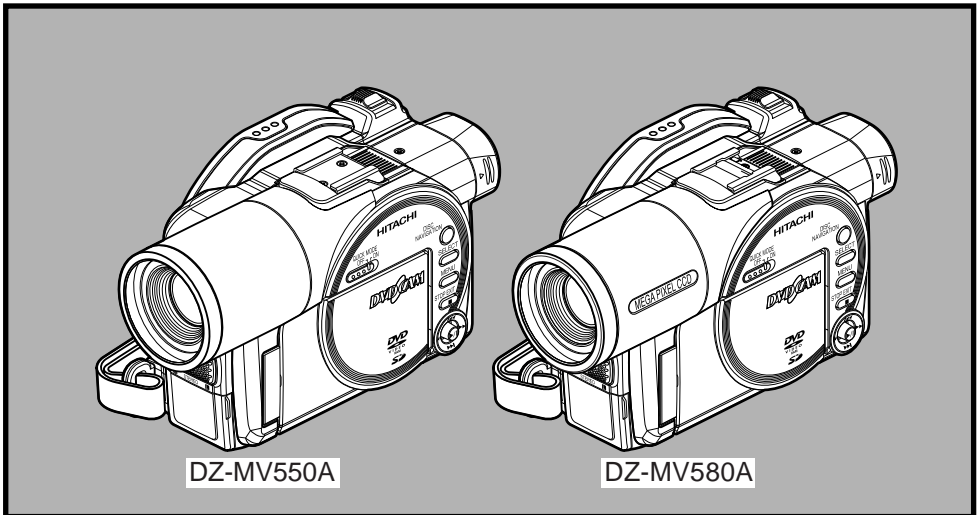

HITACHI AMERICA, LTD. HOME ELECTRONICS DIVISION

900 Hitachi Way
Chula Vista, CA 91914-3556
Service Hotline: 1-800-HITACHI
(1-800-448-2244)

HITACHI CANADA LTD. DIGITAL MEDIA DIVISION

2495 Meadowpine Blvd.
Mississauga, Ontario L5N 6C3
CANADA
Service Direct: 1-800-HITACHI
(1-800-448-2244)

DVDCAM PC Software Support Center

URL <http://dvdcam-pc.support.hitachi.ca/>

Thank you for buying a Hitachi product. Please take time to become familiar with the manual and how it is set up. Keep it handy for future reference.

Be sure to read page 187 before unpacking the provided CD-ROM.

The illustration of DZ-MV550A is shown on the front cover of this instruction manual. The method for operating the DZ-MV550A is the same as that for DZ-MV580A.



This manual was printed
with soy based ink.

Printed on recycled paper

Printed in Japan OS-H(1)

Important Information

For Your Safety

The power switch turns the DVD video camera/recorder on and off, leaving the date/time feature unaffected. If the camera/recorder is to be left unattended for a long period of time, turn it off.

WARNING : TO PREVENT FIRE OR SHOCK HAZARD, DO NOT EXPOSE THIS UNIT TO RAIN OR MOISTURE.

WARNING : TO PREVENT FIRE OR SHOCK HAZARD, USE THE RECOMMENDED ACCESSORIES ONLY.



WARNING: TO PREVENT FIRE OR SHOCK HAZARD, BE SURE TO USE THE SPECIFIED AC ADAPTER/CHARGER (DZ-ACS1).

The DVD video camera/recorder and AC adapter/charger have the following caution marks.



CAUTION

**RISK OF ELECTRIC SHOCK
DO NOT OPEN**



CAUTION: TO REDUCE THE RISK OF ELECTRIC SHOCK, DO NOT OPEN. NO USER-SERVICEABLE PARTS INSIDE. REFER SERVICING TO QUALIFIED SERVICE PERSONNEL.

Identifications of caution marks



This symbol warns the user that uninsulated voltage within the unit may have sufficient magnitude to cause electric shock. Therefore, it is dangerous to make any kind of contact with any inside part of this unit.



This symbol alerts the user that important literature concerning the operation and maintenance of this unit has been included. Therefore, it should be read carefully to avoid any problems.

Precautions

WARNING: Many television programs and films are copyrighted. In certain circumstances, copyright law may apply to private in-home videotaping of copyrighted materials.

This Class B digital apparatus complies with Canadian ICES-003.

The liquid crystal display (LCD) panel is made by highly precise technology. More than 99.99% of its picture elements (pixels) are effective, but some (less than 0.01%) may appear as colored bright dots. This does not indicate a fault as the LCD panel stretches the limits of current technology.

**CLASS 1
LASER PRODUCT**

CAUTION

This product contains a laser diode of higher class than 1. To ensure continued safety, do not remove any covers or attempt to gain access to the inside of the product. Refer all servicing to qualified personnel.

Warning: This device complies with Part 15 of the FCC Rules. Operation is subject to the following two conditions: (1) This device may not cause harmful interference, and (2) this device must accept any interference received, including interference that may cause undesired operation.

Note: This equipment has been tested and found to comply with the limits for a Class B digital device, pursuant to Part 15 of the FCC Rules. These limits are designed to provide reasonable protection against harmful interference in a residential installation. This equipment generates, uses, and can radiate radio frequency energy and, if not installed and used in accordance with the instructions, may cause harmful interference to radio communications. However, there is no guarantee that interference will not occur in a particular installation. If this equipment does cause harmful interference to radio or television reception, which can be determined by turning the equipment off and on, the user is encouraged to try to correct by one or more of the following measures:

- Reorient or relocate the receiving antenna.
- Increase the separation between the equipment and receiver.
- Connect the equipment into an outlet on a circuit different from that to which the receiver is connected.
- Consult the dealer or an experienced radio/TV technician for help.

Caution to the user: Changes or modifications not expressly approved by the manufacturer void the user's authority to operate the equipment.

Microsoft®, Windows®, Windows® 98, Windows® 98 Second Edition, Windows® Me, Windows® 2000 Professional, and Windows® XP are registered trademarks of Microsoft Corporation.

Intel®, Pentium® Processor, and Celeron® Processor are registered trademarks of Intel Corporation.

IBM® and PC/AT® are registered trademarks of International Business Machines Corporation.

Manufactured under license from Dolby Laboratories.

“Dolby” and the double-D symbol are trademarks of Dolby Laboratories.

Other company names and product names listed are trademarks or brand names belonging to each individual company.

SD logo is a trademark.

IMPORTANT SAFEGUARDS

In addition to the careful attention devoted to quality standards in the manufacture of your video product, safety is a major factor in the design of every instrument. But, safety is your responsibility too.

This page lists important information that will help to assure your enjoyment and proper use of DVD video camera/recorder and accessory equipment. Please read it carefully before operating your video product and keep it in a handy place for future reference.

INSTALLATION

- 1 Read and Follow Instructions** — All the safety and operating instructions should be read before the video product is operated. Follow all operating and use instructions.



- 2 Retain Instructions** — The safety and operating instructions should be retained for future reference.
- 3 Heed Warnings** — Comply with all warnings on the video product and in the operating instructions.
- 4 Power Sources** — This video product should be operated only from the type of power source indicated on the marking label. If you are not sure of the type of power supply to your home, consult your video dealer or local power company. For video products intended to operate from battery power, or other sources, refer to the operating instructions.

- 5 Overloading** — Do not overload wall outlets and extension cords as this can result in a risk of fire or electric shock. Overloaded AC outlets and extension cords are dangerous, and so are frayed power cables, damaged or cracked wire insulation and broken plugs. They may result in a shock or fire hazard. Periodically examine the cord and have it replaced by your service technician if appearance indicates damage or deteriorated insulation.



- 6 Power-Cord Protection** — Power-supply cords should be routed so that they are not likely to be walked on or pinched by items placed upon or against them, paying particular attention to cords at plugs, convenience receptacles, and the point where they exit from the appliance.

- 7 Ventilation** — Slots and openings in the cabinet are provided for ventilation to ensure reliable operation of the video product and to protect it from overheating. These openings must not be blocked or covered. The openings should never be blocked by placing the video product on a bed, sofa, rug, or other similar surface. This video product should never be placed near or over a radiator or heat register. This video product should not be placed in a built-in installation such as a bookcase or rack unless proper ventilation is provided or the video product manufacturer's instructions have been followed.



- 8 Attachments** — Do not use attachments unless recommended by the video product manufacturer as they may cause hazards.

Caution: Maintain electrical safety. Powerline operated equipment or accessories connected to this unit should bear the UL listing mark or CSA certification mark on the accessory itself and should not have been modified so as to defeat the safety features. This will help avoid any potential hazard from electric shock or fire. If in doubt, contact qualified service personnel.

- 9 Water and Moisture** — Do not use this video product near water — for example, near a bath tub, wash bowl, kitchen sink, or laundry tub, in a wet basement, or near a swimming pool, and the like.
- 10 Accessories** — Do not place this video product on an unstable cart, stand, tripod, bracket, or table. The video product may fall, causing serious injury to a child or adult, and serious damage to the appliance. Use only with a cart, stand, tripod, bracket, or table recommended by the manufacturer, or sold with the video product. Any mounting of the product should follow the manufacturer's instructions, and should use a mounting accessory recommended by the manufacturer.

- 11** An appliance and cart combination should be moved with care. Quick stops, excessive force, and uneven surfaces may cause the appliance and cart combination to overturn.



- 12 Power Lines** — An outside antenna system should not be located in the vicinity of overhead power lines or other electric light or power circuits, or where it can fall into such power lines or circuits. When installing an outside antenna system, extreme care should be taken to keep from touching or approaching such power lines or circuits as contact with them might be fatal. Installing an outdoor antenna can be hazardous and should be left to a professional antenna installer.

USE

- 13 Cleaning** — Unplug this video product from the wall outlet before cleaning. Do not use liquid cleaners or aerosol cleaners. Use a damp cloth for cleaning.
- 14 Object and Liquid Entry** — Never push objects of any kind into this video product through openings as they may touch dangerous voltage points or short-out parts that could result in a fire or electric shock. Never spill liquid of any kind on the video product.

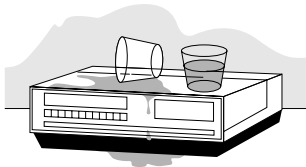

- 15 Lightning** — For added protection for this video product during a lightning storm, or when it is left unattended and unused for long periods of time, unplug it from the wall outlet and disconnect the antenna or cable-system. This will prevent damage to the video product due to lightning and power-line surges.



Disposal of these materials be regulated due to environmental considerations. For the disposal or recycling information, please contact your local authorities or the Electronics Industries Alliance : "www.eiae.org."

SERVICE

- 16 Servicing** — Do not attempt to service this video product yourself as opening or removing covers may expose you to dangerous voltage or other hazards. Refer all servicing to qualified service personnel.
- 17 Conditions Requiring Service** — Unplug this video product from the wall outlet and refer servicing to qualified service personnel under the following conditions.
- When the power-supply cord or plug is damaged.
 - If liquid has been spilled, or objects have fallen into the video product.
 - If the video product has been exposed to rain or water.
 - If the video product does not operate normally by following the operating instructions. Adjust only those controls that are covered by the operating instructions. Improper adjustment of other controls may result in damage and will often require extensive work by a qualified technician to restore the video product to its normal operation.
 - If the video product has been dropped or the cabinet has been damaged.
 - When the video product exhibits a distinct change in performance — this indicates a need for service.

- 18 Replacement Parts** — When replacement parts are required, have the service technician verify that the replacements he uses have the same safety characteristics as the original parts. Use of replacements specified by the video product manufacturer can prevent fire, electric shock or other hazards.

- 19 Safety Check** — Upon completion of any service or repairs to this video product, ask the service technician to perform safety checks recommended by the manufacturer to determine that the video product is in safe operating condition.

- 20 Heat** — The product should be situated away from heat sources such as radiators, heat registers, stoves, or other products (including amplifiers) that produce heat.

Cautions When Using

Handle the liquid crystal display (LCD) with care:

- The LCD is a very delicate display device: Do not press its surface with force, hit it or prick it with a sharp object.
- If you push the LCD surface, unevenness in display may occur. If unevenness does not disappear soon, turn the DVD video camera/recorder off, wait for a few moments, and then turn it on again.
- Do not place the DVD video camera/recorder with the open LCD screen down.
- Close the LCD monitor when not using the DVD video camera/recorder.

Liquid crystal display (LCD) and viewfinder:

- The LCD screen and viewfinder are the products of highly precise technology. Among the total number of pixels (approx. 120,000 pixels for LCD monitor and approx. 110,000 pixels for viewfinder), 0.01% or less pixels may be missing (black dots) or may remain lit as colored dots (red, blue, green). This shows the limitations of the current technology, and does not indicate a fault that will interfere with recording.
- The LCD screen and viewfinder will be slightly dimmer than usual when the DVD video camera/recorder is at low temperature, as in cold areas, or immediately after power is turned on. Normal brightness will be restored when the temperature inside the DVD video camera/recorder rises.

Hold the DVD video camera/recorder correctly:

- Do not hold the viewfinder or LCD monitor when lifting the DVD video camera/recorder: The viewfinder or LCD monitor could detach and the DVD video camera/recorder may fall.

Do not subject the DVD video camera/recorder to impact:

- This DVD video camera/recorder is a precision machine. Take great care that you do not strike it against a hard object or let it fall.
- Do not use the DVD video camera/recorder on a tripod in a place where it is subject to severe vibrations or impact.

No sand or dust!

- Fine sand or dust entering the DVD video camera/recorder or AC adapter/charger could cause malfunctions or defects.

No water or oil!

- Water or oil entering the DVD video camera/recorder or AC adapter/charger could cause electric shock, malfunctions or defects.

Heat on surface of product:

- The surface of the DVD video camera/recorder will be slightly warm, but this does not indicate a fault.

Screen on connected TV:

- Never leave the disc navigation screen, still image or camera image displayed on your TV to which the DVD video camera/recorder is connected: Doing so could result in displayed image retention or phosphor degradation of TV screen.

Be careful of ambient temperature:

- Using the DVD video camera/recorder in a place where the temperature is over 104°F (40°C) or under 32°F (0°C) will result in abnormal recording/playback.
- Take care that the temperature of this DVD video camera/recorder, when connected to PC does not rise excessively (reference for usage: approx. 30 minutes at about 86°F (30°C)).
- Do not leave the DVD video camera/recorder on beach sand or in a closed vehicle where the temperature is very high for a long time: This could cause malfunctions.

Do not point directly at the sun:

- If direct sunlight strikes the lens or viewfinder, the DVD video camera/recorder could malfunction or a fire could occur.
- Do not leave the DVD video camera/recorder with the LCD screen exposed to direct sunlight: This could cause malfunctions.

Do not use the DVD video camera/recorder near TV or radio:

- This could cause noise to appear on the TV screen or in radio broadcasts.

Do not use the DVD video camera/recorder near strong radio waves or magnetism:

- If the DVD video camera/recorder is used near strong radio waves or magnetism, such as near a radio wave tower or electric appliances, noise could enter video and audio that are being recorded. During playback of normally recorded video and audio, noise may also be present in picture and sound. At worst the DVD video camera/recorder could malfunction.

Do not expose the DVD video camera/recorder to soot or steam:

- Thick soot or steam could damage the DVD video camera/recorder case or cause malfunctions.

Do not use the DVD video camera/recorder near corrosive gas:

- If the DVD video camera/recorder is used in a place where there is dense exhaust gas generated by gasoline or diesel engines, or corrosive gas such as hydrogen sulfide, the external or internal terminals could corrode, disabling normal operation, or the battery connecting terminals could corrode, so that power will not turn on.

Do not use the DVD video camera/recorder near ultrasonic humidifier:

- With some water in humidifier, calcium and other chemicals dissolved in water could scatter in the air, and white particles could adhere to the optical head of the DVD video camera/recorder, which could cause it to operate abnormally.

Do not expose the DVD video camera/recorder to insecticide:

- Insecticide entering the DVD video camera/recorder could dirty the lens in laser pickup block, and in such a case the DVD video camera/recorder might not operate normally. Turn the DVD video camera/recorder off and cover it with vinyl sheet, etc. before using insecticide.

Do not use a generally available 8 cm CD lens cleaner:

- Cleaning the lens is not necessary when using this DVD video camera/recorder in the usual way.
- Using 8 cm CD lens cleaner could cause this DVD video camera/recorder to be faulty.

Be careful of moisture condensation:

- When you move the DVD video camera/recorder between places where the difference in temperatures is great - such as entering a lodge from a ski slope or going out of a cooled room or vehicle - condensation (vapor in air warmed or cooled to water droplets) could occur on the lens and/or inside the DVD video camera/recorder. If condensation occurs, do not open the cover of disc or card insertion block if possible. If condensation occurs on the lens, wipe it off with a soft, dry cloth. Even if the external surface of DVD video camera/recorder has dried, condensation may remain inside: Turn the DVD video camera/recorder off and leave it in a dry place for at least 1-2 hours before using it again.

Do not use the DVD video camera/recorder for a long uninterrupted period of time:

- This DVD video camera/recorder cannot be used for a long time continuously as a surveillance camera/monitor. If you use the DVD video camera/recorder for a long continuous period of time, the temperature of DVD video camera/recorder could exceed a limit and the recording/playback operation could be slowed down: In this case, turn it off and wait for a while before using it again.

Do not turn the DVD video camera/recorder off while the ACCESS/PC indicator or CARD ACCESS indicator is lit or blinking:

- The ACCESS/PC or CARD ACCESS indicator is lit or blinking to show that data is being written to disc or card, or being read from it. At this time, do not do any of the following, so as not to damage the data:
 - Remove battery
 - Disconnect AC adapter/charger
 - Plug or unplug PC connection cable
 - Remove disc or card
 - Subject DVD video camera/recorder to severe vibrations or impact.
 - Violently open or close the LCD monitor

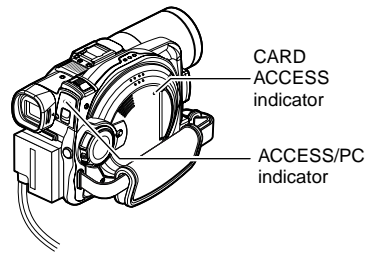

If you turn the DVD video camera/recorder off while the ACCESS/PC or CARD ACCESS indicator is lit or blinking, turn it on again with the disc or card loaded in it: Repair of the disc or card will be executed automatically (see page 165).

Do not wipe the DVD video camera/recorder case with benzene or thinner:

- The coating of case could peel off or the case surface could deteriorate.
- When using a chemical cleaning cloth, follow the instructions.

Also read the instructions attached with optional accessories:

- For optional accessories, observe the cautions and follow instruction manuals attached.

Cautions When Storing

Do not leave the DVD video camera/recorder in a place where the temperature is very high for a long period of time:

- The temperature inside a closed vehicle or trunk can become very high in a hot season. If you leave the DVD video camera/recorder in such a place, it could malfunction or the case could be damaged. Also, do not expose the DVD video camera/recorder to direct sunlight or place it near a heater.

Do not store the DVD video camera/recorder in a place where the humidity is high or in a dusty place:

- Dust entering the DVD video camera/recorder could cause malfunctions. If the humidity is high, the lens could be moldy, and the DVD video camera/recorder could become inoperable. It is recommended that you put the DVD video camera/recorder with desiccant in a box when storing it in a closet, etc.

Do not store the DVD video camera/recorder in a place subject to strong magnetism or intense vibrations:

- This could cause malfunctions.

Detach the battery from the DVD video camera/recorder and store it in a cool place:

- Leaving the battery attached or storing it at high temperature could shorten its life.

Suggestions and Restrictions

Make a trial recording:

- Always make a trial recording before doing actual recording to make sure that recording is normal. The data that have not been stored normally because of a defect in the DVD video camera/recorder cannot be restored.

It is recommended that you use DVD-RAM disc from which recorded contents can be deleted for trial recording.

Do not use the DVD video camera/recorder for professional applications:

- This DVD video camera/recorder is designed and produced for home-use recording and playback.

The recorded contents cannot be compensated for:

- Hitachi cannot compensate for any damages caused when recording is not made normally or recorded contents cannot be played back because of a defect in the DVD video camera/recorder, disc or card. Also, Hitachi cannot be responsible for your recorded video and audio.
- If you or a third party make a mistake when handling this DVD video camera/recorder, disc, card, etc., the recorded contents may be lost. We cannot be responsible for compensation for damage due to loss of recorded contents.

Copyright:

- Data recorded on the disc or card in this DVD video camera/recorder using other digital/analog media or devices are protected by the copyright act and cannot be used without permission of the owner of copyright, except for personal enjoyment. Be aware that recording is restricted for some demonstrations, performances and exhibitions, even for personal enjoyment.

Read This First

To guide you, we've included following six chapters.

- The section on “Setups” explains how to set up the DVD video camera/recorder, battery, and set the date/time.
- The section on “Basic Techniques” explains the basic operation of this DVD video camera/recorder - recording of movies, still images, external input, and playback of recorded images.
- The section on “Advanced Techniques” explains settings on this DVD video camera/recorder for more advanced usage.
- The section on “Disc Navigation” explains editing with Disc Navigation: Refer to this section when finalizing DVD-R disc and initializing DVD-RAM disc.
- The section on “Connecting to PC” explains the contents of provided CD-ROM and how to install the software included.
- “Subsidiary Information” includes an introduction to products sold separately, proper cleaning, and troubleshooting.

We want this manual to be as helpful as possible, so it includes two easy ways to find the information you need:

- A quick index for the information you use most often (this page).
- A detailed table of contents directing you to specific information quickly (see page 13-15).

Get to know your DVD video camera/recorder by using this manual, and get to know Hitachi. We appreciate your business.

Quick Index

Available Discs	25
Recording Movie	49
Playing Back	58
Connecting to a TV	77
Functions Available with Disc Navigation	109
Connecting to PC	140

With this DVD video camera/recorder you can view the picture being recorded or the playback picture whether on the LCD monitor or in the viewfinder. Opening or closing the LCD monitor switches the picture to appear on the LCD monitor or in the viewfinder. The following text describes the operation assuming that the viewfinder is used as a major monitor device.

About This Manual

● Displays in this manual

Understand that the displays are different from those you will actually see in the viewfinder or on the LCD screen.

● Notation of cancel button

Press the stop/cancel button to stop your operation midway, or return the menu screen to the preceding one. The expression “press the ■ button” will be used in this text.

● , and marks beside headings

Some functions of this DVD video camera/recorder are unavailable with disc or card used. Refer to the marks at right above each function to identify whether the disc or card is compatible with the function. Refer to these marks and identify the functions and operation to match the disc or card you use.

● Illustrations in this manual

Although the external appearances of DZ-MV550A and DZ-MV580A are different, the method of operating both models is identical.

The illustrations of DZ-MV580A are used for the explanation in this text.

Introduction

● You can start recording immediately after stopping playback (P.49, 58)

Unlike tape devices, you do not need to search for the recording start position or locate the beginning of blank portion.

You can stop playback and immediately start recording: New recording will not overwrite any previously recorded data.

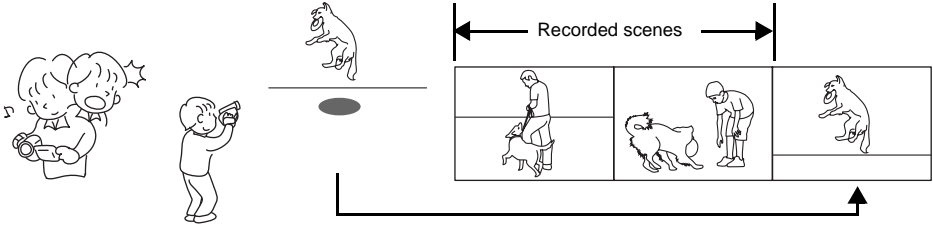

If you stop playback midway and start recording, overwrite will not occur.

● You can immediately play back desired recorded scenes (P.107)

You do not need to rewind, unlike recorders using tape.

You can select any scene you want and immediately play it back (using Disc Navigation function).

● You can easily print without PC (P.120)

Use DPOF to set the photos to be printed and the print number among the photos recorded on SD memory card or MultiMediaCard: This is useful when printing photos on a printer conforming to SD memory card or when asking a photo lab to print them.

● Use Disc Navigation to create your original movie (P.126)

You can delete unnecessary scenes, move any scenes, etc., and create your original movie work (Play List).

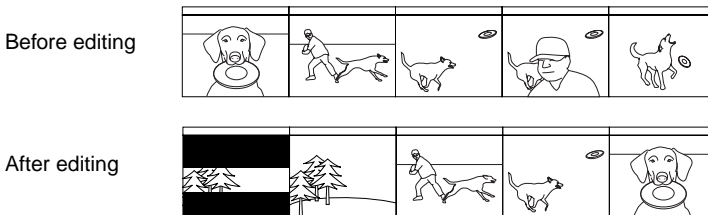

● You can easily edit scenes, which is quite difficult with tape (P.86)

Using this DVD video camera/recorder, you can collect scenes of your child, for example, on play list of Disc Navigation function and create an original movie. Then simply play back the play list and dub it on VCR. It is also easy to make any number of identical tapes.

Up to now, you had to repeatedly press buttons

With DVD, you can simply play back this DVD video camera/recorder, and press the record button on VCR.

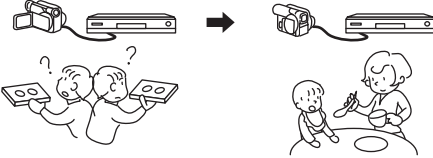

● Create original DVDs on PC (P.152)

You can use a DVD-R disc to create an original DVD, using the provided software CD-ROM. The created DVD disc can be played back on DVD player, DVD-ROM drive, etc.

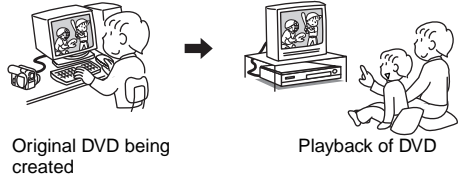

FLOW OF QUICK MODE (WITH CARD):	70
Manually Focusing Subject	71
FOCUSING DURING RECORDING	71
Adjusting Brightness of Image to be recorded (Exposure)	73
Using Full Auto Function	74
Setting Video Flash (for DZ-MV580A)	75
USING EXTERNAL MICROPHONE	76
Viewing on TV Screen	77
CONNECTING TO A TV	77
VIEWING ON TV SCREEN	78
Playback on DVD Video Recorder/Player	79
PLAYING BACK DVD-RAM DISC	79
PLAYING BACK DVD-R DISC	80
Removing and Replacing from/in Round DVD Holder	81
HOW TO REMOVE DISC	81
REPLACING DISC IN ROUND DVD HOLDER	82
WHEN THE HINGE OF ROUND DVD HOLDER COMES OFF	82
DISC CLEANING	82
Recording (Dubbing) Images	83
RECORDING (DUBBING) IMAGES FROM OTHER VIDEO DEVICE	83
RECORDING (DUBBING) IMAGES FROM OTHER VIDEO CAMERAS	85
RECORDING (DUBBING) IMAGES ON OTHER VIDEO DEVICES	86

Advanced Techniques

Checking Flow of Normal Display Mode	87
Camera Functions	
Setting Up Camera Functions	90
SELECTING SHOOTING MODE TO MATCH THE SUBJECT (SWITCHING PROGRAM AE MODE)	90
ADJUSTING COLOR (WHITE BALANCE)	91
USING THE ELECTRONIC IMAGE STABILIZER (EiS)	93
REDUCING WIND NOISE DURING RECORDING (MIC.FILTER)	93
SETTING TO WIDE TV SCREEN MODE (16:9 MODE)	94
Setting Up Record Functions	96
SWITCHING MOVIE QUALITY (VIDEO MODE)	96
SWITCHING QUALITY OF STILL IMAGE (QUALITY)	97
RECEIVING IMAGE FROM ANOTHER DEVICE (INPUT SOURCE)	98
SWITCHING EXTERNAL INPUT RECORDING METHOD (PHOTO INPUT)	98
SELF-TIMER	99
SETTING ON-SCREEN DISPLAY OUTPUT ON OR OFF (OSD OUTPUT)	100
LCD Setup	101
SETTING BRIGHTNESS OF LCD SCREEN (BRIGHTNESS)	101

SETTING COLOR DENSITY OF LCD SCREEN (COLOR LEVEL)	101
Initial Settings	102
SWITCHING OPERATING SOUND ON OR OFF (BEEP)	102
TURNING DVD VIDEO CAMERA/RECORDER OFF AUTOMATICALLY (POWER SAVE)	102
TURNING RECORD LED ON OR OFF (RECORD LED)	103
CHANGING DISPLAY LANGUAGE (LANGUAGE)	103
RESETTING MENU SETTINGS TO DEFAULTS (RESET)	104

Disc Navigation

Using Disc Navigation	105
STARTING OR TERMINATING DISC NAVIGATION	105
PLAYING BACK FROM DISC NAVIGATION SCREEN	107
SELECTING MULTIPLE SCENES	108
SELECTING CONSECUTIVE SCENES TOGETHER	108
FUNCTIONS AVAILABLE WITH DISC NAVIGATION	109
UNDERSTANDING FLOW OF DISC NAVIGATION MENU	110
Scene	111
DELETING SCENES (DELETE)	111
CHANGING IMAGES FOR THUMBNAILS (EDIT - THUMBNAIL)	113
PLAYING BACK BY SKIPPING SCENES (EDIT - SKIP)	114
ARRANGING ORDER OF SCENES (EDIT - MOVE)	114
DIRECTING SCENES EFFECTIVELY (EDIT - FADE)	115
COMBINING MULTIPLE SCENES (EDIT - COMBINE)	116
DIVIDING MOVIES (EDIT - DIVIDE)	117
COPYING STILLS ON DVD-RAM DISC TO CARD (COPY)	118
LOCKING SCENES ON CARD (LOCK)	119
DESIGNATING SCENES TO BE PRINTED (DPOF)	120
SELECTING SCENES USING MENU SCREEN (SELECT)	121
DISPLAYING INFORMATION USING MENU SCREEN (DETAIL)	122
Program	123
WHAT IS "PROGRAM"?	123
SWITCHING TO THUMBNAIL DISPLAY OF SPECIFIC DATE (SWITCH)	123
PLAYING BACK PROGRAM (PLAY)	124
CHANGING TITLE OF PROGRAM (TITLE)	124
Play List	126
WHAT IS "PLAY LIST"?	126
CREATING NEW PLAY LIST (CREATE)	126
SWITCHING TO DISPLAY OF EACH PLAY LIST (SWITCH)	127
PLAYING BACK A PLAY LIST (PLAY)	127

ADDING SCENES TO PLAY LIST (EDITING PLAY LIST)	128
DELETING SCENES FROM PLAY LIST (EDITING PLAY LIST)	129
ADDING SCENES USING SUBMENU FOR EDITING (EDITING PLAY LIST)	129
DELETING SCENES USING SUBMENU FOR EDITING (EDITING PLAY LIST)	130
SELECTING SCENES USING SUBMENU FOR EDITING (EDITING PLAY LIST)	130
ARRANGING ORDER OF SCENES (MOVE) ...	131
CHANGING TITLE OF PLAY LIST (TITLE)	132
DELETING PLAY LIST (DELETE)	132
Go To	133
TOP (END)	133
Disc or Card Management	134
VERIFYING REMAINING FREE SPACE ON DISC OR CARD (CAPACITY)	134
PROTECTING DISC FROM WRITING (PROTECT DISC)	134
INITIALIZING DVD-RAM DISC OR CARD (FORMAT DISC. FORMAT CARD)	135
UPDATING CONTROL INFORMATION OF DVD-RAM DISC (UPDATE CONTROL INFO.)	136
FINALIZING DVD-R DISC (FINALIZE DISC) ...	137
Others	138
DISPLAYING MOVIES OR STILLS INDEPENDENTLY (CATEGORY)	138
PLAYING BACK SCENES REPEATEDLY (REPEAT PLAY)	138
SLIDE SHOW (CONTINUOUS PLAYBACK OF STILLS)	139

Connecting to PC





THE FOLLOWING ARE AVAILABLE WHEN CONNECTING TO PC	140
Contents on Provided CD-ROM	142
Installing Software	144
DISPLAYING INSTALLER SCREEN	144
INSTALLING USB DRIVER	145
INSTALLING UDF DRIVER (DVD-RAM DRIVER)	146
INSTALLING DVD-MovieAlbumSE	148
INSTALLING MyDVD	150
Creating DVD Video on PC from DVD-RAM Disc Recorded on DVD Video Camera/ Recorder	152
Uninstalling Software	154
UNINSTALLING USB DRIVER	154
DELETING OTHER APPLICATIONS	155
Cautions When Using DVD Video Camera/ Recorder by Connecting It to PC	156

Subsidiary Information

Introduction to Optional Accessories	157
CAMERA ACCESSORIES	157
POWER SUPPLY	157
INFORMATION ON SQUARE ADAPTER	157
Cleaning	158
Changing Setting of Demonstration	159
Terminology	160
No DVD Video Camera/Recorder Operation - Check the Following:	163
Trouble Messages	165
Troubleshooting	172
System Reset	181
Major Specifications	182
To Order in the United States	184
To Order in the Canada	184
Index	185
Be sure to read the following before opening the package of CD-ROM	187

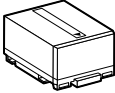
Checking Provided Accessories

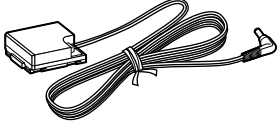
Make sure that you have all the following accessories in package:

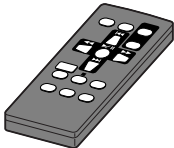
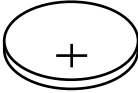
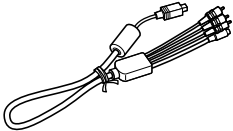
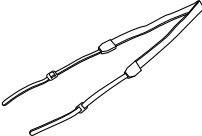
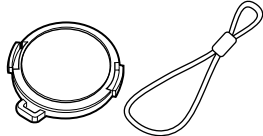
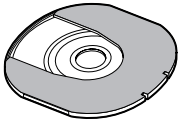
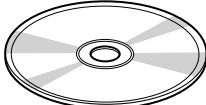
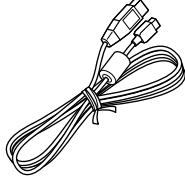
<p>Battery (model DZ-BP14S): Portable power supply for this DVD video camera/recorder. Charge it before use.</p> 	<p>AC adapter/charger (model DZ-ACS1): Used to power the DVD video camera/recorder from AC outlet, or charge battery.</p> 	<p>DC power cord: When powering the DVD video camera/recorder from household AC outlet, use this cord to connect the DVD video camera/recorder and AC adapter/charger.</p> 
<p>Power cable: Connect between household AC outlet and AC adapter/charger.</p> 	<p>Infrared remote control (model DZ-RM3W): Use to control the DVD video camera/recorder from a distance.</p> 	<p>Lithium battery (model CR2025): To power the remote control.</p> <p>WARNING: Keep this battery away from children. If swallowed, consult a physician immediately for emergency treatment.</p> 
<p>AV/S input/output cable: Used when viewing the picture played back on the DVD video camera/recorder on TV screen, or input or output video from/to another video device.</p> 	<p>Shoulder strap: Attach to the DVD video camera/recorder to hang it from shoulder.</p> 	<p>Lens cap and lens cap string: Attach the lens cap when not recording, to protect the lens.</p> 
<p>Single-sided 8 cm DVD-RAM disc (in Round DVD Holder): To record videos (movies) and photos (stills) on this DVD video camera/recorder.</p> 	<p>Software CD-ROM: Use this CD-ROM when connecting the DVD video camera/recorder to PC.</p> 	<p>PC connection cable: Use this cable when connecting the DVD video camera/recorder to PC.</p> 

Note:

The provided single-sided DVD-RAM disc is not generally available in shops: When purchasing a disc, order a 60-minute double-sided disc (2.8GB, in Round DVD Holder).

ex. Maxell DVD-RAM Camcorder Disc 2.8GB Round Holder Type (item #567620)

Names of Parts

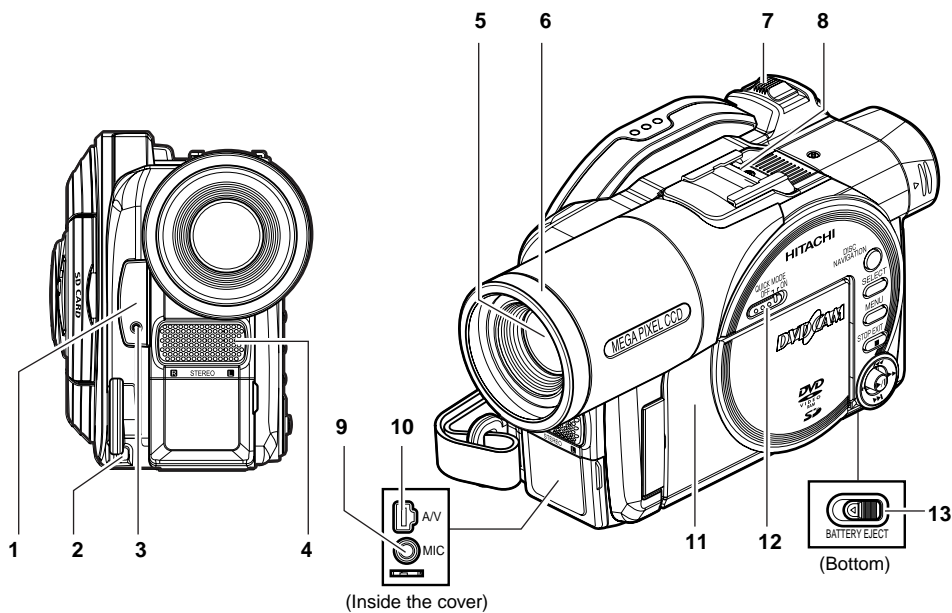

1 Infrared receiver (P. 34)

When the remote control is used to operate the DVD video camera/recorder, this receiver will receive the infrared signal.

2 Lens cap string attachment hole (P. 32)

3 Recording indicator (P. 103)

The red indicator will light during recording.

4 Stereo microphone (P. 76)

**5 Optical 18x zoom lens (DZ-MV550A)
Optical 10x zoom lens (DZ-MV580A)
(P. 56)**

6 Lens hood (P. 57)

Always remove this lens hood when using generally available tele-conversion or wide-conversion lens.

7 Zoom lever (P. 56)

Push the lever to the T side for telephoto, or to the W side for wide-angle.

8 Accessory shoe

Only for DZ-MV580A:

The optional video flash, etc. can be attached here. (See the instruction manual of device to be attached for details.)

9 External microphone jack (P. 76)

10 AV input/output jack (P. 77, 83)

**11 2.5" type liquid crystal display (inside)
(P. 35)**

12 QUICK MODE switch (P. 63)

To switch the menu display on screen between Advanced mode and Quick mode.

13 BATTERY EJECT switch (P. 40)

The BATTERY EJECT switch is located on the bottom of this DVD video camera/recorder: Slide it when removing the battery.

Although the external appearances of DZ-MV550A and DZ-MV580A are different, the method of operating both models is identical. DZ-MV580A illustrations are used in this manual.

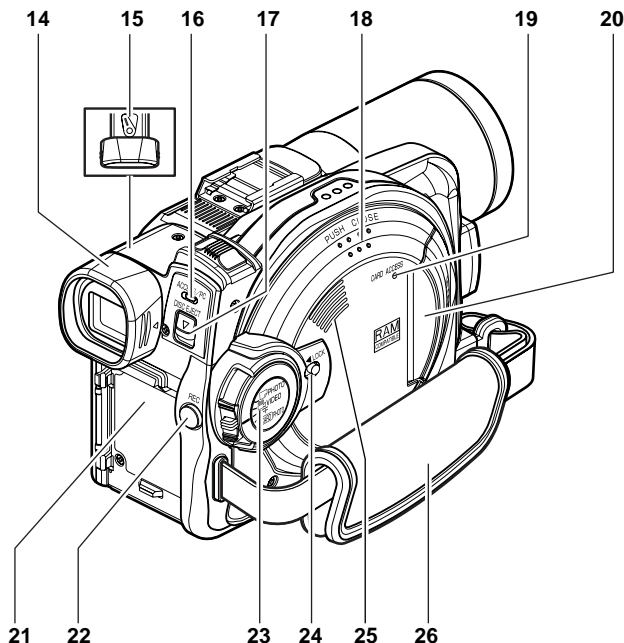

14 Viewfinder (P. 34)

15 Diopter control (P. 34)

To adjust the focus of image appearing in the viewfinder. (Pull out the viewfinder.)

16 ACCESS/PC indicator (P. 8, 49, 50)

Will blink or light when the disc in DVD video camera/recorder is accessed (write or read is executed) or the DVD video camera/recorder is connected to PC.

17 DISC EJECT button (P. 44)

Press down and release this button to open the disc guide.

18 Disc insertion block (P. 44)

19 CARD ACCESS indicator (P. 8, 50)

20 Card insertion block (P. 47)

21 Battery attachment platform (P. 40)

22 Record button (REC) (P. 49)

23 Power switch (P. 48, 49, 50)

24 LOCK switch (P. 50)

It is recommended that you set the LOCK switch to  (to the left) to prevent the power switch in the "VIDEO" position from accidentally moving to "PHOTO".

25 Speaker (P. 58)

26 Hand strap (P. 31)

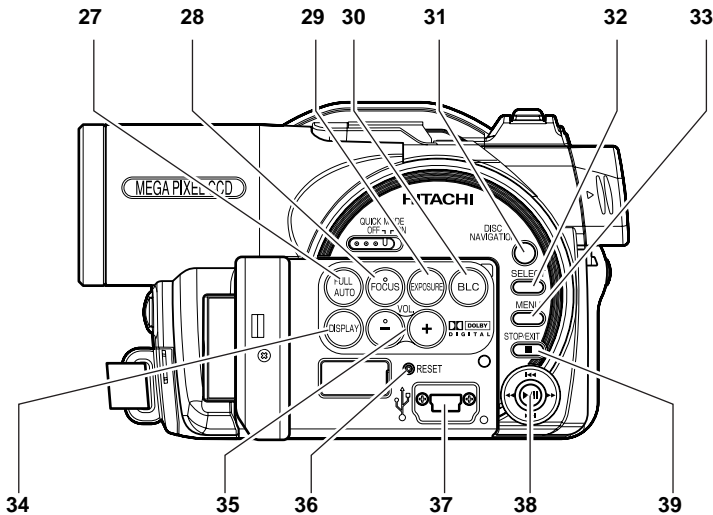

27 FULL AUTO button (P. 74)

To switch the DVD video camera/recorder to full automatic.

28 FOCUS button (P. 71)

To switch between manual focus and auto-focus.

29 EXPOSURE button (P. 73)

Press this button to adjust the exposure.

30 B.L.C. (backlight compensation) button (P. 51)

Press this button when subject is being lighted from rear.

31 DISC NAVIGATION button (P. 105)

32 SELECT button (P. 108)

33 MENU button (P. 37, 88, 111)

Press this button to display the menu for setting camera functions and Disc Navigation.

34 DISPLAY (Screen display) button (P. 62)

Press this button to display the details of image being played back or camera setting status, or switch the display off.

35 Volume control buttons (VOL)/⊖ ⊕ buttons (P. 58, 71, 73)

To adjust the volume of sound from speaker, etc.

36 RESET button (P. 181)

To reset all settings to defaults (status when the DVD video camera/recorder was shipped from the factory)

37 PC connection terminal (TO PC)

38 Joystick (P. 37, 58, 87, 89)



Move the joystick to select a scene or menu item, and then press the center (▶/||) to play back the scene, pause it, or designate an option of the menu.

39 Stop/cancel button (P. 10, 58, 105)

To end playback or cancel setting of menu.

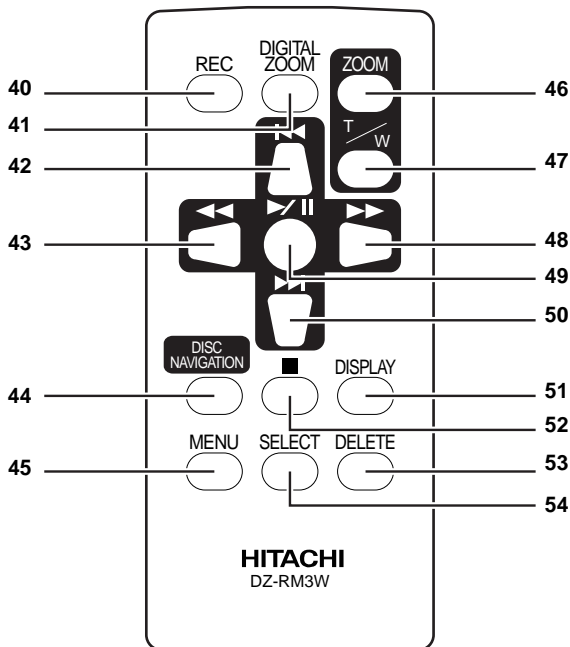

40 REC button (P. 49, 50)

41 DIGITAL ZOOM button (P. 56)

42 Reverse skip button (P. 60)

43 Reverse search button (P. 59)

44 DISC NAVIGATION button (P. 105)

45 MENU button (P. 37, 90, 112)

46 ZOOM T button (P. 56)

47 ZOOM W button (P. 56)

48 Forward search button (P. 59)

49 Play/pause button (P. 58)

50 Forward skip button (P. 60)

51 DISPLAY button (P. 62)

52 Stop button (P. 10, 58, 107)

53 DELETE button (P. 111)

54 SELECT button (P. 108)

* The buttons on remote control will function the same as those on DVD video camera/recorder.

Try to Record and Play Back using Disc (Video and Photo)

Before You Begin

- It is recommended that you use a DVD-RAM disc for trial recording, since you can delete the recorded contents (P. 25).

You can record both videos and photos on DVD-RAM disc; only videos on DVD-R disc.

1 Connect a power supply (P. 43).

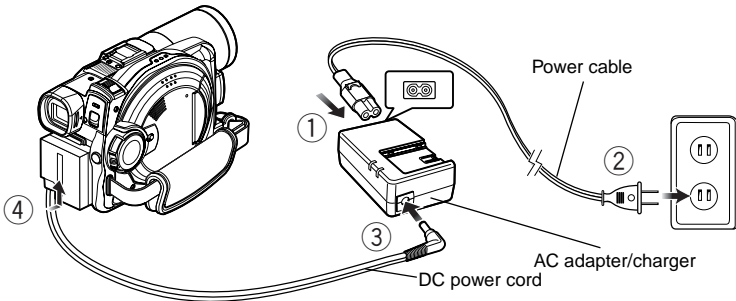

2 Insert a disc (P. 44).

① Press down the DISC EJECT button once and release it.

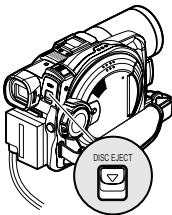

② Gently open the cover until it stops.

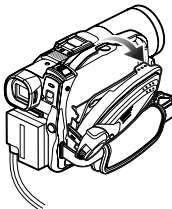

③ Insert the disc, in Round DVD Holder, into the disc guide properly until it stops, and then close the cover of disc insertion block.

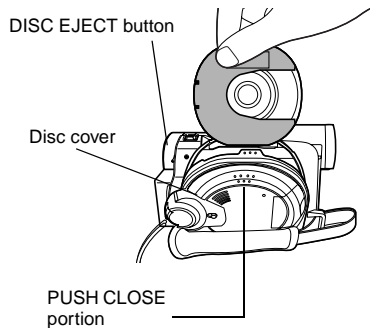

3 Start recording (P. 49).

① Open the LCD monitor (P. 35).

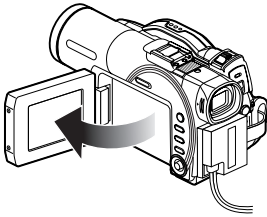

② While holding the gray switch at the center of power switch, set the switch to "VIDEO" or "PHOTO". ("VIDEO" only for DVD-R disc)

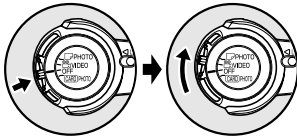

③ Press the REC button.

Recording will start.
Pressing the REC button again will stop recording (VIDEO).
Pressing REC will enable you to record one photo (PHOTO).

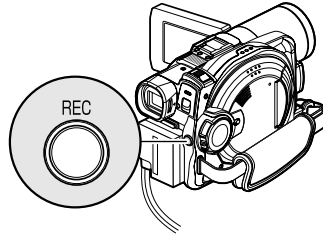

Note:

- When using an unformatted disc, format (initialize) it on this DVD video camera/recorder. If unformatted disc is inserted into this DVD video camera/recorder, a message will appear: Format the disc following the instructions on screen (P. 45, 135). Initializing the DVD-RAM disc will erase all the recorded contents: Make sure the contents on disc are not valuable before initializing the disc.
- See Check 1 on P. 163 if recording is not possible with "VIDEO".
- See Check 2 on P. 163 if recording is not possible with "PHOTO".

4 View the playback of recorded content on LCD monitor screen (P. 35).

① After recording is finished, press the ►/|| button.

The recorded scene will be played back.

② Press the ■ button to stop playback.

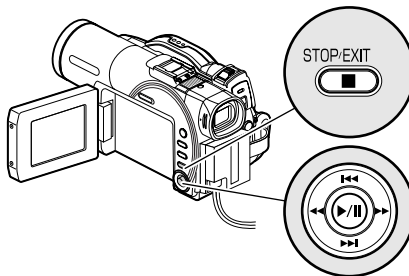

Try to Record and Play Back using Card (Photo)

Only photos can be recorded on card.

1 Connect a power supply (P. 43).

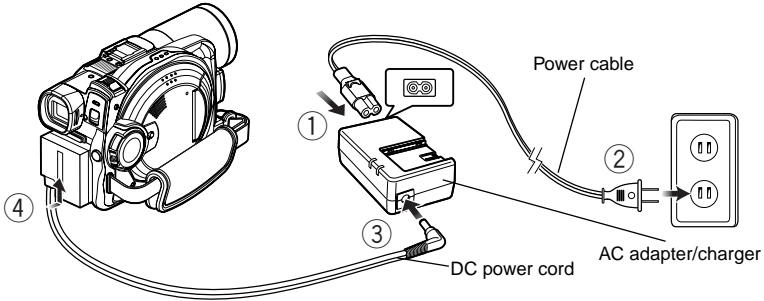

2 Insert a card (P. 47).

① Open the cover of card insertion block with power turned off.

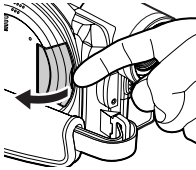

② Put in a card.

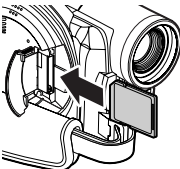

③ Insert the card all the way until it locks, and then close the cover of card insertion block.

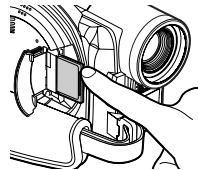

3 Start recording (P. 50).

① Open the LCD monitor (P. 35).

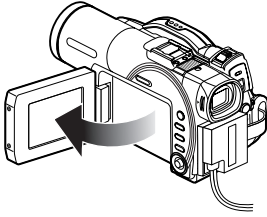

③ Press the REC button.

Pressing REC once will record one photo.

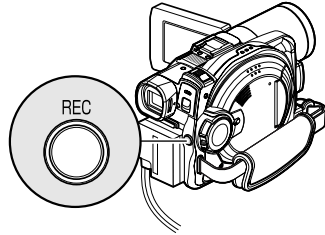

② While holding the gray switch at the center of power switch, set the switch to "CARD PHOTO".

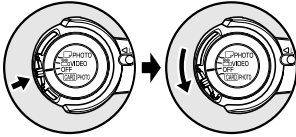

Note:

See Check 2 on P. 163 if recording is not possible with "CARD PHOTO".

4 View the playback of recorded content on LCD monitor screen (P. 35).

① Press the ►/|| button in recording pause status: The recorded scene will be played back.

② Press the ■ button to stop playback.

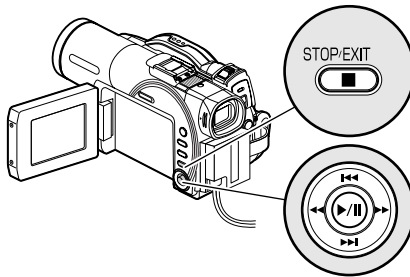

Discs and Cards

The following table lists the storage media (discs and cards) that can be used on this DVD video camera/recorder and the functions which are available with them:

Function	Media		
	DVD-RAM disc	DVD-R disc	SD memory card/ MultiMediaCard
Recording movie	∴	∴	×
Recording still	∴	×	∴
Deleting recorded image	∴	×	∴
Editing on this DVD video camera/recorder	∴	×	∴
Playback on DVD player	× ^{*1}	∴ ^{*2}	×
Playback on DVD video recorder	∴ ^{*3}	∴ ^{*2}	× ^{*4}

∴: Functions available; ×: Not available

*1: Can be played back on DVD players with the  mark.



*2: Must be finalized (see "Terminology", P. 160) on this DVD video camera/recorder before DVD-R disc can be played back on DVD player or DVD video recorder (see page 137). May not be playable on some DVD players or DVD video recorders.

*3: Cannot be played back on a DVD video recorder that does not conform to 8 cm DVD-RAM disc.

*4: There are DVD video recorders that are compatible with SD memory card or MultiMediaCard.

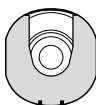
AVAILABLE DISCS



Usable discs and logos		Shape
DVD-RAM Ver. 2.1 (8 cm)		In Round DVD Holder
DVD-R [for General Ver. 2.0 (8 cm)]		

This DVD video camera/recorder uses 8 cm DVD-RAM discs and 8 cm DVD-R discs for camcorder use.

Discs removed from Round DVD Holder cannot be used on this DVD video camera/recorder: Use them only in the holder. Do not insert a bare disc removed from the holder into the DVD video camera/recorder: It will not be removable.

- The Round DVD Holder cannot be used on the following DVD video camera/recorders:
 - DZ-MV100A
 - DZ-MV230A/200A
 - DZ-MV270A
- Other DVD video camera/recorders that use square type adapters.
- See page 26 for information on DVD-R disc.

Note:

- It is recommended that you use Hitachi Maxell discs, since their compatibility with this DVD video camera/recorder has been confirmed. Using a disc other than those made by Hitachi Maxell may not allow the DVD video camera/recorder to deliver optimum performance.

INFORMATION ON DVD-R DISC

You cannot record a still on DVD-R disc, or delete any recorded images or data.

For optimum recording on DVD-R disc, this DVD video camera/recorder writes control data to the disc in order to automatically make adjustments when it is inserted and ejected accompanying recording. If the disc has no area to be written for adjustment, recording may not be possible. To prevent this, do not insert or eject a DVD-R disc accompanying recording more than 100 times.

● Finalizing DVD-R disc

Before using the 8 cm DVD-R disc provided on this DVD video camera/recorder on a DVD player or DVD video recorder that is compatible with 8 cm DVD-R disc, the disc must be finalized on this DVD video camera/recorder. For the finalizing procedure of 8 cm DVD-R disc, refer to “Finalizing DVD-R Disc (finalize disc)” (P. 137).

Note:

- When using an unformatted DVD-R disc, it is necessary to format it on this DVD video camera/recorder (see page 45).
- Do not insert a DVD-R disc recorded on this DVD video camera/recorder but not finalized, into a recordable device, such as a DVD video recorder: The recorded data may be damaged.
- DVD-R discs edited and finalized on PC or those finalized on another DVD video recorder may not be playable on this DVD video camera/recorder, depending on the editing software used or recorded status of DVD-R disc.

EXAMPLES OF DISCS THAT CANNOT BE USED ON THIS DVD VIDEO CAMERA/RECORDER:

- | | | |
|---|-------------|--|
| • DVD-RAM (2.6 GB) Ver. 1.0 | • DVD-ROM | • MO |
| • DVD-R (3.9 GB) Ver. 1.0 | • DVD-Video | • MD |
| • DVD-R (4.7 GB) for Authoring Ver. 2.0 | • CD-R | • iD |
| • DVD-RW | • CD-RW | • Floppy disk |
| • DVD+RW | • CD | • Discs other than those with diameter of 8 cm |
| • DVD+R | • LD | • CD-ROM |

Note:

Discs recorded on PC or DVD video recorder may not be playable on this DVD video camera/recorder: If so, message “This disc cannot be used.” will appear. Also, blue thumbnails will appear (Fig. 1* on page 27), or normal playback will not be possible.

HANDLING DISCS

● Using discs

DVD-RAM and DVD-R discs are very delicate recording media. Carefully read the following cautions and observe them:

- When using disc on this DVD video camera/recorder, **be sure to keep it in Round DVD Holder.**

- Always use a brand new disc when recording important material.

- Be sure not to touch the disc exposed portion, and be careful that no dirt adheres to it.

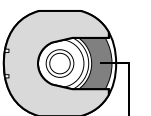

Do not touch

- **If there is dust, scratch, dirt on disc or if it is warped,** the following phenomena may occur:

- Block noise in playback image
- Momentary stop of playback image
- Sound interrupted during playback, or abnormal sound



Block noise

- Blue thumbnail display* (Fig.1)
- Disc cannot correctly be recognized
- Disc cannot be initialized
- Delay between video and audio

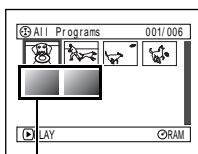
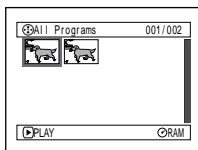

Fig. 1

Even if disc is normal, the above phenomena may occasionally occur. While the ACCESS/PC indicator is lit, do not subject disc to vibrations or impact, and avoid using DVD video camera/recorder at extremely high or low temperatures, or in environment where condensation is likely to occur.

- When recording images, the DVD video camera/recorder may avoid the portions of disc where recording is not possible, due to dust, scratches, etc.

[It will pause ●|| at such a portion and automatically restart recording (●REC).]



(Recording one scene may produce multiple thumbnails.)

This will cause recording to be interrupted for several seconds to several minutes, and multiple thumbnails will be created by one recording session as shown above. In this case, the recordable time on disc will decrease.

- Be careful when removing the disc since the metal of removal slot of DVD video camera/recorder, and disc itself, may be hot.

● Storing discs

- When storing disc, insert it in Round DVD Holder into plastic case.
- Be careful that no condensation occurs on disc.
- Do not place disc in following places:
 - **Direct sunlight for a long time**
 - **Where humidity is high or in dusty place**
 - **While there is heat from a heater, etc.**

Note:

- See page 82 when cleaning the removed disc.
- See page 81 for how to handle disc removed from Round DVD Holder.
- See page 81 for how to set the disc removed from Round DVD Holder or another disc correctly in Round DVD Holder.

AVAILABLE CARDS

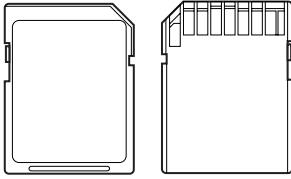

SD memory card and MultiMediaCard can be used on this DVD video camera/recorder.

● Handling card

- Do not use cards other than the designated ones.
- Be sure to use a brand new Card when recording vital images.
- Do not touch the card terminal or allow it to touch metal.
- Do not paste anything other than exclusive label on label pasting portion.
- Do not subject card to impact, bend or drop it.
- Do not disassemble card or modify it.
- Do not expose card to water.
- Do not use or store card in the following places:
 - Where the temperature is high, such as in vehicle at high temperatures, under burning sun or near a heater.
 - Where humidity is high, or in dusty place
- When the erasure prevention switch on SD memory card is locked, no recording, deletion or editing will be possible on the card.

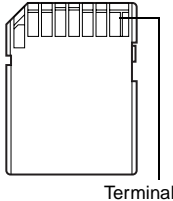

Terminal

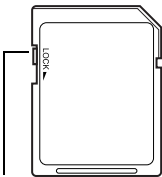

Erasure prevention switch

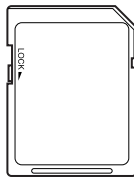

Locked status

● Common cautions for disc and card

- It is recommended that you create a backup file for valuable data on hard disk of PC.
- Do not do the following, or the data on card may be damaged or lost:
 - Do not remove the card or turn DVD video camera/recorder off during reading or writing of data
 - Do not use DVD video camera/recorder in a place subject to static electricity or electrical noise

Note:

- This DVD video camera/recorder can play back image data recorded on other digital cameras conforming to the DCF (Design rule for Camera File system) standard. The range of image data playable on this DVD video camera/recorder is that with pixels from 80 horizontal x 60 vertical to 4000 horizontal x 3000 vertical.
- DCF is an integrated image file format of digital cameras: Image files can be used on all digital devices conforming to DCF.
- Image data edited on PC and certain types of image data may not be visible on this DVD video camera/recorder.
- The image data recorded on another device may not be playable on this DVD video camera/recorder.

Storage Capacity on Disc or Card

RECORDABLE TIME OF MOVIE (VIDEO)

The recordable time will vary depending on the video recording quality: See page 96 for the setting of video recording quality.

Movie recordable time on one disc (on single side) (when recording only movies)

Recording quality	Disc used		Application
	DVD-RAM	DVD-R	
XTRA	Approx. 18 min ^{*1}	No recording possible	Very high quality
FINE	Approx. 30 min ^{*2}	Approx. 30 min ^{*2}	High quality
STD	Approx. 60 min ^{*3}	Approx. 60 min ^{*3}	Standard quality
LPCM ^{*4}	No recording possible	Approx. 30 min	Audio quality prioritized

^{*1}: Variable bit recording (recording of more than 18 minutes may be possible because the transfer rate varies automatically between approx. 3-10 Mbps)

^{*2}: Fixed bit rate: Approx. 6 Mbps

^{*3}: Fixed bit rate: Approx. 3 Mbps

^{*4}: Linear PCM recording (see "Terminology", P. 160) (If your DVD player does not conform to MPEG audio player 2, record in LPCM mode)

Note:

- Audio in XTRA, FINE or STD mode is recorded in the MPEG audio layer 2 format, which is the option standard of DVD video standard.
- No movie can be recorded on SD memory card or MultiMediaCard.
- Although the movie quality mode can be changed midway for recordings on DVD-RAM disc, it cannot be changed on DVD-R disc once the mode has been decided.
- If you record in XTRA mode at high temperatures, the DVD video camera/recorder will get hot and the maximum transfer rate will be limited to approx. 6 Mbps.
- If a disc recorded is used at high temperatures, normal playback may be impossible: Turn the DVD video camera/recorder off once, wait until the ambient temperature becomes lower, and then operate it again.

RECORDABLE STILLS (PHOTOS) ON DISC

● Number of recordable stills on one side of disc: Up to 999

If the disc still has free space after recording 999 stills on it, movies can also be recorded on it.

RECORDABLE STILLS (PHOTOS) ON CARD

The number of recordable stills will vary depending on the recording quality: See page 97 for the setting of recording quality.

For DZ-MV550A

Capacity	Recording quality		
	FINE	NORM	ECO
8 MB	Approx. 45	Approx. 95	Approx. 190
16 MB	Approx. 100	Approx. 200	Approx. 400
32 MB	Approx. 220	Approx. 440	Approx. 880
64 MB	Approx. 440	Approx. 880	Approx. 1,760
128MB	Approx. 880	Approx. 1,760	Approx. 3,520
256 MB	Approx. 1,760	Approx. 3,520	Approx. 7,040
512 MB	Approx. 3,520	Approx. 7,040	Approx. 14,080

For DZ-MV580A

Capacity	Recording quality		
	FINE	NORM	ECO
8 MB	Approx. 8	Approx. 14	Approx. 20
16 MB	Approx. 22	Approx. 35	Approx. 50
32 MB	Approx. 50	Approx. 80	Approx. 110
64 MB	Approx. 100	Approx. 160	Approx. 220
128MB	Approx. 200	Approx. 320	Approx. 440
256 MB	Approx. 400	Approx. 640	Approx. 880
512 MB	Approx. 800	Approx. 1,280	Approx. 1,760

(The numbers of recordable stills above are only for reference)

Note:

- Cards used on other devices can be used on this DVD video camera/recorder.
- No movie or music data recorded on card can be checked, viewed or heard on this DVD video camera/recorder. In addition, no such a data file can be displayed on this DVD video camera/recorder.
- Use the remaining display function to check the remaining free space on disc before use. See "Verifying Remaining Free Space on Disc or Card (Capacity)" on page 134.
- Some still data recorded on this DVD video camera/recorder may not be playable on another device.

SIZE AND QUALITY OF PHOTOS

The pixel size of stills (JPEG) that can be recorded on this DVD video camera/recorder is as follows:

Model	Setting	
	Camera input	External input
DZ-MV550A	640 × 480 pixels	640 × 480 pixels
DZ-MV580A	1,280 × 960 pixels	640 × 480 pixels

The following table shows the file size and quality of one still (JPEG) recorded on card:

Quality	File size		Application
	DZ-MV550A	DZ-MV580A	
FINE	Approx. 128 KB	Approx. 512 KB	When image quality is prioritized
NORM	Approx. 64 KB	Approx. 384 KB	Standard quality
ECO	Approx. 32 KB	Approx. 256 KB	When number of stills is prioritized (quality will be slightly inferior)

Although still images are recorded on DVD-RAM disc only in the FINE mode, the quality mode can be chosen when recording stills on card. (P. 97) The file size of a photo recorded on DVD-RAM disc in "[PHOTO]" status is equal to or larger than that recorded on card using the FINE quality in "[CARD] PHOTO".

* JPEG: Joint Photographic Experts Group.

JPEG is one of the photo image compression standards. It is widely used in digital still cameras since JPEG files can be used on ordinary PC. When this DVD video camera/recorder records on DVD-RAM disc in "[PHOTO]" status, a JPEG photo will be recorded, along with a photo that conforms to the DVD video recording (DVD-VR) format which is used to be output to TV (see "Terminology", P. 160). Only JPEG photos will be recorded on SD memory card.

Note:

- No still can be recorded on DVD-R disc.
- Since the file size is restricted in all quality modes when recording photos on card ([CARD] PHOTO), the quality of photos on card may be inferior to those recorded on DVD-RAM disc ([PHOTO]).

Setups

This section explains preparations for recording - setting up the DVD video camera/recorder and battery.

Setting Up the DVD Video Camera/Recorder

HOLDING DVD VIDEO CAMERA/RECORDER

Insert your right hand from the bottom of DVD video camera/recorder up to the base of your thumb.

Put your hand in a position where you can easily operate the REC button and the Zoom lever.

Adjust the length of hand strap so that the DVD video camera/recorder is stable when you press the REC button with your thumb.

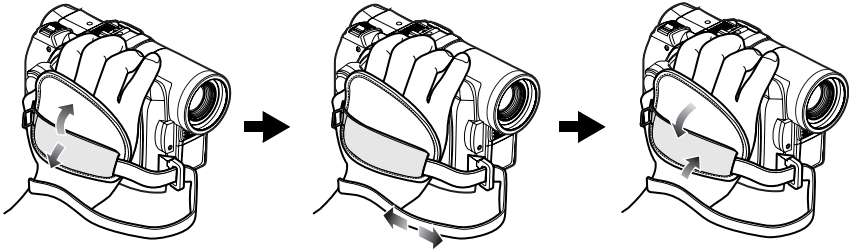

Note:

Do not adjust the hand strap while holding the DVD video camera/recorder: Doing this could cause the DVD video camera/recorder to fall and be damaged.

Caution:

Do not lift the DVD video camera/recorder by holding the viewfinder or LCD monitor: If the viewfinder or LCD monitor comes off, the DVD video camera/recorder will fall.

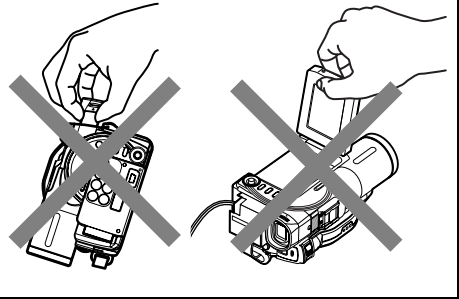

ATTACHING SHOULDER STRAP

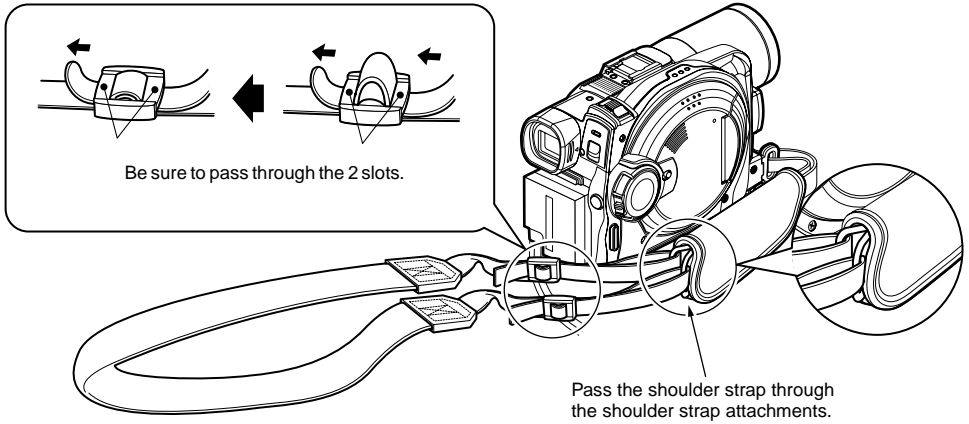

ATTACHING LENS CAP

- 1 Attach the shorter end of lens cap string to the lens cap.
- 2 Attach the longer end of lens cap string to the attachment hole of DVD video camera/recorder.
- 3 Push the both sides of cap inward and attach it over the lens.

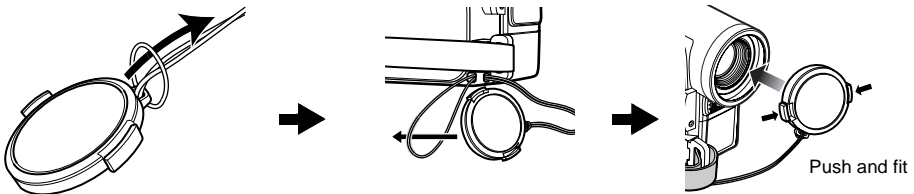
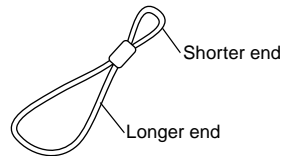

Note:

- Always keep the lens cap on when not using the DVD video camera/recorder, to protect the lens.
- When recording, attach the lens cap to the hand strap by hooking the tab inside the cap onto strap for comfortable shooting.

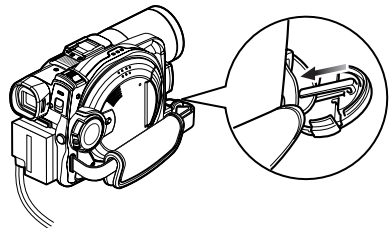

INSERTING BATTERY INTO REMOTE CONTROL

Insert the provided lithium battery into remote control.

1 Slide the cover to remove it.

2 Insert the lithium battery with the positive ⊕ terminal facing up.

3 Slide the cover to close it.

Note:

The life of lithium battery is approximately one year. If the battery is discharged, no operation is possible with remote control: Replace the battery.

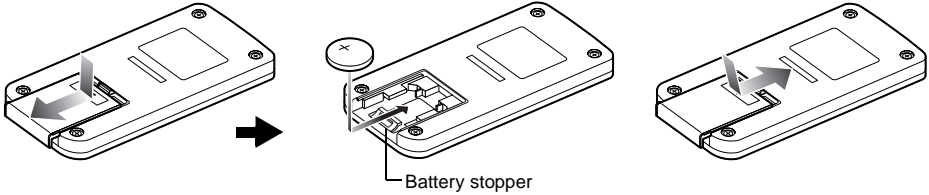

REMOVING BATTERY FROM REMOTE CONTROL

1 While pushing the battery stopper, slide the battery out.

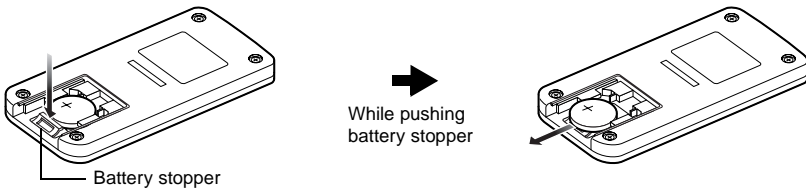

Warning:

- KEEP THE BATTERY AWAY FROM CHILDREN AND PETS.
- IF SWALLOWED CONSULT A PHYSICIAN IMMEDIATELY FOR EMERGENCY TREATMENT.
- BATTERY MAY EXPLODE IF NOT HANDLED PROPERLY. DO NOT RECHARGE, DISASSEMBLE OR DISPOSE OF IN FIRE.

Note:

- Replace the battery with a Hitachi Maxell, Sony, Panasonic, Sanyo, Toshiba CR2025, or Duracell DL2025. Use of another battery may present a risk of fire or explosion.
- Dispose of battery safely in accordance with local laws. Do not dispose of in fire.
- Do not short circuit the battery.
- Do not hold the battery with the metallic tweezers.
- Keep the battery in a dark, cool, dry place.

● Using Remote Control

Point the remote control to the infrared receiver on the DVD video camera/recorder. The remote controllable distance is up to 16 feet (5 m).

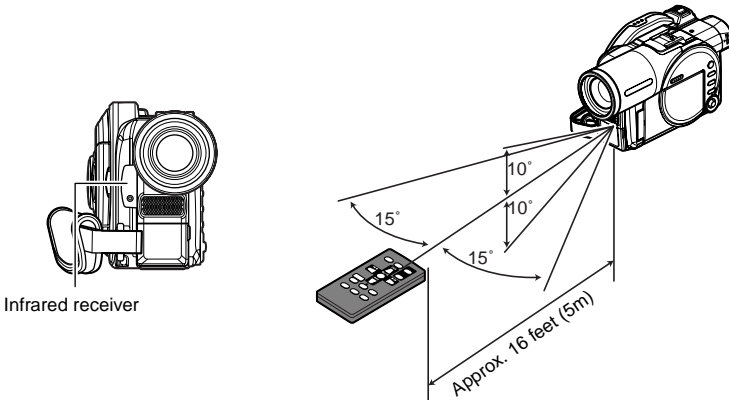

Note:

- When using the remote control, make sure that the infrared receiver on DVD video camera/recorder is not exposed to direct sunlight or any intense light. If the infrared receiver is subject to light stronger than the infrared light from remote control, the DVD video camera/recorder cannot be operated by remote control.
- If there is an obstacle between the remote control and infrared receiver on DVD video camera/recorder, remote control may not be possible.
- The DVD video camera/recorder uses the "VCR2" remote control code of Hitachi VCRs. If you use a Hitachi VCR, etc. with remote control code set to "VCR2", a VCR placed near the DVD video camera/recorder will also be operated by the remote control. To prevent this, change the remote control code of the VCR.

VIEWING SUBJECT THROUGH VIEWFINDER

- 1 Pull out the viewfinder.
- 2 Turn the diopter control knob to adjust the focus to suit your eyesight.

Note:

- If no image appears in viewfinder, refer to "Check 6" on page 164.
- If the LCD monitor is open approximately 90°, the viewfinder will be off.
- Focusing will not be correct unless the viewfinder is pulled out.

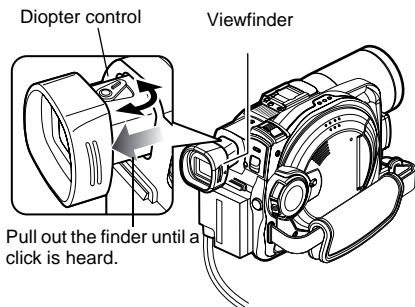

VIEWING IMAGE ON LCD MONITOR SCREEN

If you open the LCD monitor, you can monitor subject image on the LCD screen.

1 Open the LCD monitor.

The LCD monitor has a portion where you can hook your finger. Hook the finger there to open the monitor.

● Range where the LCD monitor can be moved

The LCD monitor can be opened up to approximately 90°.

If the LCD monitor is open 90°, it can be tilted with the screen down as much as 90°, and can also be tilted with screen up and turned up to 180° so the screen faces in the same direction as the lens.

If the LCD monitor is turned 180° so the screen faces in the same direction as the lens during recording, subject image will also appear in the viewfinder as a mirror image (left/right reversed). Tilt the LCD monitor to adjust its vertical angle so that you can see the screen easily.

Note:

- If no image appears on LCD monitor screen, refer to “Check 7” on page 164.
- Be sure to open the LCD monitor approximately 90° before changing its vertical angle.
- Do not record for a prolonged time with the LCD monitor turned approximately 180° in close contact with the DVD video camera/recorder body: Doing this could cause the DVD video camera/recorder and LCD monitor to become hot.

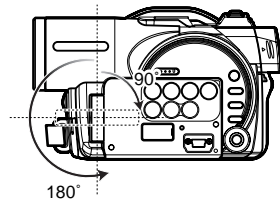
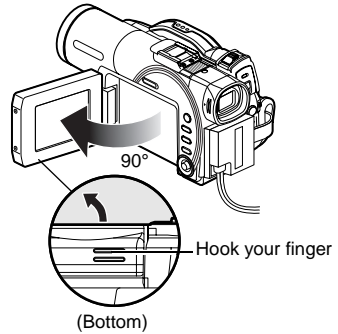

CLOSING LCD MONITOR

Before closing the LCD monitor, be sure to reset it at right angles to the DVD video camera/recorder.

Replace the LCD monitor on the DVD video camera/recorder with the LCD screen facing inward until a click is heard.

Note:

- Be sure to return the LCD monitor at right angles to the DVD video camera/recorder before closing it or replacing it on the DVD video camera/recorder with its screen facing outside. If the LCD monitor is tilted, it cannot be closed to the DVD video camera/recorder.
- If the LCD monitor is not securely locked to the DVD video camera/recorder, no image will appear in the viewfinder.

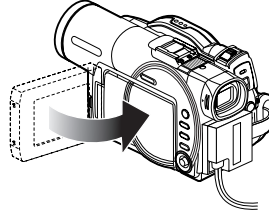

SETTING DATE AND TIME

Set the current date and time so that the date and time you make a recording can be recorded correctly. The following procedure can also be used to correct the date and time you have already set.

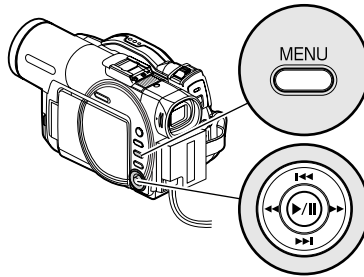

Tilt up/down and to left/right to select, and then press ►/|| to designate.

1 Turn the DVD video camera/recorder on.

2 Press the MENU button.

The menu screen will appear.

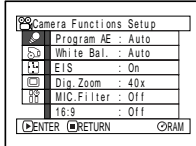

5 Tilt the joystick to left or right to select the digit you want to set in sequence.

Tilt the joystick up or down to select the number for current date/time, and then repeat step 5 to set the current date and time.

Note:

To stop date/time setting midway, press the ■ button.

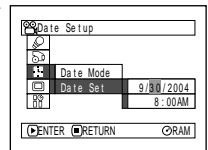

3 Use the joystick to choose “Date Setup” and then “Date Set”.

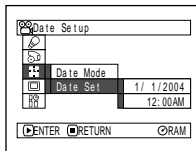

6 After setting the current date and time, press the ►/|| button.

The screen for verifying the set date will appear.

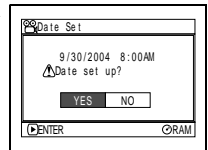

4 Tilt the joystick to right.

The figure for the month will be selected. [The digit that is highlighted first depends on the date display format (set up in Date Mode): The digit on the left end of the date display will be first highlighted.]

Note:

After setting the figure for the month, tilt the joystick to right to select the digit to be set. If you press the ►/|| button after selecting the figure for the month, the screen for verifying the set date will appear instead of screen for setting day, year or time.

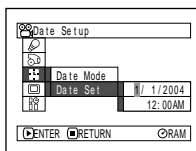

7 If the displayed date and time are correct, use the joystick to choose “YES”, and then press the ►/|| button.

The date and time will be set, and the DVD video camera/recorder will enter the recording pause status.

Choosing “NO” will restore the menu screen.

Note:

This DVD video camera/recorder incorporates a rechargeable battery to store the date and time in memory. If this built-in battery is exhausted, the date and time will be reset. To prevent this, connect the AC adapter/charger to DVD video camera/recorder every 3 months, and leave them for at least 24 hours with the DVD video camera/recorder turned off: The built-in battery will be charged.

CHANGING DISPLAY FORMAT OF DATE AND TIME

You can select one of three date display formats: month/day/year, day/month/year or year/month/day. Associated with the selected date display, the time display format will also change as follows:

Date display format	Example of display
M/D/Y	5:00PM 9/30/2004
D/M/Y	17:00 30/9/2004
Y/M/D	PM5:00 2004/9/30

1 Press the MENU button.

The menu screen will appear.

2 Use the joystick to choose “Date Mode” on the “Date Setup” menu screen, and then press the ►/|| button.

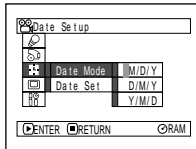

The options will appear on the right of “Date Mode”: The mark will be attached to the currently selected option.

3 Use the joystick to select the desired date display format, and then press the ►/|| button.

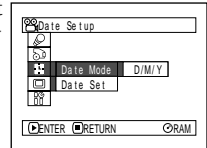

The menu screen for setting date will be restored, and the “Date Mode” has been changed as you designated.

4 Press the MENU button to switch off the menu screen.

Note:

If the date display format has been changed, the display format during playback as well as during recording will also be changed (see page 52).

Setting Up the Battery

The DZ-BP14S battery provided with this DVD video camera/recorder has not been charged at purchase time: Charge it before using the DVD video camera/recorder.

Note:

- Be sure to use the DZ-BP14S, DZ-BP14SW (optional) battery for the DVD video camera/recorder: Using other batteries could cause the DVD video camera/recorder to malfunction, or result in fire.
- Be sure to use the DZ-ACS1 AC adapter/charger to charge the battery: Using other chargers could cause electric shock or fire.
- Charge the battery at temperatures of 50 - 86°F (10-30°C).
- If the CHARGE indicator does not light when the AC adapter/charger is plugged into AC outlet, unplug it from the AC outlet, wait a few moments, and then plug it into the AC outlet again. If the CHARGE indicator still does not light, the AC adapter/charger may be faulty. Unplug it from the AC outlet and consult your dealer.
- The AC adapter/charger can be used around the world. An AC plug adapter is required in some foreign countries. If you need one, purchase it from your local electronics distributor.

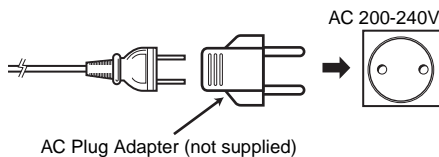

CHARGING BATTERY

Use the provided AC adapter/charger to charge the battery.

1 Connect the power cable to AC adapter/charger.

2 Plug the power cable into AC outlet.

The CHARGE indicator on AC adapter/charger will light.

3 Attach the battery to AC adapter/charger.

Note:

When charging a battery, unplug the DC power cord from the DC output jack on AC adapter/charger.

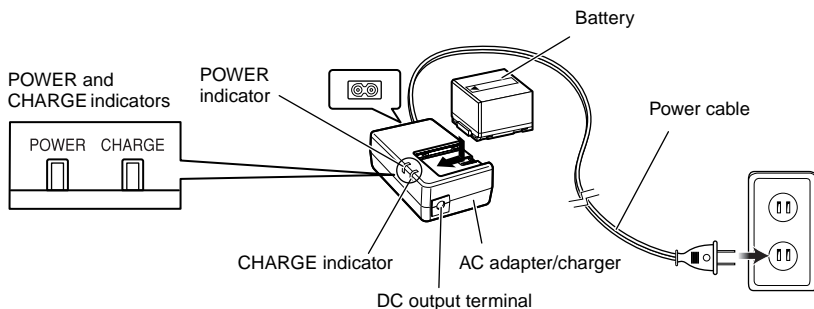

● Battery charged status

You can find out the charged status of battery by checking the CHARGE indicator on AC adapter / charger:

Charge status	CHARGE indicator
During charge	Lit
Charge complete	Goes out

Note:

See "Troubleshooting" on page 172 when the CHARGE indicator blinks.

● Reference for time required to charge battery (at approx. 25°C):

Approx. 165 minutes

The charge time will vary depending on the remaining power level of battery.

ATTACHING BATTERY TO DVD VIDEO CAMERA/RECORDER

- 1 Fit the battery to the battery attachment platform on this DVD video camera/recorder and slide it upward until a click is heard.

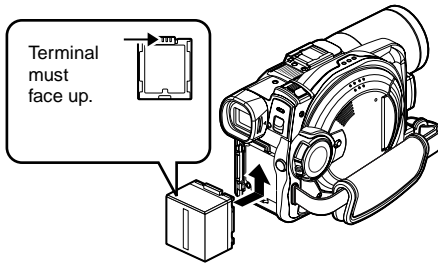

Note:

- Make sure that the battery is in the correct orientation.
- Make sure that the battery is securely attached: Incomplete attachment could cause the battery to fall, resulting in damage.

REMOVING BATTERY

After using the DVD video camera/recorder, remove the battery from it.

- 1 Slide the BATTERY EJECT switch on the bottom of DVD video camera/recorder, and hold it.
- 2 Slide the battery downward to remove it.

Note:

- For safety, be sure to turn the DVD video camera/recorder off before attaching or removing the battery.
- Be careful not to drop the removed battery.
- If the battery remains attached, minute level current will flow even if the DVD video camera/recorder is off, and the battery will discharge.

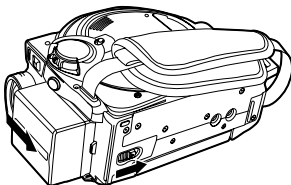

● **Continuously recordable time with fully charged battery (with no zoom operation, etc.)**

See the following table as a reference for how long the DVD video camera/recorder can continuously be used with a fully charged battery:

For DZ-MV550A

Video quality mode		DVD-RAM disc	DVD-R disc
XTRA ^{*1}	When using viewfinder	approx. 140 min	–
	When using LCD monitor	approx. 120 min	–
FINE	When using viewfinder	approx. 140 min	approx. 135 min
	When using LCD monitor	approx. 120 min	approx. 115 min
STD	When using viewfinder	approx. 165 min	approx. 160 min
	When using LCD monitor	approx. 135 min	approx. 130 min
LPCM ^{*2}	When using viewfinder	–	approx. 135 min
	When using LCD monitor	–	approx. 115 min

For DZ-MV580A

Video quality mode		DVD-RAM disc	DVD-R disc
XTRA ^{*1}	When using viewfinder	approx. 130 min	–
	When using LCD monitor	approx. 110 min	–
FINE	When using viewfinder	approx. 130 min	approx. 125 min
	When using LCD monitor	approx. 110 min	approx. 105 min
STD	When using viewfinder	approx. 150 min	approx. 145 min
	When using LCD monitor	approx. 125 min	approx. 120 min
LPCM ^{*2}	When using viewfinder	–	approx. 125 min
	When using LCD monitor	–	approx. 105 min

*1 The XTRA mode can be set only when a DVD-RAM disc is used. The time is only for reference: It will vary depending on recording contents.

*2 LPCM mode can be set only when DVD-R disc is used.

The reference for how long the DVD video camera/recorder can actually be used will be approx. 1/2 to 1/3 of the above time:

The continuously recordable time of DVD video camera/recorder in the left table shows the time available when the DVD video camera/recorder is in the recording mode without using any other function after recording is started. In actual recording, the battery will discharge 2-3 times faster than this reference, since the REC button and zoom are being operated, and playback is performed. Assume that the actually recordable time with a fully charged battery is between 1/2 and 1/3 of the above time, and prepare enough batteries to allow for the time you are planning to record on the DVD video camera/recorder. The continuously recordable time may be less depending on the conditions when the DVD video camera/recorder is used (if recording and recording pause are repeated at short intervals, etc.).

Note that the battery discharges faster in cold places.

● **The time taken for charging the battery is 165 minutes at 77°F (25°C).**

Note:



- See page 172 when charging is not possible.
- The charge time will vary depending on the battery remaining level.
- During and after charging, the battery will be warm, but this does not indicate a fault.
- A battery cannot be charged while the DC power cord is connected to the DC output jack of AC adapter/charger: Unplug the DC power cord when charging a battery.
- Charge the battery at ambient temperature 50°F to 86°F (10°C to 30°C): Charging at temperatures other than this range could damage the battery.

BATTERY REMAINING LEVEL INDICATOR

When the battery is used to power the DVD video camera/recorder, the battery remaining level appears in the viewfinder or on the LCD screen as follows:



Note:

The remaining level indicator “” may be displayed for an extended period, and “” or “” may be displayed for a shorter period.

EFFICIENT USE OF BATTERY

Charge battery immediately before using DVD video camera/recorder:

The battery will slightly discharge even if it is detached from the DVD video camera/recorder. If the battery is left attached to DVD video camera/recorder, it will consume a slight amount of power. Therefore, it is recommended that you charge the battery shortly before using the DVD video camera/recorder, usually on the day before you plan to use it.

However, since the battery used for this DVD video camera/recorder is free from the memory effect, you do not need to completely discharge the battery before charging it.

When not using the DVD video camera/recorder for an extended period:

It is recommended that you fully charge the battery once a year, attach it to DVD video camera/recorder and use it up; then remove the battery and store it in a cool place again.

Store in cool, dark place:

When you are not using the DVD video camera/recorder, remove the battery and store it in a cool, dark place. If you store it in a place where the temperature is high, the battery life will be shortened. Be especially sure not to store the battery in an environment (in a closed vehicle) over 140°F (60°C): Neglecting this could damage the battery. Also, do not store the battery in a place which is too cold, such as in a refrigerator: Doing so could cause condensation when using the DVD video camera/recorder with the battery.

Battery life:

The battery life varies greatly depending on the ambient environment and how often the DVD video camera/recorder is used. If the usable time of DVD video camera/recorder with a fully charged battery is noticeably short, the battery is probably dead: Purchase a new one.

Power save and discharge of battery:

It is recommended that you turn the DVD video camera/recorder off in status other than recording, since even during recording pause battery power is consumed at the same level as during recording.

If, when you specify Power Save On, the recording pause status continues for approximately 5 minutes, the DVD video camera/recorder will automatically turn off.

To set or release power save, see “Turning DVD Video Camera/Recorder Off Automatically (Power Save)” on page 102.

USING DVD VIDEO CAMERA/RECORDER WITH AC ADAPTER/CHARGER

It is recommended that you use the AC adapter/charger to power the DVD video camera/recorder from household AC outlet when you perform settings on it, play back or edit images, or use it indoors.

Note:

Be sure to use the specified AC adapter/charger (DZ-ACS1) to power the DVD video camera/recorder. Using other AC adapter/chargers could cause electric shock or result in fire.

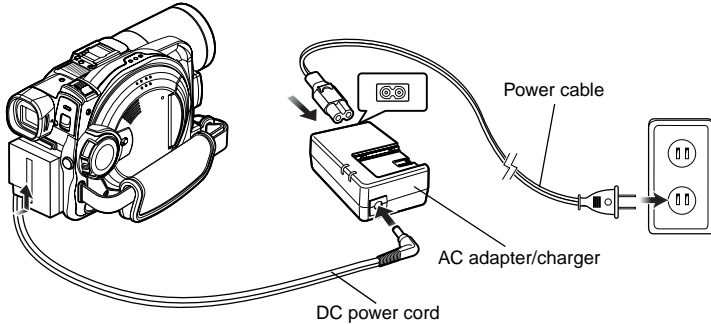

- 1** Connect the power cable to AC adapter/charger.
- 2** Plug the power cable into AC outlet.
- 3** Plug one end of DC power cord into the DC output jack on AC adapter/charger.
- 4** Attach the other end of DC power cord to the battery attachment platform on DVD video camera/recorder.

Inserting and Removing Disc

INSERTING DISC

- 1 Press down the DISC EJECT button once and release it.

A few moments after the ACCESS/PC indicator blinks, the cover of disc insertion block will open slightly.

- 2 Gently open the cover by hand until it stops.
- 3 Insert the disc, in Round DVD Holder, into the disc guide until it stops.

Note that the recording/playback surface of disc must face the inside of DVD video camera/recorder. The orientation for inserting the disc into the disc guide is also predetermined: Load the disc correctly, referring to the figure below.

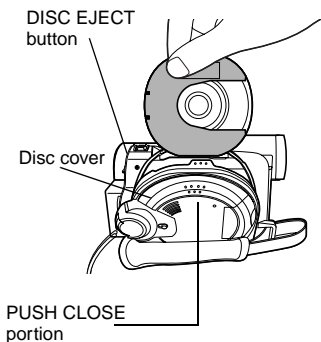

- The disc exposed portion must face in the same direction as the lens, as shown in figure.
- The recording/playback side must face the inside (DVD video camera/recorder).

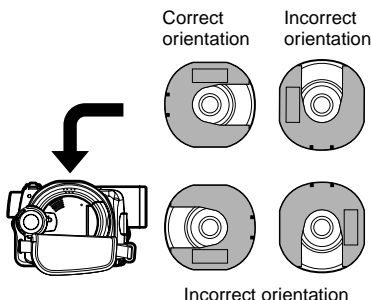
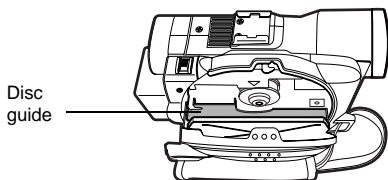

- 4 Push the section marked "PUSH CLOSE" on the cover of disc insertion block, to close the cover.

- 5 Turn the DVD video camera/recorder on (VIDEO or PHOTO).

When "DISC ACCESS" disappears, the DVD video camera/recorder is ready for recording.

● Identifying recording/playback sides of disc:

Single sided disc:

The recording/playback side is opposite to the printed label.

Double-sided disc:

The recording/playback side of "SIDE A" is opposite to the "SIDE A" marked side.

The recording/playback side of "SIDE B" is the "SIDE A" marked side.

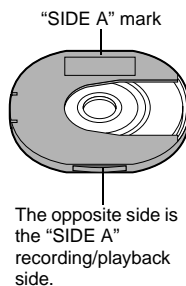

Note:

- Disc cannot be inserted or removed unless a charged battery or AC adapter/charger is connected to the DVD video camera/recorder.
- If a discharged battery is used, the disc cannot be inserted or removed: Connect a charged battery or AC adapter/charger to the DVD video camera/recorder.
- See page 82 for how to set disc in Round DVD Holder.
- If there is some delay before recording starts, refer to “Check 4” on page 163.
- The disc insertion orientation is predetermined: Forcibly inserting a disc in wrong orientation could damage the DVD video camera/recorder or Round DVD Holder of disc.
- If the disc is not correctly inserted, the cover will not close. Never try to forcibly close the cover: This could cause damage. Reinsert the disc properly.
- If a single-sided disc is inserted into DVD video camera/recorder with the printed label facing the inside, an error message will appear. Remove the disc and reinsert it with its recording/playback side facing the inside. See “Trouble Messages” on page 165.
- **When using double-sided disc**
Recording is possible on both sides of double-sided disc. However, when recording or playback on one side is finished, recording or playback will not move automatically to the other side. Remove the disc once from the DVD video camera/recorder, turn over the disc in Round DVD Holder and insert it again for continued use.

When using brand-new DVD-R disc

Recognition of the disc will start.

The messages on the right will appear in sequence by pressing the ►/|| button between messages.

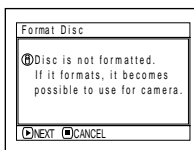
**When recording on this DVD video camera/recorder:**

When final message “Format the disc now?” appears, choose “YES” and then press the ►/|| button. The disc will be automatically formatted. When formatting is complete, “DVD-R disc, Video mode cannot be changed” will appear (see page 169): Press the ►/|| button to erase the message. Once formatted, a DVD-R disc can no longer be changed to a disc for PC, even if it has not been recorded on this DVD video camera/recorder.

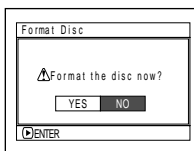
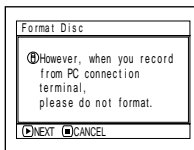
**Note:**

See page 96 for movie quality mode.

When recording data from PC:

While the above messages are being displayed, press the ■ button, or when message “Format the disc now?” appears, choose “NO” and then press the ►/|| button.

However, if data from PC has not yet been recorded, the disc can be made usable on this DVD video camera/recorder. When inserting the disc into this DVD video camera/recorder, the same message will appear: If you wish to use it on this DVD video camera/recorder, choose “YES”.

Note:

Do not initialize a disc on which you wish to record data created using the application (MyDVD) of PC.

REMOVING DISC

- 1** Set the power switch to “POWER OFF” to turn the DVD video camera/recorder off.

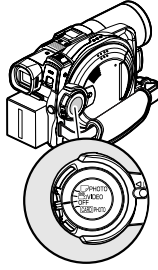

- 2** Press down the DISC EJECT button once and release it.

In a moment, the cover of disc insertion block will open slightly.

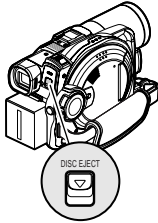

- 3** Gently open the cover until it stops.

When the cover is fully open, the disc will slightly come out from the disc guide, and stop.

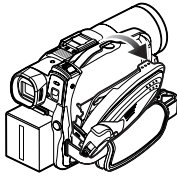

- 4** Remove the disc.

Hold the top of Round DVD Holder as shown in the illustration and gently pull it out.

Note:

Be careful not to touch the disc exposed portion when removing the disc.

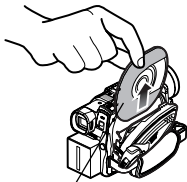

When grasping the holder, avoid the disc exposed portion.

- 5** Gently push the section indicated “PUSH CLOSE” on the cover of disc insertion block, to close the cover.

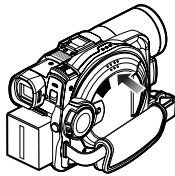

Note:

- Even after the DVD video camera/recorder is turned on, the disc can be removed unless it is in recording status. Hold down the DISC EJECT button for approximately 2 seconds, and then release it to remove the disc. (The DISC EJECT indicator on the LCD screen will blink.) It is recommended that you turn the DVD video camera/recorder off before inserting or removing disc to prevent misoperation.
- Do not remove the battery or disconnect the AC adapter/charger during removal of the disc or until power is completely turned off. If you do, the disc cover will not open. If this happens, reattach the battery or AC adapter/charger, push down the DISC EJECT button once, and then release it.
- Do not insert anything other than the 8 cm DVD-RAM or DVD-R disc into the disc insertion block: Doing so could cause malfunctions.
- Set the power switch to “POWER OFF” to turn the DVD video camera/recorder off.
- When inserting or removing the disc, be careful not to touch the inside of DVD video camera/recorder (especially, the lens of laser pickup (see “Terminology”, P. 160)). Also, BE SURE NOT to look into the lens in laser pickup: Doing so could damage your eyesight.

Inserting and Removing Card

1 Turn the DVD video camera/recorder off.

2 Open the cover of card insertion block.

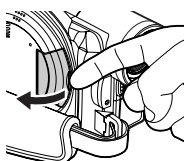

3 Inserting Card:
Insert card with its terminal inward until it locks.

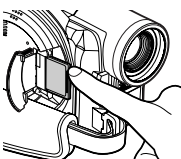
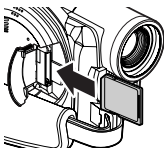

Removing Card:
Push the center of card edge.
The card will come out so that it can be held by fingers.

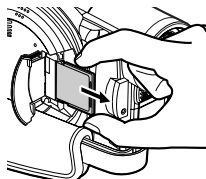
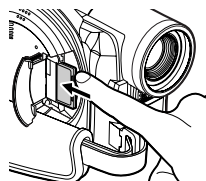

4 Close the cover of card insertion block.

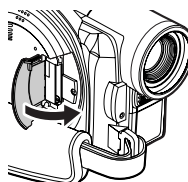

Basic Techniques

This section explains about recording of movies and still images, and also basic settings on DVD video camera/recorder.

Basic Handling of DVD Video Camera/Recorder

TURNING DVD VIDEO CAMERA/RECORDER ON AND OFF

While holding down the gray button at the center of power switch, set the switch according to each recording function:

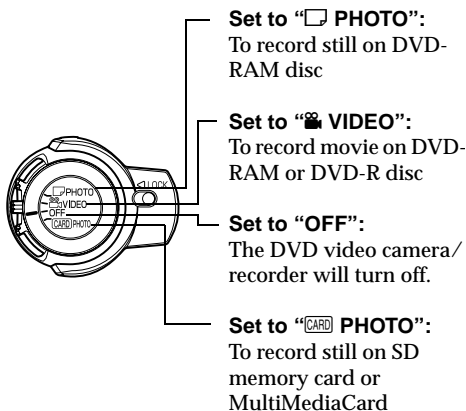

Power ON status

During playback, set the power switch to "VIDEO" or "PHOTO" when using disc, or set it to "CARD PHOTO" when using card. Turn the switch while holding down the gray button at the center of switch.

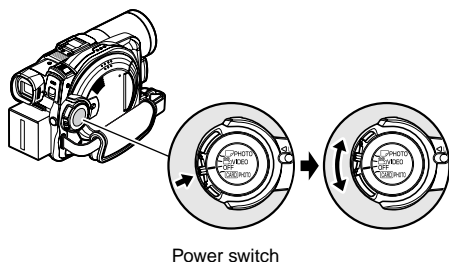

Note:

- Once you turn the DVD video camera/recorder on to let it recognize the disc, you can immediately record or play back by turning the DVD video camera/recorder on again (DVD-RAM). However, if you remove the disc, replace it, or if the date changes after power is turned on, it will take some time for the DVD video camera/recorder to start because it must recognize the disc again (see page 163).
- Once you have recorded on DVD-R disc and the disc is left in DVD video camera/recorder, you can immediately start recording when turning the DVD video camera/recorder on next time (DVD-R disc).
- It will take some time for the DVD video camera/recorder to display the Disc navigation screen after power is turned on.
- If you turn the DVD video camera/recorder on, the ACCESS indicator will light or blink to show that the DVD video camera/recorder is recognizing the disc or card: During this time, no operation, such as recording, can be performed. After several seconds, the ACCESS indicator will go out, and operating the DVD video camera/recorder will be possible. If the ACCESS indicator does not go out, refer to "Check 4" on page 163.

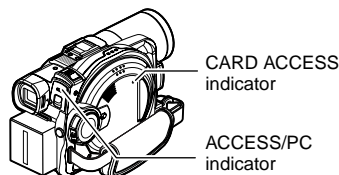

- When the DVD video camera/recorder is turned on, the self-diagnosis function will work and a message may appear. In this case, refer to "Trouble Messages" on page 165 and take corrective action.
- While the ACCESS/PC or CARD ACCESS indicator is lit or blinking, do not violently open or close the LCD monitor.

Recording Movie

Before You Begin

Pressing REC once will start recording; pressing it once again will temporarily stop recording.

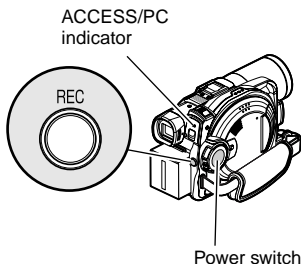

- Insert a recordable DVD-RAM or DVD-R disc into this DVD video camera/recorder.

1 Turn the DVD camera/recorder on.

Set the power switch to “ VIDEO” to turn the DVD video camera/recorder on.

After the ACCESS/PC indicator goes out, perform the subsequent operation:

2 Check the subject on the screen (viewfinder or LCD).

If using the viewfinder, pull it out.

3 Press the REC button.

The “●II” mark in the viewfinder or on the LCD screen will change to the “●REC” mark, and recording will start.

During recording, the recording indicator on the front of DVD video camera/recorder will light.

Pressing REC again during recording will set the DVD video camera/recorder to the recording pause status.

4 When recording is finished, turn the DVD video camera/recorder off.

Note:

- See “Check 1” on page 163 when recording movie is not possible.
- See “Check 4” on page 163 if it takes some time before recording is possible.
- See “Check 5” on page 164 if the DVD video camera/recorder does not operate.
- See page 52 for on-screen information display.
- It is recommended that you use DVD-RAM disc from which recorded contents can be deleted.

- Sound is recorded from the stereo microphone on the front of DVD video camera/recorder: Take care that this microphone is not blocked.
- You can press the REC button immediately after the DVD video camera/recorder enters the recording pause status, but no further recording can be made while “DISC ACCESS” is being displayed. Recording will restart after the message disappears.
- Do not turn power off while message “DISC ACCESS” is being displayed.
- Take care that power is not interrupted while the ACCESS/PC indicator is blinking.
- The minimum recordable time of movie is approximately 3 seconds.
- See page 103 for setting of Record LED (recording indicator) On/Off.
- For various functions available during recording, see “Setting Up Camera Functions” on page 90.
- Hitachi cannot be responsible for video and audio that cannot be recorded or edited because of any defect.
- The power switch can be changed over even during recording, but the operation will not be changed.
- Each time the DVD video camera/recorder enters the recording pause status, the counter display will be reset to “0:00:00”.
- When using DVD-R disc, do not perform the following, or data on the disc may not be read:
 - Using another device, doing additional recording on DVD-R disc recorded on this DVD video camera/recorder
 - Using this DVD video camera/recorder, doing additional recording on DVD-R disc recorded on another device
 - It is recommended that you set the LOCK switch to (to the left) to prevent the power switch in the “ VIDEO” position from accidentally moving to “ PHOTO”.

Recording Stills

Note:

Recording of still images is possible on DVD-RAM disc and card.

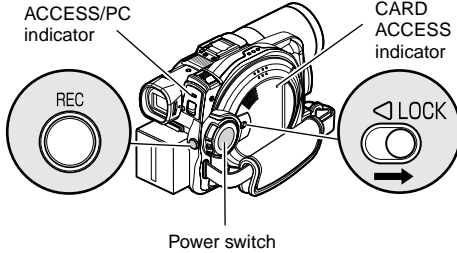

1 Turn the DVD camera/recorder on.

When using DVD-RAM disc:

Set the power switch to "□ PHOTO".

When using card:

Set the power switch to "CARD PHOTO".

After the ACCESS indicator goes out, perform the subsequent operation:

2 Check the subject on the screen (viewfinder or LCD).

3 Press the REC button.

The DVD video camera/recorder automatically focuses on the subject at the center of screen (when auto focus is selected).

The screen will be black, and then the recorded still will be displayed. When the "●||" mark appears, you can proceed with the next recording; while "DISC ACCESS" or "CARD ACCESS" is being displayed, you cannot proceed with the next recording.

4 Set the power switch to "POWER OFF" to turn the DVD video camera/recorder off.

Turn power off only after message "DISC ACCESS" disappears.

Note:

- See "SIZE AND QUALITY OF PHOTOS" on page 30 for details of photos on card.
- See "Check 2" on page 163 if recording photos is not possible.
- Shake of the DVD video camera/recorder may cause blur in recorded image.
- When holding the DVD video camera/recorder for recording, grasp it securely with both hands.
- When recording with higher zoom magnification, it is recommended that you secure the DVD video camera/recorder on a tripod.
- Do not operate the power switch or remove the card while the ACCESS/PC or CARD ACCESS indicator is lit or blinking: Doing so may damage the card or the data on card.
- With DZ-MV580A, the range of screen in which recording is possible will be different for movie and still.

Compensating for Backlight

When subject is lighted from rear, this function will compensate for lighting so that the subject is not too dark.

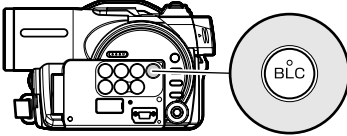

1 Press the BLC button during recording.

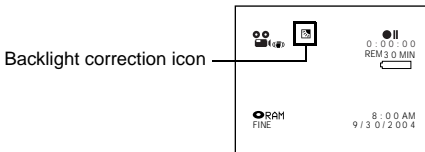

The backlight correction icon will appear.

Note:

- Pressing the BLC button will alternate between backlight setting between on and off.
- The backlight setting will automatically return to “off” when the DVD video camera/recorder is turned off.

On-Screen Information

Various types of information will appear in the viewfinder or on the LCD screen during recording.

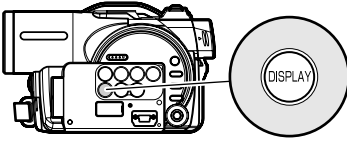



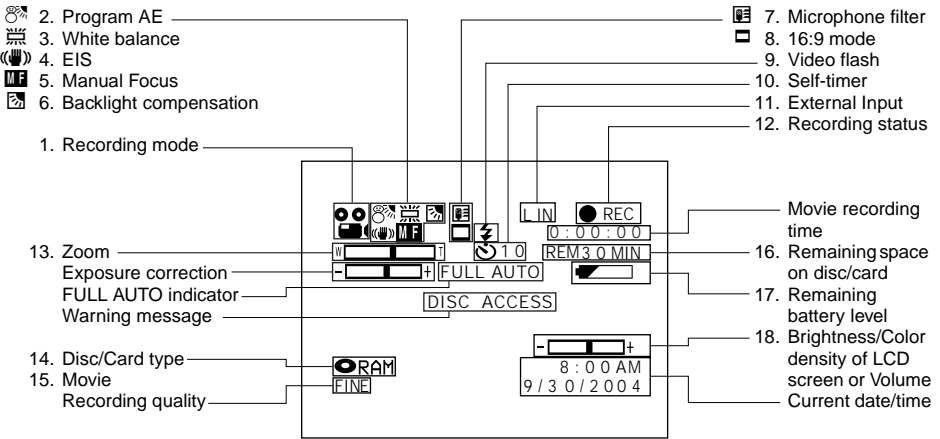

INFORMATION DISPLAY DURING RECORDING

See the next page for details.







The above screen is an example for explanation:
It is different from the actual display.





1. Recording mode (P. 49, 50, 98)

-  : Movie
-  : Still
-  : External input still (field)
-  : External input still (frame)

2. Program AE (only in movie recording mode) (P.90)

- No display: Auto
-  : Sports
 -  : Portrait
 -  : Spotlight
 -  : Sand & Snow
 -  : Low Light



3. White balance (P.91)

- No display: Auto
-  : Set
 -  : Outdoor
 -  : Indoor1
 -  : Indoor2

4. Electronic image stabilizer (EIS)*1 (P.93)

- No display: EIS OFF
-  : EIS ON

5. Manual focus (P.71)

- No display: Autofocus
-  : (display in English or German): Manual focus
 -  : (display in French or Italian): Manual focus
 -  : (display in Spanish): Manual focus

6. Backlight compensation (P.51)

- No display: Backlight compensation OFF
-  : Backlight compensation ON



7. Microphone filter (only in movie recording mode) (P.93)

- No display: Microphone filter OFF
-  : Microphone filter ON

8. 16:9 mode*2 (P.94)

- No display: 16:9 mode OFF
-  : 16:9 mode ON

9. Video flash*3 [when Video Flash (sold separately) is attached] (only in still recording mode) (P.75)

- No display: Emits light automatically
-  : Always emits light
 -  : No light emission



10. Self-timer (only in still recording mode) (P.99)

- No display: Self-timer OFF
-  : Self-timer ON (count is from 10 seconds)

11. External Input (P.98)

- L IN : AV input
- S IN*3 : S-VIDEO input





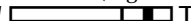
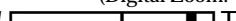

12. Recording status

-  : During recording
 -  : During recording pause
- No display*4

13. Zoom (P.56)

- W  T
(Digital Zoom: Off)
- W  T
(Digital Zoom: 40×)
- W  T
(Digital Zoom: 500× (DZ-MV550A),
240× (DZ-MV580A), only in movie
recording mode)

14. Disc/Card type

-  : DVD-RAM
 -  : DVD-R
 -  : DVD-RAM (write-protected)
 -  : DVD-R disc already finalized on this DVD video camera/recorder
 -  : DVD-R disc finalized on a device other than this DVD video camera/recorder
 -  : SD memory card or MultiMediaCard
 -  : Locked SD memory card
- No display*5

15. Movie recording quality (only when using disc) (P.96)

XTRA	: Best quality (only when using DVD-RAM disc)
LPCM	: Best audio quality (only when using DVD-R disc)
FINE	: High quality
STD	: Standard quality

Still recording quality (only when using card) (P.97)

FINE	: High quality
NORM	: Standard quality
ECO	: Number of recordable stills is prioritized

16. Remaining space on disc/card*6

REM XX MIN*7	: Remaining recordable minutes during movie recording
REM XX*8	: Number of remaining recordable still images during still recording

17. Remaining battery level (P.42)

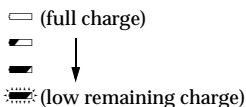

18. Brightness/Color density of LCD screen or Volume (P. 58, 101)



The volume can be adjusted during external input and playback.

- *1 EIS cannot be used when recording stills on DZ-MV580A.
- *2 Not displayed on DZ-MV550A. Displayed on DZ-MV580A only when a DVD-RAM disc is used in the movie recording mode.
- *3 Not displayed on DZ-MV550A.
- *4 When no disc or card is in the DVD video camera/recorder, or disc has not yet been initialized, a write-protected disc or locked card, or a disc or card with no remaining space, has been inserted.
- *5 When a disc or card that cannot be used in this DVD video camera/recorder is inserted
- *6 No remaining time or number will be displayed with a protected disc or locked card, or finalized DVD-R disc.
- *7 In XTRA mode, possible recording time may be longer than the displayed time.
- *8 The displayed number of recordable stills is for reference: This number may not decrease, depending on the recording conditions (not displayed with a DVD-R disc).

● Switching the information display mode

You can switch the display mode of on-screen information:

Press the DISPLAY button.

The full and minimum display modes will alternate.

- **Full display mode:** All types of information will appear.
- **Minimum display mode:** The recording mode (see 1 on page 52) and recording status (see 12 on page 52) will appear. If the DVD video camera/recorder has warning information, a warning message will appear.

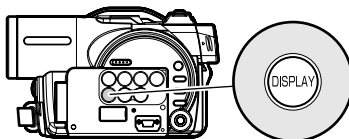

Note:

The DVD video camera/recorder does not record the date and time as a part of image. However, this information during recording will be recorded with image as data which can be checked on Disc Navigation screen during playback (see "Information Display During Playback" on page 62).

● Display when recording an image of yourself

When recording with the LCD screen facing the same direction as the lens, the operating status will appear, and in addition, the battery remaining level will blink when the battery has almost no remaining charge.



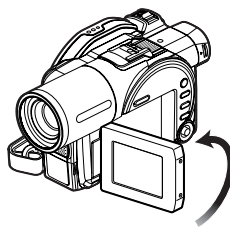

The following operating status indicator will light or blink to give warning message to user. The message can be checked when returning the LCD monitor 180° to the original status from the status in which the LCD screen was facing the same direction as the lens.



No warning/message (see page 52) will appear when recording with the LCD screen facing the same direction as the lens.

Instead, the following screen display symbols will blink to inform you of the operation status of DVD video camera/recorder.

When the LCD monitor is turned 180° from the position with the LCD screen facing the same direction as the lens, the warning/message can be checked.

Screen display symbol	Description
	<ul style="list-style-type: none"> • A write-protected disc is loaded. • A locked card is loaded.
	<ul style="list-style-type: none"> • An unusable card is loaded.
	<ul style="list-style-type: none"> • An attempt to record a still is being made with a DVD-R disc used. • An unusable disc is loaded.
	<ul style="list-style-type: none"> • The remaining capacity on disc is approaching 0.
	<ul style="list-style-type: none"> • The remaining capacity on disc or card is approaching 0. • There is no remaining capacity on disc or card. • An attempt to record a copy-guarded image is being made.

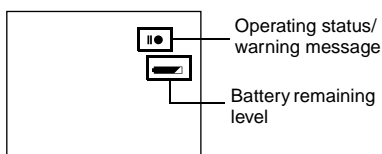

Note:

- If the LCD screen is set facing the same direction as the lens, the LCD screen will display a mirror image (left and right reversed).
- If the LCD screen is set facing the same direction as the lens, you can also view subject image in the viewfinder.
- Although you can switch to the manual focus, exposure and on-screen display modes even during recording with LCD screen facing the same direction as lens, they will not appear on the screen.

Zooming

If you continue to hold the zoom lever on the “T” control side with Dig. Zoom 40x or 240x specified, the digital zoom will be activated midway (when optical 18-power is exceeded on DZ-MV550A or optical 10-power is exceeded on DZ-MV580A). You can zoom up to 500-power on DZ-MV550A; up to 240-power on DZ-MV580A.

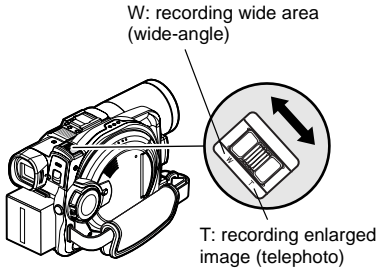

Note:

- The digital zoom setting will be stored in memory even if the DVD video camera/recorder is turned off.
- You can also use the DIGITAL ZOOM button on remote control to switch the digital zoom setting: Pressing the button during movie recording will switch the setting between “Off”, “40x” and “500x” (on DZ-MV550A) or “240x” (on DZ-MV580A); Pressing the button during still recording will switch between “Off” and “40x”.
- If you set zoom to 500x (DZ-MV550A), 240x (DZ-MV580A) when recording still, the digital zoom will be up to 40x.
- When a subject is zoomed, it may be momentarily out of focus.
- When digital zoom is engaged, the image quality will be rougher.

- 1 Press the MENU button, choose “Dig. Zoom” on the “Camera Functions Setup” menu screen, and then press the ►/|| button.

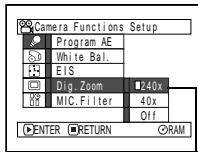

- 2 Choose the desired magnification, and then press the ►/|| button.
- 3 Press the MENU button to end the setting.

Moving the zoom lever will display the digital zoom bar.

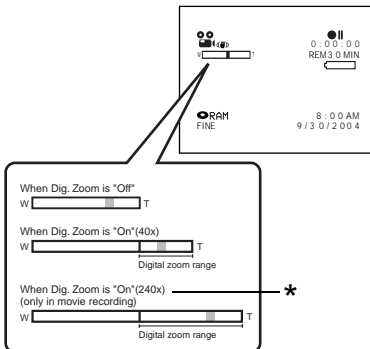

* 500x will appear on DZ-MV550A; 240x will appear on DZ-MV580A.

MACRO RECORDING

Use the macro function when recording a small object from close-up position: You can shoot the subject as close as approximately 13/16" (2 cm) from the lens surface, magnifying the image to fill the screen.

- 1 Aim the DVD video camera/recorder at the subject, and press down the zoom lever to "W" control side.

Note:

- Zoom can be used, but the subject may not be focused, depending on the distance to the subject. In this case, move the zoom to "W" control side to focus.
- The amount of light tends to be insufficient during macro recording: If the subject image is too dark, use additional lighting.

RECORDING SUBJECTS FOR STRONGER WIDE-ANGLE OR TELEPHOTO EFFECT

Use tele-conversion lens or wide-conversion lens with a filter diameter of 37 mm and thread pitch of 0.75 mm, to record subjects for stronger telephoto or wide-angle effect.

- 1 Remove the lens hood from DVD video camera/recorder.

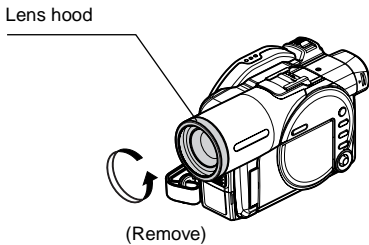

- 2 Remove the cap of conversion lens, and screw the lens into the filter thread of DVD video camera/recorder until it stops.

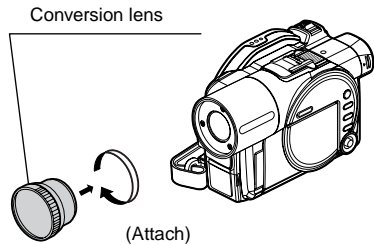

- Tele-conversion lens (DZ-TL1): For stronger telephoto effect
- Wide-conversion lens (DZ-WL1): For stronger wide-angle effect

Note:

- Be careful not to lose the removed lens hood.
- With DZ-TL1 tele-conversion lens, the focusing range at "T" (telephoto) control side is between approx. 5 m and infinite.
- When a conversion lens is attached, note that if you zoom in on a subject, vignetting will slightly occur on the "W" (wide-angle) control side (the four corners of screen will be dim).
- When replacing the lens, take care not to drop the DVD video camera/recorder.

Playing Back

Before You Begin

- Insert a disc or card recorded on this DVD video camera/recorder (P. 49, 50).
- Turn the DVD video camera/recorder on (P. 48).

RAM R CARD

PLAYING BACK

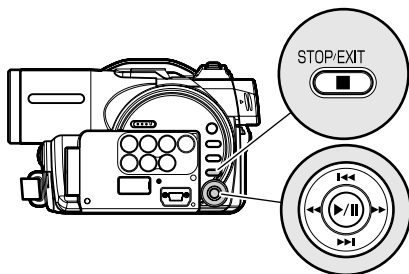

Tilt up/down and to left/right to select, and then press ►/|| to designate.

1 Press ►/|| button in the recording pause status.

The DVD video camera/recorder will enter the playback mode, and the scene you have recorded last will be played back. (For “scene”, see P. 105 and “Terminology”, P. 160.)

When playback is finished, the DVD video camera/recorder will enter the pause status at the last image on disc.

If the playback pause status continues for as long as 5 minutes, the DVD video camera/recorder will automatically return to the recording pause status.

2 Press the ■ button.

Playback will stop, and recording pause status will be restored.

Note:

- If the LCD monitor is open during playback of movie, playback sound will be heard from the speaker. Adjust the sound volume using the volume control buttons (⊖, ⊕).
- To temporarily stop playback, press the ►/|| button. Press the ►/|| button again to restart playback.
- Even if you stop playback midway and immediately start recording again, the new image will be recorded after the last scene on disc or card (the previous images will not be overwritten).
- Image data edited on PC or certain types of image data may not appear on this DVD video camera/recorder.
- Image data recorded on another camcorder may not be playable on this DVD video camera/recorder.
- Depending on the amount of data to be played back, it may take some time for the playback image to appear.
- Do not operate the power switch or remove the card while the ACCESS/PC or CARD ACCESS indicator is lit or blinking: Doing so may damage the card or the data on card.

PLAYBACK FROM START OF DISC OR CARD

Use the Go To function (P. 61) or Disc Navigation function (P. 105) to play back from the start of disc or card.

SEARCH PLAYBACK OF MOVIE

During playback, tilt the joystick to right or left and hold it: Search playback will start.

Hold to right : Scenes will be visually scanned forward

Hold to left : Scenes will be visually scanned backward

Release the joystick when you find the desired image: Normal playback will start from that point.

Note:

- When you skip or search scenes from playback or playback pause, the screen will be dark briefly.
- See page 163 if search playback does not operate normally.

FRAME ADVANCE/FRAME BACK/SLOW PLAYBACK OF MOVIE

During playback pause, tilt the joystick: Frame advance, frame back or slow playback will start.

Tilt to right once : Picture will advance one frame.

Tilt to left once : Picture will go back one frame.

Hold to right : Forward slow playback

Hold to left : Reverse slow playback

After frame advance, frame back or slow playback, the DVD video camera/recorder will enter the playback pause status.

Note:

- In slow playback, a rapidly moving subject image may be distorted.
- The intervals for playing back frames in frame advance/frame back/slow playback are as follows:
Frame advance and forward slow: Approx. 0.03 second
Frame back and reverse slow: Approx. 0.5 second
- No sound will be heard during search playback or slow playback.

SKIP PLAYBACK OF MOVIE

During playback, tilt the joystick up or down to locate the start of desired scene.

Tilt down once : To skip to the first image of the scene following the one being played back, and start playback.

Tilt up once : To return to the first image of the scene being played back, and start playback.

Hold down : To continuously locate the beginnings of scenes, starting from the scene following the scene being played back. When the desired image appears, release the joystick: Playback will start from that point.

Hold up : To continuously locate the beginnings of scenes backward, starting from the scene preceding the scene currently being played back. When the desired image appears, release the joystick: Playback will start from that point.

PLAYING BACK STILLS

Tilt the joystick up or down during playback to quickly play back stills in sequence.

Tilt down once : To display stills one by one forward

Tilt up once : To display stills one by one backward

Portion being played back

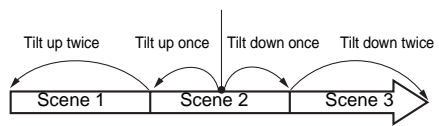

Portion being played back

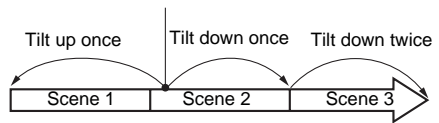

Tilting up the joystick at a portion several seconds from the start of scene being played back will return to the start of the scene preceding that being played back.

Note:

- If you perform skip playback during playback pause, the DVD video camera/recorder will enter the playback pause status at the beginning of the located scene.
- Tilting down in the last scene on disc will set the DVD video camera/recorder to the playback pause status at the last image.
- See "Check 3" on page 163 if skip playback does not operate normally.

[When using disc]

Releasing the joystick will start continuous playback.

[When using card]

When the joystick is released, the photo at that point will be displayed, and then the DVD video camera/recorder will enter the playback pause status.

Set the slide show function for continuous display (P. 139).

JUMPING TO SPECIFIED POINT (GO TO)

1 Press the MENU button during playback.

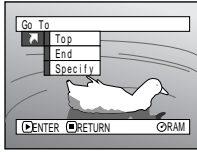

2 Choose the option (point you want to go to), and then press the ►/|| button.

- Top** : To go to the start, and enter playback pause.
- End** : To go to the end of last scene, and enter playback pause.
- Specify** : To go to a specified point and enter playback pause. See the following for details.

● Specifying the point to view

1 Choose “Specify” in step 2 above, and then press the ►/|| button.

The screen for specifying the point to go to will appear.

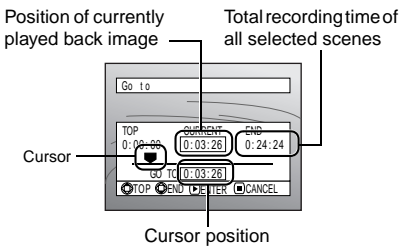

3 Press the ►/|| button to enter the selection.

The DVD video camera/recorder will go to the specified point and enter the playback pause status.

Pressing ►/|| again will start playback.

To cancel the “Go To” procedure midway, press the ■ button before going to the specified point.

Note:

- If multiple scenes are selected using the Disc Navigation function or SELECT button, choosing “Top” will jump to the beginning of selected scenes (P. 133).
- When multiple scenes are selected, the total time of selected scenes will appear in the “total recording time” display.
- With card, the number of stills will appear at the “TOP”, “CURRENT”, “END” and “GO TO” indicators.
- The cursor may not move at same-pitch intervals.

2 Use the joystick to select the desired time of chosen point.

- Tilt up : To select the start.
- Tilt down : To select the end.
- Tilt to left or right :
 - Press once: To move the cursor in 10-second units (1-still units for card)
 - Hold down: To move the cursor in 1-minute units (10-still units for card)

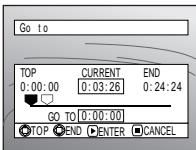

(When the start of scene is selected)

- ☐ Cursor at current image position.
- ▀ Cursor at (GO TO) position.

On-Screen Information Display

INFORMATION DISPLAY DURING PLAYBACK

Various types of information on recording will be superimposed on playback image you are viewing.

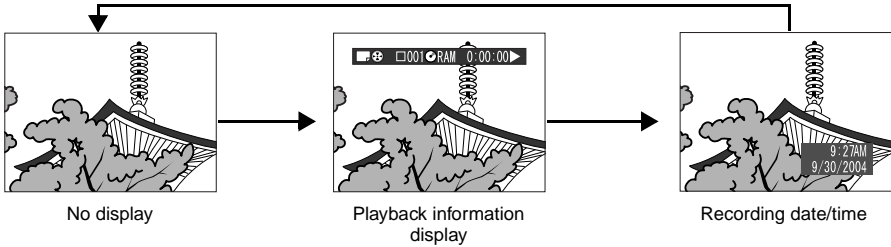

● Switching the information display mode

Press the DISPLAY button: You can switch the display mode of on-screen information.

When using disc:

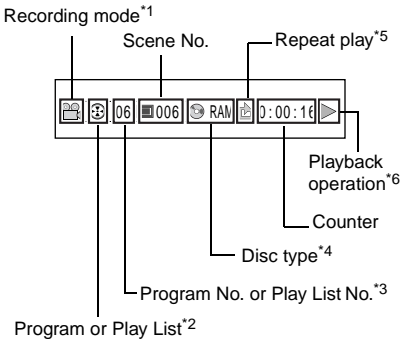

When using card:

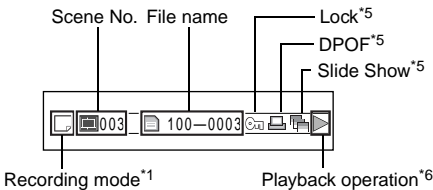

*1 (VIDEO) or (PHOTO); Only (PHOTO) with card.

*2 Program or Play List

*3 Number of program or play list being played back (not displayed when all programs are being played back)

*4 Refer to "Disc/Card type" on page 53.

*5 : Will appear when each function is specified "On"

*6 : Standard playback

: Playback pause

: Forward search playback

: Reverse search playback

: Forward skip playback

: Reverse skip playback

: Forward frame advance

: Reverse frame back

Refer to "Playing Back" beginning on page 58 for how to operate.

The "" mark will appear on the first image on disc.

The "" mark will appear on the last image on disc.

• **Recording date/time display:** Shows the date/time when recording was started. Even when playback starts, the date/time display will not advance.

• **No display:** No information will appear. However, when the mode of playback operation is switched, the symbol will appear for approx. 3 seconds.

Note:

See "Using Disc Navigation" on page 105 and later for explanation on program and play list.

Checking Flow of Quick Mode

The following two on-screen menu modes are available with this DVD video camera/recorder:

- Quick mode: To display only the fundamental menu items for first timers
- Advanced mode: To display all menu items for experts (P.87)

Camera Functions

Set the QUICK MODE switch to  ON, and then, while the camera image is being displayed on the LCD monitor, press the MENU button: The menu of Quick mode will appear.

Only the fundamental menu items will appear in the Quick mode, and the explanation of the function on which the cursor is positioned will be displayed across the bottom of menu (No explanation on function will appear in the Advanced mode.).

Tilt the joystick up, down, to left or right to select a menu item, and then press the ►/II button to choose the option.

See page 89 for how to set the menu.

No menu appears during recording.

- 1 Set the QUICK MODE switch to  ON.
- 2 Press the MENU button.

<How to interpret the menu screen>

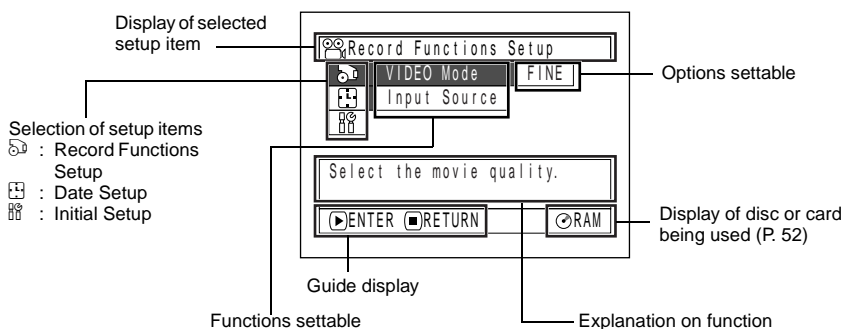

FLOW OF QUICK MODE WHEN RECORDING MOVIE:

The following shows the menu when DVD-RAM disc is being used:

The details of each function are described on the pages showing the Advanced mode: See each reference page.

● Record Functions Setup

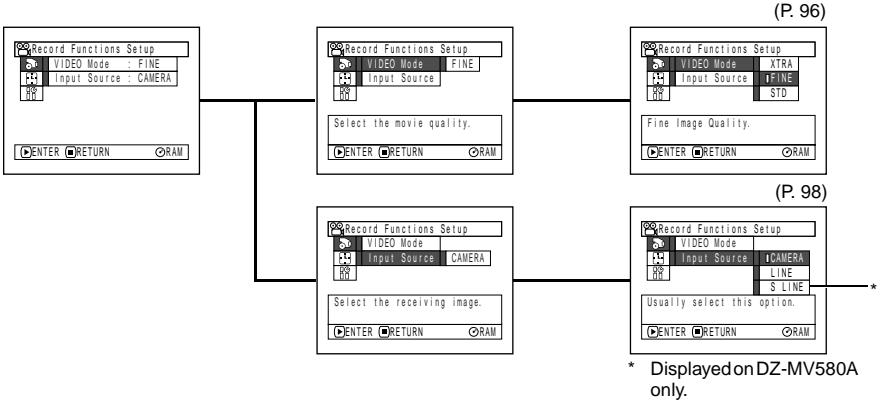

● Date Setup

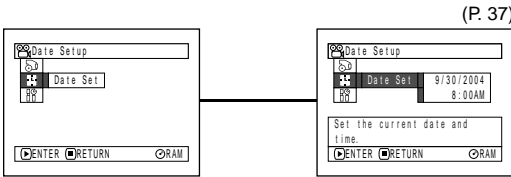

● Initial Setup



FLOW OF QUICK MODE WHEN RECORDING PHOTO (DISC):

The following shows the menu when DVD-RAM disc is being used:

The details of each function are described on pages showing the Advanced mode: See each reference page.

● Record Functions Setup

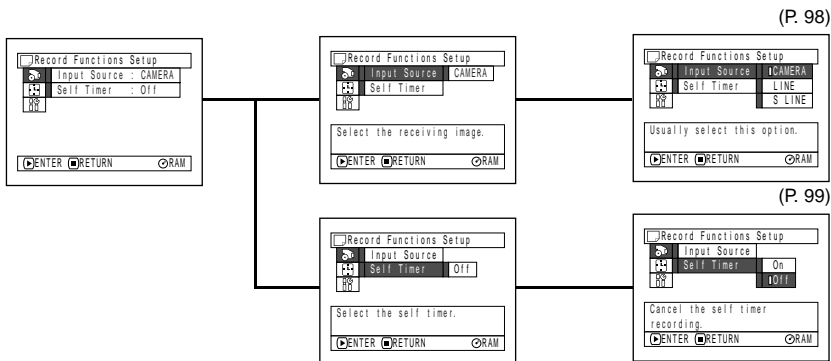

● Date Setup

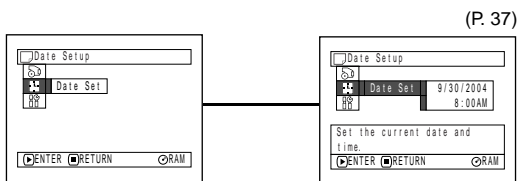

● Initial Setup



Note:
No photo can be recorded on DVD-R disc.

FLOW OF QUICK MODE WHEN RECORDING PHOTO (CARD):

The details of each function are described on pages showing the Advanced mode: See each reference page.

● Record Functions Setup

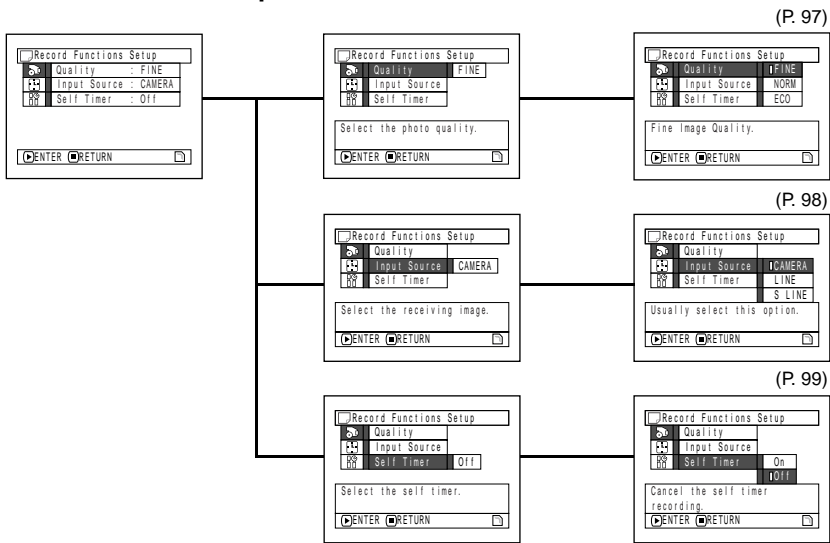

● Date Setup

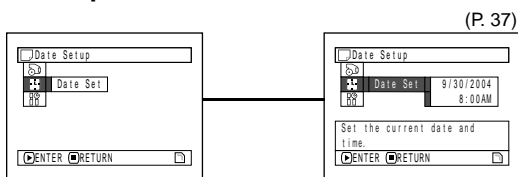

● Initial Setup



Disc Navigation Functions

Set the QUICK MODE switch to  ON, and then, while Disc Navigation screen is being displayed on the LCD monitor, press the MENU button: The menu of Quick mode will appear.

Only the fundamental menu items will appear in the Quick mode, and the explanation of the function on which the cursor is positioned will be displayed across the bottom of menu (except during recording).

- 1 Set the QUICK MODE switch to  ON.
- 2 Press the DISC NAVIGATION button.
- 3 Select a scene, and then press the MENU button.

RAM

FLOW OF QUICK MODE (WITH DVD-RAM DISC):

The details of each function are described on pages showing the Advanced mode: See each reference page.

● Scene

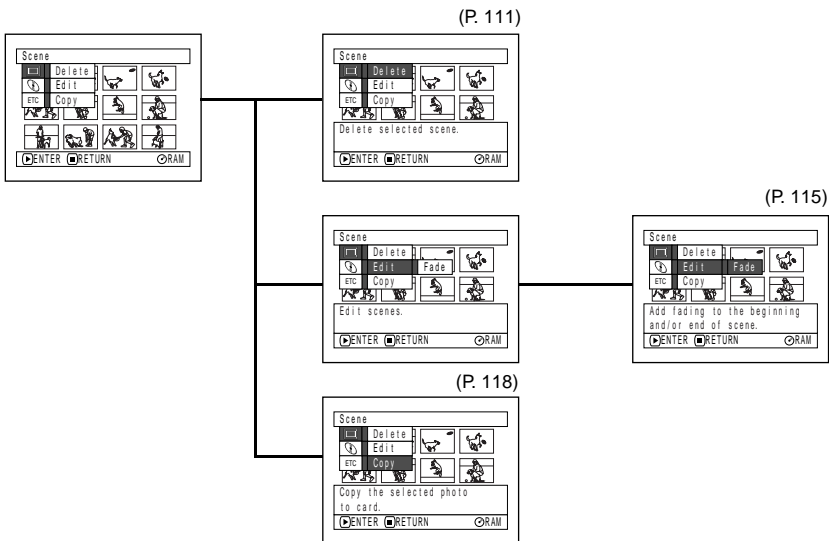

● Disc

(P. 134)

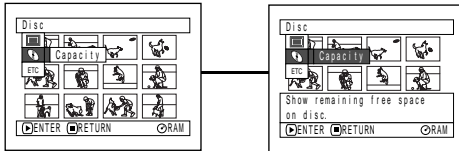

● Others

(P. 138)

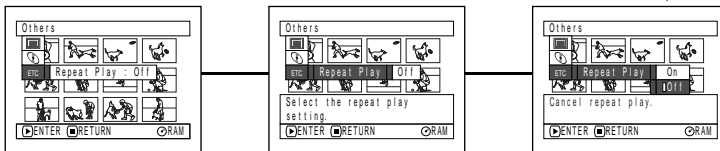

R

FLOW OF QUICK MODE (WITH DVD-R DISC):

The details of each function are described on pages showing the Advanced mode: See each reference page.

● Disc

(P. 134)

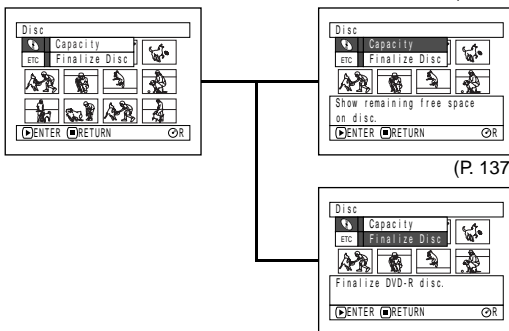

(P. 137)

● Others

(P. 138)

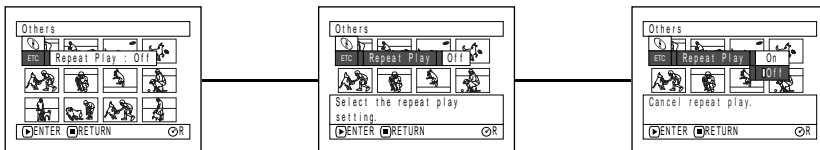

Note:

The menu item "Capacity" or "Finalize Disc" will not appear with a finalized DVD-R disc.

FLOW OF QUICK MODE (WITH CARD):

The details of each function are described on pages showing the Advanced mode: See each reference page.

(P. 111)

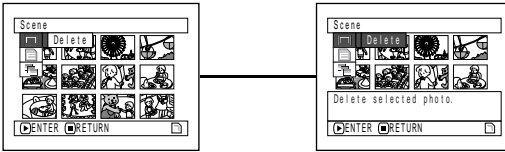

(P. 134)

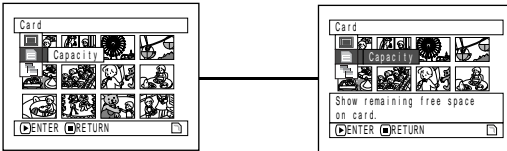

(P. 139)

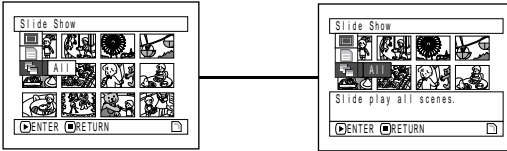

Manually Focusing Subject

The DVD video camera/recorder usually focuses on a subject automatically (autofocus). You can also manually focus a subject depending on the recording conditions.

FOCUSING DURING RECORDING

Normally, the DVD video camera/recorder automatically focuses the subject (auto-focus), but you can also manually focus a subject, depending on the recording conditions (manual focus).

Focusing range

You can switch the display mode of on-screen information:

- On T (tele) side: approximately 3.6 feet (1 m) from lens surface to infinity
- On W (wide) side: approximately 13/16" (2 cm) from lens surface to infinity

1 Press the FOCUS button during recording.

"MF" will appear on the screen.

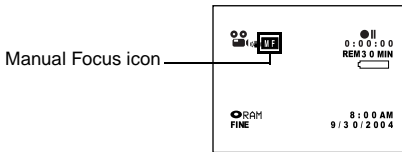

2 Press the zoom lever down to "T" control side to zoom in on subject.

3 Use the \ominus \oplus buttons to adjust the focus, while viewing the image in the viewfinder or on the LCD screen.

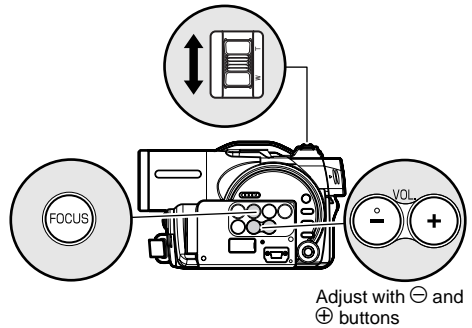

Note:

- Pressing FOCUS will alternate between manual focus and auto focus. With auto focus, no indication will appear on the screen.
- Be sure to zoom in on your subject before manually focusing on it. If you bring the subject into focus at the "W" control side, focus will be faulty when you turn the zoom lever to the "T" control side to zoom in on the subject.
- Manual focus is released when the DVD video camera/recorder is turned off. When you turn the DVD video camera/recorder on next time, auto focus will be restored.

Manually focus the following objects, which may not be automatically focused (see page 71):

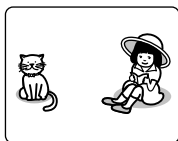

Objects not in the center of screen

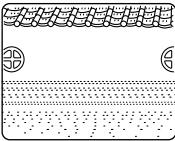

Objects with little variation in brightness, such as white wall

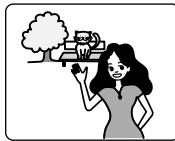

Objects that are far and near at the same time



Objects moving rapidly



Objects lit by neon sign, spotlight, etc. which glares or emits strong light



Dark objects



Object behind glass with water droplets, dirt on it



Night view

Adjusting Brightness of Image to be recorded (Exposure)

The DVD video camera/recorder usually adjusts the exposure automatically. You can also manually adjust the exposure depending on the recording conditions.

1 Press the EXPOSURE button during recording.

The exposure indicator will appear on the screen.

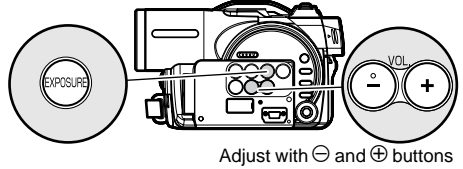
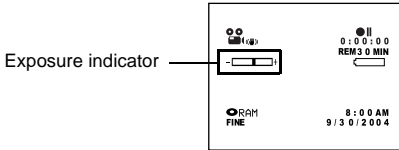

Note:

- Pressing EXPOSURE will alternate between manual adjustment and auto exposure. With auto exposure, no indication will appear on the screen.
- The exposure setting will return to Auto when the DVD video camera/recorder is turned off.

2 Use the ⊖ ⊕ buttons to adjust the exposure, while viewing the image in the viewfinder or on the LCD screen.

Using Full Auto Function

Pressing the FULL AUTO button will fully automate the camera functions.

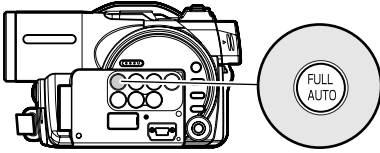

1 Press the FULL AUTO button.

“FULL AUTO” will be displayed on the screen of DVD video camera/recorder for several seconds.



The following settings will reset to defaults:

Function	When setting full auto	Reference page
Backlight compensation	Off	51
Focus	Auto	71
Exposure	Auto	73
Program AE	Auto	90
White balance	Auto	91
EIS	On	93
MIC.Filter	Off	93

Setting Video Flash (for DZ-MV580A)

See "Introduction to Optional Accessories" on page 157.

When recording stills in a dark place, or the subject is lit from rear, it is recommended that you use the optional DZ-FLH3 Video Flash*(P. 157): Refer to the instruction manual of Video Flash for use.

Setting of Video Flash	On-screen information	Manner of emitting light
AUTO	No display	Automatically emits light in dark place or in a place lit from rear.
ON		Always emits light regardless of brightness
OFF		No light emission

* Unusable on DZ-MV550A.

Note:

- However, dark subjects may not be in clear focus even if the Video Flash is used. It is recommended that you light a subject when recording in a dark place.
- "⚡" will blink while the video flash is being charged.
- While "⚡" is flashing, the video flash will not emit light, though the DVD camera/recorder is recording.
- Do not use the Video Flash when approaching the human eye. Emitting light from Video Flash near human eye could damage the subject's eyesight. Especially when recording a baby or small child, move the DVD video camera/recorder at least 1 m away.
- Do not use the Video Flash while pointing it at a driver in vehicle: Doing so could dazzle the driver, causing an accident.
- Do not use the Video Flash in a place where there is flammable or explosive gas: Doing so could cause fire or explosion.

USING EXTERNAL MICROPHONE

Connect external microphone (generally available) to the external microphone jack of this DVD video camera/recorder. Clearer sound can be recorded. Turn on the switch on external microphone and start recording. For details on external microphone, see “Major Specifications” on page 182.

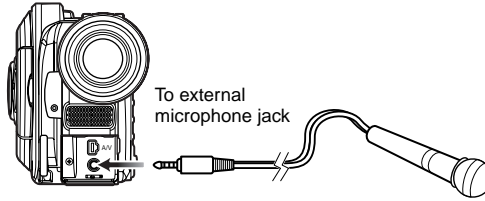

Note:

- Depending on the shape of its plug, an external microphone cannot be plugged in, while the cable is left plugged in the AV/S input/output terminal. Unplug the AV/S input/output cable to use the external microphone.
- This DVD video camera/recorder cannot use a plug-in power type microphone (power supplied from camcorder).

Viewing on TV Screen

CONNECTING TO A TV

Use the provided AV/S input/output cable to connect the DVD video camera/recorder to a TV as follows:

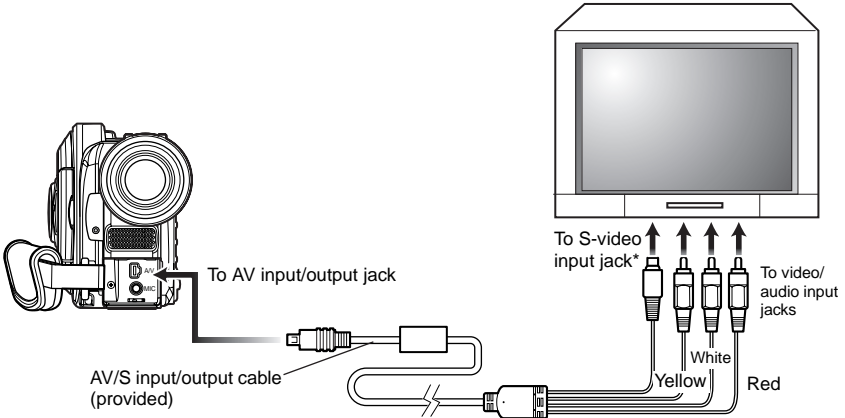

*If your TV has an S-VIDEO input jack, you can connect the S-VIDEO plug to it.

Note:

- Using S-VIDEO will deliver clearer playback status.
- Before connecting, make sure that the volume on TV is turned down: Forgetting this may cause howling (see "Terminology", P. 160) from the TV speakers.
- Insert the AV/S input/output cable plugs into jacks straight: Obliquely inserting them could damage the jacks.

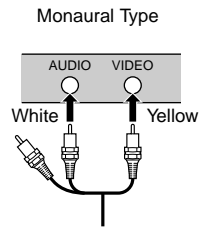
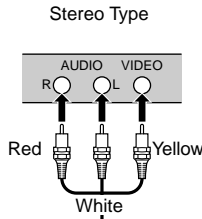
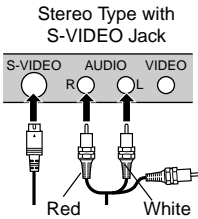

VIEWING ON TV SCREEN

- 1 Turn the TV on and set the input selector to "VCR" whichever applicable Video input.

Refer to the TV instruction manual for how to switch the TV input.

- 2 Turn the DVD video camera/recorder on.

The image that the DVD video camera/recorder is seeing will appear on the TV screen. You can also monitor the image on the LCD screen or viewfinder of the DVD video camera/recorder.

- 3 Perform playback, recording or editing.

You can perform playback, editing or editing on Disc Navigation while checking on TV screen.

Note:

- Adjust the volume of sound on TV.
- The infrared remote control is useful when operating the DVD video camera/recorder while viewing an image on TV screen. However, if you use a Hitachi VCR, the remote control may inadvertently operate the VCR if it is near the DVD video camera/recorder. To prevent this, set the remote control code of the VCR to a position other than "VCR2".
- Information that the DVD video camera/recorder is recording will appear on the TV screen: You can also display only part of information or switch off the display. Refer to "Setting On-Screen Display Output On or Off (OSD Output)" on page 100, and press the DISPLAY button to switch the display status.
- When copy-guarded disc is played back, no image will appear on TV screen.
- If you use TV with wide mode (aspect ratio 16:9) and set the TV to the wide mode, the entire Disc Navigation display may not be displayed on the TV screen. If this happens, release the wide mode setting on TV (see the TV instruction manual for releasing the wide mode).

Playback on DVD Video Recorder/Player

PLAYING BACK DVD-RAM DISC

You can use a DVD video recorder (see “Terminology”, P. 160) or DVD player that conforms to DVD-RAM to play back 8 cm DVD-RAM discs recorded on this DVD video camera/recorder.

- 1** Remove the disc from Round DVD Holder.
- 2** Insert the disc into the DVD video recorder/player and play it back.

See the instruction manual for DVD video recorder/player.

Note:

- When playing back disc on another device, the Disc Navigation display will be different from the one on this DVD video camera/recorder.

PLAYING BACK DVD-R DISC

1 Finalize a recorded DVD-R disc.

You need to finalize a disc to play it back on DVD player: See page 137.
No further data can be recorded on finalized disc.

Note:

Use this DVD video camera/recorder to finalize the DVD-R disc recorded on the DVD video camera/recorder.

2 Remove the disc from Round DVD Holder.

See “Removing and Replacing from/in Round DVD Holder” on page 81.

3 Insert the disc into the DVD player and play it back.

See the instruction manual for DVD player.

Note:

- Do not insert a DVD-R disc that has not been finalized into a DVD video recorder: The recorded image data may be damaged.
- See “Terminology” , P. 29, 160 for liner PCM recording.
- DVD-R discs recorded on this DVD video camera/recorder or other 8 cm DVD-R discs can be played back on other DVD players or other devices conforming to 8 cm DVD-R, but playback on all DVD players is not guaranteed.
- Playback may not be possible on some DVD players, or it may depend on the recorded status of DVD-R discs: In such cases, play back the DVD-R disc on this DVD video camera/recorder.

Removing and Replacing from/in Round DVD Holder

You can remove DVD-RAM or DVD-R disc used on this DVD video camera/recorder from Round DVD Holder and use the uncovered disc on DVD player, DVD video recorder, or drive for PC, etc. which conforms to 8 cm DVD-R. Removing disc from Round DVD Holder may vary with the disc maker: See the disc instruction sheet. The following explains the disc in Round DVD Holder made by Hitachi Maxell.

It is recommended that you do not remove the disc from Round DVD Holder until camera recording is finished, in order to avoid getting dirt on disc.

Note:

Using discs removed from holders on various devices may not always be possible.

HOW TO REMOVE DISC

1 Hold the Round DVD Holder with SIDE A facing up. While pushing the two release levers in the direction of arrows (1) marked on holder, slowly open SIDE A of the holder in the direction of arrows (2), taking care not to drop the disc.

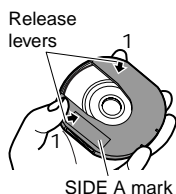

Do not open more than 90°.

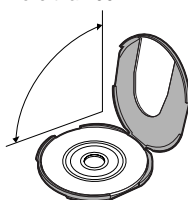

2 Without touching the recording / playback surface, hold the disc edge and center hole to remove it.



REPLACING DISC IN ROUND DVD HOLDER

1 Open SIDE A of the Round DVD Holder, and replace the disc in the holder with the SIDE A mark or label surface facing up, taking care not to touch the disc surface.

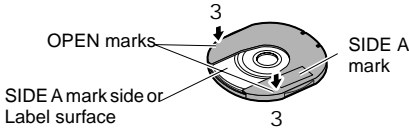

2 Close SIDE A of the Round DVD Holder, and push it to lock the release levers at positions (3).

WHEN THE HINGE OF ROUND DVD HOLDER COMES OFF

1 Push the hinged portion of the holder piece marked SIDE A with thumb and middle finger, and warp it in the direction of arrows (4).

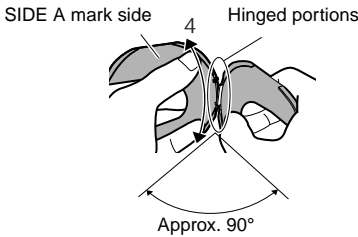

2 Fit the hinged portion of the other holder piece into the warped hinge portion.

Note:

- Handle the disc carefully so that no scratch, dirt, fingerprint or dust adheres to the recording/playback surface.
- When not using the Round DVD Holder, store it in case: Do not leave a bare holder as is.
- Be careful of drop or impact: If you drop the Round DVD Holder, the disc may pop out.
- Do not subject the Round DVD Holder to force.

DISC CLEANING

Use a soft, dry cloth to lightly wipe off any dust, dirt, etc. adhering to disc, as shown in the figure. Never use solvent. Do not use thinner, water, anti-static spray, etc. to clean disc.

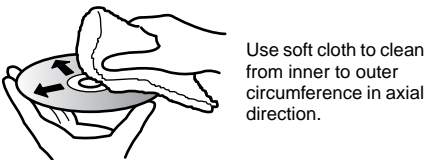

Recording (Dubbing) Images

Before You Begin

- Before connecting this DVD video camera/recorder to another device, be sure to turn both devices off.
- Insert a recordable disc or card* in this DVD video camera/recorder (see P. 25, 28).
- * Only photos can be recorded: No video can be recorded.

RECORDING (DUBBING) IMAGES FROM OTHER VIDEO DEVICE

You can record (dub) images from other video devices to disc or card in this DVD video camera/recorder.

Use the AV/S input/output cable (provided) to connect the DVD video camera/recorder to the other video device as follows:

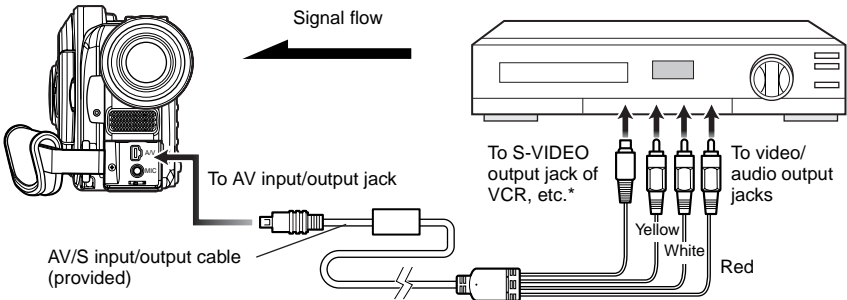

* If you are using DZ-MV580A and the connected AV device has an S-VIDEO output jack, you can connect the S-VIDEO jack of AV/S input/output cable.

1 Set the input source on the DVD video camera/recorder to “LINE (L IN)”.

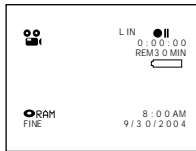

Switch the input referring to “Input Source” on page 98.

Choose “S LINE” to input S-VIDEO signal. (Only for DZ-MV580A)

2 Turn on the connected device, and start playback.

The picture will appear on the LCD screen or viewfinder of this DVD video camera/recorder.

3 Press the REC button.

Recording will start on this DVD video camera/recorder. The operation of this line-input recording is the same as for recording movie.

Note:

- If you operate the DVD video camera/recorder connected to another device, always power the camera/recorder from AC outlet using the AC adapter/charger.
- If you use a Hitachi VCR, it will be operated by the remote control provided with the DVD video camera/recorder. When recording an image from a Hitachi VCR, change the remote control code of the VCR to other than "VCR2".
- With DZ-MV580A, using S-VIDEO will enable you to record clearer images.
- The DZ-MV550A cannot record S-VIDEO input.
- Reduce the volume of external input sound heard from the built-in speaker: The loud volume may cause noise to enter the recorded image.
- The recorded contents can be played back in the same manner as when playing back camera images recorded on this DVD video camera/recorder.
- Still images can also be recorded on DVD-RAM disc or card. See "Switching External Input Recording Method (PHOTO Input)" on page 98 for details, and "Recording Stills" on page 50 for how to record still images.
- The "Input Source" setting will return to "CAMERA" whenever DVD video camera/recorder is turned off.
- Recording of most images is prohibited by the copy-guard signal to protect the copyright, except for images recorded on camcorders for personal enjoyment. "COPY PROTECTED" appears in these images: They cannot be recorded on this DVD video camera/recorder. Typical copyright protected images include those of DVD video, LD, recorded video tapes, some parts of digital satellite broadcasts, etc.
- If a video signal that cannot be read by this DVD video camera/recorder is present - even in images recorded on camcorder for personal enjoyment without copy-guard signal - the input image may not be recorded normally.
- If the input signal is interrupted by switching the channel on TV or switching the signal using video selector (see "Terminology", P. 160), normal recording cannot be performed.

RECORDING (DUBBING) IMAGES FROM OTHER VIDEO CAMERAS

You can record (dub) images from other video cameras on a disc or card* in DVD video camera/recorder. Use the AV/S input/output cable (provided) to connect the DVD video camera/recorder to the other video camera.

* Only photos can be recorded: No video can be recorded.

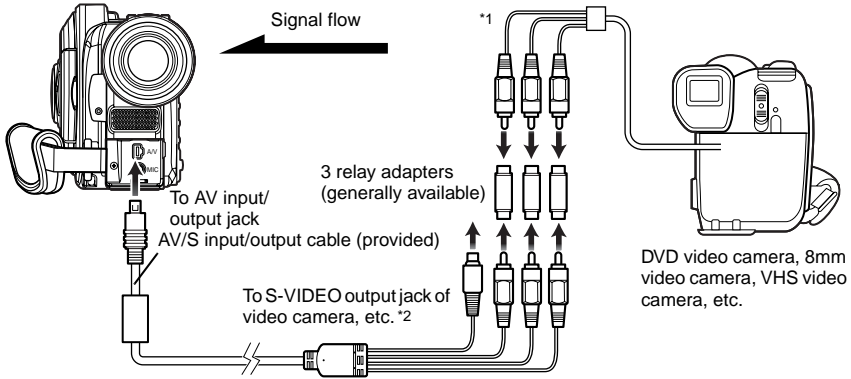

*1: The AV/S input/output cable provided with this DVD video camera/recorder can be directly connected to some video cameras.

*2: If the video camera to be connected has an S video output jack, you can connect it to the DVD video camera/recorder (DZ-MV580A only).

1 Set the input source on the DVD video camera/recorder to “LINE (L IN)”.

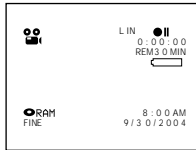

Switch the input referring to “Input Source” on page 98.

Choose “S LINE” to input S-VIDEO signal. (Only for DZ-MV580A)

2 Turn on the connected device, and start playback.

The picture will appear on the LCD screen or viewfinder of this DVD video camera/recorder.

3 Press the REC button.

Recording will start on this DVD video camera/recorder.

The operation of this line-input recording is the same as for recording movie.

Note:

- With DZ-MV580A, using S-VIDEO will enable you to record clearer images.
- Reduce the volume of external input sound heard from the built-in speaker: The loud volume may cause noise to enter the recorded image.
- Still images can also be recorded on DVD-RAM disc or card. See “Switching External Input Recording Method (PHOTO Input)” on page 98 for details, and “Recording Stills” on page 50 for how to record still images.

RECORDING (DUBBING) IMAGES ON OTHER VIDEO DEVICES

You can record (dub) images played back on this DVD video camera/recorder, on other video devices. Use the AV/S input/output cable (provided) to connect the DVD video camera/recorder to another video device as shown in the following figure:

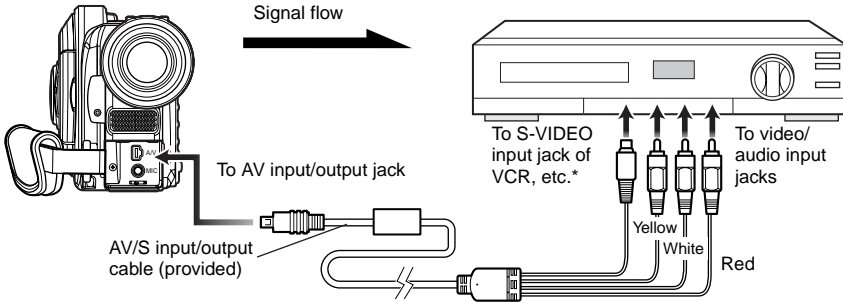

* If the video device to be connected has an S video input jack, you can connect it to the DVD video camera/recorder.

- 1 Press the DISC NAVIGATION button.
- 2 Select a scene to be played back.
- 3 Press the playback (▶/II) button on this DVD video camera/recorder and the record button on connected device: The DVD video camera/recorder will start playback and the recorded device will record (dub) it.

Note:

- Using an S-video jack will deliver clearer images.
- Audio is heard from the speaker: If the volume is too high, noise may enter the dubbed image.
- It is recommended that you use Disc Navigation to create a play list including the scenes to be dubbed among the scenes recorded on this DVD video camera/recorder (P.126).
- Be sure to use the AC adapter/charger to power the DVD video camera/recorder from AC outlet, to prevent battery power from shutting off during recording on another video device.
- If you are using a Hitachi VCR, using the remote control provided with this DVD video camera/recorder may operate the VCR. To record (dub) images from the DVD video camera/recorder to Hitachi VCR, change the remote control code of VCR to a position other than "VCR2".

Advanced Techniques

This section explains about various settings to further extend the usefulness of this DVD video camera/recorder.

Checking Flow of Normal Display Mode

The following two on-screen menu modes are available with this DVD video camera/recorder:

- Quick mode: To display only the fundamental menu items for first timers (P.63)
- Advanced mode: To display all menu items for experts

Camera Functions

Press the MENU button while the camera image is being displayed on the LCD monitor, with the QUICK MODE switch set to  OFF: The menu of Advanced mode will appear.

Tilt the joystick up, down, to left or right to select a menu item, and then press the /|| button to choose the option.

See page 88 for the setting method.

The screens used here to explain are displayed when DVD-RAM disc is used. Some items will not appear when a DVD-R disc or card is used, or when no disc is inserted.

No menu appears during recording.

<Menu screen for setting>

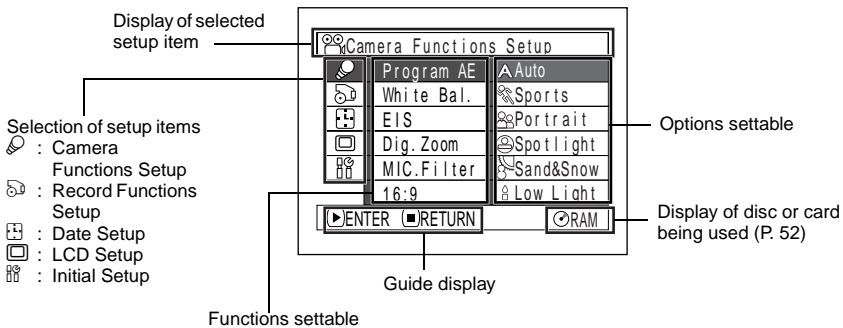

● Flow of Normal Display Mode

Refer to page indicated for details of each function.

Camera Functions Setup

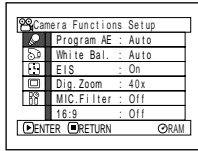

- Program AE (P. 90)
- White balance (P. 91)
- EIS*¹ (P. 93)
- Digital zoom (P. 56)
- Microphone filter*² (P. 93)
- 16:9*³ (P. 94)

- *1: Displayed on DZ-MV580A only in “ VIDEO” status.
- *2: Displayed only in “ VIDEO” status.
- *3: Not displayed on DZ-MV550A. Displayed on DZ-MV580A only for movies using DVD-RAM disc.

Recording Functions Setup

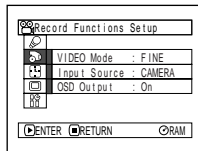

- Movie quality*⁴ (P. 96)
- Input selection (P. 98)
- External still input*⁵ (P. 98)
- Self-timer*⁶ (P. 99)
- On-screen information display output*⁷ (P. 100)

- *4 Not displayed with DVD-RAM disc in “ PHOTO” status. The quality mode is displayed in “ PHOTO” status. (P.97)
- *5: Displayed in “ PHOTO” or “ PHOTO” status using DVD-RAM disc, and input selection is set to external signal or S external signal.
- *6: Displayed with DVD-RAM disc in “ PHOTO” status, or “ PHOTO” status.
- *7: Displayed only when input selection is set to camera.

Date Setup

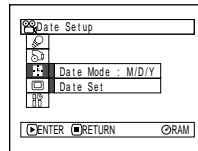

- Display format (P. 38)
- Date setting (P. 37)

LCD Setup

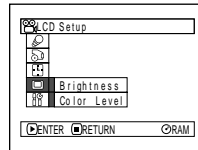

- Brightness (P. 101)
- Color density (P. 101)

Initial Setup

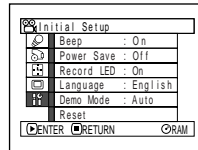

- Beep (P. 102)
- Power save (P. 102)
- Recording LED (P. 103)
- Language selection (P. 103)
- Demo mode (P. 159)
- Reset (P. 104)

You can use the joystick on DVD video camera/recorder to select various setting options in menu and designate them.

Press the MENU button.

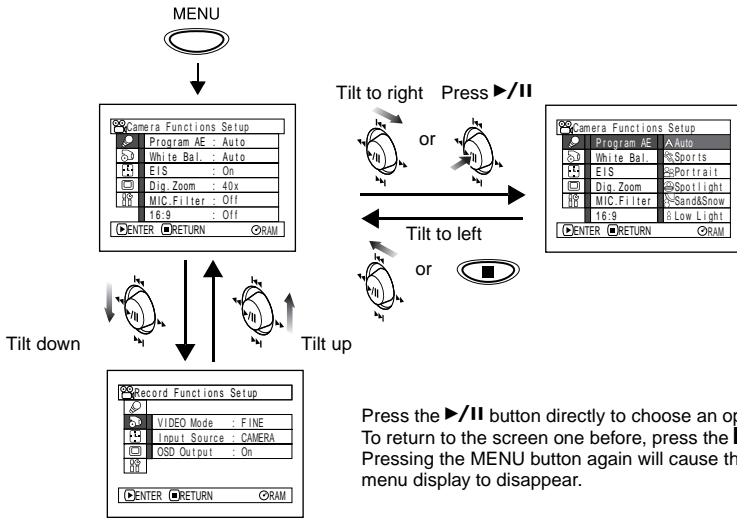

Press the ►/|| button directly to choose an option from menu. To return to the screen one before, press the ◼ button. Pressing the MENU button again will cause the advanced mode menu display to disappear.

Note:

- Pressing the MENU button during recording will not work.
- The menu screen will disappear when it is left for approx. one minute without any operation.
- With DZ-MV580A, if the MENU button is pressed with a still image displayed, the size of image will change. Pressing the MENU or ◼ button will restore the original screen.

Setting Up Camera Functions

Before You Begin

- See page 89 for how to set.
- No menu screen appears with external input.

SELECTING SHOOTING MODE TO MATCH THE SUBJECT (SWITCHING PROGRAM AE MODE)

This DVD video camera/recorder automatically detects the status of subject and surrounding situation and records the optimum image: If you choose the shooting mode to match the recording conditions, clearer images will be recorded.

- 1 Press the MENU button, use the joystick to choose "Program AE" on the "Camera Functions Setup" screen, and then press the ►/|| button.

The options will appear on the right of "Program AE".

- 2 Use the joystick to choose the desired option, and then press the ►/|| button: The selected option will be set.

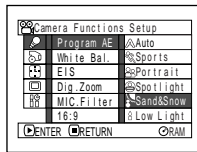

Selected AE mode

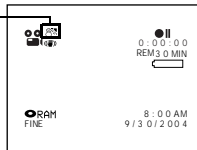

- 3 Press the MENU button to end the setting.

The menu screen will disappear.

Note:

- You can check the selected AE mode by the on-screen information display. However, nothing will appear in the Auto mode.
- The shooting mode set as above will be stored in memory even if the DVD video camera/recorder is turned off.

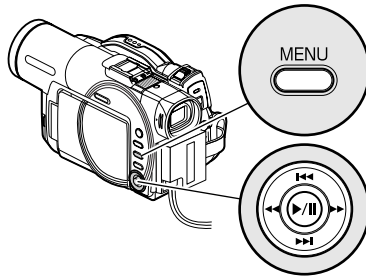

Tilt up/down and to left/right to select, and then press ►/|| to designate.

Auto : The camera/recorder automatically judges the subject and surrounding environment for optimum recording.

Sports : Reduces blurring when recording rapidly moving subjects such as in golf or tennis. If the Sports mode is used under a fluorescent light, the image may flicker: In this case, use the Auto mode for recording.

Portrait : Makes a subject, such as a person or a creature, stand out from a blurred background.

Spotlight : Prevents overexposure of subject portrait face, etc. when strong light strikes the subject, as in a wedding or on stage.

Sand & Snow : Prevents underexposure of subject portrait face, etc. in a place where reflection of light is intense, such as at the seaside in midsummer or on a ski slope.

Low Light : Allows user to record in a dark place even with decreased lighting: However, an after-image will appear with a moving subject. Note that the Low Light mode cannot be used when the recording quality mode is STD.

If there is difficulty in automatically focusing subject image, adjust the focus manually. (P.71)

ADJUSTING COLOR (WHITE BALANCE)

This DVD video camera/recorder automatically adjusts the color of subject. Change the white balance setting depending on the recording conditions.

Mode	Setting content	On-screen display
Auto	White balance always automatically adjusted	None
Set	You can manually adjust white balance to match the light source or situation (P.92)	
Outdoor	To record in fine weather	
Indoor 1	To record under incandescent light, halogen light or bulb-color type fluorescent light	
Indoor 2	To record under fluorescent light	

1 Press the MENU button, choose “White Bal.” on the “Camera Functions Setup” menu screen, and then press the **▶/||** button.

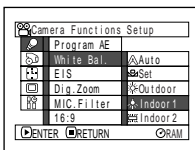

2 Choose the desired option, and then press the **▶/||** button.

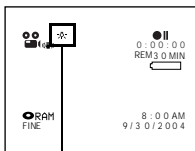

White balance mode

3 Press the MENU button to end the setting.

Note:

- The white balance mode can be confirmed using the on-screen information.
- The white balance setting will be stored in memory even when the DVD video camera/recorder is turned off.
- Do not block the infrared sensor (see “Terminology”, P. 160) with hand, etc.

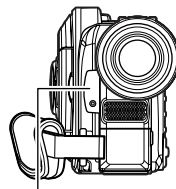

Infrared sensor block

- If a tele or wide-conversion lens is used, the auto white balance may not operate depending on the recording conditions. If this happens, set to the mode to match the recording conditions, or manually set the white balance.
- Be sure to remove the lens cap before turning the DVD video camera/recorder on: If the DVD video camera/recorder is turned on with the lens capped, the white balance will not work normally.

● Setting white balance manually

- 1 Point the DVD video camera/recorder at a white object so that it fills the screen. Use an object that is not transparent.

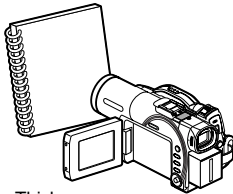

Thick paper

If focus is not correct when the white object fills the screen, manually focus the object, referring to “Manually Focusing Subject” (see page 71).

- 2 Press the MENU button, choose “White Bal.”, “Set”, and then press the ►/II button.

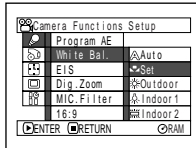

- 3 Hold ►/II pressed until the “” indicator changes from blinking to a steady light. When the “” indicator lights, the white balance setting will be complete.

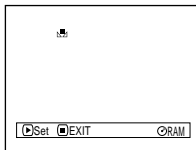

- 4 Press the button to end the setting.

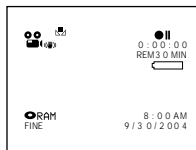

Note:

- The white balance set using the “Set” option will be stored in memory until it is re-set. Re-setting will change the “” indicator from blinking to a steady light.
- Do not use a colored object when setting the white balance: The appropriate tint cannot be set.
- If “Input Source: LINE” has been specified, you cannot use the “Set” mode of white balance (P. 98).
- The setting on white balance “Set” may not be possible in a dark place. Also, the white balance cannot be set when the zoom bar is in the digital zoom range (P. 56). In such status, the “” indicator will remain blinking. Set the white balance in a bright place with “Dig. Zoom Off” specified.
- If the recording conditions have changed, re-set the white balance for appropriate colors.

USING THE ELECTRONIC IMAGE STABILIZER (EIS)

When you use zoom to record a magnified subject image, it will correct fuzziness in the recorded image.

- 1 Press the MENU button, choose “EIS” on the “Camera Functions Setup” menu screen, and then press the ►/II button.

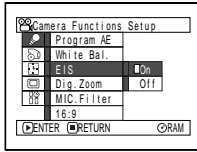

- 2 Choose the “On” or “Off”, and then press the ►/II button.
- 3 Press the MENU button to end the setting.

● Checking EIS On or Off

You can check EIS On or Off by the on-screen information display.

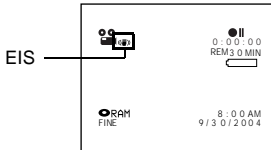

After recording with EIS set to “Off”, it is recommended that you return the setting to “On” and then turn the DVD video camera/recorder off, unless you normally record with “Off” setting.

Note:

- The EIS setting will be stored in memory even when the DVD video camera/recorder is turned off.
- It is recommended that you specify “EIS Off” when using the DVD video camera/recorder on a desk or tripod.
- When “EIS On” is specified, there will be a slight difference between the actual movement and the movement on screen.
- Gross camera shake may not be entirely corrected even if “EIS ON” is specified: Firmly hold the DVD video camera/recorder with both hands.
- EIS may not operate correctly when the tele or wide-conversion lens (generally available) is used.
- EIS cannot be used when recording stills on DZ-MV580A.

REDUCING WIND NOISE DURING RECORDING (MIC.FILTER)

When recording sound from the microphone built into this DVD video camera/recorder, you can reduce wind noise in recording.

If “MIC.Filter: ON” is specified, the low-frequency components in the sound picked up by microphone will be cut off during recording: This makes it easier to hear the target voice or sound during playback.

- 1 Press the MENU button, choose “MIC.Filter” on the “Camera Functions Setup” menu screen, and then press the ►/II button.

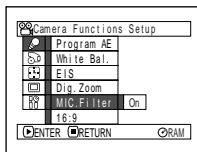

- 2 Choose the desired option, and then press the ►/II button.

- 3 Press the MENU button to end the setting.

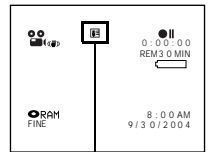

Microphone filter icon

Note:

- You can also use the on-screen display to confirm that the MIC.Filter has been set.
- The MIC.Filter setting will be stored in memory even when the DVD video camera/recorder is turned off.
- The MIC.Filter function will work only during movie recording.
- The microphone filter function works only with the built-in microphone: It will not function when using an external microphone (P. 76).

SETTING TO WIDE TV SCREEN MODE (16:9 MODE)

If you view the images recorded with “16:9 On” specified on a wide-screen TV (aspect ratio 16:9), screen image will be wider than the images recorded with “16:9 Off” (aspect ratio 4:3) by the size of the areas on left and right (in dotted lines).

“16:9 Off” specified
(aspect ratio 4:3)

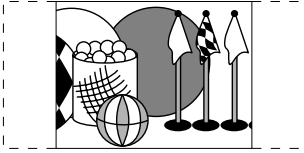

“16:9 On” specified
(aspect ratio 16:9)

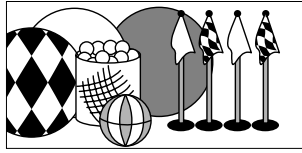

- 1 Press the MENU button, choose “16:9” on the “Camera Setup Functions” menu screen, and then press the ►/II button.
- 2 Choose “On”, and then press the ►/II button.
- 3 Press the MENU button to end the setting.

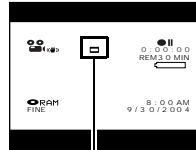
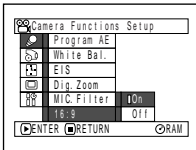

16:9 mode icon

When viewing playback on an ordinary TV screen later, specify “16:9 Off”: Recording with “16:9 On” specified will be played back on an ordinary TV with longer vertical direction of image.

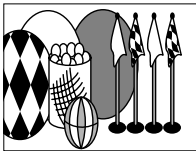

An image recorded with “16:9 On” specified will appear as follows:

Display on LCD monitor screen

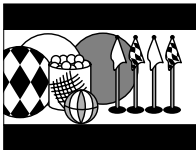

Display in viewfinder

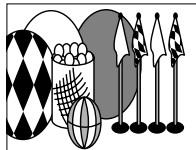

Note:

- The 16:9 setting will be kept even after the DVD video camera/recorder is turned off.
 - The DZ-MV550A does not have the 16:9 setting.
 - The 16:9 setting can be used when recording movies on DVD-RAM disc: It is not compatible with still recording, recording of external input or recording on DVD-R disc.
 - Images recorded with "16:9 On" (aspect ratio 16:9) specified will be played back with the setting used during recording regardless of the 16:9 setting then being used.
 - The characters of dates and titles will be longer in the vertical direction on a wide-screen TV and on the LCD monitor of this DVD video camera/recorder.
 - When "16:9 On" is specified, black bands will appear across the top and bottom of LCD monitor screen (except on menu screen, Navigation screen, or playback image recorded with "16:9 Off" specified).
 - The 16:9 setting is not compatible with ID-1/ID-2*.
 - To view images recorded at 16:9 setting, switch the aspect ratio of your TV: See TV instruction manual for this switching.
 - When using a video selector (see "Terminology", P. 160), the TV may not automatically be switched to 16:9 mode.
- * This system records the aspect ratio (16:9, 4:3) information in void space between video signals.

Setting Up Record Functions

RAM R

SWITCHING MOVIE QUALITY (VIDEO MODE)

Choose the movie quality from “XTRA” (only with DVD-RAM disc), “FINE”, “STD” and “LPCM” (only with DVD-R disc).

It is recommended that you record critical subjects in the “XTRA” or “FINE” when you are using a DVD-RAM disc, or in the “FINE” with a DVD-R disc. (P.29)

1 Press the MENU button, choose “VIDEO Mode” on the “Record Functions Setup” menu screen, and then press the ►/II button.

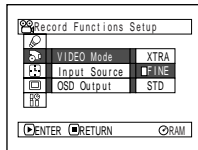

2 Choose the desired quality mode, and then press the ►/II button.

3 Press the MENU button to end the setting.

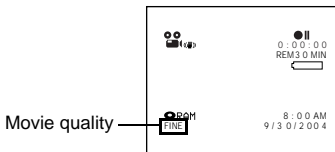

Note:

- The movie quality setting will be stored in memory even when the DVD video camera/recorder is turned off.
- The “VIDEO Mode” setting will not change even if the DVD-RAM disc is replaced with a DVD-R disc, or vice versa. However, the setting will switch to “FINE” in the following cases:
 - When the mode is set to “XTRA” with a DVD-RAM disc inserted and then the disc is replaced with a DVD-R disc
 - When the mode is set to “LPCM” with a DVD-R disc inserted and the disc is replaced with a DVD-RAM disc
- When using DVD-R disc, you cannot switch the movie quality while recording on the disc: The DVD video camera/recorder will be automatically set to the movie quality first used with the disc for recording.
- The movie quality setting is effective only during movie recording: The setting will not be displayed during recording of stills.

Block-like noise may appear in recorded image, or the outline of subject image is distorted under the recording conditions listed below: Pan the DVD video camera/recorder as slowly as possible. (Block noise is likely to appear in the “STD”):

- If there is a complicated pattern in background (as in following figure on left)
- If the DVD video camera/recorder is moved excessively or quickly
- If subject is moving rapidly even when the DVD video camera/recorder is not moving

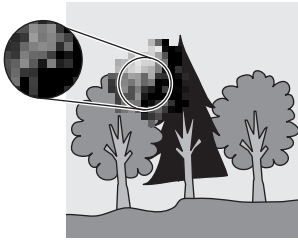

(Image when block-like noise occurs)



(Image without block-like noise)

CARD

SWITCHING QUALITY OF STILL IMAGE (QUALITY)

You can switch the still recording quality only when using card.

It is recommended that you use “FINE” when recording vital images. (P. 30 “SIZE AND QUALITY OF PHOTOS”)

- 1 Press the MENU button, choose “Quality” on the “Record Functions Setup” menu screen, and then press the ►/II button.

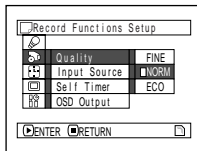

- 3 Press the MENU button to end the setting.

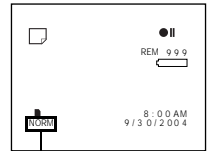

Still recording quality

- 2 Choose the option you want, and then press the ►/II button.

Note:

The still quality setting will be stored in memory even when the DVD video camera/recorder is turned off.

RECEIVING IMAGE FROM ANOTHER DEVICE (INPUT SOURCE)

If you wish to input an image from another device to this DVD video camera/recorder, you must first switch the setting on the DVD video camera/recorder.

Refer to the explanation starting from page 83 on how to connect the DVD video camera/recorder to other devices or record images input from them.

Setting	Content	On-screen display
CAMERA	Usually select this option.	No display
LINE	To input image from another device	L IN
S LINE*	To input S-VIDEO signal from another device	S IN

* Displayed on DZ-MV580A only.

1 Press the MENU button, choose "Input Source" on the "Record Functions Setup" menu screen, and then press the ►/II button.

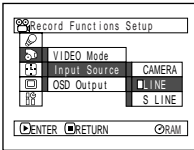

2 Choose "LINE", and then press the ►/II button.

3 Press the MENU button to end the setting.

Note:
The "Input Source" setting will return to "CAMERA" whenever the DVD video camera/recorder is turned off.

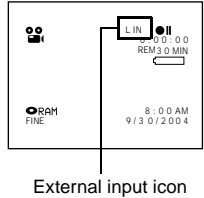

SWITCHING EXTERNAL INPUT RECORDING METHOD (PHOTO INPUT)

When "Input Source: LINE or S LINE" is specified, you can record stills of externally input images on either a DVD-RAM disc or a card. The DVD video camera/recorder can record an external image with little movement by specifying "Frame", but "Field" is recommended for recording image with movement.

Recording format	Details of setting	On-screen display
Frame	Does not suit recording of frequently moving video subjects, despite high image quality. Frame suits recording of less moving video.	
Field	Suitable for recording of frequently moving video subjects.	

1 Press the MENU button, choose "PHOTO Input" on the "Record Functions Setup" menu screen, and then press the ►/II button.

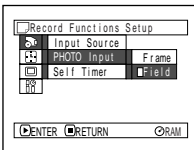

2 Select the desired option and then press the ►/II button.

3 Press the MENU button to end the setting.

Still external input icon

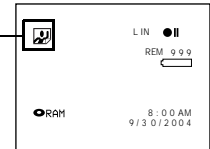

Note:

- The PHOTO Input setting can be confirmed using the on-screen information.
- The PHOTO Input setting will be stored in memory even when the DVD video camera/recorder is turned off.
- Refer to "Recording (Dubbing) Images", P. 83 to see how to connect the DVD video camera/recorder to another device.

SELF-TIMER

You can record photos using the self-timer function, as with ordinary cameras.

The self-timer function is valid only when recording photos (stills).

1 Press the MENU button, choose “Self Timer” on the “Record Functions Setup” menu screen, and then press the ►/|| button.

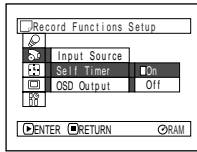

2 Select “On”, and then press the ►/|| button.

The self-timer will be set.

3 Press the MENU button to end the setting.

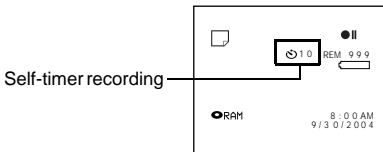

4 Press the REC button.

The recording indicator at the front of DVD video camera/recorder will blink. The self-timer indicator will start to count down, and recording will commence approximately 10 seconds later.

Note:

- You can also check that self-timer has been set by reviewing the on-screen information.
- To release the self-timer mode, choose “Off” on the menu screen or turn DVD video camera/recorder off.
- To suspend self-timer, press the REC button again before recording starts, or press the ■ button.

SETTING ON-SCREEN DISPLAY OUTPUT ON OR OFF (OSD OUTPUT)

If you connect this DVD video camera/recorder to a TV to view images on TV screen, you can switch off the on-screen information (displayed in the viewfinder or on the LCD screen) from the TV screen.

- 1** Press the MENU button, choose "OSD output" on the "Record Functions Setup" menu screen, and then press the ►/II button.

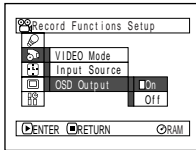

- 2** Choose "On" or "Off", and press the ►/II button.

- 3** Press the MENU button to end the setting.

Note:

- The "OSD Output" setting will be stored in memory even when the DVD video camera/recorder is turned off.
- Even if "Off" is chosen, the on-screen information will appear during playback. See page 62 for playback on-screen information display.
- Even after the on-screen information is removed from the TV screen, it will still appear in the viewfinder or on the LCD screen.
- The on-screen display output functions only when the input selection is set to camera: It cannot be set during external input.

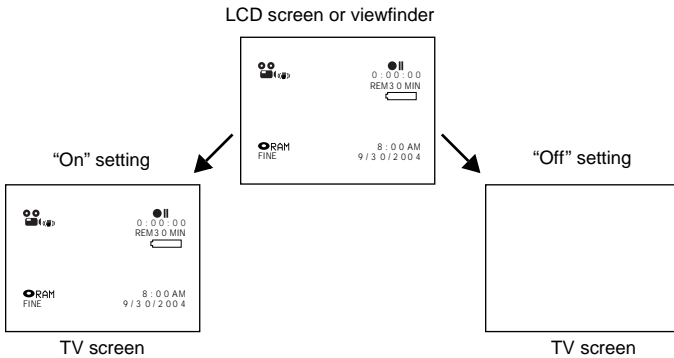

LCD Setup

SETTING BRIGHTNESS OF LCD SCREEN (BRIGHTNESS)

1 Press the MENU button, choose "Brightness" on the "LCD Setup" menu screen, and then press the ►/II button.

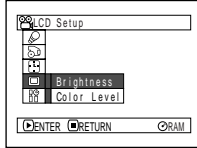

The brightness adjustment bar will appear on the screen.

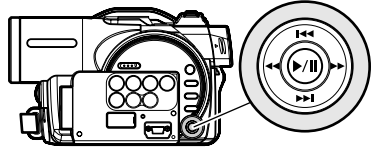

Tilt up/down and to left/right to select, and then press ►/II to designate.

2 Use the joystick for adjustment.

Tilt to left : The screen becomes dimmer
Tilt to right : The screen becomes brighter

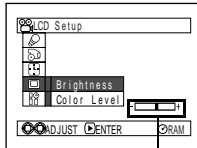

Brightness adjustment bar

3 Press the MENU button to end the setting.

Note:

The brightness setting will be stored in memory even after the DVD video camera/recorder is turned off.

SETTING COLOR DENSITY OF LCD SCREEN (COLOR LEVEL)

1 Choose "Color Level" on the "LCD Setup" menu screen, and then press the ►/II button.

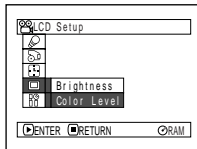

The color density adjustment bar will appear on the screen.

3 Press the MENU button.

Note:

- The color setting will be stored in memory even after the DVD video camera/recorder is turned off.
- Even if the brightness or density of LCD monitor screen is changed, the brightness or density of the recorded image itself will not change.

2 Use the joystick for adjustment.

Tilt to left : For lighter color
Tilt to right : For denser color

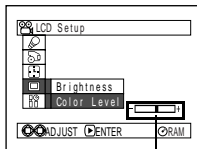

Color density adjustment bar

Initial Settings

SWITCHING OPERATING SOUND ON OR OFF (BEEP)

Setting	Content
On	Beep is heard when the power switch is changed over, the REC button is pressed, etc.
Off	No beep is heard.

- 1 Press the MENU button, choose "Beep" on the "Initial Setup" menu screen, and then press the ►/|| button.

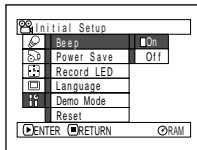

- 2 Select "On" or "Off", and then press the ►/|| button.
- 3 Press the MENU button to end the setting.

Note:

The "Beep" setting will be stored in memory even when the DVD video camera/recorder is turned off.

TURNING DVD VIDEO CAMERA/RECORDER OFF AUTOMATICALLY (POWER SAVE)

Setting	Content
On	To engage power save. If the DVD video camera/recorder is left in the recording pause status without being operated for 5 minutes, it will automatically turn off to prevent the battery from discharging needlessly.
Off	To cancel power save

- 1 Press the MENU button, choose "Power Save" on the "Initial Setup" menu screen, and then press the ►/|| button.

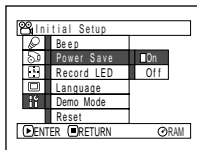

- 2 Select "On" or "Off", and then press the ►/|| button.
- 3 Press the MENU button to end the setting.

Note:

- To turn the DVD video camera/recorder on again from automatic off activated by the power save function, set the power switch to "POWER OFF", and then set it to VIDEO, "PHOTO" or "CARD PHOTO"
- The Power Save setting will not appear in the on-screen information display.
- The Power Save setting will be stored in memory even when the DVD video camera/recorder is turned off.

TURNING RECORD LED ON OR OFF (RECORD LED)

You can switch off the recording indicator on the front of DVD video camera/recorder even during recording.

Setting	Content
On	The recording indicator will light red to show that the DVD video camera/recorder is recording.
Off	The recording indicator will not light even during recording.

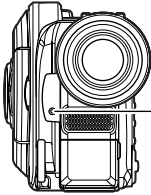

Recording indicator

1 Press the MENU button, choose “Record LED” on the “Initial Setup” menu screen, and then press the ►/II button.

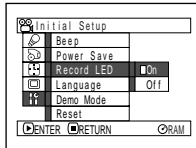

2 Select “On” or “Off”, and then press the ►/II button.

3 Press the MENU button to end the setting.

Note:

- The Record LED setting will not appear in the on-screen information display.
- The Record LED setting will be stored in memory even when the DVD video camera/recorder is turned off.
- Specify “Record LED: Off” when recording a subject behind a glass or water tank that reflects light: The reflected light of the recording indicator will not be recorded.
- Even if “Record LED Off” is specified, the recording indicator will light while the self-timer is counting down.

CHANGING DISPLAY LANGUAGE (LANGUAGE)

You can change the language used to display the menu and information. The following shows that English is changed to French.

1 Press the MENU button, choose “Language” on the “Initial Setup” menu screen, and then press the ►/II button.

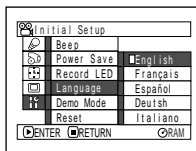

3 Press the MENU button to end the setting.

Note:

- The language setting will be stored in memory even when the DVD video camera/recorder is turned off.

2 Select “Français”, and then press the ►/II button.

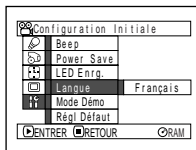

RESETTING MENU SETTINGS TO DEFAULTS (RESET)

You can restore menu settings to defaults (initial settings at the factory (P. 181)). (Note, however, that the date/time will not be reset.)

- 1 Press the MENU button, choose "Reset" on the "Initial Setup" menu screen, and then press the ►/|| button.

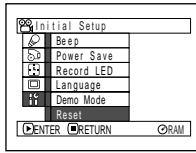

The screen for verifying reset will appear.

- 2 If you are sure that you wish to reset, use the joystick to choose "YES", and then press the ►/|| button.

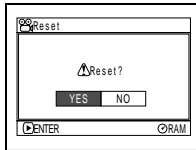

The setting items have now been reset to defaults.

- 3 Press the MENU button to end the setting.

Note:



To cancel resetting midway, choose "NO" on the screen for verification in step 2 or press the ■ button.

Using Disc Navigation

STARTING OR TERMINATING DISC NAVIGATION

Disc Navigation is a tool for editing scenes recorded on this DVD video camera/recorder. Here is an explanation on “scene” and “program”, so that you will be able to make most use of Disc Navigation function.
The screens in this instruction manual are basically those that will appear when DVD-RAM disc is used: Some items will not appear when DVD-R disc or card is used, but the operation is the same.

Before You Begin

- Turn the DVD video camera/recorder on (P.48).
- When using disc: Set the power switch to “ VIDEO” or “ PHOTO”.
- When using card: Set the power switch to “ PHOTO”.

- 1** Press the DISC NAVIGATION button.

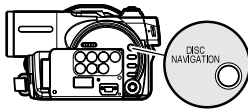

The Disc Navigation screen (shown on page 106) will appear.

- 2** Press the DISC NAVIGATION button.

Disc Navigation will be terminated and the DVD video camera/recorder will enter the recording pause status.
You can also press the  button to end Disc Navigation.

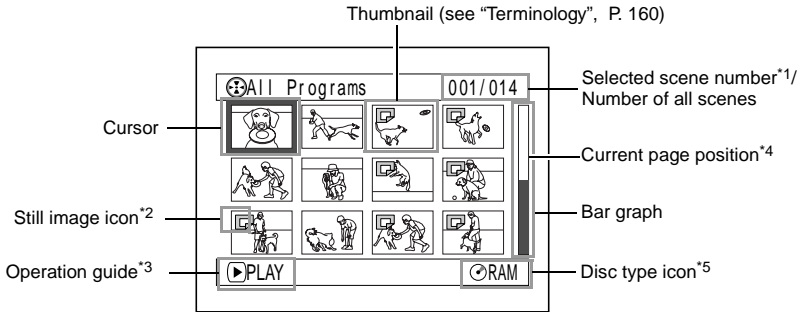

- *1 Scene number refers to display number on thumbnail display screen.
- *2 No still icon will appear for card.
- *3 The operation guide will vary depending on the operation status of DVD video camera/recorder.
- *4 Appears when 13scenes or more have been recorded.
- *5 "◉R" appears for DVD-R disc. "◻" will appear for card.

Note:

- The background color of screen allows you to identify whether disc or card is used on this DVD video camera/recorder.
 - Purple: When disc is used.
 - Green: When card is used.
- Pressing the DISPLAY button will display the recording date/time of the scene on which the cursor is placed in the space for operating guide. Pressing DISPLAY again will display the operating guide.
- If no disc or card is inserted, the Disc navigation screen cannot be displayed even by pressing the DISC NAVIGATION button.
- Each time Disc Navigation is started with a DVD-R disc inserted, message "Creating Thumbnail ..." will appear. After the message appears, the Disc Navigation screen will appear.
- If the following disc or card is inserted, the Disc Navigation screen will appear or some message will be displayed:
 - Write-protected disc
 - Locked card
 - Finalized DVD-R disc
- Do not leave the disc navigation screen displayed on TV to which the DVD video camera/recorder is connected: Doing so could damage the TV screen, possibly by burning.

PLAYING BACK FROM DISC NAVIGATION SCREEN

1 Press the DISC NAVIGATION button.

3 Press the ►/|| button.

2 Use the joystick to select the desired scene.

The selected scene will be framed: This is called a “cursor”.

Playback will start from the selected scene.

Note:

Tilting the joystick to left or right will move the cursor to the preceding or following scene.

Tilting it up or down will move to preceding or following page.

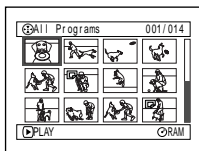

Up or Down
Left or Right

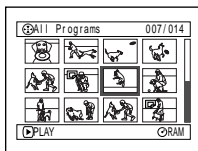

►/||

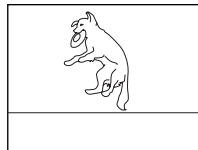

● When playback ends:

The DVD video camera/recorder will enter the playback pause status at the last image of last scene.

Pressing the ■ or DISC NAVIGATION button will restore the Disc Navigation screen.

When the playback pause status continues for as long as 5 minutes, the Disc Navigation screen will automatically be restored.

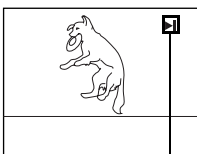

Playback pause

Note:

- Press the ►/|| button to temporarily stop playback. Pressing ►/|| again will start from that point.
- If you press the ►/|| button after playback of the last scene on disc finishes, playback will start again from the beginning of disc.
- Pressing the ■ button will always restore the Disc Navigation screen.
- When playing back a still with a large number of pixels on card, “Playback.” will appear, and it will take some time for the still to appear.

● Playing back stills

A still will be displayed for approx. 3 seconds.

When playing back stills on card, playback will stop after each still playback.

SELECTING MULTIPLE SCENES

- 1 Press the DISC NAVIGATION button.
- 2 Use the joystick to select the desired scene.
- 3 Press the SELECT button once:

The selected scene will be framed in red and yellow.

Repeat steps 2 and 3 to randomly select multiple scenes.

To cancel a selected scene, select the scene to be canceled, and then press the SELECT button.
To cancel all selected scenes, press the **■** button.

Note:

Although scenes can be randomly selected, playback will always start from the lowest scene number.

SELECTING CONSECUTIVE SCENES TOGETHER

- 1 Press the DISC NAVIGATION button.
- 2 Use the joystick to select the desired scene.

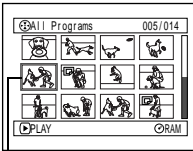

Yellow frame

- 3 Hold down the SELECT button for at least one second:

The selected scene will be doubly framed in yellow and blue.

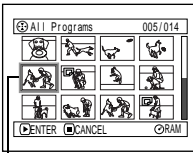

Double frames in yellow and blue

- 4 Use the joystick to select the last scene in the range you want, and then press the **▶/||** button:

The thumbnails of scenes in the specified range will be framed in red, and then selected.

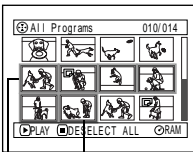

Red frame

When scenes up to this point are selected

Note:

- You can know the status of scenes from the colors of cursor and bargraph:

Cursor	Bar graph	Status of scenes
Yellow	Light blue	Current cursor position
Blue	Light blue	Range of scenes being selected
Red	Red	Scenes already selected

- Pressing the **▶/||** button after selecting scenes will play back only the selected scenes from the beginning of each.
- You can also select scenes in reverse from the last scene in the range.
- To release multiple selection, press the SELECT or **■** button after step 4.
- Up to 999 scenes can be selected for both disc and card.

FUNCTIONS AVAILABLE WITH DISC NAVIGATION

The Disc Navigation mode will allow a variety of further operations.

Available function	Disc or card used	Contents	Reference page
Deletion of scenes	RAM CARD	You can delete unnecessary scenes.	111
Editing of scenes	RAM	You can attach fade and skip to a scene, combine scenes, or divide one scene.	113 - 117
Scene information display	RAM R CARD	You can display information on one scene or multiple scenes, such as image quality, recording time, etc.	122
Changing title	RAM	You can change the title of play list or program.	124, 132
Creation of play list	RAM	You can create an original movie by changing the combination of scenes.	126
Disc or Card initialization	RAM CARD	You can initialize a DVD-RAM disc or card so that it can be used on this DVD video camera/recorder.	135
Copy from disc to card	RAM CARD	You can copy photos recorded on DVD-RAM disc to card.	118
Disc finalization	R	You can use this DVD video camera/recorder to finalize any DVD-R disc recorded on it so that the disc can be viewed on DVD player, etc.	137
Repeat play	RAM R	You can repeatedly play back programs and scenes.	138
Slide show	CARD	You can play back stills continuously.	139
Remaining display (Capacity)	RAM R CARD	The remaining recordable movie time or number of recordable stills is displayed.	134
Disc protection	RAM	You can protect the DVD-RAM disc to prevent deletion or editing by mistake.	134
Scene lock	CARD	You can lock any scene so that it will not be deleted by mistake: Essential scenes are thereby protected, and recording another still is possible.	119
DPOF setting	CARD	You can set the number of prints for each scene.	120

Note:

Editing functions (thumbnail, skip, fade) are original to this DVD video camera/recorder. When a disc edited on this DVD video camera/recorder is directly played back on a DVD-RAM recorder or read into PC, the editing results will not be reflected in the playback or reading. To reflect the editing results, connect both devices using the AV/S input/output cable and then perform recording (dubbing (P.86)).

UNDERSTANDING FLOW OF DISC NAVIGATION MENU

Press the MENU button on the Disc Navigation screen: The menu screens for Disc Navigation and menu screens for disc and card will appear.

See pages 87-89 and 106 for how to interpret the screen.

Refer to pages indicated for details of settings.

● When using DVD-RAM disc

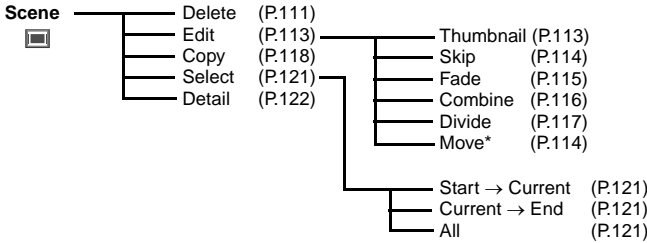

* Will appear when a play list is displayed.

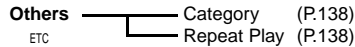
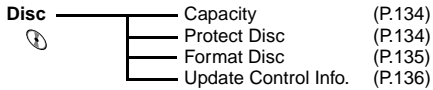
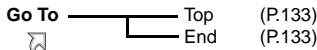
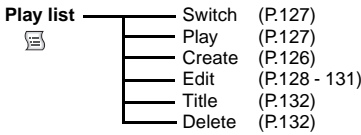

● When using DVD-R disc

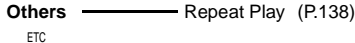
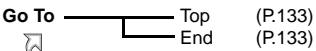
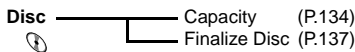
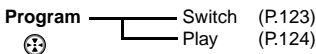
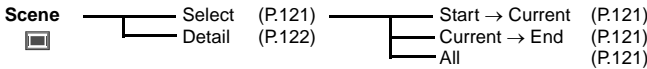

● When using card

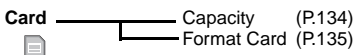
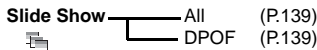
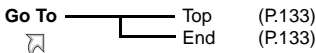
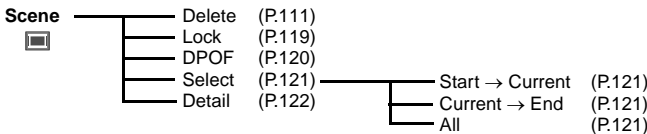

DELETING SCENES (DELETE)

You may want to delete unwanted scenes.

Scenes on DVD-R disc cannot be deleted, and menu item "Delete" will not appear with DVD-R disc.

1 Press the DISC NAVIGATION button.

2 Select the scene to be deleted.

3 Press the MENU button.

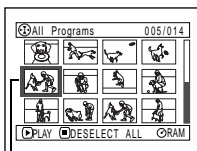

Scene to be deleted

4 Choose "Delete" on the "Scene" menu screen, and then press the ►/|| button.

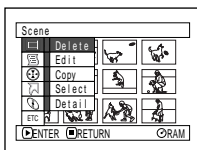

5 The "Delete Scene" screen will appear: If you are sure you want to delete the selected scene, press the ►/|| button.

If you want to change the scene to be deleted, you can change it on this screen.

6 The screen for verifying deletion will appear: Choose "YES", and then press the ►/|| button.

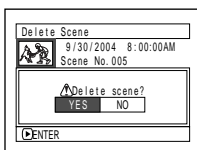

Choose "NO" to cancel deletion.

After Yes or No setting, the "Delete Scene" screen will be restored.

Repeat steps 5 and 6 to delete other scenes.

7 Press the ■ button to quit.

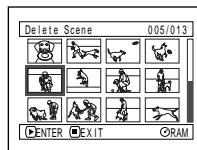

Note:

- If you point the cursor at the scene to be deleted on "All Programs" screen, and then press the DELETE button on remote control, the screen in step 5 will appear.
- To delete an unwanted part of a scene on DVD-RAM disc, divide the scene first, and then delete the unnecessary part (See page 117).
- If you delete all data on disc or card, initializing the disc or card will be recommended (See page 135).
- If the time of deleted scenes (stills) is quite short, the remaining free space of disc may not increase in the disc or card remaining indicator.
- The locked scenes on card cannot be deleted (See page 119).
- If even one play list has been created, message "Same scenes on PlayList will be deleted. Delete scenes?" will appear before deleting scene(s). This message will appear even if the scene(s) to be deleted is not used in the corresponding play list. In this case, choose "YES" and then press the ►/|| button.

● Editing using submenu

Press the MENU button before pressing the ►/|| button in step 5 (See page 111): The submenu will appear.

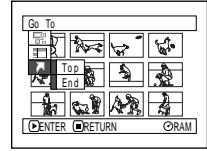
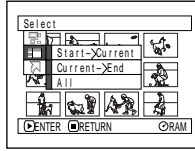
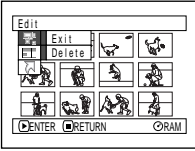

- Edit ——— Exit..... To restore the Disc Navigation screen
- Delete To delete selected scenes
- Select ——— Start→Current... To select scenes from the start to the one that the cursor is on at the moment
- Current→End... To select scenes from the scene the cursor is on to the end
- All To select all scenes
- Go To ——— Top To move the cursor to the first scene
- End..... To move the cursor to the last scene

Pressing the ■ button will restore the screen in step 5.

Note:

Although the submenu screen will appear for each setting, some menu items may not appear, depending on the setting.

CHANGING IMAGES FOR THUMBNAILS (EDIT - THUMBNAIL)

Normally, the first image of the recorded scene is displayed as a thumbnail: You can choose another image of the scene for thumbnail. If you set a vivid image to thumbnail, you can know what you recorded from a glance at the Disc Navigation screen.

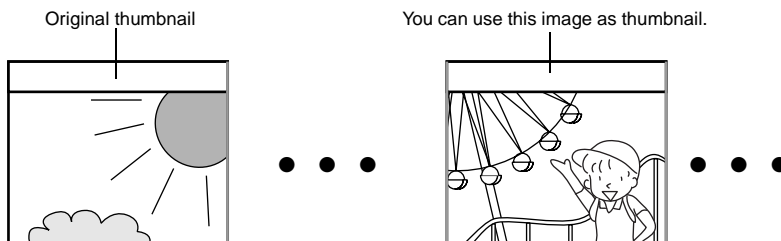

- 1 Press the DISC NAVIGATION button.
- 2 Select the thumbnail of the scene to be changed.
- 3 Press the MENU button.
- 4 Choose "Scene", "Edit", "Thumbnail", and then press the ►/|| button.

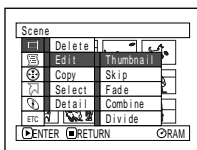

- 5 The "Change Thumbnail" screen will appear: If you are sure you want to change the thumbnail of the selected scene, press the ►/|| button: The selected scene will be played back.

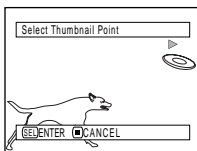

If you want to change the scene whose thumbnail is to be changed, you can change it on this screen.

- 6 When the image you want to use as the thumbnail of the scene appears, press the SELECT button.

You can use this image as thumbnail.

- 7 The screen for verifying switching of thumbnail will appear: Choose "YES", and then press the ►/|| button.

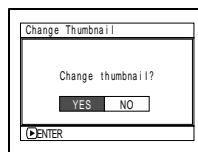

Choose "NO" to cancel switching of thumbnail. After Yes or No setting, the "Change Thumbnail" screen will be restored. Repeat steps 5-7 to change the other scenes.

- 8 Press the ■ button to quit.

Note:

- If you press the MENU button before pressing the ►/|| button in step 5, the submenu screen will appear. (See page 112)
- A thumbnail of still cannot be changed.
- Since the scene to which skipping is set cannot be played back, you will not be able to change its thumbnail: Release the skip setting of the scene to change the thumbnail.

PLAYING BACK BY SKIPPING SCENES (EDIT - SKIP)

You can specify “Skip” for scenes you do not want to play back: The selected scenes will be skipped.

1 Press the DISC NAVIGATION button.

2 Select the scene to be skipped.

3 Press the MENU button.

4 Choose “Scene”, “Edit”, “Skip”, and then press the ►/|| button.

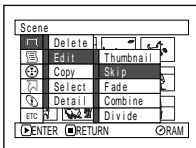

5 The “Set Skip” screen will appear: If you are sure you want to skip the selected scene, press the ►/|| button.

If you want to change the scene to be skipped, you can change it on this screen.

After skip setting, the “Set Skip” screen will be restored.

Repeat step 5 to set skipping of other scenes.

6 Press the ■ button to quit.

A skip icon “⏮” will appear in the thumbnail of any scene for which skipping has been set.

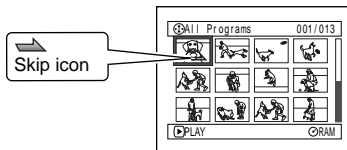

● Releasing Skip

Perform the same procedure as setting skip: The skip mark will disappear and skipping of the scene will be released.

Note:

- Multiple scenes can be selected for skipping (P.108).
- If you press the MENU button before pressing the ►/|| button in step 5, the submenu screen will appear (P.112).

ARRANGING ORDER OF SCENES (EDIT - MOVE)

You can arrange scenes within a play list by moving them to desired positions. (P.131) Create a play list first, and then arrange the scenes [“Creating New Play List (Create)”, P.126].

DIRECTING SCENES EFFECTIVELY (EDIT - FADE)

You can add fading to the beginning and/or end of scene.
There are three types of special effects:

Fade Out

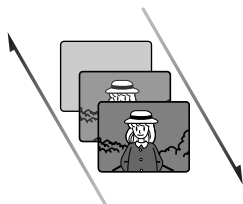

Fade In

Fade Out

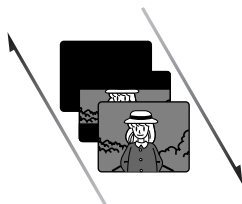

Fade In

Fade Out

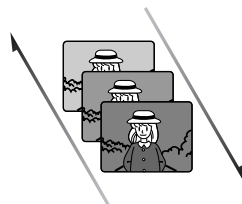

Fade In

White:

Fades in from white screen
Fades out to white screen

Wipe:

Fades in from black screen to vertical direction of screen
Fades out from vertical direction of screen to black screen

B/W:

Fades in from Black and White screen to color screen
Fades out from color screen to Black and White screen

1 Press the DISC NAVIGATION button.

2 Select the scene for adding special effects.

3 Press the MENU button.

4 Choose, "Scene", "Edit", "Fade" and then press the ►/|| button.

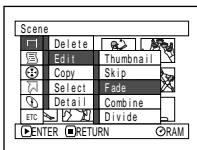

5 The "Fade Set" screen will appear: If you are sure you want to add the fade effect to the scene, press the ►/|| button.

If you want to change the scene to which fade is added, you can change it on this screen.

6 Select the special effects for "IN" and/or "OUT", choose "Enter", and then press the ►/|| button.

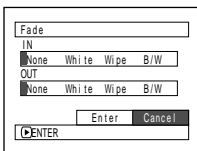

To cancel setting, choose "Cancel".

After setting, the "Fade Set" screen will be restored.

Repeat steps 5 and 6 to add fade to other scenes.

7 Press the ■ button to quit.

The "▲" and/or "▼" icon(s) will appear in the scenes for which fade in and/or fade out have been set.

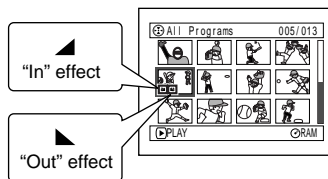

COMBINING MULTIPLE SCENES (EDIT - COMBINE)

If you have recorded numerous short scenes, combining them will be facilitated by the use of Disc Navigation.

Be sure to select consecutive multiple scenes. Combining scenes is possible only when “Category: All” is specified. (P.138) Stills cannot be combined.

1 Press the DISC NAVIGATION button.

2 Select the consecutive multiple scenes to be combined.

3 Press the MENU button.

4 Choose, “Scene”, “Edit”, “Combine” and then press the ►/|| button.

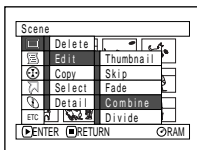

5 The “Combine Scenes” screen will appear: If you are sure you want to combine the selected scenes, press the ►/|| button.

If you want to change the scenes to be combined, you can change them on this screen.

6 The screen for verifying combination will appear: Choose “YES”, and then press the ►/|| button.

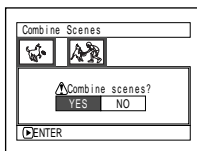

The two images appearing on the verification screen are those of the first and last scenes to be combined.

Choose “NO” to cancel combination.

After Yes or No setting, the “Combine Scenes” screen will be restored.

The thumbnail of the first scene will appear in the combined scene.

Repeat steps 5 and 6 to combine other scenes.

7 Press the ■ button to quit.

Note:

Scenes in different programs (different recording dates) cannot be combined: Create a play list first, and then combine such scenes on the play list.

DIVIDING MOVIES (EDIT - DIVIDE)

You can divide a scene into two parts.

To delete unnecessary portion of scene, first divide the scene, and then delete the unnecessary portion.

1 Press the DISC NAVIGATION button.

2 Select the scene to be divided.

3 Press the MENU button.

4 Choose, "Scene", "Edit", "Divide" and then press the ►/|| button.

5 The "Divide Scene" screen will appear: If you are sure you want to divide the selected scene, press the ►/|| button: The selected scene will be played back.

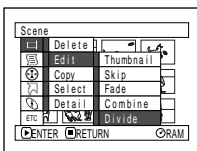

If you want to change the scene to be divided, you can change it on this screen. The selected scene will be played back.

6 When you reach the point where you want to divide the scene, press the SELECT button.

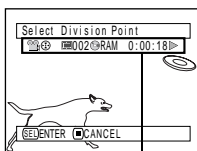

Status bar of scene being played back

7 The screen for verifying division will appear: Choose "YES", and then press the ►/|| button.

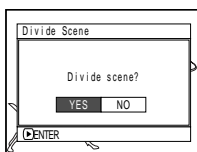

Choose "NO" to cancel division.

After division, the "Divide Scene" screen will be restored.

Repeat steps 5-7 to divide another scene.

8 Press the ■ button to quit.

Note:

- If you press the MENU button before pressing the ►/|| button in step 5, the submenu screen will appear. (P.112)
- The status bar of scene being played back can be switched off or on by pressing the DISPLAY button.
- Search and frame advance are useful when designating division points.
- If a special effect has been added to the original scene, the "IN" effect will be added to the first half of scene, and the "OUT" effect, to the latter half.
- The division point may drift before or after the designated point by approximately 0.5 seconds.
- Since a scene with a skip set cannot be played back, no division point can be specified: Release the skip for the scene before dividing it.
- If the division point is at a still, a message will appear, but no division will be made.
- If the division point is at the start or end of a scene, a message will appear, but no division will be made.
- A movie scene whose recording time is 0.5 seconds or less cannot be divided.
- If free space available on disc is insufficient, division will not be possible: Delete unnecessary scenes.
- Pressing the ■ button on the screen for verification will restore the thumbnail display screen.

COPYING STILLS ON DVD-RAM DISC TO CARD (COPY)

1 Set the power switch to “ VIDEO” or “ PHOTO”.

2 Press the DISC NAVIGATION button.

3 Select the still to be copied.

4 Press the MENU button.

5 Choose “Copy” on the “Scene” menu screen, and then press the /|| button.

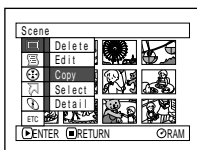

6 The “Copy to card” screen will appear: If you are sure you want to copy the selected still, press the /|| button.

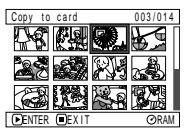

If you want to change the still to be copied, you can change it on this screen.

7 The screen for verifying copy will appear: Choose “YES”, and then press the /|| button.

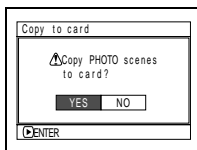

Choose “NO” to cancel copy.

After Yes or No setting, the “Copy to card” screen will be restored.

Repeat steps 6 and 7 to copy other stills to card.

8 Press the button to quit.

Note:

- No movie can be copied.
- If you press the MENU button before pressing the /|| button in step 6, the submenu screen will appear. (P.112)
- See “Category” (P.138) to check the stills recorded on DVD-RAM disc.
- You can also select multiple scenes (P.108).
- Even if all scenes, including movies, are selected to be copied, only stills will be copied.
- Data on card cannot be copied to disc.
- The quality of still copied from disc to card will be the same as when you recorded still on disc.
- Stills recorded on a device other than this DVD video camera/recorder may not be copied normally.

LOCKING SCENES ON CARD (LOCK)

You can lock each photo recorded on card so that it will not be deleted or edited by mistake.

- 1 Set the power switch to “CARD PHOTO”.
- 2 Press the DISC NAVIGATION button.
- 3 Select the scene to be locked.
- 4 Press the MENU button.
- 5 Choose “Lock” on the “Scene” menu screen, and then press the ►/|| button.
- 6 The “Lock Set” screen will appear: If you are sure you want to lock the selected scene, press the ►/|| button.

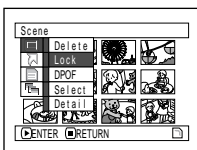

● To unlock the scene:

Select the locked scene, and then use the same procedure as above to unlock the scene: The lock icon will disappear and locking will be released.

Note:

- If you press the MENU button before pressing the ►/|| button in step 6, the submenu screen will appear. (P.112)
- You can also select multiple scenes (P.108).
- When initializing the card, the locked scenes will also be deleted.

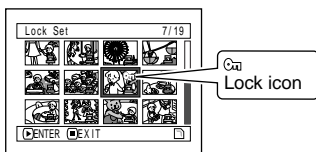

If you want to change the scene to be locked, you can change it on this screen.

After setting, the “Lock Set” screen will be restored.

Repeat step 6 to lock another scene.

- 7 Press the ■ button to quit.

The lock icon “Ca” will appear on any scene for which lock has been set.

DESIGNATING SCENES TO BE PRINTED (DPOF)

You can use DPOF to set print information, including selection of the scenes to be printed, so that you will be able to use it on a system conforming to DPOF.

Note:

DPOF stands for digital print order format. DPOF is used to ask a print lab to print recorded stills.

- 1 Set the power switch to “CARD PHOTO”.
- 2 Press the DISC NAVIGATION button.
- 3 Select the scene to which DPOF is to be set.

4 Press the MENU button.

5 Choose “DPOF” on the “Scene” menu screen, and then press the ►/|| button.

6 The “DPOF Set” screen will appear: If you are sure you want to set DPOF to the scene, press the ►/|| button.

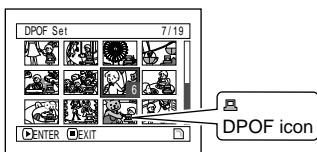
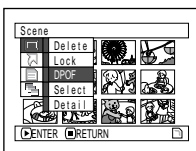

If you want to change the scene to which DPOF is set, you can change it on this screen.

7 Use joystick to specify the number of prints, and then press the ►/|| button:

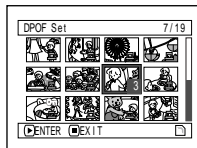

Tilt it up or to right: To increase the number one by one.

Tilt it down or to left: To decrease the number one by one.

Pressing the ►/|| button will display the DPOF icon on the selected scene(s).

After setting, the “DPOF Set” screen will be restored.

Repeat steps 6 and 7 to set DPOF to another still.

8 Press the ■ button to quit.

The DPOF icon “☐” will appear on any scene for which DPOF has been set.

Note:

- If you press the MENU button before pressing the ►/|| button in step 6, the submenu screen will appear. (P.112)
- You can also select multiple photos (P.108).
- If you specify the number after selecting multiple stills, the same specified number will be set to all those stills.
- Up to 99 prints can be set for one scene. The maximum number of settable prints on one card is 999.
- This DVD video camera/recorder may not recognize DPOF that has been set on another device: Always set the DPOF on this DVD video camera/recorder.

SELECTING SCENES USING MENU SCREEN (SELECT)

You can use this “Select” function to select consecutive scenes at one time. This function is useful when there are numerous scenes.

- 1 Press the DISC NAVIGATION button.
- 2 Select the first scene to be selected.
- 3 Press the MENU button.
- 4 Choose “Select” on the “Scene” menu screen.
- 5 Choose “Start → Current”, “Current → End” or “All” and then press the ►/|| button.

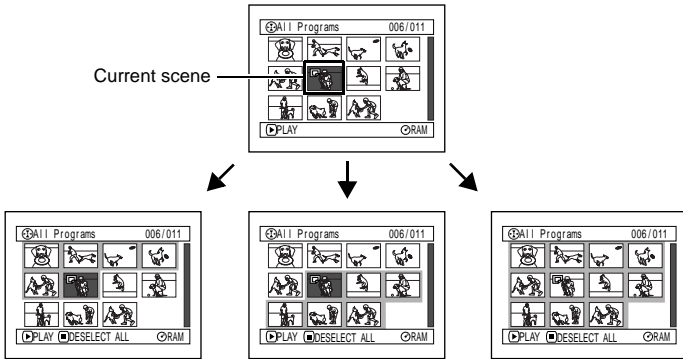
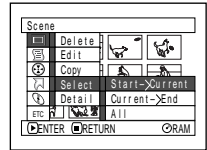

“Start → Current” is specified:
The scenes from the first to current will be selected.

“Current → End” is specified:
The scenes from the current to end will be selected.

“All” is specified:
All scenes from the first to end will be selected

● Deselecting selected scenes

Deselecting scenes one by one:

While you are displaying the “All Programs” screen on which scenes have been selected, choose the scene to be deselected and then press the SELECT button.

Deselecting all the selected scenes at once:

While you are displaying the “All Programs” screen on which scenes have been selected, press the **■** button.

Note:

Up to 999 scenes can be selected.

DISPLAYING INFORMATION USING MENU SCREEN (DETAIL)

You can display various information for a scene: the recording mode, recording date/time and length, special effects and movie quality mode.

- 1 Press the DISC NAVIGATION button.
- 2 Select the scene whose information you wish to know.
- 3 Press the MENU button.
- 4 Choose "Scene", "Detail", and then press the ►/|| button.

The detailed information on the scene will appear.

(When using disc)

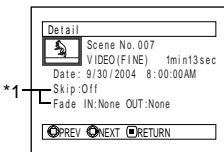

- *1 Not displayed with DVD-R disc.
- *2 May not appear if the loaded card does not comply with DCF.
- *3 Number of pixels on still in horizontal direction: This may not appear with a JPEG file that does not conform to this DVD video camera/recorder.

Note:

Tilting the joystick to right will display information on the following scene; tilting the joystick to left will display information on the preceding scene.

- 5 Press the ■ button to quit.

If you have selected multiple scenes, the information shown below will appear. Pressing the ■ button will restore the thumbnail display screen.

(When using disc)

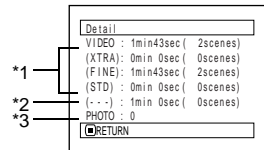

- *1 With DVD-R disc, the quality mode (FINE, STD or LPCM) selected first will appear.
- *2 Number of scenes whose quality mode is unknown: This will appear when the disc has a scene recorded on a device other than this DVD video camera/recorder, only if the disc has a scene whose mode is unknown. Also, this will not appear when a DVD-R disc is used.
- *3 This will not appear with DVD-R disc, since no still image can be recorded on it.

(When using card)

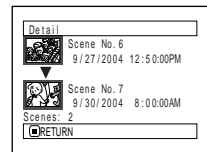

Note:

- If multiple scenes have been selected, the total recording time of the selected scenes (total number in case of stills) will appear.
- If a DVD-R disc recorded on a device other than this DVD video camera/recorder is inserted (already finalized), no scene information will appear.

Program

WHAT IS “PROGRAM”?

Program refers to an assembly of scenes recorded on the same date regardless of whether they are movie or still.

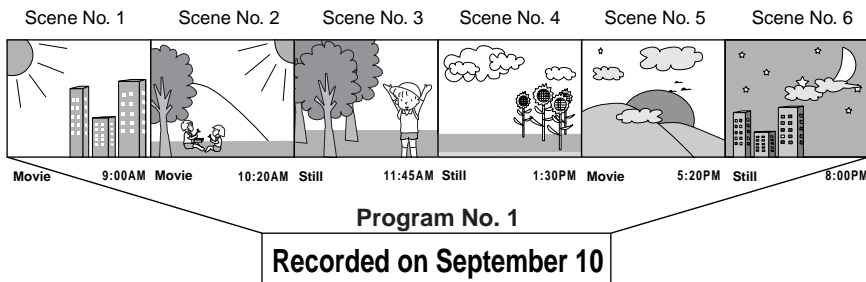

RAM R

SWITCHING TO THUMBNAIL DISPLAY OF SPECIFIC DATE (SWITCH)

Since the scenes recorded on this DVD video camera/recorder are collected as “programs” for each recording date, selecting a program will allow you to display only the scenes on a specific date.

1 Press the DISC NAVIGATION button.

2 Press the MENU button.

3 Choose “Switch” on the “Program” menu screen, and then press the ►/|| button.

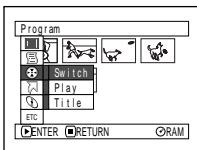

4 Select the program to be displayed, and then press the ►/|| button.

The Disc Navigation screen of the selected program will appear.

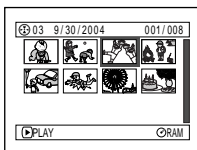
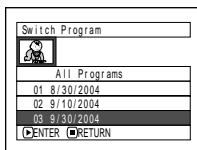

Note:

- Pressing the ■ button on the “Switch Program” screen will restore the Disc Navigation screen.
- The dates displayed on the program select screen will be in the Date Mode used when the first scenes of programs were recorded, and the date displays M/D/Y, D/M/Y and Y/M/D may be mixed.
- If a DVD-RAM or DVD-R disc recorded on another device is loaded in this DVD video camera/recorder, the program may not be a collection of recordings on the same date.

PLAYING BACK PROGRAM (PLAY)

You can play back only the selected program.

- 1 Press the DISC NAVIGATION button.
- 2 Press the MENU button.
- 3 Choose "Play" on the "Program" menu screen, and then press the ►/|| button.

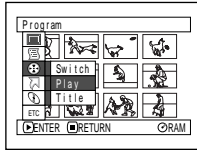

- 4 Select the program to be played back, and then press the ►/|| button.

Playback will start from the first scene of the selected program.

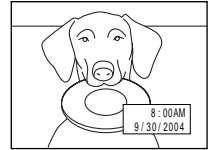
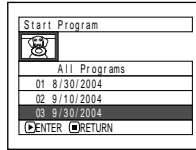

Note:

If "Repeat Play: On" is specified, the selected program will be repeatedly played back. (P.138 PLAYING BACK SCENES REPEATEDLY (REPEAT PLAY))

CHANGING TITLE OF PROGRAM (TITLE)

The recording date/time has initially been attached to any program. You can change the recording date/time to any desired title.

- 1 Press the DISC NAVIGATION button.
- 2 Press the MENU button.
- 3 Choose "Title" on the "Program" menu screen, and then press the ►/|| button.
- 4 Select the program whose title you want to change, and then press the ►/|| button.

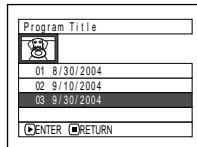

The screen for setting a title will appear.

- 5 Select a letter and then press the ►/|| button: The selected letter will be entered.

Repeat this procedure to create a title.

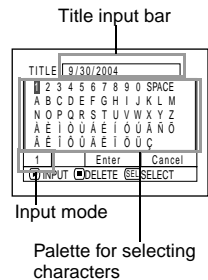

6 After entering the title, choose “Enter” and then press the ►/|| button.

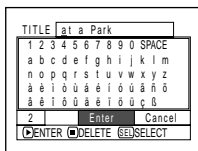

7 The screen for verifying the change in title will appear: Choose “YES”, and then press the ►/|| button.



Choose “NO” to cancel changing of the title.

After Yes or No setting, the Disc Navigation screen of the selected program will appear.

Note:

- If you wish to delete the letter for title, press the **■** button once: The input letter will be deleted. Holding down the **■** button will delete all letters in the TITLE column.
- You can also use the DELETE button on remote control to delete any input letters.
- Pressing the SELECT button on the title setting screen (in step 5) will change the cursor position from the title input bar to character select palette, input mode number, and then to “Cancel”.
- To cancel the setting of title, choose “NO” on the screen for verifying the entered title: The screen for verifying cancellation of title setting will appear. To cancel title setting, choose “YES”.
- If you press the **■** button on the screen for verifying change in title, the title setting screen will be restored.
- Double byte characters set on other devices may be displayed blank on this DVD video camera/recorder.
- Titles set on this DVD video camera/recorder may not be visible on other devices.

● Characters available for entering title

You can use the joystick to select characters from the “capital letter”, “small letter” and “symbol” input modes.

With step 5, select the input mode and then press the ►/|| button, or press the DISPLAY button.

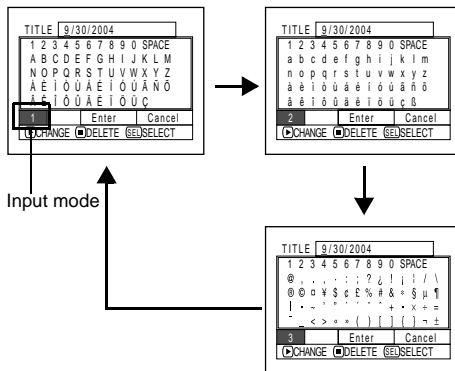

Play List

WHAT IS "PLAY LIST"?

You can create a play list on this DVD video camera/recorder by gathering your favorites from the recorded scenes.

Since the play list is not created by copying data, you will consume little of the disc capacity by making a play list. On the other hand, deleting scenes on play list will not increase the remaining disc capacity for recording.

Example:

Program 1 (recorded on September 27, 2004)



Program 2 (recorded on September 30, 2004)



Play list 1 created

Play list of up to No. 99 can be created, and up to 999 scenes can be included in each play list of No. 1 to No. 99.

CREATING NEW PLAY LIST (CREATE)

- 1 Press the DISC NAVIGATION button.
- 2 Select the scenes to be programmed in a play list.
- 3 Press the MENU button.
- 4 Choose "Create" on the "PlayList" menu screen, and then press the ►/II button.
- 5 The scene select screen will appear: If the selected scenes on the play list are the ones you want, press the ►/II button.

If you want to change the scenes with which you want to create a play list, you can change them on this screen.

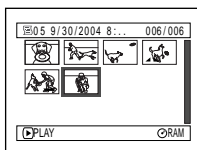
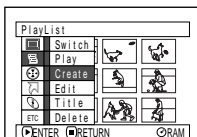

With the created play list, you can also add scenes recorded on another day or delete unnecessary scenes afterwards.

- 6 When creation of a play list is complete, the Disc Navigation screen will appear.

Note:

- You can also select multiple scenes (P.108).
- If the added scene had skip or fade setting, that information will also be added to the play list.
- The date/time when a play list was created will appear as the title for the play list. This title can later be changed (P.132).
- If free space available on disc is insufficient, creation of new play list may not be possible: Delete unnecessary scenes.
- Only the data on scenes is recorded on play list: **If you create or delete play lists, the original scenes in programs will not be erased.** Editing scenes on play list will not affect the scenes in programs.
- If you press the MENU button before pressing ►/II in step 5, the submenu will appear (see page 112).

SWITCHING TO DISPLAY OF EACH PLAY LIST (SWITCH)

Select the desired one of multiple play lists: The Disc Navigation screen of the selected play list will appear.

1 Press the DISC NAVIGATION button.

2 Press the MENU button.

3 Choose “Switch” on the “PlayList” menu screen, and then press the ►/|| button.

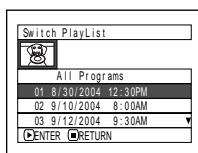
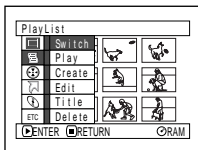

4 Use the “SwitchPlayList” screen to select the play list you wish to display, and then press the ►/|| button.

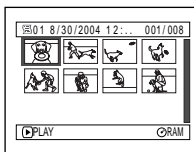

The Disc Navigation screen of the selected play list will be displayed.

Note:

To display the Disc Navigation screen showing all programs (all recorded scenes), choose “All Programs” on the “Switch PlayList” screen.

● Editing on play list

When making settings on play list, such as changing title, setting skip, adding fade, etc., use the same procedure for setting on program or scenes. Perform these settings, referring to the following reference pages:

Deleting scene,	P.111
Changing thumbnail,	P.113
Setting skip,	P.114
Adding fade,	P.115
Combining scenes,	P.116
Dividing a scene,	P.117
Copying to card	P.118
Changing title,	P.124, 132
Arranging order of scenes,	P.131

PLAYING BACK A PLAY LIST (PLAY)

1 Press the DISC NAVIGATION button.

2 Press the MENU button.

3 Choose “Play” on the “PlayList” menu screen, and then press the ►/|| button.

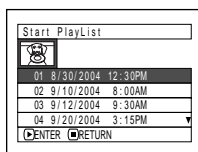
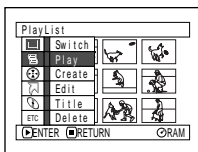

4 Use the “Start Playlist” screen to select the play list to be played back, and then press the ►/|| button.

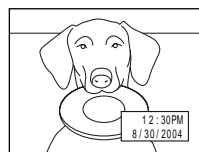

The selected play list will be played back from the first scene. To cancel playback midway, press the ■ button: The Disc navigation screen of the play list being played back will appear.

Note:

If “Repeat Play On” is specified, the play list will be repeatedly played back (see page 138).

ADDING SCENES TO PLAY LIST (EDITING PLAY LIST)

1 Press the DISC NAVIGATION button.

2 Press the MENU button.

3 Choose "Edit" on the "PlayList" menu screen, and then press the ►/|| button.

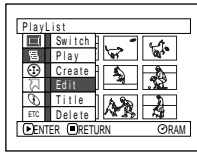

4 Use the play list select screen to select the play list to which you wish to add scenes, and then press the ►/|| button.

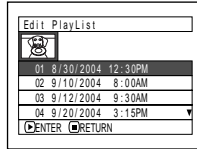

The scenes of the program that was displayed in step 1 will appear in the upper row, and the scenes of selected play list will appear in the lower row.

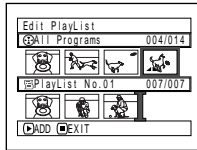

Note:

If the DISPLAY button is pressed when the thumbnails are displayed, the recording date/time of the selected scene will appear across the bottom of screen. Press DISPLAY button again to restore the previous screen.

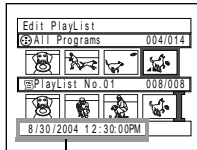

Recording date/time

5 Tilt the joystick down to move the cursor to the lower row, and tilt it to left or right to select the point where the scene is to be inserted.

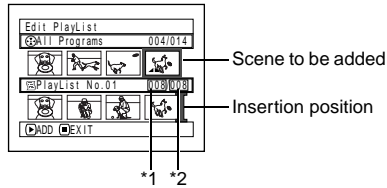

*1: Number of scene before insertion position cursor
*2: Number of all scenes on play list

6 Tilt the joystick up to move the cursor to the upper row, and tilt it to left or right to point the cursor to the scene to be added.

7 Press the ►/|| button to copy the scene.

After adding scenes is completed, the edited play list will appear.
Repeat steps 5–7 to add other scenes.

8 Press the ■ button: The screen for verifying exit will appear.

Note:

- The cursor shows the position where the scene is to be added.
- You can also select multiple scenes (P.108).
- Pressing ■ in the middle of adding scenes will display the screen for verifying an exit from "Edit PlayList". Choose "YES" to exit the edition of play list. Choosing "NO" will restore the "Edit PlayList" screen.
- If you press the MENU button in step 5 or 6, the submenu screen for editing play list will appear. You can also use this submenu to add scenes (see page 112).

DELETING SCENES FROM PLAY LIST (EDITING PLAY LIST)

1 Press the DISC NAVIGATION button.

2 Display the editing screen of the play list to be edited.

Perform steps 2–4 on page 128.

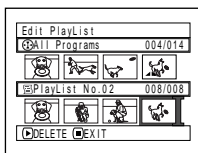

3 Move the cursor to the play list in lower row, and place the cursor on the scene to be deleted.

4 Press the ►/|| button.

Repeat steps 3 and 4 to delete other scenes.

5 Press the ■ button: The screen for verifying exit will appear.

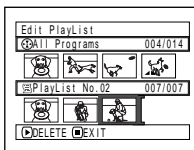

Note:

- You can also select multiple scenes (P.108).
- Place the cursor on scene to be deleted, and then press the DELETE button on remote control: You can also delete the scene on the play list.

ADDING SCENES USING SUBMENU FOR EDITING (EDITING PLAY LIST)

You can use the menu screen to add scenes to a play list.

1 Press the DISC NAVIGATION button.

2 Display the editing screen of the play list to be edited.

Perform steps 2–4 on page 128.

3 From the play list in lower row, select the position where you wish to insert a scene.

4 Select the scenes to be added from the upper row.

5 Press the MENU button.

6 Choose “Add”, and then press the ►/|| button.

Repeat steps 3–6 to add other scenes.

7 Press the ■ button to quit.

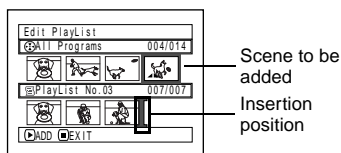
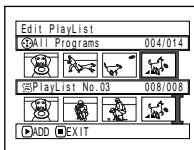
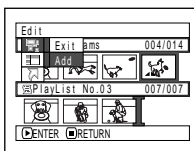

Note:

- The selected scenes will be added in the insertion position.
- You can also select multiple scenes (P.108).

DELETING SCENES USING SUBMENU FOR EDITING (EDITING PLAY LIST)

You can delete scenes from play list on the editing screen.

1 Press the DISC NAVIGATION button.

2 Display the editing screen of the play list to be edited.

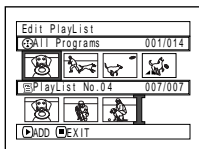

Perform steps 2–4 on page 128.

3 Move the cursor to the play list in lower row.

4 Select the scene to be deleted, and then press the MENU button.

5 Choose “Delete” on the “Edit” menu screen, and then press the ►/|| button.

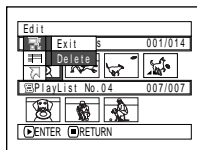

Repeat steps 3–5: other scenes can be deleted.

6 Press the ■ button: The screen for verifying exit will appear.

Note:

- If all scenes on play list are deleted, the play list itself will also be deleted.
- You can also select multiple scenes (P.108).

SELECTING SCENES USING SUBMENU FOR EDITING (EDITING PLAY LIST)

You can specify the range of scenes when adding or deleting consecutive multiple scenes to/from play list. This “Select” menu item is useful when selecting consecutive multiple scenes in items for adding or deleting scenes using menu on page 121.

1 Press the DISC NAVIGATION button.

2 Display the editing screen of the play list to be edited.



Perform steps 2–4 on page 128.

3 Specify the first scene of those you wish to select, and then press the MENU button.

4 Choose “Start → Current”, “Current → End”, “All” on the “Select” menu screen, and then press the ►/|| button.

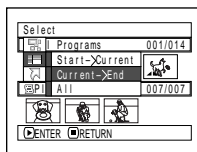

Note:

See page 121 for the status of scenes to be selected.

5 Press the ■ button: The screen for verifying exit will appear.

ARRANGING ORDER OF SCENES (MOVE)

You can move scenes only when “Category: All” is specified.

- 1 Press the DISC NAVIGATION button.
- 2 Press the MENU button.
- 3 Choose “Switch” on the “PlayList” menu screen, and then press the ►/|| button.

4 Select the scene to be moved.

5 Press the MENU button.

6 Choose “Scene”, “Edit”, “Move”, and then press the ►/|| button.

7 The “Move Scenes” screen will appear: If you are sure you want to move the scene, press the ►/|| button.

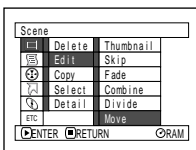

If you want to change the scene to be moved, you can change it on this screen.

8 Move the “I” mark to the position where you wish to move the scene, and then press the ►/|| button.

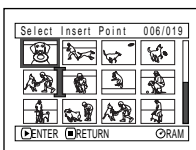

9 The screen for verifying move will appear: Choose “YES”, and then press the ►/|| button.

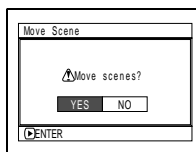

Choose “NO” to cancel move.

After Yes or No setting, the scene select screen will be restored.

Repeat steps 7–9 to move another scene.

10 Press the ■ button to quit.

Note:

- If you press the MENU button before pressing the ►/|| button in step 7, the submenu screen will appear.
- You can also move multiple scenes (P.108).
- Only scenes on play list can be moved.

CHANGING TITLE OF PLAY LIST (TITLE)

The play lists have serial numbers in the order you have created them, along with the created dates/times: You can change this title at any time.

- 1 Press the DISC NAVIGATION button.
- 2 Press the MENU button.
- 3 Choose "Title" on the "PlayList" menu screen, and then press the ►/|| button.
- 4 Use the "Playlist Title" screen to select the play list whose title you wish to change, and then press the ►/|| button.

See "Changing Title of Program (Title)" on page 124 for how to enter a title.

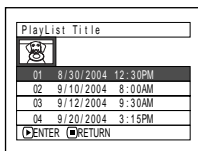

- 5 The screen for verifying exit will appear: Choose "YES" and then press the ►/|| button.



- 6 Press the ■ button to quit.

After changing the title, the Disc Navigation screen on the play list whose title has been changed will appear.

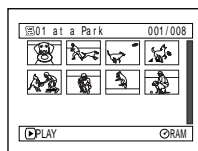

Note:

The registered title can be changed at any time using the same procedure.

DELETING PLAY LIST (DELETE)

- 1 Press the DISC NAVIGATION button.
- 2 Press the MENU button.
- 3 Choose "Delete" on the "PlayList" menu screen, and then press the ►/|| button.
- 4 Use the "Delete Playlist" screen to select the play list you wish to delete, and then press the ►/|| button.

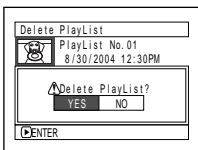
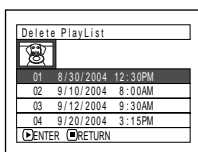

- 5 The screen for verifying deletion will appear: Choose "YES", and then press the ►/|| button.

Choose "NO" to cancel deletion.

After Yes or No setting, the Disc Navigation screen of all programs will be restored.

Note:

Even if you delete a play list, the original scenes stored on disc will not be deleted.

Go To

From the Disc Navigation screen, you can jump to the first scene or last scene.

TOP (END)

- 1 Press the DISC NAVIGATION button.
- 2 Press the MENU button.
- 3 Choose "Top" or "End" on the "Go To" menu screen, and then press the ►/|| button.

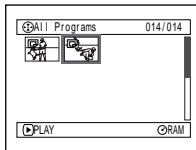
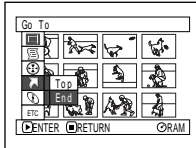

(When "End" is specified)

Disc or Card Management

RAM R CARD

VERIFYING REMAINING FREE SPACE ON DISC OR CARD (CAPACITY)

You can find out how long you will be able to record on one side of disc or on card.

- 1 Press the DISC NAVIGATION button.
- 2 Press the MENU button.
- 3 Choose “Capacity” on the “Disc” or “Card” menu screen, and then press the ►/II button.

- 4 Press the ■ button to quit.

The Disc Navigation screen will be restored.

Note:

With a write-protected disc (see “Terminology”, P. 160) or locked card, the remaining space will always be displayed as “0”.

(When using disc)

(When using card)

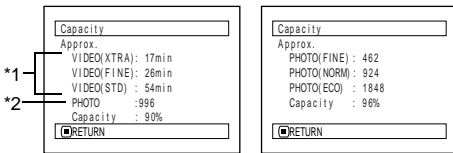

*1 With DVD-R disc: The quality mode first used for recording with disc will appear.

*2 With DVD-R disc: This will not be displayed.

PROTECTING DISC FROM WRITING (PROTECT DISC)

RAM

You can protect a DVD-RAM disc in order to prevent recorded images from being erased or edited by mistake. Further recording will not be possible on protected disc until the protection is released.

- 1 Press the DISC NAVIGATION button.
- 2 Press the MENU button.
- 3 Choose “Protect Disc” on the “Disc” menu screen, and then press the ►/II button.

Choose “NO” to cancel protection. After “YES” or “NO” setting, the Disc Navigation screen will be restored.

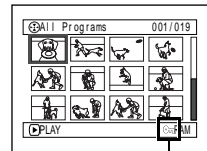

Disc protect icon

- 4 The screen for verifying protection will appear:

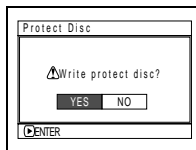
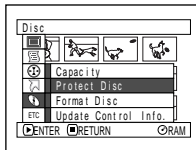

Choose “YES”, and then press the ►/II button.

Note:

- To release disc protection, perform the same procedure as above: The screen for verifying the release of protection will appear. Choose “YES” to release the protection.

INITIALIZING DVD-RAM DISC OR CARD (FORMAT DISC. FORMAT CARD)

Before You Begin

- Be sure to use the AC adapter/charger to power the DVD video camera/recorder for initialization. If the DVD video camera/recorder is turned off during initialization and the initialization is interrupted, incorrect initialization will result and the incorrectly initialized disc will be unusable.

1 Press the DISC NAVIGATION button.

2 Press the MENU button.

3 Choose “Format Disc” or “Format Card” on the “Disc” or “Card” menu screen, and then press the ►/|| button.

The screen for verifying “Format Disc” or “Format Card” will appear.

4 Choose “YES”, and then press the ►/|| button.

Choose “NO” to cancel initialization.



(When using DVD-RAM disc)

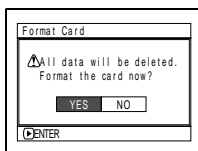

(When using card)

Note:

- Initialization will delete all the recorded contents on disc or card: Be careful not to delete data by mistake.
- Be sure to use the AC adapter/charger when initializing disc or card so that the DVD video camera/recorder is not turned off midway. If initialization is interrupted by power off, the disc or card will not be initialized correctly, or it may be damaged.
- It may not be possible to initialize a disc with many scratches or dirt: Such a disc cannot be used (P.82).
- If you use a brand-new DVD-R disc, message “Disc is not formatted” will appear: Initialize the disc, following the subsequent messages (P.45).
- This DVD video camera/recorder may not recognize some discs or cards that have been initialized on PC or a device other than this DVD video camera/recorder.
- If you attempt to initialize a disc or card in this DVD video camera/recorder when it is connected to PC via PC connection cable, the disc or card may not be initialized and may be unusable on this DVD video camera/recorder.

When initializing one side of the disc is complete, the DVD video camera/recorder will return to the recording pause status.

UPDATING CONTROL INFORMATION OF DVD-RAM DISC (UPDATE CONTROL INFO.)

Disc Navigation in this DVD video camera/recorder handles information on scenes, such as thumbnail, skip, fade, in a particular manner. If you use another device to edit a disc recorded on this DVD video camera/recorder, and then use the data again with Disc Navigation in this DVD video camera/recorder, the Disc Navigation may not appear normally. If this happens, use the Update Control Info function to update the data.

Before You Begin

- When using the AC adapter/charger to power the DVD video camera/recorder for updating control information, make sure that power is not turned off during updating. If the DVD video camera/recorder is turned off during updating and the updating is interrupted, the control information will not be updated correctly.

1 Press the DISC NAVIGATION button.

2 Press the MENU button.

3 Choose “Update Control Info.” on the “Disc” menu screen, and then press the ►/II button.

The screen for verifying “Update Control Info.” will appear.

4 Choose “YES”, and then press the ►/II button.

The message for proceeding will appear, and then the Disc Navigation menu screen will be restored.

A black screen may appear while the message for updating is displayed.

Choose “NO” to cancel updating.

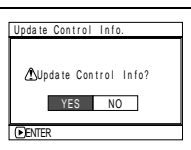

5 Press the ■ button to quit.

Note:

- Be sure to use the AC adapter/charger when updating the control information so that the DVD video camera/recorder is not turned off midway. If updating of control information is interrupted by power off, the control information will not be updated correctly.
- It may take time to update the control information if the disc has many recorded scenes.
- Pressing the ■ button on the screen for verification will restore the thumbnail display screen.

FINALIZING DVD-R DISC (FINALIZE DISC)

Before You Begin

- Be sure to use the AC adapter/charger to power the DVD video camera/recorder when finalizing a DVD-R disc. If the DVD video camera/recorder is turned off during finalization and the finalization is interrupted, incorrect finalization will result, and at worst, the disc may be damaged.

If you want to play back a DVD-R disc recorded on this DVD video camera/recorder, using a device conforming to 8 cm DVD-R disc - such as a DVD player, etc. - you must finalize the disc on this DVD video camera/recorder. (See “Terminology”, P.160)

The finalized DVD-R disc can be played on a DVD player, as “DVD Video”: The date of program will appear on the menu screen of DVD player as a title.

1 Press the DISC NAVIGATION button.

2 Press the MENU button.

3 Choose “Finalize Disc” on the “Disc” menu screen, and then press the ►/II button.

The disc will be finalized.

4 Choose “YES”, and then press the ►/II button.

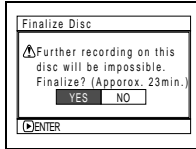

The message showing that the disc is being finalized will appear, and the disc will then be finalized.

© will appear on the Disc Navigation screen for a finalized disc.

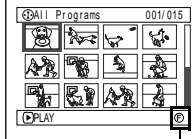

Finalized DVD-R disc

5 When finalization is complete, the Disc Navigation screen of all programs will appear.

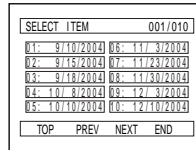

(Screen when viewed on DVD player)

Note:

- Do not finalize a disc recorded on this DVD video camera/recorder using any other device.
- No recording can be done on any DVD-R disc that has been finalized.
- If the disc in the DVD video camera/recorder has already been finalized, you cannot choose “Finalize Disc”.
- Be sure to use the AC adapter/charger when finalizing disc. Finalization cannot be executed using a battery. If finalization is interrupted by power off, the disc will not be finalized correctly, or it may be damaged.
- The time required to finalize disc that appears on the “Finalize Disc” screen is only for reference.
- The shorter the recording time on disc, the longer it will take to finalize it.

Others

DISPLAYING MOVIES OR STILLS INDEPENDENTLY (CATEGORY)

Scenes recorded on this DVD video camera/recorder will be displayed in the order of recording regardless of whether they are movies or stills. You can use the Disc Navigation screen to switch this display to stills only or movies only.

1 Press the DISC NAVIGATION button.

2 Press the MENU button.

3 Choose "Category" on the "Others" menu screen, and then press the ►/|| button.

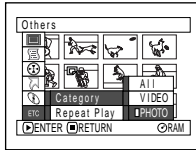

4 Specify the desired option for display, and then press the ►/|| button.

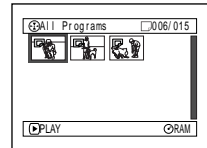

(When "PHOTO" is specified)

- All: To display all scenes, movies or stills, in the order of recording.
 VIDEO: To display only movies in the order of recording.
 PHOTO: To display only photos in the order of recording.

RAM

R

PLAYING BACK SCENES REPEATEDLY (REPEAT PLAY)

1 Press the DISC NAVIGATION button.

2 Press the MENU button.

3 Choose "Repeat Play" on the "Others" menu screen, and then press the ►/|| button.

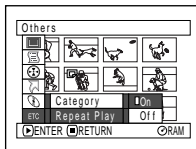

4 Choose "On", and then press the ►/|| button: Playback will start.

Choose "Off" to cancel Repeat Play Setting.

● When Repeat Play is set:

If one scene has been specified: When playback of the last scene is finished, playback of all scenes will repeat from the first scene.

If the range for playback has been specified: Playback of the scenes in that range will repeat.

● To release Repeat Play

Use one of the following 3 methods to release:

- Choose "Off" in step 4 above.
- Turn the DVD video camera/recorder off once.
- Press the DISC EJECT button to remove the disc.

Note:

- Press the ■ button to terminate playback. However, the Repeat Play setting will not be cancelled.
- Still images can also be played back repeatedly.
- Repeat playback will not function when playback is instructed from the recording pause status.

SLIDE SHOW (CONTINUOUS PLAYBACK OF STILLS)

If you play back stills recorded on a card, the DVD video camera/recorder will enter the playback pause status after each still is played back.

Setting Slide Show allows you to continuously play back stills.

1 Press the DISC NAVIGATION button.

2 Press the MENU button.

3 Choose “Slide Show”, “All” or “DPOF”, and then press the ►/II button.

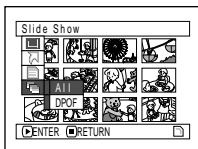

All: To play all stills recorded on card in slide show.

DPOF: To play only stills to which DPOF has been set in slide show.

When playback is finished, the DVD video camera/recorder will enter the playback pause status at the final still.

Pressing the ■ button will restore the Disc Navigation screen.

Note:

- One still is played for approx. 5 seconds.
- With slide show, playback starts from the first still on card.
- If you press the ■ button or turn the DVD video camera/recorder off, Slide Show will be canceled.

Connecting to PC

THE FOLLOWING ARE AVAILABLE WHEN CONNECTING TO PC

Use the provided PC connection cable to connect this DVD video camera/recorder to your PC in which the software on the CD-ROM provided or generally available software is installed: The videos and photos recorded on the DVD video camera/recorder can be used on the PC.

● Using, on PC, the photos recorded on DVD-RAM disc or card in this DVD video camera/recorder:

Original disc	Application used
DVD-RAM disc or card recorded on this DVD video camera/recorder 	Application on which JPEG files can be used <ul style="list-style-type: none"> • Open the DCIM\100*HPNX1 folder of DVD-RAM disc or card.

● Viewing, on PC, DVD-RAM disc recorded on this DVD video camera/recorder:

Original disc	Application used
DVD-RAM disc recorded on this DVD video camera/recorder 	DVD-MovieAlbumSE** or generally available playback software conforming to DVD video recording (DVD-VR) format (see "Terminology", P. 160) Example: PowerDVD XP produced by CyberLink

● Viewing, on PC, DVD-R disc recorded on this DVD video camera/recorder:

Original disc	Application used
DVD-R disc recorded and finalized on this DVD video camera/recorder 	Generally available playback software compatible with DVD video (see "Terminology", P. 160) Example: PowerDVD XP produced by CyberLink

● Copying contents on DVD-RAM disc recorded on this DVD video camera/recorder to another DVD-RAM disc using PC:

Original disc	Written media	Application used
DVD-RAM disc recorded on this DVD video camera/recorder 	Another DVD-RAM disc	DVD-MovieAlbum copy tool** <ul style="list-style-type: none"> • Copy the data to hard disk of PC, and then write the data to another DVD-RAM disc. • Copying in program units is also possible.

● **Using PC to edit images on DVD-RAM disc recorded on this DVD video camera/recorder:**

Original disc	Written disc	Application used
DVD-RAM disc recorded on this DVD video camera/recorder 	Original DVD-RAM disc or another DVD-RAM disc	DVD-MovieAlbumSE**

● **Using PC to edit images on DVD-RAM disc recorded on this DVD video camera/recorder and create a DVD video (DVD-R disc) (see page 152):**

Original disc	Written disc	Application used
DVD-RAM disc recorded on this DVD video camera/recorder 	Blank DVD-R disc	<ul style="list-style-type: none"> • DVD-MovieAlbumSE** • MyDVD**

* The number may be different when recording was made on a device conforming to DCF.

** Software stored on the provided CD-ROM

Note:







Images recorded on DVD-R disc cannot be edited on the software provided with this DVD video camera/recorder.

Languages compatible with each software program:

- DVD-MovieAlbumSE and UDF driver (DVD-RAM driver) can handle Japanese, English, German, French, Spanish and Italian.
- 3D-TitleSTUDIO provided with DVD-MovieAlbumSE can handle Japanese and English.
- MyDVD can handle Japanese, English, German, French, Spanish, Italian, Chinese (simplified and traditional), Dutch, Korean, Portuguese, Swedish and Thai.
- When installing the provided software, the language on your Windows® will automatically be installed: If your Windows® is run on a language other than the above, the English version will be installed.

Contents on Provided CD-ROM

The CD-ROM supplied with the DVD video camera/recorder contains the following folders:
To refer to the contents of CD-ROM, set the CD-ROM in the CD-ROM drive of PC, right-click the CD-ROM icon and choose "Open".

	DVDCAM5	
	DVDMASE3	Contains the DVD-MovieAlbumSE (see page 148 for installation). You can use DVD-MovieAlbumSE to edit the images recorded on DVD-RAM disc and create a 3D title.
	MyDVD	Contains the MyDVD (see page 150 for installation). You can use MyDVD to create a DVD-Video disc from movies edited on DVD-MovieAlbumSE.
	UDF	Contains the UDF driver (see page 146 for installation). Install this driver if you wish to use JPEG stills recorded on DVD-RAM disc, on your PC.
	USB	Contains the USB2.0 driver (see page 145 for installation). Install this driver when using the provided PC connection cable to connect this DVD video camera/recorder to PC: If the USB terminal of your PC is USB1.1, use this driver.
	AcrobatReader	Contains the Acrobat Reader (see page 143 for installation). If Acrobat Reader is not installed in your PC, you will need to install it in order to open the on-line manuals (instruction manual files) for DVD-MovieAlbumSE and UDF driver.

Although the CD-ROM may contain a folder or file other than the above, they will not be needed on this DVD video camera/recorder unless some special instruction is given.

● DVD-MovieAlbumSE

You can read the instruction manual using either of the following procedures:

- Open the PDF file in
DVDMASE 3\manuals\English folder
contained on the provided CD-ROM.
- After installing DVD-MovieAlbumSE, open “Programs” or “All Programs” from the Windows “Start” menu, choose “Hitachi DVDCAM” and “DVD-MovieAlbumSE”, and then open “On-line Manual”.

To read the above manual, you will need Adobe Acrobat Reader.

If Adobe Acrobat Reader has not been installed in your PC, start AcrobatReader\English\AR500\ENU.exe on the provided CD-ROM to install it.

● MyDVD

- After installing MyDVD, open “Programs” or “All Programs” from the Windows “Start” menu, choose “Sonic” and “MyDVD”, and then open the electronic instruction manual in “Document” folder.

To read the above manual, a Web browser (Internet Explorer, Netscape Communicator, etc.) must be set up in your PC.

If you cannot open the electronic instruction manual of MyDVD, consult the maker of your PC about the setup method for Web browser.

● UDF driver (DVD-RAM driver)

- After installing the UDF driver (DVD-RAM driver), open “Programs” or “All Programs” from the Windows “Start” menu, choose “DVD-RAM” and “DVD-RAM Driver”, and then open “How to use DVD-RAM disc”.

No electronic instruction manual is provided with the USB driver.

● Requirements of available PC

- OS: Windows® 98 Second Edition / Me / 2000 Professional / XP
- Computer: IBM PC/AT compatible
- CPU: Intel® Pentium® III 450 MHz or higher, Celeron™ 633 MHz or higher (Pentium® 4 1.2 GHz or higher is recommended)
Operation with Pentium compatible CPU other than those produced by Intel®/AMD® may not be supported. Also, operation with K6-2®/K6-III® produced by AMD® may not be supported.
- Memory: At least 128 MB (256 MB or more is recommended)
- Free space on hard disk: At least 400 MB (does not include capacity needed to copy or edit video or photo data)
- CD-ROM drive (used to install software)
- Display adapter (video memory of at least 4 MB) and display that can display at least 1024 × 768 pixels and 65,536 colors (16-bit colors), and is compatible with DirectX® 8.1 or higher.
- DirectSound® compatible sound card
- USB: One unused port is necessary for this product (USB2.0 port is recommended)

Note:

- Operation is not guaranteed in the following cases:
 - When OS other than Windows® 98 Second Edition / Me / 2000 Professional / XP is installed
 - When operated on Pentium® compatible CPU other than those produced by Intel® or AMD®
 - When connected via USB hub
 - When connected using cables other than the provided PC connection cable or mini-USB B connector 5-pin type PC connection cable (generally available)
 - When a USB device other than this DVD video camera/recorder, keyboard or mouse is connected to PC
- Multiprocessor is not supported.
- Can also be used with Windows® 98, but OS of Windows® 98 Second Edition or higher is necessary in order to use all functions of DVD-MovieAlbumSE.
- Even when your PC satisfies the above conditions of available PC, malfunction may result or restriction in use may occur, depending on the combination of other software in PC or peripheral devices.

Installing Software

Before You Begin

- Before connecting the DVD video camera/recorder to your PC, you will need to install the software on provided CD-ROM.

Before installing the UDF driver (DVD-RAM driver) provided with this DVD video camera/recorder, check to see if another UDF driver* has already been installed your PC.

*InstantWrite® provided with the DZ-WINPC1, DZ-WINPC2 or DZ-WINPC2B PC kit for the Hitachi DZ-MV100A DVD video camera/recorder, or with the DZ-WINPC3 PC editing kit for the Hitachi DZ-MV200A, DZ-MV230A or DZ-MV270A DVD video camera/recorder.

If the UDF driver has been installed, uninstall it and then install the UDF driver on the provided CD-ROM. Use “Control Panel” – “Add or Remove Programs” or “Add or Remove Applications” to uninstall the UDF driver.

If any question messages appear that mean “This file is not used on another application. Do you wish to delete it together?” during uninstalling, click “No” for all such questions.

DISPLAYING INSTALLER SCREEN

- 1 Turn the PC on.

Do not connect the DVD video camera/recorder to PC yet. First, if any software is being run on the PC, terminate all the programs being used.

- 2 Insert the provided CD-ROM into the CD-ROM drive of PC.

The installer screen will automatically appear.



If the installer screen does not automatically appear, use the following procedure to display it:

- 3 Use the Windows My Computer or Explorer to open the drive in which the CD-ROM is located.

- 4 Double-click the Setup.exe icon.

The “.exe” extension may not appear, depending on the PC being used.

INSTALLING USB DRIVER

With Windows XP

- 1 Click "USB Driver Installation" on the installer screen.
- 2 The USB driver installer screen will appear:
Click "USB Driver Installation".



Click

- 3 Check the contents and then click "OK".



Click

- 4 The message on Windows logo test will appear:
Carefully read it and then click "Continue Anyway".

Installation will start.



Click

- 5 Click "Quit".



Click

Installing the USB driver is now complete.

With Windows 2000/Me/98 Second Edition

- 1 Click "USB Driver Installation" on the installer screen.
- 2 The USB driver installer screen will appear:
Click "USB Driver Installation".

Installation will start.

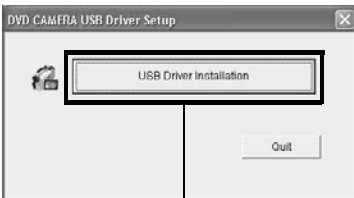

Click

- 3 Click "Quit".

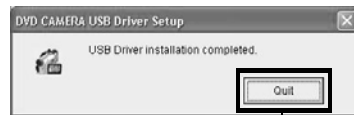

Click

Installing the USB driver is now complete.

INSTALLING UDF DRIVER (DVD-RAM DRIVER)

The UDF driver must be installed before using the disc in DVD video camera/recorder on PC.

- 1 Click “UDF Driver (DVD-RAM Driver) Installation” on the installer screen.

The installer screen can be displayed using the procedure in “DISPLAYING INSTALLER SCREEN” (P. 144).

- 2 The driver setup screen will appear: Click the “Driver and Formatter Setup” button.

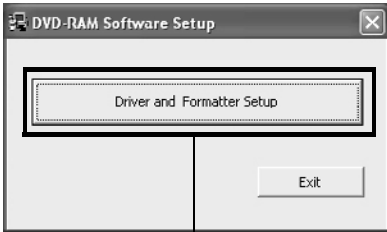

Click

- 3 Click “Next”.



Click

- 4 Carefully read the License Agreement: If you accept it, click “Yes”.

The contents of agreement displayed on actual screen may be different from those in the figure.

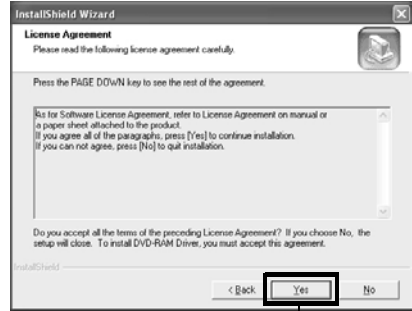

Click

- 5 If you do not wish to change the folder in which the UDF driver is installed, click “Next”.

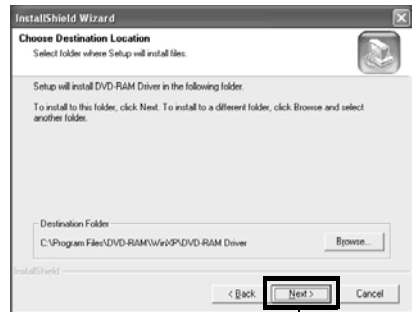

Click

6 If you do not wish to change the folder name, click “Next”.

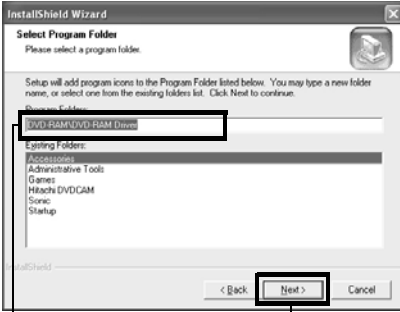

Confirm

Click

7 Check the displayed contents, and then click “Next”.



Click

8 Installation will start. When installation is complete, some notes will appear: Check the contents, and then click “x” at the top right of window.

The contents displayed on actual screen may be different from those in the figure.



Click

9 If your PC uses Windows® XP/98 Second Edition/Me, a message that prompts you to restart will appear: Click “Finish” and then restart the PC.

Installing the UDF driver is now complete. If your PC uses Windows® 2000 Professional, proceed with step 10.



Confirm

Click

10 If your PC uses Windows® 2000 Professional, a message announcing the start for detecting device will appear: Click “Finish” to start the detection of device.

It may take several minutes for PC to detect the device. When detection of the device is complete, a message that prompts you to restart will appear: Click “Yes” to restart the PC. Installing the UDF driver is now complete.

INSTALLING DVD-MovieAlbumSE

Software “DVD-MovieAlbumSE” is used to edit videos that conform to the DVD video recording (DVD-VR) format, and photos recorded on DVD-RAM disc.

1 Click “DVD-MovieAlbumSE Installation” on the installer screen.

The installer screen can be displayed using the procedure described in “DISPLAYING INSTALLER SCREEN” (P. 144).

2 The screen for installing DVD-MovieAlbumSE will appear: Click “Next”.

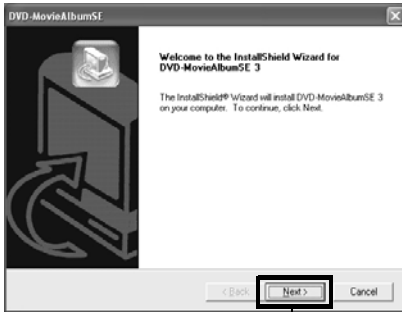

3 Carefully read the License Agreement: If you accept it, click “Yes”.

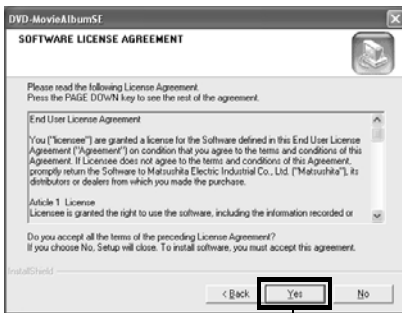

4 If you do not wish to change the folder in which DVD-MovieAlbumSE is installed, click “Next”.

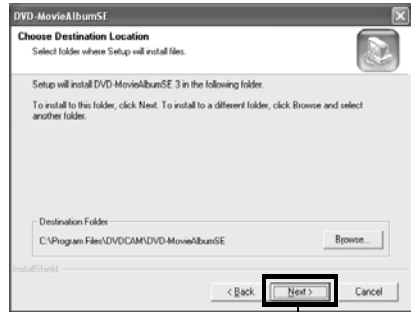

5 If you do not wish to change the folder name, click “Next”.



- 6** Check the displayed contents, and then click “Next”.

Installation will start.
Proceed with the installation, following the instructions on screen.

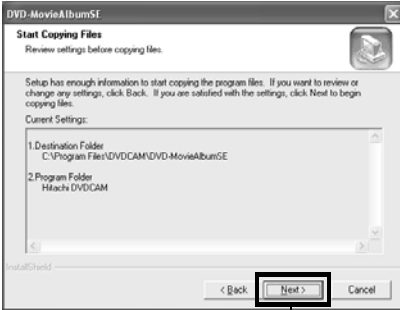

Click

- 7** A message verifying whether a shortcut icon is to be created on desktop will appear: If you want to create one, click “Yes”.

If not, choose “No”.

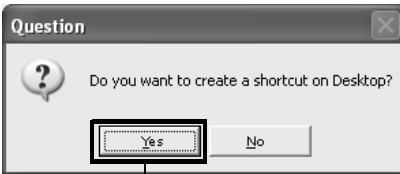

Click

- 8** Choose the restart option, and then click “Finish”.

Installing DVD-MovieAlbumSE is now complete.



Click

INSTALLING MyDVD

Software “MyDVD” is used to write the images edited on DVD-MovieAlbumSE to DVD-R disc.

- 1 Click “MyDVD Installation” on the installer screen.

The installer screen can be displayed using the procedure described in “DISPLAYING INSTALLER SCREEN” (P. 144).

- 2 The screen for installing My DVD will appear. Click “Next”.

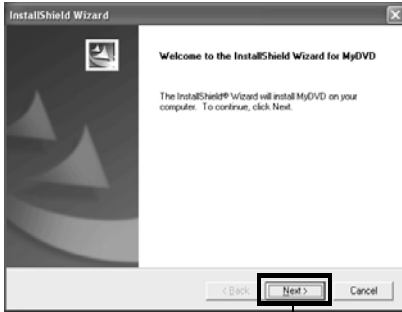

Click

- 3 Carefully read the Software License Agreement: If you accept it, click “Yes”.



Click

- 4 If you do not wish to change the folder in which MyDVD is installed, click “Next”.

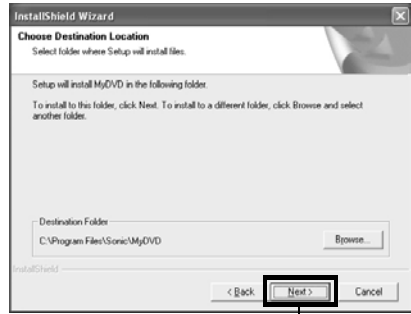

Click

- 5 Check the displayed contents, and then click “Next”.

Installation will start.

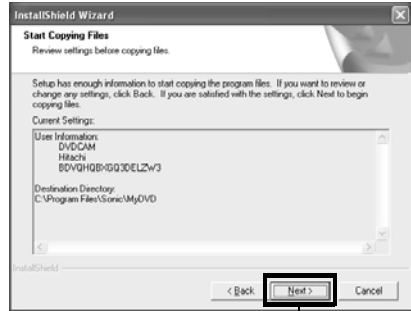

Click

6 Click “Finish” to restart the PC.

Installing MyDVD is now complete.



Click

Sonic Solutions Corporation, which developed MyDVD, recommends user registration of MyDVD, in order to offer appropriate support to customer. The guide for user registration will appear when you start MyDVD for the first time, or you can display it any time by accessing the following URL:
<http://www.mydvd.com>
(You will need the connection environment to the Internet for user registration.)

Contact the following for information on MyDVD:

U.S.

Phone: 1-877-383-1124

<http://support.sonic.com/login/default.asp>

(You will need to perform customer registration.)

Europe (London)

Phone: 44-20-7437-1100

<http://support.sonic.com/login/default.asp>

(You will need to perform customer registration.)

Note:

- If software that detects computer virus, etc., has been installed, invalidate it.
- If your PC uses Windows® XP or 2000 Professional, set the user name to “Administrator (computer’s manager)” (or user name with equivalent authorization), log on to PC, and then install the software (if you do not have authorization, consult your system manager).

Creating DVD Video on PC from DVD-RAM Disc Recorded on DVD Video Camera/Recorder

Using DVD-MovieAlbumSE and MyDVD, you can create a DVD video (DVD-R disc) from the images recorded on this DVD video camera/recorder, following the procedure below:

- 1 Insert a recorded DVD-RAM disc into the DVD video camera/recorder, and connect the DVD video camera/recorder to the USB terminal of PC.
- 2 Start DVD-MovieAlbumSE, and edit the images on DVD-RAM disc as necessary.
- 3 Right-click the thumbnail from which you wish to create a DVD video on the DVD-MovieAlbumSE screen, and execute "Export".
- 4 The "Program Export" screen, shown below, will appear: Choose "Same Resolution" and check "Use DVD-Video" in the "Export Mode" setting box. Choose "704 × 480 (recommended)" for "Resolution".



"Program Export" Screen

Click

Note:

- Choose "Divide by Marker" in the "Option" box: Each scene of program recorded on the DVD video camera/recorder will be saved as an independent movie file so that export can be executed at high speed. If you do not choose "Divide by Marker", movie files may be unified and re-encoded, so it may take time to export them. DVD-MovieAlbumSE may automatically re-encode a movie recorded in the XTRA mode containing rapidly moving scenes (8 Mbps or higher), regardless of the "Divide by Marker" setting, and it may take some time to export the movie file.
- Any disc on which scenes were combined (see page 116) on Disc Navigation of this DVD video camera/recorder is re-encoded, so it may take time to export files.
- Re-encoding may cause image quality to deteriorate slightly.
- Do not choose "Simple Export" in the "Export Mode" setting box: Choosing it may stop export midway.

- 5 Click the Start button to start export.

- 6 When export is complete, message "The file exporting was completed successfully. Do you wish to create a 'DVD-Video' disc or an 'MPEG file' disc?" will appear. Check the small box for "Eject the disc being used", and then click "Yes".

Insert a brand-new DVD-R disc into the DVD video camera/recorder.

- 7 DVD-MovieAlbumSE will automatically end, and the "Export to Disc" screen will appear: Click the "Start" button.

8 MyDVD will automatically start. After a few moments, the exported scene will be automatically registered on the MyDVD editing screen:

Now you can change the DVD menu to the desired style, change the title, etc. on this editing screen.



9 Click the Burn button: Writing to DVD-R disc will start. When writing is complete, a DVD video disc will be created. Then the disc cover of this DVD video camera/recorder will open automatically.

Note:

- The menu screen created on MyDVD will not appear on this DVD video camera/recorder. Also, depending on the written contents, the images may not be playable on this DVD video camera/recorder. In such cases, use a standard DVD player to display the created menu.
- The following table shows the recordable time on 8 cm DVD-R disc from MyDVD. The recordable time is shorter than that of 8 cm DVD-RAM disc because MyDVD always records audio in the LPCM format.

Movie quality mode of DVD-RAM disc in DVD video camera/recorder	Recordable time on 8 cm DVD-R disc (using MyDVD)
STD	Approx. 40 minutes
FINE	Approx. 25 minutes
XTRA	At least 18 minutes

* If "Style" created on MyDVD is a movie or there are many thumbnails, the recordable time will be less than that shown in the above table.

The following discs created on MyDVD cannot be played back on this DVD video camera/recorder:

- Discs containing slide show (*1)
- Discs with no audio
- Discs with audio longer or shorter than video

*1 Cannot be created on MyDVD depending on the version.

- "Slide Show" can be created using photo files on MyDVD, but it will not be playable on this DVD video camera/recorder.
- A DVD video can be created from MPEG files on PC using MyDVD, but it may not be playable on this DVD video camera/recorder.

Uninstalling Software

Use the following procedure to uninstall (delete) any provided software that has been installed:

UNINSTALLING USB DRIVER

With Windows® 98 Second Edition/Me:

- 1** Set the power switch on DVD video camera/recorder to “ VIDEO”, and use the PC connection cable to connect it to the PC.
- 2** Open “System” on Control Panel, and then choose the “Device Manager” tab.
- 3** Delete HITACHI DVD-RAM DZ-MV5 in “CD-ROM”.

If the file does not exist, proceed with the next step:
- 4** Delete HITACHI DVD-RAM DZ-MV5 in “Disk drives”.

If the file does not exist, proceed with the next step:
- 5** Delete the following items in “Universal Serial Bus controllers”:

Hitachi DVDCAM DVD Mode USB HS Interface
USB Mass Storage Device For DVDCAM

If no item exists, proceed with the next step:
- 6** Close Device Manager.

If the message for restart appears, click “No”.

- 7** Delete the following files:

Windows® 98 Second Edition:

```
C:\WINDOWS\INF\OTHER\Hitachi  
Ltd.DZ3298.inf
```

```
C:\WINDOWS\SYSTEM\IOSUBSYS\dzmvpd  
r.pdr
```

```
C:\WINDOWS\SYSTEM32\DRIVERS\DZMVU  
MSS.sys
```

No extension may appear depending on the setting on PC.

Windows® Me:

```
C:\WINDOWS\INF\OTHER\Hitachi  
Ltd.DZ32me.inf
```

No extension may appear depending on the setting on PC.

If the INF folder cannot be found, use Explorer to choose the “View” menu, “Folder Options”, “View” tab, and then “Show all files”: Click “OK” and then try again.

- 8** Disconnect the DVD video camera/recorder from PC, and then restart the PC.

With Windows® 2000 Professional/XP:

1 Set the power switch on DVD video camera/recorder to “ VIDEO”, and use the PC connection cable to connect it to the PC.

2 Open “System” on Control Panel, and then click “Device Manager” under the “Hardware” tab.

3 Delete HITACHI DVD-RAM DZ-MV5 USB Device in “DVD/CD-ROM drive”.

4 If your PC uses Windows® 2000 Professional, delete HITACHI DVD-RAM DZ-MV5 USB Device in “Disk drives”.

If your PC uses Windows®, or the file cannot be found, proceed with the next step:

5 Delete Hitachi DVDCAM DVD Mode USB HS Interface in “USB (Universal Serial Bus) controllers”.

If the item cannot be found, proceed with the next step:

6 Close Device Manager.

If the message for restart appears, click “No”.

7 If your PC uses Windows® 2000 Professional, open the C:\WINNT\INF folder.
If your PC uses Windows® XP, open the C:\WINDOWS\INF folder.

If the INF folder cannot be found, use Explorer to choose the “Tools” menu, “Folder Options”, “View” tab, and then “Show all files and folders”: Click “OK” and then try again.

8 Use application software “Notepad” provided with Windows® to open the oem*.inf files (* represents a number) from the file with the higher number. Search for the files with the following entry on the second and third lines, and then delete them:

```
;Hitachi DVDCAM USB Driver Installation  
File  
;Support OS: Windows® 2000 Professional  
and Windows® XP
```

Extension “.inf” may not appear, depending on the setting of PC.

9 Also delete the oem*.PNF files with the same numbers as those of the files deleted in step 8.

10 Disconnect the DVD video camera/recorder from PC, and then restart the PC.

DELETING OTHER APPLICATIONS

To uninstall the other applications, use “Control Panel” to open “Add or Remove Applications”, choose the applications to be uninstalled from the displayed list of applications, and then click the “Change/Remove” button.

Note:

After uninstalling software, be sure to restart the PC.

Cautions When Using DVD Video Camera/Recorder by Connecting It to PC

Note:

- Do not use Windows® application to finalize a DVD-R disc recorded on this DVD video camera/recorder: The disc will not be recognizable on the DVD video camera/recorder.
- When formatting a DVD-RAM disc on Windows®, use the UDF2.01 format (2.0 if 2.01 cannot be selected) (see "Terminology" on page 160). Formatting with other standards could cause the DVD video camera/recorder to malfunction.
- Before processing or editing photos, be sure to copy the JPEG files in 100HPNX1 folder to the hard disk of PC.
- Ordinary data on PC can usually be written to DVD-RAM disc in this DVD video camera/recorder, but Hitachi does not guaranteed the operation.
- If the PC is started from suspend (see "Terminology" on page 160) (or sleep or standby) with this DVD video camera/recorder connected to the PC, the DVD video camera/recorder may not be recognized: Disconnect the DVD video camera/recorder from PC once, and restart the PC.
- Multiple DVD video camera/recorders cannot be simultaneously connected to PC.
- Use a reference of approx. 30 minutes at approx. 86°F (30°C) or less for operation when connecting this DVD video camera/recorder to PC.
 - Use a reference of a continuous 30 minutes or less for write operation when using the DVD-MovieAlbum copy tool provided with DVD-MovieAlbumSE.
 - If the temperature of this DVD video camera/recorder is too high, writing or reading on this DVD video camera/recorder may be faulty. And in particular, note that, if an error occurs during writing to DVD-R disc, the disc will not be usable. Take care that the temperature of this DVD video camera/recorder is not too high.

Subsidiary Information

Introduction to Optional Accessories

CAMERA ACCESSORIES

Wide conversion lens (DZ-WL1)*



Tele-conversion lens (DZ-TL1)*



Video flash (DZ-FLH3)**



- When using camera accessories, be sure to read the instruction manuals for each accessory.
- * When attaching the wide or tele-conversion lens to this DVD video camera/recorder, be sure to remove the lens hood at the end of the lens (see P. 57).
- ** Unusable on DZ-MV550A.

POWER SUPPLY

Battery (DZ-BP14SW)

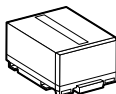

INFORMATION ON SQUARE ADAPTER

This DVD video camera/recorder cannot use a square adapter, such as for 8 cm DVD-RAM disc (DRMS-V28R), 8 cm DVD-R disc (DR30.1P): Remove the disc from square adapter and set it in the Round DVD Holder of the provided DVD-RAM disc, referring to page 82.

● Removing disc from square adapter

(Example 1)

Snap off and remove lock pin

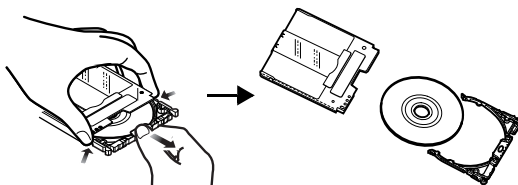
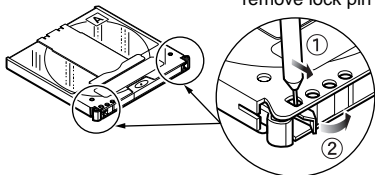

(Example 2)

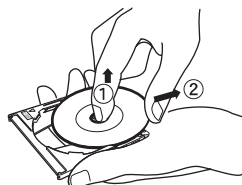

Slide the disc obliquely upward so that it is not caught by claws.

Note:

Refer to page 81, 82 if you want to correctly set the removed disc in Round DVD Holder that can be used in this DVD video camera/recorder.

Cleaning

Be sure to set the power switch to "POWER OFF" before cleaning this DVD video camera/recorder.

● **Cleaning LCD screen and camera lens**

Use dry, soft cloth to wipe dirt off. When cleaning the LCD screen, be careful not to use force, scratch it, or subject it to impact: Doing such could cause a defect in the screen, result in display unevenness, or damage the LCD monitor.

● **If dust adheres to the viewfinder lens, remove it using a cotton swab, etc.**

Do not rub the lens with force: Doing so could scratch the lens.

● **Do not use benzene or thinner to clean DVD video camera/recorder case**

The coating of case could peel off or the case could deteriorate. Wipe off dirt on the case with a moist cloth which has been completely wrung out. When using chemical cleaning cloth, follow instructions for use.

Changing Setting of Demonstration

This DVD video camera/recorder has versatile functions, including special effects.

Referring to the procedure on page 43, connect the DVD video camera/recorder, AC adapter/charger and power cable to power the DVD video camera/recorder from AC outlet.

1 Press the MENU button.

2 Choose "Initial Setup", "Demo Mode", and then press the ►/|| button.

3 Use the joystick to choose the desired option, and then press the ►/|| button.

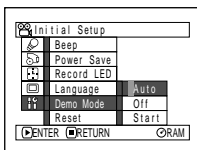

Note:

- You can press the DISC NAVIGATION button to stop demonstration midway. The Disc Navigation screen will appear.
- If you choose "Auto", the demonstration will not start if a disc is loaded with the power switch set to "VIDEO" or "PHOTO", or a card is loaded with the power switch set to "CARD PHOTO".
- The demonstration function will not work when the DVD video camera/recorder is connected to PC.
- While the demonstration is being given, the recording indicator will blink.

Auto: To start demonstration approx. 3 minutes after turning the DVD video camera/recorder on.

Off: To set demonstration to off.

Start: To start demonstration immediately.

Press the MENU button again: The menu screen will disappear.

To stop the demonstration midway, press the ■ button.

The demo mode will end when the DVD video camera/recorder is turned off or the DISC EJECT button is pressed down.



DISC-PROTECT:

This disables writing to disc (protects disc from writing) so that images recorded on DVD-RAM disc cannot be accidentally deleted and the disc cannot be initialized.

DVD PLAYER:

This device can play back video and audio signals recorded on DVD-Video and DVD-R discs using the DVD video format. Most DVD players can play back a DVD-R disc recorded on the DVD video camera/recorder (some DVD players cannot play back the disc).

DVD-RAM DISC:

Rewritable DVD disc.

DVD-R DISC:

One-time recordable DVD disc.

DVD VIDEO FORMAT:

This application format establishes the file name, directory structure, data format, etc. to record videos (movies). A generally available DVD video conforms to this format.

DVD VIDEO RECORDER:

This device can record video and audio on any recordable DVD disc, such as DVD-RAM, that conforms to the DVD video recording format. Some DVD video recorders can record on a DVD-R disc conforming to DVD video format. A DVD video recorder that is compatible with 8 cm DVD-RAM can play back DVD-RAM discs recorded on the DVD video camera/recorder.

DVD VIDEO RECORDING (DVD-VR) FORMAT:

Format to record video data on writable DVD disc: This format has been adopted for DVD video camera/recorders, and DVD-RAM recorders that are compatible with DVD-RAM disc, etc.

FINALIZE:

This process makes a DVD-R disc recorded on this DVD video camera/recorder playable on a DVD player, etc. that conforms to 8 cm DVD-R: No further recording can be made on a finalized DVD-R disc.

HOWLING:

This phenomenon occurs as follows: When the DVD video camera/recorder is connected to a device, such as TV, the audio input to the microphone of DVD video camera/recorder is amplified and output from the speakers of TV, and the signal is again input to the microphone: This is repeated to form an endless loop of audio signal, and the signal is amplified up to the audio output amplitude limit of the device. Howling can be prevented by changing the positional relationship between the DVD video camera/recorder and TV, or by turning down the volume on TV.

INFRARED SENSOR:

This sensor is used to adjust the white balance.

LASER PICKUP BLOCK:

This block emits laser beam to a disc, and then collects the laser beam reflected from the disc to convert it to an electric signal. The block consists of a laser, lens, receiving element, etc.

LINEAR PCM:

Audio recording format similar to MPEG audio layer 2: However, linear PCM does not compress an audio signal, but instead samples it and converts it to a digital signal to be recorded. Therefore, the amount of data used is larger than that of MPEG audio layer 2.

MultiMediaCard:

This is a standard of memory card developed in 1997. The card is 32 mm long x 24 mm wide x 1.4 mm thick, and has 7 pins. It can be inserted into SD memory card slot and used.

SCENE:

Video (movie): "One scene" refers to images recorded from one press of REC button until recording is stopped by pressing the REC button again.

Photo (still): "One scene" refers to a single photo recording by pressing the REC button.

SD MEMORY CARD:

This is a standard of memory card developed in 1999. The card is 32 mm long x 24 mm wide x 2.1 mm thick, and has 9 pins. Since the SD memory card was developed based on MultiMediaCard (MMC), MMC can be inserted into SD memory card slot and used. However, an SD memory card cannot be inserted in the slot exclusively for MMC.

SLOT-IN TYPE PC:

PC that has a DVD drive into/from which a DVD is directly inserted or ejected without using a tray.

SUSPENDING PC:

This function stores the status of PC before it is turned off: It will restart the work from the status immediately before PC was turned off, when the PC is turned on next time.

THUMBNAIL:

This refers to a reduced screen displayed on Disc Navigation in order to identify the recorded image contents.

UDF2.01 FORMAT:

UDF stands for Universal Disc Format: This is a world standard file format for optical storage defined by OSTA*. UDF revision 2.0 or 2.01 has been adopted for DVD-RAM disc to ensure compatibility with DVD video recorders and PCs, as well as DVD video camera/recorders.

* Optional Storage Technology Association: An organization that is promoting writable optical storage.

VIDEO SELECTOR:

This device can input multiple audio and video signals, and select the desired audio and video signals among those input, to output them.

No DVD Video Camera/Recorder Operation - Check the Following:

Check 1	No movie can be recorded
<p>Movie can be recorded only on DVD-RAM or DVD-R disc.</p> <p>Check the following:</p> <ul style="list-style-type: none"> • Is DVD-RAM or DVD-R disc inserted? • Is power switch set to "VIDEO"? • Is the DVD-RAM disc in DVD video camera/recorder write-protected? Release the write-protect. • Does disc have remaining recording space? <p>If movie still cannot be recorded after the above check is clear, the disc may be damaged: Use another disc.</p>	

Check 2	No still can be recorded
<p>Still can be recorded only on DVD-RAM disc, SD memory card or MultiMediaCard.</p> <p>Check the following:</p> <ul style="list-style-type: none"> • Is DVD-RAM disc, SD memory card or MultiMediaCard inserted? • Is power switch set to match the recording medium? <ul style="list-style-type: none"> – When using DVD-RAM disc: <ul style="list-style-type: none"> Set to "PHOTO". If the LOCK switch on this DVD video camera/recorder is set to Ⓛ (to left), set it to Ⓡ (to right). If the LOCK switch is set to Ⓡ (to left), switching to "PHOTO" is not possible. – When using SD memory or MultiMediaCard: <ul style="list-style-type: none"> Set to "CARD PHOTO". • Is loaded DVD-RAM disc write-protected? • When using SD memory card: Is the erase prevention switch locked? (P.28) • Does disc or card have remaining recording space? <p>If still cannot be recorded after the above check is clear, the disc or card may be damaged: Use another disc or card.</p>	

Check 3	Skip or search playback does not work well
<p>If the temperature inside the DVD video camera/recorder is high, normal operation may not be possible. Turn the DVD video camera/recorder off, wait for a few moments, and then turn it on again for operation.</p>	

Check 4	No operation can be performed because the ACCESS/PC or CARD ACCESS indicator on this DVD video camera/recorder remains lit or blinking. After disc or card is inserted, it takes some time until recording is possible.
<p>In the following cases, it will take more time than usual until operation is possible:</p> <ul style="list-style-type: none"> • When disc or card is removed and then reinserted • When date changes (e.g., during the first recording of the day) • When the temperature is greatly different from the status of previous recording • When disc with scratches, dirt or fingerprints is inserted • When disc is subject to severe vibrations • When the battery or DC power cord was disconnected instead of following the correct procedure using power switch to turn the DVD video camera/recorder off 	

Check 5	No DVD video camera/recorder operation
<p>Is a fully charged battery attached? Is the DVD video camera/recorder powered from AC outlet?</p>	

Check 6	No image in viewfinder
<p>Is LCD monitor open? No image will appear in viewfinder unless the LCD monitor is closed and securely locked to DVD video camera/recorder.</p>	

Check 7	No image appears on the LCD screen or in the viewfinder
<ul style="list-style-type: none"> • Is DVD video camera/recorder connected to PC using PC connection cable? Unplug the PC connection cable. • Does DVD video camera/recorder stop at the end of the scene to which wipe-out was set and played back? Press the DISC NAVIGATION button. 	

Trouble Messages

A message may appear while you are operating the DVD video camera/recorder. If a message appears, refer to the following table and take appropriate corrective action. Messages are arranged in alphabetical order.

Message	Cause & Troubleshooting	Reference page
<p>(1) Data error in a part of image file. Repair data now?</p> <p>(2) Found error in image file. Repair data now?</p> <p>(3) Data error in all image file. Repair all data now?</p>	<p>It is possible that the system cannot normally complete writing of file when power is turned off for some reason during recording or editing (deleting, dividing or combining scenes, or creating play list). Selecting "YES" will automatically repair the video file, but even if "NO" is selected, the same message will appear when the DVD video camera/recorder is turned on next time. (Do not remove the disc while the DVD video camera/recorder is recognizing it: Ignoring this will deactivate the file repair function.)</p> <p>Follow the instructions on screen, taking note of the following cautions:</p> <ul style="list-style-type: none"> • Be sure to use the AC adapter/charger to power the DVD video camera/recorder when repairing data: Repair is not possible using a battery. If a battery has been attached, turn the power switch off once, connect the AC adapter/charger, and then start repairing. • Data may not be repaired, depending on the timing when power was turned off. • Data may not be repaired normally if data recorded on another recorder is mixed in. • The repaired data may be different from the original recorded content because of partial deletion of defective portion. • Since the date/time for repair is added to the repaired data (only the corrected portion for partial repair), the original date/time information will be lost. • Since all movies, and then all stills, are repaired, the order of recorded contents will be lost. (In case of message (2) (3) only) • See *1 on page 171. 	<p>—</p>
<p>(1) Disc is not formatted. If it formats, it becomes possible to use for camera.</p> <p>(2) However, when you record from PC connection terminal, please do not format.</p> <p>(3) Format the disc now?</p>	<p>DVD-R disc that was not initialized for camera use was inserted.</p>	<p>45</p>

Message	Cause & Troubleshooting	Reference page
(1) Error has occurred. Please restart.	<ul style="list-style-type: none"> Error has occurred. Try to restart the DVD video camera/recorder using the following methods: <ol style="list-style-type: none"> Turn power off, remove the battery or AC adapter/charger and reattach it, and then turn power on again. Turn power off, and reinsert the disc. Then turn power on again. See *3 on page 171. If you have another disc available, check to see if any problem occurs with the disc. If another disc can be used normally, the original disc may be defective: Contact the disc manufacturer. <p>If the above procedures cannot solve the problem, take note of the error number, and contact your dealer.</p> <p>Reference: "Error Code 2881" shows that the disc cannot be recognized properly.</p> 	8, 40, 43, 44
(2) Error has occurred. Please reinsert a disc.		
(3) Error has occurred. Error code No. xxxx. Please read the manual.		
(4) ERROR xxxx		
(5) DISK xxxx		
Battery is almost empty. Replace it.	Replace with a charged battery, or use AC adapter/charger to power the DVD video camera/recorder.	39, 43
Cannot combine scene.	Unless consecutive scenes are selected, they cannot be combined.	116
Cannot combine. Deselect PHOTO scenes.	Select only movies and combine them.	116
Cannot combine. Select multiple scenes.	Select a range of at least 2 scenes to be combined, and then combine them.	116
Cannot delete scenes.	This may occur when scene that was edited for division, etc. is to be deleted. Combine the divided scenes, and then delete them.	116
Cannot execute. Change display category to ALL.	This message will appear if you attempt to combine or move scenes with "Category: VIDEO or PHOTO" specified.	138
Cannot execute. Unselect multiple scenes.	Division or change in thumbnail was executed when multiple scenes were selected.	108
CANNOT RECORD PHOTOS	Are you using DVD-R disc? You cannot record still image on DVD-R disc (recordable of still images from PC). Use DVD-RAM disc to record still images.	25
Cannot replace thumbnail on PHOTO scenes.	The thumbnail of a still cannot be changed. Select a movie.	113
Cannot select any more scenes.	The maximum number of selectable scenes is 999.	121
CARD ALMOST FULL	Remaining space is only enough to record less than 10 stills. Delete unnecessary stills and try the card, or use another card.	30, 111
Card error has occurred. Format the card now?	Was the card formatted on PC? Was formatting interrupted midway? When using the card on this DVD video camera/recorder, choose "YES" and format it.	135
Card error has occurred. Formatting is not complete.	The card may be damaged: Use another card.	28

Message	Cause & Troubleshooting	Reference page
Card error.	<ul style="list-style-type: none"> The card terminals may be dirty: Wipe off dirt, and try the card again, or use another card. Data other than still image may be included: Use another card. 	28
Card error has occurred. Keep card inside & restart.	Card error could have occurred during editing of scenes. Turn off the DVD video camera/recorder with the card being used inside, connect the AC adapter/charger, and then power the DVD video camera/recorder again. Repair of scenes will be attempted.	43, 48
Card full.	Delete unnecessary stills and try the card, or use another card.	30, 111
	No more recording on this card can be done: Delete unnecessary stills or use another card.	
Card full. Cannot execute.	Delete unnecessary stills and try the card, or use another card.	30, 111
Card has no data.	This message will appear when an attempt is made to execute playback or editing on Disc Navigation with no scene recorded.	—
Card is not formatted. Format the card now?	Was the card formatted on PC? When using the card on this DVD video camera/recorder, choose "YES" and format it.	135
Control Information Error.	Mismatch may occur between the recorded image and scene information. Update the control information.	136
	<ul style="list-style-type: none"> Use another disc. See *3 on page 171. 	25, 82
COPY PROTECTED	The video signal input to this DVD video camera/recorder may be copy-guarded. Some prerecorded video materials, such as movies, are guarded against copying. Copy-guarded materials cannot be recorded on this DVD video camera/recorder.	83
DISC ACCESS	The recorded scene is being stored on disc. Wait until the message disappears, and you can start to use the DVD video camera/recorder.	49, 50
	This DVD video camera/recorder is verifying whether the correct disc has been inserted. Wait until the message disappears, and you can start to use the DVD video camera/recorder. This message will be displayed for a little longer when the date changes.	—
DISC ALMOST FULL	The disc will soon be full, and recording will be impossible. Delete unnecessary scenes and try the disc again, or use another disc.	29, 111
Disc error has occurred. Finalizing is not complete.	<ul style="list-style-type: none"> Disc error occurred during finalizing, and finalizing failed. Replace the disc. See *3 on page 171. 	137
Disc error has occurred. Format the disc now?	<ul style="list-style-type: none"> Has the disc been initialized on PC? Has initializing the disc on PC been interrupted? Choose "YES" and initialize the disc when using it on this DVD video camera/recorder. Initializing the disc will erase all data on it. See *2 on page 171. 	135

Message	Cause & Troubleshooting	Reference page
Disc error has occurred. Formatting is not complete.	The disc may be dirty. Remove the disc and wipe off fingerprints, dust, etc. before reusing it, or use another disc. This message may also appear if you insert a disc for which formatting was interrupted midway. In this case, use another disc.	82, 135
Disc error has occurred. Keep disc inside & restart.	Disc error could have occurred during editing of scenes. Turn off the DVD video camera/recorder with the disc being used in it, connect AC adapter/charger, and then power the DVD video camera/recorder again. Repair of scenes will be tried.	43
Disc error.	<ul style="list-style-type: none"> • Use another disc. • See *3 on page 171. 	25, 82
	<ul style="list-style-type: none"> • Mismatch in recording information may be caused by editing done on some device other than this DVD video camera/recorder. Initialize the disc or use another disc. • Initializing the disc will erase all data on it. 	135
"DISCERROR" appears when an attempt to release write-protect is made.	If you have write-protected a disc using the write-protect setting tool (WPTOOL) that is equipped with the UDF driver contained on the CD-ROM provided with this DVD video camera/recorder, you cannot release the write-protect on this DVD video camera/recorder as is. Use the write-protect setting tool on PC to release the write-protect.	—
Disc full. Cannot execute.	Delete unnecessary scenes before using this disc, or use another disc.	111
Disc has no data.	This message will appear when an attempt is made to execute playback or editing on Disc Navigation with no scene recorded.	—
Disc has no Play List.	Switching of play list was selected with no play list stored.	127
Disc includes protected scenes. Delete scenes?	The disc may be software protected from a device other than this DVD video camera/recorder. To release this case, use a device that has executed software-protect.	—
Disc is full. Cannot add control info.	The number of entered scenes has reached the limit that can be entered, so the control information for generating thumbnails cannot be added. Combine several scenes or delete them.	111, 116
Disc is not formatted. Format the disc now?	<ul style="list-style-type: none"> • Has the disc been initialized on a PC? Choose "YES" and initialize the disc when using it on this DVD video camera/recorder. Initialization will delete all data on the disc. • See *2 on page 171. 	135
DPOF is not set to a scene.	This message will appear when "Slide Show: DPOF" is specified for the card to which DPOF was not set.	139
DPOF scenes over limit. Cannot set DPOF scenes.	The maximum number of scenes for which DPOF can be set is 999.	120
Drive overheat. Please retry later.	The temperature inside the DVD video camera/recorder is too high, and reading or writing of the data on disc may not be performed normally. Turn the DVD video camera/recorder off and wait for a while. The temperature will be effectively decreased if the DVD video camera/recorder is placed in a well-ventilated spot.	48

Message	Cause & Troubleshooting	Reference page
DVD-R Disc, Video mode cannot be changed.	With DVD-R disc, the movie quality mode once used for recording cannot be changed.	29
END OF DISC	The disc is full. You cannot record on this disc anymore. Prepare another disc or delete unnecessary movie scenes from this disc.	29
End scene cannot be divided.	Division is not possible at the end of scene.	117
Error occurred. Please replace disc or format disc.	<ul style="list-style-type: none"> Abnormality has occurred with the DVD-RAM disc to be repaired. Initialize the disc before using it, or use the another disc. Initializing the disc will erase all data on it. See *2 on page 171. 	135
Error occurred. Please replace disc.	An abnormality occurred with a DVD-R disc to be repaired. Replace the disc.	—
Finalize may not be complete. Finalize again now?	Instantaneous shutoff occurred during finalizing, after which power was supplied and disc was inserted.	137
It is unrecordable on this card.	The inserted card cannot be used in this DVD video camera/recorder: Use another card.	28
JPEG file related to scenes are not found.	This message will appear when stills recorded on DVD-RAM disc using a device other than this DVD video camera/recorder are to be copied to card.	—
No card.	Insert a card.	47
No card. Please insert card.	No card is inserted. Insert a card.	47
NO DISC	This message may appear when the DVD video camera/recorder or disc is moved from a cold place to a warm place. Condensation has occurred on the camera/recorder lens or DVD-RAM drive. Do not remove the disc; leave the DVD video camera/recorder turned off in a place as dry as possible for 1-2 hours.	8
	The disc has not been inserted. Insert it.	44
No more scenes. Play List was deleted.	<ul style="list-style-type: none"> All scenes are deleted from the play list. Since a play list with no scenes cannot be supported by specifications, a play list from which all registered scenes have been deselected will be deleted. 	129, 130
Photo cannot be divided.	Still image cannot be divided.	117
PlayLists over limit.	An attempt was made to create new play list or copy play list, even though limit specified for play lists in the video recording standard had already been stored.	126
Same scenes on Play List will be deleted. Delete scenes?	<ul style="list-style-type: none"> This will appear when scenes are to be deleted. When a play list exists on disc, an attempt to delete scenes in program will display this message. (This message will not appear if you deselect scenes from play list.) 	111

Message	Cause & Troubleshooting	Reference page
Scenes over limit. Cannot add scene.	The number of scenes entered in play list has reached the limit that can be entered. Delete several scenes.	126, 130
Scenes over limit. Cannot divide scene.	The number of entered scenes has reached the limit that can be entered. Delete several scenes.	117, 126
Scenes over limit. Cannot move scene.	This message will appear if you try to move a scene when the number of scenes has already reached the registrable limit.	114, 126
Stop processing	The button was pressed to stop processing of multiple scenes.	—
There was no scene which can be deleted.	This message will appear if you try to delete multiple scenes on Disc Navigation when all the selected scenes have been locked. Release the lock on scenes before executing deletion.	111, 119
This card cannot be used. Please replace card.	The card cannot be used in this DVD video camera/recorder: Use another card.	28
This disc cannot be used. Please replace disc.	A disc that cannot be used on this DVD video camera/recorder has been loaded. Check the type of disc.	26
This disc is recorded by the PAL system. Please replace disc.	This DVD video camera/recorder can use only discs recorded on the NTSC system. A disc recorded on the PAL system cannot be used on this DVD video camera/recorder.	—
Top scene cannot be divided.	Division is not possible at the start of scene.	117
UNFORMAT DISC	The disc is not initialized or it is damaged. If this message appears, be sure to initialize the disc on this DVD video camera/recorder before using it. Reinitializing even a disc used on this DVD video camera/recorder may be necessary (initializing will erase all recorded contents on disc). If this message appears, try to initialize the disc. If the same message still appears, the disc may be damaged: Use another disc.	135
	See *2 on page 171.	82
Use AC adapter/charger.	Finalization is not possible when the DVD video camera/recorder is powered by a battery: Use the AC adapter/charger for finalization.	43, 137
Use AC adapter/charger. Turn off power.	Scene cannot be repaired when the DVD video camera/recorder is powered by a battery. If the AC adapter/charger is unavailable in handy place, remove the disc, use the opposite side, or use another disc. To repair the removed disc, insert the disc into the DVD video camera/recorder afterwards, and connect the AC adapter/charger.	43
VIDEO scene cannot be copied to card.	No movie can be copied to card. Select stills and copy them to card.	118
Write protected. Check card.	<ul style="list-style-type: none"> • A locked card or write-protected disc is inserted. • Release the lock or write-protect using the Card or Disc Navigation menu. 	28, 134
Write protected. Check disc.		

*1

- This message may also appear when dirt adheres to disc. If this message appears when a recorded disc is recognized immediately after it is inserted, do not repair the disc; remove it and then use a soft, dry cloth to clean off the dirt before using it.
- This message may also appear when condensation occurs. In this case, do not repair the disc; turn the DVD video camera/recorder off, wait until it dries out, and then turn it on again.
- If the repair message appears when you turn the DVD video camera/recorder on from off with a disc loaded after recording on it, choose repair.
- If the repair message appears when recording and playback are normally possible with another disc - and no condensation occurs and the disc is not dirty - choose repair.

*2

- This message may also appear when dirt adheres to disc. In this case, do not initialize the disc; remove it and then use a soft, dry cloth to clean the dirt before using it.
- This message may also appear when condensation occurs. In this case, do not initialize the disc; turn the DVD video camera/recorder off, wait until it dries out, and then turn it on again.
- Initialization will delete all data on disc.

*3

- This message may also appear when dirt adheres to disc. Remove the disc and then use a soft, dry cloth to clean the dirt before using it.
- This message may also appear when condensation occurs. Wait until the DVD video camera/recorder dries out, and then turn it on again.
- This message will appear when a single-sided disc is inserted in reverse. Reinsert the disc correctly. (Insert the disc with the label printed surface facing the outside.)

Troubleshooting

Check to see the following before asking for a repair. If the suggested solution still cannot restore the DVD video camera/recorder to normal, do not attempt to repair it yourself, but consult your dealer.

Power supplies

Symptom	Cause and Correction	Reference page
Battery cannot be charged.	Is the ambient temperature too low or too high? Charge the battery at 50-86°F (10-30°C).	39
	Is the battery abnormally hot? Remove the battery, leave it for a while to cool down, then charge it.	
	Is the DC power cord connected to AC adapter/charger? Unplug it.	
	Has the battery been unused for a long time? Remove the battery, and then reattach it. If the battery is still not charged, it may be dead: Purchase a new one. * If the battery does not charge after you try the above four procedures, it may be dead: Purchase a new battery.	
Battery weakens fast	Are you using the DVD video camera/recorder where the temperature is low? A fully charged battery (DZ-BP14S or DZ-BP14SW) may be discharged sooner than usual at low temperatures. Keep extra batteries on hand.	41
	Battery may be dead. The performance of battery will deteriorate if it is used for an extended period of time or frequently: Purchase a new battery.	42
The CHARGE indicator on AC adapter/charger is blinking.	Is the ambient temperature too low or too high? Charge the battery in environment where the temperature is 50-86°F (10-30°C). The battery has possibly discharged excessively. Continue charging: After a while, the battery will be charged to the specified voltage, and the CHARGE indicator will light. Then the battery charge will be completed normally.	39
Power turns off immediately after being turned on.	Is battery charged? Charge it.	39
When power is turned on, the LCD screen will turn on and off.		
Power goes off unexpectedly.	Is Power Save set to "On"? If the powered DVD video camera/recorder is left for as long as 5 minutes without recording or playback with "Power Save: On" specified, it will automatically turn off to save battery power. To restart recording in this case, set the power switch to "POWER OFF" and then set it to "VIDEO". You can also specify "Power Save: Off" to stop automatic power off.	102
Power cannot be turned off.	Detach the battery or AC adapter/charger once, and then press the RESET button of DVD video camera/recorder: Reattach a power supply to DVD video camera/recorder before turning it on again.	—

During recording

Symptom	Cause and Correction	Reference page
Pressing the REC button will not start recording.	Is input image copy-guarded? Is the disc write-protected or the card locked?	28, 84, 134, 163
Recording starts but stops immediately.	Is disc scratched or does dirt or fingerprint adhere to it? Clean the disc. If there is still no improvement, replace the disc.	82
	Is some other AV device directly connected to the video/audio input/output jack of this DVD video camera/recorder? If the AV device is connected via several other devices, such as AV selector, the video signal may not be transmitted incorrectly. In such a case, reduce the number of devices through which the video signal is transmitted, or connect AV device directly.	83
	Are you attempting to record image from video game or PC? From some video games or PCs, image cannot be recorded on this DVD video camera/recorder.	83
LCD screen is hard to see.	Has brightness of LCD screen been adjusted? Stop recording and adjust the brightness.	101
	Is the DVD video camera/recorder being used outdoors? Use the viewfinder. When using LCD monitor, adjust its angle so that LCD screen is not exposed to direct sunlight.	36, 48
Focus is not correct.	Is it difficult to use auto focus with your subject? Focus manually.	72
	Does "MF" appear? The DVD video camera/recorder is set to manual focus. Focus the subject manually, or release manual focus.	71
	Is the diopter control correctly adjusted if you are using the viewfinder as a monitor? Adjust the diopter control.	34
	In cases other than the above, set the power switch to "POWER OFF", and then set it to "📹 VIDEO", "📷 PHOTO" or "📷 PHOTO" again.	48

During playback

Symptom	Cause and Correction	Reference page
Recognition of disc is not complete	Is disc dirty? Use soft, dry cloth to clean it.	82
Pressing the playback button will not start playback.	Has the image been recorded by devices other than this DVD video camera/recorder? Playback of image recorded on devices other than this DVD video camera/recorder may be impossible on this DVD video camera/recorder.	136
	Has scene been edited on a device other than this DVD video camera/recorder? If a scene recorded on this DVD video camera/recorder is edited on a device other than this DVD video camera/recorder, playback may not be possible on this DVD video camera/recorder.	
No playback picture appears on TV screen.	Is TV input selector set correctly? Some TVs have multiple video input jacks. Check whether the correct input was selected on TV to match the connected jacks. If the DVD video camera/recorder is connected to VCR, set its input selector to "external input (LINE)".	78
	Is the DVD video camera/recorder connected to TV correctly? Check the connections.	77
Playback picture is momentarily interrupted.	Is disc scratched or does dirt or fingerprint adhere to it? Clean the disc.	82
Poor playback picture	Was the image input from analog VCR (VHS, 8 mm) and recorded? The problem may be improved if a VCR equipped with TBC circuit is used for playback.	—
Playback picture is greatly distorted.	Was recording of external input made with "Frame" specified? Specify "Field" for "PHOTO Input" in record mode settings.	98
No sound	Is the TV volume control set correctly? Adjust TV volume control, and be sure to adjust the volume on TV.	78
Disc Navigation thumbnails do not appear.	Was the image recorded from AV input/output jack with interference? Record image with no noise or disturbance.	—

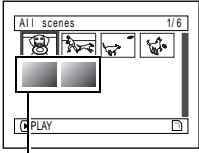
Symptom	Cause and Correction	Reference page
<p>Photos on card cannot be played back.</p>	<p>This DVD video camera/recorder can play back image data recorded on SD memory card in other digital cameras conforming to the DCF (Design rule for Camera File system) standard. The range of image data normally playable on this DVD video camera/recorder is that with pixels from 80 horizontal x 60 vertical to 4000 horizontal x 3000 vertical. If the pixel data is outside this range, blue thumbnails will appear (thumbnails* in the figure), meaning the image is unplayable.</p>  <p style="text-align: center;">Fig. 1</p> <p>Even when the number of pixels is within the above range, playback may not be possible, depending on the recording status of the digital cameras used.</p> <p>DCF (Design rule for Camera File system) is an integrated image file format of digital cameras: Image files can be used on all digital devices conforming to DCF.</p>	<p style="text-align: center;">—</p>
<p>It will take some time to play back photos on card.</p>	<p>When playing back a still, "Playback." will appear: Stills with a large number of pixels will take some time to appear.</p>	<p style="text-align: center;">—</p>

When the DVD video camera/recorder is connected to PC:

Symptom	Cause and Correction	Reference page
No drive icon appears on PC.	The DVD video camera/recorder is not turned on. Check the power supply.	48
	Driver is not properly recognized. Turn PC off and on again. If the drive icon still does not appear, use "Refresh driver" in Device Manager to reinstall the driver.	—
	Turn PC off and then disconnect the PC connection cable. Turn PC on again, and then use the PC connection cable to connect the DVD video camera/recorder to PC.	—
	Make sure the PC connection cable is completely plugged into this DVD video camera/recorder.	—
	If a yellow "!" mark is attached to some device in Windows® Device Manager, uninstall the USB device driver, and then reinstall it, following the procedure on page 145.	—
A fatal exception 0A error occurs while installing USB driver in Windows® 2000 Professional.	It is recommended that you install Windows® 2000 Service Pack 3 or later.	—
Error occurs in playback of DVD video camera/recorder on PC.	If error occurs with USB connection, the transfer rate is not sufficient. It is recommended that you use a USB terminal conforming to USB2.0 when connecting the DVD video camera/recorder.	—
Application is not normally run on PC.	Turn the PC and DVD video camera/recorder off, and try again.	—
Error occurs during writing to DVD-R disc.	The temperature of DVD video camera/recorder is too high due to continuous operation. Disconnect the DVD video camera/recorder from PC once, remove the disc from the DVD video camera/recorder, and then turn it off. After a few moments, connect them again and write to a brand-new disc.	—
Transfer of images stops.	Connect the DVD video camera/recorder to another USB terminal of PC. If your PC is a desktop type, it is recommended that you use USB terminal on the back of PC. If you are using USB2.0 extended card, it is also recommended that you install the newest version driver provided by each USB2.0 card maker.	—
DVD-RAM/R/RW drive built into PC cannot be used after the provided software has been installed.	This problem may be solved if the software related to DVD-RAM/R/RW of your PC is upgraded, or if the UDF driver is uninstalled. However, with Windows® 98 Second Edition / Me / 2000 Professional, uninstalling the UDF driver will make it impossible for the JPEG stills recorded on DVD-RAM of this DVD video camera/recorder to be read by the PC.	—
DVD-R disc cannot be played back on DVD-MovieAlbumSE.	DVD-MovieAlbumSE does not support playback or data read on DVD-R disc: Use generally available DVD video playback software to play back DVD-R disc on PC.	148
Error appears when starting DVD-MovieAlbumSE.	Make sure that your PC display adapter (video card) conforms to DirectX8.1.	—

Symptom	Cause and Correction	Reference page
Video written to hard disk of PC cannot be edited on DVD-MovieAlbum copy tool.	DVD-MovieAlbumSE cannot edit DVD-VR data stored on hard disk of PC: Copy the data to another DVD-RAM disc and then edit it.	—
Movies are not recognized by application in PC.	Make sure the power switch of this DVD video camera/recorder is set to "VIDEO", "PHOTO" or "CARD PHOTO".	—
The DISC EJECT button is not valid when the DVD video camera/recorder is connected to PC.	While the DVD video camera/recorder is connected to PC, use Explorer to right-click the DVD video camera/recorder drive icon and execute "Eject". If DVD-MovieAlbumSE is running, clicking the eject button on DVD-MovieAlbumSE will open the cover of disc insertion block of this DVD video camera/recorder: Remove the disc.	—
When the time stamp of file in DVD-RAM is viewed on PC, it is different from the actual recording time.	The file system of this DVD video camera/recorder is operated on Greenwich Mean Time (GMT), and time lag information has not been set. With Windows® as of January, 2004, the time stamp of file viewed on Explorer looks different from the actual recording time. The actual recording time will appear for date/time indication on playback screen.	—
When DVD-MovieAlbumSE is started, "Disc in Drive X: cannot be used" appears.	A disc other than DVD-RAM is loaded in drive: DVD-MovieAlbumSE cannot be used for media other than DVD-RAM.	—
	Click the "Preference" button in the dialog box, click the "Device Setting" tab to choose the drive where DVD-RAM disc is loaded in the "Drive Select" column, and then click "OK".	—
An image that should have been recorded does not appear when DVD-MovieAlbumSE is started.	Click the "Preference" button at top right of DVD-MovieAlbumSE screen, click the "Device Setting" tab to choose the drive where DVD-RAM disc is loaded in the "Drive Select" column, and then click "OK".	—
"DISC ERROR" appears when releasing write-protect.	A disc that was write-protected using the write-protect setting tool (WPTOOL) equipped with the UDF driver on the CD-ROM provided with this DVD video camera/recorder cannot be released on this DVD video camera/recorder as is. Use the write-protect setting tool on PC to release the write-protect.	—
"USBNTMAP.SYS not found" appears while installing USB driver.	You have designated a folder which is different from that for Windows® when installing USB driver: Designate the correct folder.	—
No USB HS (high speed) connection even when USB2.0 card is used.	Make sure that you have already installed the driver provided with the USB2.0 card. You will need to install the driver provided by USB2.0 card maker in order to operate the USB2.0 card at HS (high speed).	152
The "capture" function of MyDVD is unavailable.	The "capture" function of MyDVD is only for DVD camera with i.Link connection: It is not available on this DVD video camera/recorder. Use DVD-MovieAlbumSE to import the images recorded on DVD-RAM disc into the PC.	—

Symptom	Cause and Correction	Reference page
Executing "Export" on DVD-MovieAlbumSE will interrupt reading midway.	Do not choose "Simple Export": If you do, reading will stop midway.	—
When executing "Export" on DVD-MovieAlbumSE, it will take time to read.	<ul style="list-style-type: none"> • If stills are included in the range of "export", it may take more time because data must be re-encoded and read. • If "Divide by Maker" is not chosen, it may take some time because data will be read while being re-encoded. 	152
"Hardware Removal" results in error.	Exit Windows® once, and then disconnect the DVD video camera/recorder. If your PC uses Windows® 2000 Professional, the problem may be solved if you install Windows® 2000 Service Pack 3 or later.	—

Miscellaneous

Symptom	Cause and Correction	Reference page
Power does not come on, or no operation occurs by pressing button.	Execute system reset (press the RESET button).	181
	Has the DVD video camera/recorder been subjected to impact? The DVD video camera/recorder could be damaged. Consult your dealer.	—
The date and time are incorrect.	Has the DVD video camera/recorder been left unused for a long period of time? The internal backup memory battery may be discharged: Charge it.	37
No scene can be deleted.	Is the cursor placed on the scene to be deleted? If the selected scene (framed in red) exists, that scene will be deleted even if you use yellow cursor to select any scene. Check the colors of cursors and bar graph on the thumbnail screen.	106
Disc cannot be removed.	Did you detach the battery or AC adapter/charger before setting the power switch to "POWER OFF"? Connect the battery or AC adapter/charger, set the power switch to "VIDEO" and then "POWER OFF", and remove the disc.	43, 48
DVD video camera/recorder cannot be operated from remote control.	Is the remote control pointed at the infrared receiver on DVD video camera/recorder? Point it at the infrared receiver to operate the DVD video camera/recorder.	34
	Is the infrared receiver on DVD video camera/recorder exposed to direct sunlight or strong fluorescent light, etc.? The remote control cannot operate the DVD video camera/recorder when strong light strikes the infrared receiver. Adjust the place or angle of the DVD video camera/recorder.	34
	Is there battery in the remote control? Also check the polarities of battery. The battery could be dead: Try replacing it.	33
	Is the DVD video camera/recorder powered? Turn it on.	48

Symptom	Cause and Correction	Reference page
Disc cover cannot be closed.	Is disc correctly inserted? Was disc inserted from wrong direction? Remove the disc and then reinsert it.	44
	Is disc inserted in wrong orientation? Remove the disc, and then reinsert it.	44
	Connect a fully charged battery or AC adapter/charger, and then turn the DVD video camera/recorder on.	39, 43
Cover will not open.	Did you disconnect the battery or AC adapter/charger during removal of disc? Reconnect the battery or AC adapter/charger, and then turn the DVD video camera/recorder on.	40, 43
Operating sound is heard cyclically.	This sound is heard because the disc is cyclically operated and does not indicate a fault.	—
Some vibrations are felt or slight sound is heard from mechanism.	These vibrations or sound are caused by disc drive: This does not indicate a fault.	—

System Reset

If the DVD video camera/recorder does not operate normally, perform "System Reset": The DVD video camera/recorder may recover to normal. "System Reset" will reset all settings to factory defaults. The date and time will also be reset: Set the date and time again before using the DVD video camera/recorder.

- 1 Set the power switch to "POWER OFF" to turn the DVD video camera/reorder off.

Detach the battery or AC adapter /charger.

- 2 Use a fine tipped pen to hold down the reset button for several seconds.

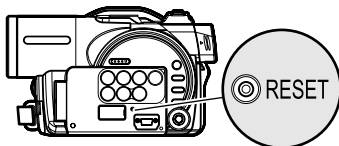

All settings will be reset.

Note:

Do not press the reset button with undue force.

● List of setting items

	Item	Default	Setting method
Camera Functions Setup	Program AE	Auto	P. 90
	White Bal.	Auto	P. 91
	EIS	On	P. 93
	Dig.Zoom	40x	P. 56
	MIC.Filter	Off	P. 93
	16:9	Off	P. 94
Record Functions Setup	VIDEO Mode	FINE	P. 96
	Quality	FINE	P. 97
	Input Source	CAMERA	P. 98
	PHOTO Input	Field	P. 98
	Self Timer	Off	P. 99
	OSD Output	On	P. 100
Date Setup	Date Mode	M/D/Y	P. 38
	Date Set	1/1/2004 12:00AM	P. 37
LCD Setup	Brightness	- <input type="checkbox"/> <input type="checkbox"/> +	P. 101
	Color Level	- <input type="checkbox"/> <input type="checkbox"/> +	P. 101
Initial Setup	Beep	On	P. 102
	Power Save	Off	P. 102
	Record LED	On	P. 103
	Language	English	P. 103
	Demo Mode	Auto	P. 159

* Some items will not appear depending on the disc or card inserted.

Major Specifications

CCD		DZ-MV550A: 1/4-inch interlaced DZ-MV580A: 1/3.8-inch interlaced
		Total number of pixels DZ-MV550A approx. 680,000 DZ-MV580A approx. 1,020,000
		Number of effective pixels DZ-MV550A Movie: approx. 340,000 Still: approx. 340,000 DZ-MV580A Movie: approx. 400,000 (approx. 530,000 when 16:9 is set) Still: approx. 960,000
Lens		DZ-MV550A: F1.8-2.8, f = 1/16"-1-1/2" (2.1-37.8 mm) DZ-MV580A: F1.8-2.4, f = 3/16"-1-1/2" (3.8-38 mm) Filter diameter: 1-7/16" (37 mm); thread pitch: 0.75 mm
Focus		Auto/Manual
Zoom		Optical 18x (DZ-MV550A), Optical 10x (DZ-MV580A), (40x-500x (DZ-MV550A), 240x (DZ-MV580A) with digital zoom added) 40x for still
Required minimum illumination		0.3 lx : When Low Light mode is selected
Viewfinder		0.33-inch color TFT (approx. 110,000 pixels)
LCD monitor		2.5-inch color TFT (approx. 120,000 pixels)
Electronic image stabilizer		Electronic type
Shutter speed		1/60 - 1/4000 second (movie)
Self-timer recording		Still recording only
External microphone jack		ø3.5 mm stereo mini-jack: (a plug-in power type microphone cannot be used)
Recording mode		Movie (with sound) Still (with DVD-RAM disc, SD memory card, MultiMediaCard)
Maximum recordable time (per side)	DVD-RAM disc	approx. 18 minutes (XTRA) approx. 30 minutes (FINE) approx. 60 minutes (STD)
	DVD-R disc	approx. 30 minutes (FINE) approx. 60 minutes (STD) approx. 30 minutes (LPCM)
Maximum number of recordable stills	DVD-RAM disc (per side)	999. However, if movies and stills are mixed on one disc, the recordable number will decrease.
	SD memory card (when using 32 MB card)	DZ-MV550A approx. 220 (in FINE mode) DZ-MV580A approx. 50 (in FINE mode) Varies depending on the recording quality and the type of card. (P. 30)

Recording format	DVD-RAM disc	Movie: Conforming to DVD video recording (DVD-VR) format (MPEG Audio layer 2) Still: Simultaneous recording, conforming to DVD video recording (DVD-VR) standard (704 × 480 pixels) and JPEG (DZ-MV550A: 640 × 480 pixels, DZ-MV580A: 1280 × 960 pixels*) * External input: 640 × 480 pixels
	DVD-R disc	Movie: Conforming to DVD video format (when MPEG Audio layer 2 or LPCM* is selected)
	Card	Still: Conforming to JPEG (DZ-MV550A: 640 × 480 pixels, DZ-MV580A: 1280 × 960 pixels*) standard * External input: 640 × 480 pixels
Audio playback format		MPEG Audio layer 2, linear PCM, Dolby AC3
Recording medium		8 cm DVD-RAM disc (conforming to DVD-RAM Ver. 2.1) 8 cm DVD-R disc (conforming to DVD-R for General Ver. 2.0) SD memory card, MultiMediaCard
Jacks		Video/audio input/output × 1, External microphone input × 1, PC connection terminal (connected to PC USB port) × 1
Battery system		Lithium-ion
Power consumption		When recording with LCD monitor off (DVD-RAM disc used) DZ-MV550A approx. 4.1W (in FINE mode) DZ-MV580A approx. 4.4W (in FINE mode)
Dimensions (W × H × D)		approx. 2-1/2" × 3-1/2" × 5-3/4" (64 × 89 × 146 mm) (excluding projections)
Operating temperature (humidity)		32-104 °F (0-40 °C) (less than 80%). 32-86 °F (0-30 °C) when connected to PC
Storage temperature		-4-140 °F (-20-60 °C)
Weight		DZ-MV550A approx. 490 g (without battery or disc) DZ-MV580A approx. 500 g (without battery or disc)
Total weight when recording		DZ-MV550A approx. 575 g DZ-MV580A approx. 585 g
Provided accessories		AC adapter/charger, battery, AV/S input/output cable, infrared remote control, Lithium battery for remote control, lens cap, lens cap string, shoulder strap, power cable, DC power cord, Software CD-ROM, PC connection cable, Single-sided 8 cm DVD-RAM disc (in Round DVD Holder)

* The MPEG Audio layer 2 format is an option of DVD video standard. If your DVD player does not conform to MPEG Audio layer 2, record in LPCM mode and the finalized DVD-R disc can later be played back on that DVD player.

To Order in the United States

BY PHONE

**Service Hotline: 1-800-HITACHI
(1-800-448-2244)**

To Order in the Canada

**FOR AUTHORIZED HITACHI SERVICE
FACILITY IN CANADA**

Please consult the following telephone number
Service Direct: 1-800-HITACHI
(1-800-448-2244)

Choisissez les articles qui vous conviennent et
passez commande.

Service Direct: 1-800-HITACHI
(1-800-448-2244)

**TO ORDER ACCESSORIES
(Canada only)
BY PHONE**

**HITACHI CANADA LTD.
DIGITAL MEDIA DIVISION**

2495 Meadowpine Blvd.
Mississauga, Ontario
L5N 6C3

Service Direct: 1-800-HITACHI
(1-800-448-2244)

**POUR COMMANDER DES
ACCESSOIRES
(Canada seulement)
PAR TÉLÉPHONE**

**HITACHI CANADA LTD.
DIGITAL MEDIA DIVISION**

2495 Meadowpine Blvd.
Mississauga, Ontario
L5N 6C3

Service Direct: 1-800-HITACHI
(1-800-448-2244)

during business hours

Monday-Friday EST 9:00am-7:00pm
Saturday EST 9:00am-5:00pm

Durant les heures de bureau:

Lundi au vendredi 9:00am-7:00pm (h.n.e)
Samedi 9:00am-5:00pm (h.n.e)

DECLARATION OF CONFORMITY

with FCC Rules for Electromagnetic Compatibility

Products: DVD VIDEO CAMERA/RECORDER
Models: DZ-MV550A/DZ-MV580A
Trade Name: HITACHI

This device complies with part 15 of FCC Rules.

Operation is subject to the following two conditions: (1) this device may not cause harmful interference, and (2) this device must accept any interference received, including interference that may cause undesired operation.

Responsible Party: HITACHI AMERICA, LTD.
HOME ELECTRONICS DIVISION
900 Hitachi Way
Chula Vista, CA 91914-3556 U.S.A
Tel: 619-591-5200

Index

Numerics

16:9	94
240x (Dig. Zoom)	56
40x (Dig. Zoom)	56
500x (Dig. Zoom)	56
8 cm DVD-R disc	25
8 cm DVD-RAM disc	25

A

AC adapter/charger	43
ACCESS/PC indicator	49, 50
Add (edit)	129
Advanced mode	87
All programs	123
Auto (program AE)	90
Auto-focus	71
AV input/output jack	77

B

Backlight correction	51
Battery	39
Attaching to DVD video camera/recorder	40
Charging	39
Recordable time on DVD video camera/ recorder	41
Removing from DVD video camera/ recorder	40
Setting Up	39
BATTERY EJECT button	40
Beep	102
Black & White fade	115
Brightness	101

C

Camera Functions Setup	90
Capacity	134
Card	
Available	28
Capacity	30, 134
Category	138
Format	135
Handling	28
Quality	97
Card Access indicator	50
CHARGE indicator	39
Cleaning	158
Color Level	101
Connecting to TV	77
Copy	118
Create	126

D

Date and time	37
Date setup	37
Defaults	104
Delete (edit)	130
Delete (play list)	132
Delete (scene)	111, 129
Demo Mode	159

Detail (scene)	122
Dig. Zoom	56
Dioptr control	34
Disc	25
Available	25
Capacity	29
Finalize Disc	137
Format	135
Handling	27
Protect	134
Update Control Info.	136
DISC EJECT button	46
Disc guide	44
Display	52
Information LCD	52
Scenes information	122
Viewfinder	34
Divide	117
DPOF	120
DVD player	79, 80, 160
DVD-R	25
DVD-RAM	25
DVD video format	160
DVD video recorder	79, 160
DVD video recording (DVD-VR) format	30, 160

E

Edit (play List)	129
EIS	93
EXPOSURE button	73
Exposure control	73
External microphone jack	76

F

Fade	115
FIELD (PHOTO Input)	98
Finalize Disc	137
FINE (VIDEO Mode)	96
FOCUS button	71
Format Disc	135
FRAME (PHOTO Input)	98
Frame advance/Frame back	59
FULL AUTO button	74

G

Go To (during playback)	61
Go To (on Disc Navigation)	133

H

Hand strap	31
Howling	77, 161

I

Information display mode	52
Infrared receiver	34
Infrared sensor	161
Initial Setup	102
Input Source	98

L	
Language	103
Laser pickup block	46, 161
Lens cap	32
Lens cap string attachment hole	17
Linear PCM	35, 80, 161
Lock	119
Lock switch	18
Low Light (Program AE)	90
LPCM (VIDEO Mode)	96

M	
MENU button	89
MF	71
MIC.Filter	93
Move	131

O	
Optical 10x zoom lens	17
Optical 18x zoom lens	56
OSD Output	100

P	
PHOTO Input	98
Play (play list)	127
Play (program)	124
Play list	126
Add scenes	128
Add scenes (submenu)	129
Create	126
Delete	132
Delete scenes	129
Delete scenes (submenu)	130
Move	131
Play	127
Select scenes (submenu)	130
Switch	127
Title	132
Portrait (Program AE)	90
Power Save	102
Power switch	48
Program	123
Play	124
Switch	123
Title	124
Program AE	90
Protect Disc	134

Q	
Quality (Card)	97
Quick mode	63
QUICK MODE switch	87

R	
Record button	49
Recording indicator	103
Remote control	33
Repeat Play	138
Reset	104
settings	104
system	181
RESET button	181

S	
Sand & Snow (Program AE)	90
Scene	
Combine	116
Delete	111
Detail	122
Divide	117
Fade	115
Move	131
Select	121
Skip	114
Searching for image	59
Select (Scene)	108
SELECT button	108
Self Timer	99
Shoulder Strap	32
Skip (Scene)	114
Skip playback	60
Slide Show	139
Sports (Program AE)	90
Spotlight (Program AE)	90
STD (VIDEO Mode)	96
Stereo microphone	49
Submenu	112
Switch (play list)	127
Switch (program)	123

T	
Tele-conversion lens	57
Thumbnail	106
Title (play list)	132
Title (program)	124

U	
UDF2.01 format	156, 162
Update Control Info.	136

V	
Video flash	75
VIDEO Mode	96
FINE	96
LPCM	96
STD	96
XTRA	96
Video selector	84, 95, 162
Vol. button	58

W	
White Bal.	91
White fade	115
Wide conversion lens	57
Wipe fade	115

X	
XTRA (VIDEO Mode)	96

Z	
Zoom lever	56

Be sure to read the following before opening the package of CD-ROM

This Agreement will take effect at the moment you open the package of the storage device (CD-ROM) provided with this product, if you agree to the terms herein.

If you do not accept the terms of this Agreement, immediately return the unopened package of storage medium and enclosed materials (printed matter, external package, and all others) to your dealer, or return only the package of storage medium to your dealer.

Consult your dealer for any refund on the unused product. However, if only the package of storage medium is returned, no refund is possible.

This License Agreement certifies that you were granted license in the past.

License Agreement

Article 1 Grant of License

Hitachi, Ltd. grants you the following rights for the following products (to be referred to as "This Software" hereafter) that you have obtained with this Agreement:

- (a) You may use This Software only on a single piece of equipment. However, if this equipment cannot be used because of mechanical problem, you may temporarily use This Software on another piece of equipment.
- (b) Although This Software contains several components that can be run on computer as independent functions, all components are licensed as a single product: You may not, by any means, use these components on different computers at the same time.

Article 2 Copyrights

The copyrights of This Software, attached manual, etc. are owned by the following corporations, and are protected by copyright laws in Japan and USA, as well as by other intellectual property and international properties:

Name of Software	Copyright Owners
USB device driver for DVDCAM	Hitachi, Ltd.
UDF driver (DVD-RAM driver)	Matsushita Electric Industrial Co., Ltd.
DVD-MovieAlbumSE	Matsushita Electric Industrial Co., Ltd.
MyDVD	Sonic Solutions

Article 3 Other Rights and Limitations

- (a) You may not copy This Software or any of the printed materials attached, except for duplications to provide back-up or storage.
- (b) Use of This Software by third parties is prohibited, whether by transferring, renting, leasing, lending, moving, or any other measures.
- (c) You may not decompile or disassemble this Software.
- (d) Duplication and/or distribution of any files on this storage medium for commercial use is prohibited.

Article 4 Quality Assurance

Under no circumstances will Hitachi, Ltd., Matsushita Electric Industrial Co., Ltd. or Sonic Solutions accept any responsibility for any damages you may incur from using or being unable to use This Software (including, but not limited to, loss of business profit, interruption of business, loss of business information, or other monetary damages).

Article 5 Termination of Agreement

If you fail to comply with the terms of this Agreement, Hitachi, Ltd., Matsushita Electric Industrial Co., Ltd. and Sonic Solutions reserve the right to terminate the Agreement. In such a case, you will be obliged to discard all copies of This Software and its components.

Article 6 Prioritized License Agreement

When some software programs are installed, the license agreements will be displayed (to be referred to as online license agreement).

If the online license agreement conflicts with this Agreement, the online license agreement shall have a priority.