

USER MANUAL

HITACHI

Inspire the Next

LCD Television

Model Name

L37X01AU

L42X01AU



This is the image of the model L37X01AU. Desktop stand for L42X01AU is optional.



DVB[®] HDTV

HDMI[™] HIGH-DEFINITION MULTIMEDIA INTERFACE
DD DOLBY DIGITAL

READ THE INSTRUCTIONS INSIDE CAREFULLY.
KEEP THIS USER'S MANUAL FOR FUTURE REFERENCE
For future reference, record the serial number of your television.
SERIAL NO. _____
This serial number is located on the rear of the television.

USER MANUAL

Thank you for purchasing the HITACHI LCD Television.
Please read this user manual carefully before operating
this product.

To ensure proper operation, please read and follow ALL
the instructions, especially the "IMPORTANT SAFETY
INSTRUCTIONS" and "SAFETY PRECAUTIONS".

Please keep this user manual for future reference.

CONTENTS

IMPORTANT SAFETY INSTRUCTIONS	01	TV SETUP OPERATION	25
INSTRUCTIONS	02	How to use the On-Screen Display (OSD) system	25
About This Manual	02	Main Menu List	26
Trademark Credits	02	Setup Menu (TV mode)	27
About Software	02	Channel Selections	29
Features	02	Picture Setting	30
SAFETY PRECAUTIONS	03	Audio Setting	32
About the Symbols	03	Timer Menu	33
Cleaning and Maintenance	06	Audio Switching (TV)	34
ABOUT LCD PANEL	07	PC Adjustment Setting	35
Other Common Characteristics of LCD Panel	07	Analog Teletext	37
QUICK START GUIDE	08	DIGITAL TERRESTRIAL TELEVISION (DTT)	
1. Supplied Accessories (including option)	08	OPERATION	39
2. Connection	08	How to use the On-Screen Display (OSD) system	39
3. Insert the batteries into the remote control	09	DTT Main Menu List	39
4. Removing the Protective Sheet	09	Installing Channels	40
5. Switch On	09	Restoring Channels	40
6. Auto Tuning	09	Channel Selections	41
COMPONENT NAMES	10	Making Favorite List	42
Main Unit	10	Information Banner	42
Remote Control	12	Digital Teletext	43
PREPARATION	13	Electronic Program Guide (EPG)	43
Remote Control Batteries Installation	13	Subtitle	44
Handling the Remote Control	13	Parental Guidance	44
Caution When Moving the Main Unit	13	Audio Language (MPEG/Dolby® Digital)	44
Safety Precaution on Main Unit Installation	14	Digital Audio Output	44
Anti-Tumble Measures	14	Change Pin	45
CONNECTION	15	Local Time	45
Terminal Positions	15	Checking DTT System Information	45
Connecting Procedure	15	Jump to TV Setup Menu	45
BASIC OPERATION	22	FUNCTION	46
POWER On/Off	22	Size Switching	46
Volume UP/DOWN	23	Multi Picture Mode	47
Mute	23	Picture Freezing	50
Input Switching to DTT/TV, AV1~4, HDMI1~3, and RGB	23	Power Save Mode	50
Input Signal Screen Display	24	DVD Player/ STB Selection	51
		TROUBLESHOOTING	52
		When Following Messages Appear on the Screen	52
		Symptom and Check List	52
		PRODUCT SPECIFICATIONS	55
		Signal Input	56
		Recommended Signal List	57

IMPORTANT SAFETY INSTRUCTIONS

- Read this instruction thoroughly.
- Retain this instruction for future reference.
- Heed all warnings and cautions to prevent possible danger.
- Follow all instructions. Improper handling could cause personal injury and/or serious damage to the unit that may shorten its service time.
- Do not block any ventilation openings.
- Install the product in accordance with the manufacture's instructions.
- Before calling for the technical support or service technician, read "TROUBLESHOOTING" (52 ~ 54) to determine the symptoms when problems occur during installation or operation of the product.
- If serious problems happen (such as smoke or an abnormal odor from the unit), turn off the Main Power, unplug the Power Cord, and then, contact your local dealer immediately.

INSTRUCTIONS

Thank you for purchasing the HITACHI LCD Television. We hope that you will enjoy the great performance with this product. This LCD Television has been designed to meet the International standards. However, it could cause personal injuries and property damage if improperly handled. In order to prevent potential danger and obtain maximum benefit from your set, please observe the following instructions when installing, operating, and cleaning the product. Keep this manual for future reference, and record the serial number of your set in the space provided on the front cover page of this manual.

About This Manual

- The information in this manual is subject to change without notice.
- This manual has been created with extra care. In case that you have any comments or questions regarding this manual, please contact your local dealer or our Customer Service Center.
- Before operating this set, please fully understand the prerequisite such as specifications or constraints of the hardware and software. We are not responsible and have no liability for any loss, damage or injury as a result of misuse.
- Reproduction, copying, use, modification, and/or transmission in whole or in part of this manual are prohibited without any prior written permission.
- All other products and company names used in this manual are trademarks or registered trademarks of their respective owners.

Trademark Credits

- VGA and XGA are trademarks of International Business Machines Corporation.
- VESA is a registered trademark of the Video Electronics Standard Association.
- HDMI, the HDMI logo and High-Definition Multimedia Interface are trademarks or registered trademarks of HDMI Licensing LLC.
- DVB is registered trademark of the DVB Project.
- Manufactured under license from Dolby Laboratories.
“Dolby” and the double-D symbol are trademarks of Dolby Laboratories.

Even if no special notation has been made of company or product trademarks, these trademarks have been fully respected.

About Software

You may not alter, decompile, disassemble, decrypt, or otherwise reverse-engineer the Software installed in this product, which are prohibited by law.

Features



- Large-screen and high-definition LCD panel.
- Enjoy high resolution display with 1920 (H) x 1080 (V) pixels.
- Improved Digital signal processor.
- High quality sound with deeper, richer and dynamic bass tones.
- Accept more digital input devices with 3 HDMI terminals.
- Great diversity of connecting terminals to cover wide range of audio-visual equipment.
- Enjoy the image from PC with large, high-definition LCD screen.
- Easy-to-use On-Screen Display system operating with remote control.
- Low power consumption with power saving feature.
- Swivel feature.(Desktop stand is optional for L42X01AU)



SAFETY PRECAUTIONS





For your safety, please read the following precautions carefully before using this product. Improper use would cause serious personal injuries and/or damage to your property or this product.

About the Symbols

The following are the symbols used in this manual and affixed on the unit itself. Please fully understand the meanings of the symbols before reading the precautions in this section.

	WARNING	Never ignore the instruction. There are risks of serious injuries or possible death to the user.
	CAUTION	Do not ignore the instruction. There are possibilities of personal injuries and/or property damage.

Other Symbols	
	The triangle with illustration is intended to alert the users that there are possibilities of fire, explosion, or high temperature if the product is handled improperly. Each illustration within the triangle specifies the contents in detail. (The figure on the left is an example.)
	The circle with diagonal line and illustration indicates a prohibited action. (the symbol at the left indicates that disassembly is prohibited.)
	This symbol indicates a compulsory action. The contents will be clearly indicated in an illustration or nearby. (the symbol at the left indicates that the power plug should be disconnected from the power outlet).

 WARNING	
There is a risk of fire, electric shock, or serious injury.	
<ul style="list-style-type: none"> ■ Unplug the power cord immediately when serious problems occur. Serious problems such as <ul style="list-style-type: none"> • Smoke, abnormal odor or sound comes out from the product. • No picture, no sound or distorted picture on the display. • Foreign objects (such as water, metals etc) get inside the unit. Do not continue using the product under these abnormal conditions. Unplug the power cord, and contact your dealer immediately. For your safety, never try to repair the product by yourself. 	 Disconnect the plug from the power outlet.
<ul style="list-style-type: none"> ■ Do not insert liquids or any foreign objects (such as metals or flammable items) inside the unit. <ul style="list-style-type: none"> • In case it happens, unplug the power cord, and contact your dealer immediately. • Use special caution when younger children are around the unit. 	
<ul style="list-style-type: none"> ■ Do not remove cover, or modify the product. <ul style="list-style-type: none"> • High-voltage components are installed inside of the unit. Removing covers can expose you to high voltage, electrical shock, and other dangerous conditions. • Contact your local dealer to perform servicing such as inspection, adjustment, or repair work. 	  Do not disassemble.

SAFETY PRECAUTIONS (continued)

WARNING

There is a risk of fire, electric shock, or serious injury.

- Install the unit at a proper area where it does not expose anyone to any danger.
 - If you hit against the edge of the unit, you may be injured.



- Do not place any objects on top of the unit.

Objects such as

 - Liquid containers (vase, fish tank, flowerpot, cosmetics or liquid medicine).
 - If water or any liquid spill onto the unit, it may cause short-circuit and result in fire or electrical shock.
 - In case that it happens, unplug the power cord, and contact your dealer immediately.
 - Do not place anything heavy on top of the unit.
 - Do not climb on or hang from the unit.
 - Do not let your pets get on top of the unit.



- Do not install the unit in an unsuitable place.
 - It could cause a malfunction or in extreme cases danger of electric shock. Places where high moisture is likely such as bathrooms or shower rooms, close to windows, or outside where rain, snow or other inclement conditions could occur should be avoided. Please also avoid installing the unit in a position where fumes from a Hot Spring could come into contact with it.



- Unplug this unit during lightning storm.
 - To reduce the risk of electrical shock, do not touch the product when starts lightning.



Disconnect the plug from the power outlet.

- Do not do anything that may damage the power cord.
 - Do not damage, modify, twist, forcibly bend, heat, or pull excessively the power cord.
 - Do not place heavy objects (including the unit itself) on top of the power cord.
 - If the power cord is damaged, contact your dealer for repairs or exchange.



- Use only with designated power supply voltage.
 - To prevent the risk of fire and electrical shock, operate this product only with the power supply voltage indicated on the unit.



- Beware not to drop or have any impact on the unit.
 - Take extra care while moving the unit.
 - The LCD panel is made of glass. In case that it breaks, you may be injured by the broken pieces.
 - In case that you drop the unit or the cabinet is damaged, turn off the Main Power, unplug the power cord and contact your local dealer immediately.
 - Continuing use of the product with above conditions may cause fire or electrical shock.



- Clean dust or metals on or around the blade of the power plug regularly.
 - Continuing use of the product with above condition may cause fire or electrical shock.
 - Always unplug the power cord first, and clean the blade with dry cloth.

















- Do not place the unit on an unstable surface.

Unstable places such as

 - Tilted place or shaky rack, table, stand or trolley.
 - If the unit falls down, it could cause personal injury.



SAFETY PRECAUTIONS (continued)

 CAUTION	
<ul style="list-style-type: none"> ■ Do not cover or block any ventilation holes on the product. The unit would overheat, and it could cause fire or damage the product which may shorten its service life. • Install the product in accordance with the instructions in this manual. • Do not place the unit with ventilation side down. • Do not install the unit on the carpet or bedclothes. • Do not cover the television with table cloth etc. 	
<ul style="list-style-type: none"> ■ Be sure to ground the earth cable correctly. <ul style="list-style-type: none"> • Especially when you use power cord adapter, be sure to connect the earth cable to the ground terminal. Incorrect connection would cause fire or electrical shock. • For your safety, always make sure to unplug the power cord before connect or disconnect the earth cable. 	 Supply connect the ground wire.
<ul style="list-style-type: none"> ■ Follow the Anti-tumble measures in this manual. <ul style="list-style-type: none"> • If the television tumbles over, there is a risk of personal injury and possible death. Also, it would damage the product seriously. 	
<ul style="list-style-type: none"> ■ Do not install the unit near the medical devices. <ul style="list-style-type: none"> • To prevent malfunction of the medical devices, do not use this product and the medical devices in the same room. 	
<ul style="list-style-type: none"> ■ Do not place a CRT-based television near the speakers of the LCD Television. <ul style="list-style-type: none"> • It could cause the partial discoloration or blurring of the image on the CRT-based television. 	
<ul style="list-style-type: none"> ■ Disconnect all of the external connection cables and detach the anti-tumble measures before moving the unit. <ul style="list-style-type: none"> • It may cause fire, electrical shock, or personal injuries. 	
<ul style="list-style-type: none"> ■ Connect the power plug securely. <ul style="list-style-type: none"> • Improper connection will cause overheating and may result in fire. • Do not touch the blades of the plug while connecting it to the wall socket. It could cause electrical shock. • If the plug is not fitted for the wall socket, contact your dealer for replacement. 	 
<ul style="list-style-type: none"> ■ Do not handle the power cord with wet hands. <ul style="list-style-type: none"> • It could result in electrical shock. 	
<ul style="list-style-type: none"> ■ Do not pull the cord when you unplug the power cord. <ul style="list-style-type: none"> • It may damage the cord and could result in fire or electrical shock. • Hold the plug when disconnecting it. 	
<ul style="list-style-type: none"> ■ Unplug the power cord when you do not intend to use the product for long periods of time. 	
<ul style="list-style-type: none"> ■ Handle the batteries properly. <ul style="list-style-type: none"> • Improper or incorrect use of the batteries may cause corrosion or battery leakage, which could cause fire, personal injury or damage to the property. • Use only the types of the batteries which are indicated in this manual. • Do not install new batteries with used ones. • Install the batteries correctly by following the polarity (+ and -) indications on the battery compartment. • Do not dispose the used batteries as domestic waste. Dispose them in accordance with the local regulations. 	
<ul style="list-style-type: none"> ■ Adjust the headphone volume properly. <ul style="list-style-type: none"> • Excessive sound pressure from headphones might cause hearing loss. 	

SAFETY PRECAUTIONS (continued)

PRECAUTIONS

- Do not install the unit at areas where it will be subjected to high temperatures. It could damage the cabinet or parts of the product.
 - Do not install near any heat sources such as radiator, heat registers, stoves, or other apparatus that produce heat.
 - Keep the unit out of direct sunlight. It could increase the temperature of the unit and cause malfunction.



- Viewing Advice
 - The lighting of the environment in which the product is used should be appropriate. Too bright / dark environments are not good for your eyes.
 - Take time to relax your eyes occasionally.
 - When you use this product, view from a distance equal to 3 to 7 times the height of the screen. This is the best viewing distance in order to protect your eyes against eyestrain.
 - Adjust the volume in appropriate level, especially during the night.

- When transporting this product
 - When the product needs to be transported due to moving or repair, use the carton box and buffer material that come with this product.
 - Do not transport this product on its side. It could damage the panel glass or degrade the phosphors of the panel.



- Keep radio away from the unit while in use. The unit is designed to meet the international EMI standards due to prevent radio interference. However, the unit may generate noise in the radio.
 - If the noise is heard on the radio, please try the following actions.
 - Adjust the direction of the radio antenna in order not to receive the interference from the unit.
 - Keep the radio away from the unit.
 - Use coaxial cable for the antenna.



- About the infrared communication devices
 - The infrared communication devices such as cordless microphone or cordless headphone may not operate properly around the unit. It is because of the communication failure. Please note that this is not malfunction.
- When you dispose this product at the end of its life, follow the regulations in your residential area.
 - For more information, contact the local authority or the dealer where you purchased the product.

Cleaning and Maintenance

Please make sure to unplug the power cord before cleaning the unit.

- How to clean the LCD panel of the unit.
 - The panel surface is specially- coated to reduce the reflection and cut infrared radiation; thus, wipe the panel with a lint-free and dry cloth in order to prevent damage to the coating.
 - Do not use a chemical cloth or cleaner. Depending on the ingredients, it may cause discoloration and damage on the coating.
 - Do not wipe with a hard cloth or rub hard. It may damage the coating.
 - In case of the greasy dirt such as fingerprint, wipe with a lint-free cloth moistened by a diluted neutral detergent solution, and then wipe with a soft and dry cloth.
 - Do not use a spray cleaner. It could remove the coating or cause malfunction by entering inside of the unit.
- How to clean the Bezel (glossy surface).
 - Even a small blemish on the glossy surface easily stands out. Do not use gloss cleaning products other than the one included in the package. (To prevent change of color, please do not use detergent to clean the glossy surface). To clean away dust, gently wipe it with the special raised surface (the surface with characters) of the gloss included in the package. To clean fingerprints and grease, gently wipe the surface with the plain surface (surface without the characters) of the same gloss.
 - Excess pressure while wiping may damage the surface even if it is done with the included gloss. Thus, please be careful when cleaning the surface. To prevent damaging the surface due to dust attached on the included gloss, please remember to wash it after use. (Please do not use fabric softener or bleaching agents).
- How to clean the cabinet of the unit.
 - The following may cause crack, deformation, and paint peeling.
 - Do not wipe the cabinet with benzene, thinner, and other chemical products.
 - Do not spray volatile solutions such as insecticide over the cabinet.
 - Do not leave the cabinet in prolonged contact with plastic or rubber materials.
 - Do not use a chemical cloth, cleaner or wax. Depending on the ingredients, it may cause crack and deformation.
 - Use a lint-free cloth to clean the cabinet and control panel of the unit. In case of the heavy dirt, wipe with a soft cloth moistened by a diluted neutral detergent solution, and then wipe with a soft and dry cloth.
 - Never use the following detergents. It could cause crack, discoloration, and scratch.
 - Acid/ alkaline detergent, alcoholic detergent, abrasive cleaner, powder soap, OA cleaner, car wax, glass cleaner, etc.

ABOUT LCD PANEL

Other Common Characteristics of LCD Panel

The following are the common phenomena when operating LCD Panel due to its structural reason. Please note that they are not malfunctions.

- Defective Spots on Panel

The LCD panel is manufactured with high-precision technology. However, there might be some spots that are not emitted, brighter than the others, or in different colors, etc.

- Surface on Panel

The LCD panel displays images by blinking the fluorescent lamps internally. This could raise the temperature of the display surface.

In addition, do not impact strongly on the surface of the panel because LCD panel is made with fine processing glass.

- Residual image

When a still image or menu is displayed on the screen for a short time (about a minute) and then switches to another image, it may leave an "after-image" on the screen.

The residual image will disappear on its own.

- The Usage under the Low Temperature Environment

Because of the structural characteristics of the LCD panel, the response speed of the LCD panel becomes slower when the ambient temperature around the television becomes too low. In some cases, it may cause the residual image.

The residual image will disappear on its own as the temperature goes up and back to normal.

QUICK START GUIDE

For more information on connecting and using your TV, please be sure to read all instructions in this user manual.

1. Supplied Accessories (including option)

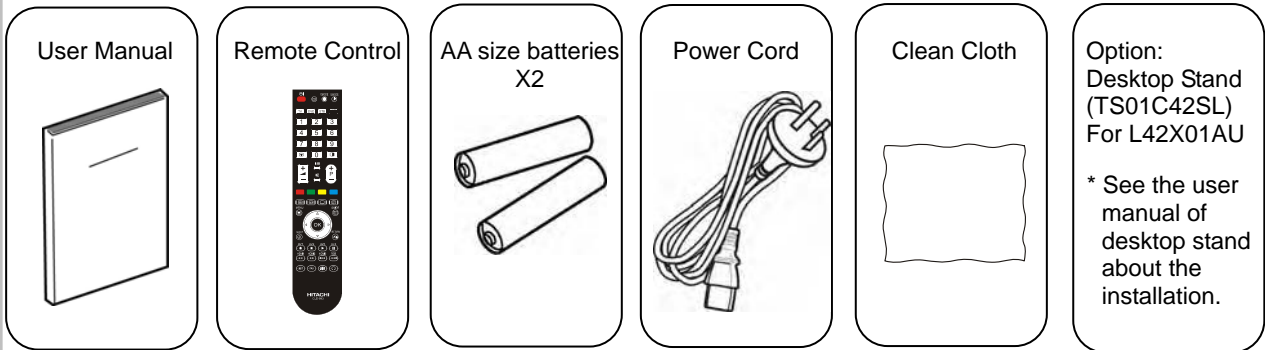

*The type of power plug provided may be different from this drawing for some countries.

2. Connection 15 ~ 21

① Connect the power cord to the rear panel.

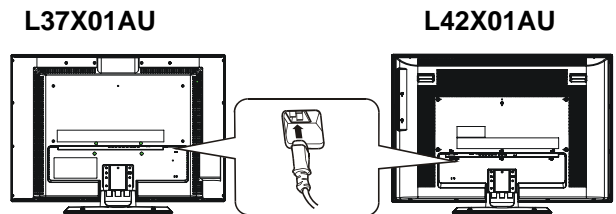

② Connect to the aerial lead and external equipment.
Example: Connecting aerial lead through DVD/STB.

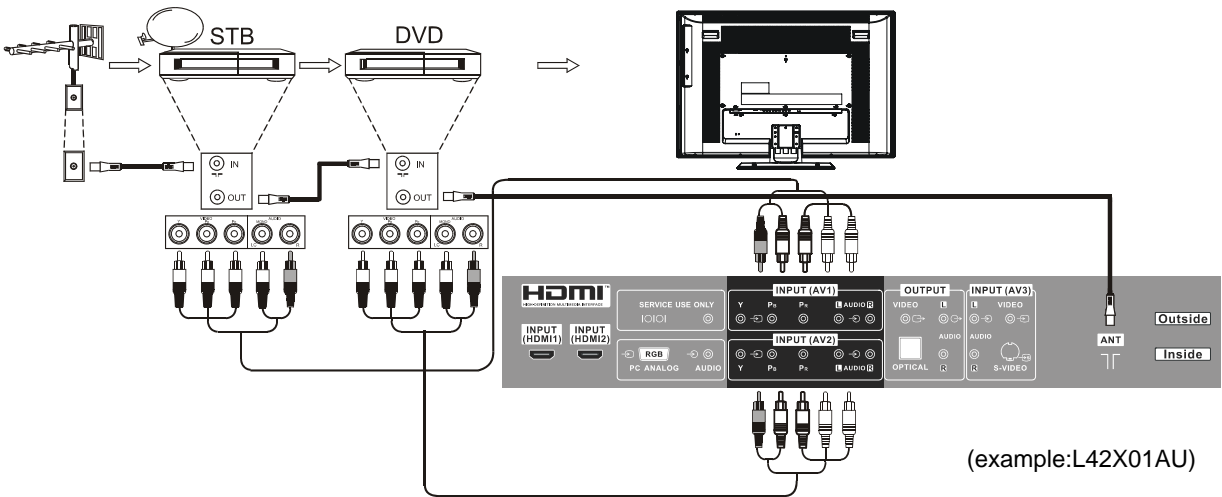

③ Connect the plug into the wall socket after all other connections are completed.

⚠ CAUTION

- Ensure that both ends of power cord are easily accessible.

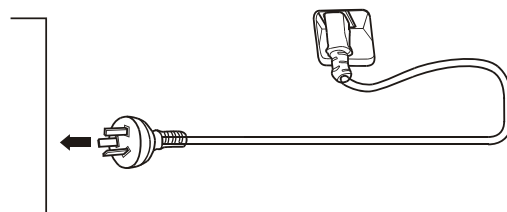

QUICK START GUIDE (continued)

3. Insert the batteries into the remote control... [13](#)

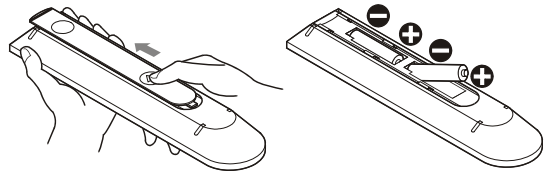

4. Removing the Protective Sheet

Before using the TV, remove the protective sheet from the cabinet.

The protective sheet

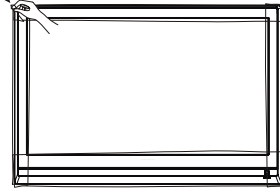

5. Switch On... [22](#)

Press either **Power On/ Off** switch on the unit or **Power On/ Off** button on the remote control.

- The color of the indicating lamp turns from Red to Green.

Main Power switch
(L37X01AU)

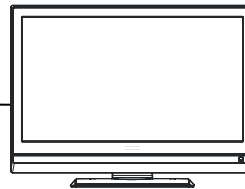

Main Power switch
(L42X01AU)

Sub Power button



6. Auto Tuning ... [27](#) and [40](#)

When you turn ON the TV for the first time, a message show up to lead to the DTT channel installation.

DTT

- ① The message **“Database is Empty Press MENU for installation”** appears.
- ② Press **MENU** button to access DTT main menu.
- ③ Select **“Installation”** form DTT main menu and press **OK** button.
- ④ The password box will appear as **“****”**, and enter **“0000”** as your initial password.
- ⑤ Select one of the scanning methods from **“Manual scan”**, **“Quick scan”**, or **“Auto scan.”**

TV

Then, go to with TV channel installation.

- ① Press **MENU** button to access TV Main Menu.
- ② Select **“Setup”** from Main Menu.
- ③ Select **“Auto scan.”** From **“Setup”** menu and press **OK** button.
- ④ Select **“Search”** to turn the local channels automatically.

NOTE

- If you want to change the setting after completing this first time setup, press

MENU button and set up individually. Refer to [26](#), [27](#) and [28](#)

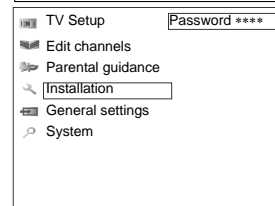
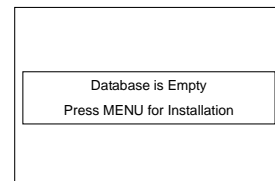

< DTT Main Menu >

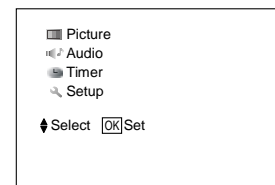

<TV Main Menu>

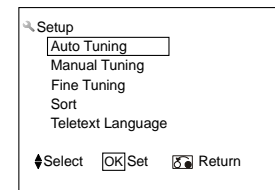

COMPONENT NAMES

Main Unit

Front Panel

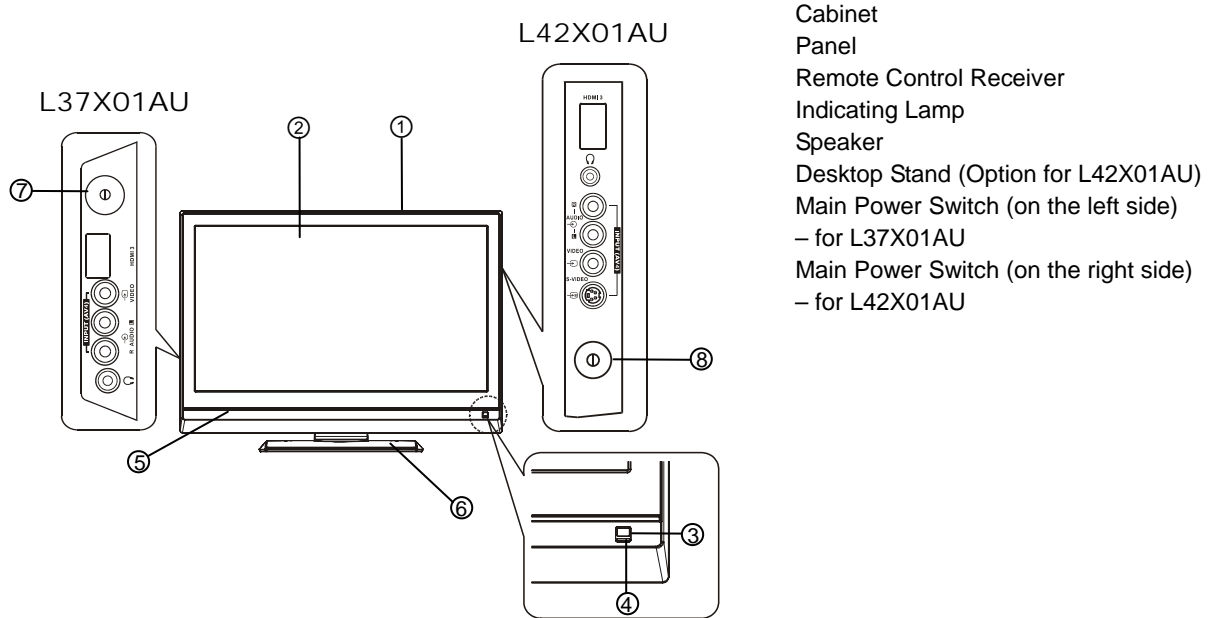

- Cabinet
- Panel
- Remote Control Receiver
- Indicating Lamp
- Speaker
- Desktop Stand (Option for L42X01AU)
- Main Power Switch (on the left side)
 - for L37X01AU
- Main Power Switch (on the right side)
 - for L42X01AU

Rear Panel

L37X01AU

L42X01AU

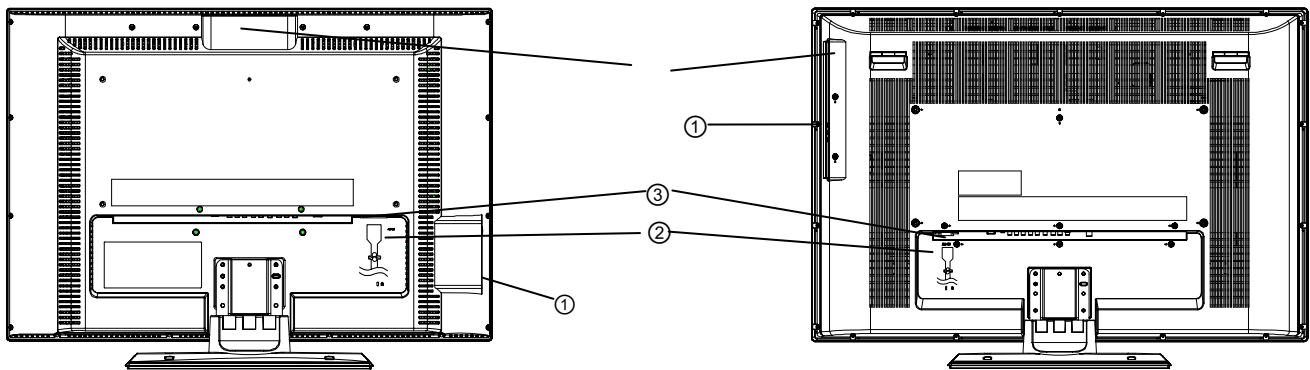

- Side Input
- Power Cord Socket
- Terminal Board (External Device Connection)
- Control Panel (see below for details)

Please refer to [15](#) ~ [21](#) for the detailed information for the connections.

COMPONENT NAMES (continued)

Main Unit (continued)

Control Panel

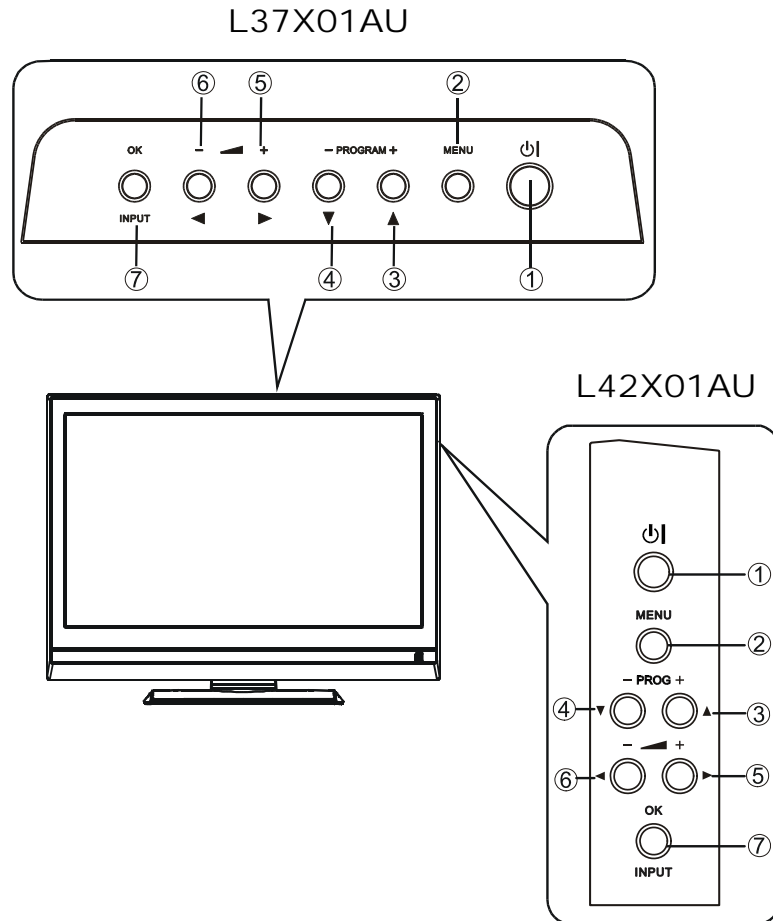

Sub Power button

Menu button

Channel Up/ ▲ button

Channel Down/ ▼ button

Volume Up ▲ /▶ button

Volume Down ▼ /◀ button

Input Select /OK button

COMPONENT NAMES (continued)

Remote Control

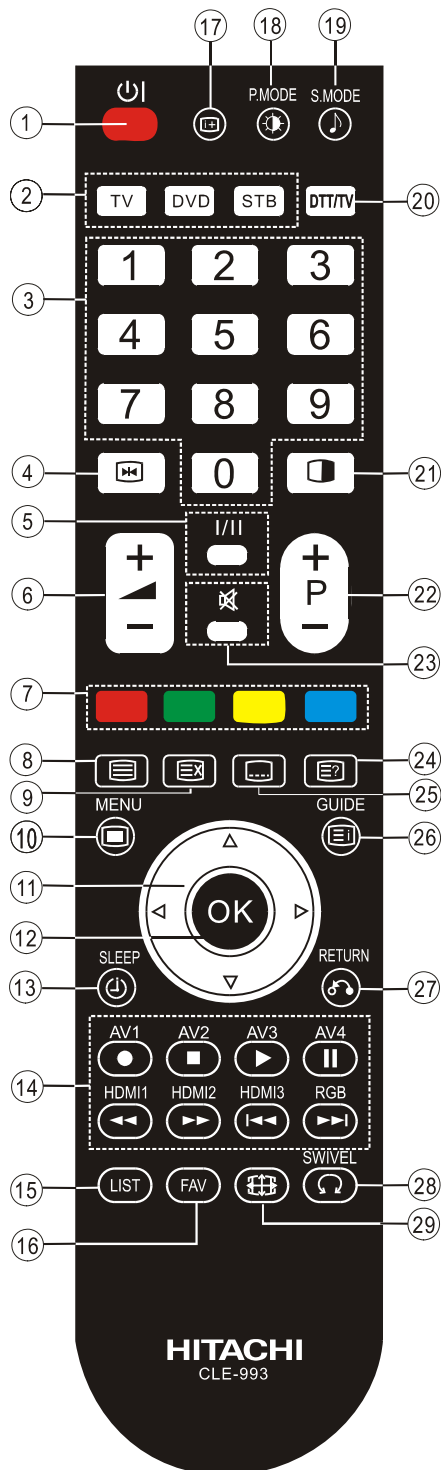

- ① **Sub Power**
Press this button to switch TV On or Off standby.
- ② **Device Select (TV/DVD/STB)**
Press these buttons to select the device (TV, DVD or STB) to be controlled by this remote control.
The selected button will light up to display the selected mode. Normally, select "TV".
- ③ **Program Select [Page Select]**
Press these buttons to select a TV program directly. Refer to [29] for details.
- ④ **Freeze [Hold]**
Press this button to change the picture to freeze mode.
Press it again to return to normal picture. (Also, it holds the page in teletext mode.)
- ⑤ **CHI/II**
This is exclusively for TV audio A2/NICAM mode.
Also, press this button to select Audio Language in DTT mode.
- ⑥ **Volume Up/Down**
- ⑦ **[Color]**
- ⑧ **TV/Text [TV ↔ Text]**
This switches between the TV mode and the Teletext mode.
- ⑨ **Time [Cancel]**
Press this button to display the time when receiving an analog TV program. The time is not displayed if the received signal does not have any time information.
- ⑩ **Menu [Back Light]**
- ⑪ **Cursor**
- ⑫ **OK**
- ⑬ **Off Timer**
This automatically sets the power to standby mode when the selected time period has elapsed. (0→30→60→90→120min.)
- ⑭ **Input Select/DVD Control**
Press these buttons to change input mode. In addition, you can use these buttons while operating the selected brand of DVD player.
- ⑮ **Program List**
It displays program list in DTT mode.
- ⑯ **Favorite List**
It displays favorite list in DTT mode.
- ⑰ **Recall**
Press this button shows the input signal status.
- ⑱ **Picture Mode**
Picture mode can be changed each time pressed in the following sequence. Dynamic→Natural→Cinema
- ⑲ **Sound Mode**
Sound mode can be changed each time pressed in the following sequence. Movie→Music→Speech→Favorite.
- ⑳ **DTT/TV**
Press this button to select DTT (Digital Terrestrial TV) mode or TV mode.
- ㉑ **Multi Picture**
Press this button to change the picture to multi-picture mode. Press it again to return to normal picture.
- ㉒ **Channel Up/Down[Page select]**
- ㉓ **Mute**
- ㉔ **[Reveal]**
- ㉕ **[Subtitle]**
- ㉖ **Guide [Index]**
It displays EPG screen in DTT mode
- ㉗ **Return**
You can use this to return to the previous menu.
- ㉘ **Not Available**
- ㉙ **Picture Size [Zoom]**
Press this button to change picture size.

NOTE →

Some buttons are only for Teletext mode, and other buttons have different functions in Teletext mode from the use of TV mode. Those buttons are indicated by []. Refer to "Analog Teletext" on [37] ~ [38].

PREPARATION

Remote Control Batteries Installation

This remote control operates on 2 "AA" batteries.

1. Open the battery compartment cover

- Slide open the battery compartment cover on the backside in the direction of an arrow, and remove the cover.

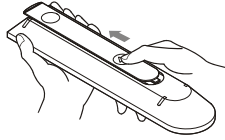

2. Installing the batteries

- Install 2 "AA" batteries (included) making sure the polarities match the indication inside the compartment.

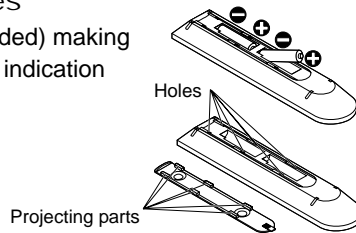

3. Close the battery compartment cover

- Make sure of the positions to fit the projecting parts in the holes, and slide the compartment cover in the direction of an arrow till it clicks shut.

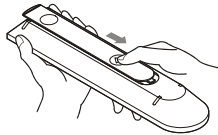

Handling the Remote Control

Use the remote control within about 5m from front of the unit's remote-control sensor and within 30 degrees on both sides.

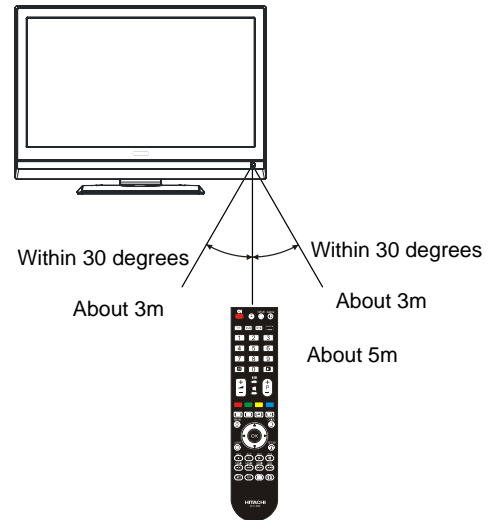

CAUTION

It could cause corrosion or battery leakage and may result in physical injury and/or property damage including fire.

- Never mix used and new batteries in the device.
- Replace all the batteries in a device at the same time.
- Remove the batteries if the remote control is not going to be used for an extended period of time.

To avoid possible failure, read the following instructions and handle the remote control properly.

- Do not drop or have an impact on the remote control.
- Do not spill water or any liquid on the remote control.
- Do not place the remote control on the wet object.
- Do not place the remote control under the direct sunlight or near sources of excessive heat.

Caution When Moving the Main Unit

As this product is heavy, whenever it is moved, two people are required to transport it safely.

When moving the unit, hold it by the top and bottom frame of the LCD screen. (See the figures below for details.)

L37X01AU

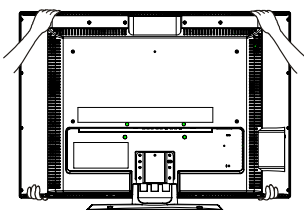

L42X01AU

Hand grips

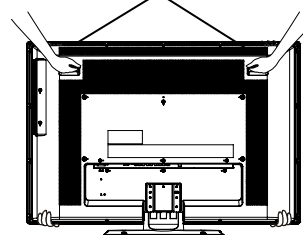

PREPARATION (continued)

Safety Precaution on Main Unit Installation

Read SAFETY PRECAUTIONS (3 to 6) carefully besides this page.

* When installing the unit, use the optional Desktop Stand (TS01C42SL for L42X01AU). Please refer to the user manual of the stand.

The Desktop Stand (optional) has been used for the illustration in this manual.

When installing the main unit, be sure to use the specified mount units in order to obtain maximum performance and maintain the safety. We assume no responsibility or liability for personal injuries or property damages caused by use of other mount units or improper installation.

As for the installation instruction, please read each user manual of the mount units: for Desktop Setup, Wall Mounting, and Ceiling Mounting.

In case of using Wall or Ceiling Mounting unit, contact your local dealer, ask the specified installation specialist to set up. Never attempt to install it by yourself. It could cause injuries or damages

Please leave adequate space around this television in order to avoid increasing the internal temperature.

Make sure not to block any ventilation holes.

Do not install the television in the small space such as inside the rack, closet or the box.

Leave more than 10cm of clearance from each side of television and 30cm from the top of television to wall.

Without Swivel function: Leave at least 10cm of clearance behind rear unit.

With Swivel function: Leave at least 35cm of clearance to obtain the maximum performance of Swivel Function.

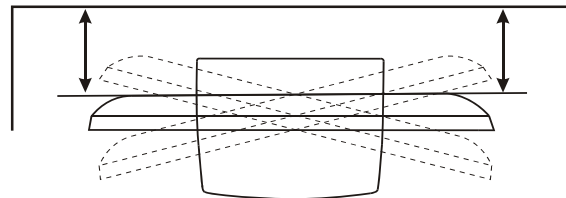
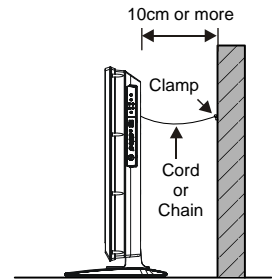
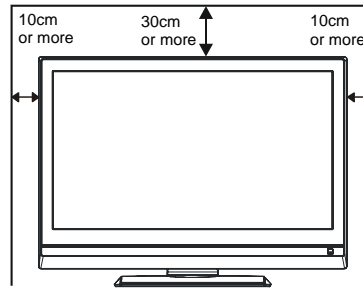

Anti-Tumble Measures

Install in a stable place and implement safety measure against overturning.

Securing to a wall or pillar

Using a commercially available cord, chain and clamp. Secure the set to a firm wall or pillar.

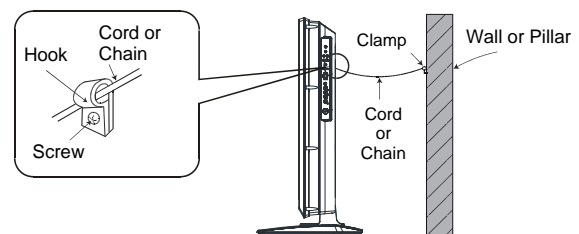

Securing to ceiling

Using a commercially available cord, chain, and clamp secure the set to a ceiling.

NOTE

- For more information regarding the mounting of the unit, please contact your dealer.
- Please install the unit at a proper area where it does not expose anyone to the danger of hitting themselves (for example their hands, head or face, etc) against the edge of the unit and cause personal injury.

CONNECTION

Terminal Positions

L37X01AU

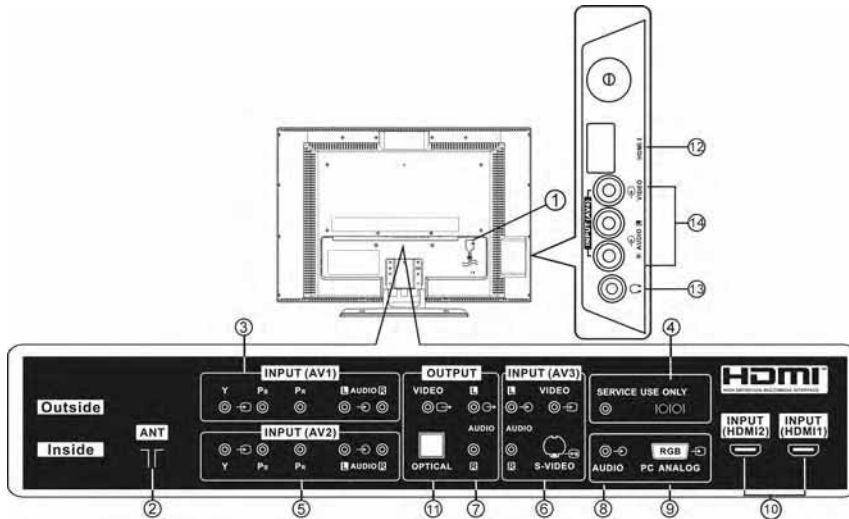

Rear

- Power Cord Socket
- Aerial Socket
- AV1
- Service Use Only
- AV2
- AV3
- Monitor Out
- PC(RGB)/HDMI Analog Audio Input
- PC Connection Terminal (D-Sub 15 pin)
- HDMI 1 and HDMI 2
- Optical Out (Digital Audio)

Side

- HDMI 3
- Headphone Terminal
- AV4

L42X01AU

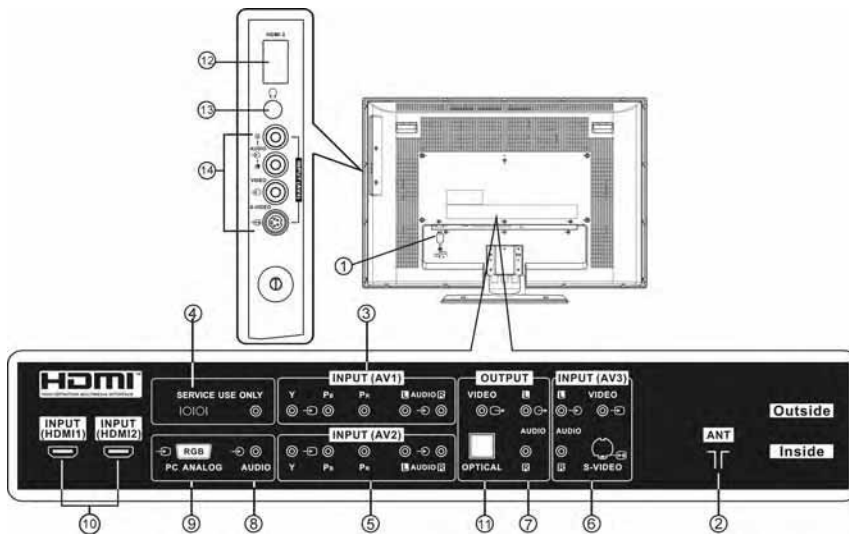

Rear

- Power Cord Socket
- Aerial Socket
- AV1
- Service Use Only
- AV2
- AV3
- Monitor Out
- PC(RGB)/HDMI Analog Audio Input
- PC Connection Terminal (D-Sub 15 pin)
- HDMI 1 and HDMI 2
- Optical Out (Digital Audio)

Side

- HDMI 3
- Headphone Terminal
- AV4

Connecting Procedure

This unit is ready for various kinds of connections. Make a connection in the following steps. Be sure to unplug the power cord from the wall socket first, when connecting external equipment.

1. Connect Power Cord to the rear panel.
2. Connect Aerial Lead.
3. Connect your external equipment (if any) to the unit.
4. Connect the power plug to the wall socket.

CONNECTION (continued)

Connecting Procedure (continued)

1. Connecting Power Cord to Rear Panel.

Connect power cord to the television.

* Make sure not to connect the power plug to the wall socket until all connections are completed.

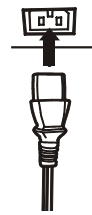

2. Connecting Aerial Lead.

There are two ways to connect aerial lead.

When you do not have any other external equipment

Connect the aerial lead directly into the socket at rear panel.

When you have one or more external devices to connect:

1. Use RF cable to connect between each equipment and aerial.
2. Connect the Aerial Lead to an equipment "In" socket marked
3. Connect the RF cable from the equipment "Out" to the other equipment "In".
4. Then, connect from the equipment "Out" to "ANT" on the LCD screen socket.

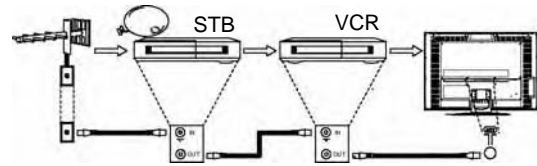

[Example: Connecting Antenna through STB and VCR.]

Precautions when connecting the aerial

- Please use a coaxial cable which is free from interference to connect the aerial. Avoid using a parallel flat feeder wire as interference may occur, causing reception to be unstable and stripe noise to appear on the screen.
- Avoid using indoor aerial as this may be affected by interference. Please use CATV net or outdoor aerial.
- For safety, install an external aerial conforming to AS1417.1(Applicable for Australia only)
- If there are noise in the picture of VHF-Low band channel, please use the double-shielded cable (not provided) for RF LEADS to reduce the noise.

CONNECTION (continued)

Connecting Procedure (continued)

3. Connecting to External Equipment

• Terminals on Rear

AV1 and AV2 can be connected to the equipment with Component output.

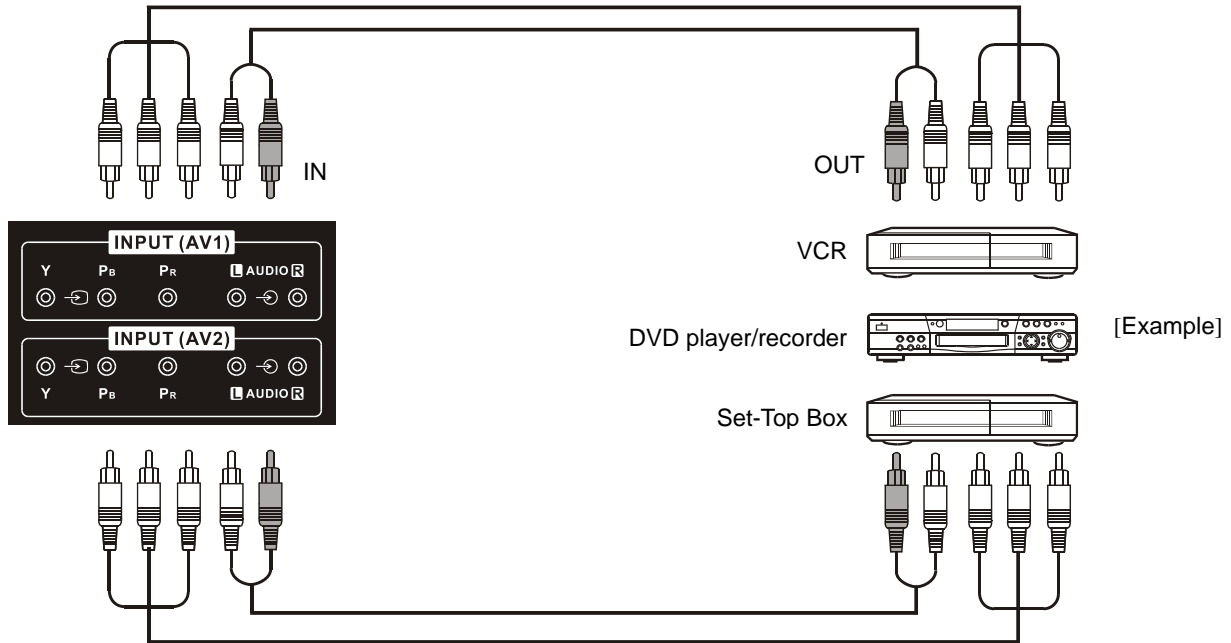

💡 If your external device has a Component terminal, COMPONENT / AUDIO connection is recommended for higher quality picture.

AV3 can be connected to the equipment with S-Video output and Composite output.

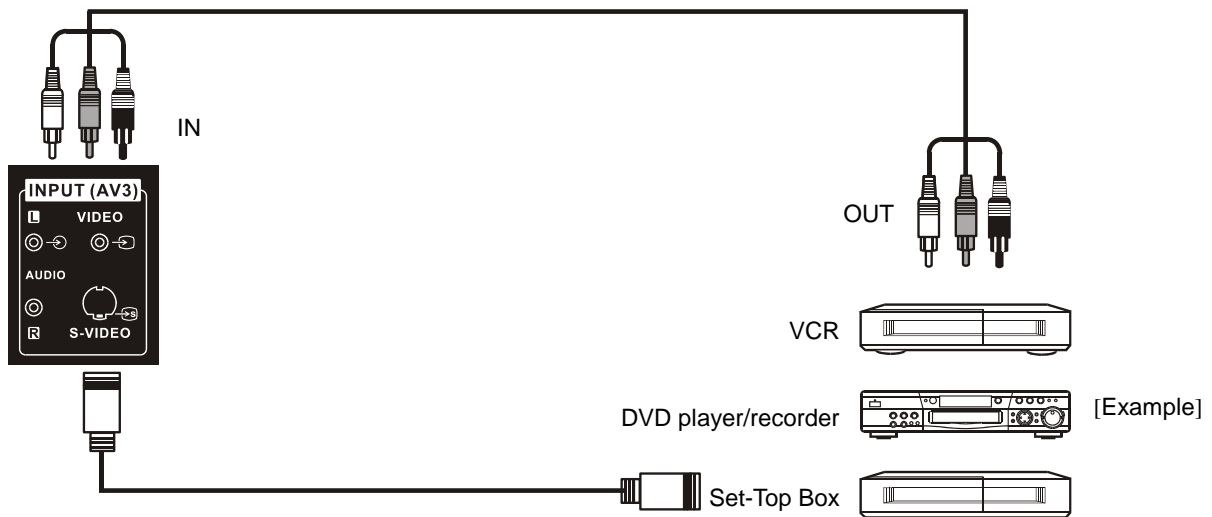

💡 If your external device has a S-Video terminal, S-Video connection is recommended for higher quality picture.

NOTE

• If both S-video and Composite Video input terminals of AV3 are connected at the same time, S-Video will have its priority.

CONNECTION (continued)

Connecting Procedure (continued)

Monitor Out can be used to display same image and sound as main unit on another television.

When this output terminal is connected to an external television with a 75 Ohm terminal, the same image and sound from composite (AV3, AV4), or DTT/TV signal can be displayed to the external television.



NOTE

- Video output is not available from component, RGB, or HDMI input.

PC connection terminal (D-sub 15 pin) + **PC(RGB)/HDMI Analog Audio Input** terminal connected to PC, which allows Analog RGB signal.

L37X01AU

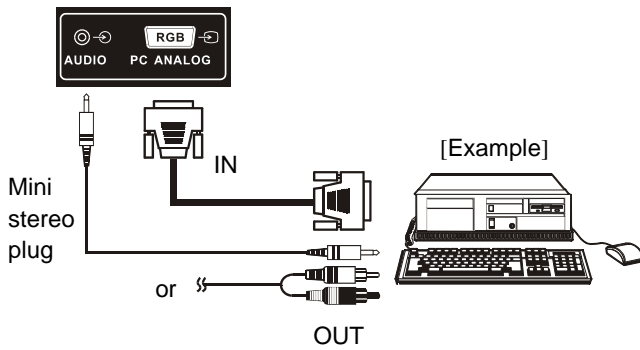

L42X01AU

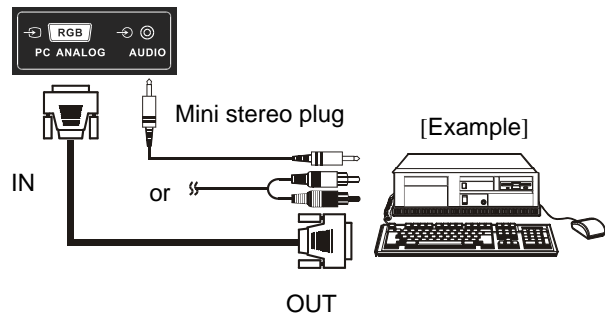

CONNECTION (continued)

Connecting Procedure (continued)

HDMI1~ 3 terminals can be connected to the devices with HDMI output .

If the external device has DVI output, this can be available with HDMI-DVI cable. In case of using the HDMI-DVI cable, connect analog audio signal to **PC (RGB)/HDMI Analog Audio Input** terminal.

HDMI 1- 2 terminals are located on the rear side of unit, while **HDMI 3** terminal is located on the right side control panel. See 15

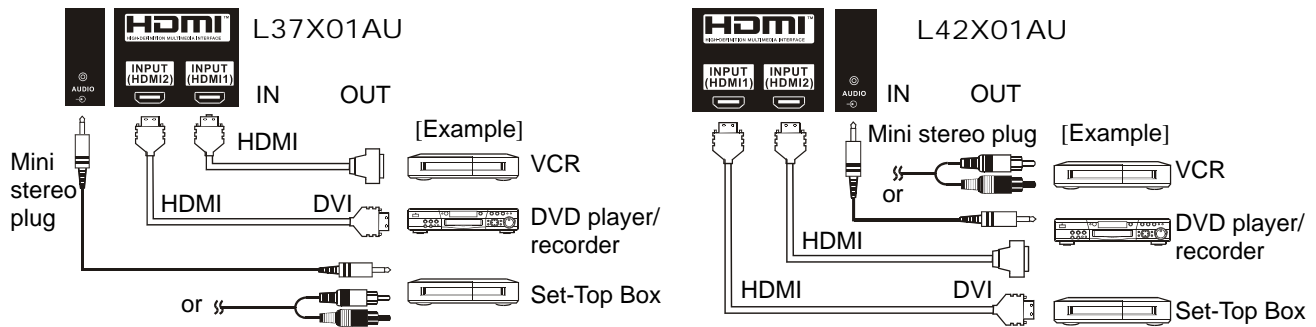

Information

HDMI (High Definition Multimedia Interface) is next-generation multimedia I/O interface. Only one cable is used to transmit all video/audio/control signals, which creates easy connection.

Moreover, those digital signals can produce high quality data without any degradation.

You are provided with three HDMI terminals, one of the most remarkable features.

If your external device has a HDMI terminal, HDMI connection is recommended for higher quality picture and sound.

NOTE

- About PC (RGB)/HDMI analog audio input terminal

This terminal can be used in one of the following cases only.

- The external device is connected to the PC (RGB) terminal of the TV.
- The DVI output of an external device is connected to the HDMI 1 terminal using the HDMI-DVI cable.
- The DVI output of an external device is connected to the HDMI 2 terminal using the HDMI-DVI cable.
- The DVI output of an external device is connected to the HDMI 3 terminal using the HDMI-DVI cable.

Make sure that the video and audio terminals are connected to the same external device.
About the output format of an external device, refer to "Recommended Signal List" on 57 58

Optical Out (Digital Audio) terminal can be connected to an audio amplifier with Optical Audio input.

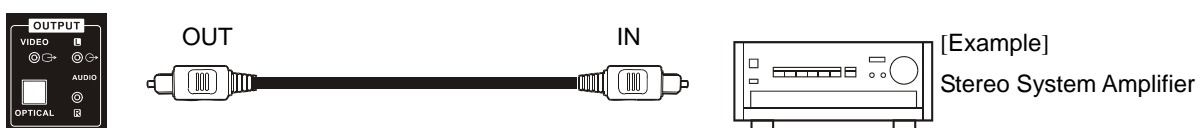

NOTE

- This output is DTT output but not monitor output.

CONNECTION (continued)

Connecting Procedure (continued)

• Terminals on Side

Since the following terminals are located on the side, it is very convenient to use the extra device on a temporary basis after done the connections on the rear panel.

AV4 can be connected to the equipment with composite output. (For L37X01AU)

AV4 can be connected to the equipment with S-Video output and composite output. (For L42X01AU)

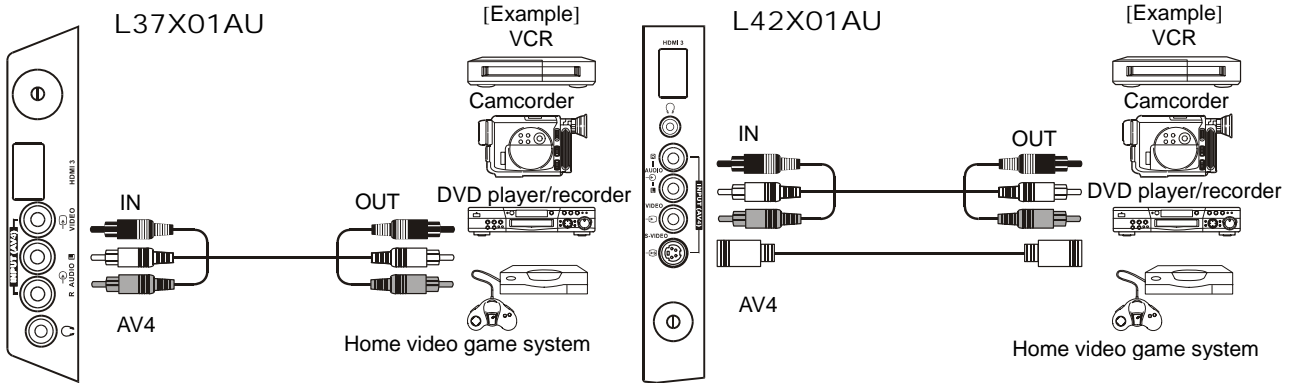

If your external device has an S-Video terminal, S-Video connection is recommended for higher quality picture.

NOTE

- If both S-video and Video input terminals of AV4 are connected at the same time, S-Video will have its priority. (For L42X01AU)

Headphone

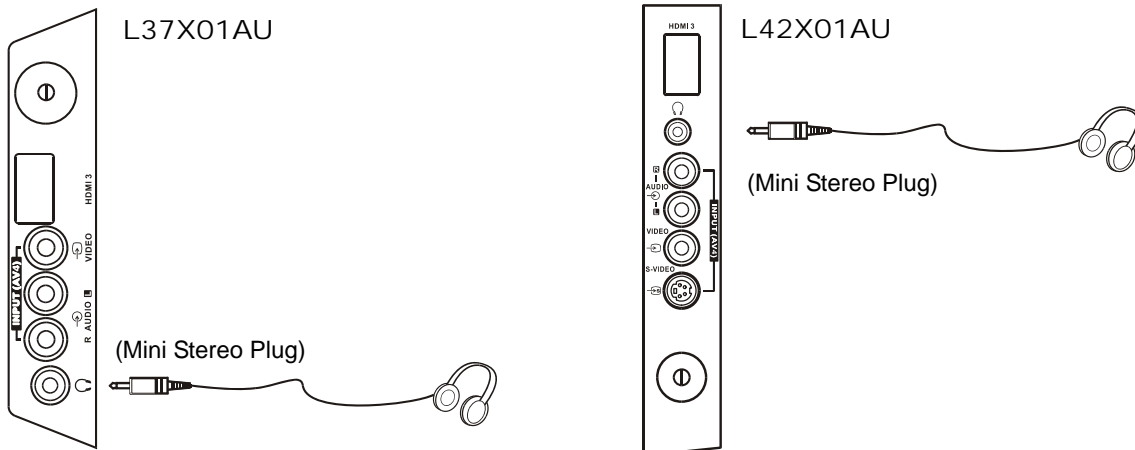

The audio from the speaker will be muted when connecting the headphone to this terminal.

CONNECTION (continued)

Connecting Procedure (continued)

4. Connecting the plug into the wall socket

Connect the power cord after completing all other connections.
(The type of plug is different from this drawing for some countries.)

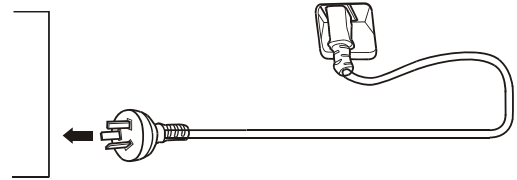

CAUTION

- Use only the power cord provided.
- Do not use a power supply voltage other than that indicated (AC110-240V, 50/60Hz). It may cause fire or electric shock.
- For the LCD panel, a three-core power cord with a ground terminal is used for efficiency protection. Always be sure to connect the power cord to a three-pronged grounded outlet and make sure that the cord is properly grounded. If you use a power source converter plug, use an outlet with a ground terminal and screw down the ground line.
- Ensure that both ends of power cord are easily accessible.
- If you have to change the power cord, please use the certified power cord that meets your region's safety standard.

Information

- How to secure the power cord and cables

Step 1. Secure the power cord

After connecting power cord to the rear panel, secure the power cord with the clamp.

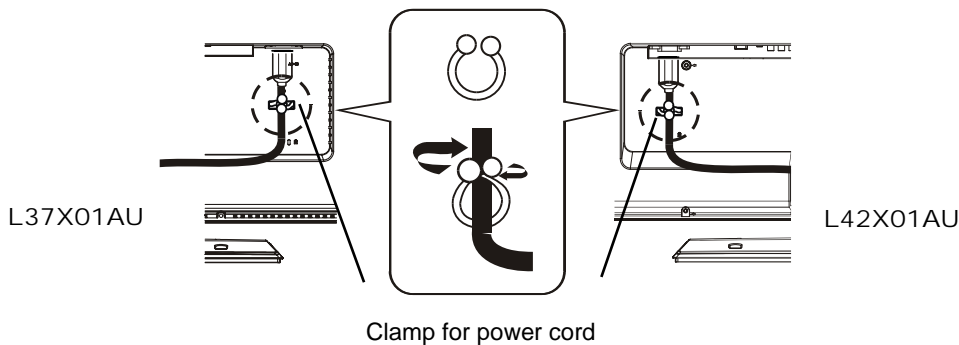

Step 2. Secure all cables

Secure all cables together with power cord by using large clamp.

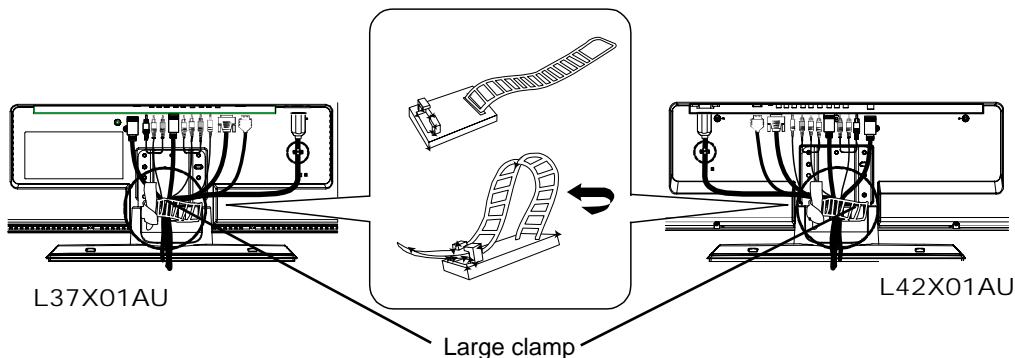

NOTE

- When you secure the cables, please be careful not to tighten too much.

BASIC OPERATION

POWER On/Off

Now, turn On the main power of the unit.

- To turn On the power of the television
 1. Press the **Main Power switch** on the television.
 - The Indicating Lamp will illuminate in **Red** (Standby mode).
 2. Press either **Sub Power button** on the control panel or **Sub Power button** on the remote control.
 - The color of the Indicating Lamp turns into **Green**, and the image will display on the screen.
- To turn Off the power of the television
 1. Press either **Sub Power button** on the control panel or **Sub Power button** on the remote control.
 - The image disappears from the screen and the Indicating Lamp turns into **Red** (Standby mode).
 2. Press **Main Power switch** to completely turn Off the power of the unit.

L37X01AU
(on the left side)

L42X01AU
(on the right side)

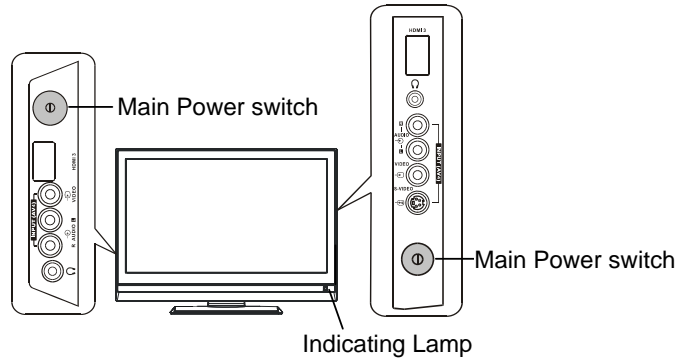

L37X01AU

Sub Power button

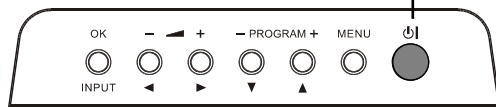

L42X01AU

Sub Power button

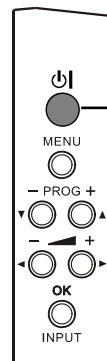

The Indicating Lamp Status



Indicating Lamp Status	Power Status	Power Switch Status
Off	Off	Main power Off
Red	Standby mode	Main power On Sub Power button Off
Green	On	Main power On Sub Power button On
Orange	Power Save mode	Main power On Sub Power button On

NOTE

- If the image does not appear on the screen at all, or have any problem, see TROUBLESHOOTING on 52 ~ 54. It may help you to solve the problems.
- You can turn ON the power only by pressing the **Sub Power** button during the Standby mode.
- Do not switch the power On/Off repeatedly in a short period of time. It could cause malfunction.
- To avoid sudden surges of electricity when the power comes back on, unplug the power cord before you leave if there is a power cut during use of the unit.



BASIC OPERATION (continued)

Volume UP/DOWN

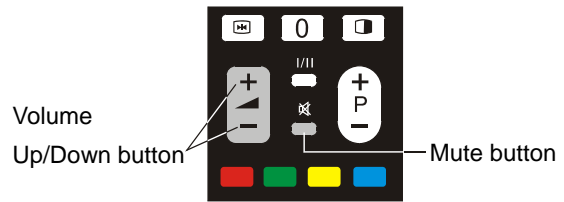
- To increase the sound volume, press  button on the remote control, or **Volume Up** button on the control panel.
 - The Volume Indicator value on the screen will shift right.
- To decrease the sound volume, press  button on the remote control or **Volume Down** button on the control panel.
 - The Volume Indicator value on the screen will shift left.



Mute

- To mute the sound, press  button on the remote control.
 - The sound of the unit is temporarily turned Off.
 - The color of the Volume indicator will turn into **magenta** while muting the volume.
- To turn the sound back, press  button again, or Volume Up button on either remote control or the control panel.
 - The color of the Volume Indicator will turn back to yellow.

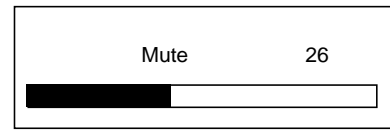

The Volume Indicator

NOTE

- You can decrease the volume by pressing  button while the sound is muted.

L37X01AU

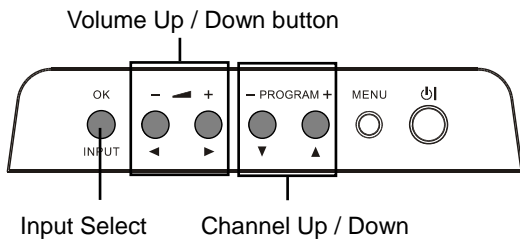

L42X01AU

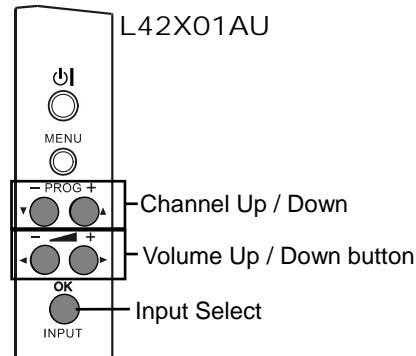

Input Switching to DTT/TV, AV1~4, HDMI1~3, and RGB

By pressing **Input Select** button, you can switch the input.

- To watch actual broadcast, press **Input Select** button on the control panel, the numeric buttons, **DTT/TV** button or **Channel Up / Down** button on the remote control.
- To display the image outputting from the external equipment connected to each terminal (DTT/TV, AV1~4, HDMI1~3 and RGB), select corresponding mode.

- Press **Input Select** buttons on the remote control.
(Use "  " button to switch between DTT and TV mode.)
- The Input modes can be also switched by using **Input Select** button on the control panel.
Each time this button is pressed, the screen displays corresponding mode by following order.

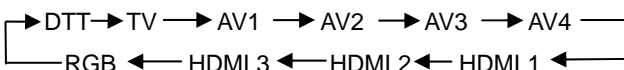

- To go to **TV** mode, press **Channel Up/Down** buttons on remote control or **DTT/TV** button on the control panel.
Also, you can use the numeric buttons on the remote control.

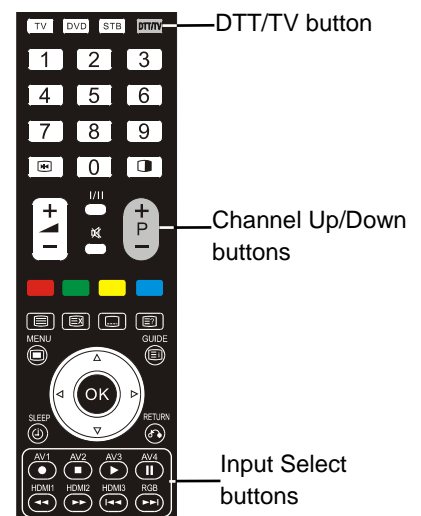

BASIC OPERATION (continued)

Input Signal Screen Display

The input signal status and off timer status can be displayed on the screen by pressing the  button of the remote control.

- The display in DTT mode will appear when changing the channels.
(Refer to 41, 42)
- The display will go out in approximately 5 seconds.

DTT

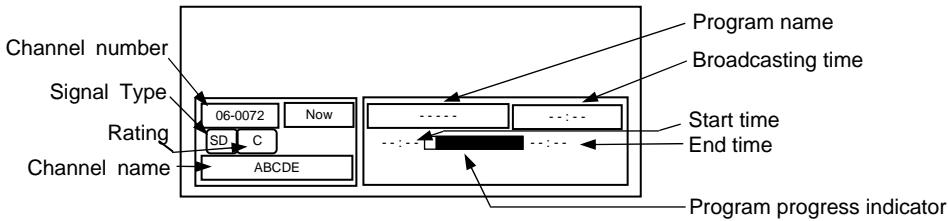

TV

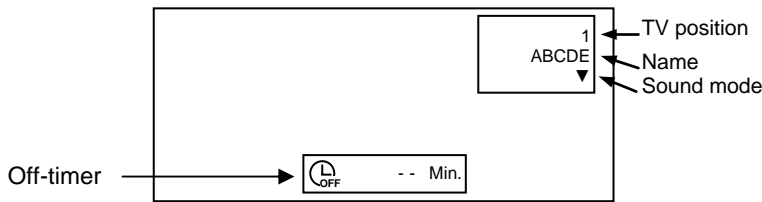

VIDEO

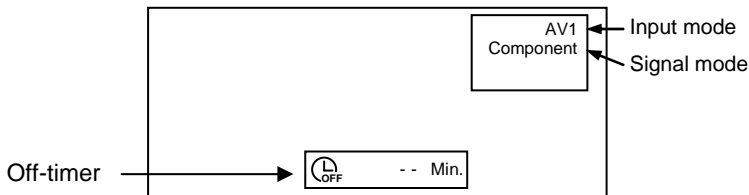

RGB

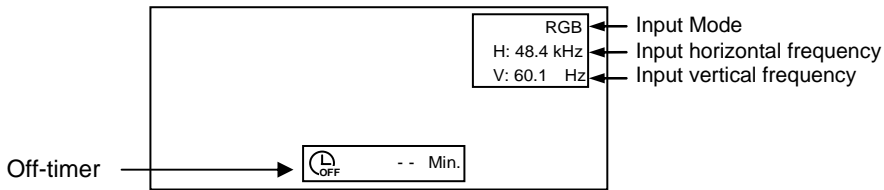









TV SETUP OPERATION

How to use the On-Screen Display (OSD) system

With the On-Screen Display system, you can access the various kinds of the features and functions in this product.

• Basic Operation

1. Press  button on the remote control or **Menu** button on the control panel of the unit. The **Main Menu** is displayed on the screen as shown on the right.
2. To select the item, press  buttons.
The selected item will be highlighted in Yellow.
3. Press  button to set your selection.
The selected menu page will be displayed on the screen.
4. Use  buttons to choose the item on the MENU page.
Press  button to set your selection.
5. Use  buttons to adjust the item values or choose options.
Press  button to set your selection.
6. To exit from the menu, press  button.

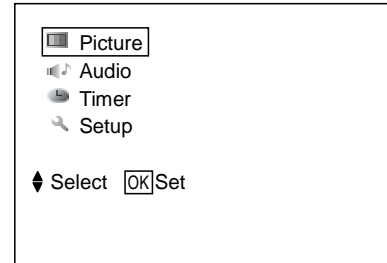

<Main Menu>

NOTE

- The OSD menu screen will be closed automatically when no operation has been made for about 30 seconds.
- If the item in menu is shown in gray, it means that it cannot be selected or adjusted.

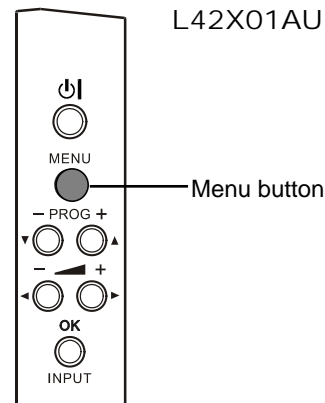
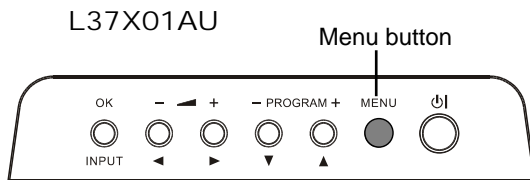
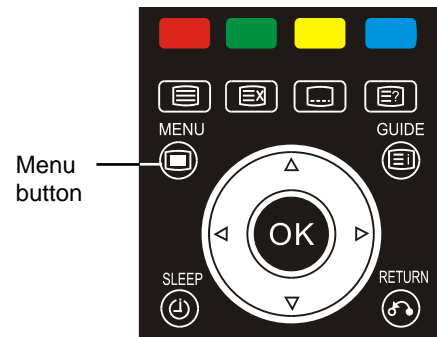

TV SETUP OPERATION (continued)

Main Menu List



Menu		Page
Picture(TV/AV)	Picture Mode	30
	Contrast	30
	Brightness	30
	Color	30
	Sharpness	30
	Tint	30
	Color Temperature	30
	Back Light	30
	Reset	30
	Black Enhancement	31
	DNR	31
	MPEG NR	31
	Film Mode	31
	3D Comb Filter	31
	Picture Size	31
	Reset	31
Picture(RGB)	Contrast	36
	Brightness	36
	Color Temperature	36
	Back Light	36
	Reset	36
Audio	Audio Mode	32
	Treble	32
	Bass	32
	Balance	32
	Matrix Surround	32
	Dynamic Bass	32

Menu		Page	
Audio	Perfect Volume	32	
	TV Speakers	32	
	Reset	32	
Timer	Off Timer	33	
Setup(TV)	Auto Tuning	Mode	27
		Search	27
	Manual Tuning	Position	27
		Frequency	27
		Name	27
		Sound System	27
		Color System	28
		Skip	28
		Antenna Att.	28
	Fine Tuning	28	
	Sort	28	
	Teletext Language	28	
	Setup(AV)	Video Power Save	50
Reset		50	
Setup(RGB)	Auto Adjust	35	
	Image Position	35	
	Horizontal Clock	35	
	Clock Phase	35	
	Reset	35	
	Frequency Display	35	
WXGA	35		





TV SETUP OPERATION (continued)

Setup Menu (TV mode)

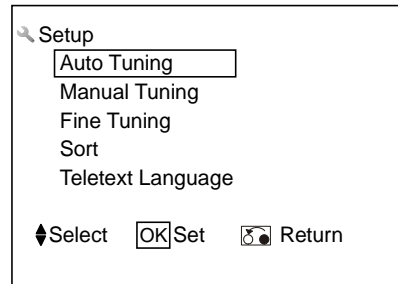
You can install channels and make the various settings related channels.

1. Press  button.
2. Select "Setup" menu and press  button.
3. Select the preferred menu item and press  button.



Selected Items		Setup hint	
Auto Tuning	Mode	Position	Searches every channel. Store the channels in order of tuning.(1~125)
		Direct	Searches available channel. Store the channels in fixed number according to broadcasting standard. The channel number 1~12 and 21~69 are displayed as C* *, and the channel number 101~146 are displayed as S* *.
	Search	Tune the local channels automatically. Press  button to start searching.	
Manual Tuning	Position	Press channel up (+) down (-) buttons to input position number (1~125) or channel number (C** or S**).	
	Frequency	Search the frequency by using  button when Auto Tuning Mode is set to [position]. When Auto Tuning Mode is set to [Direct], this function is not available (grayed out).	
	Name	1. Move the cursor to the first digit and select the letters with  buttons. 2. Move to the next digit with  button. 3. Press  button again when you finish inputting all the letters. • The selectable letters are as follows: "0"~"9", "A"~"Z", " " (blank), "+", "-", ".", "?" (Period) and "?".	
	Sound System	Auto	Select [Auto] normally. In case that sound is not output correctly, select the other modes depending on the received signal.
		M	
D/K			
I			
B/G			

NOTE

When you turn ON the television for the first time, your television is at "the original factory setting" and may not be able to display the image normally on the TV screen. Please select **Auto Tuning** to set the TV channel.

TV SETUP OPERATION (continued)

Setup Menu (TV mode) (continued)

With this menu, you can access various kinds of features relating to TV channel settings.

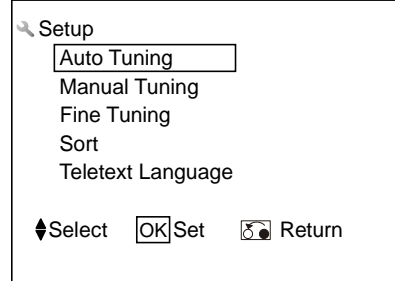

Selected Items			Setup hint
Manual Tuning	Color System	Auto	Select [Auto] normally. In case that color is not displayed correctly, select the other modes depending on the received signal.
		NTSC 4.43	
		SECAM	
		PAL	
		NTSC 3.58	
	Skip	Off	It allows you to skip unregistered channels automatically when you use channel up (P+) down (P-) buttons to select channels.
On		This function will automatically skip unavailable channels when set to on.	
Antenna Att.	Off	The noise on the screen or interference could be reduced in case that the receiving field strength are too strong. • The selection on this item is applied to all the channels.	
	On		
Fine Tuning	-56~+56	▶: Increase the frequency data for the main tuner. ◀: Decrease the frequency data for the main tuner.	
Sort		You can change the order of channels as follows. 1. Move the cursor to the channel row you want to change order and then, press [OK] button. 2. The color of the letters on the designated line will be turned into yellow bracket and with []. 3. Move the designated row by using [Up/Down] buttons. 4. Press [OK] button to fix the position. • This function is not available (grayed out) when the Auto Tuning Mode is set to [Direct].	

TV SETUP OPERATION (continued)

Channel Selections

There are 2 ways to select the channels: stepping through the channel, and selecting by number.

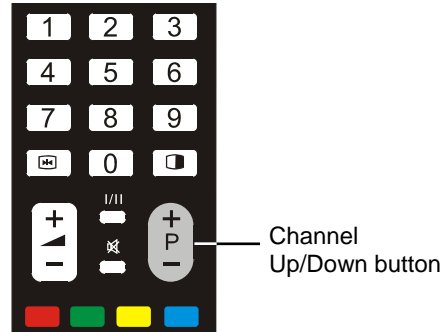

Stepping through the Channel

Press **Channel Up/Down** button to switch the next or previous channel on the list.

L37X01AU

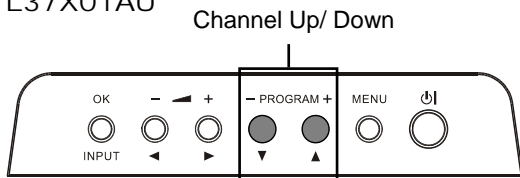

L42X01AU

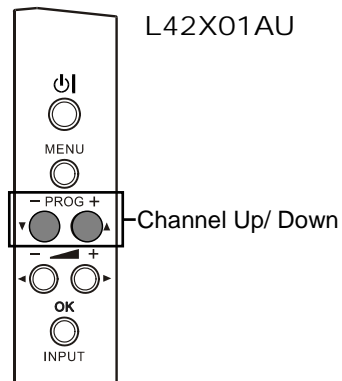

Selecting by Number

Enter the number of acquired channel by using numeric buttons on the remote control.

The selectable channel number and method differ depending on the modes ("Position" or "Direct") of **Auto-tuning**. See [27](#) for the details.

- If you have tuned channels with "Position" mode:

The position number of 0~125, of which you have tuned with "**Position**" mode, can be selected by using numeric buttons on the remote control.

- If you have tuned channels with "Direct" mode:

Input the number "001~012 (displayed as C1~C12) or 021~069 (displayed as C21~C69) or 101~146 (displayed as S1~S46)" by using numeric button on the remote control.

TV SETUP OPERATION (continued)

Picture Setting

You can make specific adjustments for the picture based on your preference.

1. Press button.
2. Select “Picture” menu and press button.
3. Select the preferred menu item and press button.

(By pressing button at the bottom of each menu page, the next Picture menu will appear on the screen.)

NOTE

Please see [36](#) about picture setting of PC

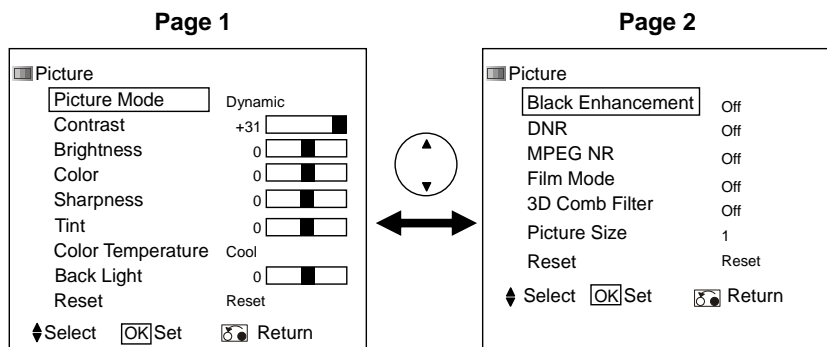

Selected Items		Setup hint
Picture Mode	Dynamic	You can make the better selection from 3 modes depending on the lighting condition and intended use. Dynamic : Suitable for the brighter conditions. Natural : Suitable for the normal lighting condition. Cinema : Suitable for watching movie.
	Natural	
	Cinema	
Contrast*	-31~+31	This adjusts the contrast to meet the lighting environment by using .
Brightness*	-31~+31	With this function, black is adjusted to change the overall brightness by using button.
Color*	-31~+31	It can adjust color density based on your preference by using button
Sharpness*	-15~+15	Preferred sharpness can be adjusted by pressing button for softer image or button for sharper image.
Tint*	-31~+31	Pressing button enhances red, while pressing button enhances Green. The setup hint is adjusting for the realistic skin color. This is not available by PC mode when receiving RGB signal.
Color Temperature*	Cool	You can select from 3 settings (default): Cool, Normal, Warm depending on the color condition with buttons. You can adjust the setting in “User” item.
	Normal	
	Warm	
	User	
Back Light	-20~+20	Adjust the brightness of the Back Light for the maximum visibility.
Reset		Each item on this menu screen can be restored to the original factory settings by pressing button.

Information

The setting of the items indicated by “*” can be stored for each of inputs and picture modes (Dynamic/Natural/Cinema). You can enjoy different setting depending on the selected input such as VCR in AV3.

TV SETUP OPERATION (continued)

Picture Setting (continued)

Selected Items		Setup hint
Black Enhancement	Off	Adjusts the black level compensation.
	Low	
	Middle	
	High	
DNR	Off	The noise on the screen or interference could be reduced, especially at the area of weak electric field.
	Low	
	Middle	
	High	
MPEG NR*	Off	This is a noise reduction system for MPEG picture signal. (ex. against mosquito noise and block noise)
	Low	
	High	
Film Mode	Off	This helps to make the moving image smooth. On: Automatically identify if it is the movie film and faithfully reproduces the original film images. Off: Set to Off if the image does not look natural.
	On	
3D Comb Filter	Off	This is available only when receiving PAL/ NTSC 3.58 composite signal. This reduces the dot and color blurring in minute scales so that it can reproduce purer color.
	On	
Picture Size	1	Select [1] it will display the original picture completely. If the images from TV signal (especially CATV) has blacken gap in Panoramic mode, and select [2], it will make up for the gap. But when display is no available in "Cinema" size. This function only works for TV, Composite, Component and HDMI input.
	2	
Reset		Each item on this menu screen can be restored to the original factory settings by pressing  button.

Information

The settings of the item indicated by " * " can be automatically stored depending on the signal mode.

NOTE About "Film Mode"

- The image might not look natural depending on the image contents.

Phenomena such as

- ① When switching the subtitles of a film or images, the image displays fine horizontal streak lines.
- ② When switching the scenes such as commercial and animation, the image displays fine horizontal streak line.
- ③ When displaying a ticker or subtitle, the text on the image becomes rough (aliasing).
- ④ When watching the image form AV input which is connected to any external equipment, the OSD of external equipment displays fine horizontal streak lines.

These phenomena occur due to the method of converting the image.

Please note that this is not malfunction.

In case that it is disturbing, please set to Off.



In addition, the effect of this menu might vary depending on the size setting (See )

Also, this might not be ineffective depending on the scene of image.

TV SETUP OPERATION (continued)

Audio Setting

You can adjust and customize the audio condition as you like.

1. Press  button.
2. Select "Audio" menu and press  button.
3. Select the preferred menu item and press  button.

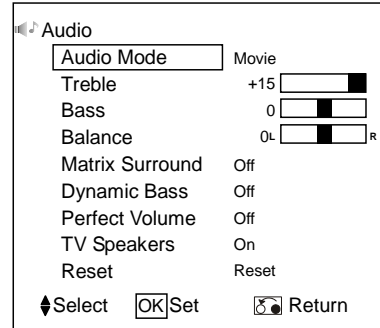

Selected Items		Setup hint
Audio Mode	Movie	You can select the most suitable sound condition from these 4 items. You can adjust any value you preferred in "Favorite" item.
	Music	
	Speech	
	Favorite	
Treble	-15~+15	Adjust the Treble of the sound.
Bass	-15~+15	Adjust the Bass of the sound.
Balance	-10~+10	Adjust the balance of the sound comes out from right and left side of the speakers. (Notice: When Matrix Surround is enabled, adjusting the Balance will not completely mute any one speaker.)
Matrix Surround	Off	The surround sound is mixed to left and right in order to create the illusion of virtual surround speakers. (Recommendation: when the Matrix Surround is on, ensure the Balance is set to "0" for optimum surround sound effect.)
	On	
Dynamic Bass	Off	Dynamic Bass gives you the enhanced bass sound. Low frequency signals can be boosted while the output signal amplitude is measured.
	On	
Perfect Volume	Off	Automatically adjusts audio input levels to stay within a safe volume range. For example, when the input sound is too loud, the volume is automatically decreased.
	On	
TV Speakers	Off	This needs to be switched to Off when you want to listen to audio from external equipment.
	On	It is normally set to On when you operate the set using the built in speakers.
Reset		Each item on this menu screen can be restored to the original factory settings by pressing  button.

TV SETUP OPERATION (continued)

Timer Menu

This allows your **television** to turn Off (Standby mode) at set time automatically, which you may find useful.

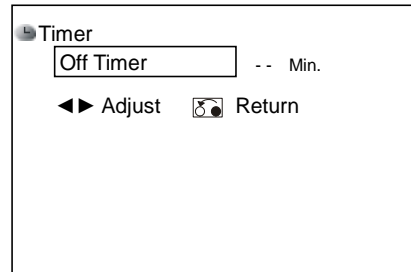

Selected Items		Setup hint
Off Timer	- - Min.	This function automatically sets the power to Standby mode when the selected time period has elapsed.
	30Min.	
	60Min.	
	90Min.	
	120Min.	

Information

One minute before the time you set, the screen will display "Time off within one minute".

TV SETUP OPERATION (continued)

Audio Switching (TV)

NICAM / Sound Multiplex (including A2) (TV mode)

You can make optimum use of available audio by pressing I/II button of remote control. Audio can be switched only if receiving NICAM and sound multiplex signals; otherwise, pressing this button will have no effect, such as when only mono sound is received.

These can be divided into two main categories: Bilingual/Dual Sound broadcast and Stereo broadcast.

Bilingual/Dual Sound broadcast

Bilingual broadcast is the broadcast available on the main and sub languages, while dual sound broadcast is available on the primary and secondary sounds; for example, some sports programs contain broadcast commentary on a game as primary sound, and a commentary about a team as the secondary.

When bilingual program is received, sound mode display appears in yellow as shown. Also, when receiving NICAM signals, NICAM display will appear.

Each time I/II button is pressed, the display is switched in the sequence of following.

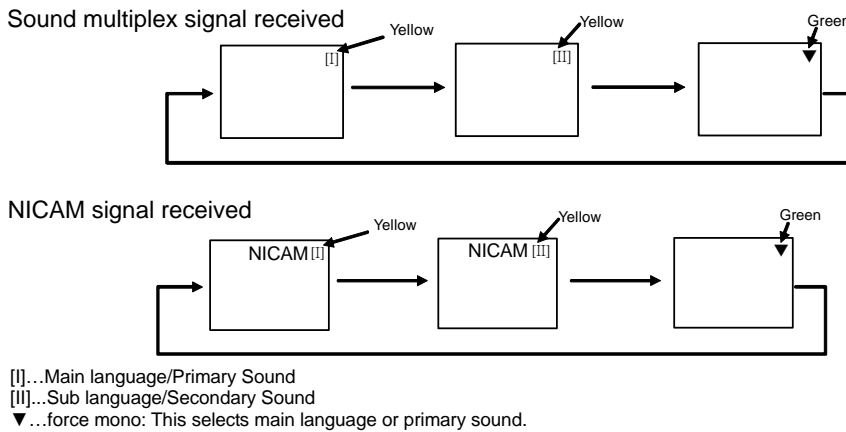

Stereo broadcast

With stereo broadcast, you can enjoy different sound from either side.

When a stereo program is received, sound mode display will appear in red as shown. Also, when receiving NICAM signals, NICAM display will appear.

Press I/II button to switch between stereo and mono sound.

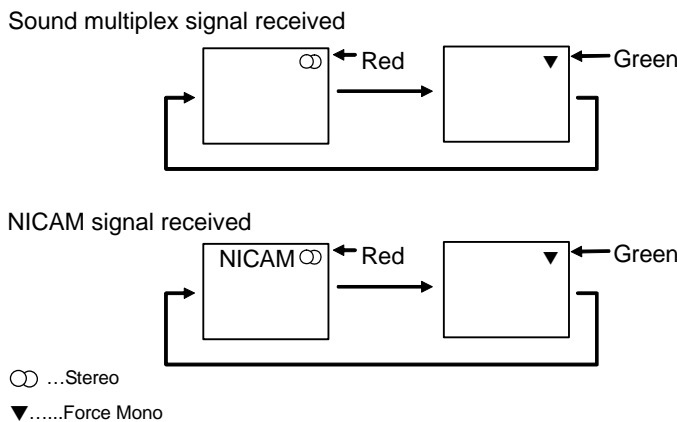

NOTE



- Please select ▼ (force mono) in case of poor reception, noise, poor stereo sound due to signal condition so that you can receive a clear mono sound.
- represents the Mono broadcast.

TV SETUP OPERATION (continued)





PC Adjustment Setting

You can adjust the display condition such as position adjustment and color setting while connecting to the PC and being RGB mode. See [18] for the PC connection.

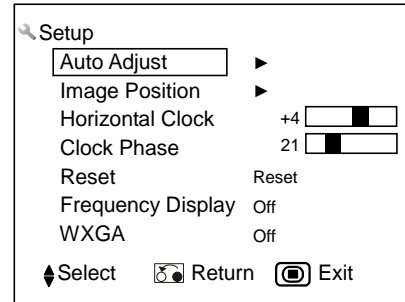
From Setup Menu (RGB)

1. Press  button.
2. Select "Setup" menu and press  button.
3. Select the preferred menu item and press  button.



Selected Items		Setup hint
Auto Adjust		Adjust Horizontal Position, Vertical Position, Horizontal Clock, and Clock Phase automatically. <ul style="list-style-type: none"> • Press  or  button to start auto adjustment as needed. The message "Auto Adjust" is displayed. • Depending on the type of the signal, there is a possibility that the display may not be adjusted in its optimum condition with this function. In that case, please adjust each item manually.
Image Position*		<ul style="list-style-type: none"> • Press  button and  button to adjust the horizontal and vertical display positions. (For example: When user connect PC terminal to LCD TV set. PC Display card provide timing is 1024x768 60Hz that Horizontal range: -100~+100 and Vertical range: -22~+22.)
Horizontal Clock*	-31~+31	Minimize the vertical stripes on the screen.
Clock Phase*	0~+63	Minimize the blurring of the letters and stripes on horizontal row. <ul style="list-style-type: none"> • Make sure to adjust <u>Horizontal Clock</u> first before adjusting Clock Phase.
Reset		Each item on this menu screen can be restored to the original factory settings by pressing  button.
Frequency Display	Off	Select whether indicating the PC signal frequency information on Input Signal Screen Display or not.
	On	
WXGA	Off	<ul style="list-style-type: none"> • This function is available only for WXGA signal. • Refer to "Recommended Signal List" on [58].
	1280x768	
	1360x768	



Information

The setting of the items indicated by " * " can be automatically stored depending on the signal mode.





TV SETUP OPERATION (continued)

PC Adjustment Setting (continued)

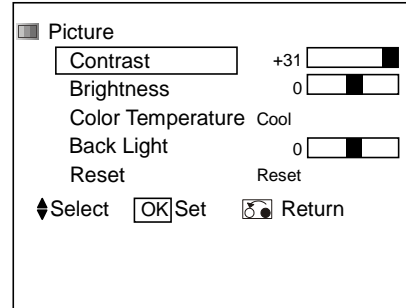
From Picture Menu (RGB)

1. Press  button.
2. Select "Picture" menu and press  button.
3. Select the preferred menu item and press  button.



Selected Items		Setup hint
Contrast	-31~+31	This adjusts the contrast to meet the lighting environment by using  button.
Brightness	-31~+31	With this function, black is adjusted to change the overall brightness by using  button..
Color Temperature	Cool	You can select from 3 settings (default): Cool, Normal, Warm depending on the color condition with  buttons. You can adjust the setting in "User" item.
	Normal	
	Warm	
	User	
Back Light	-20~+20	Adjust the brightness of the Back Light for the maximum visibility.
Reset		Each item on this menu screen can be restored to the original factory settings by pressing  button.

Information

There is a useful function to automatically store the setting on menu in almost every item so that you do not have to reset every time.

TV SETUP OPERATION (continued)

Analog Teletext

What is "Teletext"

Teletext is the written information services provided by each TV channel. Most TV channels provide information via Teletext such as:

- TV program schedule
- Weather forecasts
- Sports results
- Newsflash

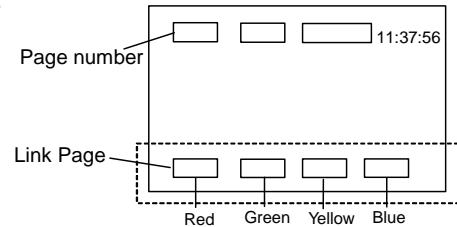

Select Teletext Language

1. Press button.
2. Select "Setup" menu and press button.
3. Select "Teletext Language" and press button.

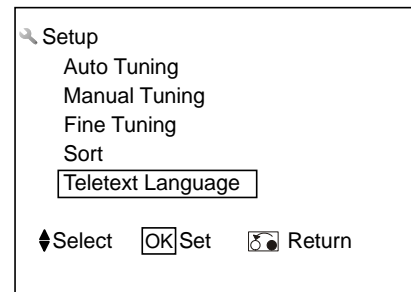











Selected Items	Setup hint
Teletext Language	<p>Select Teletext Language from 5 different categories (West Europe, East Europe, Russian, Arabic and Farsi) According to the area.</p> <p>West Europe : Asian countries where the Teletext Is broadcasting in English such as Singapore, Australia, and Malaysia</p> <p>East Europe : Poland, Sweden, Hungary</p> <p>Russian : Russia</p> <p>Arabic : Arab countries</p> <p>Farsi : Iran</p>

TV SETUP OPERATION (continued)

Analog Teletext (continued)

How to Operate the Teletext

You can display the Teletext simply by pressing the remote control buttons.

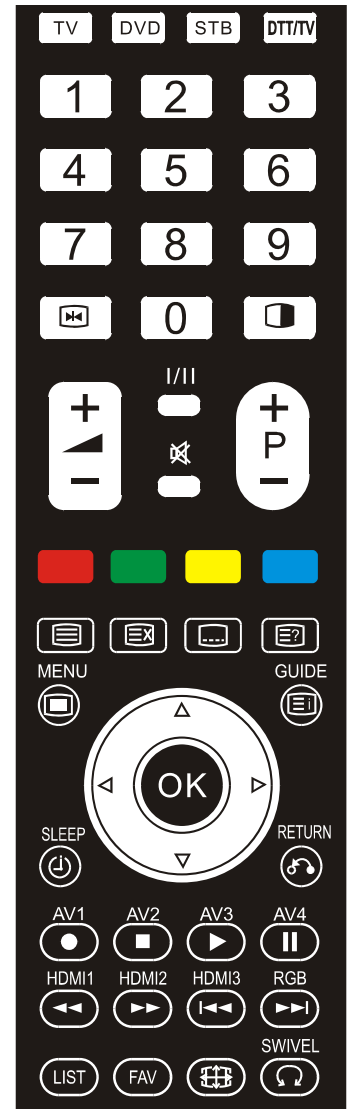

Operation	Press
To activate Teletext mode.* To exit from the Teletext mode.	 [TV ↔ Text]
To move to the next or previous page.	 [Page Select]
To jump to the indicated page. (Enter 3 digits.)	 [Page Select]
To change Teletext picture size.	 [Zoom]
To display Index page.	 [Index]
To adjust Back Light of the image.	 [Back Light]
To access Subtitle service directly (if the channel has the Subtitle service broadcasting).*	 [Subtitle]
To display Hidden text. Ex. The answers of the Quiz or the Game page. Press again to close the revealed answer.	 [Reveal]
To return to actual broadcast temporarily while searching for the Teletext page you request. When the search is done, the designated page # will be displayed on the upper left of the screen. Press again to return to Teletext page.	 [Cancel]
To access the link pages which are displayed at the bottom of the page. (Select the buttons corresponding to the colors of the letters on screen.)	 [Color]
To hold the text picture.	 [Hold]



* This is not available in the following conditions.

- Color system : NTSC 3.58, NTSC 4.43, PAL60, PAL-M
- No input signal

Information

- Each time the  button is pressed, the Teletext pages size will be change in single screen.
- Some Teletext pages do not display Link Pages at the bottom of the screen. Press  button to display them.

NOTE









- Teletext function is different between Analog and Digital. Refer to  about Digital Teletext.

DIGITAL TERRESTRIAL TELEVISION (DTT) OPERATION

How to use the On-Screen Display (OSD) system

With the On-Screen Display system, you can access the various kinds of the features and functions.

● Basic Operation

1. Press  button on the remote control or **Menu** button on the control panel of the unit. The **DTT Main Menu** is displayed on the screen as shown on the right.
2. To select the item, press  buttons.
The selected item will be highlighted.
3. Press  button to set your selection.
The selected menu page will be displayed on the screen.
4. Use  buttons to choose the item on the MENU page.
Press  button to set your selection.
5. Use  buttons to adjust the item values or choose options.
Press  button to set your selection.
6. To exit from the menu, press  button.

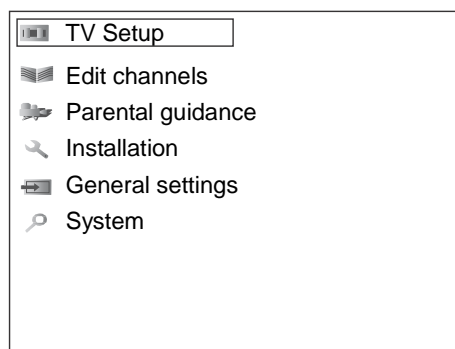

(DTT Main Menu)

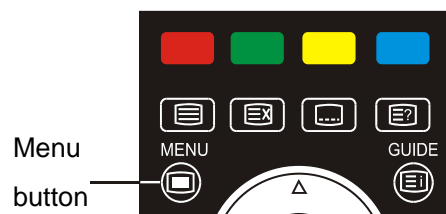

NOTE

- The OSD menu screen will be closed automatically when no operation has been made for about 30 seconds.
- During DTT input, the part of OSD might not be displayed in 4:3 mode. To display fully, select the  other display size with button. (Refer to [46](#))

DTT Main Menu List

Check the reference page for details.

Menu	Function	Page
TV Setup	This jumps to the TV main menu containing Analog TV functions, such as Picture menu and Audio menu.	46
Edit channels	You can set a list of favorite channels.	42
Parental guidance	This blocks programs with the selected rating.	44
Installation	This searches the available channels.	40
Manual scan	Search by its channel number, frequency, bandwidth, or priority.	40
Quick scan	Search by the resident area.	40
Auto scan	Automatically search one by one.	40
Restore default	Restore the channel setting.	40
General settings		43
Option setup	Set up the display time of information banner.	43
Change pin	Change the Password.	44
Local time	Set up the local time.	45
Subtitle setting	Enable or disable the subtitle.	43
System	This displays the current DTT system information.	45

DIGITAL TERRESTRIAL TELEVISION (DTT) OPERATION (continued)

Installing Channels

You can search available channels in any of the following 3 methods.

1. Press button on the remote control in DTT mode.
2. Select “**Installation**”, on the DTT main menu with buttons and press button.
3. The password is required to enter the Installation menu. The initial password is 0000.
4. You can select either of the followings by pressing button.

- **Manual scan:** Searches by individual settings manually. The box shown on the right appears. Fill out the following 4 items as needed.

Channel num	Use buttons or numeric button to enter the number. (Ch2-Ch69) *In case of tuning Ch9A, select Ch2 (Frequency: 205.5MHz.).
Frequency	Use numeric button to enter the frequency.
Bandwidth	Select either 7MHz or 8MHz by using buttons. Set to 7MHz normally.
Priority	Select High or Low by using buttons. Set to High normally.

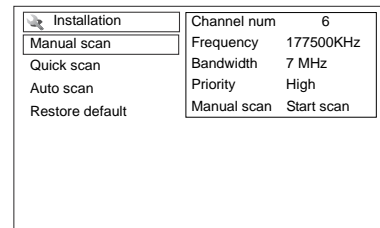

Then, press button on “**Start scan**” of “**Manual scan**” column. If it finds a channel, “**Success**” shows up. If not, “**Timeout error**” is displayed.

- **Quick scan:** Searches channels of the selected area. The list of the area shows up. Select one of those with buttons and press button.

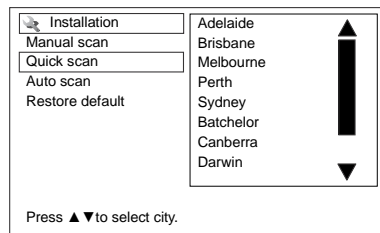

NOTE

- If you are uncertain about the area, please select “Auto scan” method or contact the local dealer in your area.
- **Auto scan:** Searches every channel.

The message “**Auto scan will take more than 10 minutes. Do you want to continue?**”

Select “**Yes**” and press button to precede it.

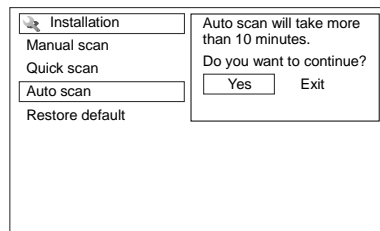

Restoring Channels

This restores the all channel settings.

1. Press button on the remote control in DTT mode.
2. Select “**Installation**”, on the DTT main menu with buttons and press button.
3. The password is required to enter the Installation menu. The initial password is 0000.
4. Select “**Restore default**” and press button. The message “**All setting would be lost**” appears. Select “**Yes**” and press button.

NOTE



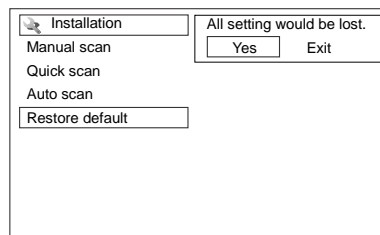



- The password will return to the default setting when activating “**Restore default**”



DIGITAL TERRESTRIAL TELEVISION (DTT) OPERATION (continued)

Making Favorite List

The “Edit channels” menu allows you to select your favorite channels and make a Favorite List in order to access easily to the channel you watch most often.

1. Press  button on the remote control and select “**Edit channels**” and press  button.
2. Use  buttons to select the channel, and  button to select **Fav. 1** or **Fav. 2**.
3. Press  button to set up as Fav. List. The ♥ mark will show up, which means as favorite channel. Pressing  button again on the mark will cancel the setting.

You can display favorite list by pressing  button. (Refer to )

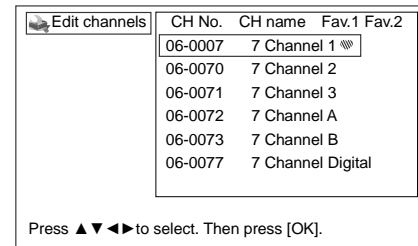

Information Banner

- Display information by changing channel

Whenever a channel is switched, the TV displays the banner containing the brief channel information(name of channel and program, etc.)

- Display information by changing channel





The TV displays not only brief information but also program description.

Each time  button is pressed, it displays information by following order.

Brief Channel Information → Current Program Description →
Next Program Description → Normal Screen

- Set up the display time

The display time of information banner can be set up from 1 to 20 sec.

1. Press  button on the remote control.
2. Select “**General settings**” and press  button.
3. Select “**Option setup**” and press  button.
4. The box shows up, and selects the display time by using  buttons.

NOTE

- When you select “**0 sec**” for “**Information box timeout**”, the information banner will not show up.

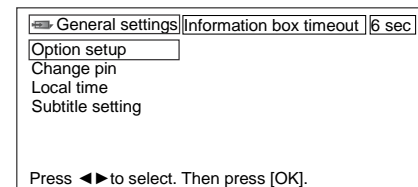
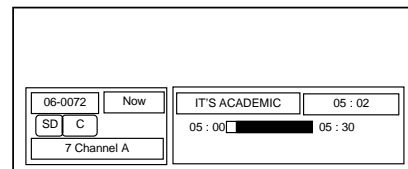





DIGITAL TERRESTRIAL TELEVISION (DTT) OPERATION (continued)

Digital Teletext

Teletext can provide various information with text on the screen.

Press  button to access. Press it again to return to the normal screen.

Operation	Press
To activate Teletext mode. To exit from the Teletext mode.	 [TV↔Text]
To move to the next or previous page	 [Page Select]
To jump to the indicated page.	 [Page Select]
To access Subtitle service directly (if the channel has the Subtitle service broadcasting).	 [Subtitle]

NOTE

- See [37](#) how to operate at Analog teletext.
- The service of digital broadcasting signal varies depending on the area.
- When you press the color buttons along with the direction on the screen, you can access the linked pages.





P100 Austext 100 Tue 14 Mar 16:04:58	
AUSTEXT MAIN INDEX	
COPYRIGHT INFORMATION ON 104	
INDEX	INFORMATION
MAIN INDEX100	GENERAL INDEX600
BUSINESS113	HOROSCOPES606
NEWS160	SCI/TECH NEWS677
WEATHER300	SHOWBIZ NEWS683
TAB SERVICE500	TEST PAGES690
GENERAL INFO. 600	
TV PROGRAMS. 650	
CAPTIONS801	
MAKE AUSTEXT YOUR FIRST CHOICE FOR LOCAL NEWS NATIONAL NEWS INDEX PAGE 120	



Electronic Program Guide (EPG)

The EPG screen displays a list of the stored channels along with information. This provides the information for 7 days.



1. Press  button to display EPG screen.
2. You can adjust the EPG screen with the following remote control keys.

Button	Select a channel/program, Display information
	Select a program from the list. <ul style="list-style-type: none"> • The picture of selected program is displayed at lower right screen. • The detailed information of selected program is displayed at lower left screen.
	Select a channel. <ul style="list-style-type: none"> • The picture of selected program is displayed at lower right screen. • The detailed information of selected program is displayed at lower left screen.
Red/Green	Select date. (up to 7 days)
Yellow/Blue	Move to the next or previous page if more than on e page.
Button	Reserve a program
	Set the view timer by pressing  button on the selected item. <ul style="list-style-type: none"> • mark will be displayed. • Up to 5 items can be selected. • A message appears when the desired program is about to start while you are watching another channel. • Press  button to cancel the reservation.

Electronic Program Guide	
Page 1/1	Monday 19 March 2007
◀ 06-0070 Seven HD Digital ▶	
22:00 – 23:00	Movie News
23:00 – 00:00	Sports News ★
Prev Day	Next Day
Prec Page	Next Page
OK Reserve	
Sports News 23:00 – 00:00	
Highlights and features on today's sports in the world.	

NOTE

- The message appears only during DTT mode. (Please note that this does not appear in TV, AV, RGB, and HDMI mode.)
- This setting will be canceled once turns Off the TV.

3. Press  button or  button to return to the normal screen.





NOTE

- Not all channels broadcast all program information data. Some channels do not provide program name and details. In that case, only channel name are displayed.

DIGITAL TERRESTRIAL TELEVISION (DTT) OPERATION (continued)

Subtitle

The enables (disable) the subtitle if available as your useful tool.

1. Press  button to display DTT main menu.
2. Select "General settings" and press  button.
3. Select "Subtitle settings" and press  button.
4. With  buttons select "Enable" and press  button.

You can also activate the subtitle by pressing  button on the remote control. "Subtitles On" or "Subtitles Off" will appears on the upper left corner.



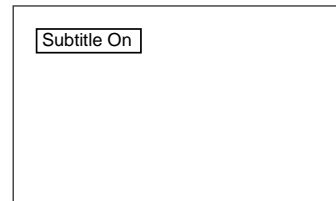
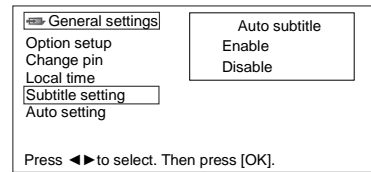

NOTE

- Once Turing TV off, "Auto subtitle" returns to "Disable".



Parental Guidance

Any channel can be locked so that it cannot be selected for viewing without 4 digits pin code.

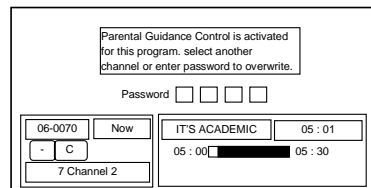
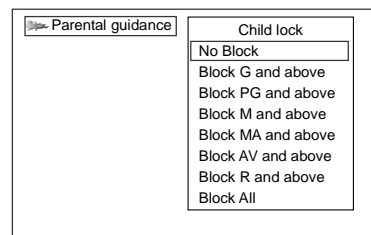

1. Press  button on the remote control.
2. Select "Parental guidance" and press  button.
3. The password is required to enter. (The initial password is **0000**.)
4. With  buttons, select the rating and press  button.

After this protection, when encounter the channel blocked, the message show up and the password is required to view the channel.



Audio Language (MPEG/Dolby® Digital)



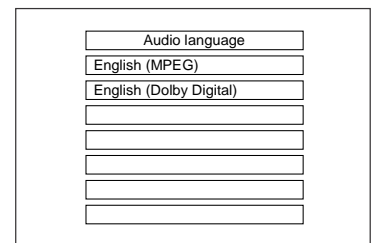

The available Audio language (MPEG/Dolby® Digital) can be selected.

1. Press  button on the remote control in DTT mode.
2. The available audio language (MPEG/Dolby® Digital) appears.
3. With  buttons, select the audio language and press  button.



Digital Audio Output

This enables you to select the optical digital audio output between PCM and Dolby® digital.

1. Press  button to display DTT main menu.
2. Select "General setting" and press  button.
3. Select "Audio setting" and  button.
4. With  button, select either "PCM" or "Dolby Digital" and press  button.

NOTE

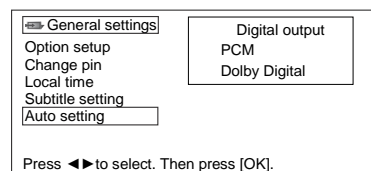

- In case that MPEG audio is selected by using I/II button, or the broadcasting program has only MPEG audio, it outputs only PCM audio even if "Dolby Digital" is selected in "Audio setting" menu.
- If Dolby® Digital audio is selected by using I/II button, you can select either "Dolby Digital" or "PCM" from "Audio setting" menu.



DIGITAL TERRESTRIAL TELEVISION (DTT) OPERATION (continued)

Change Pin

To use the locks effectively, do change the pin number from the default setting, which should be known and remembered only by you. The default setting is **0000**.

1. Press  button on the remote control.
2. Select “**General setting**” and press  button.
3. Select “**Change pin**” and  button.
4. The box appears to fill out the old and new password, and the confirmation of the new password.
5. Use the numeric number to enter.





NOTE

- In case that you forget your password, please refer to Troubleshooting on 

General settings	Old password	* * * *
Option setup	New password	* * * *
Change pin	Confirm new password	* * * *
Local time		
Subtitle setting		

Local Time

Make sure to select your resident area to set up the correct local time.



1. Press  button on the remote control.
2. Select “**General setting**” and press  button.
3. Select “**Local time**” and  button.
4. With  buttons, select the area and press  button.

General settings	Current time zone
Option setup	Greenwich mean time
Change pin	Adelaide, Aust.
Local time	Brisbane, Aust.
Subtitle setting	Canberra, Aust.
Audio setting	Darwin, Aust.
	Melbourne, Aust.
	Perth, Aust.
	Sydney, Aust.
	Tasmania, Aust.

Press  to select. Then press [OK].

Checking DTT System Information

This can display current DTT system information.

1. Press  button on the remote control.
2. Select “**System**” and press  button.
3. Pressing  button on “**Status**” shows up System information.
(H/W version, S/W version, and Release time)

System	System information
Status	H/W Version : H2-DT640HD
	S/W Version : 1.2.0
	Release time : JUL 27 2007 21:06:23



System information. Press [Return] to return.

*The above is an example

Jump to TV Setup Menu

“**TV Setup**” menu can be accessed from the DTT main menu.

It jumps to the TV main menu containing Analog TV function, such as Picture menu and Audio menu.

Refer to  ~  regarding the setting form the details.

Picture
Audio
Timer
Setup
Select  Set

FUNCTION

Size Switching

Each time  button of the remote control is pressed, the screen display size is switched in sequence, and the status will be displayed at the bottom of the screen.

TV/AV signal input

- Display Size

Watching standard Definition Picture(480i,480p,576i,576p)



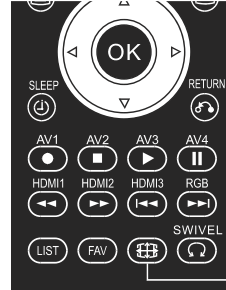

TV/AV1/AV2/AV3/AV4 /HDMI1~3

→ 4:3 → Panoramic → Cinema → Full →

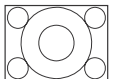
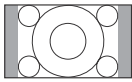
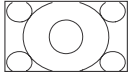

Picture Size

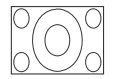
You can display the image at optimum condition by selecting display size depending on the current output image as shown below.

Input Signal	Display Screen	Display Size	To display suitable screen as follows.
When Watching Standard Definition Picture (TV, 480i, 480p, 576i, 576p)			
 (4:3 Signal)		4:3	Play a 4:3 image on screen faithfully. Blanking occurs on both sides.
		Panoramic	Play a 4:3 image which enlarges horizontal and vertical size of the middle in equal scales, and displays both sides appearing much wider.
 (Cinema)		Cinema	Play a 21:9 image in 4:3 frame (Cinema size) expanding vertically. *In some case, slight blanking may remain at the top and bottom.
 (Squeeze)		Full	Play a 4:3 image faithfully in the standard vertical size and horizontally squeezed.

Information

Aspect ratio represents horizontal: vertical ratio on screen.

Watching High Definition Picture(720p, 1080i, 1080p (HDMI only))

DTT/AV1,2/HDMI1~3: Only Full mode signal output.

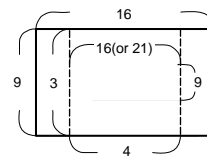

NOTE

- The size will fix as Full mode and not change when receiving High Definition Picture (720p, 1080i, 1080p (HDMI only)).
- If the images from High Definition Picture has blacken gap and select Picture Size [2], it will make up for the gap. Refer to [31](#).

CAUTION

Using a wide-screen television

- This television has a screen mode selection feature. If an incompatible screen mode is selected to play certain software, such as a TV program, the image would appear different form the original. Take this into consideration when making screen mode choices.
- Use of the wide feature displaying enlarged pictures in coffee shops, hotel and other establishments for commercial or public viewing purposes could infringe on the copyright holder's right protected by Copyright Law.
- When a normal 4:3 image (not wide screen) is displayed over the entire screen in the Panoramic mode, the peripheral image may disappear partly and/or appear distorted in some cases. Use 4:3 mode to view the image reflecting original intention.

FUNCTION (continued)

Size Switching (continued)

RGB signal input

You can select a suitable size depending on the resolution.

Full → 4:3

Display Area Selection Diagram

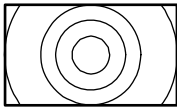
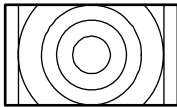
Resolution	Full	4:3
640x400 (VGA)		
640x480 (VGA)		
800x600 (SVGA)		
1024x768 (XGA)		
1280x768 (WXGA)		
1280x1024 (SXGA)		
1360x768 (WXGA)		

Multi Picture Mode

With this feature, you can watch different channels simultaneously on one screen in several ways.

As for the available signals, please refer to "Recommended Signal List" on [57](#), [58](#).

Activate the Multi Picture Mode in HDMI Mode

To activate Multi Picture mode in either TV, AV, HDMI, and RGB mode, press  on the remote control.

2-picture mode





You can watch two different pictures side by side.

This mode is available in both TV mode and AV mode (AV1~4 Input).

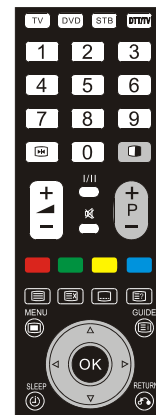
Control on the side with Speaker Icon

Audio is output from the selected picture with the speaker icon. Switch the Input modes (HDMI1~3) on the Main-Screen. Switch the Input modes (DTV/TV and AV1~4) or change Channels on the Sub-Screen.



- To shift the speaker icon , press  button.
 - The speaker icon  will be shifted from A to B back-and-forth.
- To change the channel of the of the Sub -Screen
 - Make sure that  mark is located on the Sub -Screen.
 - Press  to select channels.
- To change the Input mode of the Sub -Screen
 - Make sure that the speaker icon is located next to the Input mode indication of the Sub -Screen
 - Press Input Select buttons on the remote control. (DTV/TV , AV1~4 are available)

NOTE

- The message " Not Available" will be appeared on the screen when the combinations of the **Input modes** are not acceptable. (See the Table below for details.)

The selected picture with speaker icon

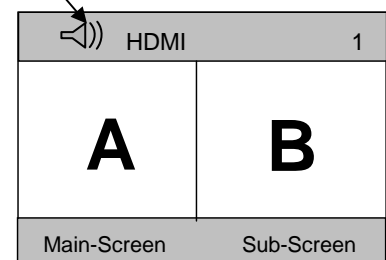

FUNCTION (continued)

Multi Picture Mode (continued)

Table: Mix-and –Match of the Input Modes (HDMI)

Main \ Sub	DTT	TV	AV1	AV2	AV3	AV4
HDMI1	○	○	○	○	○	○
HDMI2	○	○	○	○	○	○
HDMI3	○	○	○	○	○	○

(O: Available)







Activate the Multi Picture Mode in RGB Mode

When you activated the Multi Picture mode in RGB Input, the picture will be displayed at the mode which the Sub-screen is displayed inside of the large screen (Main-screen).

- To activated Multi Picture mode, press  on the remote control.

The speaker icon  indicates the following.

- The audio sounds can be heard on the side with the speaker icon.
- When the speaker icon is on the Sub-screen
 - Change channels.
 - Switch the Input modes (DTT/TV, AV3~4 and HDMI1~3) on the Sub-screen.
(Main-screen is only for RGB Input.)

- To shift the speaker icon , press  button.
 - The speaker icon  will be displayed in front of the Input mode indication.
- To change the channel of the Sub-screen.
 - Make sure that  mark is located on the Sub-screen.
 - Press  to select channels.
- To change the Input mode of the Sub-screen.
 - Make sure that the speaker icon is located next to the Input mode indication of the Sub-screen (lower).
 - Press Input Select buttons on the remote control. (DTT/TV, AV3~4, and HDMI 1~3 are available)
- To exit from the Multi Picture mode, press  button.

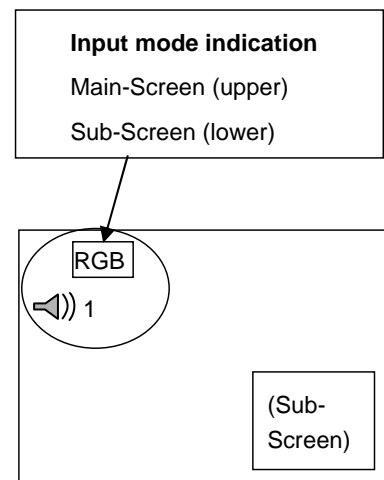

NOTE

- When operating Multi Picture mode, the "Power Save mode" is not available even though the Horizontal / Vertical Sync. Signal (or any kind of Video signal) has not input for certain period of time.
- The message " Not Available" will be appeared on the screen when the combinations of the **Input modes** are not acceptable.
(See the Table below for details.)

Table: Mix-and –Match of the Input Modes (RGB)

Main \ Sub	DTT	TV	AV3	AV4	HDMI1	HDMI2	HDMI3
RGB	○	○	○	○	○	○	○

(O: Available)

As for the available signals, please refer to "Recommended Signal List" on [57](#), [58](#).

FUNCTION (continued)

Multi Picture Mode(continued)

Activate the Multi Picture Mode in Video Mode





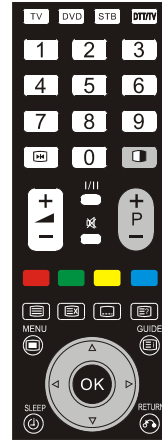

To activate Multi Picture mode in either TV, AV, HDMI, and RGB mode, press  on the remote control.

2-picture mode

You can watch two different pictures side by side.
This mode is available in both TV mode and AV mode (AV1~4 Input).

Control on the side with Speaker Icon 
Audio is output from the selected picture with the speaker icon.
You can switch the Input modes (DTT/TV and AV1~4) or change Channels only on the side with Speaker icon.



1. To shift the speaker icon  , press  button.
 - The speaker icon  will be displayed in front of the Input mode indication.
2. To change the channel of the Sub-screen.
 - Make sure that  mark is located on the Sub-screen.
 - Press  to select channels.
3. To change the Input mode of the Sub-screen.
 - Make sure that the speaker icon is located next to the Input mode indication of the Sub-screen (Upper).
 - Press Input Select buttons on the remote control. (DTT/TV, AV3~4, and HDMI 1~3 are available)
4. To exit from the Multi Picture mode, press  button.

The selected picture with speaker icon

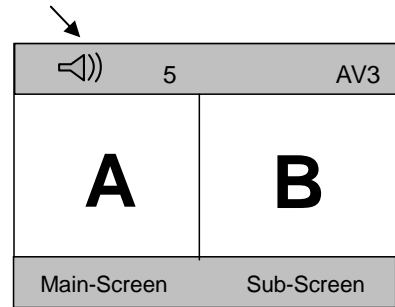

NOTE

- You cannot select input on both sides simultaneously.
- You cannot select the same AV input on both sides simultaneously.
- The message “ Not Available” will be appeared on the screen when the combinations of the **Input modes** are not acceptable.
(See the Table below for details.)

Table: Mix-and –Match of the Input Modes

Main \ Sub	DTT	TV	AV3	AV4	HDMI1	HDMI2	HDMI3
DTT	-	○	○	○	○	○	○
TV	○	-	○	○	○	○	○
AV1	○	○	○	○	○	○	○
AV2	○	○	○	○	○	○	○
AV3	○	○	-	○	○	○	○
AV4	○	○	○	-	○	○	○

(O: Available)

FUNCTION (continued)

Picture Freezing

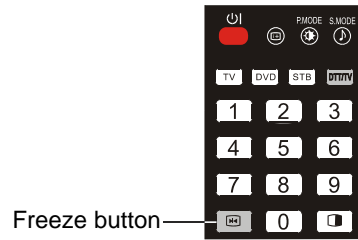

By pressing  button, you can change to freeze mode easily anytime you like. Press it again to return to normal picture.



Power Save Mode

When the AV input is selected

You are provided the function to save power consumption when no signal is detected in AV input. Set to On in **"Video Power Save"** from Function Menu, which leads to the power save mode in AV1 /AV2 /AV3 /AV4 /HDMI1 /HDMI2 /HDMI3 and the Standby mode in other AV input. Please see the table below for details.

1. Press  button.
2. Select **"Setup"** menu and press  button.
3. Select **"Video Power Save"** and press  button.

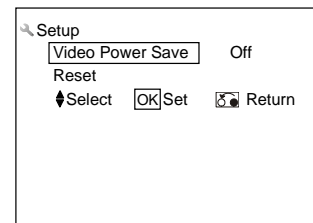

Video Power Save	Off
	On

	When no signal is detected		When signal is input during on in "Video Power Save"
	Condition	Indicating Lamp	
AV1~AV2, AV3~AV4, HDMI1~3	Power Save*	Orange	Turns On automatically

*Power Save that only control Back Light On/Off.

Returning to operating status

- Press the **Input Select** button of the control panel or the remote control to restart the television.

When the RGB input is selected

When this unit is connected to a VESA DPMS computer, the Power Save mode (Operation mode: Off) can be set to be activated automatically when the computer is not being used to reduce power consumption by this unit.

RGB sync signal	Horizontal	Yes	No	Yes	No
	Vertical	Yes	Yes	No	No
PC signal		Active (normal display)	Blank (no display)		
Operation mode		On	Off		
Indicating lamp		Lights green	Lights orange		

Returning to operating status

- Operate the personal computer, then input computer's H. sync, V. sync or press the **Sub Power** button of the control panel or the remote control to restart the television.

FUNCTION (continued)

DVD Player/ STB Selection

You can use this remote control to operate DVD Player and Set Top Box of other manufacturers as well as this set. After press **[DVD]** or **[STB]** button, press (or hold) the required buttons to select the manufacturer and type as shown below.

Set up

Example: HITACHI DVD **[2]**

1. Set up the manufacturer.

Press **[DVD]** button so that the button light. While the button is lighting (Approx. 30 seconds), press **[DVD]** and **[1]** buttons.

2. Set up the manufacturer type.

Press **[1]** button so that the button light. While keeping **[DVD]** button depressed. Then press **[2]** buttons.

3. Confirm the setting.

After setting the manufacturer and type, press the Power On/ Off button on the remote control. If the DVD dose not switch ON, repeat setp 1 and 2 using other manufacturer types as listed.



<"DVD" Selection>

Manufacturers of DVD Player	Set Manufacturer	Set type	Manufacturers of DVD Player	Set Manufacturer	Set type
HITACHI	[DVD] [1]	[1] ~ [3]	RCA	[DVD] [0]	[1]
FUNAI	[DVD] [2]	[1]	Mitsubishi	[DVD] [1]	[1]
Pioneer	[DVD] [3]	[1] ~ [6]	ONKYO	[DVD] RED	[1] ~ [3]
Panasonic	[DVD] [4]	[1] ~ [4]	ZENITH	[DVD] GREEN	[1]
TOSHIBA	[DVD] [5]	[1] ~ [4]	THOMSON	[DVD] YELLOW	[1]
Philips	[DVD] [6]	[1] ~ [2]	SHINCO	[DVD] BLUE	[1]
JVC	[DVD] [7]	[1]	SKYWORTH	[DVD] [1]	[1]
SAMSUNG	[DVD] [8]	[1]	BUBUKO	[DVD] [1]	[1]
Sony	[DVD] [9]	[1] ~ [4]	DENON	[DVD] [1]	[1] ~ [2]
Sharp	[DVD] [1]	[1] ~ [2]	YAMAHA	[DVD] [1]	[1] ~ [2]

<"DVD" Selection>

Manufacturers of STB Player	Set Manufacturer	Set type
HITACHI	[STB] [1]	[1] ~ [2]
TOSHIBA	[STB] [2]	[1]
DGTEC	[STB] [3]	[1]
Panasonic	[STB] [4]	[1]
Zinwell	[STB] [5]	[1]
PX	[STB] [6]	[1]

NOTE

- Please note that not all models of the listed manufacturers can be operated using this remote control.





TROUBLESHOOTING

Before calling service technician, check the following tables first. If the problem is not be solved with the suggested procedures, contact your local dealer. For your safety, NEVER try to repair the product by yourself.

When Following Messages Appear on the Screen

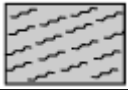

Message	Condition / Action	Page
Power Save	This indicates it is in Power Save mode. (in RGB mode) The indicating lamp lights in orange.	50
No Sync. Signal	The unit cannot detect any signals from any input terminals. <ul style="list-style-type: none"> • Check if the cable is connected correctly and firmly. • Check if the power of the external equipment is ON. • Check if the input selection matches the connection terminal. • Check if the PC is in Power Save mode or not. 	16 ~ 22
Auto Adjust	This indicates that it is in the process of auto adjusting. (in PC input mode)	35
Invalid Mode	The unit receives unsupported signals. <ul style="list-style-type: none"> • Check if the cable is connected correctly and firmly. • Check if the input signal is compatible with the specification of the television. 	55, 57 58
Not Available	This shows when the selected operation is not available.	
Weak signal	<ul style="list-style-type: none"> • Check aerial lead if it is disconnected/damaged/misaligned. (in DTT mode) • Check with your dealer if it is out of signal area or not. (in DTT mode) 	
Bad or No signal		
Database is Empty		

Symptom and Check List

Symptoms	Check list	Page
No picture – no sound	<ul style="list-style-type: none"> • Check the Indicating lamp status (Off, Red, Green, or Orange). • Check the connection of the Power Cord and/or other cables. • Check if the Main Power of the unit or external equipment is ON. • Check if the TV mode is selected. • Check if the TV is in “Standby mode” or “Power Save mode”. • Adjust the values in “Picture menu” and “Audio menu”. 	16 ~ 23 50
Snowy picture-poor sound	 <ul style="list-style-type: none"> • Check the aerial connection and direction. • The TV station may have broadcast difficulties. • Try another channel. 	16
Multiple images-normal sound	 <ul style="list-style-type: none"> • Check the aerial connection and direction. • Fine tuning the TV. • Check the connection of the external equipment. • The TV station may have broadcast difficulties. Try another channel. 	16, 28
Intermittent interference	 <ul style="list-style-type: none"> • Check if the source of interference is shielded well. • Remove those kinds of electrical devices away from the TV. 	
Normal picture, but no sound	<ul style="list-style-type: none"> • Check the volume level. • Check if the  button has been press or not. • Make sure that the headphone is NOT connected. • Check the connection of the external equipment. 	16 ~ 20 23









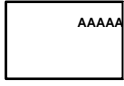
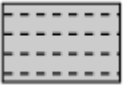

TROUBLESHOOTING (continued)

Symptom and Check List (continued)

Symptoms	Check list	Page
• No picture – normal sound	• Check the value level of “Brightness” and “Contrast” in “Picture Menu”.	30
• The remote control does not work.	• Check if the batteries are installed correctly. • The batteries might be exhausted. Replace them with new ones. • Remove all the obstructions in front of the sensor window on the unit. • Check if the buttons of the control panel can work.	12, 13
• Normal picture but no color-normal sound	• Check the connection of the external equipment. • Check the “Color” in “Picture Menu”.	16 ~ 22 30 ~ 31
• Image is paused.	• Check if the TV is in freeze mode by pressing  button.	50
• No picture The Indicating lamp → Off	• Check if the Power Cord is plugged into the socket firmly. • Check if the Main Power is ON.	11, 16, 22
• No picture The Indicating lamp → Orange It means that the unit is in “Power Save Mode”.	• Check if all the cables of the external equipment are connected correctly and firmly. • Check if the power of the external equipment is ON. • Check if the TV/AV mode has been selected correctly. • Check if the PC is in Power Save mode or not. • Refer to “Power Save mode” and “When following messages appears on the screen”	50
• No picture The indicating lamp → Green	• Check if the signal cable is connected correctly and firmly. • Adjust the level of Brightness and Contrast lower.	16 ~ 21
• The top of the television and surface of the panel heat up.	• It may happen when you use the unit for long hours. Turn off the Main Power of the unit for a while. Please note that this is not all function.	22
• Image cannot be displayed in the correct position.	• Press Recall button  to check if the input signal of the displayed image is compatible with the specification of the television.	25, 54
• When the VCR is in special playback features (Fast forward or Rewind), the screen gets dark and cannot see the image at all.	• It could happen when the VCR is connected to Component output, such as 480i. This is not malfunction. • Try Composite output or S-video output and check the picture again.	
• The images are not displayed on sub pictures (right side) in “Multi Picture mode”	• There are some combinations of input signals that the images are not displayed on sub pictures (right side). • Please check the Table of “Multi Picture Function” for details.	47 ~ 49
• Some screen display size cannot be switched.	• Check the signal status by pressing the  button on the remote control. The available screen display size is different depending on the current signal status.	24 46, 47
• Cannot be displayed the image from HDMI 1~3	• Check if the cables are connected correctly. • Check the output format of the equipment. • (Please refer to “Connecting Procedure” and “Recommended Signal List”.)	15 55 ~ 58
• The image and audio are mismatched when in RGB or HDMI 1~3 mode.	• Check if the PC (RGB)/HDMI analog audio input terminal is connected to the same external device.	18, 19

TROUBLESHOOTING (continued)

Symptom and Check List (continued)

Symptoms		Check list	Page
<ul style="list-style-type: none"> The image on the screen is moving in an oblique direction. (PC input mode only) 		<ul style="list-style-type: none"> Adjust "Horizontal Clock" and "Clock Phase". 	35
<ul style="list-style-type: none"> The coarse horizontal stripes could be seen in full-display mode. (PC input mode only) 		<ul style="list-style-type: none"> Adjust "Horizontal clock". 	35
<ul style="list-style-type: none"> The part of the image is lacking. (PC input mode only) 		<ul style="list-style-type: none"> Try "Auto Adjust". 	35
<ul style="list-style-type: none"> The horizontal stripes are moving vertically with flickering screen. (PC input mode only) 		<ul style="list-style-type: none"> Check the Signal status of the PC by pressing Recall button  on the remote control. 	35
<ul style="list-style-type: none"> When the characters are displayed on the whole screen, <u>the vertical stripes appear and some of the characters are blurred.</u> (PC input mode only) 		<ul style="list-style-type: none"> Try "Auto Adjust". If the display condition is not improved with Auto Adjust, adjust "Horizontal Clock". 	35
<ul style="list-style-type: none"> When the letter string is displayed in full-screen, <u>all of the characters</u> on the screen is blurred. (PC input mode only) 		<ul style="list-style-type: none"> Try "Auto Adjust". If the condition is not improved with Auto Adjust, adjust "Clock Phase" till you get clearest image. 	35
<ul style="list-style-type: none"> When the small patterns are displayed on the screen, the entire screen is flickering. (PC input mode only) 		<ul style="list-style-type: none"> Try "Auto Adjust". If the condition is not improved with Auto Adjust, adjust "Clock Phase" till you get flicker-free display. 	35
<ul style="list-style-type: none"> Image cannot be displayed in the correct position. (PC input mode only) 		<ul style="list-style-type: none"> Press  button to check if input signal of the displayed image is compatible with the specification of the television. 	51, 35
<ul style="list-style-type: none"> No Picture or sound is output. (DTT mode only) 		<ul style="list-style-type: none"> It might occur because it is tuned to digital teletext channel. Return to another channel. 	45
<ul style="list-style-type: none"> Forgotten password. (DTT mode only) 		<ul style="list-style-type: none"> Press and hold down  [Yellow],  [Blue] and  [LIST] buttons on the remote control simultaneously for over 3 seconds so that the password returns to the default setting (0000). 	44
<ul style="list-style-type: none"> Due to the bad reception, block noise (DTT mode only) 		<ul style="list-style-type: none"> Check the aerial system to improve signal quality. 	15
<ul style="list-style-type: none"> Local time displays incorrectly. (DTT mode only) 		<ul style="list-style-type: none"> Check if you select correct area in "Local time" from "General setting". 	45

PRODUCT SPECIFICATIONS

SPECIFICATION		L37X01AU	L42X01AU
Panel	Display dimensions	Approx. 37 inches (820 (H) × 461 (V)mm, diagonal 941 mm)	Approx. 42 inches (930(H) × 523 (V)mm, diagonal 1067 mm)
	Resolution	1920(H) x 1080 (V) pixels	
Net dimensions		including Stand: 910 (W) x 680 (H) x 365 (D) mm excluding Stand: 910 (W) x 627 (H) x 125 (D) mm	including Optional Stand: 1033 (W) x 749 (H) x 365 (D) mm excluding Optional Stand: 1033 (W) x 692 (H) x 126 (D) mm
Net weight		including Stand: 24.4 kg excluding Stand: 20.1 kg	including Optional Stand: 28.5kg excluding Optional Stand: 24.2 kg
Ambient conditions	Temperature	Operating: 5°C to 35°C, Storage: 0°C to 40°C	
	Relative humidity	Operating: 20% to 80%, Storage: 20% to 90% (non-condensing)	
Power supply		AC110 - 240V, 50/60Hz	
Power consumption/at standby		177W/< 2W	210W/< 2W
Audio output		speaker total 20W	
(VIDEO input)			
Input terminals		AV1 · AV2: component video input terminal (RCA) L/R audio input terminal (RCA) AV3 · AV4: composite video input terminal (RCA) S video input terminal*1 L/R audio input terminal (RCA) HDMI1~3 : HDMI input terminal	
Input signals		Composite video : PAL, SECAM, NTSC3.58, NTSC4.43, PAL60 Component video: 480i, 576i, 480p, 576p, 720p/50, 720p/60, 1080i/50, 1080i/60 HDMI1~3 : 480i, 576i, 480p, 576p,720p/50, 720p/60,1080i/50,1080i/60,1080p/50, 1080p/60, 1080p/24	
Output signals		OUTPUT (MONITOR): composite video monitor-output terminal (RCA) OUTPUT (MONITOR): L/R audio monitor- output terminal (RCA) OUTPUT (HEADPHONE): L/R audio monitor- output terminal (Mini-pin) OPTICAL OUT (Digital Audio) : PCM, Dolby® Digital	
(RF input)			
Input terminal / Receiving range		ANT: 75Ω Unbalanced / 44~870MHz	
RF Video System		PAL B/G, H, I, D/K SECAM B/G, D/K, K1 NTSC-M DVB-T	
(RGB input)			
Input terminals		Analog RGB input terminal (D-sub 15-pin) Audio input terminal (3.5mm Stereo Mini Jack)*2	
Input signals		0.7 V, analog RGB (Recommended Signal)	
Sync signals		H/V separate, TTL level [2kΩ]	

• The television takes at least 30 minutes to attain the status of optimal picture quality.

*1 S-Video input terminal is available for AV3 of L37X01AU only.

*2 This analog audio input terminal can be used for PC (RGB) or HDMI(DVI) 1~3 only.

PRODUCT SPECIFICATIONS (continued)

Signal Input

S-input connector pin specifications

Pin	Input signal
1	Y
2	Y-GND
3	C
4	C-GND
Frame	GND

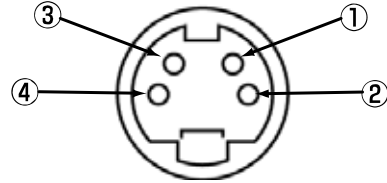

HDMI connector Input pin specifications

Pin	Input signal	Pin	Input signal
1	T.M.D.S. Data2+	11	TMDS Clock Shield
2	T.M.D.S. Data2	12	TMDS Clock -
3	T.M.D.S. Data2-	13	CEC
4	T.M.D.S. Data1+	14	Reserved (N.C.)
5	T.M.D.S. Data1	15	SCL
6	T.M.D.S. Data1-	16	SDA
7	T.M.D.S. Data0+	17	DDC/CEC Ground
8	T.M.D.S. Data0	18	+5V Power
9	T.M.D.S. Data0-	19	Hot Plug Detect
10	T.M.D.S. Clock+		

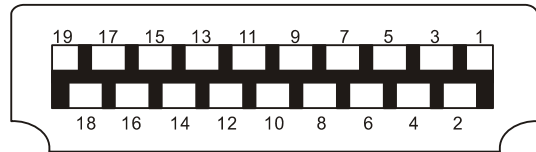

RGB terminal (D-sub 15-pin connector)

Pin	Input signal
1	R
2	G
3	B
4	No connection
5	No connection
6	R.GND
7	G.GND
8	B.GND
9	No connection
10	GND
11	No connection
12	[SDA]
13	H. sync
14	V.sync.
15	[SCL]

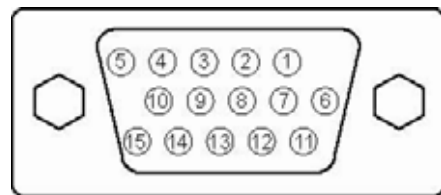

When different kinds of input signals are simultaneously input to the television via a graphics board or the like, the television only support H/V separate sync signal.

PRODUCT SPECIFICATIONS (continued)

Recommended Signal List

With Component Video INPUT

No	Signal mode			Horizontal frequency (kHz)	Dot clock frequency (MHz)	Remarks
	Signal name	Resolution	Vertical frequency (Hz)			
1	576i	720(1440) x 576	50.00	15.63	27.00	EIA-861D
2	480i	720(1440) x 480	59.94	15.73	27.00	EIA-861D
3	576p	720 x 576	50.00	31.25	27.00	EIA-861D
4	480p	720 x 480	59.94	31.47	27.00	EIA-861D
5	1080i/50	1920 x 1080	50.00	28.13	74.25	EIA-861D
6	1080i/60	1920 x 1080	60.00	33.75	74.25	EIA-861D
7	720p/50	1280 x 720	50.00	37.50	74.25	EIA-861D
8	720p/60	1280 x 720	60.00	45.00	74.25	EIA-861D

With HDMI INPUT

No	Signal mode			Horizontal frequency (kHz)	Dot clock frequency (MHz)	Remarks
	Signal name	Resolution	Vertical frequency (Hz)			
1	VGA	640 x 480	59.94	31.47	25.18	EIA-861D
2	576i	720(1440) x 576	50.00	15.63	27.00	EIA-861D
3	480i	720(1440) x 480	59.94	15.73	27.00	EIA-861D
4	576p	720 x 576	50.00	31.25	27.00	EIA-861D
5	480p	720 x 480	59.94	31.47	27.00	EIA-861D
6	1080i/50	1920 x 1080	50.00	28.13	74.25	EIA-861D
7	1080i/60	1920 x 1080	60.00	33.75	74.25	EIA-861D
8	720p/50	1280 x 720	50.00	37.50	74.25	EIA-861D
9	720p/60	1280 x 720	60.00	45.00	74.25	EIA-861D
10	1080p/50	1920 x 1080	50.00	56.25	148.50	EIA-861D
11	1080p/60	1920 x 1080	60.00	67.50	148.50	EIA-861D
12	1080p/24	1920 x 1080	24.00	27.00	74.25	EIA-861D

PRODUCT SPECIFICATIONS (continued)

Recommended Signal List (continued)

With RGB input

No	Signal mode			Horizontal frequency (kHz)	Dot clock frequency (MHz)	Remarks
	Signal name	Resolution	Vertical frequency (Hz)			
1	VGA	640 x 400	70.09	31.47	25.18	
2		640 x 480	59.94	31.47	25.18	
3	VESA	800 x 600	60.32	37.88	40.00	
4		1024 x 768	60.00	48.36	65.00	
5		1280 x 1024	60.02	63.98	108.00	
6	VESA	1280 x 768	59.88	47.78	79.50	
7		1360 x 768	60.02	47.71	85.50	

- The type of video board or connecting cable used may not allow for correct displays adjustment of Horizontal Position, Vertical Position, Horizontal Clock and Clock Phase.
- The unit differentiates the signal modes according to the horizontal and vertical frequencies and the horizontal and vertical sync signal polarities. Note that different signals having all these elements alike may be handled as the same signal.

With Multi Picture Function

- 2-Picture

Main \ Sub	Sub	DTT	TV	AV1, AV2	AV3, AV4	HDMI 1~3	TELETEXT
				Component	S-Video*1/ Composite		
DTT		–	O	–	O	O	–
TV		O	–	O	O	O	O
AV1, AV2	Component	–	–	–	O	O	–
AV3, AV4	Composite/S-Video*2	O	–	O	O	O	O*2
HDMI 1~3		O	O	O	O	–	–

(O: Available)

*1 S-Video input terminal is available for AV3 of L37X01AU only.

*2 This is not available when NTSC signal is received, or no AV signal is detected.