

StarBoard T-17SXL

User's Guide

How to Request a User's Guide

When requesting a separate copy of this user's guide, specify **T269-2-201**.

Read this user's guide and carefully retain it for future reference.

Before using this product, carefully read and fully understand the safety instructions.

Store this User's Guide nearby for ease of reference.

T269-2-201

Hitachi Software Engineering Co., Ltd.

Notices

Reproduction or reprinting, without permission, of this manual or any part thereof is prohibited.

The contents of this manual are subject to change without prior notice.

Every effort has been made to ensure that this manual is complete and correct. However, should any questionable points, mistakes, etc., come to your attention, please inform the vendor.

Please be advised in advance that this company will assume no responsibility for losses, etc., resulting from the operation of this product, regardless of the preceding clauses.

FCC Warning

The user is cautioned that changes and modifications made to the equipment without approval of the manufacturer could void the user's authority to operate this equipment.

This Class B digital apparatus complies with Canadian ICES-003.

Cet appareil numérique de la classe B est conforme à la norme NMB-003 du Canada.

Disclaimers

Hitachi Software Engineering Co., Ltd. assumes no liability and makes no warranty, either express or implicit, regarding the contents of this user's guide.

Also, the company makes no warranty as to the product's suitability, merchantability or fitness for a particular intended use.

All products of Hitachi Software Engineering Co., Ltd., described in this user's guide are presently for sale or are site-licensed.

Users who purchased the aforesaid product(s) will bear the costs of all required services, repairs, and damages resulting from defects in this product, and will bear the costs of direct or indirect damages (including the loss of profits or required information) that resulted from the product defects.

Moreover, Hitachi Software Engineering Co., Ltd., retains the right to revise this user's guide and to modify the contents thereof, without any obligation to notify anyone.

Product Assurance Provisions

This product is limited to use in the United States and Canada markets.

For warranty details, refer to Appendix 3.6 at the end of this user's guide.

This First edition of the user's guide (T269-2-201) is for the following products:

95.64301G00A (StarBoard T-17SXL)

The StarBoard T-17SXL incorporates WALTOP's 17-inch LCD monitor integrated digitizer technology.

Windows, Windows 98, Windows Me, Windows NT 4.0, Windows 2000, Windows XP and PowerPoint are trademarks of Microsoft Corporation (U.S.) and in other countries.

Other trademarks and product names are trademarks and/or registered trademarks of their respective holders.

Manual Creation Dates

June 2005, First Edition

T269-2-201

All Rights Reserved. Copyright © 2005, Hitachi Software Engineering Co., Ltd.

Manufacturer for Repairs

Contact the department below for technical questions concerning this product.

Hitachi Software Engineering America, Ltd.

601 Gateway Blvd, Suite 750

South San Francisco, CA 94080

Phone : 650-615-7614

Fax : 650-615-7639

E-mail : Starboard_Support@hitachi-soft.com

Safe Handling

Markings and Symbols

Various markings and symbols are used in this user's guide and on this product, to ensure the safe and correct use of this product and to prevent personal injury and property damage. These symbols and their meanings are as explained below. Understand the information well before reading the body of the user's guide.



WARNING

This symbol indicates the presence of potential dangers that, if ignored or applied incorrectly, could lead to death or serious injury.



CAUTION

This symbol indicates the presence of potential dangers that, if ignored or applied incorrectly, could lead to slight or moderate injury.

CAUTION

This symbol indicates the presence of potential dangers that, if ignored or applied incorrectly, could lead to damage to surrounding property.



This symbol draws attention to cautions (including warnings).



This symbol indicates something prohibited.



This symbol indicates something that must be done.

Safety Precautions

Always comply with them



WARNINGS

Securely insert the power plug into the power outlet.



If it is not plugged in securely, overheating will occur, possibly resulting in electric shock or fire.

Before moving this product, detach the power plug and the power cable.



The power cable might be damaged, possibly resulting in electric shock or fire.

Do not plug in the power plug with a wet hand.



Electric shock will result.

When plugging in or unplugging the power plug, hold the plug.



If the power cord is pulled, it might be damaged, possibly resulting in electric shock or fire.

Before cleaning this product, unplug the power plug.



Electric shock sometimes results.

Periodically clean the power plug to remove dust.



If a dirty plug is plugged into an outlet, fire or electric shock might result.

Do not use this product near water.



Electric shock will result.

Be careful about the locations of the power cable, etc.



The power cable might trip someone, possibly causing the product to fall, etc., thereby causing injury or product failure. Be careful with their locations.

Do not damage, break, process, or forcibly bend the power cable.



The power cable will be damaged, resulting in fire or electric shock.

Use the product at the indicated power supply voltage.



If the product is used at a power supply voltage other than the one indicated, it will fail, resulting in fire or electric shock.

Safety Precautions

Always comply with them



WARNINGS

Do not use a power cable other than the accessory power cable.



If a power cable other than the accessory power cable is used, fire or electric shock might result.

Do not open or alter the cabinet of this product.



The cabinet contains high-voltage areas, so electric shock or other injury will result.



Unplug the power plug if you do not plan on using the product for an extended period of time.



Failure to do so could result in a fire.

Do not leave this product or any of its accessories on the floor.



Someone might step on it and break it, or might be injured by tripping on it.

Only place specified objects on this product.



If a liquid or a metal object enters this product, electric shock or fire might result. If either should enter, unplug the power plug from the outlet and contact your dealer.



This Product must be disposed of as industrial waste, in accordance with the relevant laws and regulations.



Do not use this product in a location with high temperature or high humidity.



This product's usage environment conditions:

Temp.: 50 °F to 95 °F

Humidity: 30% to 80%

(But no condensation may be allowed to form..)

Do not place a heavy object on the power cable, heat or pull it.



The power cable will be damaged, causing fire or electric shock.

Safety Precautions

Always comply with them



WARNINGS

In the following cases, unplug the product from the AC Adaptor outlet and ask the technical support of Hitachi Software.

- a. After the power cord or AC Adaptor plug is damaged.
- b. After a liquid is spilled onto the main unit.
- c. After the main unit is exposed to rain or water.
- d. After this product malfunctions, even when operated according to the instruction manual. Adjust this product within the ranges specified in the instruction manual. Do not make other adjustments. A qualified service representative is required to correct improper adjustments.
- e. After this product falls or after its cabinet is damaged.
- f. After the functionality of this product changes and repair by a service representative is considered necessary.



WARNINGS

This product contains the substance mercury. When disposing this product, abide by state law legislating the disposal and handling of mercury.

Careful thought was given to the cautions on this device and in this user's guide. However, unanticipated circumstances might occur. When operating this product, users themselves must exercise caution as well as follow instructions.



WARNINGS

Warning Details	Page
<p>Use the AC Adaptor supplied with this product.</p> <p>Use only AC Adaptor or power cables specified by the manufacturer. Use of improper adaptors or cables can damage the product or cause a fire.</p>	P. 1-10



CAUTION

Warning Details	Page
<p>Hold the body firmly and slide the stand slowly when adjusting it.</p> <p>When adjusting the stand, if you pull up the lever without holding onto the body, the body may move suddenly, resulting in unexpected injuries or damage to the body.</p>	P. 1-8
<p>Use the screen at an easily viewable angle.</p> <p>Use the screen at an easily viewable angle, taking into account external light and ceiling lighting, which may reflect off the screen.</p>	P. 1-8

CAUTION

Warning Details	Page
<p>When changing the battery, be careful not to close the pen's rear part too forcefully.</p> <p>If too much force is applied when closing the rear part of the stylus pen, the pen may be damaged.</p>	P. 2-4

Contents

1. Introduction	1-1
1.1 Preparations before Use	1-1
1.1.1 Product Overview	1-1
1.1.2 Features	1-1
1.2 Parts Check	1-2
1.3 Part Names and Functions	1-3
1.3.1 Front Screen	1-3
1.3.2 Front Switch Panel	1-4
1.3.3 Connector Panel	1-5
1.3.4 Function Buttons	1-6
1.4 Assembly and Setup	1-7
1.4.1 Adjusting the Stand	1-7
1.4.2 How to Use the Pen Holder	1-8
1.4.3 Connection Procedure	1-9
2. Usage Procedures	2-1
2.1 Turning the StarBoard On	2-1
2.2 Using the Stylus Pen	2-2
2.2.1 How to Use the Stylus Pen	2-2
2.2.2 Basic Stylus Pen Operations	2-2
2.2.3 Stylus Pen Settings	2-3
2.2.4 Changing the Battery in the Stylus Pen	2-4
2.2.5 Replacing the Stylus Pen Tip	2-5
2.3 Using the OSD Menu	2-6
2.3.1 OSD Buttons and Their Functions	2-6
2.3.2 OSD Adjustment Options	2-7
3. Appendix	3-1
3.1 Troubleshooting	3-1
3.2 System Specifications	3-4
3.3 How to Take Care of the StarBoard	3-5
3.4 Consumables	3-5
3.5 LCD Panel	3-5
3.6 Provisions of Product Warranty	3-6

1. Introduction

1.1 Preparations before Use

This section covers preparations before using the StarBoard. Please read this section thoroughly if you are using the StarBoard for the first time.

1.1.1 Product Overview

StarBoard T-17SXL is a convenient and easy-to-use tablet-type interactive electronic board that lets you operate a PC with a stylus pen, and write text and images to a PC screen in real time as well as simultaneously input those to the PC. Those features work when the included software is set up on a PC connected to the StarBoard.

1.1.2 Features

○Write directly to the PC screen

Use the stylus pen just like a mouse to operate the PC on the screen displayed on the LCD monitor. The StarBoard Software allows text and images to be written to the PC, and allows the text and images to be input to the PC as digital data in real time. That data can then be saved, printed, or otherwise manipulated.

○Use as soon as the PC is started up

The StarBoard can be used as soon as the PC is started up, by just installing the StarBoard Software package included.

○Compatible with presentations in PowerPoint

Text and images can be written into presentation materials prepared in Microsoft PowerPoint. That allows you to further enhance presentation expression. Presentations can also be linked to remote meetings.

○Write on video images

Write text and images to screens of captured video. That allows for easy use of video materials in classes and presentations.

○Eight function buttons

Standard functions used frequently in the StarBoard Software are assigned to the eight function buttons located on the top left side of the StarBoard. Those buttons act as shortcuts when using the software.

1.2 Parts Check

After unpacking, make sure that all of the following parts are included.

Parts

No.	Name	Qty.
(1)	17-inch LCD monitor	1
(2)	Stylus pen	1
(3)	AAA alkaline dry cell	1
(4)	Spare pen tips	2
(5)	AC adapter	1
(6)	Power cable	1
(7)	RGB cable	1
(8)	USB cable	1
(9)	Audio cable (stereo mini-plug)	1
(10)	Pen tip replacement pin set	1
(11)	StarBoard Software x.x (CD-ROM) (*1)	1
(12)	StarBoard T-17SXL User's Guide (this manual)	1
(13)	StarBoard Software x.x User's Guide (*1)	1
(14)	StarBoard Function Buttons User's Guide	1
(15)	Warranty Sheet	1

(*1) The term "x.x." as used in this manual denotes the same version as the software which is included with the accessories.

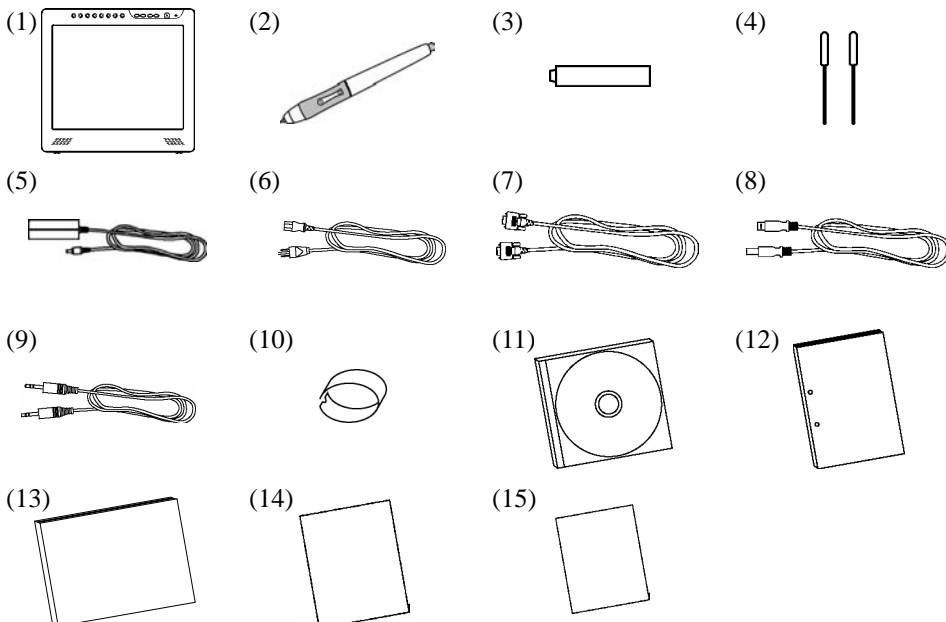

1.3 Part Names and Functions

1.3.1 Front Screen

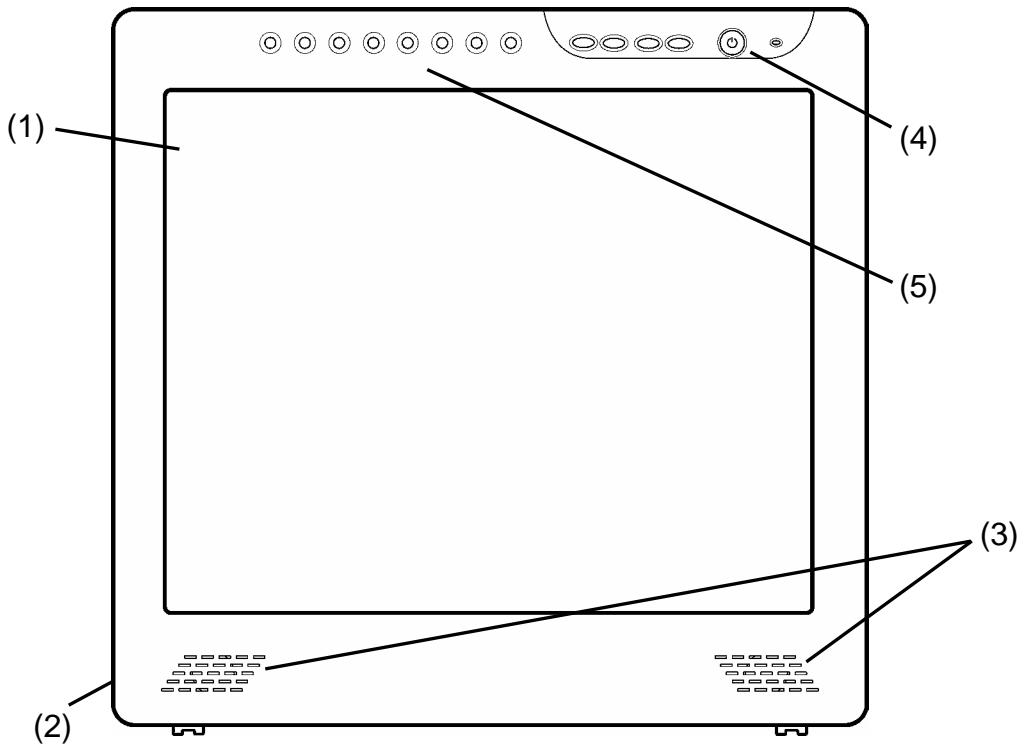

(1) LCD and tablet operating area

Receives text and graphical information entered with the stylus pen, and transmits the data to a PC.

(2) Stand (bottom of body and back)

The stand serves to hold the StarBoard in place. The LCD angle can be adjusted in the range of approx. 20° to 70°.

(3) Speakers

The supplied audio cable can be used to connect to the PC to allow audio output from the speakers.

(4) Front switch panel

These switches are used to turn the power ON/OFF, enter OSD menu settings, and adjust the volume.

(5) Function buttons

Eight standard functions used by the StarBoard software are assigned to these buttons. (For details on function button initial settings, see “1.3.4 Function Buttons” on page 1-6 of this User’s Guide.)

1.3.2 Front Switch Panel

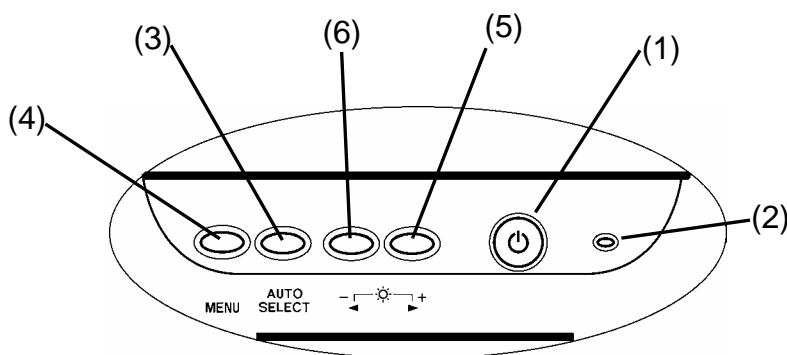

(1) Power button

This button turns the StarBoard LCD monitor ON/OFF.

(2) Power indicator

This indicator turns green when power is supplied normally to the StarBoard and an image signal is detected. It turns red when no image signal is output from the PC, or when power saving mode is on.

(3) AUTO/SELECT button

This button is used to automatically adjust the screen display and select OSD menu options.

(4) Menu button

This button is used to display the OSD menu. Press it after making menu selections to apply those.

(5) (+) button

This button is used to toggle muting ON/OFF. It is also used to select OSD menu options and change settings.

(6) (-) button

Brightness can be adjusted by the (+) and (-) buttons after pressing the (-) button. This button is also used to select OSD menu options and change setting values.

- For details on using the OSD menu, see “2.3 Using the OSD Menu” on page 2-6 of this User’s Guide.

1.3.3 Connector Panel

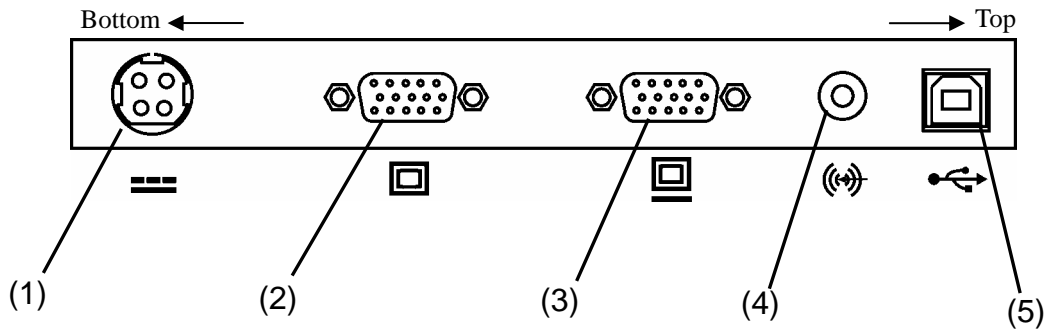

View of StarBoard Back Right Side

(1) Power port

The AC adapter is connected here.

(2) VGA input port

This port is used to connect a PC via RGB cable to display images from the PC.

(3) VGA output port

This port is used to connect external devices such as a projector via RGB cable to output video displayed on the StarBoard.

(4) Audio input port

This port is used to output PC audio from the StarBoard speakers. The supplied audio cable is connected to this port.

(5) USB port

A USB cable is connected here.

1.3.4 Function Buttons

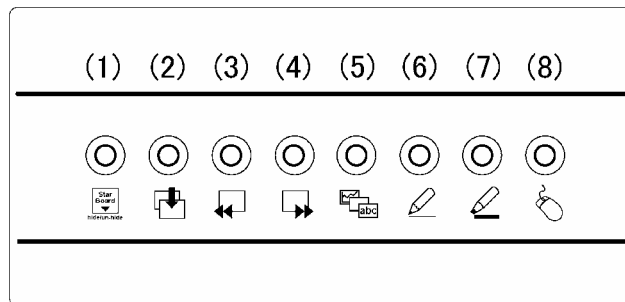

- | | |
|--|---|
| <p>(1) ToolBar hide/un-hide
Hides/displays StarBoard Software ToolBar.</p> <p>(2) New blank page
Adds a new blank page.</p> <p>(3) Previous page
Displays the page before the currently displayed page.</p> <p>(4) Next page
Displays the page after the currently displayed page.</p> | <p>(5) Topic list
Hides/displays the Topic List.</p> <p>(6) Solid pen
Switches to solid pen.</p> <p>(7) Fluorescent marker pen
Switches to fluorescent marker pen.</p> <p>(8) PC screen
Launches PC Operation mode, in which operations on the PC screen are done via the pen instead of the mouse.</p> |
|--|---|

- For details on using the function buttons, see the StarBoard T-17SXL Function Buttons User's Guide.

1.4 Assembly and Setup

Keep the following points in mind when installing the StarBoard.

Select a stable, flat location.

Avoid installing in locations that are dusty, extremely hot, cold, or humid. Also avoid installing in locations exposed to direct sunlight.

1.4.1 Adjusting the Stand

Follow the procedure shown below to adjust the stand.

(1) Pull up the stand lever.

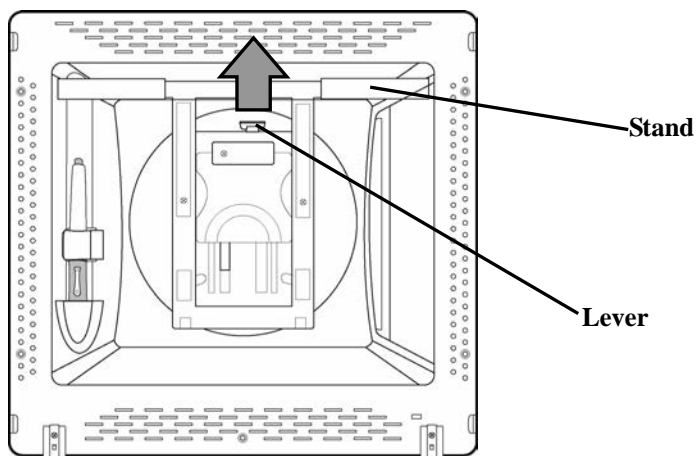

(2) Slide the stand to the desired angle, and release the lever.

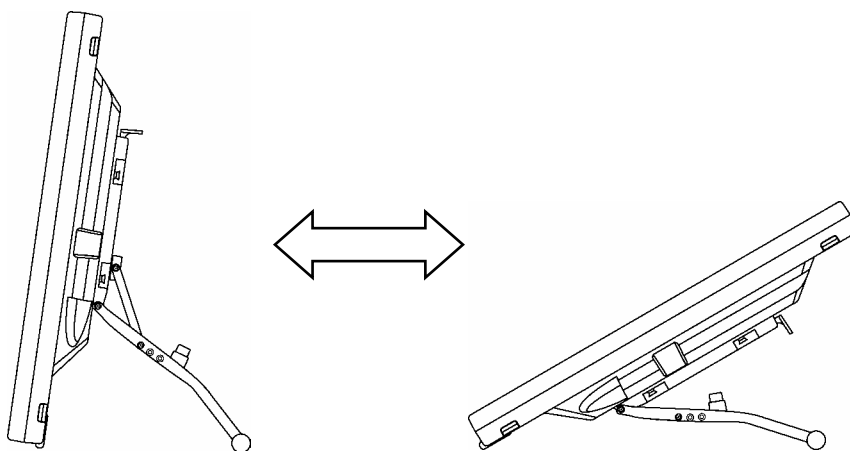

- (3) Check that the lever and stand are secure.

! CAUTION

Hold the body firmly and slide the stand slowly when adjusting it.

When adjusting the stand, if you pull up the lever without holding onto the body, the body may move suddenly, resulting in unexpected injuries or damage to the body.

Use the screen at an easily viewable angle.

Use the screen at an easily viewable angle, taking into account external light and ceiling lighting, which may reflect off the screen.

1.4.2 How to Use the Pen Holder

The T-17SXL comes with a pen holder on the back side.

Store the stylus pen in the pen holder when not in use.

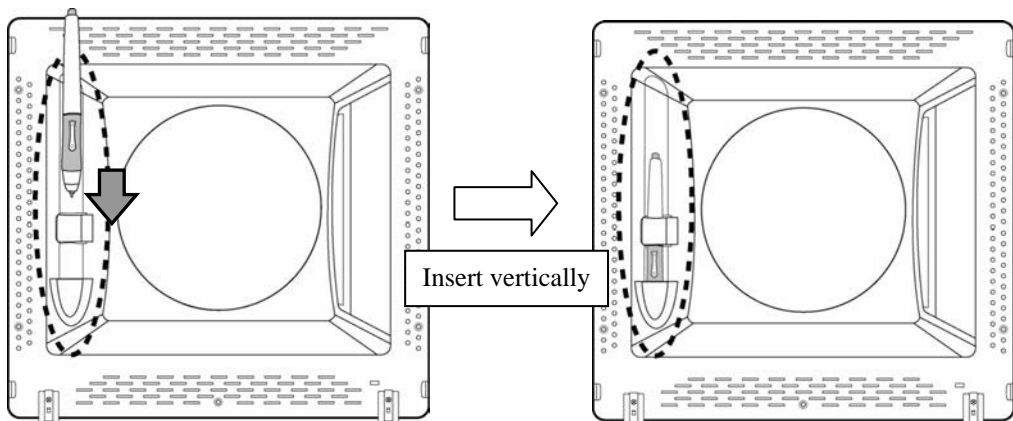

1.4.3 Connection Procedure

Follow the procedure below to connect the PC and StarBoard.

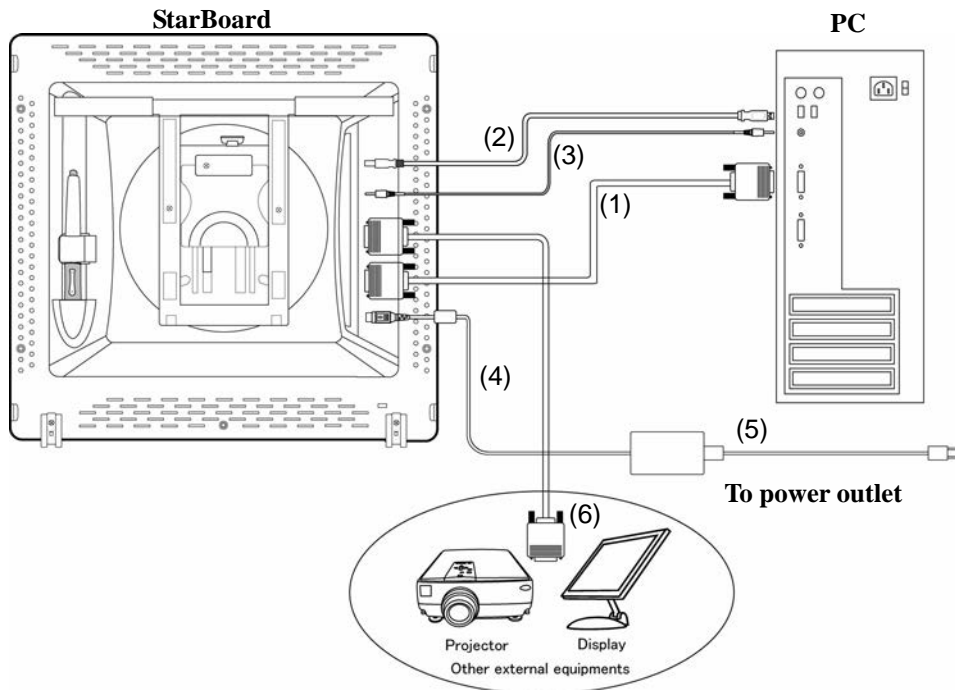

- (1) Connect the RGB cable to the VGA input port on the side of the StarBoard, and tighten the screws to fasten. Connect the other end of the cable to the PC VGA port, and tighten the screws to fasten.
- (2) Connect the USB cable to the USB port on the side of the StarBoard. Connect the other end of the cable to a USB port on the PC.
- (3) Connect the audio cable to the audio input port on the side of the StarBoard. Connect the other end of the cable to the audio output port on the PC. (Do this only if you plan to use the StarBoard's built-in speakers.)
- (4) Connect the AC adapter connector to the StarBoard power connector.
- (5) Connect the power cable to the AC adapter, then plug the power plug into power outlet.
- (6) If outputting the StarBoard screen to external equipment, connect the RGB cable to the VGA output port. Connect the other end of the cable to an input port on the external video equipment.



WARNING

Use the AC Adaptor supplied with this product.

Use only AC Adaptor or power cables specified by the manufacturer. Use of improper adaptors or cables can damage the product or cause a fire.

Using this product with Windows 98 and Windows 98 Second Edition

When using this product with Windows 98 or Windows 98 Second Edition, on some computers it may be necessary to install a driver for the USB controller located inside the PC. Follow the instructions shown in Windows to install the driver.

2. Usage Procedures

This section describes the basic procedures for using StarBoard. For information on using advanced StarBoard features, see the StarBoard Software x.x. User's Guide.

2.1 Turning the StarBoard On

This section describes how to turn the StarBoard on.

- (1) Turn on the StarBoard power.

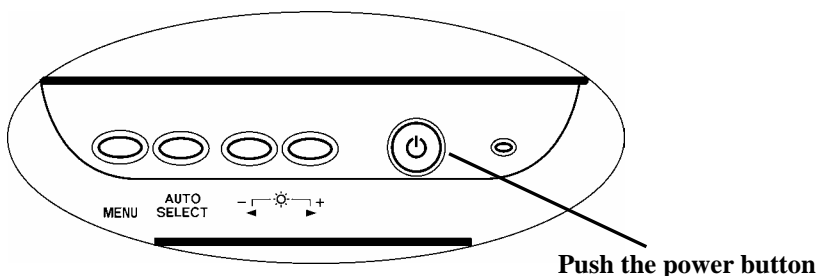

- (2) Turn on the PC and allow Windows to start.
- (3) The StarBoard Software starts automatically. (If the Startup checkbox was not checked during the shortcut creation process when the software was installed, the StarBoard Software will not start when Windows opens. In such cases, start the StarBoard Software manually. For further details, see the StarBoard Software x.x User's Guide.)

Manual Startup

Either select **Start** → **Programs** → **StarBoard Software** →  **StarBoard Software**, or double-click the StarBoard Software icon on the desktop. (The StarBoard Software icon is not created on the desktop unless the Desktop checkbox is selected during the shortcut creation process when the software is installed.)

Notice when displaying screens at SXGA resolution

Be sure to set the monitor refresh rate to 60 Hz if displaying the StarBoard at SXGA resolution (1280 × 1024). If used at a refresh rate other than 60 Hz, the pen may not operate correctly due to noise from the LCD panel. (For details on how to make settings, see your PC's manual and other documentation.)

2.2 Using the Stylus Pen

This section describes how to use the StarBoard stylus pen.

2.2.1 How to Use the Stylus Pen

The stylus pen has a power switch. Battery life can be prolonged by ON/OFF the power switch. To draw characters and figures using the stylus pen, set the power switch of the stylus pen to the ON position.

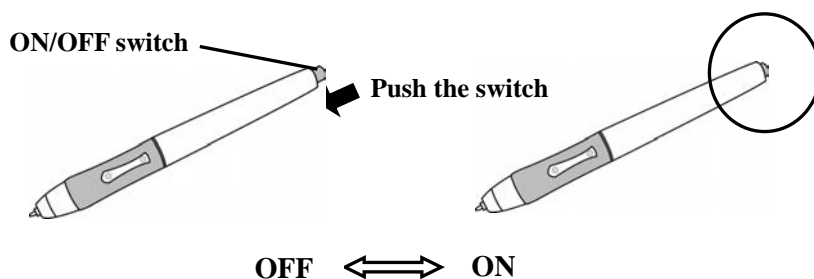

2.2.2 Basic Stylus Pen Operations

The stylus pen can be used in the same way as a mouse. Under the stylus pen's default settings, the pen tip button is set to correspond to the left mouse button. When Windows is open, the pen tip button may be used to perform the following mouse actions.

- **Clicking**
Press the pen tip against the display with a suitable amount of force and then release it quickly.
- **Double-clicking**
Press the pen tip against the display with a suitable amount of force and then release it, two times in a row.
- **Dragging**
Press the pen tip against the display with a suitable amount of force and then move the pen while keeping it pressed against the display (without releasing it from the display).

The permitted stylus pen input angle range is 30° in any direction from a position where the stylus pen is perpendicular to the display surface. Note that if the pen is tilted at an angle greater than 30°, its coordinates may not be input correctly.

2.2.3 Stylus Pen Settings

The stylus pen has one pen tip button, and two side buttons. Mouse actions can be assigned to these three buttons. The default button settings are summarized in the following table.

Button	User action	Corresponding mouse action
Pen tip	Press the pen tip against the display.	Mouse left-click
Side Button No. 0	Press the button with the pen tip slightly removed from the screen (5 mm or less).	Mouse left double-click
Side Button No. 1	Same as above.	Mouse right-click

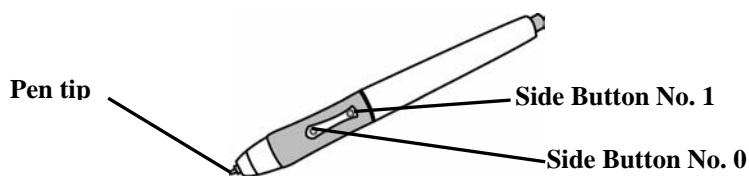

For details on changing the button settings, see the StarBoard Software x.x User's Guide.

2.2.4 Changing the Battery in the Stylus Pen

The stylus pen contains a single AAA alkaline dry cell. If the pen begins to operate erratically (e.g., if pen input is cut off), change the battery as described below. Note that battery life is approximately 1,800 hours under normal usage. If the residual quantity of a battery decreases, the center of a side button will light up red.

If the center of a side button will light up red, change the battery as described below.

- (1) Turn the stylus pen grip to separate the two halves.

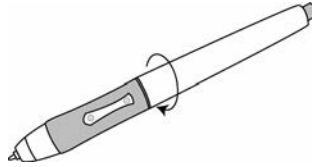

- (2) Remove the AAA alkaline dry cell contained in the grip, and insert a new cell with the positive side facing the pen tip.

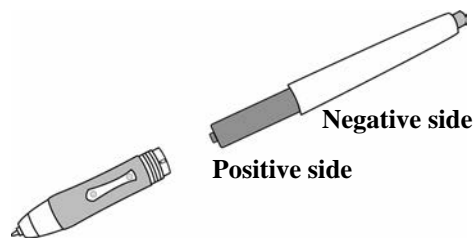

- (3) Put the stylus pen back together.

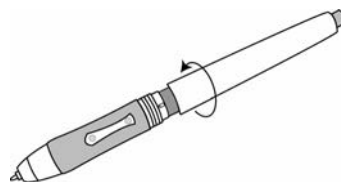

CAUTION

When changing the battery, be careful not to close the pen's rear part too forcefully.

If too much force is applied when closing the rear part of the stylus pen, the pen may be damaged.

2.2.5 Replacing the Stylus Pen Tip

When the stylus pen tip wears down and becomes too short, replace it as described below.

- (1) Using the special pin set, remove the stylus pen tip.

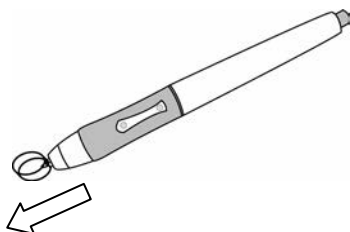

- (2) Insert a new pen tip into the stylus pen.

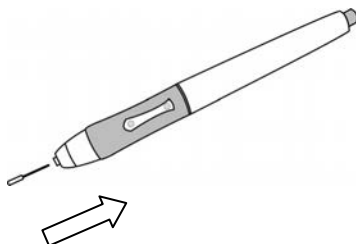

2.3 Using the OSD Menu

The OSD menu is used when adjusting the StarBoard LCD screen. OSD is an abbreviation for On-Screen Display. The OSD feature allows you to view and adjust the settings for the display on the screen.

2.3.1 OSD Buttons and Their Functions

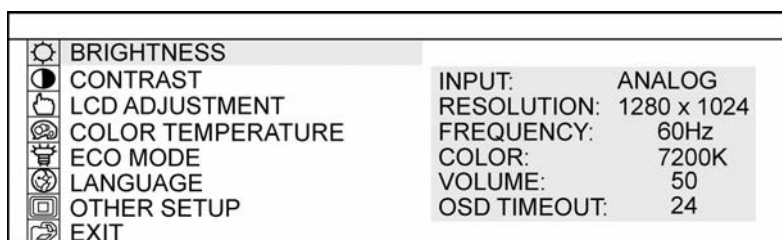
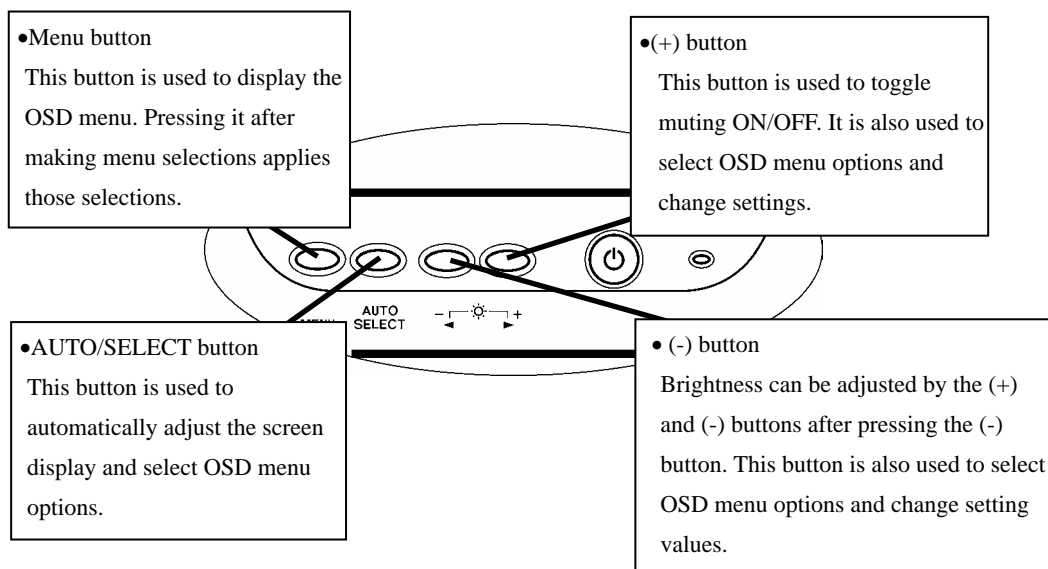

OSD Menu

■ Adjustment procedure

- (1) Press the Menu button to display the OSD menu.
- (2) Use the (+) button and (-) button to select a menu item.
- (3) Press the AUTO/SELECT button to confirm the selection.
- (4) Use the (+) button and (-) button to adjust the value, and AUTO/SELECT to select that value.
- (5) To close the OSD menu, leave buttons unpressed for a set amount of time (adjustable), or select EXIT from the menu screen. (If closing by not pressing buttons, setting changes made up to then will be applied when the OSD closes.)

2.3.2 OSD Adjustment Options

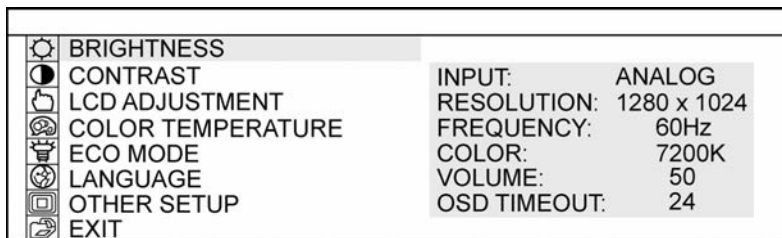

(1) BRIGHTNESS

Used to adjust screen brightness. (0-100)

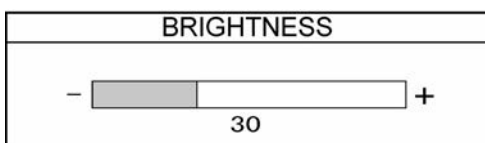

(2) CONTRAST

Used to adjust color contrast. The larger the value, the brighter the image will be. (0-100)

(3) LCD ADJUSTMENT

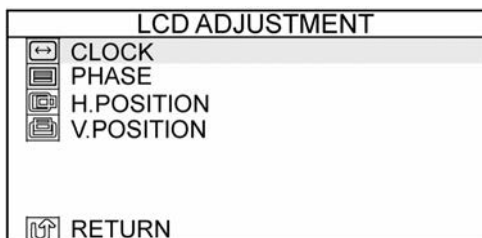

- CLOCK : Used to adjust screen size. (0-100)
- PHASE : Used to adjust the sampling timing (phase) for converting the analog input signal to a digital input signal. (0-63)
- H.POSITION : Used to change the horizontal position of the screen. (0-100)
- V.POSITION : Used to change the vertical position of the screen. (0-100)
- RETURN : Used to return to the previous page.

(4) COLOR TEMPRATURE

Used to adjust the color temperature of the screen.

(SRGB, 9300K, 7200K, 6500K, 5000K)

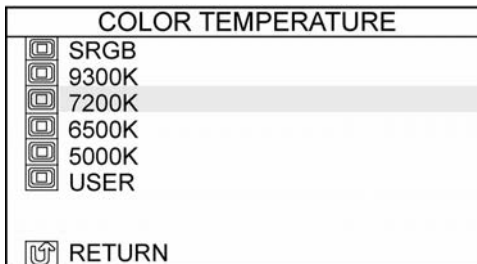

USER : Used to adjust the red, green, and blue colors of the screen.
(0-100)

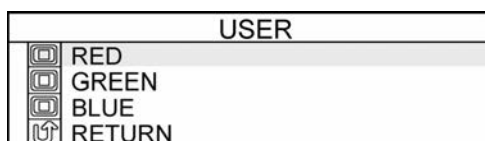

RETURN : Used to return to the previous page.

(5) ECO MODE

Used to turn the ECO mode ON, and limit brightness setting from 0 to 20 to reduce power consumption.

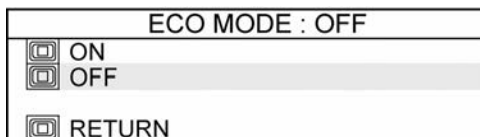

RETURN : Used to return to the previous page.

(6) LANGUAGE

Used to select the display language. The following languages are available: Japanese, English, French, German, Spanish, Italian, and Chinese.



RETURN : Used to return to the previous page.

(7) OTHER SETUP

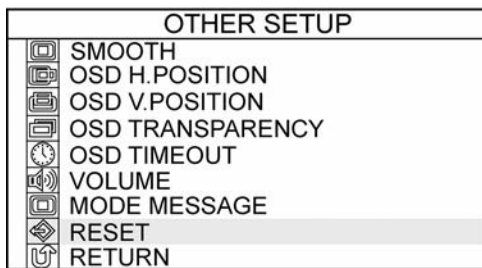

- SMOOTH : Used to adjust the smoothness of the image. (0-3)
- OSD H.POSITION : Used to adjust horizontal position of OSD window. (0-100)
- OSD V.POSITION : Used to adjust vertical position of OSD window. (0-100)
- OSD TRANSPARENCY : Used to turn OSD window background transparency ON/OFF.

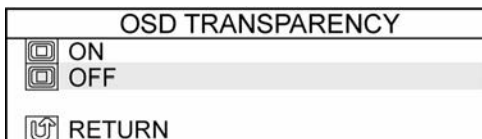

- OSD TIMEOUT : Used to set the amount of time before the OSD menu closes automatically. (0-60)
- VOLUME : Used to adjust the speaker volume. (0-100)
- MODE MESSAGE : Used to turn the screen resolution display ON/OFF.

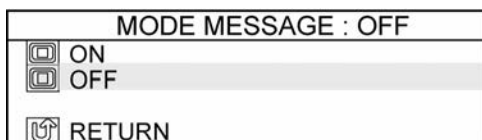

- RESET : Used to reset OSD menu settings to their default values.
- RETURN : Used to return to the previous page.

(8) EXIT

Used to exit the OSD menu.

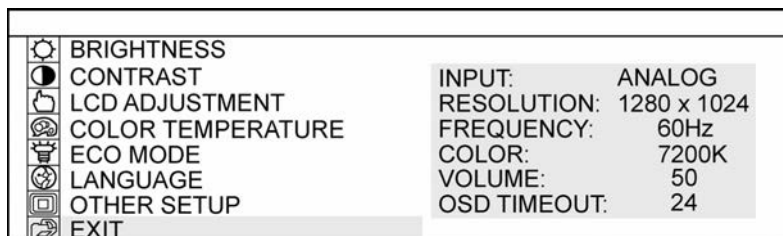

3. Appendix

3.1 Troubleshooting

First, check adjustments and handling methods and check for poor cable connections.

Those are often the causes of problems when nothing is actually broken.

Screen display-related problems

In this case	Check this	And do this
PC screen does not display on StarBoard.	Is the PC power on?	To deal with problem see the PC manual and other documentation.
	Is the RGB cable connected to the PC and StarBoard properly?	Connect the RGB cable correctly. (For details on how to connect, see “1.4.3 Connection Procedure” on page 1-9 of this User’s Guide.)
	For laptop PCs, is external (RGB) output selected?	Connect cable after starting up the PC, or switch to external (RGB) output at the screen display mode settings. (Method of switching differs by PC. For instructions, see the PC manual and other documentation.)
	Was LCD and monitor switching done right (may be assigned to a function key)?	Set so LCD and monitor are both selected, or that just the monitor is selected. (For details on selection, see the PC manual and other documentation.)
	Other	Contact technical support.

StarBoard Software-related problems

In this case	Check this	And do this
StarBoard is not recognized.	Is the USB cable connected properly?	Connect USB cable to PC. (For details on how to connect, see “1.4.3 Connection Procedure” on page 1-9 of this User’s Guide.)
	Was system startup done in the proper order?	Start up system in proper order. (For details on how to start up the system, see “2.1 Turning the StarBoard On” on page 2-1 of this User’s Guide.)
	StarBoard Software may be damaged or did not install correctly.	Uninstall StarBoard Software, and then reinstall. (For details on how to install StarBoard software, see “StarBoard Software Installation” in StarBoard Software x.x User’s Guide)
	Other	Contact technical support.

Stylus pen-related problems

In this case	Check this	And do this
Stylus pen does not operate.	StarBoard Software may be damaged or may not be installed correctly.	Uninstall StarBoard Software, and then reinstall. (For details on how to install StarBoard software, see “StarBoard Software Installation ” in StarBoard Software x.x User’s Guide)
	Is battery worn out?	Replace stylus pen battery. (For details on how to change the battery, see “2.2.4 Changing the Battery in the Stylus Pen” on page 2-4 of this User’s Guide.)
	Is pen tip worn down?	Check if the pen tip is worn down or is too short. (For details on how to replace the stylus pen tip, see “2.2.5 Replacing the Stylus Pen Tip” on page 2-5 of this User’s Guide.)
	Are there any electronic devices located nearby the StarBoard such as microwave ovens or radio transmitters that emit electromagnetic noise?	This product is susceptible to electromagnetic noise, so use the StarBoard away from devices that emit noise.
	Other	Restart Windows and StarBoard Software. Contact technical support.
Stylus pen tip and pen cursor positions do not match.	Did you calibrate the pen position correctly?	Calibrate the pen position correctly. (For details on how to calibrate the pen, see “Calibration” in the StarBoard Software x.x User’s Guide)
	Other	Contact technical support.

Function button-related problems

In this case	Check this	And do this
Function buttons don't operate.	Is the USB cable connected properly?	Connect USB cable to PC. (For details on how to connect, see "1.4.3 Connection Procedure" on page 1-9 of this User's Guide.)
	Is the StarBoard Software running?	Function button features require the StarBoard Software. Use them with the StarBoard Software running. (For details on how to use the StarBoard Software, see the StarBoard Software x.x User's Guide.)
	StarBoard Software may be damaged or may not be installed correctly.	Uninstall StarBoard Software, and then reinstall. (For details on how to install StarBoard software, see "StarBoard Software Installation" in StarBoard Software x.x User's Guide.)
	Are there any electronic devices located nearby the StarBoard such as microwave ovens or radio transmitters that emit electromagnetic noise?	This product is susceptible to electromagnetic noise, so use the StarBoard away from devices that emit noise.
	Other	Restart Windows and StarBoard Software. Contact technical support.

3.2 System Specifications

Item		Specification
Product name		StarBoard T-17SXL
Model No.		95.64301G00A
Display characteristics	Driver type	Active-Matrix Liquid Crystal Display (TFT)
	Effective screen size	17 inches 337.920 mm (W)×270.336 mm (H)
	Resolution	1280×1024 (SXGA)
	Pixel pitch	0.264×0.264 mm
	Standard colors	16,200,000 colors
	Brightness	260 cd/m ²
	Contrast ratio	450 : 1
Viewing angles		right 70°, left 70°, up 70°, down 70°
Digitizer characteristics	Input system	Electromagnetic induction
	Pen	Stylus pen (Uses one AAA alkaline dry cell; battery life: approximately 1800 hours*)
	Coordinate resolution	0.05 mm
	Reading accuracy	± 0.5 mm
	Tracking speed	Approximately 125 points per second
	Interface	USB interface (USB1.1)
Input/output	Input	Dsub 15-pin (analogue RGB) Stereo mini-jack (stereo audio)
	Output	Dsub 15-pin (analogue RGB)
Speaker output		Stereo (1 W+1 W build-in amplifier)
Environmental conditions	Temperature	During use: +10 – +35°C; in storage: -10 – +60°C
	Humidity	During use: 30 – 80% (no condensation); in storage: 10 – 80% (no condensation)
Power consumption / power supply		40 W or less (4W or less in power saving mode) / AC adapter Input (AC 100 – 240 V, 50/60 Hz, 1 A) Output (DC 12 V, 3.3 A)
External dimensions		395.0 (W)×375.0 (H)×57.0 (D) mm (without stand)
Weight		Approx. 5.0 kg
Stand adjustment		Adjustable in the range of 20° to 70°
Compatible operating systems		Windows 98/98SE/Me/2000/XP

* Battery life varies depending on the temperature and humidity of the usage environment.

3.3 How to Take Care of the StarBoard

Please clean your StarBoard periodically so it will continue to work for a long time.

(1) Cleaning and care

- Use a dry, soft cloth to clean the StarBoard display surface. Do not use detergents.
- Use a diluted detergent without abrasives to clean the StarBoard cabinet area. Do not use undiluted detergent; rather, mix with water and soak a soft cloth in the mixture. Wring out cloth thoroughly before wiping.
- Be careful not to scratch the StarBoard surface with fingernails or other hard objects. That or bumping the StarBoard can damage it.
- Never use gasoline, thinner, or other solvents. That can cause the cabinet to degenerate and printed areas to peel off.

3.4 Consumables

- (1) Pen tips for Stylus pen
- (2) AAA alkaline dry cell

Inquire at the place of purchase or with technical support for information on how to get replacements.

3.5 LCD Panel

- (1) The LCD panel is made using extremely high-precision technology. However, some dots may be constantly lit or dark.
- (2) The backlight used in the LCD panel has a limited lifespan. Contact technical support if the screen becomes dark, flickers, or will not light up.

3.6 Provisions of Product Warranty

1. During the free warranty service period, if a malfunction occurs during normal use, the malfunction will be corrected without charge, according to the provisions of the warranty. Furthermore, if the customer registration card accompanying the warranty is not returned to our company, the customer information will not be registered, so free repairs might be unavailable. After receiving this product, please immediately fill out and return this customer registration card.
2. The warranty coverage is as listed in the following table:

Product Name	Part Name	Warranty Coverage
StarBoard	17-inch LCD monitor	+
	Stylus pen	+
	RGB cable	+
	USB cable	+
	AC adapter	+
	Power cable	+
	Audio cable	+
	Stand	+
Replacement tip for Stylus pen		-
Other parts		-

Legend: + Covered by warranty (excluding wear and physical damage)
 - Not covered by warranty

3. Please refer to the warranty about this product's warranty service period.
4. Even during the warranty period, there will be a repair charge in the following cases:
 - (1) If the registration card accompanying the warranty is not returned to our company.
 - (2) If the warranty is not presented.
 - (3) If specified fields on the registration card accompanying the warranty are not completed, or if the wording has been changed without authorization.
 - (4) The warranty applies only to the original purchasers. (It does not apply to a third party to whom the customer resold this product.)
 - (5) In the event of a malfunction or damage resulting from the customer's improper handling (e.g., a fall, impact, etc., caused by the customer during transportation or movement).
 - (6) In the event of problems resulting from handling contrary to the handling and precautions mentioned in this user's guide.
 - (7) In the event of failure or damage resulting from abnormal voltages, pollution or other natural disasters (e.g., fire, earthquake, lightning).

- (8) In the event of a malfunction in this product caused by the connection to this product of equipment other than the equipment specified by our company.
 - (9) In the event that there is no abnormality in this product, but a defect in a part other than this product was detected or remedied.
 - (10) In the event of ordinary wear and tear, wear, deterioration, etc., of consumables, even during normal use.
5. If this product malfunctions, review the contents of this user's guide. If the problems remain irreparable, contact technical support. Technical support will determine whether or not the product must be repaired, so please contact them. If the customer sends the product to our company without RMA (Return Merchandise Authorization) number, it might not be covered by warranty.
 6. As a rule, the customer is responsible for shipping charges required to send all or part of the product for repair, etc. Our company will assume responsibility for the return shipping to the customer.
 7. This warranty does not cover labor fees for repair-associated equipment assembly or disassembly.
 8. Incidental damage caused by the failure of this product (e.g., loss of profit that should have resulted from the use of this product) is outside the scope of this warranty.
 9. The aforementioned provisions define this warranty, and they supersede those of all express or implied warranties that include legal defect liability.

