



# ROYAL EVO-







## *Instructions*

**MULTIPLEX<sup>®</sup>**

MULTIPLEX Modelltechnik GmbH • Neuer Weg 15 • D-75223 Niefern • Germany  
© MULTIPLEX 2002, Printed in Germany

<b>1. Contents</b>		
<b>1. Contents</b>	<b>57</b>	
<b>2. Introduction</b>	<b>59</b>	
<b>3. Safety notes</b>	<b>59</b>	
3.1. General safety notes	60	
3.2. Range checking	61	
<b>4. Liability / Compensation</b>	<b>62</b>	
<b>5. Guarantee</b>	<b>62</b>	
<b>6. Specification</b>	<b>62</b>	
<b>7. The transmitter</b>	<b>63</b>	
7.1. Front face of transmitter	63	
7.2. Rear face of transmitter	63	
7.3. Inside the transmitter	64	
7.4. Mechanical details	64	
7.4.1. Opening and closing the transmitter case	64	
7.4.2. Adjusting the transmitter aerial, fitting a new aerial	65	
7.4.3. Installing and removing the RF module	65	
7.4.4. Changing the transmitter crystal (HFM-4 module only)	66	
7.4.5. Changing the transmitter battery	66	
7.4.6. Disabling the stick neutralisation system, installing the spring for ratchet or friction operation	66	
7.4.7. Adjust the neutralising force	66	
7.4.8. Swivelling the stick units	67	
7.4.9. Adjusting and replacing the stick tops	67	
7.4.10. Stick top with buttons - how to fit them, how they work	67	
7.4.11. Installing the optional switches "P" and "K"	68	
<b>8. The transmitter battery</b>	<b>68</b>	
8.1. Battery management in the <i>ROYALeVo</i>	68	
8.1.1. This is what we have already	68	
8.1.2. This is <b>NEW</b>	69	
8.1.3. This is what you must attend	69	
8.2. The essentials in brief	69	
8.3. Safety notes	69	
8.4. Charging the transmitter battery	70	
8.5. Maintaining and storing the transmitter battery	70	
8.6. Recycling	70	
<b>9. Using the transmitter</b>	<b>71</b>	
9.1. Switching on for the first time	71	
9.2. The power-ON procedure	71	
9.2.1. Switching ON with the HFM-4 RF module for crystals	71	
9.2.2. Switching ON with the HFM-S synthesizer RF module	71	
9.2.3. Switching ON without transmitting an RF signal	71	
9.3. Security queries when switching ON	72	
9.3.1. Throttle check	72	
9.3.2. RF Check with the synthesizer module	72	
9.4. Selecting the channel with an HFM-S synthesizer RF module	72	
9.5. The RF status display (red LED)	72	
9.6. The status displays	73	
<b>10. The basic operating philosophy</b>	<b>74</b>	
10.1. The keypad	74	
10.1.1. Direct menu access buttons (row 1)	74	
10.1.2. Task buttons (row 2)	74	
10.1.3. Text input	74	
10.2. The 3-D digi-adjustors	75	
10.2.1. Programming using the 3-D digi-adjustors	75	
10.2.2. Making adjustments using the 3-D digi-adjustors	75	
10.3. Working with the keypad and 3-D digi-adjustor -the fundamental operating philosophy	75	
10.3.1. Calling up main menus	75	
10.3.2. Opening sub-menus	76	
10.3.3. Changing values	76	
10.3.4. Returning from whence you came	77	
<b>11. Digital trims</b>	<b>77</b>	
11.1. Introduction	77	
11.2. Advantages of digital trims	77	
11.3. The cruciform digital trim assembly	78	
11.4. On-screen trim display	78	
<b>12. Creating a new model</b>	<b>78</b>	
12.1. Basic information	78	
12.2.  <b>A new fixed-wing model</b>	78	
12.3.  <b>A new helicopter</b>	79	
12.4. Model templates in detail	83	
12.5. Template: BASIC	83	
12.5.1. Assigned transmitter controls and switches	83	
12.5.2. Assigned servos / receiver outputs	83	
12.5.3. Fine-tuning	83	
12.6. Template: ACRO	84	
12.6.1. Assigned transmitter controls and switches	84	
12.6.2. Assigned servos / receiver outputs	84	
12.6.3. Fine-tuning	84	
12.7. Template: HOTLINER	84	
12.7.1. Assigned transmitter controls and switches	84	
12.7.2. Assigned servos / receiver outputs	84	
12.7.3. Fine-tuning	84	
12.8. Template: DELTA	85	
12.8.1. Assigned transmitter controls and switches	85	
12.8.2. Assigned servos / receiver outputs	85	
12.8.3. Fine-tuning	85	
12.9. Template: GLIDER	85	
12.9.1. Assigned transmitter controls and switches	85	
12.9.2. Assigned servos / receiver outputs	85	
12.9.3. Fine-tuning	85	
12.10. Template: 4-Flaps	86	
12.10.1. Assigned transmitter controls and switches	86	
12.10.2. Assigned servos / receiver outputs	86	
12.10.3. Fine-tuning	86	
12.11. Template: HELImech	86	
12.11.1. Assigned transmitter controls and switches	86	
12.11.2. Assigned servos / receiver outputs	86	
12.11.3. Fine-tuning	86	
12.12. Template: HELIccpm	87	
12.12.1. Assigned transmitter controls and switches	87	
12.12.2. Assigned servos / receiver outputs	87	
12.12.3. Fine-tuning	87	
<b>13. Main menu „Setup“ </b>	<b>87</b>	
13.1. Sub-menu „Transmitter“	87	
13.1.1. Parameter „Trim graphics“	87	
13.1.2. Parameter „Sounds“	87	
13.1.3. Parameter „Battery alarm“	87	
13.1.4. Parameter „Battery charge“	88	
13.1.5. Parameter „Contrast“	88	
13.1.6. Parameter „ Check throttle “	88	
13.1.7. Parameter “Check RF”	88	

13.2.	Sub-menu "Define mixer"	88	<b>16.</b>	<b>Main menu „Servo“</b> 	<b>103</b>
13.2.1.	How the freely definable mixers work	88	16.1.	Sub-menu „Calibrate“	103
13.2.2.	Defining mixers	89	16.1.1.	Parameter „REV/TRM“	103
13.2.3.	The mixer options	89	16.1.2.	Parameter „P1 ... P5“	104
13.3.	Sub-menu "Assignment"	90	16.2.	Sub-Menu „Assignment“	104
13.3.1.	Parameter „Mode“	91	16.2.1.	Special: MULTInaut IV	105
13.3.2.	Parameter „Assignment“	91	16.2.2.	Assigning servos for fixed wing models	105
13.3.3.	Parameter „Assignment - Name“	91	16.2.3.	Assigning servos for helicopters	106
13.3.4.	Parameter „Assignment - Controls“	91	16.3.	Sub-menu „Monitor“	106
13.3.5.	Parameter „Assignment - Switches“	92	16.4.	Sub-menu „Test run“	106
13.4.	Sub-menu "Training"	92	<b>17.</b>	<b>Main menu „Timer“</b> 	<b>107</b>
13.4.1.	Teacher/pupil operation	92	17.1.	Sub-menu „Model“	107
13.4.2.	The ROYALevo as Teacher transmitter	92	17.2.	Sub-menu „Slot“	107
13.4.3.	The ROYALevo as pupils transmitter	93	17.3.	Timer „Σ Sum“	107
13.5.	Sub-menu "User"	93	17.4.	Sub-menu „Interval“	107
13.5.1.	Parameter „PIN“	93	<b>18.</b>	<b>Main menu „Memory“</b> 	<b>108</b>
13.5.2.	Parameter „Language“	93	18.1.	Sub-menu „Select model“ (change memory)	108
13.5.3.	Parameter „Name“	93	18.2.	Sub-menu „Copy“	108
<b>14.</b>	<b>Main menu „Controls“</b> 	<b>93</b>	18.3.	Sub-menu „Erase“	108
14.1.	Sub-menu „Control switch“	93	18.4.	Sub-menu „Flight phases“	108
14.2.	Sub-menus for individual controls	94	18.4.1.	Selecting flight phase names	108
14.2.1.	Control settings for the primary axes	94	18.4.2.	Block / release flight phase	109
14.2.2.	Parameter „Trim“	95	18.4.3.	Copying the active flight phase	109
14.2.3.	Parameter „Step“ (trim increment)	95	18.5.	Sub-menu „Properties“	109
14.2.4.	Parameter „D/R“ (Dual-Rates)	95	18.6.	Sub-menu „New model“	109
14.2.5.	Parameter „Trvl“	95	<b>19.</b>	<b>Accessories</b>	<b>110</b>
14.2.6.	Parameter „Expo“	95	19.1.	Scanner	
14.2.7.	Parameter „Fixed value“	95		(with HFM-S RF module)	110
14.2.8.	Parameter „Run time“ (Slow)	95	19.1.1.	Scan all frequencies/channels in the band	110
14.2.9.	Parameter „Idle“ (idle trim)	95	19.1.2.	Channel-Check at power-ON	110
14.2.10.	Parameter „Collective pitch“ (Coll. pitch curve)	95	19.1.3.	Installation of the scanner module	110
14.2.11.	Parameter „Throttle“ (Throttle curve)	96	19.2.	Channel-Check	
14.2.12.	Parameter „RPM“ speed regulators	96		(with the RF module HFM-4)	110
<b>15.</b>	<b>Main menu „Mixers“</b> 	<b>97</b>	19.2.1.	Installation of the Channel-Check module	110
15.1.	Sub-menu „Combi-Switch“	97	19.2.2.	Operating Channel-Check	110
15.2.	Sub-menu „A-Diff“ (aileron differential)	97	19.3.	Other accessories/spar parts	110
15.2.1.	Parameter „Mode“	97	19.3.1.	Overview	110
15.2.2.	Parameter „Diff.“	97	19.3.2.	Stick top button/switch	110
15.3.	Submenu „Gyro“	97	19.4.	Using MULTInaut IV	111
15.3.1.	Parameter „Mode“	98	19.5.	Diagnosis lead	111
15.3.2.	Parameter „Heading / Damping“ (Gyro gain)	99	19.6.	PC interface	111
15.3.3.	Parameter „Suppression“	99	19.6.1.	Accessing transmitter data	111
15.4.	Sub-menu „Tail rotor“ (static tail rotor compensation/Revo-Mix)	99	19.6.2.	Flight simulator operation	111
15.4.1.	Parameter „Collective Pitch+ and -“	100	<b>20.</b>	<b>Care and maintenance</b>	<b>112</b>
15.4.2.	Parameter „Yaw diff.“	100	<b>21.</b>	<b>Service and Support</b>	<b>112</b>
15.4.3.	Parameter „Offset“	100			
15.4.4.	Parameter „Zero point“ and Coll.Pitch display	100			
15.5.	Sub-menu „Rotor head“ (electronic swashplate mixer/CCPM)	100			
15.5.1.	Parameter „Geometry“	101			
15.5.2.	Parameter „Rotation“	101			
15.5.3.	Parameter „Lever +/-“	101			
15.5.4.	Helicopters HEIM mechanics	101			
15.6.	Sub-menu „Throttle compensation“	102			
15.6.1.	Parameter „Rudder“ (Yaw)	102			
15.6.2.	Parameter „Aileron“ (Roll)	102			
15.6.3.	Parameter „Elevator“ (Pitch axis)	102			
15.7.	Setting up "free mixers"	102			

## 2. Introduction

We are delighted that you have decided to purchase the MULTIPLEX **ROYAL**evo radio control system. The **ROYAL**evo was introduced early in 2002, and constitutes a modern digital radio control system, which represents a further milestone in the development of radio control systems by MULTIPLEX. In the overall design, development and production of this system we have invested all our experience of several generations of radio control equipment. The result is a universal, ergonomically efficient radio control system of modern design which is simple to operate, and which is suitable for use both hand-held and in a transmitter tray. And - not least - the **ROYAL**evo is **MADE IN GERMANY**.

We placed particular emphasis on convenience of operation during the development of the system software. The **ROYAL**evo offers you a wide range of functions selected by experienced users, and these cope effortlessly with any model from simple two-axis gliders to complex large-scale models and helicopters. Despite its comprehensive features, the transmitter is simple to operate and easy to understand.

The essential features of the **ROYAL**evo are as follows:

- Ergonomically efficient case, suitable for hand-held or tray use, with precision stick units which swivel to suit your personal preference
- Graphical folding screen (132 x 64 pixels) with variable contrast
- Easily accessible digital trims in a cruciform arrangement, giving an entirely new feeling to the trims
- Low-cost standard RF module\* with plug-in crystals, or synthesizer RF module\* with software channel selection
- 9 or 12 channels
- 20 or 36 model memories
- 6 menu buttons for fast, direct access to the main menus
- 5 function buttons and two 3-D digi-adjustors for user-friendly programming
- Detailed menu texts, selectable language, various languages available
- Comprehensive set-up and mixer facilities for fixed-wing models and helicopters
- Sample models (templates) minimise programming effort required
- Unrestricted assignment of transmitter controls, switches and servos
- 4 flight phases per model memory
- 5 timers (3 alarm timers + transmitter and model times)
- Facilities for selective Teacher/Pupil (Trainer) operations as standard

We are confident that you will quickly learn to appreciate the **ROYAL**evo, and enjoy using it to control your models over a period of many years. Please take a little while to familiarise yourself with the system, referring constantly to these instructions which are intended to help you.

Yours – the **MULTIPLEX** team

Options:

\* MULTIPLEX Channel-Check power-on guard system

\*\* Scanner with power-on guard function

See the main MULTIPLEX catalogue for frequency ranges available.

## 3. Safety notes

- ⚠ **These operating instructions are an integral part of the product, and contain important information and safety notes. They should therefore be stored in a safe place where you can refer to them at any time. If you ever dispose of the equipment be sure to pass on the instructions to the new owner.**
- ⚠ **Read these safety notes!**  
**Read the instructions carefully! Please do not attempt to use the equipment until you have read these operating instructions thoroughly, together with the following safety notes (included in these instructions or supplied separately).**
- ⚠ **It is not permissible under any circumstances to make technical modifications to the radio control system itself or its components. Use genuine MULTIPLEX accessories and replacement parts exclusively (especially transmitter battery, crystals, aerial, ...).**
- ⚠ **If you wish to use the system in conjunction with products made by other manufacturers, it is up to you to carry out checks to ensure their quality and compatibility. Every time you make any change to the system, carry out a careful check of the functions, and check the effective range. Don't operate the system or the model if you are not sure everything is working correctly; first locate the fault and eliminate it.**
- ⚠ **Warning!**  
**Radio-controlled models are not playthings in the usual sense. Building these models, installing the RC system, and operating them all demand technical knowledge, due caution and a responsible, safety-conscious approach. If you are negligent or make mistakes, the result may be serious damage and injury. As manufacturers, we have no control over your methods of building and operating any model, so all we can do is point out these hazards expressly. We deny all liability.**
- ⚠ **A model, which is out of control, for whatever reason, is capable of causing serious personal injury and damage to property. It is essential that you should take out suitable third-party insurance, so that you are covered if, in spite of all your care, an accident should occur.**
- ⚠ **Always keep to the following sequence when switching the equipment on and off, as this avoids the danger of an electric power system bursting into life unexpectedly:**
  1. **When switching on:**  
**Transmitter ON first,**  
**then receiver ON.**  
**Connect flight battery and switch power system ON**
  2. **When switching off:**  
**First disconnect flight battery and switch power system OFF**  
**Receiver OFF**  
**Transmitter OFF**

- **We recommend that you have your radio control system transmitters and receivers checked at regular intervals (every 2 to 3 years) by an authorised MULTIPLEX Service Centre.**
- **If any electrical device gets damp or wet, cease operations immediately and disconnect the power supply from it. Open the case if possible and allow the unit to dry out thoroughly - preferably for several days. After this carry out a very careful check of all the functions. If you are not certain that all is well, send the unit to an authorised MULTIPLEX Service Centre for checking**
- **The operation of this radio control system is approved for use on particular channels / transmitter frequencies which vary from country to country. In some cases there are formalities such as registration to be completed before you may use the system. Please read the notes which are supplied with this set on a separate sheet.**

### 3.1. General safety notes

#### When building the model:

- All control surfaces and linkages must be installed and set up in such a way that the control surfaces move with complete freedom, and do not tend to bind or move stiffly at the extremes of travel. Do not limit the servo travel from the transmitter; it is always better to adjust the servo output arms, horns and pushrods instead. Always aim at minimum possible lost motion (slop) in any linkage. All these points help to minimise the load on the servos, ensuring that their maximum performance is available to you, and that they will last as long as possible. This also means maximum reliability and safety for you and your models.
- Receiver, battery, servos and other RC components and electronic units should be effectively protected from vibration to avoid the danger of failure of any electronic component. All the individual items are supplied with operating instructions, and these should be read thoroughly. Standard methods of avoiding vibration include balancing propellers and rotor blades before use, replacing damaged blades, installing glowplug and petrol engines with effective vibration damping, replacing or repairing damaged motors and engines if they do not run smoothly, and so on.
- Don't place cables under tension, and don't bend them tightly; protect all leads from rotating parts.
- Keep servo leads as short as possible, and don't use them unless absolutely necessary. If you must use extension leads which are 30 - 50 cm or more in length, fit a separation filter (ferrite ring) in each lead, and ensure that the conductors are of adequate cross-section to avoid voltage drop. We recommend at least 0.3 mm<sup>2</sup>.

- Don't coil up the receiver aerial, and do not shorten it. Never deploy the aerial parallel to conductive components such as metal pushrods, or inside a fuselage which has a shielding effect, i.e. made of or reinforced with carbon fibre, or finished in metallic paint. Don't deploy the aerial on top of electrically conducting model components. For large-scale models we recommend the use of a whip aerial.
- Ensure that the receiver power supply is of adequate capacity. If you are using servos rated at up to about 40 Ncm you can calculate the required battery capacity using the following rule of thumb:  
 $Capacity[mAh] \geq No.of\ servos \times 200\ mAh$   
 If you have no problems with weight or space, it is always better to select the next larger size of battery.
- Avoid any situation in which parts made of conductive material (e.g. metal linkage components or pushrods) are in contact with each other, and move against each other. This causes what is known as electrical "noise", which can interfere with the receiving system.
- Avoid interference pulses due to static charges or powerful electric or electro-magnetic fields by taking appropriate suppression measures. These include suppressing electric motors with suitable capacitors, using shielded plug caps, ignition leads and ignition units with spark-ignition petrol engines; keeping the RC system components, including aerial, wiring and batteries, well away from the ignition circuit.
- Keep the receiving system a safe distance from high-current leads (e.g. electric power system wiring). High-current cables, especially those between brushless electric motors and their controllers, should be as short as possible (guide: max. 10 - 15 cm).
- When you have completed a new model, carry out the programming of your transmitter in the peace and quiet of your home. Check all the functions carefully before flying the model. Take the time to familiarise yourself with the programming procedure and method of operating the transmitter before you use it for the first time to control a model.

#### Check the model regularly

- Ensure that all control surfaces and mechanical linkages work smoothly, freely, and without slop.
- Check that pushrods, linkages, hinges etc. are stiff enough for their purpose and in good condition.
- Carry out a visual check for fractures, cracks, signs of stress in the model itself and on the components of the RC system and power system.
- Check that all cables and connectors are in good condition and are making sound contact.
- Check the state of the power system and its wiring, including the switch harness, and check the external condition of the cells. Regular care of the battery is important: monitor its voltage and capacity using a charger and charging process designed for the battery type you are using.

### 3.2. Range checking

Range checking gives reliable information about the working condition of your radio control system.

Based on our experience and measurements we have designed a test formula which will always keep you on the safe side.

1. Set the transmitter aerial in an upright, slightly angled position and then collapse all the sections together.
2. Set up the model so that the tip of the receiver aerial is about 1 m above the ground.
3. Ensure that there are no large metallic objects (e.g. cars, wire fences etc.) in the vicinity of the model.
4. Carry out the test only if there are no other transmitters switched on - even if they are on different channels.
5. Switch on the transmitter and receiving system. At a range of about 80 m between transmitter and model check that the control surfaces still respond immediately and definitely to stick deflections, without carrying out any unwanted movements. When close to the range limit the servo output arms will start to jitter; they should not move by more than the width of the output arm.
6. Secure the model and repeat the test with the power system running (alternating the throttle setting between idle and full-throttle).



The stated range of 80 m is only an approximate guideline, as the actual range will vary very greatly according to ambient conditions. For example, effective range may only be half the stated value at a mountain bowl site, or close to a public radio transmitter, radar station or similar.

#### What can you do to establish the cause of insufficient range?

1. Change the position of the receiver aerial. If it is close to metal parts or model components reinforced with carbon fibre, the receiver may suffer adverse effects.  
The influence of electric power systems and ignition systems also varies if you alter the position of the aerial.
2. Disconnect the servos from the receiver one by one, and repeat the check. Connecting leads of excessive length without suppressor filters have an adverse effect on reception conditions. Remember that servos deteriorate with age, and then generate more interference than when new (brush sparking, suppressor capacitors adrift from motor terminals etc.).

If you are unable to effect an improvement, try removing the complete system from the model and checking the equipment on its own. This enables you to determine whether the fault is in the system, or in the installation conditions in the model.

#### Pre-flight checks:

- Charge the transmitter, receiver and flight batteries carefully, and check their state of charge before and during the session. This means using the correct type of charger, and a charge process which is suitable for the battery type in use. It also involves regular care and maintenance of the packs (balancing by a slow charge), and testing the voltage curve and capacity.
- At the flying site the first step should always be to check with the other modellers present whether your own channel (transmitter frequency) is vacant. If there is a site manager or flight director present, register with him and check that you understand the method of frequency control in use. Do not switch ON until you have done this, otherwise there is a danger of channel clashes and wrecked models.
- Check the range with the transmitter aerial collapsed.
- Ensure that you have selected the right model memory.
- Check that all primary and secondary control systems are working perfectly, and that the control surfaces are deflecting in the right "sense" (direction).

**⚠ If you detect any irregularity or problem, abort the flight. Seek out the cause of the error, eliminate it, then check everything again.**

#### When operating your model:

- If you have little or no experience flying radio-controlled models, it makes sense to ask an experienced model pilot to help you initially. The use of a Teacher/Pupil (Trainer) system is strongly recommended, especially for the initial phase of learning to fly.
- Operate the model only at suitable approved sites.
- Never fly or run your model directly towards or over spectators.
- Don't carry out risky manoeuvres when flying or operating your model.
- Have a clear idea of your abilities and skill; don't over-estimate what you can do!
- If you detect any sign of problems or interference, land the model immediately and carry out a thorough check.
- **Caution: static charges!**  
When the air is extremely dry (in mountainous terrain, in mountain bowls, close to weather fronts) static charges tend to build up in the transmitter and/or the pilot. The charge eventually dissipates through a static spark, which can endanger the pilot or cause interference to the transmitter.  
**Counter-measures:**  
When you feel "static", cease operations as soon as you possibly can, and walk a little way down the mountain to reach a less exposed position.

**4. Liability / Compensation**

As manufacturers, we at MULTIPLEX Modelltechnik GmbH are not able to ensure that you observe these instructions when assembling and installing this equipment. Neither are we in a position to influence the way you install, operate and maintain the radio control system components. For this reason MULTIPLEX Modelltechnik GmbH is obliged to deny all liability for loss, damage or costs which are incurred due to the incorrect use and operation of our products, or which are connected with such operation in any way.

Unless otherwise prescribed by law, the obligation of MULTIPLEX Modelltechnik GmbH to pay compensation, regardless of the legal argument employed, is limited to the invoice value of that quantity of MULTIPLEX products which was immediately and directly involved in the event which caused the damage. This does not apply if MULTIPLEX Modelltechnik GmbH is found to be subject to unlimited liability according to binding legal regulation on account of deliberate or gross negligence.

**5. Guarantee**

Our products are guaranteed in accordance with current statutory requirements.

If you wish to make a claim under guarantee please contact the model shop who supplied the equipment to you.

The guarantee does not cover malfunctions which are due to the following:

- incompetent or incorrect usage,
- maintenance work carried out incorrectly, not carried out at the correct time, not carried out at all, or carried out by any non-authorized person or organisation,
- incorrect connections,
- use with accessories not of genuine MULTIPLEX manufacture,
- modifications or repairs which were not carried out by MULTIPLEX or a MULTIPLEX Service Centre,
- use with components made by other manufacturers,
- accidental or deliberate damage,
- operating the equipment outside the limits stated in the Specification.

**6. Specification**

No. of channels:	
<b>ROYAL</b> evo 9	9
<b>ROYAL</b> evo 12	12
Transmission system:	automatic adoption to servo count
Servo 8 - 12 unused	FM-PPM 7
Servo 9 - 12 unused	FM-PPM 8
Servo 10 - 12 unused	FM-PPM 9
<b>ROYAL</b> evo 12 only! at least one of the servos 10 - 12 is used	FM-PPM 12
Channel spacing:	10 kHz
Servo signal format:	UNI 1,5 ± 0,5 ms MPX 1,6 ± 0,55 ms variable for each channel
Model memories:	
<b>ROYAL</b> evo 9	20
<b>ROYAL</b> evo 12	36
Power supply:	7,2 V, 6 cells, AA size NiMH-battery
Current drain:	~ 20 mA excl. RF module ~ 165 mA with HFM-4 ~ 190 mA with HFM-5
Permissible operating temperature range:	- 15 °C to + 55 °C
Dimensions:	
Length	approx. 220 mm approx. 250 mm with aerial collapsed
Width	approx. 200 mm
Height	approx. 60 mm excl. sticks and carry handle
Weight:	approx. 750 g excl. battery approx. 900 g incl. Battery

## 7. The transmitter

### 7.1. Front face of transmitter

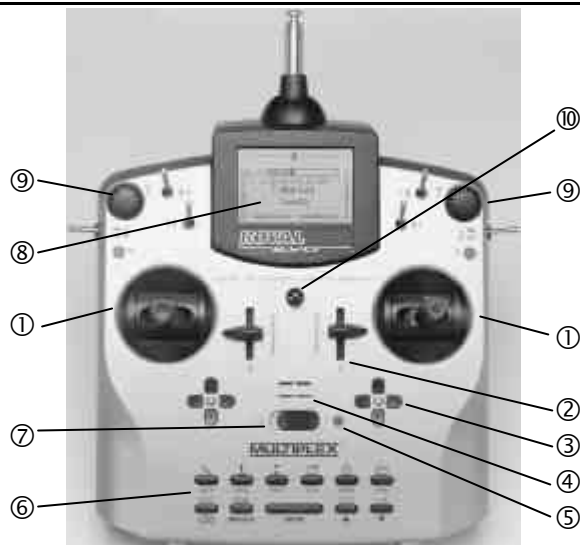

① Two precision **stick units** for controlling the 4 primary control axes. Stick ratchet for throttle/spoilers, can be activated on right or left stick unit (→ 7.4.6.). Both units can be swivelled to suit the pilot's personal preference (→ 7.4.7.). The stick tops can be rotated and are infinitely variable in length. Various optional versions are available.

② Two **sliders "E" and "F"** are fitted as standard, and can be assigned to any channel. They also operate as switched functions with centre detent.

③ Two **cruciform trim assemblies** located below the stick units provide digital trimming facilities on the primary control axes. Each set consists of a pair of buttons for left/right and up/down.

④ **Audible sounder** (piezo beeper)

⑤ When the transmitter is switched on, the **RF status display LED** (red LED) indicates whether an RF (Radio Frequency) signal is being transmitted:

LED glowing constantly → no RF transmission

LED flashing (2 sec.) → RF transmission

The LED is controlled by the current drain of the RF module. For example, if the transmitter crystal is not present, or is defective, no RF signal can be generated, and the constantly glowing LED alerts you to the fact that an RF signal is not being transmitted.

⑥ **Keypad** consisting of 11 buttons in 2 rows. The 6 buttons in the first row provide fast, direct access to the 6 main menus (direct menu access buttons). The 5 buttons in the second row are used for programming procedures. With the exception of the "ENTER" button, all the buttons have a double function for entering text. The method of entering text is similar to that used with mobile telephones.

⑦ **ON/OFF-switch** („O" / „I")

⑧ The **screen** is a modern, UV-stable, graphical LCD screen (132 x 64 dots) with an anti-reflective coating. The contrast is variable (→ 13.1.5.). The screen can be moved through about 40° in order to optimise the viewing angle.

All **switches and buttons** (apart from installation wells "K" and "P" → 7.4.11.) are arranged as standard in easily accessible positions. They cannot be re-positioned or swapped over. The designations of the switches and buttons are neutral ("G", "H", "I", ... "O", "P"). They can be defined in any way to provide channel functions and/or switched functions (transmitter controls or switches → 13.3.4. and 13.3.5.), i.e. the designations serve only to identify them.

⑨ The transmitter **features two 3-D digi-adjustors** which are used for programming and adjusting the system. They are a permanent feature and are fitted as standard. During the programming process both digi-adjustors can be pressed and/or rotated, and work in parallel with the "ENTER" or „▲"(UP) / „▼"(DOWN) buttons. For operating a model it is possible to assign many different parameters to the 3-D digi-adjustors, which can then be used to adjust those settings conveniently e.g. while the model is flying (→ 10.2.2.).

⑩ **Mounting lug** for attaching a neckstrap (e.g. # 8 5161 or # 8 5646)

### 7.2. Rear face of transmitter

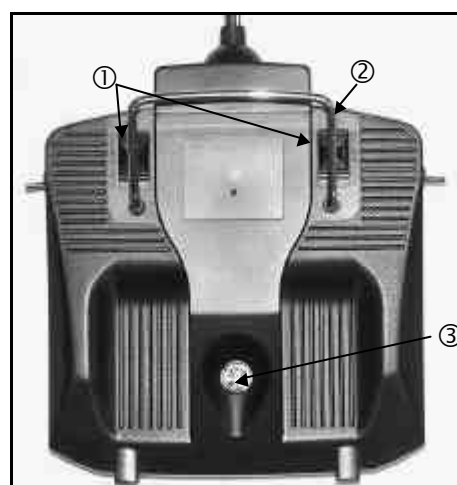

Two **sliding latches** ① (OPEN) provide a fast, easy method of opening and closing the transmitter, e.g. for changing the crystal or RF module (→ 7.4.3.).

The stout **carry handle** ② enables you to carry the transmitter safely, and also protects the back of the case when you put the transmitter down.

As usual with MPX, the **ROYALevo** features a **MULTIPLEX multi-function socket** ③ (marked "CHARGE" on the case) as standard. Its purposes are as follows:

- Charging the transmitter battery (→ 8.4.)
- Connecting the transmitter to another for Teacher/Pupil operations (→ 13.4.)
- PC interface for backing up model data (→ 19.6.)
- PC interface for updating the transmitter (→ 19.6.)
- PC interface for flight simulators (→ 19.6.2.)
- Interface for diagnosis lead, i.e. controlling a receiver for programming and adjustment without transmitting an RF signal (→ 19.3.2.)



**7.3. Inside the transmitter**

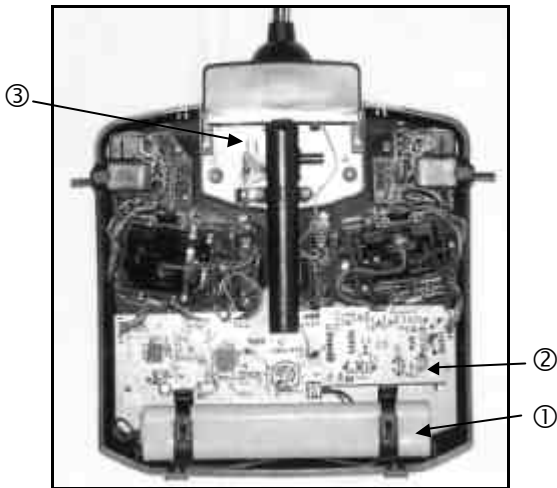

The rechargeable **transmitter battery** ① is installed as standard. It consists of 6 environmentally friendly high-capacity AA-size NiMH cells (Nickel-Metal-Hydride). For safety reasons the individual cells are spot-welded to ensure constant contact, and the pack is protected by a heat-shrink sleeve.

⚠ **The transmitter battery is fitted with a special thermo-fuse which protects the battery and - above all - the transmitter from short-circuit, reverse polarity and excessive currents. The transmitter itself does not feature a separate fuse, and for this reason the battery may only be replaced by a genuine MPX transmitter battery pack designed exclusively for this transmitter. It is also very important to observe the instructions for charging the transmitter battery (→ 8.).**

**RF module** ② (Radio Frequency module). The RF module is simply plugged into the main circuit board, and can easily be changed if you wish to switch to a different frequency band (→ 7.4.3.). Two different RF modules can be used in the **ROYAL**evo:

**HFM-4:**

A simple, low-cost RF module with plug-in crystals for selecting the channel (transmission frequency). Use only genuine MULTIPLEX transmitter crystals! The optional "Channel-Check" power-on guard module can be fitted at any time.

**HFM-5:**

A modern synthesizer RF module which allows you to select the channel (i.e. transmission frequency) by software. An optional scanner with power-on guard can be fitted at any time.

The **TORX**® **screwdriver** ③ (size T6), which you will find in a clip below the aerial well, close to the screen, is used for tasks such as swivelling the stick units, and for installing the auxiliary switches in wells "K" and "P".

On the inside of the transmitter back panel there are **crystal holders** for 3 spare crystals.

⚠ **Don't lever the crystals out! Slide them out!**



Slide!

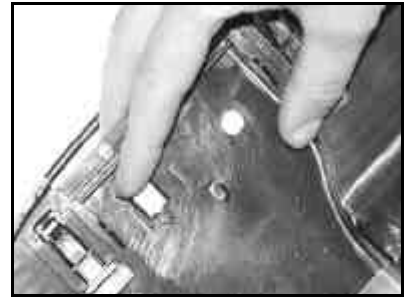

**7.4. Mechanical details**

**7.4.1. Opening and closing the transmitter case**

⚠ **Be sure to switch the transmitter OFF before opening it (short-circuit hazard)!**

**Opening the transmitter case:**

1. Hold the transmitter in both hands and push the sliding latches on the back panel downwards with your thumbs (towards "OPEN") (Fig. 1).

Carefully lift off the back panel of the case (Fig. 2).

Fig. 1

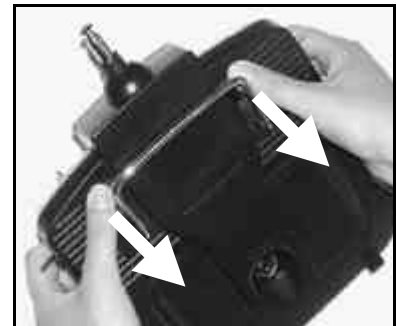

Fig. 2



**Closing the case:**

1. Carefully position the back panel on the rear edge of the case, holding it at an angle as shown, and check that both retainer lugs are correctly engaged (arrow) (Fig. 3).
2. **Carefully close the case back** (Fig. 4).
  - ⚠ Check that no cables are snagged, and that the transmitter aerial has not slipped out of its guide sleeve. It should be possible to fit the case back easily and without forcing.
3. Push the sliding latches up as far as they will go, in the opposite direction to "OPEN".

Fig. 3

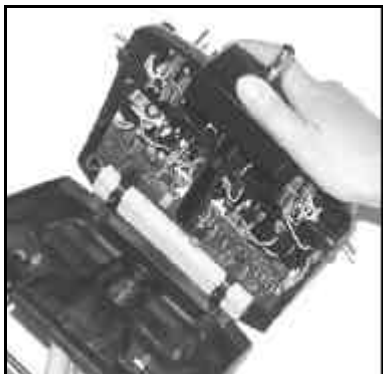

Fig. 4



**7.4.2. Adjusting the transmitter aerial, fitting a new aerial**

The transmitter aerial is a permanent fitting in the case. For transport it can be collapsed completely and recessed into the case. For adjustments and programming the aerial can be left in this position without damaging the RF section.

**⚠ When operating a model always extend the aerial to its full length. Only in this configuration can you be sure of safe operation with maximum radiated power and range.**

The aerial can also be moved to a second position (angled up and to the left), and locked in that position:

1. Pull out the aerial until you feel a distinct resistance (Fig. 1).
2. Pull the aerial another 3 to 5 mm to overcome the resistance, pulling fairly hard, and swivel the aerial up and to the left (Fig. 2). You will again feel resistance at this point, but this time do not push past it.
3. Tilt the aerial as far as it will go, and it will latch in the correct position..

To swivel it back, the aerial must first be unlocked again as described under point 2.

**⚠ Check regularly that the aerial is still making good contact. Contact problems with telescopic aerials cause adverse effects on radiated power, and thereby reduce effective range. In such situations reliable operation can no longer be guaranteed. Intermittent contact or bent aerials should be replaced at the earliest opportunity, as should an aerial that has become loose and sloppy through hard use.**

If the aerial should be damaged, it can be replaced easily as follows: Remove the case back, and simply push it back and out of the aerial guide sleeve (replacement **ROYAL**Levo aerial: # 89 3002).

Fig. 1



Fig. 2



**7.4.3. Installing and removing the RF module**

The two RF modules (HFM-4 and HFM-S) for the ROYA-Levo are not fitted in protective cases. To avoid damaging them:

- Don't touch the circuit board and its components.
- Don't exert any force on the circuit board.
- Protect RF modules from mechanical strain.

**⚠ Don't touch components on the circuit board. Don't change the settings of adjustable components.**

If settings have been changed mistakenly or components are damaged, have the module checked and realigned by the MULTIPLEX service.

**Removing the RF module:**

1. Switch off the transmitter!
2. Open the transmitter (→ 7.4.1.)
3. Lay the front face of the transmitter on a soft surface, taking care to avoid damage to the sticks and switches!
4. Grasp the RF module by all four corners using both thumbs and index fingers, and carefully pull it up and out (see picture below).

**Replacing the RF module:**

Grasp the RF module as before. Ensure that the module is fitted onto the contact pins correctly, i.e. that it is not offset in any direction.



**⚠ When changing the RF module avoid touching the electrical components at all costs. If the mod-**

ule is to be stored outside the transmitter, it is essential to protect it from dirt and damp, and also from shock and vibration.

**7.4.4. Changing the transmitter crystal (HFM-4 module only)**

Changing Frequency

Changing the crystal to avoid conflicts with others is possible where permitted. Check your local rules before doing so. In the US, the FCC prohibits the changing of transmitter crystals except by a Manufacturer Authorized service center.

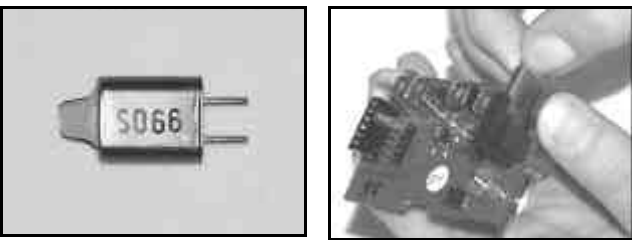

**⚠ Crystals are extremely delicate components, vulnerable to shock and vibration. They are one of the crucial parts of your RC system, without which reliable operation is not possible. For this reason never drop them, subject them to mechanical load (by pushing them forcibly into the crystal socket), and always store them carefully.**

**7.4.5. Changing the transmitter battery**

1. Switch the transmitter OFF!
2. Pull the snap-latches of the two plastic battery holders back towards the battery, and fold them up (Fig. 1).
3. Remove the battery and disconnect the battery connector from the main circuit board (Fig. 2).

Fig 1



Fig. 2

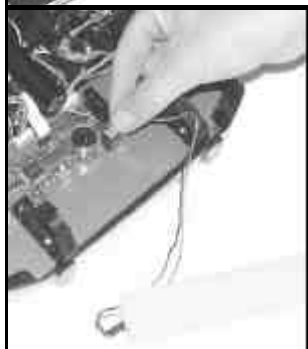

When installing the battery ensure that the battery lead is correctly positioned, and cannot become jammed or snagged when you close the case.

**Note:**

Model data is not lost when you change the battery.

**7.4.6. Disabling the stick neutralisation system, installing the spring for ratchet or friction operation**

The **ROYAL**evo transmitter is supplied as standard with two self-neutralising stick units. The stick neutralising system can be disabled, and a stick ratchet spring or friction mechanism can be activated quickly and easily as follows:

Switch off the transmitter!

1. Locate the TORX screwdriver (in a clip below the aerial guide sleeve, close to the screen) and use it to rotate the TORX screw (1) of the stick neutralising arm clockwise until the neutralisation is completely disabled. **Don't unscrew it too far! The neutralising arm must not be removed!**
2. If the stick shall work with friction the spring must be displaced. Tighten screw (2) fully and adjust the strength of friction/ratchet with screw (3). The further the screw is tightened, the greater the holding force of the spring.

It is also possible to fit both springs if you wish. This produces a hybrid ratchet / friction movement of the stick which some pilots find they prefer.

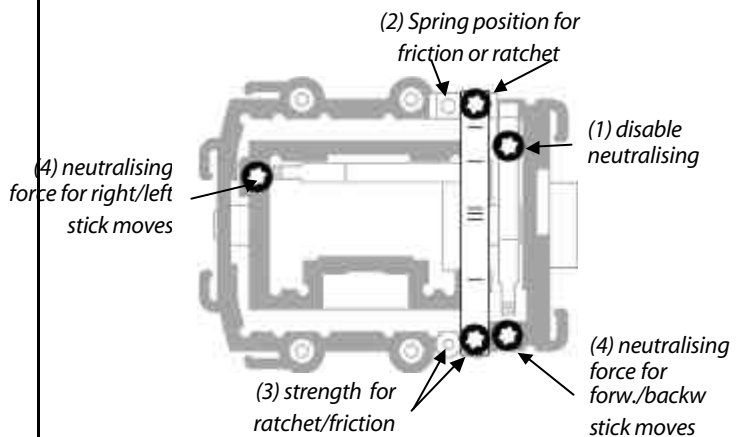

**7.4.7. Adjust the neutralising force**

The neutralising force is adjustable for each of the four stick axis separately. The illustration above shows, where the screws are located. Turning clockwise the screws (4) increases the neutralising force.

**7.4.8. Swivelling the stick units**

The stick units of the **ROYAL**Levo can be swivelled in their mountings in order to align them perfectly with your natural hand movements. This is a unique feature, and can offer a real advantage when the transmitter is used hand-held, with the thumbs operating the sticks, resting on short stick-tops. In this hand position the "natural" working action of the thumbs is at a slight angle to the transmitter case, i.e. it does not coincide exactly with the horizontal and vertical axes of the transmitter. Both stick units of the **ROYAL**Levo are infinitely variable through an angle of about 15°.

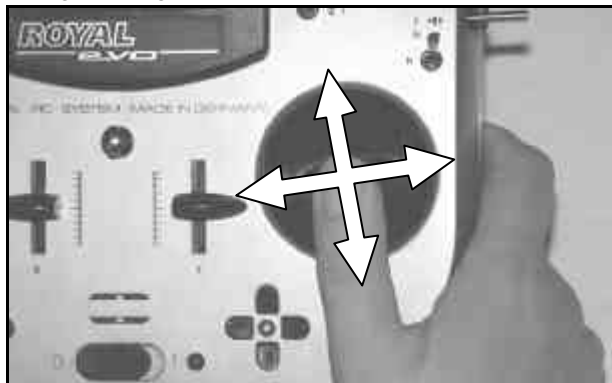

1. Loosen the 3 TORX screws of the stick unit you wish to swivel, using the TORX screwdriver (in a clip below the aerial guide sleeve, close to the screen) until the unit can be rotated (Fig. 1).
2. Swivel the stick unit to your choice of angle, then tighten the screws again. Take care not to over-tighten them, or you may strip the threads (Fig. 2).

Fig. 1

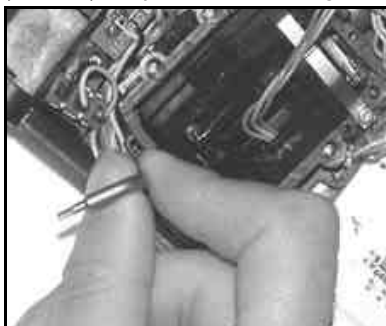
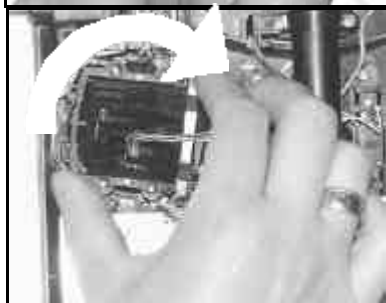

Fig. 2



**7.4.9. Adjusting and replacing the stick tops**

As standard the **ROYAL**Levo is supplied with three pairs of stick tops of different lengths. They are easy to change, adjust in height, or rotate:

1. Place the transmitter on a flat surface.
2. Hold the stick top firmly in one hand (Fig. 1).
3. With the other hand undo the locking nut by rotating it clockwise (Fig. 1).

The stick shaft is smooth, and the stick top can now be rotated or adjusted in length (position on the shaft). If you are changing the stick tops, unscrew the locking

nuts from the old ones, and use them to secure the new stick tops (Fig. 2).

Before installing the stick tops ensure that the stick shaft is clean and free of grease and oil. If you don't do this you may find that the stick top does not stay in position reliably.

Fig. 1



Fig. 2



**7.4.10. Stick top with buttons - how to fit them, how they work**

If you use the transmitter with the long stick top with buttons (# 7 5303) is very helpful, as it can be used for many important switched functions. This helps to ensure that auxiliary functions can be operated simply, quickly and safely, without having to let go of the associated stick.

Fig. 1



Fig. 2



The top button has a non-latching or momentary function (e.g. pressed = ON, released = OFF), whereas the two lateral buttons form one complete switch together (e.g. button 1 = ON, button 2 = OFF). Fitting the stick tops is a quick, simple procedure, and requires no soldering:

1. Switch off the transmitter and remove the stick top.
2. Thread the two wires attached to the new stick top through the stick shaft (Fig. 1) and fit the stick top again, as already described in Section 7.4.9.

**Tip:**

Threading the wires is easier if you slightly bend the wire-ends and hold the stick in one of the corners.

3. Clip the wires in the holders designed for them on the stick unit. Check that the wires have sufficient freedom when the stick is deflected; they must not be under tension at any point, and should not snag anywhere.
4. Connect the bare wire ends to the appropriate green screw-terminals on the main circuit board; you will need a small slot-head screwdriver for this. Remove the battery and push the wires in from the battery-facing side of the terminals. It does not matter which way round the wires are connected.

Fig. 1

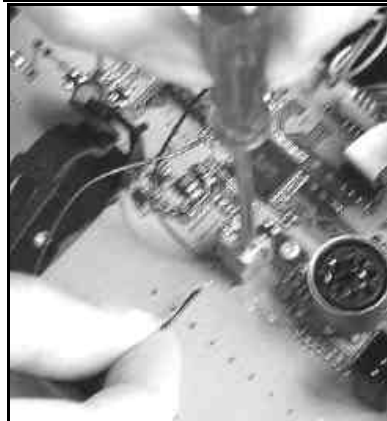

Fig. 2

**7.4.11. Installing the optional switches "P" and "K"**

If you need extra functions 2-position switches can be installed in the installation wells "P" and "K". To fit them the corresponding corner unit must be removed from the transmitter:

1. Locate the TORX screwdriver (in a clip below the aerial guide sleeve, close to the screen) and undo the four TORX screws holding the appropriate stick unit (Fig. 1).
2. Check that the switches are at the centre position, then carefully withdraw the corner unit from the transmitter. Remove the rotary knob (push-fit) from the 3-D digi-adjustor when you withdraw the unit (Fig. 2).
3. Use a small screwdriver to push out the blind cover from the inside.
4. Fit the switch and secure it with the retaining nut supplied (Fig. 3). Note the correct orientation: the yellow wire should face the battery.
5. Re-install the corner unit, fit the retaining screws and push the rotary knob back onto the 3-D digi-adjustor (note correct position: internal index shoulder). Connect the plug attached to the new switch directly to the micro-connector on the corner unit (Fig. 4).

Fig. 1

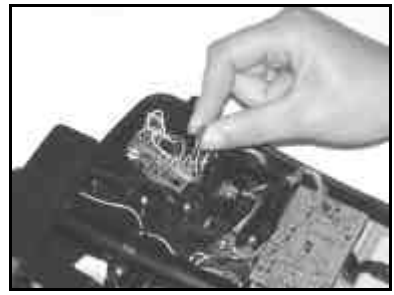

Fig. 2

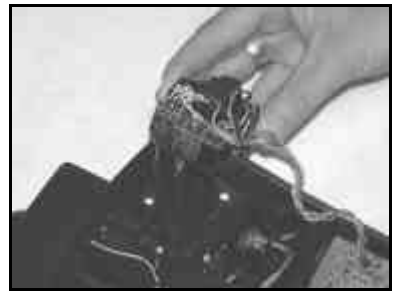
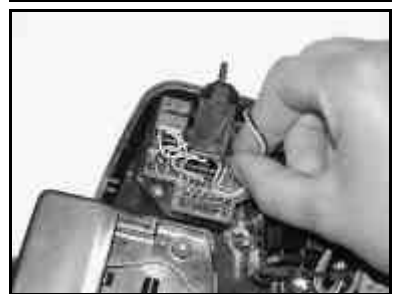

Fig. 3



Fig. 4

**8. The transmitter battery**

The **ROYAL**evo is powered by a high-quality ready-made battery pack consisting of 6 NiMH cells (Nickel-Metal-Hydride) of the AA size. NiMH cells offer a much higher energy density (capacity : weight) than NiCd (Nickel-Cadmium) cells, and therefore provide longer operating times for the same weight. They do require slightly different handling and greater care, especially when charging.

**8.1. Battery management in the *ROYAL*evo****8.1.1. This is what we have already****Battery voltage display**

Most transmitters show the battery voltage in graphic or numeric form.

**Battery alarm**

An audible alarm indicates the voltage falling below the minimum level. In many transmitters the minimum level can be set by the user.

Both features are available in the **ROYAL**evo of course. (Battery alarm → 13.1.3.)

**8.1.2. This is NEW**

The battery management in the **ROYALevo** monitors the charge status of the transmitter battery during all operating conditions, even when the transmitter is switched off.

In detail the following happens:

**a. during charging**

If the transmitter battery is charged with more than 50 mA via the charging socket, the charging current is measured regularly and the charge is calculated. The result is stored in the transmitters memory..

**b. during operation**

Also during operation the current is measured and the drawn charge is calculated and subtracted from the available charge. In the status display 4 (→ 9.6.) the remaining **battery charge** is shown. Further the **residual operating time** is calculated and displayed. This figure is shown to give a rough idea of how long the transmitter can be operated with the power consumption currently measured.

**c. when the transmitter is switched off**

Also if your transmitter „sleeps“ on the shelf, the battery loses charge by the effect of self-discharge (approx. 1.5% per day). The battery management automatically reduces the available charge accordingly.



**!** Battery charge and residual values are only intended as a guide. Tolerances and variations between individual examples, and the effects of battery maintenance schedules, can produce considerable discrepancies.

**8.1.3. This is what you must attend**

To get battery management display as reliable as possible, please take care of the following:

**a. Correction of the indicated battery charge**

The battery management assumes a nominal capacity of 1500 mAh. After the battery has reached its full capacity (more than 5 charge/discharge cycles) the true capacity can be set in the menu:

↖, Transmitter parameter: Batt. charge

In steps of 50 mAh you can set the capacity measured by your charger.

**!** **If battery voltage of 6.5 V or below is detected, the available charge is set to 0 mAh.**

**b. Use a suitable charger (→ 8.4.) and charge via the socket**

Only if the battery is charged via the socket the battery management can work correctly.

**c. charging with constant current (1/10 C)**

If the battery will be charged longer than calculated with the formula in chapter 8.4. the battery management will limit the available charge at 1500 mAh.

**8.2. The essentials in brief**

- 6 cells, 1500 mAh, NiMH (Nickel-Metal-Hydride)
- Integral thermo-fuse (automatic reset)
- Standard charge (0,1 C = 150 mA) 12 hours
- Fast charge (1 C = 1,5 A) = maximum charge current with automatic cut-off
- Avoid deep-discharging (< 1V/Zelle)
- during longer storage (more than 4 weeks) avoid temperatures above 30°C

**8.3. Safety notes**

**!** **The transmitter battery is responsible for supplying power to the transmitter, and therefore makes a vital contribution to the unit's operational security.** For this reason it is very important that you observe the following instructions on charging and maintaining the battery.

**!** The transmitter battery is fitted with a thermo-fuse with automatic reset which protects the battery and transmitter from short-circuit, reverse polarity and excessive current. The transmitter electronics have **no additional fuse!** For this reason it is **only permissible** to replace the battery with another **genuine MULTIPLEX transmitter pack!**

**!** **Additional safety notes**

- Batteries are potentially hazardous, and must be stored out of the reach of children.
- Before each session check that the battery is in perfect order. Damaged or defective batteries must not be re-used.
- Never heat, burn, open or short out batteries. Do not charge or discharge them at excessive currents, overcharge or deep-discharge them, nor charge them with reversed polarity.
- Place batteries on a heat-resistant, non-flammable and non-conductive surface for charging, and do not leave them on charge unsupervised.
- Do not make any modifications to the rechargeable batteries. Never solder or weld direct to the cells.
- If these batteries are mistreated, there is a danger of fire, explosion, burns and chemical burns. Suitable extinguishing agents: water, CO<sub>2</sub>, sand.
- Escaped electrolyte is corrosive!  
Do not allow it to contact your skin or eyes. In an emergency wash the affected area with copious amounts of water and seek the help of a doctor immediately.

## 8.4. Charging the transmitter battery

### ⚠ Never connect the TX without battery to a charger!

Chargers can supply high output voltages if no battery is connected. This voltages can cause damages in the transmitter.

### ⚠ Charging with mains chargers or 12V-chargers for max. 8 cells

The battery can remain installed in the TX for charging. Connection to the charger is made via the charging socket on the back of the transmitter (→ 7.2.). Use only genuine MULTIPLEX charge leads (e.g. transmitter charge lead with banana plugs # 8 6020). For details of other charge leads and battery chargers please refer to the current MULTIPLEX main catalogue.

### ⚠ Charging with 12V-chargers for more than 8 cells

**Never charge via the charging socket!** Unplug the battery from the electronics board and use the TX battery direct charge lead # 8 6021.

The battery management can only work correctly with a permanent connection (even if the transmitter is switched off) between battery and electronics board to measure into (charging) or out of (operation) the battery. Chargers for more than 8 cells need voltage converters producing high voltages, which can damage the transmitter electronics.

### Full capacity and performance

NiMH batteries only produce maximum performance after a series of charge/discharge cycles (~5 cycles). The first charge/discharge cycles should be carried out at 0.1CA (150 mA). Don't fast-charge the pack until you have done this.

### What means C in charging advices?

C is the charging current, which supplies 100% of its nominal capacity to a battery within 1 hour. This is a current of 1500 mA for the 1500 mAh battery of the **ROYAL**evo. Charging with this current is named 1-C-charging. This current can be derived from the nominal capacity in mAh (or Ah) by just removing the letter "h".

### Standard charging

This means that the pack is charged at a current within the range 0.05 to 0.2 C (75 mA to 300 mA).

The charge time is then calculated from the following formula:

$$\text{Charge time [h]} = \frac{\text{Capacity [mAh]}}{\text{Charge current [mA]}}$$

### Fast charging

This means that the pack is charged at a current within the range 0.5 to 1 C (750 mA to 1.5 A). The charging is finished by the automatic cut-off.

### ⚠ Timer-controlled charging is not permissible!

### ⚠ Important with fast charging:

The charger must be designed to cope with NiMH batteries, i.e. Delta Peak termination sensitivity < 5 mV/cell, or temperature-controlled termination at > 0.8°C/min.

### Trickle charging

This means that the pack is charged at a current within the range 0.03 CA to 0.05 CA (45 to 75 mA). Automatic

chargers generally switch over to this mode of charging when the fast charge phase is concluded. After max. 20 hours trickle charging must be stopped.

### This is the correct method of charging:

1. Switch off the transmitter
2. Switch on the battery charger designed for NiMH batteries (see left column 8.4.) and connect the charge leads.

3. Check polarity:

Red plug = positive terminal (+)

Blue/black plug = negative terminal (-)

### Connecting the charger with reversed polarity may ruin the battery!

(excessive heat, escape of corrosive electrolyte, bursting of cells)

4. Connect the charge lead to the transmitter
5. Select the charge current (max. 1.5 A); alternatively set the current after starting the charge process

### ⚠ Automatic fast chargers: Use manual current selection!

If the fast charger should interrupt the charge process prematurely, reduce the charge current and start again.

6. If the battery becomes too hot during the charging (touching impossible) immediately interrupt the charging.
7. Disconnect the transmitter from the charger at the end of the process.
8. When you have charged the battery enter the charged-in energy in the menu ↶ Transmitter, Batt. charge (8.1.3. a.).

### Note:

The development of rechargeable batteries continues apace, just like other technical components. We therefore reserve the right to supply different battery packs as standard in our transmitters, in order to keep the equipment abreast of current standards.

## 8.5. Maintaining and storing the transmitter battery

Always store NiMH batteries in the **fully charged state**. This avoids the danger of deep-discharge.

Store NiMH batteries at a temperature between 0°C and 30°C, in dry conditions, and out of direct sunshine.

Charge unused NiMH batteries every 3 months. This compensates for the natural self-discharge rate, and again prevents deep-discharge.

If you have to store a battery for a long period, we recommend that you balance the cells by giving the pack several charge/discharge cycles. Protracted storage may reduce the pack's usable capacity.

## 8.6. Recycling

Unlike NiCd cells, NiMH cells contain no cadmium, which is a toxic heavy metal. Nevertheless, exhausted cells should not just be thrown in the domestic rubbish. Take the cells to your local specialist recycling centre. The cells must first be discharged completely and made safe against short-circuit (wrap in plastic film).

**9. Using the transmitter**

**9.1. Switching on for the first time**

When you switch on the transmitter for the first time the following display appears:



Use the buttons „▲“ (UP) or „▼“ (DOWN) to select your language and confirm by pressing „ENTER“. The language can be changed at any time (→ 13.5.2.). All user-definable names (like mixer names, assignment table names, model names) are not affected if you change the language.

**9.2. The power-ON procedure**

When the you switch the transmitter ON, the following power-on info screen will always appear briefly, regardless of whether an RF module is installed or not. This gives information on the transmitter type, the current software version and the languages available for the screen texts:



If no RF module is fitted, the following message appears briefly: „Note: No RF!“

**9.2.1. Switching ON with the HFM-4 RF module for crystals**

After the power-on info screen (→ 9.2.), the last used status display appears (→ 9.6.). If everything is in order, the software immediately activates the RF module for crystals, and an RF (Radio Frequency) signal is immediately transmitted. The LED starts to flash, the screen switches to the last active status display, and the transmitter is ready to use.

**9.2.2. Switching ON with the HFM-S synthesizer RF module**

After the power-on info screen (→ 9.1.), the currently set channel and transmission frequency appears briefly for your information:



After this the last used status display appears. If everything is in order, the software activates the synthesizer RF module, and an RF (Radio Frequency) signal is immediately transmitted. The LED starts to flash, the

screen switches to the last active status display, and the transmitter is ready to use.

The first time you switch the transmitter ON with a synthesizer RF module fitted, or after installing a different synthesizer RF module, an information screen appears, replacing the power-on info screen. This tells you how to set the channel when using a synthesizer RF module:



The method of selecting a channel when using an HFM-S synthesizer RF module is described in Section 9.4.

**9.2.3. Switching on without transmitting an RF signal**

Whether you are using an HFM-4 RF module for crystals or an HFM-S synthesizer RF module it is possible to switch the transmitter ON without transmitting an RF signal, even when an RF module is installed. The transmitter can then be operated in that mode. This can be useful for programming when no RF signal is required, e.g. to minimise current drain, or when your channel is already in use.

Hold the tool button  pressed in when you switch the transmitter on ⇒ you are now at the power-on menu. RF is OFF (⇒ LED glows constantly)

The following display appears:

With HFM-4 RF module for crystals



With HFM-S synthesizer RF module



Pressing any direct menu access button, or the ENTER button, takes you to the last active status display.

**Note:** RF stays OFF until the transmitter is switched ON again.



**9.3. Security queries when switching ON**

**9.3.1. Throttle check**

If in the menu  Transmitter the parameter Check thr. is ON (→ 13.1.6.), the following can appear:



The transmitter starts immediately and RF radiation begins.

- ⓘ For safety reasons throttle is kept in **idle** until the throttle control (Heli: throttle limiter) is in idle position (Heli: at throttle minimum).  
The symbol below the text reminds you of the control, used for throttle. The figure above shows the stick symbol.

If Throttle-Cut is active the transmitter immediately starts operation and a message appears for 4 sec.:

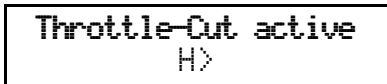

Also in this case the corresponding switch is indicated. The "Throttle Check" safety query can be switched ON or OFF as required (→ 13.1.6.).

 **TIP ! If the safety query does not disappear**  
When missing or defective operating elements are assigned for Throttle and Throttle Cut the safety query can be by-passed by pressing any of the menu buttons or **ENTER**.

**9.3.2. RF Check with the synthesizer module**

If a synthesizer RF module is fitted in your **ROYAL**evo, an additional safety query can be activated (Check RF).  
When you switch ON with an HFM-S synthesizer RF module fitted, the following screen may appear after the power-on info screen:



For safety reasons RF transmission remains OFF until you confirm the displayed channel or transmission frequency by pressing any direct menu access button or the ENTER button. Only then will you see the last active status screen; RF transmission is then activated.  
The "RF Check" safety query can be switched ON or OFF as required (→ 13.1.7.).

**9.4. Selecting the channel with an HFM-S synthesizer RF module**

Channel selection with an HFM-S synthesizer RF module is very simple, convenient and safe:

- 1. Switch on the transmitter with the tool button  pressed in**

⇒ You are now at the channel setting menu, RF is OFF (LED glows constantly).

The following display appears:



Set the channel you wish to use by pressing the „▲“(UP) / „▼“(DOWN) buttons, or one of the two 3-D digi-adjustors. The channel is displayed as a channel number and also the associated transmission frequency. To activate the transmitter on the channel you have just selected, the transmitter must now be switched OFF, and then switched on again -

- 2. Switch the transmitter OFF and then ON again** (this time WITHOUT the tool button pressed in)

You will see the following display::

English text:

Channel 72  
  
NEW CHANNEL!  
  
Enable RF



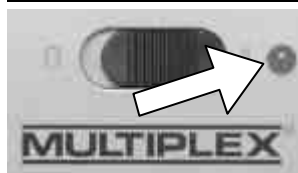

For your information the screen displays the previously set channel. RF transmission remains OFF (=> LED glows constantly) until the waiting period (horizontal bar on screen) to activate the new channel has elapsed. During this waiting period you have the chance to switch off the transmitter before the RF module is activated, if, for example, you have inadvertently set the wrong channel. When the waiting period has elapsed, the last used status display appears  
The LED starts flashing, the transmitter is ready for use.

**9.5. The RF status display (red LED)**



The red LED (light emitting diode) constantly indicates the current status of the RF module when the transmitter is switched on, i.e. whether an RF (Radio Frequency) signal is being transmitted or not.

**RF transmission ON:**  **2 sec**  **2 sec**  ...  
The LED flashes at intervals of about 2 seconds and the transmitter is ready for use.

**RF transmission OFF:**  \_\_\_\_\_  
The LED glows constantly.

The system monitors the current drain of the RF module to check whether an RF signal is being transmitted or not, rather than by checking the status of the RF module. If the current drain is below a typical value, either no RF signal is being transmitted, or the RF signal is being transmitted at less than full power (in which case safe operation cannot be guaranteed!) This method of

monitoring is much safer, as it is also capable of detecting faults and errors::

- Is an RF module installed?
- Is the connection between RF module and transmitter in order (contact fault)?
- Is the RF module working correctly?
- Is a crystal fitted, and is it in order? (only with HFM-4 RF module for crystals)?
- Is the transmitter aerial installed, and is it making proper contact?

If the **ROYAL**evo is in use as a Pupil transmitter, or in diagnosis mode, no RF signal will be transmitted => LED glows constantly.

### 9.6. The status displays

There are four different status displays available in total. You can switch between the individual status displays at any time (provided that you are at one of the other status displays, i.e. not in a menu) using the „▲“ or „▼“ buttons, depending on the information you wish to see.

When you switch the transmitter on, the last used status display will always appear.

#### Status display 1

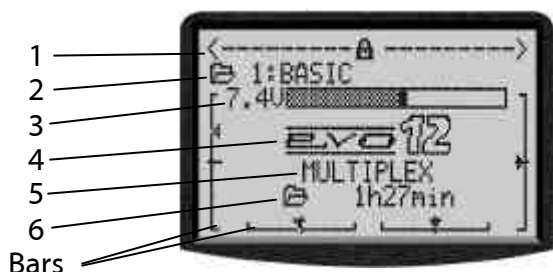

Line 1	Status of the 3-D digi-adjustors. Numerous set-up parameters can be assigned to the 3-D digi-adjustors, which can then be varied directly (→ 10.2.2.).
Line 2	Current model memory with No. of the memory (1): model name(BASIC)
Line 3	Current operating voltage of the transmitter battery in numeric form, and also graphically in horizontal bar form
Line 4	Version: <b>ROYAL</b> evo 9 or <b>ROYAL</b> evo 12
Line 5	User name (→ 13.5.3.)
Line 6	Operating time of the current model memory(→ 17.1.)
Bars	The 4 bars at the sides and bottom of the screen show the current trim positions of the 4 primary control functions/sticks (→ 11.4.)

#### Status display 2 (flight phases)

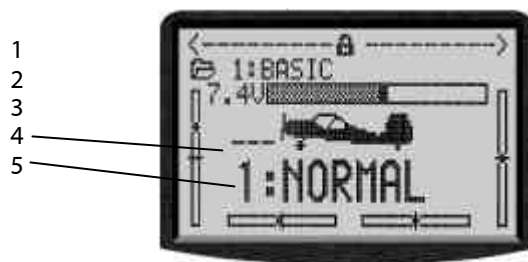

Line 1	Status of the 3-D digi-adjustors, see above
Line 2	Current model memory, see above
Line 3	Current operating voltage, see above
Line 4	Code letter of the switch used to change flight modes (→ 18.4)
Line 5	Current flight mode with No. (1): name (NORMAL)
Bars	Current trim positions, see above

#### Status display 3 (Timers)

Only timers with assigned switches are displayed. Behind the time the switch code letter is shown (P in the example).

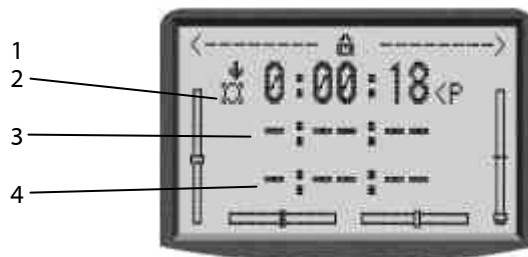

Line 1	Status of the 3-D digi-adjustors, see above
Line 2	Slot-Timer (→ 17.2.)
Line 3	Sum Timer (→ 17.3.)
Line 4	Interval Timer (→ 17.4.)
Bars	Current trim positions, see above

#### Status display 4 (system)

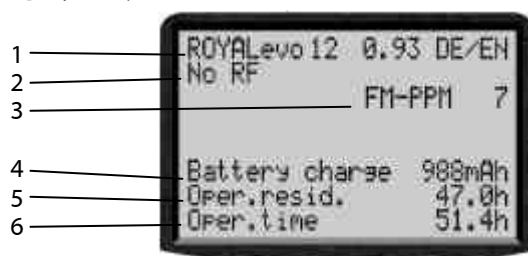

Line 1	Variant (ROYALevo 9 or 12), software-version (e.g. 9/23), language set currently loaded (e.g. DE/GB)
Line 2	with synthesizer module: channel no. freq. else type of RF module (HFM-4) or "No RF"
Line 3	Transmission system (FM-PPM 9)
Line 4	available battery charge
Line 5	residual operating time with the residual charge at the current power consumption
Line 6	Overall operating time of the transmitter

**10. The basic operating philosophy**

The **ROYAL**evo features a new, very simple operating philosophy which is easy and fast to learn. Proven elements of the operating systems used in our other renowned radio control systems are combined here. The system is operated by means of a keypad, although one or both 3-D digi-adjustors can be used optionally for making adjustments and for navigating within the menus.







**10.1. The keypad**

**10.1.1. Direct menu access buttons (row 1)**

The keypad consisting of these buttons is used for programming or - more accurately - setting up the transmitter.





The 6 buttons in the top row are known as the direct menu access buttons. When you press one of the buttons you move directly to the corresponding one of the six main menus, all of which contain appropriate sub-menus. All these buttons are marked by a relevant symbol:

	<b>SETUP</b> (configuration)
	<b>TRANSMITTER CONTROLS</b>
	<b>MIXER</b>
	<b>SERVO</b>
	<b>TIMER</b>
	<b>MEMORY</b>

**10.1.2. Task buttons (row 2)**

What we call the task buttons are required for a wide variety of operations. The way they work varies according to what you are doing. The table below shows the function.

<b>Button</b>	<b>Function in the status display</b>	<b>Function in a menu</b>
	<b>Digi-assignment button</b>	
	Opens or blocks the facility to change a value assigned to one of the two 3-D digi-adjustors.	Selects a value which can be varied using one of the two 3-D digi-adjustors.

<b>Button</b>	<b>Function in the status display</b>	<b>Function in a menu</b>
<b>REV/CLR</b>	<b>Reverse/clear button</b>	
	Manual reset or erase timer times.	Cancel or reverse and erase values and settings.
<b>ENTER</b>	<b>Confirm button</b>	
	No function	Select menus and parameters/settings, confirm and quit.
 	<b>UP/DOWN button</b>	
	Switch between status displays	Select menus and parameters/settings, change values.

**10.1.3. Text input**

For some programming procedures it is necessary to input text. For example, this is required when entering a model name (model memory), the user's name, or the name of a freely definable mixer. The text is entered using the keypad (using the method commonly adopted with mobile telephones) and a 3-D digi-adjustor.

The keypad is used to select the letters and other symbols. The symbols which can be called up by pressing a button rapidly and repeatedly are printed in small letters below each of the direct menu access buttons (row 1) and above the task buttons (row 2):



If you enter a letter at the start of a text input process, or after a space symbol, the software automatically renders it as a capital letter, and subsequent letters automatically as lower-case letters. If you wish to enter a series of capitals, "leaf" through the lower-case letters, and you will find the capital letters thereafter. When you make a selection, the cursor moves automatically to the next position. One of the two 3-D digi-adjustors can be rotated to move the input cursor manually to any position, forward or back.

Press the "ENTER" button to end the text entry process. You now see the following query:

"Clear rest of line? Yes -> (REV/CLR), No -> ENTER"

- Pressing the (REV/CLR) button erases all characters following the last position of the cursor
- Pressing "ENTER" leaves the content unchanged.

**Enter special characters**

Some of the keys have hidden characters, not printed on the transmitter case.

<b>Button</b>	<b>Character</b>
ABC1	A B C 1 a b c
DEF2	D E F 2 d e f
GHI3	G H I 3 g h i
JKL4	J K L 4 j k l
MNO5	M N O 5 m n o
PQR6	P Q R 6 p q r
STU7	S T U 7 s t u
VWX8	V W X 8 v w x
YZ_9	Y Z 9 y z _
/-#0	0 / ? ! - + * & < > *

Space

## 10.2. The 3-D digi-adjustors

The transmitter is fitted with two 3-D digi-adjustors as standard, and these are used for programming and setting up the system

### 10.2.1. Programming using the 3-D digi-adjustors

At the programming stage, both 3-D digi-adjustors operate in parallel with the "ENTER" button when pressed, and in parallel with the "▲" (UP) and "▼" (DOWN) buttons when rotated. You will soon find that you naturally use one or other by default.

### 10.2.2. Making adjustments using the 3-D digi-adjustors

It is possible to assign many different parameters to the 3-D digi-adjustors; you can then use them to adjust the setting quickly and easily, e.g. when the model is flying. One typical setting which can be adjusted and optimised in flight is aileron differential:

1. Select the aileron differential parameter (Fig. 1)
2. Press the <F> button  
Instead of the parameter value the 3-D digi-adjustor symbol (Fig. 2) appears. Now press one of the two 3-D digi-adjustors (in our example the right one) to select it.

If you make a mistake, and the selected parameter is not to be assigned, simply press the "ENTER" button.

Now you can quit the menu and go back to the status display.

In the top line of status displays 1-3 you can now see that aileron differential "Ail-Diff" is variable using the right-hand 3-D digi-adjustor (Fig. 3). If you press or rotate the corresponding 3-D digi-adjustor for a moment, the screen displays the current value of that parameter (Fig. 4). A closed padlock indicates that the value cannot be changed at the moment (as a guard against accidental operation).

If you want to be able to change the value, press the 3-D digi-adjustor assignment switch <F>. The value can now be changed. Every change you make is immediately stored. Pressing the 3-D digi-adjustor assignment switch once more blocks access to the value again (symbol: closed padlock).

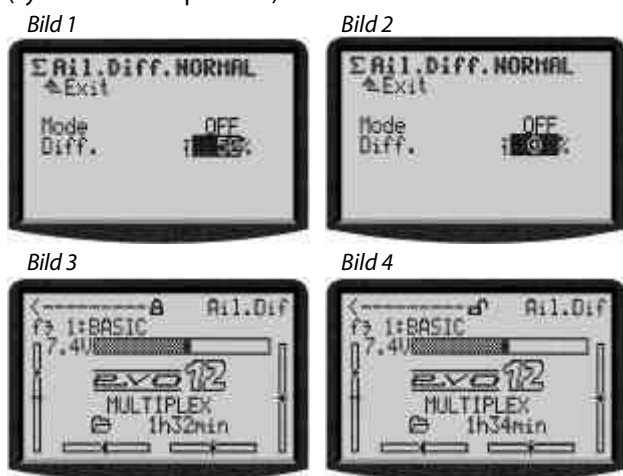

### Note: If you use flight phases

Setup parameters which have different values for each flight phase are displayed correctly, i.e. the displayed values vary according to the currently active flight phase, and can be adjusted separately in each flight phase using the appropriate 3-D digi-adjustor.

This is the procedure for erasing the assignment:

1. Hold the appropriate 3-D digi-adjustor pressed in
2. Press the **REV/CLR** button  
⇒ the screen shows " - - - " and the assignment is erased

Alternatively you can "overwrite" an assignment at any time by assigning a new parameter.

### Which parameters can be assigned to a digi-adjustor?

The general rule is that only those parameters with numeric values can be assigned in this way. However, there are a few exceptions. In the following Display the parameter Step (Step width for trim) can not be assigned.



Assignable parameters with numeric values are indicated by a high-set hyphen following the parameter name. If you attempt to assign a parameter which cannot be assigned, a crossed-out 3-D digi-adjustor symbol appears when you press the 3-D digi-adjustor assignment button.



If you press a 3-D digi-adjustor in this situation you will hear an audible error warning.

### NOTE:

Assigned parameters can not be reversed unintentionally, i.e. modified "across 0" or OFF to values with the inverted sign.







## 10.3. Working with the keypad and 3-D digi-adjustor -the fundamental operating philosophy

These instructions have already described how to switch the transmitter on, the type of status display, and the information and method of operating the status displays (→ 9.1./ → 9.6.).

The following section explains the operating philosophy of the **ROYAL**evo and the methods of working with the keypad and 3-D digi-adjustors, using the example of changing the screen language. The starting point is one of the status displays 1-4 (→ 9.6.).

### 10.3.1. Calling up main menus

To move to the transmitter's menu level, the direct menu access buttons are required (→ 10.1.1.), and they are also used for programming. Six main menus are present in total, all of which contain appropriate sub-menus:

	<b>SETUP</b> (configuration (→ 13.) Transmitter Mixer definitions Assignment Training User
	<b>CONTROL</b> (→ 14.) Access to the individual set-up menus for the transmitter controls. The screen only displays those controls which are used in the current model (=> dynamic menu).
	<b>MIXER</b> (→ 15.) Access to the individual mixer menus. The screen only displays those mixers which are used in the current model (=> dynamic menu).
	<b>SERVO</b> (→ 16.) Calibrate Assignment Monitor Test run
	<b>TIMER</b> (→ 17.) Model/memory operating time Slot timer Sum timer Interval timer
	<b>MEMORY</b> (→ 18.) Select or change model Copy model Erase model Flight phase management Model properties Create new model

Press the corresponding direct menu access button to call up a main menu.

(Example, switch language:  button)

The following display appears:



The first line indicates the main menu in which you are currently located (example main menu Setup: „  Setup“).

The second line always shows „  Exit“.More on this: (→ 10.3.4.).

The following lines list the associated sub-menus. Four dots ..... after the name of the sub-menu indicate that additional menus (sub-menus) are present.

**10.3.2. Opening sub-menus**

You can now select one of the sub-menus line by line using the UP/DOWN buttons (▲ / ▼)\*, or alternatively one of the two 3-D digi-adjustors. The selected line is always highlighted (displayed in inverse video). This corresponds approximately to the cursor of a PC.

(Example: language switch: sub-menu „ User “)



To open a sub-menu press the “ENTER” button, or alternatively one of the two 3-D digi-adjustors.

The sub-menu opens.





To help you keep track of your movements, the first line displays the symbol of the current main menu and the name of the current sub-menu.

(Example language switch:

Main menu  Setup: sub-menu „ User “)

**Note:**

If the area of the screen is not sufficient to list all the sub-menus, you will see arrows „  “ or „  “ on the left-hand edge of the screen. You can then “leaf through” the list up or down using the UP/DOWN (▲ / ▼) arrows, or alternatively one of the two 3-D digi-adjustors, in order to reach the end or beginning of the list. This is very similar to the process of “scrolling” in a PC program. Example:

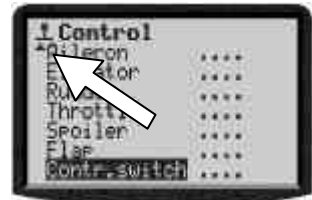
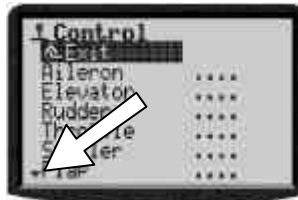

**10.3.3. Changing values**

Switching the display language is used as an example.

Starting from the status display you must proceed as follows:

1. Press the  button  
 This opens the menu Setup. You can now select the sub menu User using the UP/DOWN buttons ▲ ▼ or alternatively one of the two 3-D digi-adjustors. To move to the sub-menu press **ENTER** (or).
2. Now select the parameter “Sprache” (German word for language)with the UP/DOWN buttons ▲ ▼ (or one of the 3-D digi adjustors).



- Press the **ENTER** button (or one of the 3-D digi adjustors) to release the parameter for changing. With the UP/DOWN buttons ▲ ▼ (or one of the 3-D digi adjustors) you can now select one of the two languages:



Your selection is confirmed by pressing **ENTER** (or one of the 3-D digi adjustors) and you will leave the parameter field.

**Note on memorisation of modifications:**

**Modified values/settings are stored immediately in the model memory. No manual storing procedure is required.**

**TIP!**

**Using the REV/CLR button**

The value of a parameter can be changed using the UP/DOWN (▲ ▼) buttons or one of the two 3-D digi-adjustors, but in addition **REV/CLR** button can also be used to reverse many values, or reset them to the default (standard) setting.

**10.3.4. Returning from whence you came**

When you quit the value/setting field the cursor moves back to the last used parameter field.



To leave the sub-menus and main menus simply move to the 2nd line „▲ Exit “ and then press the **ENTER** (or one of the 3-D digi adjustors), until you return to the status display.

Fig.1

Fig.2



**TIP!**

**Direct switching to other main menus**

If you are in one menu and wish to move straight to another main menu, you can do this directly by pressing the relevant direct menu access button.

**TIP!**

**Back to the status display**

Pressing any direct menu access button twice takes you quickly and directly to the status display you last used (provided that you are not currently located at a parameter value).

**11. Digital trims**

**11.1. Introduction**

The **ROYALevo** features modern digital trims for the 4 primary control axes (stick functions).

The trims of the **ROYALevo** operate on the “Centre Trim” principle, i.e. trim corrections only affect the range around the centre of the stick travel, and not the end-points. The advantage compared with conventional trims is that the full control travel (and thus servo travel) remains available, so you do not need to provide a reserve for trimming.

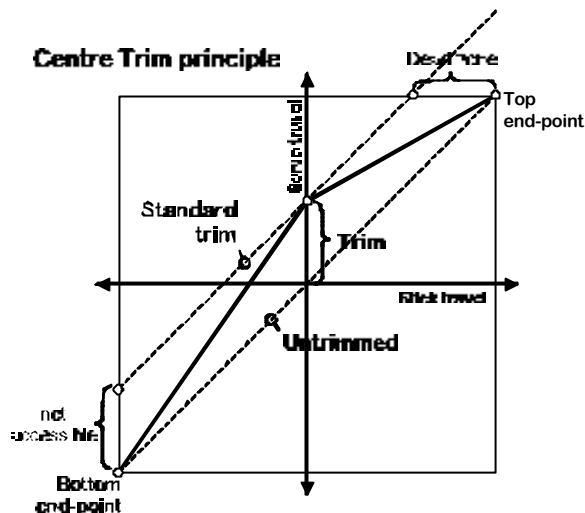

**Standard trim**

The diagram shows what happens when the stick is moved to the right: the servo moves to the top end-point before the stick reaches its end-point. This means: dead zone at one extreme of stick travel.

When the stick is moved to the left, the servo fails to reach the bottom full travel point. That means: full servo travel is not available.

**Centre trim**

Both servo end-points are always reached, regardless of the trim position.

**TIP!**

Since the response curve of the transmitter control is altered when you adjust the “Centre Trim”, it is important that trim corrections should be relatively small. If major corrections are required, always adjust the mechanical linkage!

**11.2. Advantages of digital trims**

Digital trims have two important advantages:

- The trim buttons do not have a mechanical position corresponding to the trim value (as is the case with a conventional trim system with trim sliders). The trim setting of the digital trim is displayed on the screen, and the trim values are stored in the model memory. If you change to a different model memory, the trim is immediately correct; you do not have to move the trim slider to adjust the transmitter to the new model.
- The **ROYALevo** features flight phases, and each phase features its own trim memory for models used with flight phases. Each flight phase can easily be trimmed accurately and independently of the other phases.

### 11.3. The cruciform digital trim assembly

The trims of the ROYALevo take the form of buttons arranged in a cross, located below and to one side of the stick units. They are located in an ergonomically optimum position, and can be reached easily when the transmitter is hand-held or installed in a tray.

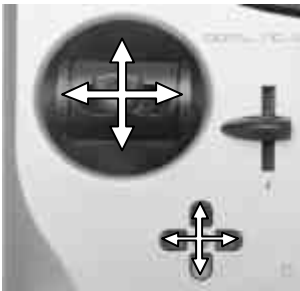

Each press of a trim button effects a trim adjustment around the corresponding control axis in the direction of that button.

If you hold a trim button pressed in for longer than about 1 second, the trim continues to increment until you release the button (AUTO-REPEAT).

ton (AUTO-REPEAT).

Each trim step (increment) is accompanied by a confirmation beep. When you reach the trim centre position, and when you reach the ends of the available trim range, you will hear different sounds. You can switch the trim beeps OFF if you prefer (→ 13.1.2.).

**⚠ The trim of the 4th stick axis (⇄) always works in idle trim mode for throttle!**

This is also valid if SPOILER is assigned to this ⇄ and for helicopters.

### 11.4. On-screen trim display

The trim settings are displayed on the screen in status displays 1-3. They take the form of graphic displays in bar form, on both sides and the bottom of the screen:

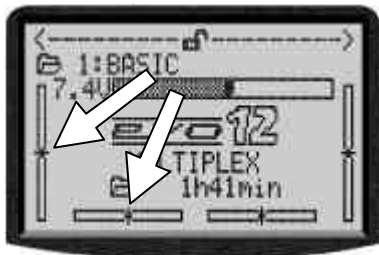

Starting from the trim centre position, a maximum of 20 trim steps are available in both directions. The trim increments can be set to any of 4 values from 0.5% to 3.5% (TStep → 14.2.3).

**⚠ Note: Trim step width, trim range**

**When you alter the trim step, the number of steps stays the same. This means that both the trim range and the actual trim value (!) are changed, i.e. you must adjust the trims again if you alter the trim increment size.**

The current trim value is displayed on the screen in graphic form, but it can also be displayed numerically if you wish (parameter Trim → 14.2.2)

There are several variations in the form of the graphic trim display shown in the status display (parameter Trim Graph → 13.1.1)

**💡 TIP!**



**Reset trim to centre**

If you press both buttons for one of the trimmed axis simultaneously, trim is set to centre for the currently active flight phase. This applies also to throttle.

## 12. Creating a new model

### 12.1. Basic information

With the ROYALevo you create a new model by selecting a model template. A total of eight model templates, or sample models, are available, sub-divided into fixed-wing and helicopters (detailed description of model templates → 12.4.):

	
1. BASIC	7. HELImech
2. ACRO	8. HELIccpm
3. HOTLINER	
4. DELTA	
5. GLIDER	
6. 4 FLAPS	

The values defined by the template serve as starting points, and have to be adjusted to suit your model. All the settings and definitions can be altered at any time and changed in any way you wish.

*"Take it in easy stages"*

When you wish to create a new model with the ROYALevo there are various ways you can proceed. In our opinion the procedures described in the following sections for fixed-wing models (→ 12.2.) and helicopters (→ 12.3.) are the swiftest means of getting to your destination.



### 12.2. A new fixed-wing model

#### Step 1 Creating a new memory

New models are created by moving to the sub-menu New Model in the Memory menu (→ 18.6.).

This is the procedure once you have reached this menu:

1. The software automatically selects the first vacant spot memory for the new model.  
(Parameter Memory nr.)
2. You select a template to suit the model  
(Parameter Template).  
From the eight available model templates select the one which is closest to your model (description of model templates → 12.4.)
3. Choose the servo type and the servo assignment (sequence) at the receiver.  
(Parameter Servo conf.)
4. Select your preferred control mode (stick mode)  
(Parameter Mode)
5. Select an assignment list (which transmitter controls operate the various functions).  
(Parameter Assignment)

**⚠ Note re. assignment list**

In each case you must use the stated assignment list (from the three lists available) depending on the model template you have selected. If you do not do this, the model template cannot be guaranteed to function as described in the text (→ 12.4.).

 **TIP: Changing the assignment**

If the default assignment of transmitter controls and switches does not meet your requirements, you can change the set-up at any time.

(→ 13.3. )

6. Leave the menu by selecting OK; you have successfully created the new model.

**Step 2 Entering the model name**

The model is assigned a name in the menu

 Memory/Properties (→ 18.5.)

**Step 3 Connecting servos**

Connect the servos, speed controller, ... to the receiver, keeping to the sequence of receiver outputs described in the model template. The receiver output sequence can be checked in the menu  Servo/Assignment (→ 16.2.).

 **Note:**

If you wish to connect devices (servos, speed controllers, ...) designed for different signal formats, you can change this parameter separately for each channel in the menu  Servo/Assignment (→ 16.2.).

 **TIP:**

In the same menu you can also change the assignment of the receiver outputs if necessary (in sequence and/or function).

**Step 4 Switch on transmitter and receiver**

 **Note the correct sequence when switching on!**

Always switch on the transmitter first, and only then the receiver.

 **Caution!**

**Injury hazard: power systems may burst into life!**

In principle you can now control your model, but in fact you need to set up the various values to suit the model in question.

**Step 5 Calibrating the servos**

**Please work with the greatest care when calibrating. Your model will only respond accurately to the controls if the servos are correctly calibrated.**

The servos are calibrated in the menu

 Servo, Calibrate (→ 16.1.).

**Step 6 Setting up mixers**

The mixers are set up in the menu  Mixer. This menu is dynamic in nature, i.e. in the interests of clarity the screen only displays the mixers used in the current model. The values assigned to the mixers in the model templates are default (standard) values, and they will need to be adjusted to suit your model.

Please refer to Section → 15 for all you need to know on the subject of setting up mixers.

**Step 7 Setting up the transmitter controls**

The transmitter controls are set up in the  Control. Like the Mixer menu, this menu is dynamic in nature, i.e. in the interests of clarity the screen only displays the transmitter controls used for the current model.

→ 14.

**Step 8 Pre-flight checks**

Your newly created model is now ready to fly. Before you operate the model for the first time be sure to test all the working systems carefully.

You will probably need to fine-tune various aspects of the control system, especially relating to mixers and transmitter control settings, and this is done during the test-flying process. Don't be tempted to make changes in a menu while the model is in the air. The safe, convenient method of altering values is to use the 3-D digi-adjustor (→ 10.2.2.).

**Step 9 Activating flight phases**

Once you have test-flown the model in one flight phase (usually the Normal flight phase) and successfully trimmed it out, with all the mixer and transmitter control values set to your satisfaction, you can consider setting up additional flight phases (if you wish). Flight phases enable you to optimise the model for use in different flight situations. The first step is to activate a new flight phase and copy the values from the first flight phase into the newly activated phase (→ 18.4). The transmitter control settings can now be adjusted ( Control menu) to suit the new task. All the transmitter control settings marked with a small number (1 ...4) can be adjusted separately for each flight phase (→ 14).



**12.3. A new helicopter**

 **Safety note**

Radio-controlled model helicopters are technically demanding flying machines which require fastidious setting up, maintenance and general care. If operated incompetently or irresponsibly they represent a serious hazard.

If you are a beginner we recommend that you:

- Contact an experienced model pilot, your local model club or a model flying school, and ask for help.
- Ask your local model shop for advice.
- Increase your knowledge by reading all you can find on the subject.

**Step 1 Creating a new memory**

New models are created by moving to the sub-menu New Model in the  Memory menu (→ 18.6.).

This is the procedure once you have reached this menu:

1. The software automatically selects the first vacant spot memory for the new model. (Parameter Memory nr.)
2. You select a template to suit the model (Parameter Template). From the two available model helicopter templates select the one which is closest to your model: see table on the next page



Rotor head systems in templates

HELlmech	Model with mechanical rotor head mixing
Heliccpm	Model with electronic rotor head mixing (CCPM); at this stage the type of swashplate (e.g. 3-point 120°, 3-point 90°, 4-point 90°, ...) does not matter. Setting up the appropriate swashplate is carried out later. By default the HELlccpm model template assumes a 3-point 120° swashplate with the "pitch-axis servo" arranged at the rear in flight direction.

(Description of model helicopter templates → 12.11.)

3. Choose the servo type and the servo assignment (sequence) at the receiver.  
(Parameter `Servo conf.`)
4. Select your preferred control mode (stick mode)  
(Parameter `Mode` → 13.3.1.)
5. Select an assignment list (which transmitter controls operate the various functions).  
(Parameter `Assignment` → 13.3.2.)

**Note re. assignment list**

In each case you must use the stated assignment list (from the three lists available) depending on the model template you have selected. If you do not do this, the model template cannot be guaranteed to function as described in the text (→ 12.4.).

**TIP: Changing the assignment**

If the default assignment of transmitter controls and switches (also the idle position, e.g. collective pitch minimum forward or back) does not meet your requirements, you can change the set-up at any time. (→ 13.3 *Setup, Assignment*.)

6. Leave the menu by selecting `OK`; you have successfully created the new model.

**Step 2 Entering the model name**

The model is assigned a name in the menu

`Memory/Properties` (→ 18.5.)

**Step 3 Connect servos to the receiver**

Connect the servos, speed controller, ... to the receiver, keeping to the sequence of receiver outputs described in the model template. The receiver output sequence can be checked in the menu `Servo/Assignment` (→ 16.2.).

**Note: Models with CCPM swashplate**

If you want to set up a model with electronic swashplate mixing (CCPM), but it features a swashplate other than the default arrangement in the HELlccpm template (3-point 120°, pitch-axis servo at rear), you must first alter the servo assignment in the menu `Servo, Assignment` (→ 16.2). Please also read the notes relating to Rotor head mixers (electronic swashplate mixer/CCPM → 15.5.).

**Note**

If you wish to connect devices (servos, speed controllers, ...) designed for different signal formats, you can change this parameter separately for each channel in the menu `Servo/Assignment` (→ 16.2.).

**TIP:**

In the same menu you can also change the assignment of the receiver outputs if necessary (in sequence and/or function).

**Step 4 Switch on transmitter and receiver**

**Note the correct sequence when switching on!**

Always switch on the transmitter first, and only then the receiver.

**Caution!**

**Injury hazard: power systems may burst into life!**

In principle you can now control your model, but in fact you need to set up the various values to suit the model in question.

**Step 5 Calibrating the servos**

**Please work with the greatest care when calibrating. Your model will only respond accurately to the controls if the servos are correctly calibrated.**

The servos are calibrated in the menu

`Servo, Calibrate` (→ 16.1.).

**TIP:**

A 2-point servo calibration is sufficient for the throttle, collective pitch and tail rotor servos. Before calibrating the servos, remember to check that they rotate in the correct direction; if you have to reverse a servo, you will then need to re-calibrate it! For calibrating the two reference points P1 and P5 use the `Assign` button, which moves the servo to the correct position (and keeps it there) regardless of the position of the associated transmitter control (→ 16.1.2). Adjust the percentage values so that the servos move to the maximum travels required, but do not strike their mechanical end-stops (servo stalled) at either extreme of travel.

A 3-point servo calibration is required for the Roll and Pitch-axis servos. Once again, do check that the servos rotate in the correct direction before carrying out the calibration; if you have to reverse a servo, you will then need to re-calibrate it!

For the servos `Head f/b`, `Head l`, `Head r` and (if present) `Head 4` (CCPM swashplate) a more accurate calibration can be carried out by using a 5-point servo calibration. You can set the number of reference points in the menu `* Servo, Calibration` (→ 16.1). Check that the servos are working in the correct "sense" (direction) before you start the calibration process; you can do this by moving the collective pitch stick up and down. Use the `assign` button for calibrating the individual reference points P1 ... P5: all the rotor head servos will run to the appropriate position (and stay there) regardless of the position of the associated transmitter controls. You can now adjust the percentage values until the swashplate remains exactly horizontal at every reference point, without being mechanically obstructed (stalled) at the extreme points P1 and P5.

**Step 6 Setting up the rotor head mixer (models with CCPM rotor head only)**

The mixer is set up in the menu `Mixer, Rotor head` (→ 15.5.). The model template HELlccpm assumes the use of a 3-point 120° swashplate with the "pitch-axis servo" mounted at the rear, as seen from the tail. The values for the parameters `Geometry`, `Rotation` and `Lever` are set in

accordance with this default set-up. If your model features a different type of swashplate control system, you will need to alter these values to suit.

The control travels can now be adjusted in the menu **↓ Control** (→ 14.2.4. Aileron Trvl, Pitch axis Trvl)

### **Step 7** Setting up the collective pitch curve

The collective pitch curve is set up in the menu **↓ Control Collect.** (→ 14.2.9).

A separate collective pitch curve can be set for each flight phase, so that the collective pitch control system is an optimum match to each flight phase. For example:

- **Hover**  
Collective pitch range -2 ... +10°: this means that the model is less sensitive in response at collective pitch minimum, making it easier to land the helicopter under full control.
- **Acro**  
Collective pitch range -10 ... +10°: this means that the model behaves the same in upright and inverted flight.
- **Autorot**  
Collective pitch range -8 ... +12°: this means that the optimum rotor blade settings for auto-rotation are available at collective pitch minimum and maximum.

**TIP:**

The blade pitch angle for hovering is usually in the range approx. 4 ... 5°. When you are adjusting the collective pitch curves it is important to ensure that this value is achieved at roughly the same position of the collective pitch stick on all the collective pitch curves you set up, otherwise the model will “jump” when you switch from one flight phase to another.

**Note: Models with CCPM swashplate**

The collective pitch curve points P1 and P6 should not be set to + or - 100%, as this would mean that symmetrical cyclic control movements (pitch-axis or roll) would not be possible at collective pitch maximum and collective pitch minimum. Depending on the set travels for roll and pitch-axis we recommend a maximum setting of approx. 75 ... 80% for P1 and P6.

### **Step 8** Setting up the throttle curve

The throttle curve is set up in the menu **↓ Control, Throttle** (→ 14.2.10).

The purpose of setting up a throttle curve is to obtain constant system rotational speed over the full range of collective pitch. Stable flight handling can only be achieved if this is the case. Fine-tuning can only be carried out during actual test-flying.

**Note**

The throttle limiter must be at the full-throttle position, and the direct throttle switch must be set to OFF. In this situation the collective pitch → throttle mixer is activated, and the throttle servo follows the movement of the collective pitch stick in the ratio dictated by the throttle curve you have set.

### **Step 9** Setting up the tail rotor mixer (static tail rotor compensation / REVO-MIX)

The tail rotor mixer is set up in the menu **Σ Mixer, TAIL** (→ 15.4).

In the model templates HELMech and HELccpm tail rotor compensation is switched off by default. If your model is fitted with a modern gyro system which is always operated in Heading Lock mode, you must set all values for the TAIL mixer to OFF or 0%. An alternative is to control the tail rotor directly using the Yaw function instead of the TAIL mixer. To do this you need to change the servo assignment (☐ menu, Servo/Assignment → 16.2.) from TAIL to Yaw

If you are using a gyro system which is required to work in normal or damping mode, the TAIL mixer should be activated and set up carefully. This mixer prevents the characteristic swing of the model around its vertical axis when the torque level changes, and makes it easier for the gyro to achieve optimum tail stabilisation.

This is the procedure for setting up tail rotor compensation:

1. Ensure that the servo output arm and the tail rotor actuating arm are at right-angles to the tail rotor pushrod when the tail rotor servo is at the neutral position. If necessary adjust the length of the tail rotor pushrod until this is the case. An accurate mechanical adjustment in this way automatically defines a pre-set tail rotor setting which minimises the helicopter's tendency to swing when hovering.

**TIP:**

If you fold both tail rotor blades to one side, the distance between the blade tips should be around 10 - 20 mm; the actual figure varies with the model.

2. Now move the collective pitch stick to the hover position. You can now set the correct starting point for the tail rotor compensation mixer by transferring the value of the Collective pitch parameter to the Zero point parameter.
3. The level of tail rotor compensation for climb can now be adjusted using the parameter Collective pitch max. “Coll.+”.  
Move the collective pitch stick to the Climb position (collective pitch maximum), and set an initial value which doubles the distance between the tail rotor blade tips (when folded together as previously described). Now move the collective pitch stick to the Descend position (collective pitch minimum) and set an initial value which reduces the distance between the tail rotor blade tips almost to 0 (approx. 5 mm).

For the other flight phases (apart from Auto-rotation) it is safe to start by adopting the same values. Fine adjustment of tail rotor compensation (Collective pitch+, Collective pitch-) for the various flight phases can only be carried out during flight-testing.

In the flight phase Autorotation (AUTOROT) tail rotor compensation is not needed, as the motor is switched off or at idle in this phase, and produces no torque which requires compensation. For this phase set a value of OFF for the parameters Collective pitch+ and Collective pitch-. Set the Offset parameter to a value which sets the blade tips of the (folded) tail rotor blades in a line (= blade pitch angle 0°).

**Step 10** Setting up and testing the gyro

The model templates are designed to reflect the fact that most modellers nowadays use a standard gyro system (normal/damping or heading lock) whose gain (sensitivity) can be adjusted from the transmitter using a separate channel.

In the **ROYAL**evo's two model templates HELlmech and HELlcpm the default setting is the simplest method of gyro gain control: the gyro mode Transmitter control (→ 15.3). In this mode gyro gain is adjusted manually using the transmitter control Gyro (slider E). If you wish to assign a different transmitter control, this can be done in the menu Setup, Assignment (→ 13.3).

The first step is to establish the position of the transmitter control which corresponds to maximum gyro gain. This is done by moving the appropriate transmitter control to one end-point, and moving the model around its vertical axis. At maximum gain the corrective travel of the tail rotor will be at a maximum. If maximum gyro gain is obtained at the opposite position of the transmitter control, you need to reverse the "direction of rotation" of the gyro channel (→ 16.1.1).

The optimum gain setting for the gyro has to be established with the model in flight. For the first few flights we recommend a gain setting of around 50%. During the first few test-flights increase gyro gain gradually until the tail begins to oscillate. Now reduce the gain to the point where the oscillation can just no longer be detected. This is the optimum gyro gain setting.

**Caution!**

Before you fly the model it is essential to ensure that the gyro is working correctly, i.e. that it is set up to counteract any rotational movement. If the gyro is set up incorrectly, it will amplify any tendency to swing, and the helicopter will be uncontrollable. Please read the instructions supplied by the gyro manufacturer.

In addition to gain adjustment from the transmitter control (gyro mode Transmitter control) the **ROYAL**evo offers further facilities for optimising gyro gain separately for each flight phase. (gyro modes Damping, Heading → 15.3.).

**Step 11** Getting to know the method of working of the throttle limiter and direct throttle

**Throttle limiter**

We strongly recommend the use of the throttle limiter. This is slider F in the model templates.

**TIP: Changing the assignment**

If you wish to re-assign the throttle limiter (and also the idle setting: idle forward/back) you can change it at any time. (→ 13.3. Setup, Assignment)

When the throttle limiter is at the idle position, the motor runs at a rotational speed dictated by the parameter Min. (→ 14.2.10), For safety reasons the collective pitch stick has no influence on throttle at this position. The motor can now be started safely. Fine adjustment of the motor's idle speed is available at any time quickly and simply using the trim associated with the collective pitch stick. Set the model on the ground at the take-off patch and move a safe distance away, then check that the collective pitch stick is at collective pitch minimum before slowly moving the throttle limiter to the full-throttle position. The motor will now accelerate to the throttle value corresponding to collective pitch minimum (throttle curve P1 → 14.2.10.). The throttle curve is

now "released", and the model is ready to fly. Throttle is controlled by collective pitch via the throttle curve you have already set.

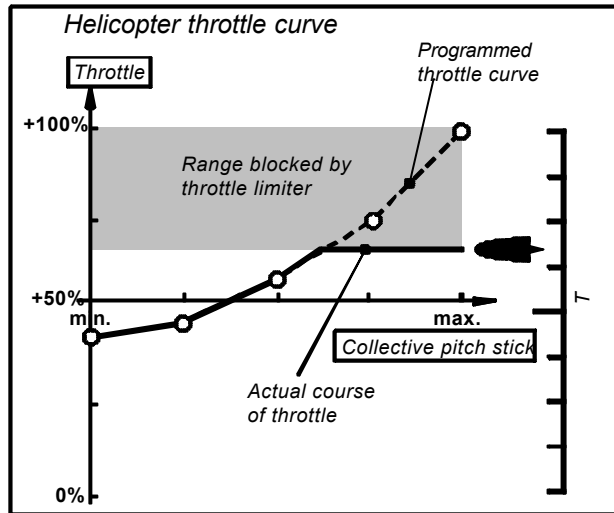

**Direct Throttle**

For testing and adjusting the motor the **ROYAL**evo offers the Direct Throttle facility. Direct throttle means that the motor can be controlled from idle to full-throttle using the throttle limiter, independently of the collective pitch stick. For example, the motor can be set to full-throttle on the ground for testing, and can be loaded with negative blade pitch (minimum collective pitch) (keep a safe distance!). The Combi-Switch is used to activate the Direct Throttle function (→ 13.3.5.).

**Caution**

Ensure that the throttle limiter is at idle before you activate Direct Throttle, otherwise the motor may run up to full-throttle immediately!

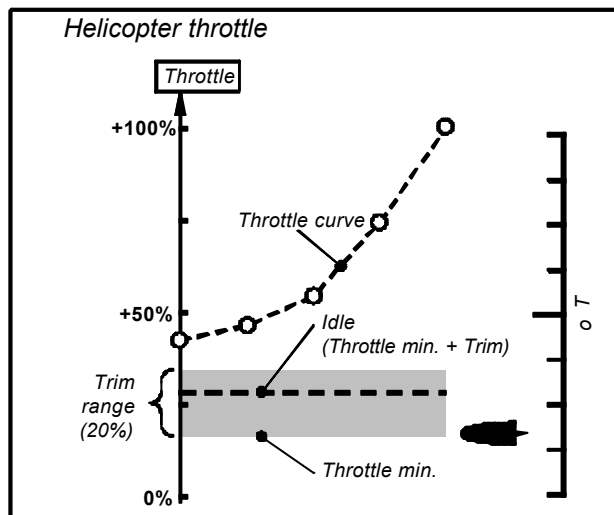

**Note:**

Use the Throttle-Cut to stop the motor not the throttle trim. (→ 13.3.5).

**Step 12** Before test-flying

Your newly created model is now ready to fly. Before you operate the model for the first time be sure to test all the working systems carefully.

You will probably need to fine-tune various aspects of the control system, especially relating to mixers and transmitter control settings, and this is done during the test-flying process. Don't be tempted to make changes in a menu while the model is in the air. The safe, con-

venient method of altering values is to use the 3-D digi-adjustor (→ 10.2.2).

**Step 13 Activating flight phases**

Once you have test-flown the model in one flight phase (usually the Hover flight phase) and successfully trimmed it out, with all the mixer and transmitter control values set to your satisfaction, you can consider setting up additional flight phases (if you wish). Flight phases enable you to optimise the model for use in different flight situations. The first step is to activate a new flight phase and copy the values from the first flight phase into the newly activated phase (→ 18.4.). The transmitter control settings can now be adjusted (↓ Control menu) to suit the new task, especially the collective pitch curve and throttle curve. All the transmitter control settings marked with a small number (1 ... 4) can be adjusted separately for each flight phase (→ 14.).

**Step 14 "Expert tips"**

**Mixer Thr. COMP. (Yaw/Roll/Pitch axis→Throttle)**

When the collective pitch, roll, pitch-axis or yaw commands are made, they may need a corresponding increase in the throttle setting. The mixer Throttle compensation (→ 15.6.) is used for this.

**Mixture mixer**

Some glow plug motors feature a carburettor with variable mixture facility, for which a separate servo is used to maintain the optimum mixture at all throttle settings (carburettor openings). One example of this is the WEBRA mc carburettor. The ROYALevo offers a special feature for this type of carburettor:

Assign the function Mixture to the receiver output to which the mixture adjustment servo is to be connected, and select 5P (→ 16.2.3.) for the servo calibration. The mixture can now be adjusted accurately in the menu ⏏ Servo, Calibrate, Mixture (→ 16.1.) , so that it suits all positions of the throttle servo.

Mixture may not be assigned as control (→ 13.3.4). If you do so, Mixture will not be derived from the throttle signal, but from the assigned throttle control. This would be required if Mixture on an conventional carburettor is controlled by an auxiliary channel.

**12.4. Model templates in detail**

The following sections contain detailed descriptions of all the model templates which are present in your ROYALevo.

In each template description you will first learn the types of model for which the template is suitable.

The first section (12.x.1.) tells you which transmitter controls and switches are assigned. The drawing also shows how the various switches and transmitter controls must be set to ensure that the model can be switched on in as safe a state as possible.

The second section (12.x.2) includes a drawing showing the receiver outputs to which the servos (speed controller, gyro) have to be connected. This sequence can be changed in any way you wish (→ 16.2.).

The third section contains (12.x.3.) notes on how to adjust the model to meet your specific needs and preferences.

**!** The next two steps must **always** be carried out when you start programming a new model.

- a. Check the stick functions (aileron/elevator/rudder); if necessary select a different mode (→ 13.3.1.)  
⏏, Assignment, Mode
- b. Check the direction of servo rotation for all functions, if necessary reverse the directions (REVERSE)  
⏏, Calibrate, select servo, Parameter **REV/CLR**

**12.5. Template: BASIC**

suitable for:

- simple power models
- models with one or two aileron servos,
- models with spoilers (landing flaps or airbrakes)

Typical models:

- Lupo, PiCO-CUB, **Movie Star** (fig. 12.4.2.), Twin-Star, Big Lift

**12.5.1. Assigned transmitter controls and switches**

Assignment used: **POWER**  
not used: Flap (F)

**⌚**: Sum timer **Σ** controlled by throttle (⏏**Σ**)

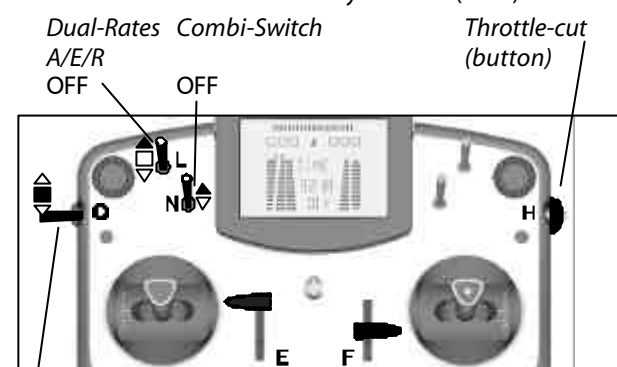

Phase 1-3  
1: NORMAL

**12.5.2. Assigned servos / receiver outputs**

To ensure that the template can be used for as many model types as possible, more servos can be assigned than are required for the model shown in the drawing.

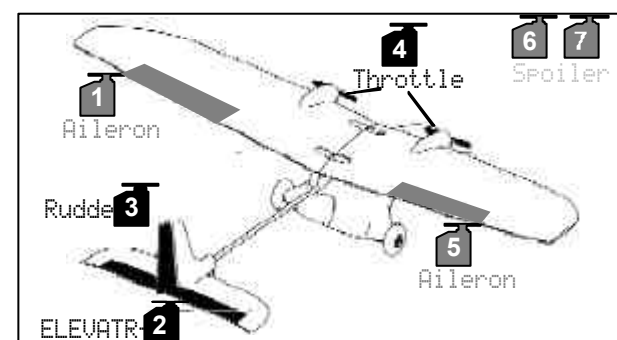

**12.5.3. Fine-tuning**

**!** Steps a. and b. (see left)

**c. Activate throttle - elevator mixer**

- select **Σ**, ELEVATR+, input Thr -Tr , set 10% down elevator
- For fine adjustment in flight assign the value to the 3-D digi-adjustor (→ 10.2.2.).

## 12.6. Template: ACRO

suitable for:

Power models such as F3A (formerly RC1), F3AX  
Fun-fly models

Typical models:

**Sky Cat** (fig. 12.5.2.)

### 12.6.1. Assigned transmitter controls and switches

Assignment used: **POWER**  
not used: Spoiler (E), Flap (F)

⌚ : Sum timer  $\Sigma$  controlled by throttle ( $\uparrow$   $\downarrow$ )

Dual-Rates A/E/R OFF  
Combi-Switch OFF  
Mix-1 Snap-Flap OFF  
Throttle-cut (button)

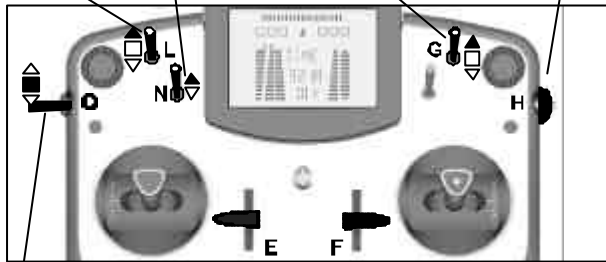

Phase 1-3  
1: NORMAL

### 12.6.2. Assigned servos / receiver outputs

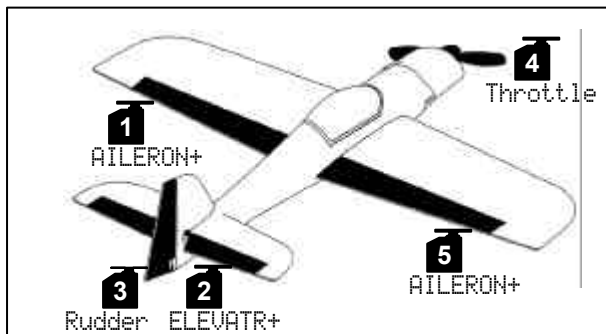

### 12.6.3. Fine-tuning

(for ACRO)

⌚ Steps a. and b. (→ 12.4.)

#### c. Activate throttle - elevator mixer

select  $\Sigma$ , ELEVATR+, input Thr -Tr,  
set 10% down elevator  
For fine adjustment in flight assign the value to the  
3-D digi-adjustor (→ 10.2.2.).

#### d. Activate flap - elevator mixer

select  $\Sigma$ , ELEVATR+, input Flap,  
set Trvl $\uparrow$  = 5%, Trvl $\downarrow$  = 10%  
For fine adjustment in flight assign the value to the  
3-D digi-adjustor (→ 10.2.2.).

## 12.7. Template: HOTLINER

suitable for: F5B

Typical models: Bonito, Akro, Akro Star

### 12.7.1. Assigned transmitter controls and switches

Assignment used: **POWER**  
not used: Combi-Switch (N)  
Spoiler (E), Flap (F)

⌚ : Sum timer  $\Sigma$  controlled by throttle ( $\uparrow$   $\downarrow$ )

Dual-Rates A/E/R OFF  
Combi-Switch OFF  
Throttle-cut (button)

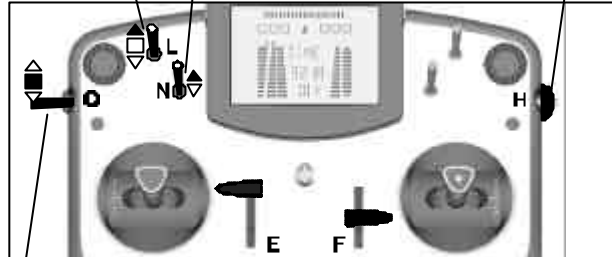

Phase 1-3  
1: NORMAL Spoiler retracted

### 12.7.2. Assigned servos / receiver outputs

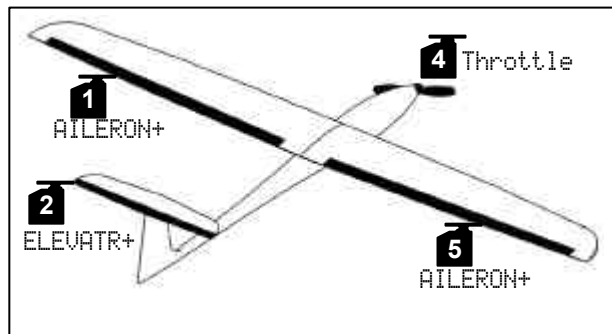

### 12.7.3. Fine-tuning

⌚ Steps a. and b. (→ 12.4.)

#### c. Ailerons raised as landing aid

This function is already programmed in the template, and is controlled by the Spoiler transmitter control (slider E). You may have to adjust the pitch compensation ratio (15%) in the ELEVATR+ mixer.

#### d. Activate throttle - elevator mixer

select  $\Sigma$ , ELEVATR+, input Thr -Tr,  
set 10% down elevator  
For fine adjustment in flight assign the value to the  
3-D digi-adjustor (→ 10.2.2.).

## 12.8. Template: DELTA

suitable for:

Deltas and flying wings powered or glider,  
Model Jets

Typical models:

PiCOJet, **TWIN-JET** (fig. 12.7.2.), Stuntman

### 12.8.1. Assigned transmitter controls and switches

Assignment used: **POWER**  
not used: Combi-Switch (N)  
Spoiler (E), Flap (F)

☉: Sum timer  $\Sigma$  controlled by throttle (E) ( $\Sigma$  Tr)

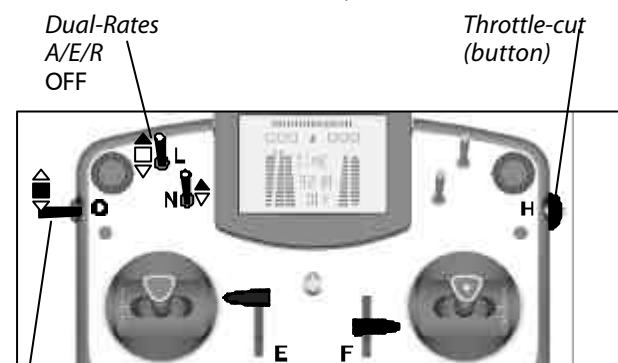

Phase 1-3  
1: NORMAL

### 12.8.2. Assigned servos / receiver outputs

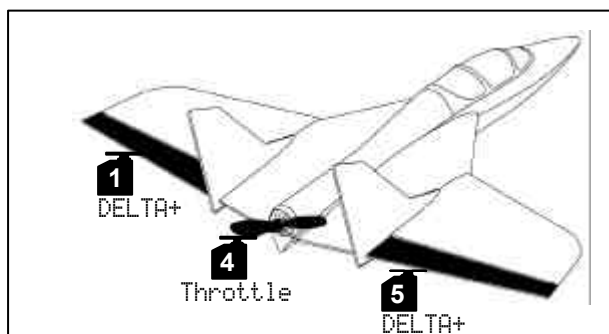

### 12.8.3. Fine-tuning

☉ Steps a. and b. (→ 12.4.)

#### c. Using a receiver with fewer than 5 channels

Change servo assignment:  Assignment  
e.g. 1=DELTA+, 2=DELTA+, 3=Throttle

#### d. Control surface travels excessive or insufficient

select  $\Sigma$  mixer DELTA+,  
change elevator and/or aileron inputs

#### e. Activate throttle - elevator mixer

select  $\Sigma$ , ELEVATR+, input Thr -Tr,  
set 10% down elevator  
For fine adjustment in flight assign the value to the  
3-D digi-adjustor (→ 10.2.2.).

## 12.9. Template: GLIDER

suitable for:

Gliders with two wing flaps (i.e. ailerons only), with  
electric power, with V-tail

Typical models:

Flamingo, Kranich, Alpha 21/27

### 12.9.1. Assigned transmitter controls and switches

Assignment used: **GLIDER+**  
not used: Flap (F)

☉: Sum timer  $\Sigma$  controlled by throttle (E)

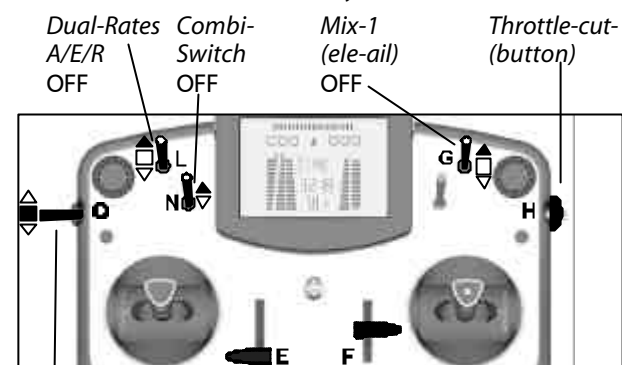

Phase 1-3  
1: NORMAL Throttle  
Idle

### 12.9.2. Assigned servos / receiver outputs

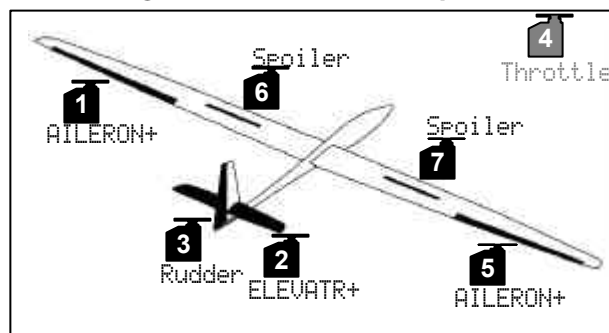

If your model has an **aero-tow release** mechanism instead of a power system, you can use servo 4 to operate it. The following steps are required:

#### 1. Assign control

$\Sigma$ , Assignment, Control, then select Tow rel. and an element to operate it (e.g. button M)

#### 2. Assign servo

, Assignment, select servo 4, change Throttle to Tow release

#### 3. Adjust servo

Direction of servo rotation and end-points are set under  , Calibrate.

### 12.9.3. Fine-tuning

☉ Steps a. and b. (→ 12.4.)

#### c. Ailerons raised as landing aid ...

... if your model has no airbrakes (servos 6/7).

Select  $\Sigma$ , AILERON+, set Spoiler input to 90%  
Adjust the compensation ratio if necessary in ELEVATR+.

#### d. Activate throttle - elevator mixer

select  $\Sigma$ , ELEVATR+, input Thr -Tr,  
set 10% down elevator  
For fine adjustment in flight assign the value to the  
3-D digi-adjustor (→ 10.2.2.).

**12.10. Template: 4-Flaps**

suitable for:

F3B, F3J,  
Glider with four wing flaps, with electric power,  
with V-tail Typical models:

DG 600, ASW 27, Milan, EURO/ELEKTRO-MASTER,  
**Alpina** (Bild 12.9.2.), ASH 26

**12.10.1. Assigned transmitter controls and switches**

Assignment used: **SEGLER**

⌚ : Sum timer  $\Sigma$  controlled by throttle (E)

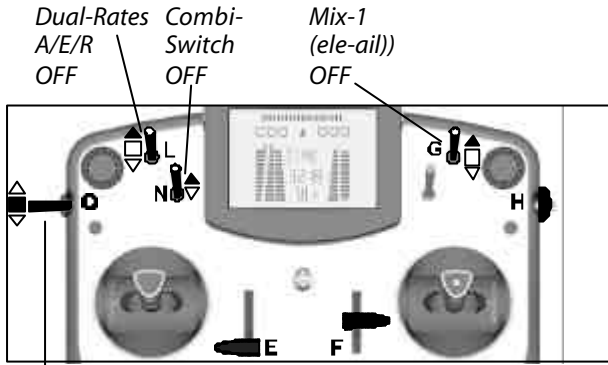

Phase 1-3  
1: NORMAL

Throttle  
Idle

Flap  
neutral

**12.10.2. Assigned servos / receiver outputs**

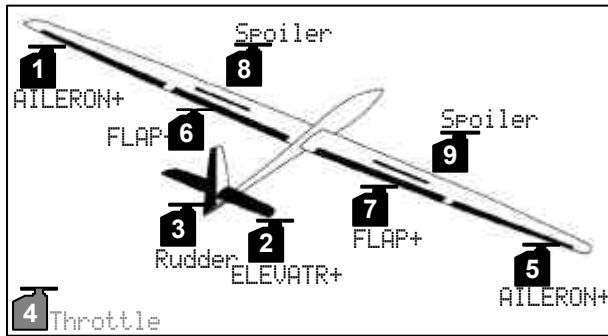

← **Aero-tow release** instead of throttle: see 12.9.3.

**12.10.3. Fine-tuning**

⚙ Steps a. and b. (→ 12.4.)

**c. Butterfly**

This function is already programmed in the template, and is operated using the transmitter control Spoiler (slider E). You may have to adjust the compensation ratio (15%) in the ELEVATOR+ mixer.

**d. Activate throttle - elevator mixer**

select  $\Sigma$ , ELEVATR+, input Thr -Tr, set 10% down elevator  
For fine adjustment in flight assign the value to the 3-D digi-adjustor (→ 10.2.2.).

**12.11. Template: HELI**

suitable for:

Main rotor control systems with mechanical mixers

Typical models:

Ergo, Futura, Moskito, Raptor

**12.11.1. Assigned transmitter controls and switches**

Assignment used: **HELI**

⌚ : Sum timer  $\Sigma$  controlled by THR.LIMITER (F)

Dual-Rates A/E/R OFF  
Direct Throttle OFF  
Main phase OFF  
Throttle Cut

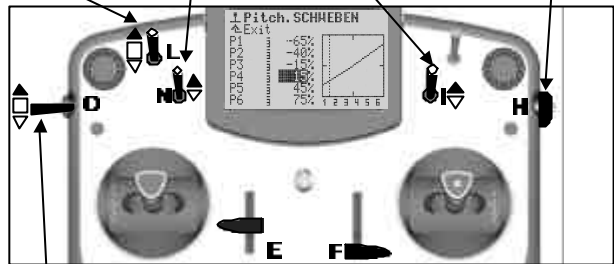

Phase 1-3  
1: HOVER

Gyro  
Centre

Thr. limiter (Direct Thr.)  
Minimum

**12.11.2. Assigned servos / receiver outputs**

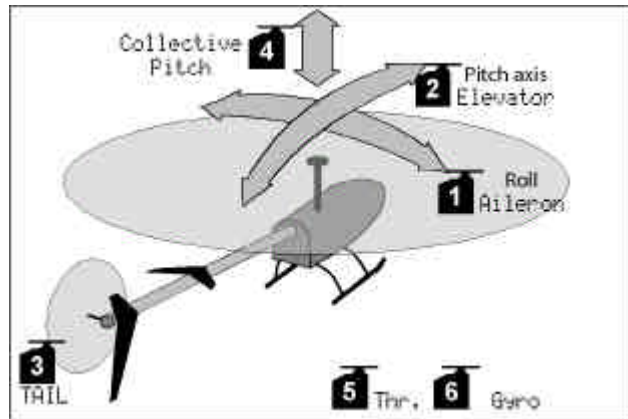

**12.11.3. Fine-tuning**

a. Check stick functions (roll, pitch-axis, yaw)  
Select different mode if necessary (→ 13.3.1.)  
↔, Assignment, Mode

b. Check direction of servo rotation for all functions  
If necessary change servo direction (REVERSE)  
☐, Calibrate, select servo, Parameter **REV/CLR**

c. Gyro features  
→ 15.3.

### 12.12. Template: HELIccpm

suitable for:

Main rotor control systems with electronic mixers  
CCPM (Cyclic-Collective-Pitch-Mixing)  
with 3 or 4 servos, 90° to 150°

Typical models:

ECO 8, Logo, Fury, Three Dee NT, Uni-Expert

#### 12.12.1. Assigned transmitter controls and switches

Assignment used: **HELI**

: Sum timer controlled by THR.LIMITER (F)

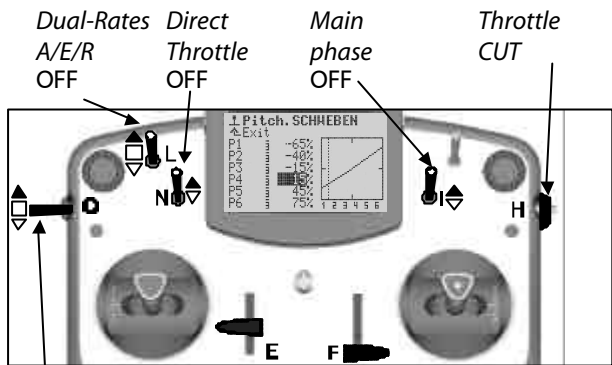

Phase 1-3  
1: HOVER  
Gyro  
Centre  
Thr. limiter (Direct Thr.)  
Minimum

#### 12.12.2. Assigned servos / receiver outputs

The default setting in the HELIccpm model template is a 120° swashplate with the pitch-axis servo at the rear.

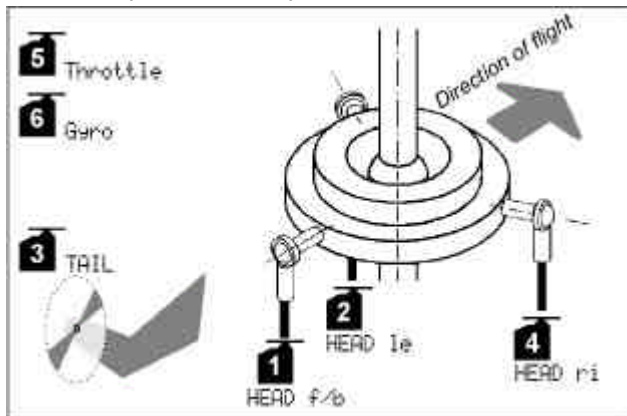

#### 12.12.3. Fine-tuning

- Check stick functions (roll, pitch-axis, yaw)  
Select different mode if necessary (→ 13.3.1.)  
, Assignment, Mode
- Check direction of servo rotation for all functions  
If necessary change servo direction (REVERSE)  
, Calibrate, select servo, Parameter **REV/CLR**
- Gyro features  
→ 15.3.

### 13. Main menu „Setup“

This main menu is primarily concerned with settings which apply to the transmitter generally.



- This symbol indicates global settings which influence the behaviour of the transmitter generally.
- Some settings apply only to the selected model. These are marked with the model memory symbol.

#### 13.1. Sub-menu „Transmitter“

##### 13.1.1. Parameter „Trim graphics“

- global effect
- The current state of the trims can be displayed on screen in any of 6 different ways (trim graphics 0 to 5). We suggest that you try out the variants and set the one which you find easiest to see at a glance.

##### 13.1.2. Parameter „Sounds“

- global effect
- With this parameter you determine which events in the transmitter trigger an audible signal.

Setting	Audible signal
1. Battery	when battery voltage falls below alarm threshold
2. Batt+Time	as 1. + timer alarm
3. B+Ttim+Tr	as 2. + trim adjustments
4. Init off	all, except during power on
5. ALL	always

##### 13.1.3. Parameter „Battery alarm“

- global effect
- Range 6,50 to 7,5 V (0,01V increments)  
Default setting 6,9 V
- The battery alarm is intended to alert you to a failing battery, i.e. the charge is only sufficient for a limited residual operating time.
- The lower you set the threshold, the shorter the remaining residual operating time.**

The residual operating time varies very widely according to the set threshold and the state of the battery. For this reason it is important that you should carry out a test to establish how much residual time is available in your particular case.

This is done by switching on the transmitter with the aerial fully extended, and the RF module with crystal (or synthesizer) installed. You don't need to move the sticks. Set the alarm threshold to the desired value, and leave status display 1 or 2 on the screen to show the battery voltage.

Now time the period from the first audible alarm warning until the minimum operating voltage (6.5 V) is reached).

- The transmitter switches itself off automatically at around 6.3 V!**



**TIP!**

When you reach the alarm threshold that you prefer (first audible alarm), set the threshold to 6.5 V. The transmitter will then only emit an alarm when the battery falls to the minimum threshold. That tells you how long you have to land your model. Don't forget to set "your" threshold again afterwards.

**13.1.4. Parameter „Battery charge“**

 global effect  
Is set to 0 mAh if the battery voltage drops below 6.5 V.

This parameter allows correction of the charge measured by the battery management system (→ 8.1.).

**13.1.5. Parameter „Contrast“**

 global effect  
Range -8 to 8  
Default setting 0

This parameter enables you to adjust the contrast of the screen to suit the prevailing temperature conditions.

**13.1.6. Parameter „Check throttle “**

 affects active model only

 **Guards against the power system starting up accidentally when you switch on the model!**  
Check thr ON

Electric-powered models may burst into life at full throttle when you switch on unless the throttle control on the transmitter is at the idle position.

With Check THROTTLE = ON the software checks two conditions when you switch on the transmitter:

1. Is Throttle-Cut switched off?
2. Is the THROTTLE control at idle?

The message is displayed as long as the throttle control is **not** in idle position: RF radiation starts immediately, but .due to safety reasons the throttle signal is kept in idle.

**13.1.7. Parameter “Check RF”**

 global effect  
only possible with synthesizer RF module

 **Safety query when transmitter is switched on!**  
Check RF ON

Changing channels with synthesizer RF modules is relatively simple, so the **ROYAL**evo provides an additional security query which can be activated.

With Check RF = ON the transmitter asks you whether you **really** want to start transmitting on the set channel; this it does every time you switch on. You must confirm this by pressing a button (or by switching the transmitter off again).

**13.2. Sub-menu “Define mixer”**

 Defined mixers are globally available



The **ROYAL**evo provides 14 freely definable mixers. From this "mixer pool", which you create over a period of time to suit your applications and models, you can use up to 5 different mixers in one model as often as you like.



**Note for helicopter pilots**

**These freely definable mixers are only available for fixed-wing models. The system provides a set of ready-made mixers for model helicopters which cannot be changed.**



**Note: Predefined mixers**

Mixers 1-5 are already set up as standard, but they can be changed at any time to suit your personal requirements. However, please note that we cannot guarantee that the template will work 100% correctly if you change the standard mixers and subsequently create a new model using a model template (→ 12.4.) which includes the assigned "standard mixers".

If you attempt to change one of these "standard mixers" the following on-screen note appears:



**13.2.1. How the freely definable mixers work**

The basic principle of the **ROYAL**evo's freely definable mixers is based on the proven method of working employed by the MULTIPLEX PROFI mc 3000 and 4000 series of radio control systems. A simple method of explaining this is as follows:

We always start from the "control functions" or the servo movements. Example: aileron servo on a glider (pre-defined mixer: AILERON+). When do we want this servo to move?

1. When the "aileron" control is operated (primary function)
2. When the "spoiler" function is operated (ailerons up as landing aid)
3. When the "flap" control is operated (up/down movement of the ailerons to trim the wing section for thermal or speed flying)
4. When the "elevator" control is operated (up/down movement of the ailerons to amplify the elevator response when flying "square" aerobatic manoeuvres => snap-flap)

We can see that the aileron servo is to be controlled by 4 transmitter controls. The "AILERON+" mixer therefore has 4 inputs (up to 5 inputs are possible).

The mixer adds together the value of the signals generated by the individual inputs (hence also the sum symbol Σ) and passes the result to the aileron servo or servos.

If this or any other mixer is to work correctly on a model, the following requirements must be satisfied:

- The appropriate assignment list with the correct transmitter controls -> inputs must be assigned to the model (→ Setup, Assignment, Controls).

- The mixer must be assigned to the appropriate receiver outputs (→ Servo, Assignment).
- The inputs must be set up correctly, i.e. the magnitude and direction of the servo's movements when the input / transmitter control is operated (→  $\Sigma$  Mixer).

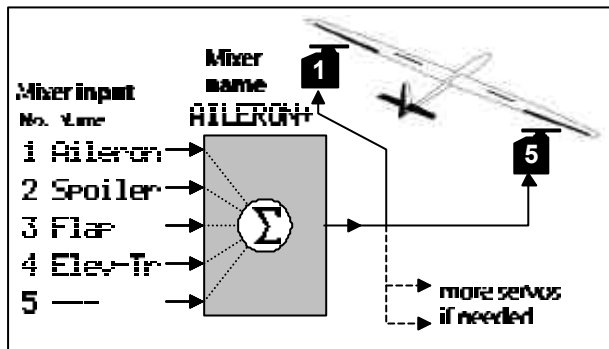

**TIP:**

**For modellers familiar with the PROFI mc 3000 and 4000:**

The mixer inputs of the **ROYAL**evo are now set at the mixer, rather than at the servo end.

**The advantage is this:**

The inputs are set up at a **single** point (→ 15.), rather than at several points (servos). This makes the task of setting up simpler and less time-consuming. It also means that the setting of an input can be adjusted conveniently when the model is in flight, using a 3-D digi-adjustor. Careful servo calibration (→ 16.1.) is also important, otherwise you may find that multiple control surfaces do not deflect by the same amount. This would mean, for example, that a model being landed with the ailerons deflected up would tend to turn to one side on the final landing approach.

**13.2.2. Defining mixers**



Each mixer can be assigned its own name of your choice. This is carried out in line 3 under Name (→ 10.1.3. text input).

The next step is to assign up to 5 mixer inputs (transmitter controls) of your choice; this is done in lines 1 - 5.:

Col. 1	<b>Mixer inputs</b> (controls) Aileron, elevator, rudder and throttle can be assigned as required, with or without trim. Example line 4: "Thr -Tr" = Throttle without trim
Col. 2	<b>Mixer switch</b> Mix-1, Mix-2 or Mix-3 Can be used to switch the corresponding input on or off. "-----" means that the input is always active.
Col. 3	<b>Mixer options</b> (→ 12.2.3.) How is the input to take effect? Which settings are to be available when you set up the mixer? Where is the neutral position of the control?

**13.2.3. The mixer options**

**„Symmetrical“**

Neutral position of control: Centre  
one parameter: Travel

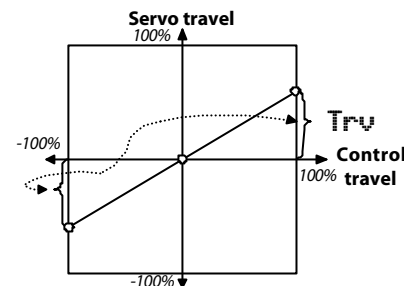

The control generates a symmetrical movement of the servo with variable travel around the servo centre

Application sample: Input Aileron, Elev., Flap in mixers like AILERON+, FLAP+, ELEVATOR +

**„Asymmetrical“**

Neutral position of control: Centre  
two parameters: Travel↑ and Travel↓

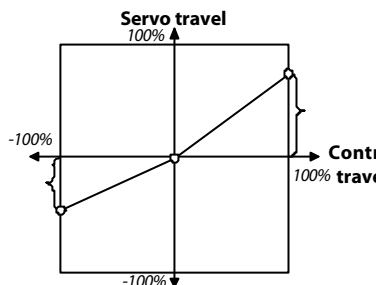

The transmitter control generates an asymmetrical movement of the servo around the servo centre; travel can be set differently for both travel directions.

Application sample: Input Flap in mixers like AILERON+, FLAP+

**„Single-sided with curve“**

Neutral position of control: End-point  
two parameters: Point1 and point2

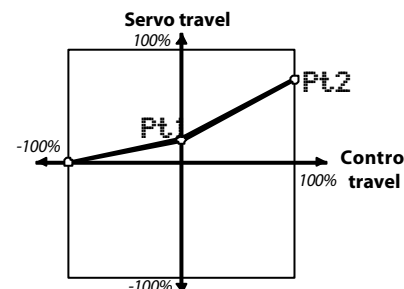

The transmitter control generates a linear movement of the servo from the servo centre, with variable travel in one direction.

Application sample: Non-linear inputs for compensation (Spoiler in ELEVATOR+)

**„Single-sided/linear with dead zone“**

Neutral position of control: End-point  
two parameters: Dead zone and travel

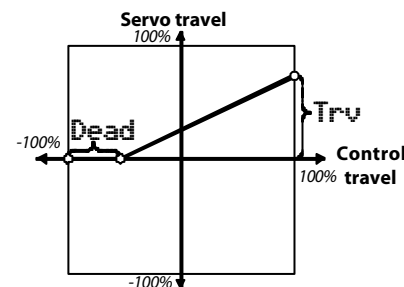

The transmitter control generates a linear movement of the servo from the servo centre, with variable travel in one direction and variable dead zone of the transmitter control.

„Symmetrical with dead zone“

Neutral position of control: Centre  
 two parameters: Dead zone and travel

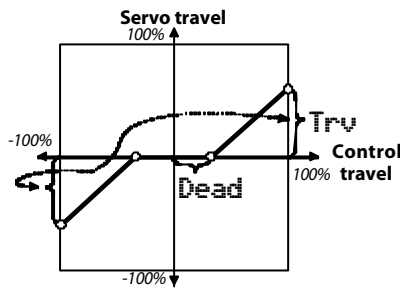

The control generates a symmetrical movement of the servo starting at a point remote from the control centre (dead zone), with variable but identical travel in both directions.

**Attention:** Do not use for ALLERON inputs!

The option single sided/linear with offset is the only one where the servo movement starts from the point defined by the OFFSET parameter and not from the centre.

„Single-sided, linear with offset“

Neutral position of control: End-point  
 two parameters: Offset and travel

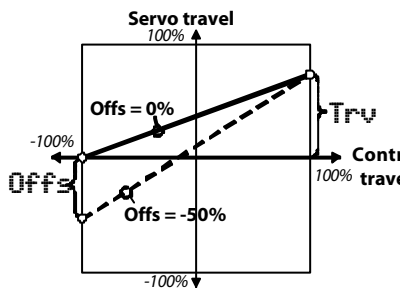

The offset moves the end-point of the servo travel. Total travel of the servo is Offs+Trv

Application sample: Input Spoiler in the mixer FLAP+ for large travel down-wards with butterfly (crow).

13.3. Sub-menu "Assignment"



The ROYALevo enables the user to assign the various physical elements present (sticks, sliders, switches, buttons) as transmitter controls or switches (function switches)..

**What are transmitter controls?**

Transmitter controls are all those elements on your transmitter which you can use to control a servo (speed controller, etc.) on the model directly. In chapter 13.3.4. you find a list of all possible controls for the ROYALevo.

**What are switches?**

What we term switches are physical controls which are not used to control primary functions on the model. They are used, for example, to switch mixer functions (e.g. Combi-Switch), Dual Rates, timers and flight phases on and off. In chapter 13.3.5. you find a list of all possible switches.

**TIP:**

For modellers familiar with the MULTIPLEX PROFI mc 3000 and 4000:

All the control elements of the ROYALevo are permanently installed. The ROYALevo does not differentiate "electrically" between transmitter controls and switches; this means that any control element can be used as a transmitter control and/or as a switch. It is no longer necessary to assign what are known as "transmitter control switches" or "Gx switches". For example, if you wish to time the motor run, simply assign the throttle transmitter control as the timer switch.

All the control elements of the ROYALevo are permanently installed. The ROYALevo does not differentiate "electrically" between transmitter controls and switches; this means that any control element can be used as a transmitter control and/or as a switch. It is no longer necessary to assign what are known as "transmitter control switches" or "Gx switches". For example, if you wish to time the motor run, simply assign the throttle transmitter control as the timer switch.

**Note: Predefined assignment lists**

3 of the 5 assignment lists contain default assignment data. This can be changed at any time to suit your own requirements. However, please note that we cannot guarantee that the template will work 100% correctly if you change the standard mixers and subsequently create a new model using a model template (→12.1.) which includes the assigned "standard mixers".

If you attempt to change one of these “standard mixers” the following on-screen note appears:

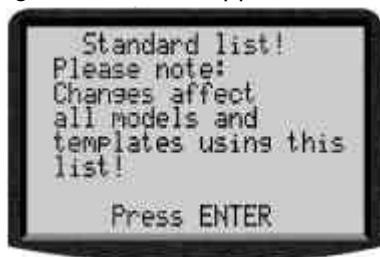

**13.3.1. Parameter „Mode“**

Affects active model only

The transmitter controls for the primary control axes (sticks) aileron / elevator / rudder or roll-axis / pitch-axis / yaw are governed by the “Mode” (stick mode) parameter, rather than by assignment lists.

All 4 possible control modes are available. The arrows are reminders for the assignment.

↔ stands for Rudder resp. yaw

⊖ stands for Elevator resp. Pitch Axis

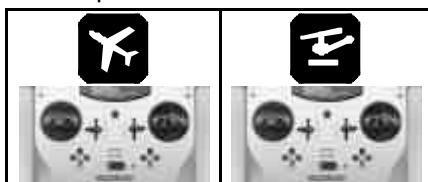

Mode				
	left	right	left	right
1: ⊖ ↔	Elevat. Rudder	Thr./Sp. Aileron	Pitch Yaw	Coll. Roll
2: ↔ ⊖	Rudder Thr./Sp.	Elevat. Aileron	Coll. Yaw	Pitch Roll
3: ⊖ ↔	Elevat. Aileron	Thr./Sp. Rudder	Pitch Roll	Coll. Yaw
4: ⊖ ↔	Thr./Sp. Aileron	Elevat. Rudder	Coll. Roll	Pitch Yaw

The stick mode can be changed at any time (e.g. if another modeller accustomed to a different stick mode wishes to fly your model). Changing the mode does not affect any settings or values (e.g. trim settings) in any way.

You can change the stick mode here in the menu Setup, Assignment (→ 13.3.2.) as well as in the menu Memory, Properties (→ 18.5.).

**13.3.2. Parameter „Assignment“**

Affects active model only

You can change the stick mode here in the menu Setup, Assignment as well as in the menu Memory, Properties (→ 18.5.).

**13.3.3. Parameter „Assignment - Name“**

affects only the active assignment (→ 13.3.2.)

Each assignment list (consisting of transmitter control assignment and switch assignment) can be allotted its own name. 8 characters are available (text input: → 10.1.3.).

**13.3.4. Parameter „Assignment - Controls“**

Affects active assignment only (→ 13.3.2.)



The following control functions are available:

Control function	Note
Throttle	
Spoiler	
Flap/RPM	Flap for fixed wing models and RPM control for helicopters
L. gear	
Tow hook	
Brake	
Gyro	
Mixture	
AUX1	Auxiliary function/channel
AUX2	Auxiliary function/channel
Collect.	Helicopters only
Thr. limit	Helicopters only (throttle limiter/“Idle up”)

The corresponding transmitter control (control element) for the control functions listed above can be assigned quickly and simply using Quick-Select.

**Assigning using Quick-Select:**

1. In Column 1 select the desired function (Column: Control function)
2. Press **ENTER** to move to Column 2 (Column: Control element)
3. Operate the desired control element  
⇒ The screen displays the code letter for the control element you operated.

**TIP:**

One control element can be assigned to multiple control functions, and can also be assigned simultaneously as a switch (also for several functions).

1. **Important!**  
Move the control element to the desired neutral position (e.g. throttle to idle, spoiler to retracted position, collective pitch to minimum position)
2. Press **ENTER** to confirm the input  
⇒ cursor returns to column 1

If the control function is not required, erase the assignment by pressing **REV/CLR** ⇒ „ - - - “ appears.

Column 3 shows the status (\* = ON, control element at neutral position) and the direction of the neutral position (↕ / ↗).

**Note: Assignment of push buttons**

Please note the exceptions which apply when assigning the following control elements: momentary switches “H” and “M”, stick-top buttons “KTa” and “KSw” (→ next page).

**13.3.5. Parameter „Assignment - Switches“**

Affects active assignment only (➔ 13.3.2.)



The following switch functions are available:

Switch function	Note
DR-ai	Dual-Rates for aileron or roll (➔ 14.2.4.)
DR-el	Dual-Rates for elevator or pitch axis (➔ 14.2.4.)
DR-ru	Dual-Rates for rudder or yaw (➔ 14.2.4.)
CombiSwitch	<b>Fixed wing models:</b> ON/OFF switch for combi-switch mixer (➔ 15.1.) <b>Model helicopters:</b> Activates direct throttle
Throttle-cut	Activates Throttle-Cut function Independent of the current throttle setting the motor (electric or gasoline) is switched OFF (➔ 9.3.1.)
Slot	Activates slot timer (➔ 17.2.)
Σ sum	Activates sum timer (➔ 17.3.)
⌘ interval	Activates interval timer (➔ 17.4.)
Mix-1 ..3	<b>Fixed wing models:</b> Switches mixer inputs ON/OFF (➔ 13.2.2.) <b>Model helicopters:</b> Mix-1: Switches gyro mode Mix-2, Mix-3: no function
Teacher	Transfer switch for teacher/pupil (Trainer) operations (➔ 13.4.)
Main Phase	Aktivates primary flight phase 4
Phases 1-3	Aktivates secondary flight phases

Assigning a control element to one of the functions listed above is carried out using Quick-Select, as when assigning Transmitter controls (➔ 13.3.2.).

**TIP ! Where is ON, where the OFF position?**

The arrow (↕/↗) behind the code letter in the menu always points towards the ON position. Move the switch to the position where you want the selected function to be switched ON and confirm by pressing **ENTER** (or one of the digi-adjustors).

The selected position is now memorised.

**Exception: Momentary switches „H“ and „M“:**

The momentary switches “H” and “M” are mounted on the case sides; they feature two modes of operation:

- Chage-over (toggle) „F“**  
Operate switch = function ON  
Operate switch again = function OFF  
Typical application: Timer

- Momentary „H“**  
Operate switch = function ON  
Switch not operated = function OFF  
Typical application: Teacher/Pupil, Throttle-cut

**Exception stick-top buttons:**

The optional stick-top with push-buttons features a total of three integral buttons:

- Top button KTa**  
The assigned function is ON as long as the button is pressed (momentary action)
- Pair of buttons on the side KSw**  
One (selectable) button switches the function ON, the other button switches the function OFF (toggle action).

**13.4. Sub-menu “Training”**

**13.4.1. Teacher/pupil operation**

The **ROYAL**evo „Teacher“ as well as „Pupil“.  
In **Teacher** mode the **ROYAL**evo can let the pupil control up to 5 functions..  
In **Pupil** mode 6 functions are supplied to the output, which can be accepted by a teacher transmitter.

**13.4.2. The ROYAL**evo as Teacher transmitter

Connect teacher and pupil with the cable #8 5121.  
The following transmitters can be used as “pupil”:  
**ROYAL**evo, Cockpit MM, Commander mc, EUROPA mc, PiCOLine, PROFI mc 3010/3030/4000  
Many older MULTIPLEX transmitters can also be used as pupil transmitter. If your pupil transmitter is not mentioned above, please ask our after sales service.

- Assign the teacher switch (➔ 13.3.5.). The assignment also determines the switch position for teacher enable.
- Change to sub-menu Training.



**Heli:** Roll, Pitch axis, Yaw, Coll. Pitch, --- (4 functions only)

"I>\*" means, switch I on the right-hand side (>) of the transmitter is assigned as teacher switch. The asterisk behind indicates: The switch is currently in ON position. **Assignments using Quick-Select (step 4.) can only be done if the switch is in this position and the pupil can control the already assigned functions.**

- Select  
Mode = **Teach.M**, if the pupil transmitter signal output is in MULTIPLEX format.  
Servo centre = 1,6 ms  
Mode = **Teach.U**, if the pupil transmitter signal output is in UNIVERSAL format.  
Servo centre = 1,5 ms
- Select the function, which the pupil shall control and press **ENTER**.
- On the pupils transmitter quickly move the stick axis (Quick-Select) to be used for the selected func-

tion. The corresponding channel number is displayed (e.g. K3 for aileron). Check the movement directions for all control surfaces. Wrong directions can be reversed by pressing **REV/CLR** (⇩ or ⇧).

**Attention:** Quick-Select is not possible, if the **ROYALevo** is switched on with "No RF".

Repeat steps 4. and 5. until all desired channels are assigned. Now you can return to the status display and start the training.

**Be careful when assigning throttle if your engine is running or the model is electrically powered!**

Make sure not to endanger other modellers, spectators or models by your engine bursting into life.

### 13.4.3. The **ROYALevo** as pupils transmitter

**Important:** If the **ROYALevo** works as pupils transmitter, the trims are not operative (the teacher will trim the model).

The following transmitters can be used as "Teacher":

**ROYALevo**, Commander mc, PiCOline, PROFI mc 3010/3030/4000

Some older MULTIPLEX transmitters can also be used as teacher transmitter. If your teacher transmitter is not mentioned above, please ask our after sales service.

1. Select the sub-menu training.
2. Select  
Mode = **Pupil M**, if the teacher transmitter needs signals in MULTIPLEX format.  
Servo centre = 1,6 ms  
  
Mode = **Pupil U**, if the teacher transmitter needs signals in UNIVERSAL format.  
Servo centre = 1,5 ms

**NOTE:**

If the **ROYALevo** is switched OFF without setting the training mode to OFF, it will directly go to the Training menu when you switch ON for the next time (safety).

## 13.5. Sub-menu "User"



### 13.5.1. Parameter „PIN“

global effect

The PIN can be used to protect the settings stored in your transmitter. If the PIN is activated, the operator can view the set values, but not change them.

PIN=0000

If you enter this PIN, the values in the transmitter are **not protected** against changes.

PIN = \*\*\*\* (four digits)

The PIN must contain at least one digit which is not „0“!

If you enter a PIN, the lock takes effect next time you switch the transmitter on. You can leaf through all the menus, but as soon as you attempt to change a setting, the following message appears:



If you enter the PIN correctly, the block is lifted. It is only activated again when you next switch the transmitter on.

### 13.5.2. Parameter „Language“

global effect

As standard the **ROYALevo** contains two language sets for use in display texts. The default for the primary language is ENGLISH, and this is selected as active language.

The second default language is GERMAN.

In the menu ↖, USER you can invoke the LANGUAGE parameter to select either of these two languages.

On the Internet (<http://www.multiplex-rc.de/>) you will find a link to the page **ROYALevo** INFO. On this page we will make alternative language sets available for you to download. These files can be installed in the transmitter using the **ROYALevo** PC program, and take their place as the second language.

### 13.5.3. Parameter „Name“

global effect

If your transmitter is new, you will find the name MULTIPLEX in this field. You can enter your own name of up to 16 characters. Your name then appears in status display 1 (→ 9.2.).

## 14. Main menu „Controls“ !

By transmitter **control** we mean all the physical control elements on the transmitter which are assigned to a model function. These may include sticks, sliders and switches. For instance, if you assign a switch for operating the tow-release, this constitutes a transmitter control. Which transmitter controls are present, and which elements are to be used to operate them, is determined in the menu ↖ -Assignment, Controls.

The Assignment Controls menu is **dynamic**, i.e. it displays only those controls which are used in the active model. If you are operating a simple model which only features rudder and elevator controls, the menu will look like this:



Section 14.2. informs you first which programmable characteristics (parameters) are possible for the individual transmitter controls. Paragraphs 14.2.1. to 14.2.10. describe the individual parameters in detail.

### 14.1. Sub-menu „Control switch“

- Affects active model only
- Range -100% to 100%
- Default 0% (control centre)

**always appears at the end of the controls list**

Transmitter control switches are used when you wish to trigger a switched process using a proportional transmitter control.

Example: motor run, electric motor

You wish the sum timer to start running as soon as the throttle is moved past the 1/4-throttle point.

To achieve this you must assign the same transmitter control to act as the sum timer switch as the one you use to control the motor.

If you use an analogue control such as a stick as a switch (or control E or F) the switching point can be defined at any point you wish.



## 14.2. Sub-menus for individual controls



### Transmitter controls for fixed-wing models

This menu only displays those transmitter controls which are used in the active model. This means that they are either assigned directly to a servo, or are used in one of the mixers you have set up. We term this a "dynamic menu".

The menu point Transmitter control switch (→ 14.1.) is always displayed.



### Transmitter controls for helicopters

This menu always displays the transmitter control switches (→ 14.1.) and the transmitter controls Aileron (ROLL), Elevator (PITCH-AXIS), Rudder (YAW), COLLECTIVE PITCH and THROTTLE.

The other optional transmitter controls - retracts, gyro, tow release, brake and AUXx - only appear if they are assigned to the active model.

### Overview of transmitter controls

If you see **4x** after an available parameter in the table below, this means that you can set a different value in all four flight phases. Transmitter controls which have the same parameters are grouped together.

Control	available parameter	Notes
---------	---------------------	-------



Aileron	Trim 4x	display only
Elevator	Step	0.5/1.5/2.5/3.5%
Rudder	D/R	0% to 100%
	Trvl 4x	0% to 100%
	Expo	-100% to +100%
Throttle	T. cut	display only
	Idle	display only
	Step	0.5/1.5/2.5/3.5%
	Slow	0.0 to 4.0 sec
Spoiler	Run time	0.0 to 4.0 sec
Flap	Fixed val.4x	OFF, -100% to +100%



Aileron	Trim 4x	display only
Elevator	Step	0.5/2.5/2.5/3.5%
Rudder	D/R	0% to 100%
	Trvl 4x	0% to 100%
	Expo	-100% to +100%
Coll. pitch	6-point-Coll.curve4x	Collective: -100% to +100%
Throttle	Min.	Thr-Minimum 0% to 100%
	5-point-Thr.-curve 4x	Throttle: 0% to 100%
RPM	Run time	0.0 to 4.0 sec
	Fixed val.4x	OFF, -100% to +100%
Thr. limiter	-	No adjustments



Retract	run time	0.0 to 4.0 sec
Tow hook	-	No adjustments
Brake	-	
Gyro	-	
AUX 1	-	No adjustments
AUX 2	-	

### 14.2.1. Control settings for the primary axes



Aileron, Elevator, Rudder



Aileron (Roll), Elevator (Pitch axis), Rudder (Yaw)

The transmitter controls for the primary axes are all shown in the same manner, and also share the same parameters (→ 14.2.2. to 14.2.6.).

Displaying them in the form of a graph allows changes in the settings to be assessed immediately, and makes it obvious how that transmitter control functions.

The illustration below is an example, and shows the graph for the transmitter control Aileron.



In addition to the parameters you will see two further items of information:

a. The small dash after the parameter name indicates that this value can be assigned to one of the 3-D digi-adjustors, in which case it is variable in flight.

Expo - -90%

b. The small number (1 to 4) after the parameter name indicates that this can be set to a different value for each of the four flight phases.

Trim 1 2.0%

Some parameters can be assigned to a 3-D digi-adjustor, and are also variable separately in each flight phase. In this case both symbols appear.

Trvl 1 -90%

**14.2.2. Parameter „Trim“**

- 👁 display only
- change using cruciform trim buttons

- 📄 one trim value for each flight phase

The value of this parameter indicates the extent of the trim for this control, i.e. the magnitude and direction of the trim correction. It is calculated from the increment size TStep and the number of trim steps used. If the largest increment size (3.5%) is selected, the trim travel can be up to 70% in each direction.

**14.2.3. Parameter „Step“ (trim increment)**

0,5% – 1,5% – 2,5% – 3,5%

Only these four values can be selected for the trim step. The number of trim steps is +/- 20, giving trim range values of +/- 10%, +/- 30%, +/- 50% and +/- 70% respectively

**14.2.4. Parameter „D/R“ (Dual-Rates)**

- ⊗ can be assigned to a 3-D digi-adjustor
- 10% to 100%

Dual Rates enable the user to change the control sensitivity of the model. For example, if the Dual Rate parameter is set to 50%, you can reduce the model's control surface travels to half of normal by operating the assigned switch.

**14.2.5. Parameter „Trvl“**

This parameter is used to determine the percentage of full servo travel which can be obtained using the associated transmitter control.

**14.2.6. Parameter „Expo“**

- ⊗ can be assigned to a 3-D digi-adjustor
- 100% to 100%, 0% = OFF

This parameter allows you to assign an exponential characteristic to the transmitter control. If Expo is 0%, the transmitter control is linear in effect. Negative Expo values have the effect that control in the area around the centre position produces reduced control surface travels, giving you fine control around neutral. Positive Expo values have the opposite effect: the control surface travels are greater around the centre position.

The Dual Rates function (→ 14.2.3.) reduces total servo travel, whereas Expo does not change the end-points. This means that full travel is always available when required.



**14.2.7. Parameter „Fixed value“**

- 📄 separately variable for each flight phase
- ⊗ can be assigned to a 3-D digi-adjustor
- 100% to 100%, 0% = OFF

This parameter is used to generate control surface travels which cannot be changed by the associated transmitter control.

A typical example for this function is a fixed flap position for launching the model. When you switch on the LAUNCH flight phase, the flaps are required to move automatically to the launch position. In NORMAL flying

the flaps are controlled using a transmitter control (e.g. slider F) in the normal way.



**14.2.8. Parameter „Run time“ (Slow)**

- ⊗ can be assigned to a 3-D digi-adjustor
- 0.1 to 4.0 s

The run time parameter allows you to determine the time over which a transmitter control moves from one end-point to the other. This enables you to set up gradual travel of any control system, even if it is triggered by a switch.

Examples:

Extending **retractable undercarriage slowly**, so that the process operates at scale speed.

Lowering or raising **flaps slowly**, so that the model does not make any abrupt movements when you change the flap setting.

**14.2.9. Parameter „Idle“ (idle trim)**



**Throttle control only**

This function alters the operation of the idle trim, as the name indicates. From the graph in the ↓ Throttle menu you will see that the throttle trim only affects the range up to centre (1/2-throttle). The area from centre to full-throttle is not affected.

**14.2.10. Parameter „Collective pitch“ (Coll. pitch curve)**



- 📁 affects the active model only
- Range +/- 100%

- 📄 one coll. pitch curve for each flight phase

- ⊗ each curve point can be assigned to a 3-D digi-adjustor (→ 10.2.2)

Adjusting the collective pitch curve for helicopters is done in the menu ↓ Control/Collect. Each flight phase can have a separate curve, to adopt the curve to each individual phase.

**Example 1: Coll. pitch curve phase Hover**

„Flattened“ curve between hover and collective pitch-minimum for more sensitive hovering and landing.





**Example 2:** Coll. pitch curve phase **Cruise**  
(linear, symmetrical coll. pitch curve for identical reactions during climb and descend)

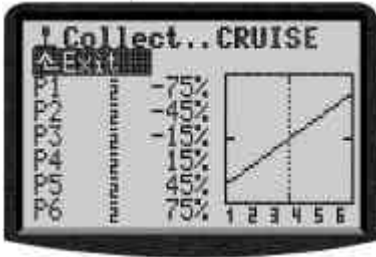

The **ROYAL**evo offers a 6-point coll. pitch curve. The advantage of such a curve is: Not too many points to adjust. "Flat" curve for hovering in normal and reversed flight possible.

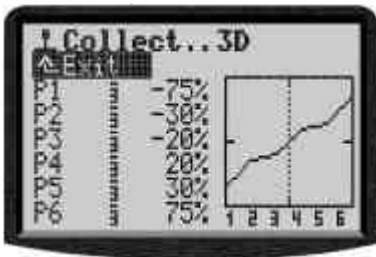

**14.2.11. Parameter "Throttle" (Throttle curve)**



- affects the active model only  
Range 0 - 100%
- one throttle curve for each flight phase
- each curve point can be assigned to a 3-D digi-adjustor (→ 10.2.2)

Adjustment of the throttle curve is done in the menu **↓ Control/Throttle**. Each flight phase can have a separate curve with 5 points to adopt the curve to each individual phase. The goal is to stabilize the RPM count for the system in all situations.

**Example 1:** Throttle curve phase **Hover**



**Example 2:** Throttle curve, phase **Acro**  
(symmetrical, V-shaped throttle curve to increase throttle in normal **and** reversed flight)

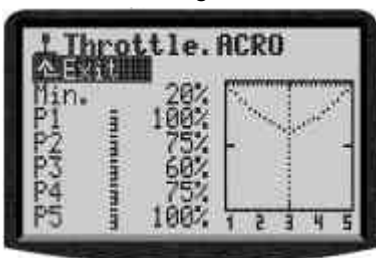

**Throttle curve for Autorot(ation)**

The flight phase named **Autorot** (phase 4 as standard, highest priority) has a fixed throttle position ("safe" idle with open clutch or motor OFF) for the training of autorotation landings.

The points P1 ... P5 can't be adjusted separately. Changing one of the points will affect all the others too.



**Parameter Min. (Idle) Throttle limiter**

The parameter **Min.** determines the RPM count, if the throttle limiter is set to min. or idle (to start the motor). The parameter is independent of the flight phase.

The horizontal dotted line in the diagram shows for all phases the position of the throttle limiter. The throttle value is limited and no higher throttle can be achieved, independently of the flight phases:

**TIP:**

To adjust the carburettor (parameter **Min.**) move the throttle limiter to idle. Changing the **Min.** value moves the dotted line and makes the value visible in the diagram.



**14.2.12. Parameter „RPM“ speed regulators**



Control signal for speed regulators

- affects the active model only  
Run time 0,0 to 4,0 sec
- a fixed value for each flight phase
- Fixed value and run time can be assigned to a 3-D digi-adjustor for modifications during the flight (→ 10.2.2)

With RPM a predefined number of rotations per minute (RPM) can be set. This works also if **no control** is assigned to FLAP/RPM.

If you assign a control to this function the regulator can be switched off if you move the control to idle.

## 15. Main menu „Mixers“ Σ

The Mixers main menu is a **dynamic menu**, i.e. only those mixers which are used in the current model also appear in this menu.

### Exception for fixed-wing models:

The mixers Combi-Switch and A-Diff (aileron differential) are always present.



### Helicopters:

No free mixers can be defined for helicopters.

**All** the helicopter mixers are **always** present in this menu.

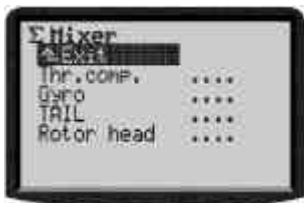

### 15.1. Sub-menu „Combi-Switch“

- ✉ Aileron → Rudder (Aileron is master) 2 to 200 %
- Aileron ← Rudder (Rudder is master) -2 to -200% increments of 2%, switchable

Smooth turns can only be flown if aileron and rudder are operated simultaneously; this applies to models just as it does to full-size aircraft. Combining two controls is not easy for the less skilled pilot, and the Combi-Switch can be a great help, as it “combi”nes, or couples, aileron and rudder, making it much easier to fly smooth, accurate turns.

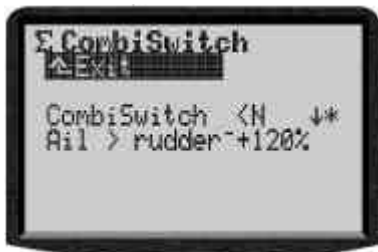

The physical Combi-Switch is selected in the menu ↘, ASSIGNMENT, SWITCH, and is only shown here as a point of information. The arrow after it indicates the ON position of the switch, i.e. Combi-Switch ON back or forward.

In the bottom line you can set the degree to which the Slave follows the Master (2% to 200%). The prefix determines the direction of following (+ means: aileron is Master). You can also select OFF, which disables the Combi-Switch completely.

The Combi-Switch can also be switched off using the REV/CLR button.

### 15.2. Sub-menu „A-Diff“ (aileron differential)

- ✉ affects active model memory only
- Range +/- 100%
- Prefix reverses direction (up/down)
- Default OFF
- Can be suppressed by spoilers (mode +SPOILER)

Differential means that the ailerons deflect further when they move up than when they move down. Differential travel reduces the problem of “adverse yaw”.

If you set differential to 100%, the ailerons deflect only (“split” mode).



#### 15.2.1. Parameter „Mode“

This parameter affects **all** flight phases. Here you can activate differential (ON) or disable it (OFF). If you select +SPOILER as mode, the differential is suppressed when you extend the spoilers, to restore some of the lost roll response.

#### 15.2.2. Parameter „Diff.“

📄 Flight phase dependent

⊗ can be assigned to a 3-D digi-adjustor

If you wish to reduce differential to zero for a particular flight phase, you must activate this flight phase and set the Differ parameter to 0%. The screen then displays OFF.

The active flight phase is displayed in the top line, and by the number preceding the parameter.

### 15.3. Submenu „Gyro“



The **ROYAL**evo’s Gyro mixer can be used for fixed-wing models as well as helicopters, i.e. it is suitable for use with any model fitted with a gyro system with a separate input for gyro gain adjustment from the transmitter.

The **ROYAL**evo’s gyro mixer incorporates completely new thinking. It is designed to achieve optimum stabilisation around one model axis using a simple gyro as well as a modern heading-hold gyro, under all conditions and in all situations. The **ROYAL**evo’s gyro mixer achieves this by offering a number of operational modes. We recommend that you start with the “Transmitter control” mode, as this makes it easier to get to know the basic functions (→ 13.3.1.).



#### Note 📌: Aileron stabilisation

For fixed-wing model aircraft we assume that the gyro system is intended to stabilise the model’s longitudinal axis (aileron).

#### Note 📌: Yaw stabilisation (tail rotor)

For model helicopters we assume that the gyro system is intended to stabilise the model’s vertical axis (yaw / tail rotor).

The following table shows the characteristics of the two gyro systems which are in common use today.

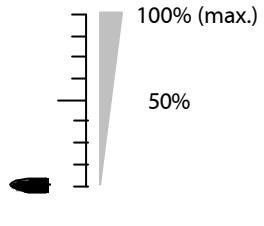
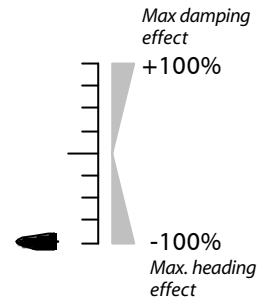
Damping gyro (normal gyro)	Heading-lock gyro
The gyro damps (slows) the rotational movement of the model around the axis to be stabilised.	The gyro damps (slows) the rotational movement of the model around the axis to be stabilised, and also moves the model back to its starting point. You can select either heading-lock or damping mode as the starting point, according to preference.
Gain range 0 ... 100%: 	Gain range -100 ... +100%: 

**15.3.1. Parameter „Mode“**

 Affects active model memory only

The **ROYAL**evo provides three different gyro modes:

**Control** The transmitter control Gyro (must be assigned) controls gyro gain independently of the position of the flight phase switch. Can be suppressed by yaw command. The adjustment range is -100% to +100%.

**Damping** Two different gain settings can be set for each flight phase. The switch Mix-1 is used to switch between the settings. Can be suppressed by yaw command. The adjustment range is 0% to +100%.

**Heading** Two different gain settings can be set for each flight phase. The switch Mix-1 is used to switch between the settings. The adjustment range is -100% to +100%.

**0% to +100% setting**

The gyro works as a damping gyro. Can be suppressed by yaw command

**0 to -100% setting**

The gyro works in heading lock mode. No suppression required.

In each flight phase the switch Mix-1 can be used to select heading lock or damping mode.

**Mode: Control**

In this mode gyro gain is controlled manually by the transmitter control Gyro. In the model templates this is the slider E. This mode of operation is possible with all gyros which feature an input for gain control. These also include heading-lock gyros.

Gyro suppression is possible (→ 15.3.3).

**Mode: Damping**

Gyro gain is selected using the parameter Damping (Gyro gain). Separate values can be set for each flight phase. This allows gyro gain to be varied to suit any flight task or flight phase.

**Application:**

Fixed-wing models and helicopters which are fitted with a normal gyro.

Gyro suppression is possible (→ 15.3.3).

**Mode: Heading**

Gyro gain / mode of operation is selected using the parameter Damping / Heading (Gyro gain). Separate values can be set for each flight phase. This mode provides the means to adjust gyro gain to the optimum setting for any flight task or flight phase.



If the pilot of a fixed-wing model switches to a gain range (→ 15.3.2.) of 0 ... -100% (⇒ Heading) within a particular flight phase, yaw trim is automatically switched off. Trim changes now affect a separate yaw trim memory, designed to carry out minor corrections (temperature drift). This trim value is used in every flight phase in which the operating mode Heading is invoked. This trim facility is shown in Status displays 1-3. The parameter Trim (→ 14.2.2.) also shows exclusively the trim setting in the operational mode Damping, according to the flight phase.



With a model helicopter it is also possible to switch between two values for gyro gain (→ 15.3.2) within a particular flight phase.

**Requirement:**

At the Assignment stage a switch must be assigned to the mixer switch Mix-1 (→ 13.3.4).

If the pilot of a model helicopter switches to a parameter with a gain range of 0 ... -100% (⇒ Heading):

- yaw trim is automatically switched off. Trim changes now affect a separate yaw trim memory, designed to carry out minor corrections (temperature drift). This trim value is used in every flight phase in which the operating mode Heading is invoked.

This trim facility is shown in Status displays 1-3. The parameter Trim (→ 14.2.1.) also shows exclusively the trim setting in the operational mode Damping, according to the flight phase.

- The static tail rotor compensation (→ 15.4) is switched off.

**Application:**

Fixed-wing models and helicopters fitted with a heading-lock gyro.

Gyro suppression is possible (→ 15.3.3). However, this is only effective if the gyro is operated in Damping mode (gyro gain 0 .. +100% ⇒ Damping).

**15.3.2. Parameter „Heading / Damping“ (Gyro gain)**

**In the gyro mode Control:**

Gyro gain can only be adjusted manually using the transmitter control Gyro (→ 15.3.1 Mode → Control). The set value of the Heading / Damping parameter (gyro gain) has no effect in this gyro mode.

**In the gyro mode Damping:**

- 📁 is effective in the active model memory
- 📄 allows separate values to be set for each flight phase  
Range 0 ... +100%
- ⊗ can be assigned to 3-D digi-adjustor

The value for the parameter Damping (gyro gain) can be set separately for each flight phase. The transmitter control Gyro has no influence on the set values (→ 15.3.1 Mode → Damping).

**In the gyro mode Heading:**

- 📁 is effective in the active model memory
- 📄 allows two separate values to be set in each flight phase, and called up using the Mix-1 switch  
Range -100% (Heading) ... +100% (Damping)
- ⊗ can be assigned to 3-D digi-adjustor

Two values for gyro gain can be set for each flight phase. The switch Mix-1 is used to switch between the settings (→ 15.3.1.).

**TIP:**

If you only want to be able to call up one gain setting in a particular flight phase, regardless of the position of the switch Mix-1, simply set the same values for both switch positions.

The control Gyro has no influence on the set values.

**Note when using the gyro mixer in Heading mode:**

Before you operate the model, check carefully that the gyro is working in accordance with the gain range you have set

1. Activate a flight phase in which the gain range is 0 ... -100% (Heading).
2. Move the yaw (tail rotor) stick to either end-point then back to neutral (centre).

If the yaw / tail rotor servo moves back to its starting point, the gyro is working in Damping mode => the direction of rotation of the Gyro channel must be reversed (→ 16.1.1)

**15.3.3. Parameter „Suppression“**

- 📁 affects the active model memory  
Range 2% ... 200%, increments of 2%
- ⊗ can be assigned to 3-D digi-adjustor

The Suppression parameter is designed to provide a user-variable linear reduction in gyro gain when the associated transmitter control is moved to full travel. This prevents the gyro system counteracting a deliberate control command.

Values from 2% to 98% reduce the gain, but do not suppress the gyro fully.

Values from 102% to 200% invoke full suppression before the yaw stick reaches its end-position.

Suppression works in all gyro modes (Transmitter control, Damping, Heading) using the same value, regardless of flight phase.

Exception:

If gain is in the range 0 ... -100% (Heading).

**Note**

Many gyro systems feature their own suppression function. In this case the suppression provided by the transmitter must not be activated (Suppression => OFF). Please read the operating instructions supplied with the gyro.

**15.4. Sub-menu „Tail rotor“**

(static tail rotor compensation/Revo-Mix)

The **ROYAL**evo's Tail rotor mixer provides what is known as "static tail rotor compensation". If the pilot sends a command to the hovering helicopter causing it to climb or descend, the torque which the tail rotor has to counteract increases or reduces accordingly, and the model reacts by swinging around its vertical axis. If correctly set up, this mixer compensates for torque changes. This helps to prevent the model swinging, and also eases the work of the gyro system, with the net result that a high level of stabilisation is possible. Four parameters are required for this:

Collective Pitch+, Collective Pitch-, Offset, Zero point



**Notes**

Before you start setting up this mixer all the settings which involve the rotor head must be completed, including the collective pitch curves. Before you make any fine adjustments during the test flying programme the throttle curve must be set up accurately. If you subsequently alter the throttle curve it is usually necessary to correct the Tail rotor mixer settings too.

**If you use a heading lock gyro the TAIL rotor mixer must not be used or must be switched OFF!** Please read our notes regarding the GYRO mixer (→ 15.3.).

**Preparation:**

- The servo TAIL must be assigned in the menu \* Servo / Assignment (→ 16.2.), otherwise the TAIL mixer will not appear in the menu Σ Mixers.
- When calibrating the Tail servo a 2-point calibration is sufficient (→ 16.1.). However, **it is important** to ensure that the servo is not mechanically obstructed (stalled) at either end-point (P1, P5).

**15.4.1. Parameter „Collective Pitch+ and -“**

- 📁 affects the active model memory
- 📄 Separate value for each flight phase  
Range -100 ... +100%
- ⊗ can be assigned to 3-D digi-adjustor

The parameters Collective pitch+ / Collective pitch- are used to set the mixing ratio for collective pitch -> tail rotor for climb and descent. These values can be set separately for each flight phase:

- CollP.+ → Correction for climb
- CollP.- → Correction for descent

**15.4.2. Parameter „Yaw diff.“**

- 📁 affects the active model memory
- 📄 separate value for each flight phase  
Range -100 ... +100%
- ⊗ can be assigned to 3-D digi-adjustor

The parameter Yaw diff. is designed to reduce the tail rotor travel in one direction. This may be necessary if your model behaves differently when yawing to left or right (rotational speed). A separate value can be set for each flight phase.

**15.4.3. Parameter „Offset“**

- 📁 affects the active model memory
- 📄 separate value for each flight phase  
Range -100 ... +100%
- ⊗ can be assigned to 3-D digi-adjustor

There will be some torque at 0° collective pitch (main rotor), which means that a slight pitch angle (= Offset) of the tail rotor blades is necessary even at this setting. This value can also be set separately in each flight phase; this will be necessary if you set a different system rotational speed in each phase. In the flight phase Auto-rotation the Offset can be changed so that the tail rotor exhibits no pitch. This is especially important if your model features a driven tail rotor in auto-rotation mode.

**15.4.4. Parameter „Zero point“ and Coll.Pitch display**

- 📁 Affects the active model memory  
Range -100 ... +100%
- ⊗ Can be assigned to 3-D digi-adjustor

The Zero point parameter allows you to set the collective pitch stick position at which the collective pitch -> tail rotor mixer starts to take effect. For climbing the value is set under **Coll.+**. In the other direction (descent) the mixer takes effect with the value set under **Coll.-** (→ 15.4.1).

**Procedure:**

1. First set the starting point for the TAIL mixing. Move the collective pitch stick to the hover position. Set the parameter **Zero point** to the same value as indicated under **Collect.**
2. The parameter Collective pitch simply supplies information, and therefore cannot be changed; it just indicates the current collective pitch position. Transfer the value shown under Collective pitch to the parameter Zero point.

**15.5. Sub-menu „Rotor head“**

(electronic swashplate mixer/CCPM)



The **ROYAL**evo features a swashplate mixer (CCPM) which can be set up for any swashplate type (up to 4 actuation points or servos) for which electronic mixing is required. Three parameters are required for this:

Geometry, Rotation, Lever +/-



**Preparation:**

If the Rotor head mixer is to appear in the menu Σ Mixers, the following servos must be assigned in the menu Servo/Assignment (→ 16.2) in accordance with the swashplate type:

Servo	Note
Head f/b	Swashplate servo front/back
Head le	Swashplate servo left
head ri	Swashplate servo right
Head 4	For 4-point linkage only

The servo assignment sequence is freely variable.

<b>Example 1:</b>	3-point 120° swashplate
Geometry	+120°
Rotation	+0°
Lever +/-	0%

<b>Example 2:</b>	4-point 90° swashplate
Geometry	-90°
Rotation	+0°
Lever	0%

**15.5.1. Parameter „Geometry“**

- ☞ affects active model memory
- Range 90 ... 150° / -91 ... -150°
- Default +120°

The parameter Geometry defines the angle between the swashplate servo Head f/b and the servos arranged symmetrically to it, i.e. Head le and Head ri.

**Attention:** The angle must be entered with a **negative** prefix if the servo Head f/b is **at the front** (in flight direction) (Ex. 2).

**15.5.2. Parameter „Rotation“**

- ☞ Affects active model memory
- Range -100 ... +100°
- negative → clockwise,
- positive → anti-clockwise
- Default 0°

The parameter Rotation (also termed virtual swashplate rotation) is required,

- if the swashplate in the model is installed physically in such a way that the servo Head f/b is not located on the model's centreline
- if the model rolls when a pitch-axis command is given.

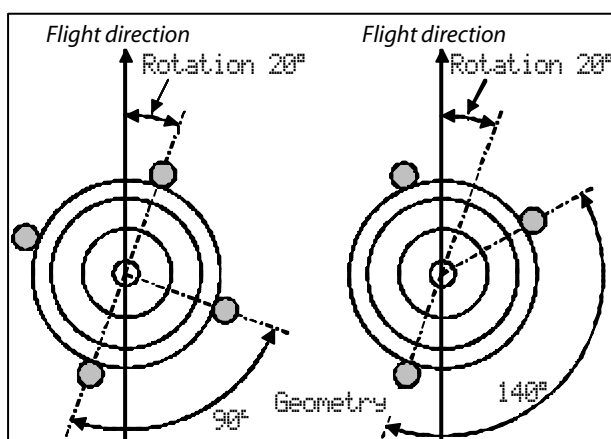

**15.5.3. Parameter „Lever +/-“**

- ☞ affects active model memory
- Range -100 ... +100%
- Default 0%

The parameter "Lever +/-" is only needed if your model has a 3-point swashplate whose design dictates that the actuation points are not equi-distant from the rotor shaft axis.

The radial spacing ratio (centre rotor shaft -> actuation point) of the servo Head f/b is adjusted relative to the two lateral servos Head le and Head ri in the form of a percentage, where the lateral lever lengths are 100%.

**Example:**

- Spacing Head f/b: 40mm
- Spacing Head re (li): 50mm (=100%)

The lever for Head f/b is 20% shorter than the lateral levers..

⇒ Correct setting: Lever +/- -20%.

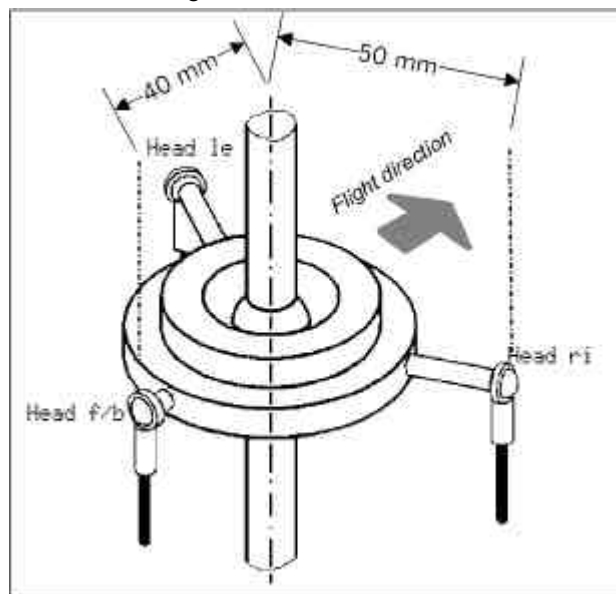

**TIP:**

Once you have entered the mechanical values for the swashplate of your model into the Rotor head mixer in the form of parameters, the next step is to calibrate the rotor head servos carefully in the menu ☞ Servo / Calibration (→ 16.1) You cannot expect the control system to work accurately unless you calibrate the servos exactly. You can check the direction of rotation of the servos by applying collective pitch control commands. If any servo does not run in the correct "sense" (direction), simply reverse its direction of rotation. At the servo calibration stage you may find it helpful to disconnect the pushrods from the swashplate to the rotor head, as this makes it easier to calibrate the maximum travels (P1, P5). The control travels can be adjusted once you have completed this stage; this is carried out in the menu ⊥ Control (→ 14.2.4. Aileron / Trvl., Elevator / Trvl., → 14.2.9. Collect. (Collective Pitch Curve).

**15.5.4. Helicopters HEIM mechanics**

To program a helicopter with HEIM arrangement proceed as follows:

1. Use the template "HELIccpm"
2. Assign HEAD f/b as servo 9. This servo is not used in the model. It serves to activate the head mixing.
3. Assign Elevator (pitch axis) to the original HEAD f/b servo.
4. In the mixer Rotor head set the parameter geometry to 90°. The servos HEAD le and HEAD ri will now be controlled by Collective pitch and Aileron (Roll) only.

## 15.6. Sub-menu „Throttle compensation“



✉ affects the active model memory  
Range 0% to 100%  
Default OFF

⊗ Each value can be assigned to a 3-D digi-adjustor for in-flight adjustment (→ 10.2.2)

The purpose of the throttle compensation mixer is to maintain constant system rotational speed in model helicopters. Collective control movements (collective pitch), large cyclic control commands (roll and pitch-axis) and major tail rotor control commands (as are used especially in aerobatics) all affect system rotational speed, and these changes are unwanted. This mixer is used to compensate for each change separately. The final settings for the mixer values can only be found during the test-flying programme. In most cases values in the range 10 - 20% are required.

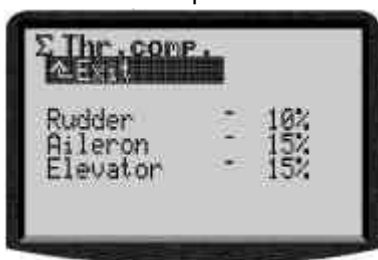

### 15.6.1. Parameter „Rudder“ (Yaw)

Range +/-100%,  
Default OFF

Yaw control commands which increase the tail rotor blade pitch angle require a linear throttle increase up to the maximum set value at full deflection.

Yaw control commands which decrease the tail rotor blade pitch angle require a linear throttle reduction up to the maximum set value at full deflection.

Positive and negative values are required for this parameter because the tail can move with or against the direction of the main rotor. Throttle must be increased or decreased accordingly.

### 15.6.2. Parameter „Aileron“ (Roll)

Range 1% to 100%,  
Default OFF

Roll control commands (both directions, right **and** left) require a linear throttle increase up to the maximum set value at full deflection.

### 15.6.3. Parameter „Elevator“ (Pitch axis)

Range 1% to 100%,  
Default OFF

Pitch-axis control commands (both directions, forward / back) require a linear throttle increase up to the maximum set value at full deflection.

## 15.7. Setting up “free mixers”



The term “free mixers” means the mixers which are defined in the menu Setup/Mixer (→ 13.2). The mixers defined there (max. 14) can then be adjusted in the menu \* Mixers to meet the requirements of your particular model.

### Note

The mixers defined in the menu Setup/Mixer def (→ 13.2) are only available for use with fixed-wing models - not with model helicopters.

In the interests of clarity the Σ Mixer menu only lists those mixers which are used in the currently selected model, i.e. which you have already assigned in the menu Servo/Assignment (→ 16.2):



The Combi-Switch and Aileron differential mixers are always listed.

The next section explains how to set up a “free mixer” using the example of the AILERON+ mixer, which is defined by default and is used in several model templates.



The example shows how to set up the mixer AILERON+ (-> the various control deflections of the ailerons) as they may be required on a model glider (4-flap wing).

### What does the menu show?

#### Mixer values

The lower five lines show the mixer inputs and the transmitter controls (which operate the control surface/s) according to the mixer definition.

#### Values

The next two columns display the mixer values (1 or 2) of the associated mixer input. Only these values can be changed in this menu.

#### “Dynamic heading”

Line 3 of the menu displays a “dynamic heading” which varies according to the input at which the cursor is positioned. The heading provides additional information about the current input.

Column 1 (above input)	Shows the mixer option assigned to the mixer input in the form of a symbol (→ 13.2.3)
Column 2+3	Show the type and effect of the mixer values.
Column 4	Indicates whether the mixer input can be switched off; if so, which switch is used, and the current switch status: Asterisk * mixer input = ON Arrow shows ON position of switch (if input is OFF)

**Example:**

The input (transmitter control) Aileron (primary input) affects the aileron servo(s) symmetrically relative to the servo centre, with a travel setting of 80%.



**Example:**

The input (transmitter control) Ele -Tr (Elevator, no trim) affects the aileron servo(s) asymmetrically relative to the servo centre (snap-flap). The travel setting is 30% in one direction, 20% in the other. The mixer input can be switched off using switch G. The current switch status is ON (asterisk \*), i.e. the input is activated.



**16. Main menu „Servo“**

affects active model memory

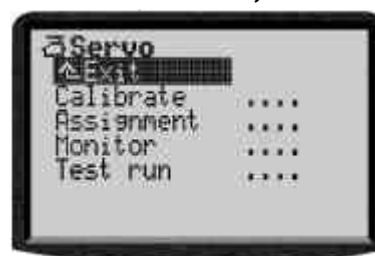

**16.1. Sub-menu „Calibrate“**

In “Calibrate” you can adjust the travels, centres and - if required - intermediate points for all servos, to ensure that the servos move identically and evenly, and reach the required end travels.



All changes to the parameters REV/TRM and the servo calibration points P1 ... P5 are shown immediately in the graph, making it easy to understand the effect of the changes you make.

Line 1 always displays the name (function) of the servo. The channel number (receiver output) of the selected servo is shown above the graph.

Below the graph (X-axis) the numbers 1 ... 5 correspond to the servo calibration points P1 ... P5.

**16.1.1. Parameter „REV/TRM“**

The first parameter REV/TRM has two functions:

1. Servo reverse (**REV**) changes the direction of rotation
2. Servo trim (**TRM**)

**Servo reverse REV**

To reverse the direction of servo rotation simply select the parameter value and press the **REV/CLR**-button:

⇒ the curve is “reversed”

⇒ the prefix changes

(only if the value of the parameter TRM ≠ 0)

**Servo trim TRM**

Servo trim is used to compensate for variations from the nominal neutral position of one control surface. A correction may be necessary with servos, for example, which do not feature adequate temperature compensation, and whose neutral position tends to vary.

The value for TRM operates on the standard trim principle, i.e. the set trim value works as an offset on all calibration points P1 ... P5, thereby effecting a parallel shift



of the curve. The shape of the curve is unchanged. This is the same as with the standard trim option.

Use servo trim TRM only to correct deviations in a servo's neutral position which you discover when setting up the model. Don't use it to trim a new model: the mechanical linkage should always be adjusted as accurately as possible.

**16.1.2. Parameter „P1 ... P5“**

Adjusting the servo calibration points (parameters "P1 ... P5") can be useful in several ways. In detail these are:

- Defining the maximum working range of the servo  
*The servo travels never exceed the values (servo travels) you set here.*  
*(guards against the servo being stalled mechanically)*
- Setting symmetrical control surface travels
- Adjusting the travels of several servos to match each other.  
*This avoids the risk of mutual stalling, i.e. when two (or more) servos are actuating the same control surface.*
- Compensating for mechanical differences in the control surface linkage  
*For example, if the flaps of a multi-flap wing do not move through exactly the same deflections, the travels can be matched to each other by adjusting the intermediate points P2 and P4.*

Careful calibration is important, especially in the case of servos to which a mixer has been assigned.

**Note:**

Servo calibration should only be used for fine adjustment; it is not a remedy for an inaccurate mechanical linkage. Always set up the mechanical system accurately as the first step. On no account reduce the maximum servo travels (P1 and P5) by more than about 10 - 20%, otherwise you effectively reduce the maximum power of the servo, and the effect of any lost motion in the servo gearbox is amplified.

**This is the procedure for calibrating a servo:**

**1. Servos, controlled by basic (non-mixed) functions**

(Aileron, Elevator, Rudder, Undercarriage, ...):  
First ensure that the direction of servo rotation (control surface travel) is in the correct "sense". If necessary change the sense of rotation in the parameter **REV/TRM** (→ 16.1.1.). If you subsequently reverse the servo, you will need to repeat the calibration procedure.

**Servos, controlled by mixers**

(AILERON+, DELTA, V-TAIL, ...):  
If you have assigned a mixer to the servos the direction of servo rotation is not relevant. The correct direction for the control surface travel is set in the mixer itself.

2. Select the value of one of the points (P1 to P5). Now press the digi-adjustor assignment button < [Digi-Adj] >. The servo automatically takes up the position of the selected calibration point and remains there. With one hand you can now easily and conveniently measure and check the travel (ruler, calliper); the other hand remains free, and can be used to adjust the value using the UP/DOWN buttons ▲ / ▼ or one of the two 3-D digi-adjustors.

If the deflection is correct, press the digi-adjustor assignment button < [Digi-Adj] > again. The servo moves to the position given by the current position of the corresponding control.

The number of variable servo calibration points (min. 2, max. 5) varies according to the setting you selected under Servo Assignment (→ 16.2).

**TIP: Vertical dotted line for orientation**

The vertical dotted line always shows the current servo position, to help you understand "where you are". Pressing the digi-adjustor assignment button < [Digi-Adj] >(\*), or moving the transmitter control associated with the servo or servos, releases the servo again at the selected calibration point. The servo takes up the position corresponding to the position of the associated transmitter control(s).

**16.2. Sub-Menu „Assignment“**

affects the active model memory

**free assignment of servos**

assignments in the model templates for MULTIPLEX or other standards

all 9 (or 12) servos are shown in the list

As with the MULTIPLEX PROFI mc 3000 and 4000 series of radio control systems, the **ROYAL**evo offers the facility to define the sequence, or order, of the receiver outputs - with no restrictions. Compared to radio control systems with a fixed receiver output sequence this provides the advantage that, for example, the signal for a second aileron servo (usually generated on the "high" channels, e.g. channel 5) can be assigned to any channel you wish. This makes it possible to use two aileron servos even with a small 4-channel receiver.

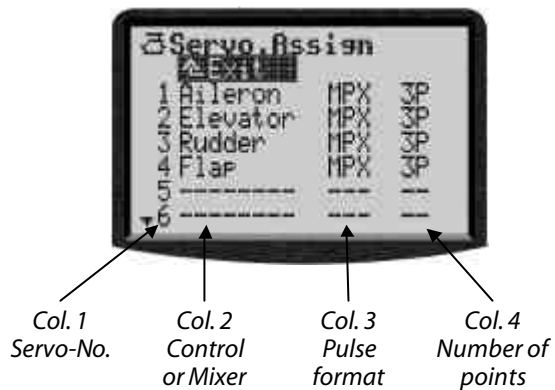

Details see table on the right-hand side.

**This is the assignment procedure:**

1. Select a servo, then press the 3D digi-adjustor
2. Select function (control or mixer), then press the 3D digi-adjustor
3. Select pulse format (or leave it as it is), then press the 3D digi-adjustor
4. Select the number of calibration points, then press the 3D digi-adjustor

The cursor jumps back to the selected servo number. Assignment is finished for this servo.

**This is the procedure to cancel assignments:**

1. Select a servo, then press the 3D digi-adjustor
2. Press the **REV/CLR** button, then press the 3D digi-adjustor

**Table for the menu Servo Assignment**

Col. 1	<b>Channel / Servo number</b> ROYALevo 9 ⇒ max. 9 channels ROYALevo 12 ⇒ max. 12 channels The transmission mode (PPM 7/8/9 or PPM 12) is set automatically.
Col. 2	<b>Signal source</b> Here you select the transmitter control or mixer which is to be present at the corresponding channel. " - - - " means that the channel is not used. In this case a neutral pulse is supplied to the receiver output.
Col. 3	<b>Servo signal format</b> A format (MPX / UNI) has already been selected when you initially set up your new model (→ 18.6). If not all the servos (or other devices) connected to the receiver are designed to work with this signal format, you can make the appropriate change at this point.
Col. 4	<b>Servo calibration points</b> Here you define how many calibration points are to be available in the Servo calibration menu (→ 16.1.). 2P 2 points (e.g. for throttle, tow release) 3P 3 points (e.g. elevator, rudder) 5P 5 points (if a non-linear travel is to be compensated or required)

**16.2.1. Special: MULTInaut IV**



**The MULTInaut function is available only for fixed wing models!**

The **ROYALevo** can control two MULTInaut IV receiver units. This enables control of up to 8 loads (lamps, relays, ...) and/or up to 8 servos in different operating modes.

In the menu Servo Assignment you determine, to which channels (receiver output) the MULTInaut signal is supplied. The MULTInaut receiver units in the model must be connected to the same channels (receiver outputs).

**Using MULTInaut IV** → 19.4.

**16.2.2. Assigning servos for fixed wing models**

The following transmitter controls / mixers are available, depending on the model type (fixed-wing / helicopter):



**Model type „fixed wing“**

	Note	
Aileron	Aileron signal only	No mixing *
Elevator	Elevator signal only	No mixing
Rudder	Rudder signal only	No mixing
Throttle	Throttle signal only	No mixing
Spoiler	Spoiler signal only	No mixing
Flap	Flap signal only	No mixing
L. Gear	Retract signal only	No mixing
Tow rel.	Tow release signal only	No mixing
Brake	Brake signal only	No mixing
Gyro	Gyro signal with all mixed signals from gyro mixer	
Mixture		
Aux1 Aux2	AUX1/2 signal only	No mixing
M.naut 1 M.naut 2	Control signal for MULTInaut IV → 19.4.	
all free mixers	all mixer as defined under "Mixer def." * (→ 13.2.)*	

**\* Note for all mixers with Aileron as input**

To ensure that aileron differential works correctly with channels whose signal source is aileron, or a mixer with an aileron input, the individual servos must be connected to the receiver alternately.

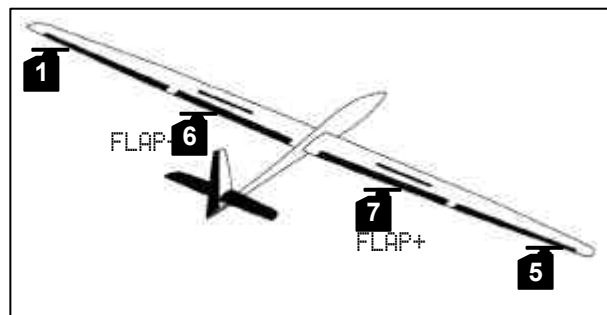

- Servo 1 AILERON+ left
- Servo 5 AILERON+ right
- Servo 6 FLAP+ left
- Servo 7 FLAP+ right

16.2.3. Assigning servos for helicopters



Model type „Helicopter“

	Note
Aileron	Roll signal only No mixing <i>for mechanical rotor head mixing</i>
Elevator	Pitch-axis signal only No mixing <i>for mechanical rotor head mixing</i>
Rudder	Yaw signal only No mixing
Throttle	Throttle signal with mixed throttle curve, throttle limiter, direct throttle, throttle-cut
Spoiler	(for fixed wing models)
RPM	Speed regulator control
L. gear	Landing gear signal No mixing
Tow rel.	Tow release signal No mixing
Brake	Brake signal No mixing
Gyro	Gyro signal, including all mixed signals from gyro mixer
Mixture	Mixture signal for special carburettors
Collect.	Collective pitch signal No mixing <i>for mechanical rotor head mixing</i>
Thr. lin.	Throttle limiter signal No mixing
TAIL	Tail rotor signal, including all mixed signals -> tail rotor (e.g. static tail rotor compensation / Revo-Mix)
HEAD f/b HEAD le HEAD ri HEAD 4	Signal for swashplate servos ** HEAD f/b, le and ri for swashplates with 3-point linkage (e.g. 3-point 120°) HEAD f/b, le, ri and 4 for swashplates with 4-point linkage (e.g. 4-point 90°) (electronic swashplate mixing, CCPM)

**\*\* Note**

To ensure that the electronic swashplate mixing works correctly, the servos must be connected to the receiver in a particular, pre-defined sequence. (→ 15.5.)

16.3. Sub-menu „Monitor“

The servo monitor acts as a substitute for a receiving system with servos connected. It enables you check the function / response of speed controllers, gyro systems, speed regulators etc., and helps to locate errors.

Two forms of display are available: graphical, with the output signals displayed in bar graph form, and numerical, with the signals displayed in % values. You can switch between the two types of display using the UP/DOWN (▲ / ▼) buttons, or alternatively using one of the two 3-D digi-adjustors.

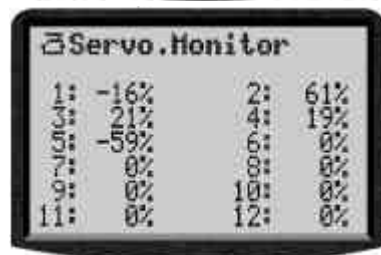

16.4. Sub-menu „Test run“

Automatic servo run, which can be used for test purposes and demonstrations, or as an "electronic" aid when range-checking.



When you select a transmitter control, the software generates a steadily changing control signal, running from one end-point of the control to the other. All the servos operated by this transmitter control (directly or via a mixer) start running.

You can stop the test run by either of two methods:

- Press the **REV/CLR** button ⇒ „Control“ appears
- select no control („-----“)

The transit time can be set within 0,1 – 4,0 sec.

## 17. Main menu „Timer“

The **ROYAL**Levo has 5 timers. Four of them you will find in the Timer menu. The fifth timer records the operating time of the transmitter, and is only shown in status display 4.

Oper. time	5.25h
------------	-------

After 1000 hours the timer stops.

### 17.1. Sub-menu „Model“

affects active model only  
 Range = 1000 h (stops at the end)  
 Press the **REV/CLR** button to erase

This timer is present once in each model memory, and it runs constantly when the transmitter is switched on. The wide range enables you to record the operating time of any model over an entire season.

### 17.2. Sub-menu „Slot“

affects active model only  
 Alarm range = 3:30:00 (3 ½ hours)  
 Time range = 4:30:00 (4 ½ hours)  
 Erase: in menu only

The special feature of this timer is that it is started with the assigned switch, but cannot be stopped again using the same switch until the slot time has concluded.

#### Applications:

- Measuring the total time of a flight
- Slot time in competitions

When you open the sub-menu, you will see the following items below the timer name (Slot, Sum or Interval) and Exit:



#### Line 1: Time

This is the time which has elapsed since the timer started. If you select this field, you can erase the time with the **REV/CLR** button.

#### Line 2: Alarm = Slot time

This is where you set and display the slot time.

#### Line 3: Difference (display only)

This line shows the time which also appears in status display 3. It is calculated as the difference between Time and Alarm. The arrow before the difference indicates the direction in which the indicated time is running:

- ↑ counting up
- ↓ counting down

#### Line 4: Switch (display only)

This line shows the switch you are using to control the timer (<N), and the location of the ON state (↑ = forward). When the switch is at the selected ON position, an asterisk \* appears after the arrow.

#### Alarm sequence:

- 10 seconds before the set alarm time: short beep every second (🔔)
- When the alarm time is reached: long beep (🔔 ---)

### 17.3. Timer „Σ Sum“

affects active model only  
 Range = 3 h 30 min  
 Press **REV/CLR** button in status display 3 (or in menu) to erase

This timer acts cumulatively, i.e. it sums the times. Once started, it can be stopped again using the same switch, then re-started by operating the switch once more.

#### Application:

Timing motor runs using throttle control as switch  
 You can set up the “Sum” timer to work in two different modes:

1. **Set alarm to 0:00:00**  
 The timer begins at zero, runs forward (count-up), adds the time and is stopped and re-started using the assigned switch. You can reset it to zero in status display 3 using the **REV/CLR** button, or in this menu. In this case there is no alarm.
2. **Alarm not set to 0:00:00**  
 The timer begins at the alarm time you set, runs backward (count-down) and sounds the alarm when the selected time has elapsed.

#### Alarm sequence:

- starting 5 min before the set alarm is reached: short double beep every minute (🔔🔔)
- 5 seconds before the set alarm time: short double beep every second (🔔🔔)
- When the alarm time is reached: long double beep (🔔 --- 🔔 ---)

### 17.4. Sub-menu „Interval“

affects active model only  
 Range = 3 h 30 min  
 Automatic erase at every re-start

With this timer you can call up the set interval as often as you like.

The timer starts running at the set alarm time, runs backward (count-down) and sounds the alarm when the selected time has elapsed.

If the switch is at the ON position at the end of the alarm time, the interval re-starts.

If the switch is at the OFF position at the end of the alarm time, the timer continues to count up until the maximum value is reached (4 h 30 min).

#### Alarm sequence:

- 1 second before the set alarm time: short triple beep (🔔🔔🔔)
- When the alarm time is reached: long triple beep (🔔 --- 🔔 --- 🔔)

## 18. Main menu „Memory“

The ROYALevo has 20 or 36 model memories, depending on the version you have purchased. The memory spots are numbered continuously. You can also enter a name with up to 16 characters for each model memory.

The model data is stored in an area of non-volatile memory, and cannot be lost even if you disconnect the transmitter battery from the transmitter.

In addition to memory management (switching, copying, erasing) you can also use this menu to create new models (→ 18.6.) and manage the flight phases you set up (→ 18.4.).

### 18.1. Sub-menu „Select model“ (change memory)

When you move to this sub-menu, the screen displays a list showing all the model memories. The top of a typical list might look like this:



The **active model memory** is marked with the letter x.

An **empty model memory** is marked with -----. Vacant memories can be managed, but not activated.

To change models simply select the memory you wish to use, then press the 3-D digi-adjustor or the ENTER button.

### 18.2. Sub-menu „Copy“

In this menu you can copy all the setup values relating to the transmitter controls, mixers, servos, timers, model name and trims.

The copy process is carried out in four stages:

1. **Select the model** which is to be copied.  
This can be any model.
  2. **Confirm your selection** with the 3-D digi-adjustor or ENTER button. The letter after the model name changes from x to c (copy).
  3. **Seek the destination**  
The model name and the "c" are carried along with you during the search.
  4. **Confirm the destination** with the 3-D digi-adjustor or ENTER button.
- If the **destination memory is empty**, the copy process is carried out immediately.
  - If the **destination memory already contains data**, you will see the security query: "Overwrite existing model?"
  - At this point you can **interrupt the copy process** by pressing the ENTER button or the 3-D digi-adjustor.
  - If you wish to **overwrite the existing model data**, press the REV/CLR button.

When the copy process is finished, the software calls up the previously active model again.

### 18.3. Sub-menu „Erase“

When you have selected the memory you wish to erase, press the 3-D digi-adjustor or the ENTER button. The screen displays the security query "Erase selected model?".

- If you do **not want to erase** the data:  
Press ENTER or the 3-D digi-adjustor.
- If you do **want to erase** the data:  
Confirm by pressing the REV/CLR button.

You **cannot erase** model data if you have selected the active model memory, i.e. the one marked with the letter "x".

### 18.4. Sub-menu „Flight phases“

 affects active model memory

4 phases are possible

Phases are switched "smoothly"  
(over approx. 1 sec)

Phase name can be selected from 13 pre-sets

Phases can be released and blocked  
(alarm sound if you select a blocked phase)

Phases can be copied

You can adjust the characteristics of the transmitter control to suit the requirements of the model for each flight phase separately, e.g. reduced control travels for SPEED FLYING, lowered flaps for LANDING, greater collective pitch travel for AUTO-ROTATION. Where settings are present which can be altered separately for each flight phase, the code number of the flight phase appears in the transmitter control menus (→ 14.2.).

**Basic requirement:** if you wish to work with flight phases, you must first assign at least one phase select switch (main phase or phases 1-3) in the menu ↘, ASSIGNMENT, SWITCHES. If no switch is assigned, the transmitter remains permanently in Phase 1.

A typical Flight Phase menu might look like this:



This display tells us the following:

1. Flight phases 2 and 3 are blocked  
(name crossed through)
2. Flight phase 1 (main phase) is active  
(x after the name)
3. Main phase switch is switch J on the right-hand side
4. No switch is currently assigned to phase 4  
(--- after phase 4)

#### 18.4.1. Selecting flight phase names

The following names are available:

NORMAL, START1, START2, THERMAL1, THERMAL2, SPEED1, SPEED2, CRUISE, LANDING, AUTOROT, HOVER, 3D, ACRO

The phase names are only intended as a reminder for the operator. The significant factor in the characteristics of the flight phase is always the number of that phase.

You can select a suitable name after activating the name input field.

### 18.4.2. Block / release flight phase

Use the **REV/CLR** button to release or block the flight phases. First select the flight phase, then activate the name, and finally switch between "free" and "blocked" using the **REV/CLR** button. Selecting a different name using the 3-D digi-adjustor also releases a blocked flight phase. The active flight phase (x) cannot be blocked.

**NOTE:**

If you accidentally select a blocked flight phase with the phase select switch, you will hear a continuous warning tone. The settings of the last used phase remain active, the corresponding phase number appears in the display and the phase name appears striked out.

### 18.4.3. Copying the active flight phase

The active flight phase is marked by an "x" after the name. You can copy the values for this phase into any of the three other phases. This is the procedure:

1. Select the active phase (x)
2. Press the 3-D digi-adjustor (or ENTER) twice: the "x" is activated
3. Select the destination phase for the copy: a "c" appears in the cursor.
4. Confirm with the 3-D digi-adjustor or ENTER

### 18.5. Sub-menu „Properties“

 affects active model memory  
Displays model template used to create this model

This menu displays certain characteristics of the active model. These characteristics can also be changed, with the exception of the used template.

Example:



In this example **Mode** indicates that the left stick controls rudder and elevator. You can change this setting if you wish.

**Assignment** indicates which of the available assignment lists for transmitter controls and switches is in use for this model. You can change this setting if you wish.

**Template** indicates the model template you invoked when you created this model. You cannot change this setting.

the **name** of the model can be entered at this point, with a maximum of 16 characters. If you create a new model, the name of the template you used is automatically entered here.

### 18.6. Sub-menu „New model“

When you open this sub-menu the following display appears:



The transmitter tells you which **memory number** will be used: it is always the first vacant memory. You cannot change the memory number.

The **template** determines which basic settings are accepted into the memory (→ 12.4.). You can change this setting if you wish.

**Servo conf.** (Servo configuration) defines the assignment of the servos and the signal format. The following combinations are possible:

Servo conf..	Servo assignment	Signal format
MPX-MPX	MPX	MPX
MPX-UNI	MPX	UNI
Futaba	Futaba	UNI
JR	JR	UNI

**Mode** defines the assignment of the sticks. In our example the left-hand stick controls rudder and elevator. You can change this setting if you wish.

**Assignment** defines which of the possible assignment lists for transmitter controls and switches is to be used with this model. You can change this setting if you wish. Select **OK** to conclude the process, and the new model is created.

**Note:**

If there are no vacant memories available, the screen displays the number -1 and the note "No memory free!" In this case press ENTER and then "EXIT" the menu.

**19. Accessories**

**19.1. Scanner (with HFM-S RF module)**

A scanner module can expand the Synthesizer RF module HFM-S of the ROYALeVo. The scanner can do two „jobs“:

**19.1.1. Scan all frequencies/channels in the band**

All channels in the band will be measured sequentially. Detected signals will show up in the display as bars. The height of the bar corresponds to the strength of the signal.

**19.1.2. Channel-Check at power-ON**

The channel selected for the synthesizer is checked every time you switch your transmitter ON. If the channel is occupied already the synthesizer does not start operation (no RF output) and in the display you will see a warning. If no signal is detected on your channel, normal operation starts.

**19.1.3. Installation of the scanner module**

The user can install the scanner. No tools or adjustments are required.

Available frequencies/bands: see MULTIPLEX main catalogue

**19.2. Channel-Check (with the RF module HFM-4)**

A Channel-Check module can be installed in the RF module HFM-4. This module needs a **receiver crystal** with the same frequency/channel, which will be used for the model.

Every time you switch your transmitter on, the module checks if the channel is occupied or not.

The Channel-Check module for the **ROYALeVo** is identical with the module, used in the transmitters PiCO line, COCKPIT MM and in the RF module HFM3.

Available frequencies/bands: see MULTIPLEX main catalogue

**19.2.1. Installation of the Channel-Check module**

Switch OFF and open the transmitter

remove the RF module  
Install the desired receiver crystal in the Channel-Check module  
plug Channel-Check module onto the RF module  
reinstall the unit in the transmitter

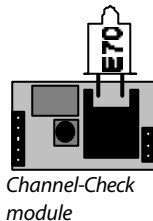

**19.2.2. Operating Channel-Check**

Expand the aerial fully  
Switch the transmitter on

LED glows permanently: Channel occupied  
LED flashes: Channel free (without guarantee)

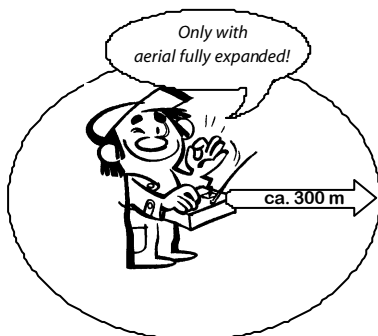

If the channel is occupied the following message appears in the display:

English text:

! NOTE !

No RF



**19.3. Other accessories/spar parts**

**19.3.1. Overview**

Article	Order No.
Transmitter bag	76 3322
Transmitter aerial 110 cm	89 3002
Transmitter tray	8 5305
Space-Box <b>ROYALeVo</b> BASIC	8 5658
Space-Box matching rainshield	8 5655
Transmitter neckstrap	8 5646
Transmitter Coross-over strap	8 5640
Padded neckstrap cushion	8 5641
Switch 2-position	7 5748
Stick top button/switch (→ 19.3.2.)	7 5303

**19.3.2. Stick top button/switch**

# 7 5303

A stick top button/switch is available for the **ROYALeVo** with integral button KTa and switch KSw. Two wires connect the stick to the main electronics board. Switch and button can be assigned to controls and switches in the same way as all the other switches are.

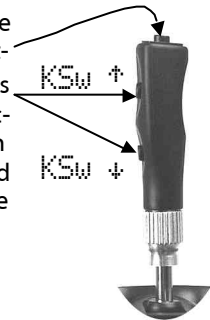

### 19.4. Using MULTInaut IV

Models equipped with the MULTInaut IV receiver unit can be operated with the **ROYAL**Levo.

The buttons of the **ROYAL**Levo are used to control the MULTInaut functions. No additional switches are required. All you need are the receiver units in the model.

4 buttons in two groups are assigned to each MULTInaut channel and control the connect lamps, servos, etc.

The effect of a key-press depends from the selected operating mode. The following possibilities exist:

1. **Left-hand sketch for Servo 5 = M.naut 1**  
Switching loads (e.g. lamps, horns, ...)  
Each key-press changes (toggles) the status of the load. (OFF → ON resp. ON → OFF)
2. **Right-hand sketch Servo 6 = M.naut 2**
  - a. Move servos between two positions (e.g. undercarriage, tow hook release, ...)  
Each key-press moves the servo (A or B) from one position to the other.  
(right → left resp. left → right)
  - b. Move the servo continuously (quasi-proportional)  
(e.g. mixture)  
As long as the key is pressed the servo (C) moves into one direction until it reaches its end-point. The full travel is split in 32 steps and takes approx. 4 sec.. A short hit on the key initiates a step of approx. 3°.

**This is how to activate MULTInaut**

1. Assign M.naut 1 or 2 to the receiver output where the decoder unit is connected to.
2. Back to one of the four status displays press the **ENTER** button for more than 3 sec. to activate the button groups for MULTInaut operation.  
Message in the display:  
MULTINAUT keyboard active
3. Press the **ENTER** button for more than 3 sec. again to end the MULTInaut operating mode.

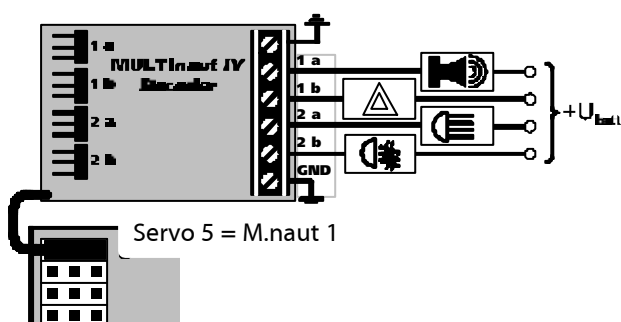
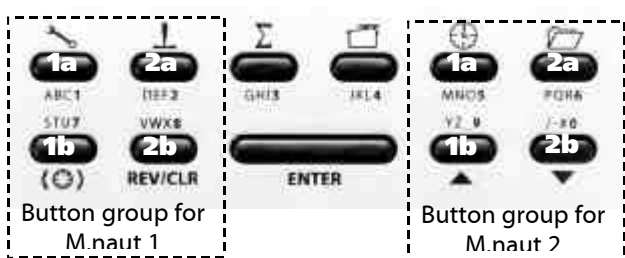

### 19.5. Diagnosis lead

You can connect the transmitter to the receiver directly using a diagnosis lead, in which case the transmitter does not generate an RF signal. This can be very useful for making adjustments, checking travels etc.

This is the procedure:

1. Connect the appropriate diagnosis lead to the multi-function socket on the back of the transmitter, and to the model's receiving system
2. First switch the transmitter on (RF remains off)
3. Switch the receiving system on

Different diagnosis leads must be used according to the receiving system in the model:

Diagnosis lead for MULTIPLEX switch leads with charge socket # 8 5105 for the „EinStein“ # 8 5162

### 19.6. PC interface

The multi-function socket on the back panel of the **ROYAL**Levo provides the functions Charge, Teacher/Pupil (Trainer) and diagnosis mode, and also works as a serial interface for connection to a PC. Two functions are possible via this interface:

- Access to transmitter data
- Use of transmitter to control model flying simulators

#### 19.6.1. Accessing transmitter data

Data exchange between transmitter and PC offers the following possibilities:

- Back-up model memory data on the PC
- Load new software into the transmitter

The latter point provides a unique feature: in conjunction with the Internet this opens up entirely new methods of updating the transmitter software, or downloading new screen languages.

The software (# 85 5321) and the matching connecting lead (# 8 5157) required for these functions are available as optional accessories.

#### 19.6.2. Flight simulator operation

Many manufacturers of flight simulators offer interface cables with which MULTIPLEX transmitters can be connected directly to the PC. The MULTIPLEX interface cable is not designed for use with simulators.

If you have queries regarding this application, please contact the manufacturer of the simulator.

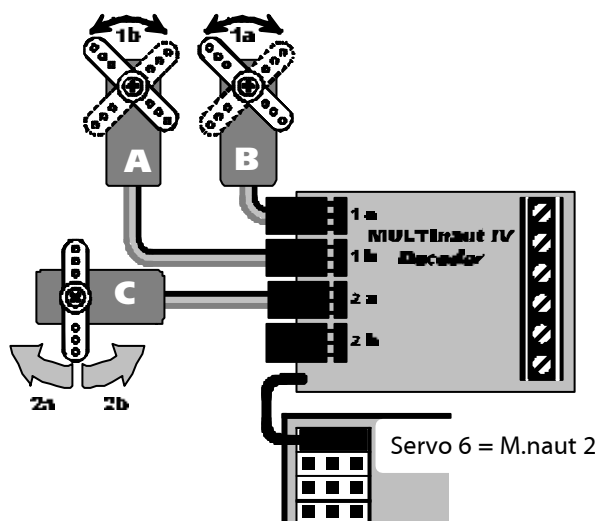



**20. Care and maintenance**

The transmitter requires no special maintenance. However, we strongly recommend that you have the system checked regularly by an authorised MULTIPLEX Service Centre. This should be done every 2 - 3 years, but the interval varies according to the amount of use the system has. In any case it is essential to check all the system's functions regularly, and carry out thorough range checks (→ 3.2.).

Remove dust and any soiling whenever necessary, ideally using a soft bristle brush. Obstinate soiling, such as grease and oil, should be removed using a damp cloth and a mild household cleaner if required. Never use powerful cleaning agents such as methylated spirits or solvents!

Avoid subjecting the transmitter to shock and pressure loads. For safety the transmitter should be stored and transported in a suitable container (case or transmitter bag).

Check the case, mechanical parts and - especially - the cables and contacts in the transmitter at regular intervals.

**⚠ Switch off the transmitter before opening the case, and disconnect the transmitter battery to be completely safe. Avoid touching the electrical components and circuit boards.**

**21. Service and Support**

We have tried to make these instructions helping you to find answers to your questions quickly and easily. If nevertheless an unanswered question arises, your local dealer will be glad to help you.

For technical questions you can call the MULTIPLEX Hot-Line: +49 7233 7343

For Service and repair contact the authorized MULTIPLEX service partners:

**Deutschland**

MULTIPLEX-Service  
Neuer Weg 15 • D-75223 Niefern  
Tel. 07233/73-33  
Fax. 07233/73-19

**Österreich**

MULTIPLEX Service Heinz Hable  
Seppengutweg 11 • A-4030 Linz  
Tel. 0732/321100

**Schweiz**

MULTIPLEX Service Werner Ankli  
Marchweg 175 • CH-4234 Zullwil  
Tel. 0691/7919191  
079/2109508

RC-Service Basel K. Elsener

Felsplattenstraße 42 • CH-4012 Basel  
Tel. 061/3828282  
079/3338282

**Frankreich**

MULTIPLEX Service Hubscher Electronic  
9, rue Tarade • F-67000 Strasbourg  
Tel. 03 88 41 12 42

**Italien**

Holzner & Premer OHG-Snc. • c/o Robert Holzner  
Prission 113 • I-39010 Trisens BZ  
Tel. 0473/920887  
0337/451198

**Niederlande**

MULTIPLEX Service • Jan van Mouwerik  
Slot de Houvelaan 30 • NL-3155 VT Maasland  
Tel. 010/5913594

**Belgien**

MULTIPLEX Service • Jean Marie Servais  
Rue J.-B. Fichet 56 • B-5100 Janbes  
Tel. 081/304564

**Schweden**

ORBO elektronik/hobby ab  
Lidgatan 20 • S-17158 Solna  
Tel. 08832585

**USA**

Ernest Pritchard, MULTIPLEX USA Service, Arizona  
1005 N. Aviator Parkway, Payson AZ 85541  
phone: 520-474-2528

© MULTIPLEX 2002

Errors and omissions excepted!