

NON  
BEC

3 CHANNEL

# RANGER

# // FM

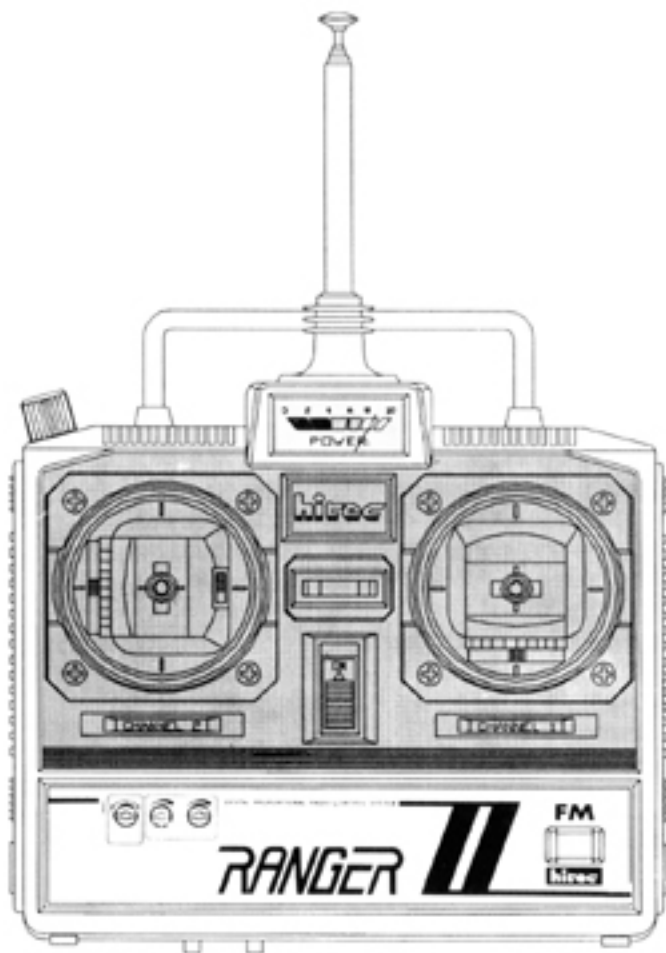

## **WELCOME TO THE INTRIGUING WORLD OF R/C**

**Thank you for purchasing the Ranger 3 channel FM radio system and thereby entering into the wonderful world of radio control model hobby. The Ranger 3 radio is the finest of its kind using the latest electronic technologies thereby assuring the best performance and highest quality.**

**Team up with Hitec, “The R/cer’s Partner” and you will enjoy the many facets of R/C fun.**

(WARNING) Please note that the receiver of RANGER 3 FM is not equipped with a Battery Eliminator Circuit. So don't exceed 6 volts Only use 4 cell “AA” size batteries, 4-5 cell NiCad batteries or an electronic speed controller which has a B.E.C..

## **FEATURES AND SPECIFICATIONS**

### **A.TRANSMITTER**

- 3 CHANNEL FM TRANSMITTER FOR REAL TIME SERVO RESPONSE
- CRYSTAL INTERCHANGEABLE
- TWO CHANNEL SERVO REVERSING SWITCHES
- CHARGER CONNECTOR FOR NICAD BATTERIES (8 CELL 9.6V)
- ADJUSTABLE SERVO TRAVELING (ATV) FOR STEERING AND THROTTLE
- QUICK START/BRAKE FUNCTION FOR FAST RESPONSE OF THROTTLE
- ALL SMT CIRCUITRY

### **B.RECEIVER (NON B.E.C.)**

- FM SINGLE CONVERSION RECEIVER FOR NOISE PROOF
- CRYSTAL INTERCHANGEABLE
- SIZE AND WEIGHT
- SIZE: 48 X 29 19mm (1.9 X 1.1 X 0.7”), WEIGHT 22.5g (0.79oz)

### **C.SERVO**

- HEAVY DUTY AND DUST RESISTANT DESIGN
- HIGH SPEED: 0.16sec / 60°
- HIGH TORQUE: 3.5kg/CM (44oz/in)
- HITEC CUSTOM CHIP FOR NARROW DEADBAND
- ALL SMT CIRCUITRY

# RANGER 3 CH FM LAYOUT DIAGRAM

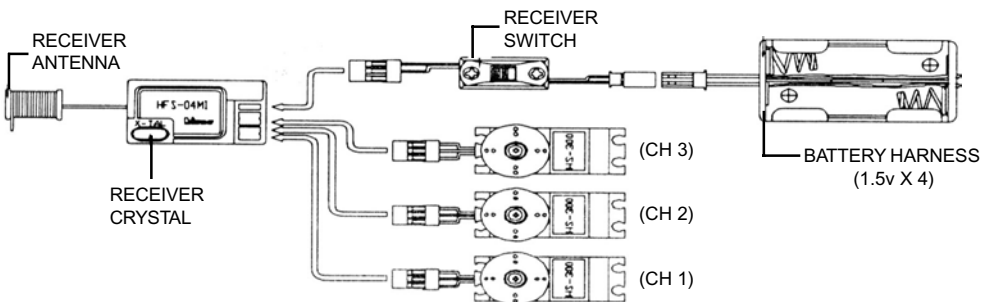
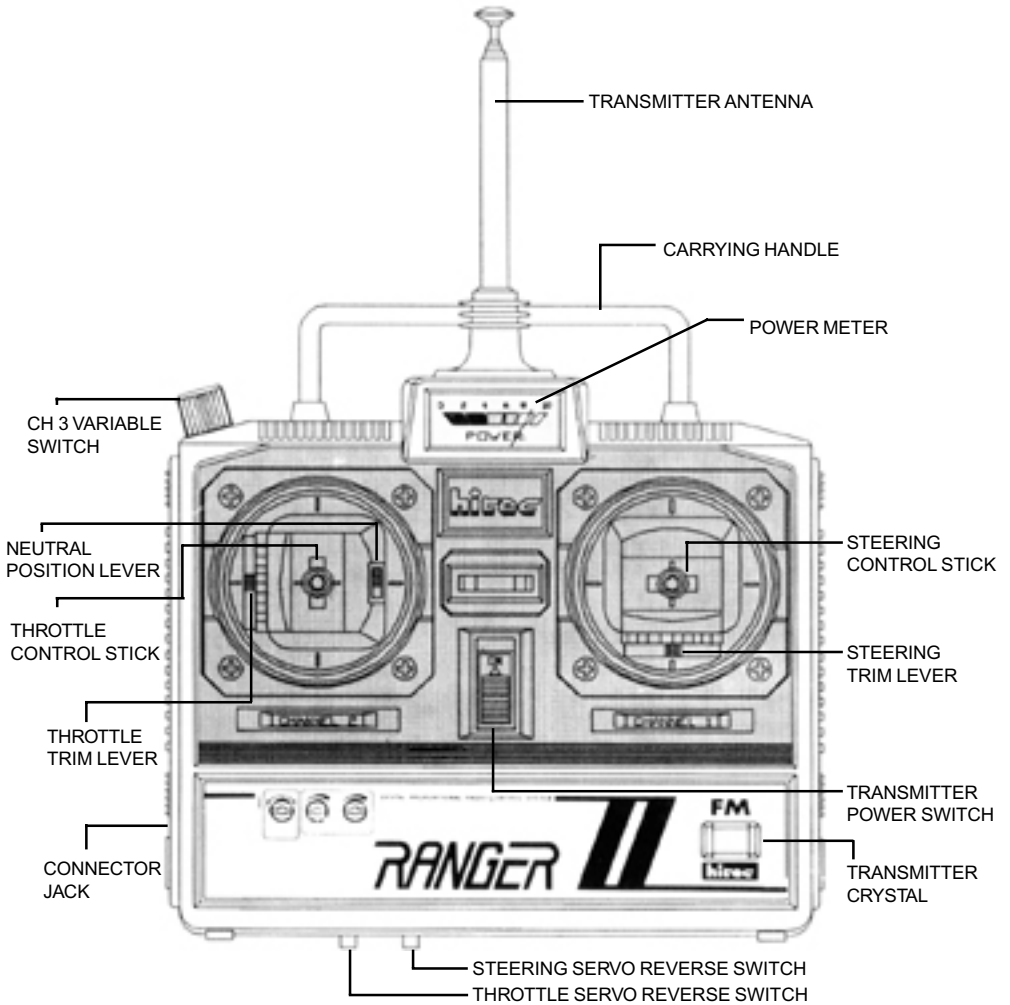

# THE VARIOUS USES OF THREE CHANNEL RADIOS

## A. VEHICLES & BOATS

You can operate all model vehicles and boats of course with this advanced three-channel radio whether they are engine powered or battery operated. Since the basic maneuver of all vehicles and boats is throttle and steering (rudder), two-channel operation is all you need in most cases. However the third channel provides one more auxiliary channel you can use for whatever purpose you may desire.

## B. AIRPLANES & GLIDERS

The main use of the third channel for aircrafts would be throttle control. The third channel of this radio is designed exactly for this purpose. After lifting the aircraft in the air, you will be able to control speed and or turn off the power to let it soar by controlling the variable switch of the third channel. To control speed or turn off the power in the air, you may need another accessory item such as the Hitec SP-1801N Speed control or the SP-1003 ON/OFF control. The Sp-1801N will provide proportional speed control from neutral to high end and the SP-1003 will do ON/OFF control without any extra servo for throttle. Also, both of them have Battery Eliminator Circuits and Auto Cut OFF function so there is nothing else needed for enjoying the 3-channel aircraft model.

## C. OTHERS

You may find many other models too numerous to mention or categorize such as tanks, submarines, parachute planes, rocket launched gliders, hovercraft etc...

(WARNING) Please note that certain frequencies are to be used solely for airborne uses as well as certain frequencies earmarked only for surface use, so please consult your local club or hobby store to make sure.  
(EXAMPLE) In the U.S.A. 75MHZ: For surface only, 72MHZ: For Aircraft only

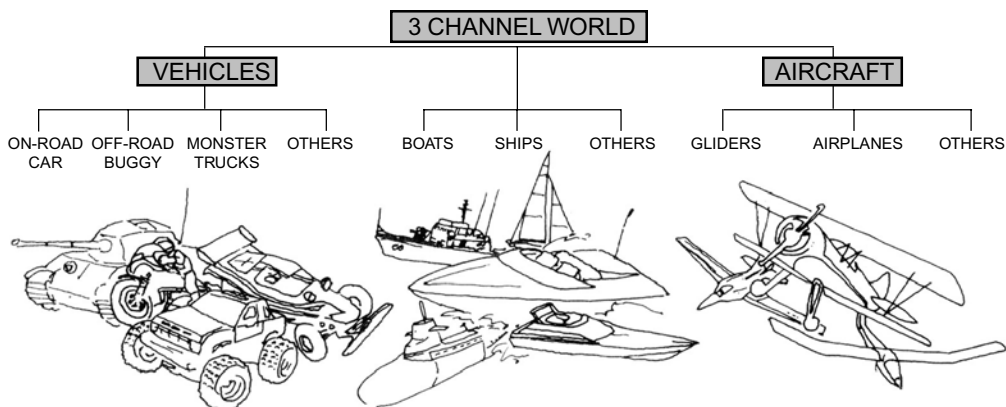

## SETTING UP

Please read the following section carefully before installation and operation of your new model. The instruction was written with the beginner in mind but even experienced modelers should take note.

### A. BATTERY INSTALLATION

The transmitter uses eight "AA" size batteries and four for the receiver. We recommend using the NiCad batteries whenever possible as it will prove to be far more economical in the long run.

- 1) When loading the batteries, please make sure the transmitter and the receiver switches are in the off positions.

- 2) Open the battery compartment at the back of the transmitter by pressing the cover down and toward the bottom. (See fig 2)
- 3) Load batteries into the slots paying close attention to the polarity. (See fig 2)
- 4) Replace the battery cover and turn the power "ON" to see if the indicating arrow will move up. If the batteries are fresh, the indicating arrow will move to the far right side but if the arrow is in the low power or lower part of the yellow zone, you had better replace the batteries or recharge your NiCad batteries. (See fig 3)

Loading Battery fig 2

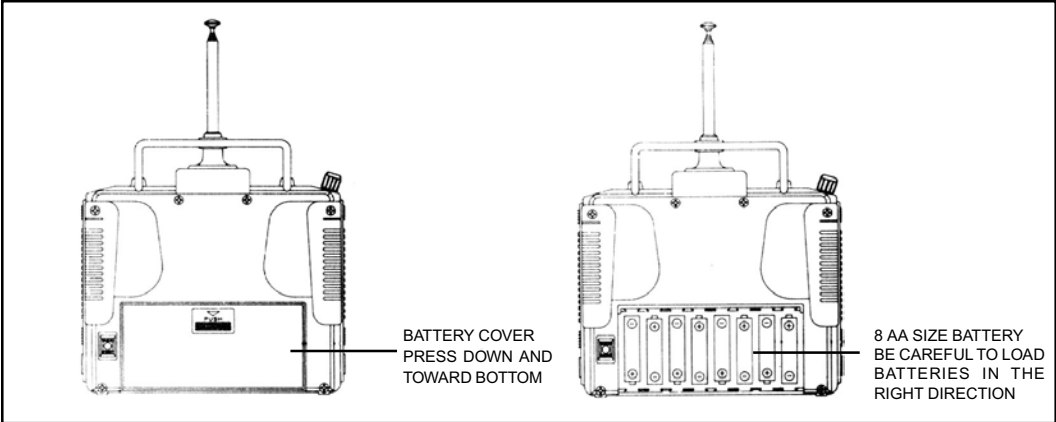

Power indicating fig 3

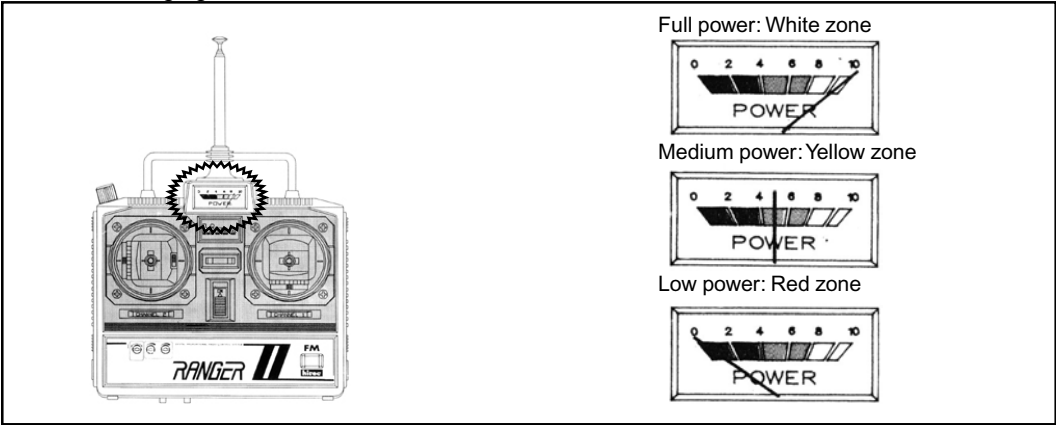

## B. OPERATION CHECK

- 1) Gently plug the switch harness and servo connectors into the proper slots of the receiver. The connectors are polarized, thus, should fit only one-way. If they will not go in one-way, reverse it and see if it will plug in. Never use excessive force to plug in connectors. (See fig 1).
- 2) Turn the transmitter power switch "ON" first, then the receiver switch. Always remember to turn the transmitter on the transmitter before you turn the receiver on, otherwise your receiver may receive other interfering signals from other radio sources and jitter.
- 3) Check to see if the servos move when you control the sticks. Move the trim lever to the center position. (See fig 4)

- 4) Check the direction of the servo rotation. If you wish to change the direction of the servo, push the servo reversing switch and check if it changes direction as you desired. (See fig 4)
- 5) If you wish to have more forward throttle than backward, you can push down the neutral position adjustment lever. You will have 30% more forward than backward. The control stick will only return to the lower position. You may have to adjust the servo horn position when you do this.
- 6) Adjustable Travel Volume: you may use this volume to adjust servo travel according to the characteristics of your model; the servo travel can be adjusted from 50% to 100% of the total travel range by turning each ATV knob on the transmitter. (See fig 5). Turning clockwise will increase servo travel and counter clockwise will decrease servo travel.
- 7) Quick Start/Brake: This button is located at the back of the transmitter and is a convenient feature if you ever get involved in competition racing. While pressing the button with you little finger, you hold the throttle stick at full throttle, then let go at the start signal by releasing the button. This button also doubles as a quick brake when you need it. Instead of throwing the throttle stick down, you can simply press this button to bring your car to a screeching halt. Before using the Quick Start/Brake feature, you should preset the braking point by adjusting the Throttle Quick Trim as follows; With the throttle stick set in neutral for your servo or speed control, press the Quick Start/Brake button to see if braking position is correct. If not, adjust the trim. You may adjust the trim while the car is running but you would have to take extra care so it does not get out of control. (See fig 6)
- 8) If everything checks OK, turn your receiver off before you turn your transmitter off. Remember that this is exactly the reverse sequence of turning the system "ON".

Stick control fig 4

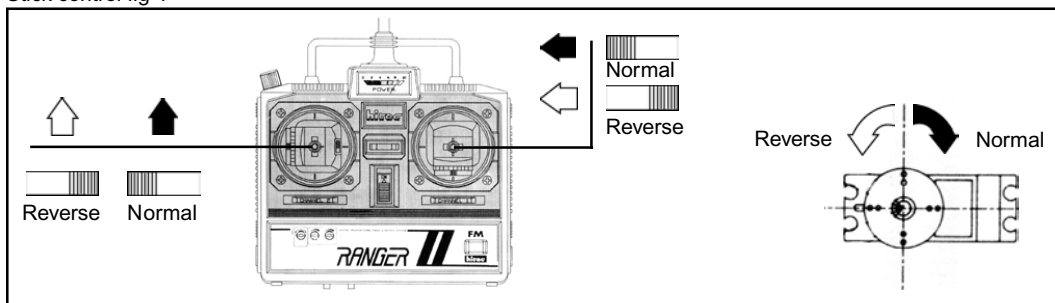

Servo traveling adjustment fig 5

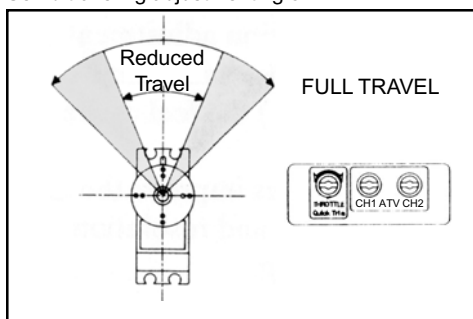

Quick start/break function fig 6

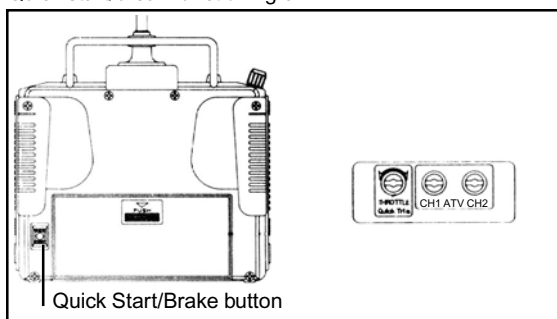

## INSTALLATION

When installing the radio system to the model, please follow the detailed instructions for the model kit.

### A. Normal Installation (non BEC)

If you are using the regular mechanical speed control that usually comes with the model kit, you will need both servos, and the battery harness that comes with the radio set. Incidentally this is the installation method for the engine equipped model as well.

### B. ESC installation (Electronic Speed Control)

You may wish to use an ESC in place of the mechanical speed control and throttle servo. This will allow more precise control as well as less power consumption. Please note that most ESC's are already equipped with BEC so you can simply plug into channel two of the receiver.

Installation diagram fig 7

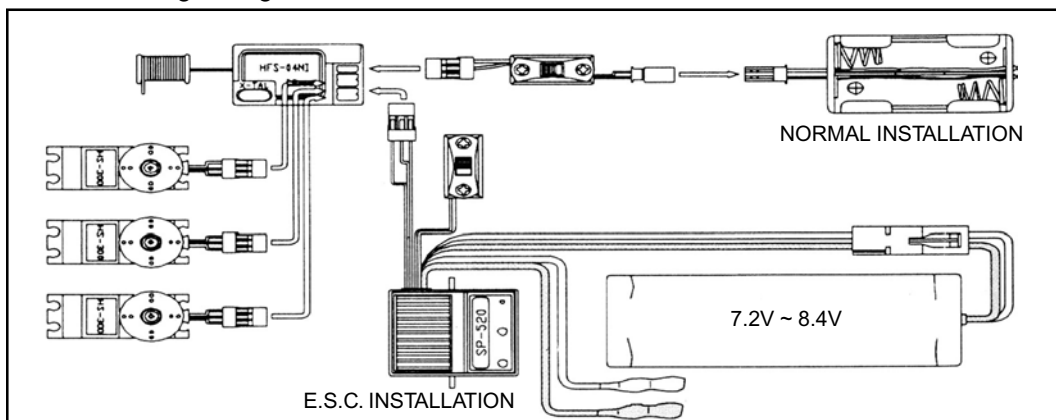

## HELPFUL HINT

### A. BATTERY

Always take extra care that all the batteries in the radio set are fully charged (NiCad) or fresh (Dry) when operating your radio. Otherwise the receiver range will substantially be reduced and lose control thereby damaging your model and or people. When you recharge your transmitter NiCads with a charger jack, be careful of its polarity. The inner contact should be positive (+), the outer negative (-). For your convenience, we recommend our genuine overnight charger. CG-22(220V0 or CG-25(110V).

### B. ANTENNA

Both the transmitter and the receiver antenna must be fully extended when in use. Be careful that you do not cut off the excess receiver antenna wire or bundle it. This will severely cut down on the operating range.

### C. XTAL CHANGE

When changing the frequency to another channel, make sure that you match the transmitter to the receiver channel. Also you must make sure that they are replaced with only genuine Hitec single conversion FM xtals as not all xtal makes are compatible with each other. Also remember that you can change frequencies only within the same frequency band, which means you cannot change to 72MHz from 75MHz. (Also in the US, you may not be allowed to change the transmitter xtal).

#### **D.WATER, DUST AND FUEL**

Take suitable measures to prevent water, dust and oil (fuel) from getting into the radio system. In the event that this does happen, make sure that you clean them off thoroughly before you turn it "ON" again.

#### **E.SERVO LINKAGE**

Install your linkage rod to product the maximum freedom of movement possible with the minimum amount of slop and friction; to check these points out, operate each servo over its full stroke and check if the rod binds or is loose. One great item that we at Hitec have invented is the "Jam Checker" which is uniquely designed just to detect if there are any binds in the linkage if they are buried in the installation and cannot be detected easily.

#### **F.POLARITY**

Many a model were wasted and junked by a simple but mindless mistake such as connecting to the wrong polarity so whenever making a connection, do make sure that they are the right polarity.

#### **G.RACHET THROTTLE CONTROL**

You may defeat the spring mechanism on the throttle stick by placing a Spring Defeat plate (copper colored) provided on top of the gimbal inside the transmitter case.