

PACKING LIST

- Drone X 1
- Protective cover X 1
- Charging cable X 1
- Magic glove X 1
- Spare blade X 4

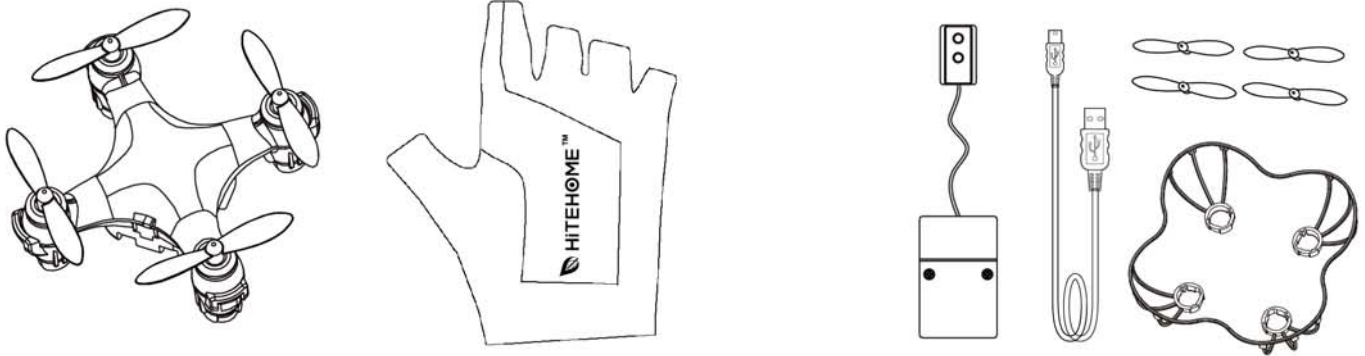

FCC ID:2ANDC-17100

This device complies with Part 15 of the FCC rules. Operation is subject to the following two conditions: (1) This device may not cause harmful interference, and (2) This device must accept any interference received, including interference that may cause undesired operation.

Caution:

This equipment has been tested and found to comply with the limits for a Class B digital device, pursuant to part 15 of the FCC rules. These limits are designed to provide reasonable protection against harmful interference in a residential installation. This equipment generates uses and can radiate radio frequency energy and, if not installed and used in accordance with the instructions, may cause harmful interference to radio communications. However, there is no guarantee that interference will not occur in a particular installation. If this equipment does cause harmful interference to radio or television reception, which can be determined by turning the equipment off and on, the user is encouraged to try to correct the interference by one or more of the following measures:

- Reorient or relocate the receiving antenna.
- Increase the separation between the equipment and receiver.
- Connect the equipment into an outlet on a circuit different from that to which the receiver is connected.
- Consult the dealer or an experienced radio/TV technician for help.

This device complies with part 15 of the FCC rules. Operation is subject to the following two conditions: (1) This device may not cause harmful interference, and (2) this device must accept any interference received, including interference that may cause undesired operation.

Any Changes or modifications not expressly approved by the party responsible for compliance could void the user's authority to operate the equipment.

RF Exposure

The equipment complies with FCC radiation exposure limits set forth for an uncontrolled environment. This device should be installed and operated with minimum distance 0 cm between the radiator & your body.

RF Power(EIRP): 0 dBm (2412 MHz - 2468 MHz)

Caution

1. Risk of explosion if battery is replaced by an incorrect type. Dispose of used batteries according to the instructions.
2. The product shall only use USB port to charging.
3. The max operating of the EUT is 45°C. and shouldn't be lower than -20°C.
4. The device complies with RF specifications when the device used at 0cm form your body.

5. Declaration of Conformity

We, Hitehome International Co., Limited hereby, declare that the essential requirements compliance with the Directive 2014/53/EU.

have been fully fulfilled on our product with indication below:

Product Name: MINI DRONE

Brand Name: HITEHOME™

Model: 17100

This product can be used across EU member states.

FLYING TIPS

When launching the Drone, face the same direction as the Drone. Red LEDs should be in front and Blue LEDs should be in back.

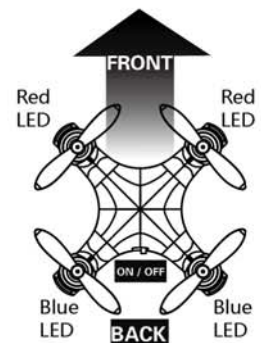

CHANGING DAMAGED PROPELLERS

1. Power off the drone.
 2. Make note of the blade letter(A or B) before removing the blade from Drone.(Markings are located on the underside of blades).
 3. Pull up on the damaged blade to remove.
 4. Press on a new blade.
- WARNING :** Do not fly with broken or damaged propeller blades as it may cause damage or lead to injury.

MAINTENANCE:
Over time loose hair or carpet fibers might get wound in propellers, reducing performance. Turn off the Drone and remove fibers from motors.(Remove blades if necessary)

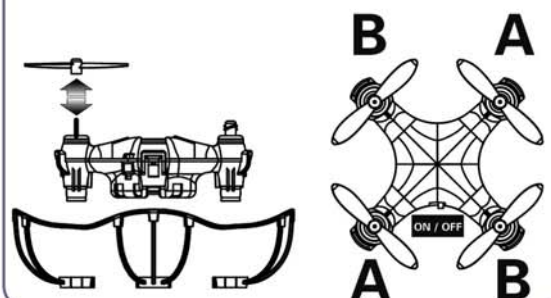

CHARGING THE DRONE AND CONTROL BOX

17100 – MINI DRONE

Power off the drone or control box, plug small end of the CHARGING CORD into the back of the drone or control box, plug the large end of the CHARGING CORD into a computer or USB power block. The voltage at the USB interface is $5V \pm 0.5V$.

The USB indicator light is OFF=CHARGING
The USB indicator light is ON=FULLY CHARGED

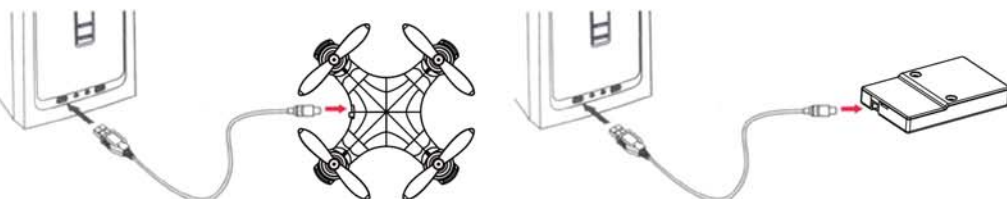

INSTALLING THE PROTECTIVE COVER

The protective cover is very helpful for beginners, which can greatly prevent the drone from being damaged, and protect the safety of its. However, the protective cover may also increase the weight of drone, so as to reduce the flight performance, and shorten the flight time to a certain extent.

The protective cover is easy to install: you just need to install its four clamping grooves correspondingly onto the motor seat from the lower part of drone.

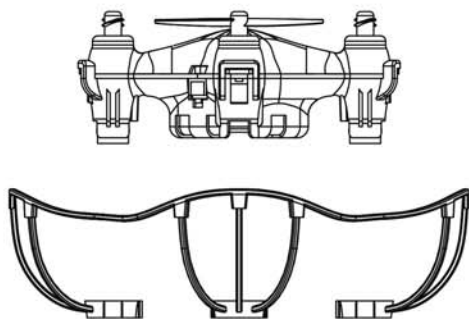

REPLACING THE BLADE

1. Power off the drone.
2. Before removing the blades from the drone, please remember the corresponding letters (A and B) on them (the letters are marked on the back of these blades).
3. Remove the damaged blades.
4. Install the new blades.

Maintenance :

After a period of time, the scattered hair or wool cloth of the carpet fiber may be involved in the blade and degrade the performance. Power off the drone and take the fiber off the motor.(remove the blades if needed)

PACKING LIST

- Drone X 1
- Protective cover X 1
- Charging cable X 1
- Magic glove X 1
- Spare blade X 4

ADULT SUPERVISION REQUIRED

Before each use, an adult should check this product and the LiPo battery to ensure no damage or hazards exist. Drone has rotating blades that move at high speed, posing danger of damage and injury. Pilots are responsible for any actions that result in damage or injury from the improper operation of Drone. Adequate flying space is required.

Avoid flying near interior fans and/or vents as they may make flying difficult to control.

Keep a safe distance away from streets, public thoroughfares and power lines. Never attempt to retrieve Drone from any location higher than your reach (such as rooftops or trees) or from any location that poses a safety hazard. Never fly Drone at night. Keep Drone in sight at all times during operation. Discontinue operation immediately if Drone flies out of your field of view. Do not fly near spectators or animals. Pets can become excited about R/C vehicles therefore keep away from pets at all times. Keep spinning rotors away from fingers, hair, eyes and other body parts. Always launch from a flat surface. Never leave Drone unattended while it is turned on. Read all enclosed information before operating.

THIS DRONE CONTAINS A 3.7V 150mAH LITHIUM-POLYMER BATTERY AND A 3.7V 100mAH LITHIUM-POLYMER BATTERY FOR THE GLOVE

LiPo batteries have a severe risk of fire and injury if they are improperly handled or misused. They may explode, overheat or ignite. Read all following precautions and instructions regarding the care and use of LiPo batteries. The enclosed LiPo battery is only to be used with the vehicle and charger included with this product.

- Keep away from flammable materials.
- Do not expose to direct sunlight.
- Do not place in a fires or leave in hot places.
- Do not drop or make subject to strong impact.
- Keep dry and away from water.
- The supply terminals are not to be short circuited.
- Never throw batteries in a fire or attempt to open outer casing.

LiPo Battery Disposal: LiPo batteries must be recycled or disposed of properly. They should not be disposed of with other household waste. Check your local laws and regulations for correct recycling and/or battery disposal.

WARNING:

Batteries are harmful if swallowed. Please keep away from children.

Battery Disposal: Dispose of batteries according to the local laws and regulations of your region. Some batteries may be recycled, and may be accepted for disposal at your local recycling center. If you are not able to identify the applicable rules in your area, please check the instructions of the battery manufacturer.

Hitehome International Co., Limited
2F, Building C, NO.38, Xingye Ave., Panyu, Guangzhou, CHINA

If you are unable to solve the problems encountered in the process of using, please call: (0086)-20-28981302

MADE IN CHINA

INSTRUCTIONS OF CONTROLLER BUTTONS

17100 – MINI DRONE

The magic glove has two operating buttons of A and B: The button A is a active button, which control to fly forward/backward/left/right, and rotate counter-clockwise/rotate clockwise; the button B is a active button which control auto-launch/autoland/lift/descend, as well as flip stunt.

Press down the buttons of A and B at the same time=WAKE UP

Press and hold the buttons of A and B for more than three seconds =SLEEP MODE

When the buttons of A and B have not been operated for more than 1 minute, the magic glove will automatically power off.



CONNECT THE MAGIC GLOVE TO THE DRONE

1. Open the Velcro, insert the control box into the pocket, then seal the Velcro.
2. Wear the magic glove properly.
3. Power on the drone, and place it on a horizontal plane. The indicator light is at fast flashing for "waiting for connection".
4. Press down button A and B at the same time to wake up the magic glove.
5. With 1-3 seconds, the indicator light of Drone is always on, this means connecting successfully.
6. After that, the status of drone is "Waiting for flight", which is waiting for the operating instruction from magic glove.

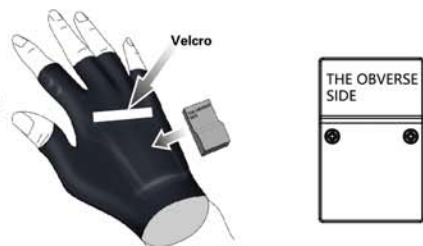

(Pay attention to the correct installation direction of the control box)

TIPS ON SLEEP AND WAKE UP THE MAGIC GLOVE

1. When the buttons of A and B have not been operated for more than 1 minute, the magic gloves will automatically go to sleep.
2. When the status of the magic glove is "Normal-operation", simultaneously press and hold the buttons of A and B for more than three seconds, the magic glove will go to sleep mode.
3. When the control box go to sleep mode, the magic glove can not control the drone, you can wake up it by pressing down the buttons of A and B at the same time.

FLIGHT CONTROLS

Auto-launch

Lay your forearm flat, press and hold the button B, then raise the forearm, the drone will LAUNCH automatically and hover at a fixed height. After that, release the button B.



Auto-land

Continuously press down the button B for three times, the drone will LAND to the ground.

Lift and Descend

Lift: 1, Lay your forearm flat, press and hold the button B, and raise your hand, the drone will lift, then release the button B.

2, If you want it lift more, repeat the step.1.

Descend: 1, Upward your forearm, press and hold the button B, and drop your hand, the drone will descend, then release the button B.

2, If you want it descend more, repeat the step.1.

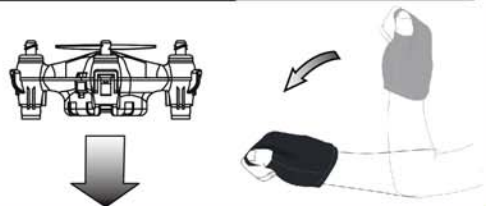
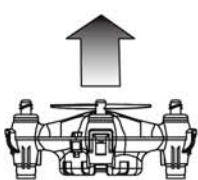

FLIGHT CONTROLS

Stunt

While HOVERING, continuously press down the button B for two times, the drone will perform a FLIP stunt.

Fly forward

Upward your forearm, press and hold the button A, and then drop your hand, the drone will keep FORWARD. When it reach the position you want, release the button A.

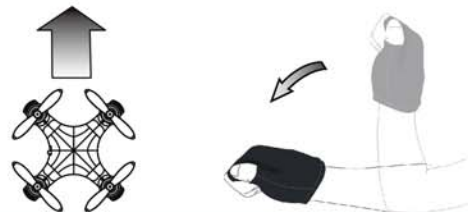

Fly backward

Lay your forearm flat, press and hold the button A, then raise your hand, the drone will keep BACKWARD. When it reach the position you want, release the button A.

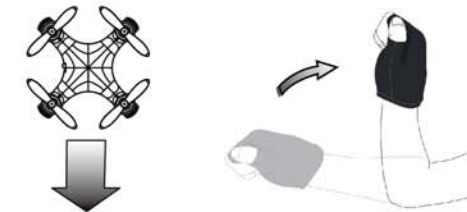

Fly left

Lay your forearm flat, press and hold the button A, then rotate your hand to left, the drone will keep flying to LEFT. When it reach the position you want, release the button A.



Fly right

Lay your forearm flat, press and hold the button A, then rotate your hand to right, the drone will keep flying to RIGHT. When it reach the position you want, release the button A.

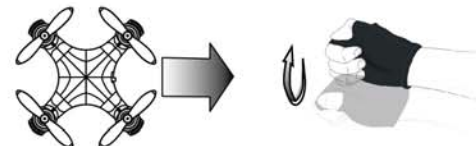

Rotate counter-clockwise

Lay your forearm flat, 1, press and hold the button A, then rotate your hand counter-clockwise: The drone will perform a COUNTER-CLOCKWISE flight, then release the button A and put your hand back. 2, If you want the rotate angle bigger, repeat step.1.



Rotate clockwise

Lay your forearm flat, 1, press and hold the button A, then rotate your hand clockwise: The drone will perform a CLOCKWISE flight, then release the button A and put your hand back. 2, If you want the rotate angle bigger, repeat step.1.

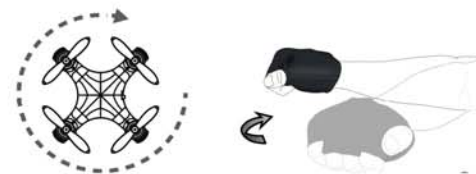

Maintenance :

The fabric can be machine washed or hand washed, please leave it to dry naturally (Electronic parts and cloth material should be separated)

Hitehome International Co., Limited

2F, Building C, NO.38, Xingye Ave., Panyu, Guangzhou, CHINA

If you are unable to solve the problems encountered in the process of using, please call: 0086-20-28981302

MADE IN CHINA