

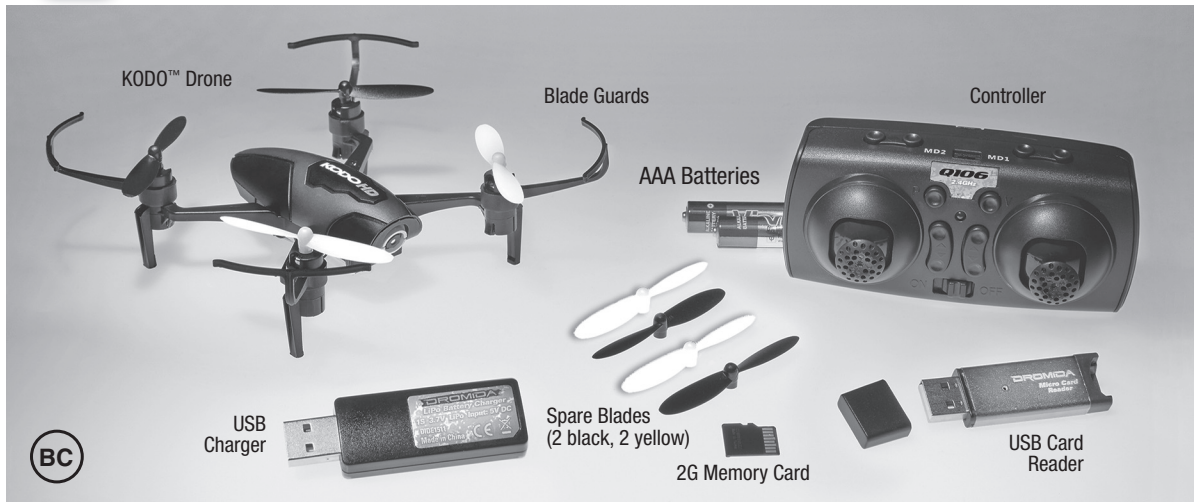

READ THESE INSTRUCTIONS BEFORE FLYING!

KODO HD™



CONTROLLER SETUP

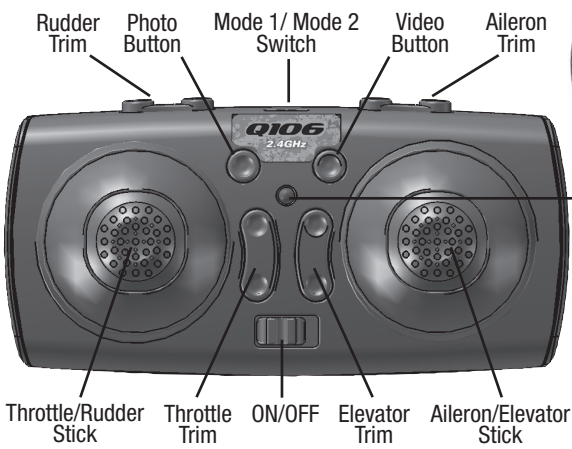

NOTE: For Mode 1 operation, slide the mode switch to the MD1 position and flip the controller so the throttle is on the right side.



Remove the screw on the battery compartment cover. Take the cover off and insert 2 AAA batteries. Replace cover securing with the screw.

SENSITIVITY ADJUSTMENT

Push down on the left stick to change the sensitivity of the controls.



- Lowest (Default) BEEP!
- Moderate BEEP! X2
- Maximum BEEP! X3

- Do not mix old and new batteries
- Do not mix alkaline, standard, or rechargeable batteries.

CHARGING the FLIGHT BATTERY

Plug charger into USB port or AC adapter (DIDP125 not included) as shown and connect the battery. The red LED will flash slowly while the battery is charging. The LED will be steady when the battery is fully charged.

- **NEVER** leave the battery unattended while charging.
- **DO NOT** allow the USB port to power down while the charger is connected to the battery.
- **ALWAYS** unplug the charger from the USB port and the battery when charging is complete.
- The battery connector will only fit in one way.

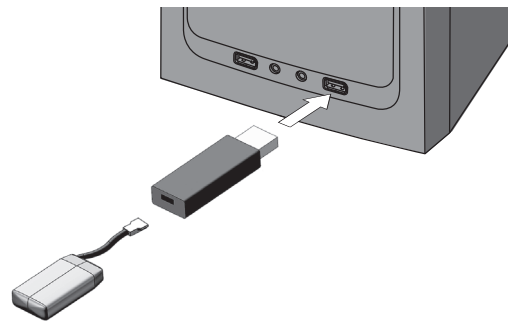

LINKING

Your KODO comes with a Power-On failsafe. This is designed to ensure that the motors will not start until the KODO has detected the controller.

1. Turn on the controller with the throttle at its lowest position.
2. Connect the battery to the Kodo HD and place it on a level surface. Listen for two beeps. The red LED at the back of the quadcopter will start flashing slowly.

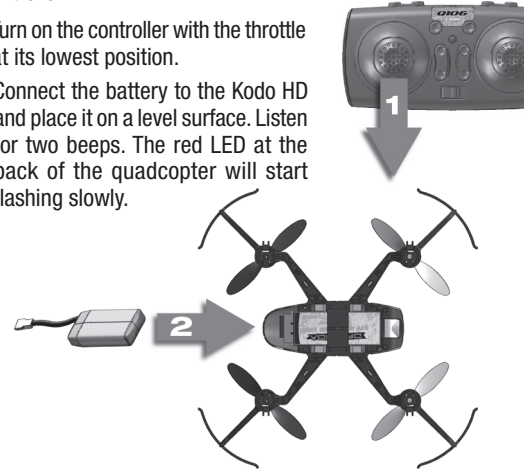

3. Move the throttle to its highest position. Listen for a beep
4. Move the throttle back to its lowest position. Listen for three beeps.

The Kodo's motors are now armed and the quad is ready to fly. The red LED on the Kodo HD will become steady.



HOW TO FLY

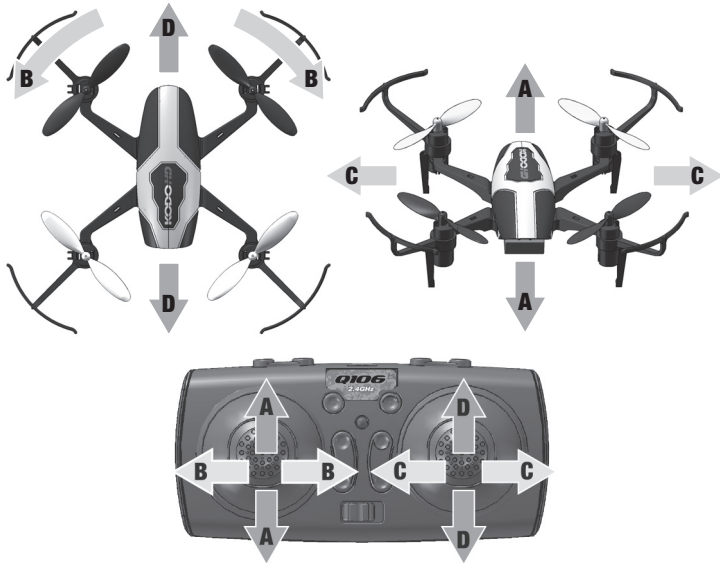

Basic Flight Advance the throttle slowly until your Kodo HD rises into the air. The controls are very sensitive and small stick movements should be used to control the quadcopter. If you get into trouble and see that the Kodo HD is going to crash, move the throttle to its lowest position immediately.

The LED on the Kodo HD will flash slowly when the battery voltage is getting low. **Land as soon as possible and unplug the battery.** Always recharge the battery or batteries before storing the Kodo HD.

CORRECTING DRIFT

It is normal for the KODO to drift slightly. However, if it drifts in any direction consistently, press the trim button that is opposite the movement as many times as needed to eliminate the drift.



CAMERA OPERATION

Photo Button Video Button



Press the photo button to capture a photo. BEEP!

Press the video button to start a video. BEEEEEP!

The video button must be pressed again to stop and save the video on the card. The photo button will not operate while the camera is recording a video.

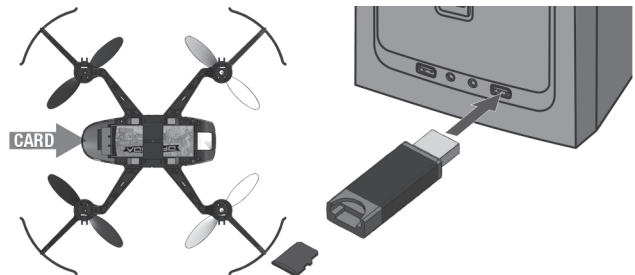

Only insert and remove the memory card when the battery is not connected to the Kodo HD. When the memory card is installed, there will be a steady blue LED just above the card slot.

The camera lens angle can be adjusted from straight ahead to 70 degrees down.

To view the photos or videos, remove the memory card and install it in the card reader. Install the card reader in a USB port on your computer

BLADE GUARD REPLACEMENT



Flips Push down on the right stick. Move the right stick in any direction and release when the flip is completed. The controller will beep until the right stick is released.

The red LED on the Kodo HD will flash when the battery voltage is getting low. Land as soon as possible and charge the battery. The battery must be charged before it is stored. The battery must not be connected to the Kodo HD or the charger when stored.



1. Carefully pry off the blade using a flat head screwdriver. **NOTE:** Do one corner at a time so you don't accidentally mix up the blades.



2. Pull blade guard up and off the motor housing. Install the new guard and replace the rotor blade.

BLADE REPLACEMENT

NOTE: Rotor blades *must* be installed as shown.

- Carefully pry off the blade using a flat head screwdriver.
- Rotor blades are marked with an A or B.
- Yellow rotor blades are front and black are rear.
- Match the A and B blades to this drawing to insure that the replacement blades are in the correct locations.

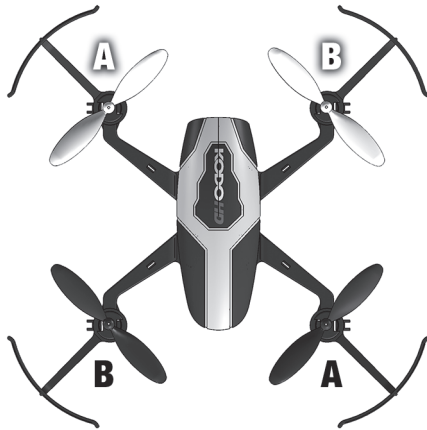

SENSOR CALIBRATION

It is normal for the Kodo HD to require minor corrections while hovering. If the quad has a strong tendency to drift in one direction, the sensors may need calibration.

1. Power up and link the controller and the Kodo HD.
2. Place the quad on a level surface.
3. Hold both sticks in the lower right corners. When the LED on the quad starts to flash rapidly, release the sticks but do not move the Kodo HD until the LED is steady again.



MOTOR REPLACEMENT

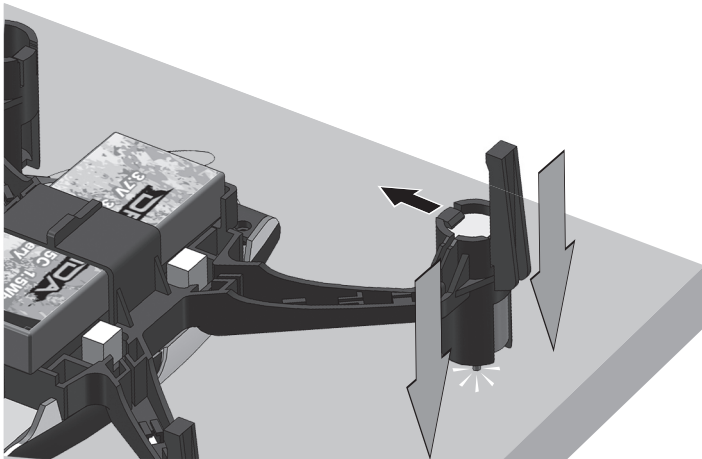

1. Remove the rotor blade from the motor.
2. Remove the blade guard from the motor housing.
3. While holding the motor locking tab open, place the motor shaft on a solid surface and push down on the arm to force the motor up and out of the motor housing.
4. Remove the wires from the brackets on the arms and unplug the assembly from the control board.
5. Before installing the new motor, make sure that the wires are the same color and are installed in the same positions in the connector.

TROUBLESHOOTING

PROBLEM: KODO will not stay level or drifts while hovering.

SOLUTION: (1) Calibrate the sensors – see the Sensor Calibration section.
(2) Check the rotor blades and motors for damage. A common problem is lint wrapped around the motor shaft.

PROBLEM: Red controller LED light flashing after linking.

SOLUTION: Replace with new AAA batteries.

PROBLEM: The Kodo HD will not respond to the controller.

SOLUTION: (1) Relink the controller and the Kodo HD.
(2) Make sure the flight battery is fully charged.

PROBLEM: Unable to flip but the KODO is flying.

SOLUTION: Battery voltage is low and needs to be charged.

PROBLEM: Will not take off.

SOLUTION: (1) Check the rotor blades for proper installation.
(2) Battery is not fully charged.
(3) Check motors and props for damage.

PROBLEM: Drone is shaking.

SOLUTION: Check the canopy, chassis, motors and rotor blades for damage.

SAFETY PRECAUTIONS

Follow these safety precautions when operating this or any model drone.

- Adult supervision required.
- Do not touch the spinning blades or fly over another person's head.
- Keep your face and body as well as all spectators away from the rotors whenever the battery is connected.
- Stay clear of buildings, trees and power lines. **AVOID** flying in or near crowded areas. **DO NOT** fly close to people, children or pets.
- Maintain a safe pilot-to-drone distance while flying.
- Your KODO drone should not be considered a toy, but rather a small, working model. If not operated correctly, the model could possibly cause injury to you or spectators and damage to property.
- Do not alter or modify the model, as doing so may result in an unsafe or unflyable model.
- You must check the operation of the model before every flight to insure that the model has remained structurally sound.

CAUTION: Changes or modifications to this product not expressly approved by the party responsible for compliance may void the user's authority to operate the equipment.

BATTERY PRECAUTIONS

The KODO is equipped with a rechargeable 3.7V LiPo battery. Please pay attention to the following cautions for safe use:

- Parental guidance is recommended when installing batteries.
- Only use the included charger with the flight battery.
- Do not attempt to use this charger with NiCd or NiMH battery packs.
- Do not attempt to use a damaged battery.
- This product contains a LiPo battery. Must be recycled or disposed of properly.
- Do not leave the charger unattended while charging. Disconnect the battery and unplug the charger immediately if either becomes hot! However, it is normal for the charger to get warm.
- Disconnect the battery from the charger and carefully move the battery to a fireproof location if the battery begins to swell or smoke!
- Never allow the battery temperature to exceed 140° F [60° C].

- Do not attempt to charge a battery if it is swollen or hot.
- Do not place the charger or any battery on a flammable surface or near combustible materials while in use.
- Always disconnect the battery and remove the charger from the USB port when not in use.
- Land your model immediately when the LEDs flash to indicate that the battery power is low. Recharge the battery before attempting another flight. A dangerous situation can occur when attempting to recharge an over-discharged battery!
- Never disassemble or modify pack wiring in any way or puncture cells.
- ALWAYS keep a supply of sand accessible when charging. Dumping sand on the battery will extinguish a LiPo chemical fire.
- Never charge inside a vehicle.
- ALWAYS KEEP OUT OF REACH OF CHILDREN
- Do not dispose of battery into fire or heat.
- Do not use or leave battery near a heat source, such as a fire or a heater.
- Do not strike, pierce or throw against a hard surface.
- Do not disassemble or alter battery.
- Turn off power switch and disconnect the battery after use.



FCC STATEMENT AND INDUSTRY CANADA NOTICE

1. This device complies with Part 15 of the FCC Rules and RSS-210 of Industry Canada. Operation is subject to the following two conditions:

- (1) This device may not cause harmful interference, and
- (2) This device must accept any interference received, including interference that may cause undesired operation.

2. Changes or modifications not expressly approved by the party responsible for compliance could void the user's authority to operate the equipment.

Remark: This device is in accordance with the digital device grade B limitation and the 15th regulation of FCC. This limitation requires reasonable anti-interference protection around the residence. The device can transmit radio waves during use and can interrupt the mobile communication without proper installment.

Interruption will occur for special device. If the device does interrupt the radio or television, please turn the device off and then turn it on to adjust. Below are some resolutions for your reference:

- Move the receiving antenna
- Enlarge the distance between the device and receiver
- Try to not connect the device and the receiver on the same circuit
- Ask for professional help from experts

3. This digital apparatus does not exceed the Class B limits for radio noise emissions from digital apparatus set out in the Radio Interference Regulations of Industry Canada.

NOTE: THE MANUFACTURER IS NOT RESPONSIBLE FOR ANY RADIO OR TV INTERFERENCE CAUSED BY UNAUTHORIZED MODIFICATIONS TO THIS EQUIPMENT. SUCH MODIFICATIONS COULD VOID THE USER'S AUTHORITY TO OPERATE THE EQUIPMENT.

90-DAY LIMITED WARRANTY

PLEASE DO NOT RETURN YOUR PRODUCT TO THE STORE. Dromida will repair or replace factory defects for 90 days from the date of purchase. This warranty specifically does not cover crash damage, misuse or abuse. To make a warranty claim, please contact our product support team at **1-217-398-8970 ext #5** or e-mail us at **helihotline@greatplanes.com**.

If requested by Product Support, please send defective product to:

Hobby Services
3002 N Apollo Dr., Suite #1
Champaign, IL 61822

Please include a note about the problem, your contact information, and a copy of the receipt.

This warranty applies only if the product is operated in compliance with the instructions and warnings provided with each model. Dromida assumes no liability except for the exclusive remedy or repair of parts as specified above. Dromida shall not be liable for consequential or incidental damages. Some states do not allow the exclusion of consequential or incidental damages so the above exclusion may not apply to you. This warranty gives you specific legal rights and you may also have other rights which vary from state to state.

REPLACEMENT PARTS

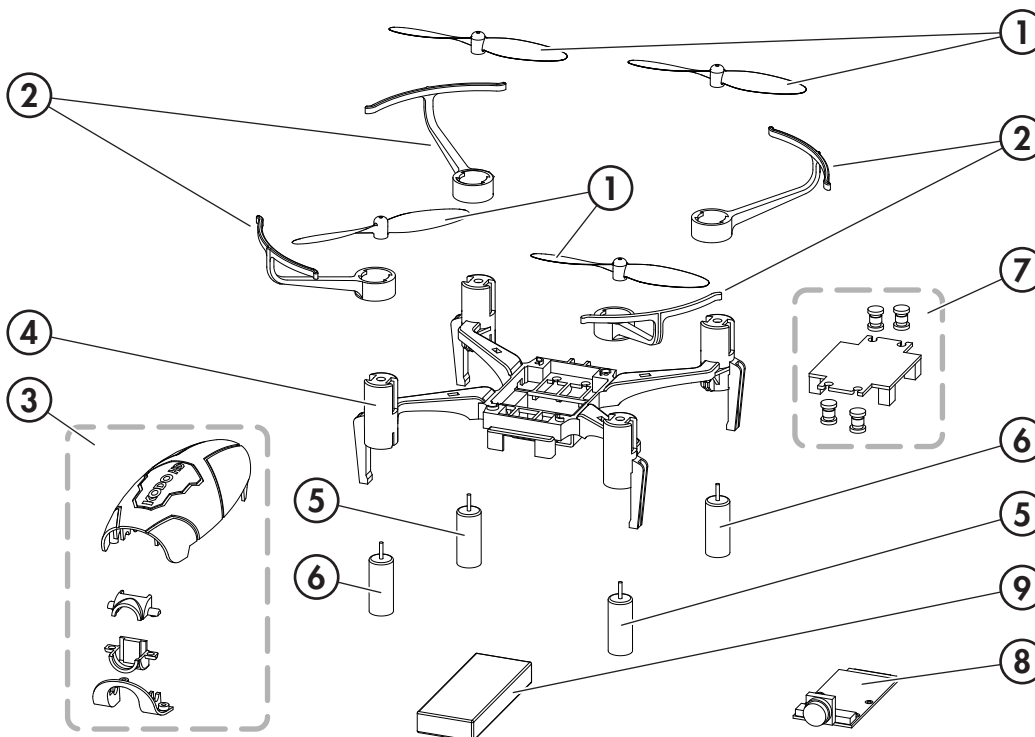

| Part No. | Key No. | Description |
|----------|---------|---|
| DIDE1552 | 1 | Rotor Blade Set Black & Yellow (4) |
| DIDE1553 | 2 | Blade Guard Set (4) |
| DIDE1554 | 3 | Upper Body 3 Lens Housing top 3 Lens Housing bottom 3 Lens frame |
| DIDE1555 | 4 | Frame |
| DIDE1556 | 5 | Motor CCW R/F L/R (2) |
| DIDE1557 | 6 | Motor CW L/F R/R (2) |
| DIDM1558 | 7 | Control board |
| | 7 | Dampers |
| DIDZ1559 | 8 | Camera board |
| DIDZ1559 | 8 | Lens |
| DIDE1550 | 9 | Battery |
| DIDE1551 | | Transmitter |
| DIDE1511 | | USB Charger |
| DIDZ1501 | | Card reader |