Contents

Maintenance	1
Features	1
Accessories and optional	2
Instruction manual	3-4
Basic operation	5-8
Operation	9-14
Self-Programming mode	15-17
Deleting stored channels	18
Specification	20
Troubleshooting Guide	21

UNPACKING AND CHECKING EQUIPMENT

Carefully unpack the radio. We recommend that you identify the items listed in the following table before discarding the packing material. If any items are missing or have been damaged during shipment, file a claim with the carrier immediately.

Supplied Accessories

ITEMS	QUANTITY
Radio	1
Antenna	1
Battery	1
Rapid Charger	1
Belt Clip	1
Users' Manual	1

Optional Accessories

ITEMS
Earphone
Microphone
Connecting cable
Programmable software

Maintenance

Your Two Way Radio is an electronic product of exact design and should be treated with care .The suggestions below will help you to fulfill any warranty obligations and to enjoy this product for many years.

- Do not attempt to open the unit. Non-expert handling of the unit may damage it.
- When using regulated power supply, take notice of power voltage must be between 6V and 8V to avoid damaging the unit.
- Do not store the Radio under the sunshine or in hot areas.
High temperatures can shorten the life of electronic devices, and warp or melt certain plastics.
- Do not store the Radio in dusty, dirty areas
- Keep the Radio dry. Rainwater or damp will corrode electronic circuits.
- If it appears that the Radio diffuses peculiar smell or smoke, please shut off its power immediately and take off charger or battery in the Radio, then contact with PUXING agency.
- Do not transmit without antenna.

Feature

UHF4W Output power

118 groups of memory channels.

12.5KHz Channel spacing

Automatic Numbering Identification (ANI) code

Built-in Voice Operate Transmit (VOX) function.

All channels scan and priority channel scan

Scrambler

Three color LCD backlight adjustable

Emergency alarm

Programmable by pc with software

50 CTCSS and 104 DCS Normal/Inverted selectable

Time-out Timer (TOT)

Busy channel lockout

Instruction manual

Key, Knob, Switch, Indicator

■ Power/volume On-off	For opening and closing power, and control volume.
■ Sending indicator	Press PTT switch and it glows, which indicates talking is in sending status.
■ Busying indicator	When monitor key and squelch are opened,  shows on the LCD which means the radio is in busying status.
■ PTT key	Switch in sending and receiving signal.
■ MON (monitor) Key	Hold down this key in receiving and it can monitor the case in working channel, busying indicator lights after holding down monitor key.
■ Call key	Call to your partner
■ CLR	For returning key and other function.

Socket and connector

■ SMA Connector	For connecting attached antenna
■ Speaker/microphone jack	If you want to use speaker, microphone or programming cable, connect them with this socket. If not, prevent water from dropping into it.

Screen

You can see various icon show on the screen when power on. The following table can help you identification the icon meaning which display on LCD.

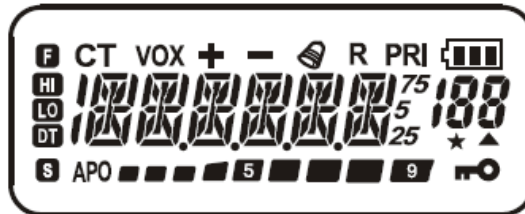

<input type="checkbox"/>		Battery power display
<input type="checkbox"/>		Dispersion to hyper-received frequency
<input type="checkbox"/>		Dispersion to under-received frequency
<input type="checkbox"/>		Frequency scanning indication
<input type="checkbox"/>		Keypad locked
<input type="checkbox"/>		Display when DCS is turned on
<input type="checkbox"/>		CTCSS turned on
<input type="checkbox"/>		VOX turned on
<input type="checkbox"/>		Bell Function
<input type="checkbox"/>		Display reverse frequency
<input type="checkbox"/>		Priority scan active
<input type="checkbox"/>		Received signal strength and power display
<input type="checkbox"/>		Show the working frequency
<input type="checkbox"/>		Function menu
<input type="checkbox"/>		Display when the channel is priority scan
<input type="checkbox"/>		Squelch open

Basic operation

Connected antenna

Insert the base of the attached antenna into SMA connector and coincided with each other by clockwise rotate antenna, make sure the antenna has set down. Take out the antenna from the base by counter clockwise rotation until pull out it from SMA connector.

Turn on and off the power

If you want to turn on the power, rotate PWR/VOL knob by clockwise until beep sound is heard .All icons and frequencies appeared on the screen. (Due to have automatic squelch function, the speaker will not send out any sound before receiving call.) You can adjust your desired volume by turning the button. If you turn off the power, turn PWR/VOL knob in counter clockwise rotation until beep sound is heard .All displays will disappear and the radio is off.

Adjusting volume

After turning on the power, (Due to have automatic squelch function, the speaker will not send out any sound before receiving call.) You can hold down [MONI] key, and then turn PWR/VOL knob to increase the volume in clockwise rotation and decrease the volume in counter clockwise rotation.

Monitoring function

If only hold down [MONI] key and adjust your desired volume by PWR/VOL knob, you can directly hear sound without waiting for receiving any signals.

Basic operation

Connected antenna

Insert the base of the attached antenna into SMA connector and coincided with each other by clockwise rotate antenna, make sure the antenna has set down. Take out the antenna from the base by counter clockwise rotation until pull out it from SMA connector.

Turn on and off the power

If you want to turn on the power, rotate PWR/VOL knob by clockwise until beep sound is heard .All icons and frequencies appeared on the screen. (Due to have automatic squelch function, the speaker will not send out any sound before receiving call.) You can adjust your desired volume by turning the button. If you turn off the power, turn PWR/VOL knob in counter clockwise rotation until beep sound is heard .All displays will disappear and the radio is off.

Adjusting volume

After turning on the power, (Due to have automatic squelch function, the speaker will not send out any sound before receiving call.) You can hold down [MONI] key, and then turn PWR/VOL knob to increase the volume in clockwise rotation and decrease the volume in counter clockwise rotation.

Monitoring function

If only hold down [MONI] key and adjust your desired volume by PWR/VOL knob, you can directly hear sound without waiting for receiving any signals.

Transmitting

Firstly, hold down [MONI] a moment to make sure that the channel isn't in busy status and press [PTT] key then speak to the radio in ordinary tone.

Transmitting indicator lighting during holding down [PTT] key.

If you are too close to the microphone or your voice is too loud, it's not clear in receiving.

Release [PTT] key so as to listen a response from your partner.

Emergency Alarm

Hold down [CALL] key for 1 second and press [MONI] key the radio will emergency alarm.

Call to receiver

Press and hold the [CALL] key for 2 seconds .The receiver will ring.

Keypad Lock

In channel/Frequency mode, press and hold down *** LOCK** for two seconds the keypad will Lock. Press and hold down *** LOCK** for two seconds to unlock the keypad.



Setting Reverse Frequency Function

In channel/Frequency mode, to select Reverse frequency function, hold down **# T-R** for two seconds until "R" appears on LCD. To cancel it hold down **# T-R** for two seconds.

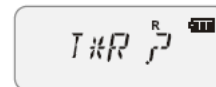

Scanning

Scanning is applicable to monitor your need frequency without manual.

Scan entire channel

In channel/Frequency status, press **MENU** and **1 SCAN** key the radio will scan from current channel through all the channels, whenever any activity is detected, the radio will suspend the scan for 5 seconds. It will then continue to scan unless you press PTT key or **ENTER** key to end scanning.

Priority channel scan

In Frequency Mode, Press **MENU** and **2 PRI** the radio will scan from current frequency through all the frequency range within 1MHz, whenever any activity is detected, the radio will suspend the scan for 5 seconds. It will then continue to scan unless you press PTT key or **ENTER** key to end scanning.

In channel mode, Press **MENU** and **2 PRI** the radio will scan from current channel through all the channels, whenever any activity is detected, the radio will suspend the scan for 5 seconds. It will then continue to scan unless you press PTT key or **ENTER** key to end scanning.

DTMF Code

In channel/Frequency status, press PTT and input the number on keypad, MENU stands for A, ENTER stands for B, CLR stands for C, CALL stands for D.

MENU → A

CLR → C

ENTER → B

CALL → D

Flank Keys

Moni + CALL : Emergency Alarm, press Moni and call key, Emergency Alarm on

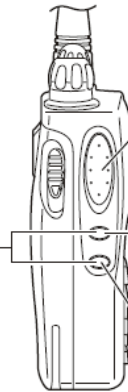

PTT : Press PTT to send singal and release it to receive

Moni : Press Moni key to montor working frequency

CALL : Press CALL to call to your partner

Operation

Switching between channels and Frequencies.

Hold down **ENTER** key and turn on the power, the radio can switch between channel and Frequency mode.

Select VOX sensitivity level

In channel/Frequency mode, if you want to open VOX, press **MENU** and **3 VOX** until "VOX OFF" displays, input the number on keypad (0-9) or turn the encoder to select the sensitivity level, then press **ENTER**. Press **CLR** key to exit. "VOX OFF" set in default factory state.



Setting transmit power

In channel/Frequency mode, hold down **MENU** and **4 POWER** key until "POW L" displays which means Low Power. Turn the encoder until "POW H" appears, it means high power and it is two times than low power. Transmit power level is programmable by using programming software.



Setting squelch

In channel/Frequency mode, hold down **MENU** and **5 SQL** until "SQL 5" displays, input the number on keypad (0-9) or turn the encoder then press **ENTER**. Press **CLR** to exit. "SQL 5" set in default factory state.



Scrambler on/off

Hold down **MENU** and **6 SCR** so that "on" displays. Turn the encoder to select on/off then press **ENTER** . Press **CLR** to exit. (This Function is optional)



Backlight on/off

To turn backlight on. Hold down **MENU** and **7 LED** so that "on" displays, turn the encoder to select from ON, OFF, AUTO and press **ENTER** . Press **CLR** to exit.



Select backlight color

Hold down **MENU** and **8 COLOR** so that "LIGHT2" displays, turn the encoder to select one color then press **ENTER** . Press **CLR** to exit. Total three colors are selectable.

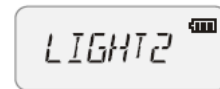

Beep on/off

To turn Beep on, hold down **MENU** and **9 BEEP** so that "on" displays. To close Beep turn the encoder until "off" displays, then press **ENTER** . Press **CLR** to exit.



Automatic Numbering Identification (ANI) on/off

To show caller ID on display while the caller press PTT switch. Hold down **MENU** and **0 ANI** so that "on" display, to close ANI please turn the encoder until "off" displays, then press **ENTER** . Press **CLR** to exit.



Setting the direction of potential difference

To set transmitting frequency higher (+) or lower (-) than receiving frequency. Select needed receiving frequency then press **MENU** and **# T-R** , repeat to operate will switch among, +, - and simplex.



Select beat frequency

This function is used to determine the difference (Potential difference) between sending frequency and receiving frequency.

Press **MENU** key and turn the encoder until "DIFFR ?" displays, press **ENTER** key and input needed frequency, Range from 00.000 to 70.995MHz ,then press **ENTER** key to confirm.



Select frequency stepping

Press **MENU** key and turn the encoder until "STEP ?" displays, press **ENTER** key and turn the encoder to select frequency stepping from 5k, 10k, 6.25k, 12.5k, 25k; then press **ENTER** to confirm, press **CLR** to exit.



Menu Operation

1. Press **MENU** into menu mode.
2. Turn the Encoder to selected menu.
3. Press **ENTER** and turn the encoder to set then press **ENTER** key to confirm.
4. Press **CLR** twice to exit Menu mode.

Menu Operation List

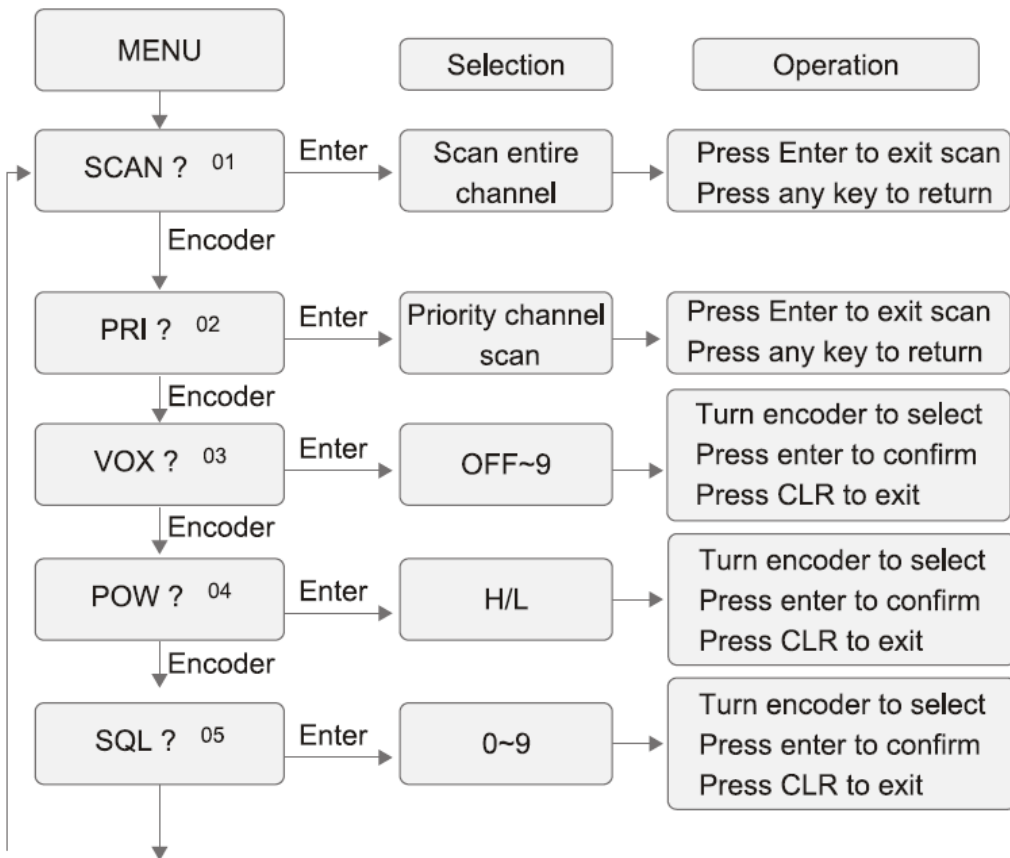

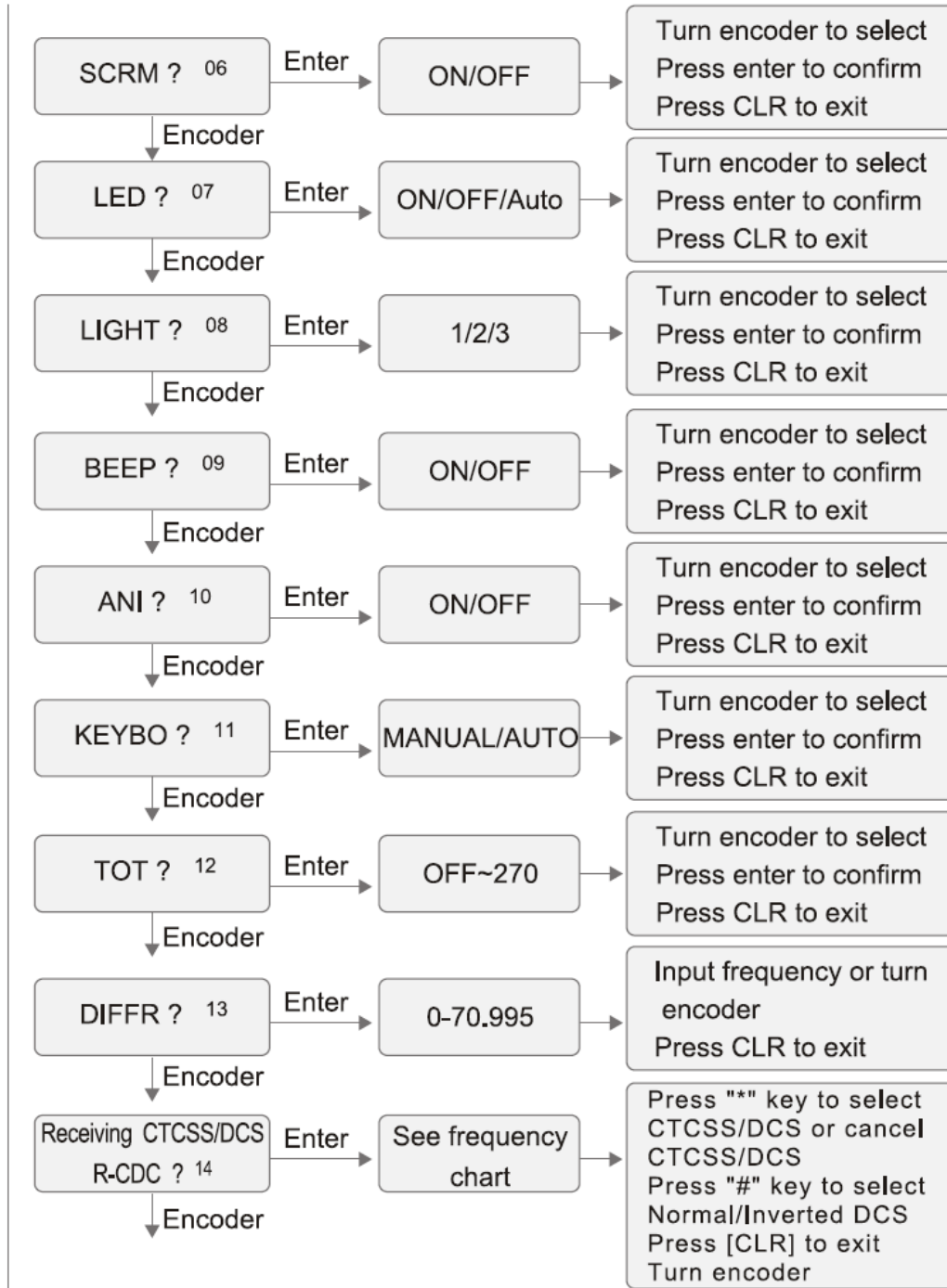

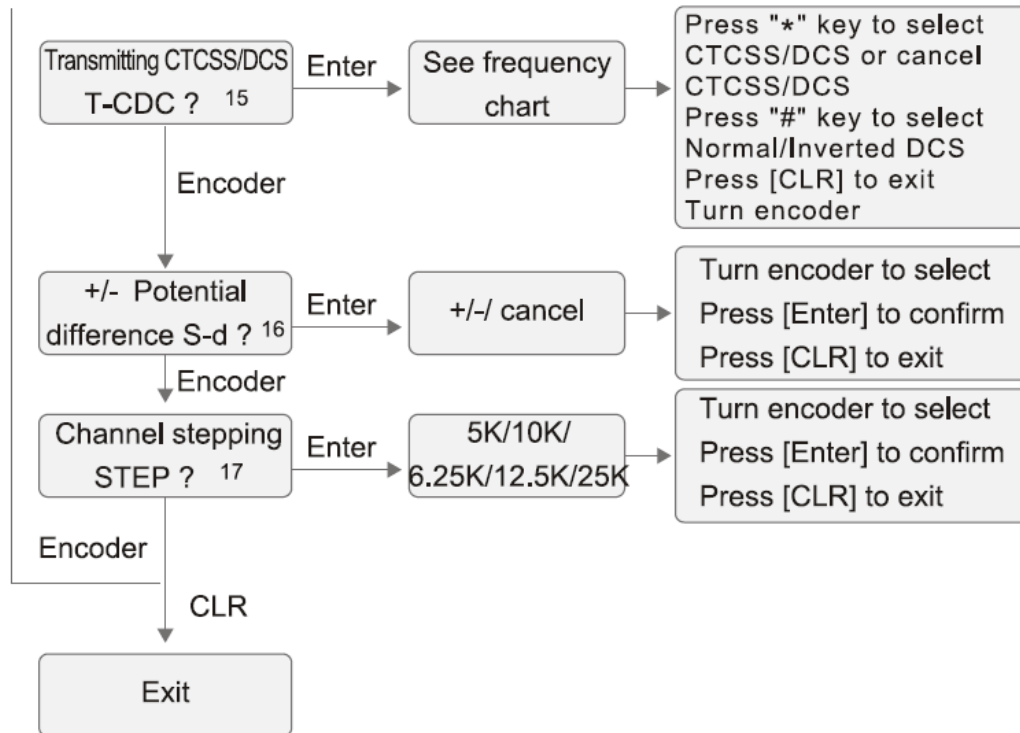

Notice: Items 13-17 is available only in Frequency mode.

Self-Programming mode

You can set the radio by self-programming.



Operation

1. To enter self-programming mode, hold down (MONI) and **MENU** key accomplished by turning on the VOL/POWER switch until "SELF" displays.



2. Press Enter key to start.
3. Press [ENTER] to store the data and continue to next function.

Items	Display (example)	Contents
Channels Items below are not available if without setting "Channels"		Channels from 1 to 118
Receiving frequency Items below are not available if without setting "Receiving frequency" It will return to "Channels" if "blank" was selected		Blank. (Press CLR)
		67.0000MHz~549.9875MHz Press [CALL] key to select from 5k/10k/6.25k/12.5k/25k stepping
Receiving CTCSS/DCS (This item will be skip if without setting "channels")		OFF
		CTCSS (see CTCSS Frequency chart) 67.0Hz-250.3Hz {Notice: (1)}
		DCS (see DCS Normal/Inverted chart) 023-754 Normal {Notice: (2)}
		DCS (see DCS Normal/Inverted chart) 023-754 Inverted {Notice: (2)}

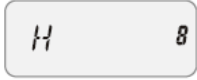
Transmitting frequency		Same as Receiving Frequency
Transmitting CTCSS/DCS (This item will be skip if without setting "transmitting frequency")		Same as Receiving CTCSS/DCS
Busy Channel Lockout		OFF: Close; 1: Carrier 2: CTCSS/DCS
Add/Del priority channel scan		Del: Delete priority channel scan Add: Add priority channel scan
Output Power		H: High power L: Low power

Notice

1. Set Receiving/transmitting codes

Press *** LOCK** key to select from OFF/CTCSS/DCS



2. Press **# T-R** to set DCS Normal/Inverted

Self-programming chart

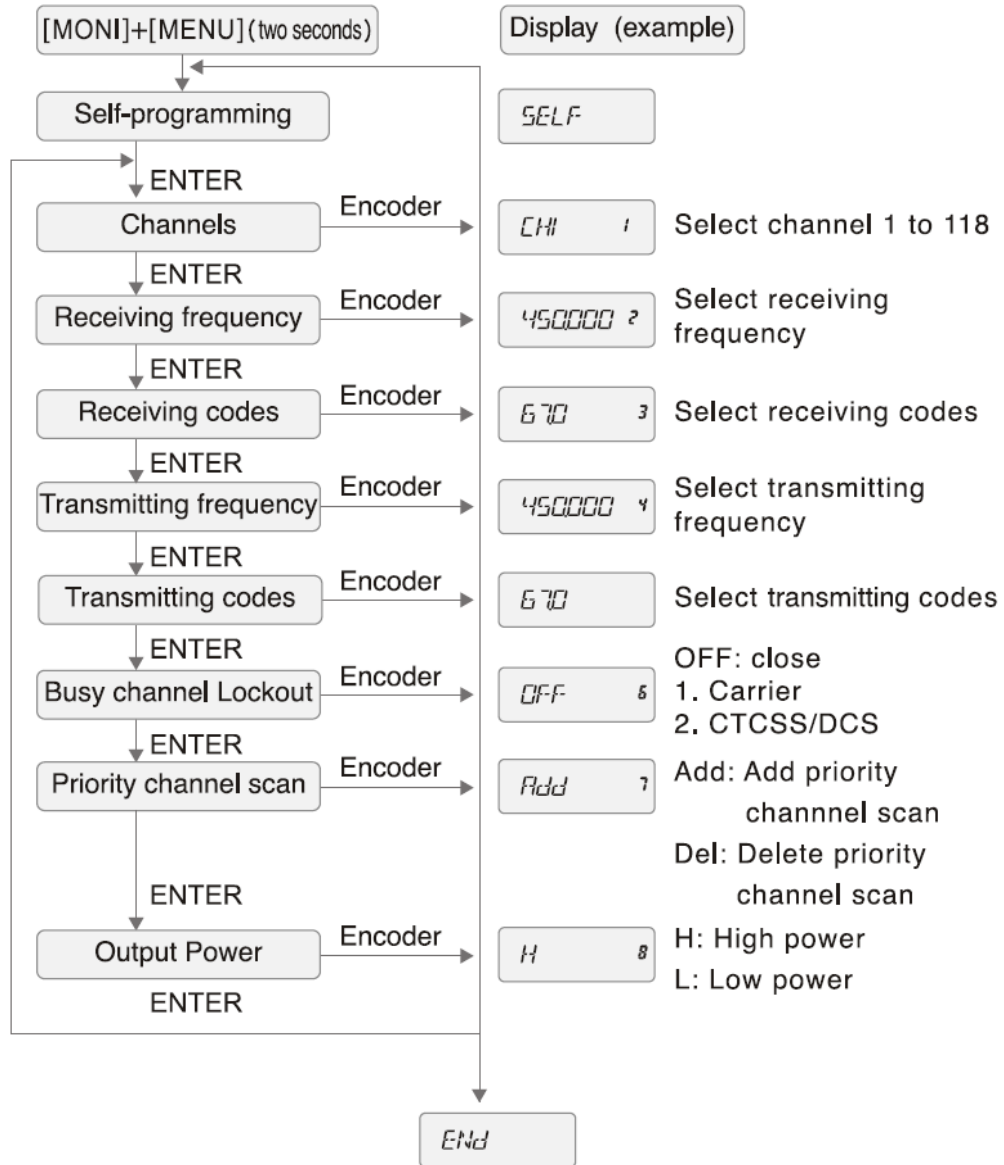

Deleting Stored Channels

1. Enter into self programming.
2. Press [Enter] key.
3. Turn the encoder to the channel, which need to be deleted.
4. Press [Enter] key.
5. Press **CLR** key to delete the channel (.....2 displays on LCD).
6. Press [Enter] key to delete next channel.
7. Repeat 3 to 6.

Enclosed chart

50 CTCSS frequency code (Hz)

67.0	85.4	107.2	136.5	165.5	186.2	210.7	254.1		
69.3	88.5	110.9	141.3	167.9	189.9	218.1			
71.9	91.5	114.8	146.2	171.3	192.8	225.7			
74.4	94.8	118.8	151.4	173.8	196.6	229.1			
77.0	97.4	123.0	156.7	177.3	199.5	233.6			
79.7	100.0	127.3	159.8	179.9	203.5	241.8			
82.5	103.5	131.8	162.2	183.5	206.5	250.3			

104+1 DCS code

023	065	132	205	255	331	413	465	612	723
025	071	134	212	261	332	423	466	624	731
026	072	146	223	263	343	431	503	627	732
031	073	145	225	265	346	432	506	631	734
032	074	152	226	266	351	445	516	632	743
036	114	155	243	271	356	446	523	645	754
043	115	156	244	274	364	452	526	654	
047	116	162	245	306	365	454	532	662	
051	122	165	246	311	371	455	546	664	
053	125	172	251	315	411	462	565	703	
054	131	174	252	325	412	464	606	712	

TROUBLESHOOTING GUIDE

PROBLEM	SOLUTION
No Power	<ul style="list-style-type: none">• The battery pack may be dead.Recharge or replace the battery pack.• The battery pack may not be installed correctly. Remove the battery pack and install it again.
Battery power dies shortly after charging	<ul style="list-style-type: none">• The battery pack life is finished.Replace the battery pack with a new one.
Cannot talk to or hear other members in your group	<ul style="list-style-type: none">• Make sure you are using the same frequency and CTCSS/DCS tone as the other members in your group.• Other group members may be too far away. Make sure you are within range of the other radios.
Other voices (besides group members) are present on the channel.	<ul style="list-style-type: none">• Change the CTCSS/DCS tone.Be sure to change the tone on all radios in your group.

■ User Safety, Training, and General Information

- READ THIS IMPORTANT INFORMATION ON SAFE AND EFFICIENT OPERATION BEFORE USING YOUR PUXING PORTABLE TWO-WAY RADIO.

Operational Instructions and Training Guidelines

To ensure optimal performance and compliance with the occupational/controlled environment RF energy exposure limits in the above standards and guidelines, users should transmit no more than 50% of the time and always adhere to the following procedures:

Transmit and Receive

To transmit (talk), push the Push-To-Talk (PTT) button; to receive, release the PTT button.

Hand-held radio operation

Hold the radio in a vertical position with the microphone one to two inches (2.5 to 5 cm) away from the lips.

FCC Compliance

This equipment has been tested and found to comply with the limits for a Class B digital device, pursuant to part 90 of the FCC Rules. These limits are designed to provide reasonable protection against harmful interference in a residential installation. This equipment generates, uses and can radiate radio frequency energy and, if not installed and used in accordance with the instructions, may cause harmful interference to radio communications. However, there is no guarantee that interference will not occur in a particular installation. If this equipment does cause harmful interference to radio or television reception, which can be determined by turning the equipment off and on, the user is encouraged to try to correct the interference by one or more of the following measures:

- Reorient or relocate the receiving antenna.
- Increase the separation between the equipment and receiver.
- Connect the equipment into an outlet on a circuit different from that to which the receiver is connected.
- Consult the dealer or an experienced radio/TV technician for help.

FCC Requirements

Your radio must be properly licensed Federal Communications Commission prior to use. Your dealer can assist you in meeting these requirements. Your dealer will program each radio with your authorized frequencies, signaling codes, etc., and will be there to meet your communications needs as your system expands.

Safety:

It is important that the operator is aware of and understands hazards common to the operation of any radio.

READ THIS IMPORTANT INFORMATION ON SAFE AND EFFICIENT OPERATION

BEFORE USING YOUR HYT PORTABLE TWO-WAY RADIO.

- ◇ Only qualified technicians are allowed to maintain this product.
- ◇ To avoid electromagnetic interference and/or compatibility conflicts, turn off your radio in any place where posted notices instruct you to do so. Hospitals or health care facilities may be using equipment that is sensitive to external RF energy. When on aircraft, turn off your radio when airline crew instruct you to do so.
- ◇ When in vehicles with an airbag, do not place a portable radio in the area over an airbag or in the airbag deployment area.
- ◇ Turn off your radio prior to entering any area with a potentially explosive atmosphere. Do not remove, install, or charge batteries in such areas.
- ◇ To avoid possible interference with blasting operations, turn off your radio when you are near electrical blasting caps.
- ◇ Do not use any portable radio that has a damaged antenna. If a damaged antenna comes into contact with your skin, a minor burn may result.
- ◇ Do not expose the radio in direct sunlight for a long time nor place it close to a heating source.
- ◇ When transmitting with a portable radio, hold the radio in a vertical position with its microphone about 5 centimeters away from your mouth.
- ◇ If you wear a portable two-way radio on your body, ensure that the antenna is at least 2.5 centimeters from your body when transmitting.