



HOMEOWNERS MANUAL

# TED28 BC



ELECTRIC FIREPLACE INSERT



## INSTALLER / CONSUMER SAFETY INFORMATION

**PLEASE READ THIS MANUAL BEFORE INSTALLING AND USING APPLIANCE**

### WARNING

*IF THE INFORMATION IN THIS MANUAL IS NOT FOLLOWED EXACTLY, AN ELECTRICAL SHOCK OR FIRE MAY RESULT CAUSING PROPERTY DAMAGE, PERSONAL INJURY OR LOSS OF LIFE.*

### FOR YOUR SAFETY

*(Service must be performed by a qualified service agency.)  
DO NOT STORE OR USE GASOLINE OR OTHER FLAMMABLE VAPORS OR LIQUIDS IN THE VICINITY OF THIS OR ANY OTHER APPLIANCE.*



Scan the below QR code to download Smart Flame.



SAVE THESE INSTRUCTIONS



**IF YOU HAVE ANY PROBLEMS OR QUESTIONS, EMAIL OR CALL CUSTOMER SERVICE BEFORE YOU RETURN THIS PRODUCT TO THE STORE WHERE IT WAS PURCHASED.**

### FOR CUSTOMER SERVICE:

✉ [INFO@MASTERFLAMEFIREPLACE.COM](mailto:INFO@MASTERFLAMEFIREPLACE.COM) ☎ 1-855-837-2569

# General

1. Read all instructions before using this appliance.
2. This heater is hot when in use. To avoid burns, do not let bare skin touch hot surfaces. Keep combustible materials, such as furniture, pillows, bedding, papers, clothes and curtains at least 3 feet (0.9m) from the front of this heater and keep them away from the sides and rear.
3. **CAUTION:** Extreme caution is necessary when any heater is used by or near children or invalids and whenever the heater is left operating unattended.
4. Always unplug this appliance when not in use.
5. Do not operate any heater with a damaged cord or plug or after the appliance malfunctions, has been dropped or damaged in any manner. Return heater to authorized service facility for examination, electrical or mechanical adjustment, or repair.
6. Any repairs to this appliance should be carried out by a licensed service person.
7. Under no circumstances should this appliance be modified.
8. Do not use outdoors.
9. This heater is not intended for use in bathrooms, laundry areas and similar indoor locations. Never locate heater where it may fall into a bathtub or other water container.
10. Do not run cord under carpeting. Do not cover cord with throw rugs, runners or similar covering. Arrange cord away from traffic areas and where it will not be tripped over.
11. To disconnect this appliance, turn controls to the off position, then remove plug from outlet.
12. Connect to properly grounded outlets only.
13. This appliance, when installed must be electrically grounded in accordance with local codes, with the current CSA C22.1 Canadian Electrical codes or for USA installations, follow local codes and the National Electric Code, ANSI/NFPA No. 70.
14. Do not insert or allow foreign objects to enter any ventilation or exhaust opening as this may cause an electric shock, fire or damage the heater.
15. To prevent possible fire, do not block air intakes or exhaust in any manner. Do not use on soft surfaces, like a bed, where openings may become blocked.
16. This heater has hot and arcing or sparking parts inside. Do not use it in areas where gasoline, paint or flammable liquids are used or stored. This appliance should not be used as a drying rack for clothing, nor should Christmas stockings or decorations be hung on or near it.
17. Use this appliance only as described in this manual. Any other use not recommended by the manufacturer may cause fire, electric shock or injury to persons.
18. Always plug heaters directly into a wall outlet/receptacle. Never use with an extension cord or relocatable power tap (outlet/power strip).
19. The heater has a safety device that makes it stop working once the inner temperature reaches 85° (± 2°C). To reset the appliance, turn heater off and disconnect power, let it cool off for 10 minutes and plug back in.
20. When the mantel slide doors cover the firebox, the firebox will be closed, if you move away the doors, the firebox will restart to work. Make sure the power is turned off when you are not use the unit.
- 21. The firebox can be controlled with Bluetooth by Iphone and Android mobile phone, please refer to the page E-5, E-6 for detailed operation instructions.**
- 22. SAVE THESE INSTRUCTIONS**

## LOCATING YOUR FIREPLACE

Your new electric fireplace may be installed on the floor only in your home. This fireplace is an insert fireplace and can't be used as an movable fireplace. However, when choosing a location for your electric fireplace, ensure that the general instructions are followed. Also, for best effect, install the electric fireplace away from direct sunlight and dust.

# SERVICE INSTRUCTIONS

## USER INSTRUCTIONS

1. Any repairs to this appliance should be carried out by a qualified service person.
2. Under no circumstances should this appliance be modified. Parts having to be removed for servicing must be replaced prior to operating this appliance again.
3. This firebox is to be cleaned with a damp cloth (water) only. Do not use any abrasive cleaners on the unit.
4. Please unplug this firebox when not in use.
5. If using firebox in existing fireplace, please clean/vacuum thoroughly before inserting the firebox. Vacuum firebox vents periodically to avoid dust buildup for long lasting use.

## TEMPERED GLASS INFORMATION

1. Under no circumstances should this product be operated with broken glass.
2. Do not strike or slam the glass.
3. Do not use abrasive cleansers to clean the glass.
4. This product uses tempered glass. Replacement of the glass supplied by the manufacturer should be done by a qualified service person.

## FIREBOX SPECIFICATIONS

Fireplace Insert Dimensions(W x D x H)	23 1/8 x 7 x 17 5/8 inch 59 x 17.9 x 44.8 cm
Net Weight / Gross Weight	9.2 kg / 10.2 kg
Voltage	120V~
Frequency	60Hz
Watts	1500 Watts

## ELECTRICAL CONNECTION

Preferably, the fireplace will be on a dedicated circuit as other appliances on the same circuit may cause the circuit breaker to trip or the fuse to blow when the heater is in operation. The unit comes standard with 6ft. (1800mm) three prong cord, exiting from the rear of the fireplace. Plan the installation to avoid the use of an extension cord. Always plug heaters directly into a wall outlet/receptacle. Never use with an extension cord or relocatable power tap(outlet/power strip).

## WARNING



- ▲ Do not use this fireplace insert if any part of it has been under water. Immediately call a qualified service technical to inspect the firebox and replace any part of the electrical system which has been under water.
- ▲ During any service of this appliance, the power to the unit must be turned off. First turn the main power switch to the "OFF" position. Then remove the electrical plug from the wall outlet.
- ▲ This device complies with part 15 of the FCC Rules. Operation is subject to the following two conditions: (1) This device may not cause harmful interference, and (2) this device must accept any interference received, including interference that may cause undesired operation.  
Any Changes or modifications not expressly approved by the party responsible for compliance could void the user's authority to operate the equipment.
- ▲ **Note:** This equipment has been tested and found to comply with the limits for a Class B digital device, pursuant to part 15 of the FCC Rules. These limits are designed to provide reasonable protection against harmful interference in a residential installation. This equipment generates uses and can radiate radio frequency energy and, if not installed and used in accordance with the instructions, may cause harmful interference to radio communications. However, there is no guarantee that interference will not occur in a particular installation. If this equipment does cause harmful interference to radio or television reception, which can be determined by turning the equipment off and on, the user is encouraged to try to correct the interference by one or more of the following measures:
  - Reorient or relocate the receiving antenna.
  - Increase the separation between the equipment and receiver.
  - Connect the equipment into an outlet on a circuit different from that to which the receiver is connected.
  - Consult the dealer or an experienced radio/TV technician for help.This equipment complies with FCC radiation exposure limits set forth for an uncontrolled environment. This equipment should be installed and operated with minimum distance 20cm between the radiator & your body.

# OPERATING INSTRUCTIONS

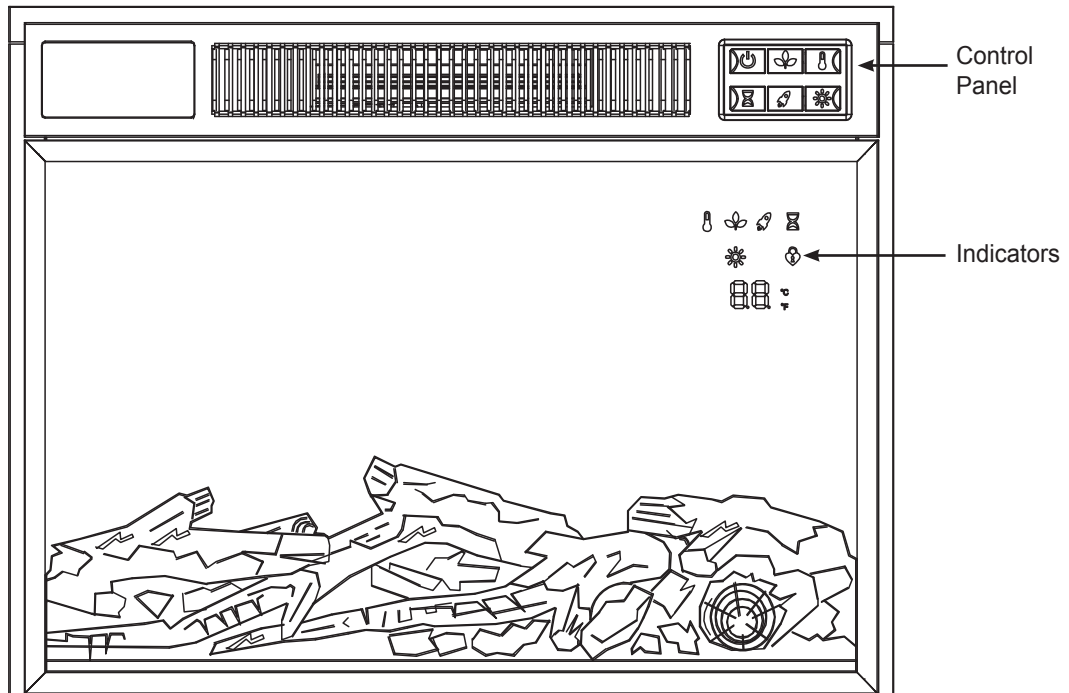

Figure 2

When a function is changed from the control panel or remote there will be a corresponding indicator displayed. The indicator shows the function changed and the level selected. When the function is turned off, the corresponding indicator will fade off.

## GROUNDING INSTRUCTIONS

This heater is for use on 120 volts. The cord has a plug as shown at A in figure 1.

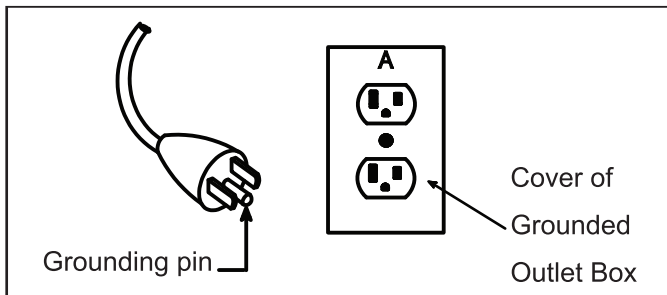

Figure 1 Grounding method

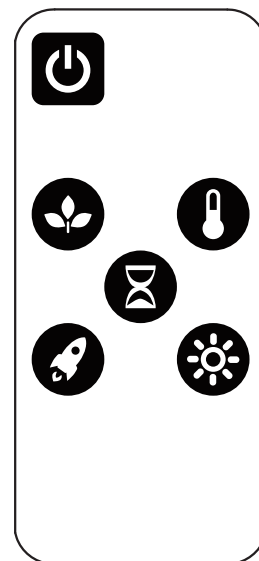









Figure 3

# OPERATING INSTRUCTIONS

FUNCTION	ICON	DESCRIPTION
POWER		<p>This button will not only put the fireplace insert in a standby mode, but also you can see the flame effect through the screen. This will turn off all functions at once.</p> <p>Note: Holding the POWER button for 3 seconds will turn on the Child safety lock. It disables or enables all functions on the control panel and remote control.</p>
HEATER		<p>The fireplace contains a fan forced heater.</p> <p>The default setting temperature is 72°F (22°C). The thermostat setting range is 50°-86°F or 10°-30°C. The thermostat is adjustable by 2°F or 1°C increments.</p> <p>To change between °F and °C press and hold the HEATER button for 5 seconds.</p>
ECO		<p>Press the ECO button when the heater is on, to run the heater in a reduced wattage range.</p> <p>Note: Holding the ECO button for 3 seconds disables any heater functions.</p>
BOOST		<p>To quickly heat up a cold room/space, press the BOOST button to run the heater at the full rated wattage.</p> <p>Pressing the BOOST button repeatedly will cycle through the following boost settings: 5 minutes, 10min, 15min, 20min, 25min, 30min and off.</p>
TIMER		<p>Pressing the timer button repeatedly will cycle through the following timer settings: 30 minutes, 1 hr, 2 hr, 3 hr, 4 hr, 5 hr, 6 hr, 7 hr, 8 hr and off.</p> <p>The fireplace will automatically turn off when the timer reaches zero minutes.</p>
BRIGHTNESS		<p>This button controls the brightness of the flame effect.</p>

# OPERATING INSTRUCTIONS

Bluetooth Operation Instructions as below. Please make sure  has been opened.

1. Scan the below QR code to download Smart Flame or search “Smart Flame” from Apple APP Store and Google Play Store to download.
2. Register an account with your cellphone number or email adress.
3. Log in and tap  to scan the QR code again to bind the cellphone with the unit.  
Then set any device name as you like.
4. There is notice “Add the device successfully”, that means you have added the unit successfully.
5. Tap the  enter Home interface.

NOTICE: Due to some protecting reason, when you scan QR code via Wechat, click top right to open in Safari or Brower.

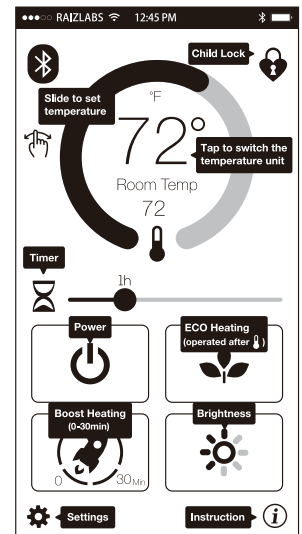
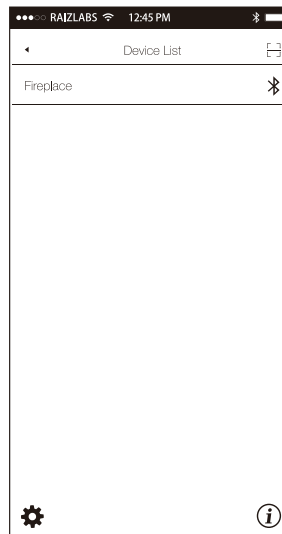
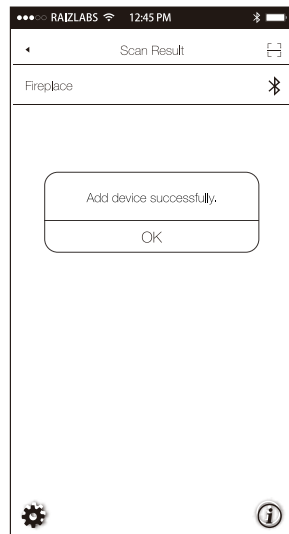
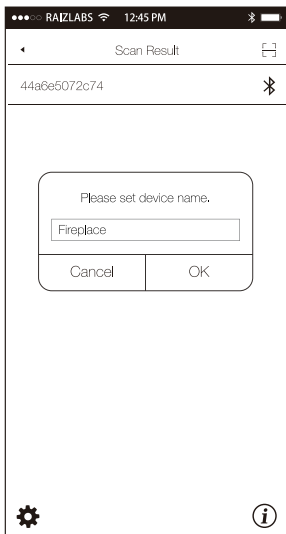
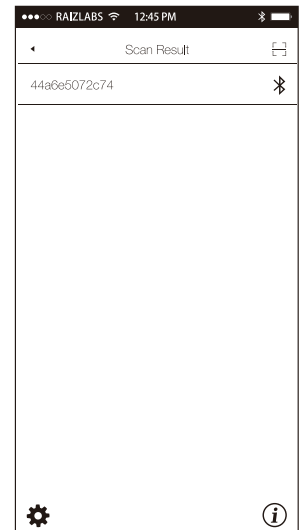
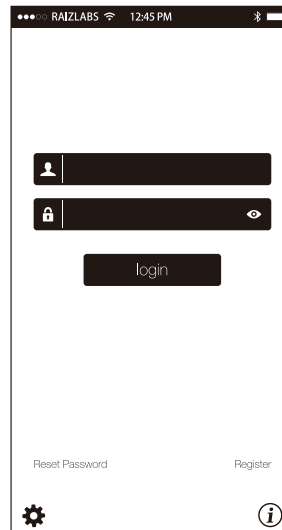

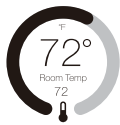









Figure 4

# OPERATING INSTRUCTIONS

FUNCTION	ICON	DESCRIPTION
BLUETOOTH		Press this button to connect the unit and also return back to the Device list interface.
POWER		This button will not only put the fireplace insert in a standby mode, but also you can see the flame effect through the screen. This will turn off all functions at once.
HEATER		<p>Tap the temperature gauge button  open the HEAT function.</p> <p>Slide to set the temperature. Tap the temperature to change between °F and °C.</p> <p>The default setting temperature is 72°F (22°C).</p> <p>The thermostat setting range is 50°-86°F or 10°-30°C.</p> <p>The thermostat is adjustable by 2°F or 1°C increments.</p>
ECO		Press the ECO button when the heater is on, to run the heater in a reduced wattage range.
BOOST		<p>Quickly heat up the room/space with tapping the BOOST button. This will push the heater to full wattage and heat the room up faster.</p> <p>Pressing the BOOST button repeatedly will cycle through the following boost settings: 5 minutes, 10min, 15min, 20min, 25min, 30min and off.</p>
TIMER		<p>Slide the timer through the following timer settings: 30 minutes, 1 hr, 2 hr, 3 hr, 4 hr, 5 hr, 6 hr, 7 hr, 8 hr and off.</p> <p>The fireplace will automatically turn off when the timer reaches zero minutes.</p>
BRIGHTNESS		This button controls the brightness of the flame effect. There are 5 level brightness.
CHILDREN LOCK		Press the button, choose "Yes" to turn on the Child safety lock, it disables or enables all functions on the control panel, remote control and cellphone
SETTING		Press the button to choose "English", "French" and "Spanish". Also find the Customer service information.
INSTRUCTION		To review the instruction manual tap the information icon.

## TROUBLESHOOTING GUIDE

PROBLEM	POSSIBLE CAUSE	CORRECTIVE ACTION
Display shows "E1".	Manual Reset overheat protection has triggered.	Inspect the heater and check that the air inlets and outlets are not blocked as this may cause overheating. Unplug the heater for 10 minutes and allow it to cool down. Plug back in and turn it on; check the heater for signs of overheating. If the problem persists discontinue use of the heater and contact customer service.
Display shows "E2".	The thermostat sensor is broken or disconnected.	Contact customer service for a replacement thermostat sensor.
There is no power.	There is no power to the unit.	Check that unit is plugged into a standard 120V outlet. Press the power button several times and make sure the power is set to the "ON" position.
The heater does not blow warm air.	Thermostat setting is preventing heater from turning on.	Adjust the temperature settings to ensure that the thermostat is set higher than the current room temperature.
Power cord gets warm.	Normal operation.	Check your heater cord and plug connections. Faulty wall outlet connections or loose plugs can cause the outlet or plug to overheat. Be sure the plug fits tight in the outlet. Heaters draw more current than small appliances, overheating of the outlet may occur even if it has not occurred with the use of other appliances. During use check frequently to determine if your plug outlet or faceplate is HOT! If so, discontinue use of the heater and have a qualified electrician check and/or replace the faulty outlet(s).
The remote control is not working.	There is no battery or the signal is poor.	Change the remote battery.  Operate remote control at a slow measured pace. Press the remote control buttons with an even motion and gentle pressure. Repeatedly pressing buttons in rapid succession may cause the transmitter to malfunction.
The noise when the heater is on is louder than normal.	a. The air intakes are dirty or obstructed.	a. Check the air intakes for obstructions or high dust build up.
	b. The blower/heater assembly is defective.	b. Contact Customer Service for a new heater/blower assembly.
Abnormal noise when the heater is not on and the flame effect is on.	The spinner motor is defective.	Contact Customer Service for a new spinner motor.



# INSTRUCTIONS

Periodic cleaning/vacuuming of the fan/heater unit is recommended. Make sure the unit is turned OFF and unplugged whenever you are cleaning the appliance.



Check your heater cord and plug connections. A loose fitting outlet can cause the plug to overheat and/or cause a fire. Be sure plug fits tight in the outlet. Check frequently during use to make sure plug and outlet are not hot. If so, discontinue using heater and have outlet replaced by a qualified electrician.

Note: Heaters draw more current than small appliances, overheating of the outlet may occur even if it has not occurred with the other appliances.



WARNING: Electrical outlet wiring must comply with local building codes and other applicable regulations to reduce the risk of fire, electrical shock and injury to persons.



WARNING: Make sure the power is turned off before proceeding. Any electrical repairs or rewiring of this unit should be carried out by a licensed electrical in accordance with national and local codes.

**If repairing or replacing any electrical component or wiring, the original wire routing, color coding and securing locations must be followed.**



WARNING: Disconnect power before attempting any maintenance or cleaning to reduce the risk of fire, electrical shock or personal injury.

## REPLACING THE REMOTE CONTROL BATTERY

When the remote control stops operating or its range seems reduced, it is time to replace the battery with new ones.

3 volt lithium coin cell type 2025.

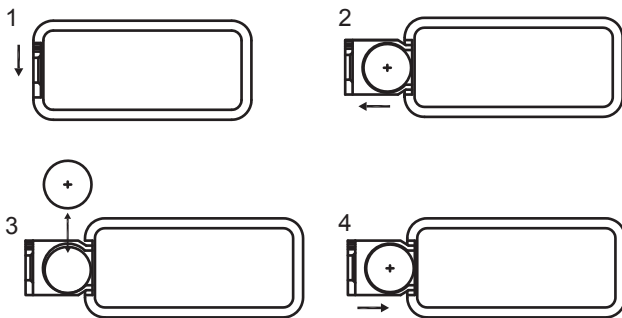

### NOTE:

#### Caution for Ingestion.

Do not mix alkaline, standard (carbon-zinc), or rechargeable (ni-cad, ni-mh, etc) batteries.

Battery should be removed if the product is to be left unused for a long time.

Please operate the remote control at a slow measured pace. Press the remote control buttons with an even motion and gentle pressure. Repeatedly pressing buttons in rapid succession may cause the transmitter to malfunction.

## DISPOSING OF USED BATTERIES

The batteries may contain hazardous substances that could endanger the environment and human health.

This symbol appearing on the battery and/or packaging indicates that used batteries must not be processed with municipal waste. Instead they should be brought to the appropriate collection point for recycling.

By correctly disposing of used batteries, you prevent potential negative consequences for the environment and human health. Recycling used materials also preserves our natural resources.

For more information about collecting and recycling used batteries, please contact your local municipality, your waste disposal service or the store where you purchased this product.

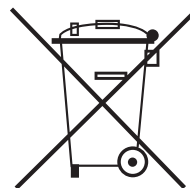

# 1 YEAR WARRANTY

## For Electric Fireplace Insert

### **BASIC WARRANTY:**

***BIG LOTS (hereinafter referred to collectively as the "Company") warrants that your electric fireplace insert is free from manufacturing and material defects for a period of one year from date of installation, subject to the following conditions and limitations.***

1. This electric fireplace insert must be installed and operated at all times in accordance with the Installation and Operating instructions furnished with the product. Any alteration, willful abuse, accident, or misuse of the product shall nullify this warranty.
2. This warranty is non-transferable, and is made to the original owner, provided that the purchase was made through an authorized supplier of the Company.
3. This warranty is limited to the repair or replacement of part(s) found to be defective in material or workmanship, provided that such part(s) have been subjected to normal conditions of use and service, after said defect is confirmed by the Company's inspection.
4. The Company may, at its discretion, fully discharge all obligations with respect to this warranty by refunding the wholesale price of the defective part(s).
5. Any installation, labor, construction, transportation, or other related costs/expenses arising from defective part(s), repair, replacement, or otherwise of same, will not be covered by this warranty, nor shall the Company assume responsibility for same. Further, the Company will not be responsible for any incidental, indirect, or consequential damages, except as provided by law.
6. All other warranties expressed or implied with respect to the product, its components and accessories, or any obligations/liabilities on the part of the Company are hereby expressly excluded.

7. The Company neither assumes, nor authorizes any third part to assume, on its behalf, any other liabilities with respect to the sale of this BIG LOTS.
8. The warranties as outlined within this document do not apply to non-Master Flame accessories used in conjunction with the installation of this product.

### ***THIS WARRANTY IS VOID IF :***

- (a) The fireplace insert has been operated in atmospheres contaminated by chlorine, fluorine or other damaging chemicals.
- (b) The fireplace is subjected to prolonged periods of dampness or condensation.
- (c) Any alteration, willful abuse, accident, or misuse of the product.

### ***IF WARRANTY SERVICE IS NEEDED :***

- (1) Please note: When you open the carton, carefully check the unit and sure there is no damage. If you have any problems with how the various functions operate or with internal damager or missing parts, please contact [info@masterflamefireplace.com](mailto:info@masterflamefireplace.com).
- (2) **Do not attempt to do any service work yourself.**

**MADE IN CHINA**

### **For Customer Service**

**E-Mail: [info@masterflamefireplace.com](mailto:info@masterflamefireplace.com)**

**Toll Free: 1-855-837-2569**

**The warranty is null and void if used in commercial or industrial applications.**

Retailer: \_\_\_\_\_

Model Number: \_\_\_\_\_

Serial Number: \_\_\_\_\_

Date Code: \_\_\_\_\_

Purchase Date: \_\_\_\_\_

**This equipment complies with FCC radiation exposure limits set forth for an uncontrolled environment. This equipment should be installed and operated with minimum distance 20cm between the radiator & your body.**