

California Proposition 65 Warning

WARNING: This product contains or emits chemicals known to the state of California to cause cancer and birth defects or other reproductive harm.

Event Data Recorders

This vehicle is equipped with an event data recorder (EDR).

The main purpose of an EDR is to record, in certain crash or near crash-like situations, such as an air bag deployment or hitting a road obstacle, data that will assist in understanding how a vehicle's systems performed. **The EDR is designed to record data related to vehicle dynamics and safety systems for a short period of time, typically 30 seconds or less. The EDR in this vehicle is designed to record such data as:**

- **How various systems in your vehicle were operating;**
- **Whether or not the driver and passenger safety belts were buckled/fastened;**
- **How far (if at all) the driver was depressing the accelerator and/or brake pedal; and,**
- **How fast the vehicle was traveling.**

These data can help provide a better understanding of the circumstances in which crashes and injuries occur. NOTE: EDR data are recorded by your vehicle only if a non-trivial crash situation occurs; no data are recorded by the EDR under normal driving conditions and no personal data (e.g., name, gender, age, and crash location) are recorded. However, other parties, such as law enforcement, could combine the EDR data with the type of personally identifying data routinely acquired during a crash investigation.

To read data recorded by an EDR, special equipment is required, and access to the vehicle or the EDR is needed. In addition to the vehicle manufacturer, other parties, such as law enforcement, that have the special equipment, can read the information if they have access to the vehicle or the EDR.

The data belongs to the vehicle owner and may not be accessed by anyone else except as legally required or with the permission of the vehicle owner.

Service Diagnostic Recorders

This vehicle is equipped with service-related devices that record information about powertrain performance. The data can be used to verify emissions law requirements and/or help technicians diagnose and solve service problems. It may also be combined with data from other sources for research purposes, but it remains confidential. Some diagnostic and maintenance information is uploaded to Acura upon vehicle start up.

California Perchlorate Contamination Prevention Act

The airbags, seat belt tensioners, and CR type batteries in this vehicle may contain perchlorate materials - special handling may apply. See www.dtsc.ca.gov/hazardouswaste/perchlorate/

As you read this manual, you will find information that is preceded by a **NOTICE** symbol. This information is intended to help you avoid damage to your vehicle, other property, or the environment.

A Few Words About Safety

Your safety, and the safety of others, is very important. And operating this vehicle safely is an important responsibility.

To help you make informed decisions about safety, we have provided operating procedures and other information on labels and in this manual. This information alerts you to potential hazards that could hurt you or others.

Of course, it is not practical or possible to warn you about all the hazards associated with operating or maintaining your vehicle. You must use your own good judgment.

You will find this important safety information in a variety of forms, including:

- **Safety Labels** - on the vehicle.
- **Safety Messages** - preceded by a safety alert symbol  and one of three signal words: **DANGER**, **WARNING**, or **CAUTION**. These signal words mean:

 **DANGER**

You WILL be KILLED or SERIOUSLY HURT if you don't follow instructions.

 **WARNING**

You CAN be KILLED or SERIOUSLY HURT if you don't follow instructions.

 **CAUTION**

You CAN be HURT if you don't follow instructions.

- **Safety Headings** - such as Important Safety Precautions.
- **Safety Section** - such as Safe Driving.
- **Instructions** - how to use this vehicle correctly and safely.

This entire book is filled with important safety information - please read it carefully.

This owner's manual should be considered a permanent part of the vehicle and should remain with the vehicle when it is sold.

This owner's manual covers all models of your vehicle. You may find descriptions of equipment and features that are not on your particular model.

Images throughout this owner's manual (including the front cover) represent features and equipment that are available on some, but not all, models. Your particular model may not have some of these features.

This owner's manual is for vehicles sold in the United States and Canada.

The information and specifications included in this publication were in effect at the time of approval for printing. Honda Motor Co., Ltd. reserves the right, however, to discontinue or change specifications or design at any time without notice and without incurring any obligation.

➤ Safe Driving P. 31

For Safe Driving P. 32

Seat Belts P. 37

Airbags P. 45

➤ Instrument Panel P. 77

Indicators P. 78

Gauges and Multi-Information Display (MID) P. 117

➤ Controls P. 135

Clock P. 136

Locking and Unlocking the Doors P. 137

Opening and Closing the Moonroof P. 163

Adjusting the Seats P. 187

➤ Features P. 227

Audio System P. 228

➤ Driving P. 229

Before Driving P. 230

Towing a Trailer P. 236

Parking Your Vehicle P. 316

Multi-View Rear Camera P. 326

➤ Maintenance P. 331

Before Performing Maintenance P. 332

Maintenance Minder™ P. 335

Checking and Maintaining Wiper Blades P. 357

Remote Control and Wireless Headphone Care* P. 372

➤ Handling the Unexpected P. 383

Tools P. 384

If a Tire Goes Flat P. 385

Indicator, Coming On/Blinking P. 412

Fuses P. 418

When You Cannot Open the Tailgate P. 429

➤ Information P. 431

Specifications P. 432

Identification Numbers P. 434

Emissions Testing P. 437

Warranty Coverages P. 438

Contents

Child Safety P. 60

Exhaust Gas Hazard P. 75

Safety Labels P. 76

Opening and Closing the Tailgate P. 151

Security System P. 158

Opening and Closing the Windows P. 161

Operating the Switches Around the Steering Wheel P. 164

Adjusting the Mirrors P. 184

Interior Lights/Interior Convenience Items P. 201

Climate Control System P. 214

Off-Highway Driving Guidelines P. 237

When Driving P. 239

Braking P. 299

Refueling P. 327

Fuel Economy and CO₂ Emissions P. 330

Maintenance Under the Hood P. 339

Replacing Light Bulbs P. 352

Checking and Maintaining Tires P. 361

12-Volt Battery P. 370

Remote Transmitter Care P. 371

Climate Control System Maintenance P. 374

Cleaning P. 375

Accessories and Modifications P. 380

Power System Won't Start P. 404

Jump Starting P. 407

Overheating P. 409

Emergency Towing P. 427

When You Cannot Unlock the Fuel Fill Door P. 428

Refueling P. 430

Devices that Emit Radio Waves P. 435

Reporting Safety Defects P. 436

Authorized Manuals P. 440

Client Service Information P. 441

Quick Reference Guide P. 4

Safe Driving P. 31

Instrument Panel P. 77

Controls P. 135

Features P. 227

Driving P. 229

Maintenance P. 331

Handling the Unexpected P. 383

Information P. 431

Index P. 442

Visual Index

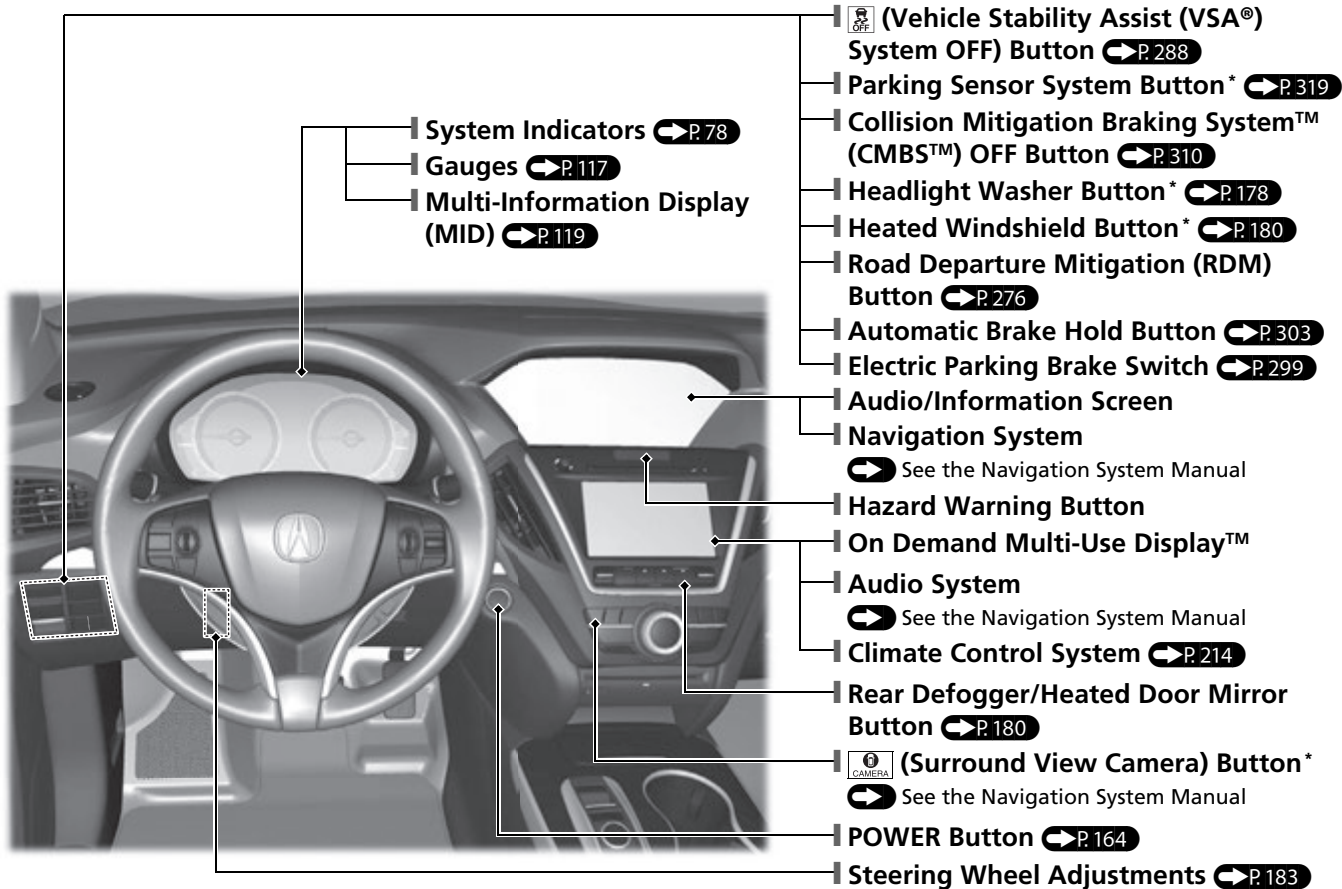

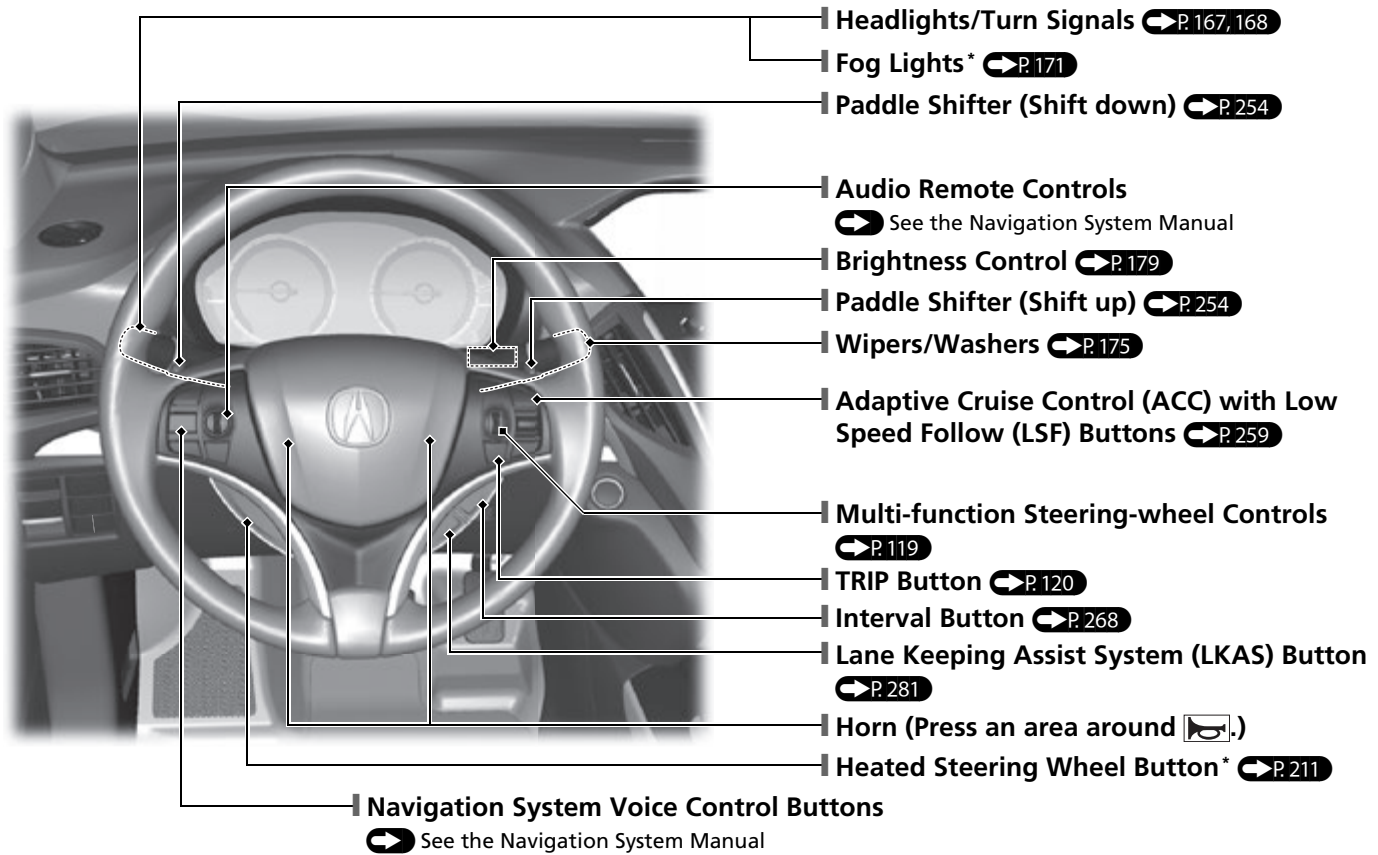

Visual Index

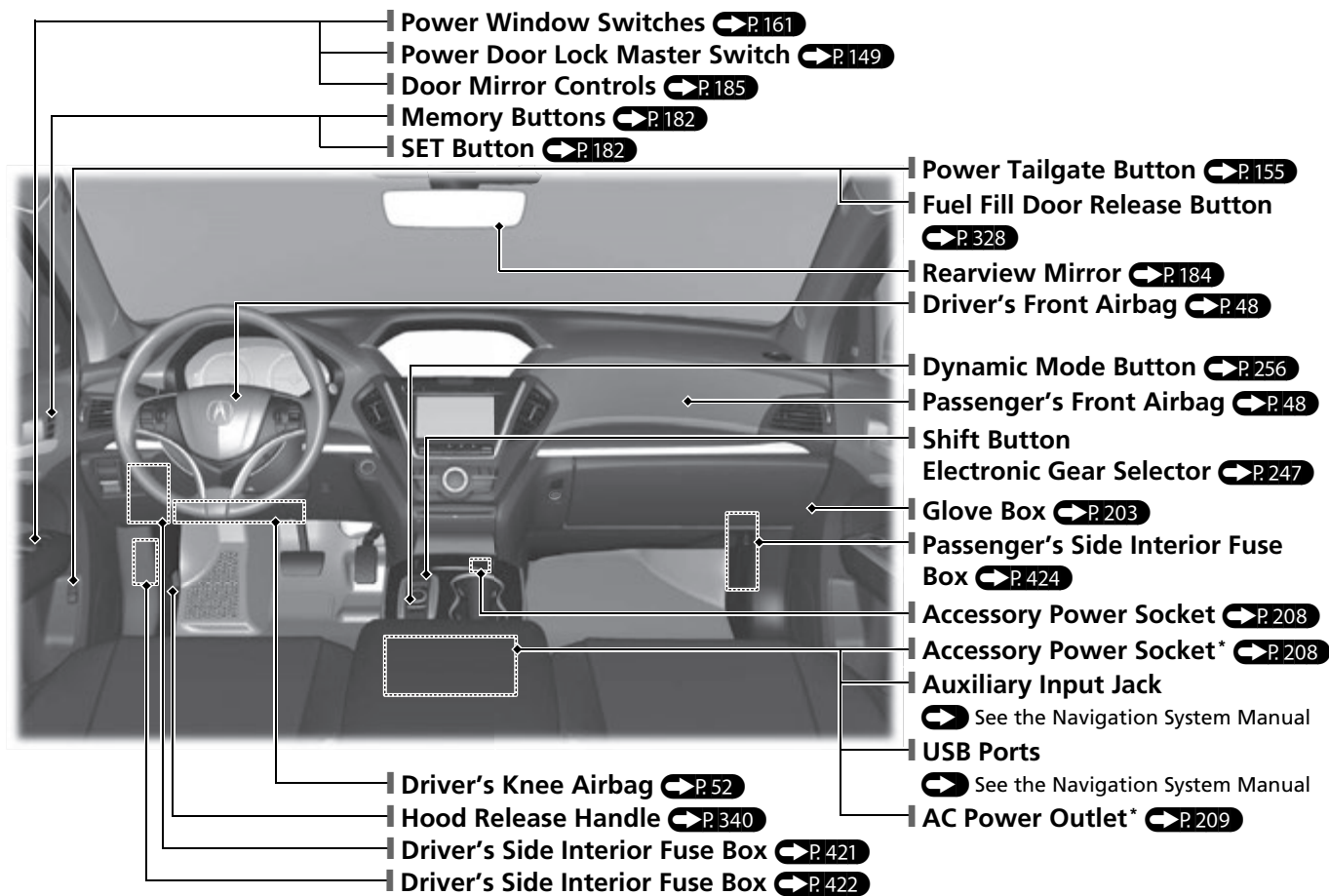

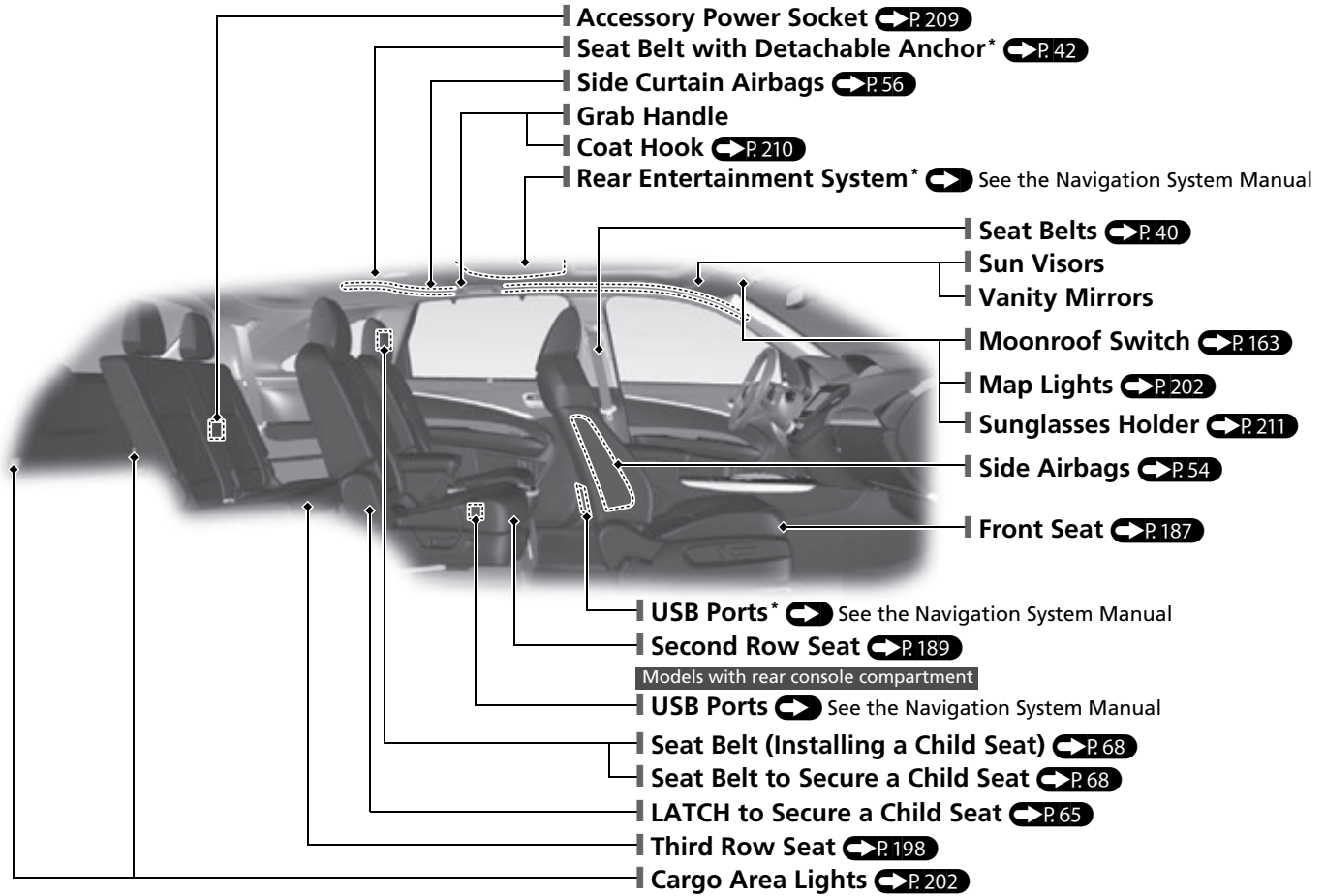



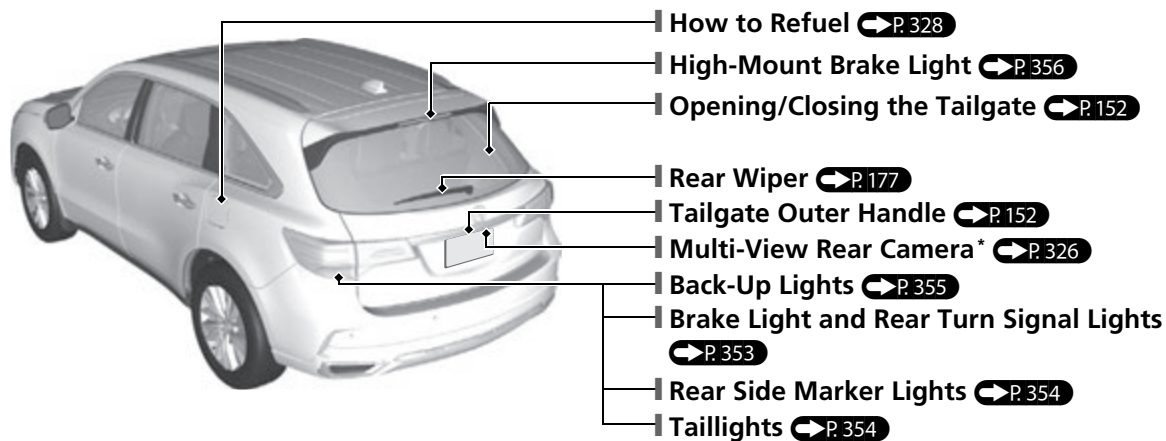
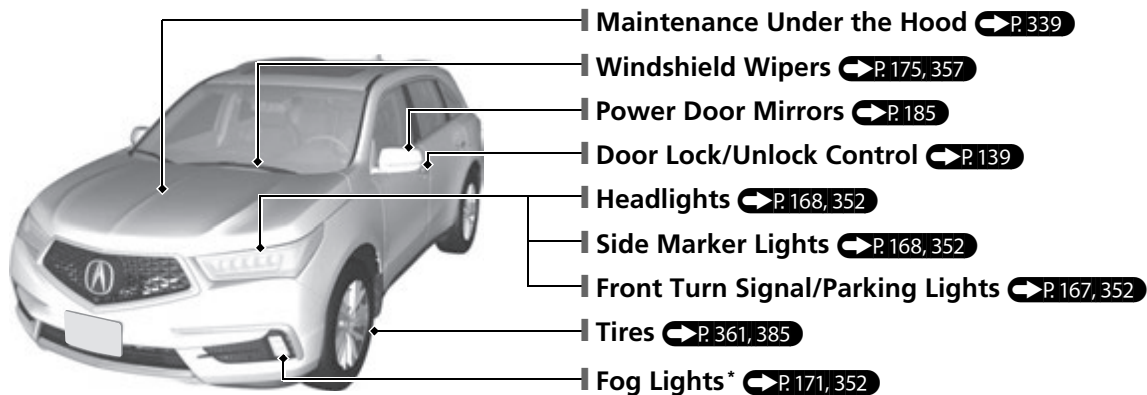

* Not available on all models

Visual Index





SPORT HYBRID Super Handling-All Wheel Drive™ (SPORT HYBRID SH-AWD®)

Your SPORT HYBRID SH-AWD® vehicle uses both electric motors and a gasoline engine as propulsion sources, with electric motors receiving electricity from an internal High Voltage battery.

Operating mode	EV Launch*	Engine Drive	EV Cruising*	Power Acceleration
Vehicle Speed	Launch Acceleration: <ul style="list-style-type: none"> • Rear Motor Drive 	Gentle Acceleration: <ul style="list-style-type: none"> • Engine Drive 	Low Speed Cruise: <ul style="list-style-type: none"> • Rear Motor Drive 	Aggressive Acceleration: <ul style="list-style-type: none"> • Engine Drive • Motor Assist
Power Flow Monitor				
Electric Motors	Drive	- / Drive	Drive	Drive
Generators	-	Generate / -	-	-
Gasoline Engine	Stopped	Running	Stopped	Running
Battery	Discharges	Charges/Discharges	Discharges	Discharges

*: When Integrated Dynamics System is in SPORT+ mode, EV Launch and EV Cruising cannot be operated.

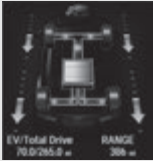
*: Operating paddle shifters when the gear position is in **D** or **S** cancels EV Launch and EV Cruising.

Operating mode	Engine Cruising	Regeneration	AWD Mode
Vehicle Speed	High Speed Cruise: • Engine Drive	Deceleration: • Front & Rear Regeneration	Slippery Condition: • Engine Drive • Front Generation • Rear Motor Drive
Power Flow Monitor			
Electric Motors	Drive	Regenerate	Drive
Generators	Generate	Regenerate	Generate
Gasoline Engine	Running	Stopped	Running
Battery	Charges/Discharges	Charges	Charges/Discharges

Energy Efficiency

As with a gasoline-powered vehicle, hybrid vehicle fuel efficiency and driving range is most impacted by your driving style. Aggressive acceleration and high-speed driving can easily trigger the system to switch the propulsion source to the gasoline-powered engine. In addition, heavy climate control system use negatively affects vehicle range and efficiency. Either of these use patterns will more quickly reduce the High Voltage battery's state of charge.

Battery Types

There are two types of batteries used in this vehicle: a standard 12-volt battery that powers the airbags, the interior and exterior lights, and other standard 12-volt systems; and a high voltage battery that is used to power the propulsion motors and recharge the 12-volt battery.

Regenerative Energy and Regenerative Braking

When decelerating without the accelerator being depressed or the brake pedal being applied, or while driving downhill, the electric motors act as generators that recover a portion of the electrical energy that was used to accelerate the vehicle. This regenerative braking slows the vehicle in a manner similar to engine braking in a gasoline-powered vehicle.

When the high voltage battery is fully charged or its condition is affected by extreme temperatures or other factors, regenerative braking may not work.

Auto Engine Stop/Start

Your vehicle's gasoline engine will automatically stop and start during vehicle operation as needed to meet driving and battery conditions. These are some examples that could cause the gasoline engine to automatically start.

In the following cases, however, Auto Engine Stop may not activate.

- When the Integrated Dynamics System is in SPORT+ mode.
- The vehicle momentarily needs additional power for aggressive acceleration, driving uphill, or driving at high speeds.
- The climate control system is in heavy use.
- The High Voltage battery temperature is high or low.
- The High Voltage battery state of charge is low.
- When the gear position is in **S** or **R**.

Sounds Unique to the SPORT HYBRID SH-AWD® System

When you first start driving this vehicle, you likely will hear some unfamiliar sounds, particularly when you first turn on the power system, while driving, and just after parking. Some of these sounds are unique to this vehicle's powertrain, fuel, and climate control systems; others are similar to sounds generated by conventional automobiles that typically are masked by louder noises absent from a vehicle of this design. These sounds are not a cause for concern, and you will soon recognize them as normal and thus be able to detect any new or unusual noise should one develop.

Safety Precautions



Do not touch the High Voltage system

Attempting to take a High Voltage system component apart or disconnect one of its wires can cause severe electrical shock. If the High Voltage system needs maintenance or repair, it should be performed at an Acura dealer.

If a crash occurs

●Be careful of electric shock hazard.

▶If a severe crash damages your vehicle's High Voltage system, there is a possibility of electrical shock due to exposed High Voltage components or wires. If this happens, do not touch any of the High Voltage system components or any of its orange wires.

●Avoid contact with High Voltage battery fluid.

▶The High Voltage battery contains a flammable electrolyte that could leak as a result of a severe crash. Avoid any skin or eye contact with the electrolyte as it is corrosive. If you accidentally touch it, flush your eyes or skin with a large quantity of water for at least five minutes, and seek medical attention immediately.

●Use a fire extinguisher for an electrical fire.

▶Attempting to extinguish an electrical fire with a small quantity of water, from a garden hose for instance, can be dangerous.

●Anytime the vehicle is damaged in a crash, have it repaired by an Acura dealer.

Emergency Shutdown System for the High Voltage System

The emergency shutdown system may activate when the vehicle is impacted by some incident such as a crash. When this system activates, the High Voltage system automatically shuts down, and your vehicle no longer will move under its own power. To return the High Voltage system back to normal operation, consult an Acura dealer.

Acura collects and recycles High Voltage batteries used in its vehicles – consult an Acura dealer for more information.

Safe Driving P.31

Airbags P.45

- Your vehicle is fitted with airbags to help protect you and your passengers during a moderate-to-severe collision.

Child Safety P.60

- All children 12 and younger should be seated in the rear seat.
- Smaller children should be properly restrained in a forward-facing child seat.
- Infants must be properly restrained in a rear-facing child seat.

Exhaust Gas Hazard P.75

- Your vehicle emits dangerous exhaust gases that contain carbon monoxide. Do not run the engine in confined spaces where carbon monoxide gas can accumulate.

Seat Belts P.37

- Fasten your seat belt and sit upright well back in the seat.
- Check that your passengers are wearing their seat belts correctly.

Before Driving Checklist P.36

- Before driving, check that the front seats, head restraints, steering wheel, and mirrors have been properly adjusted.

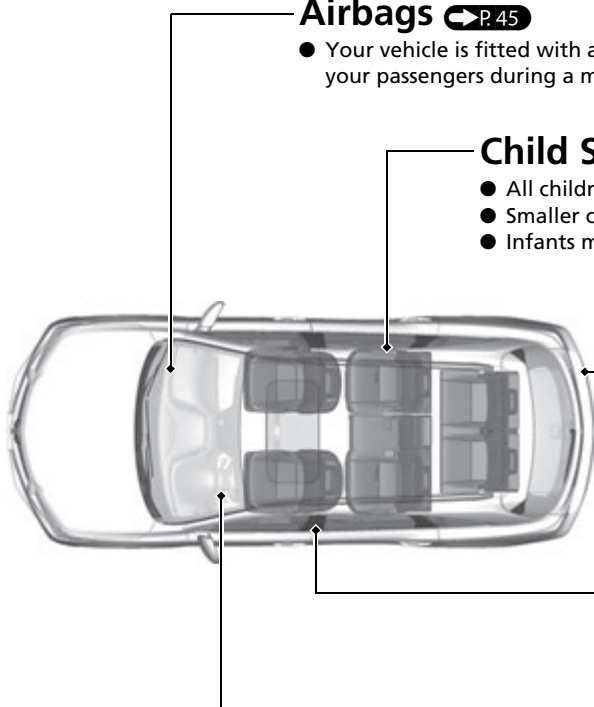













Fasten your lap belt as low as possible.

Instrument Panel ↔ P.77



Gauges ↔ P.117 / Multi-Information Display (MID) ↔ P.119 / System Indicators ↔ P.78

System Indicators

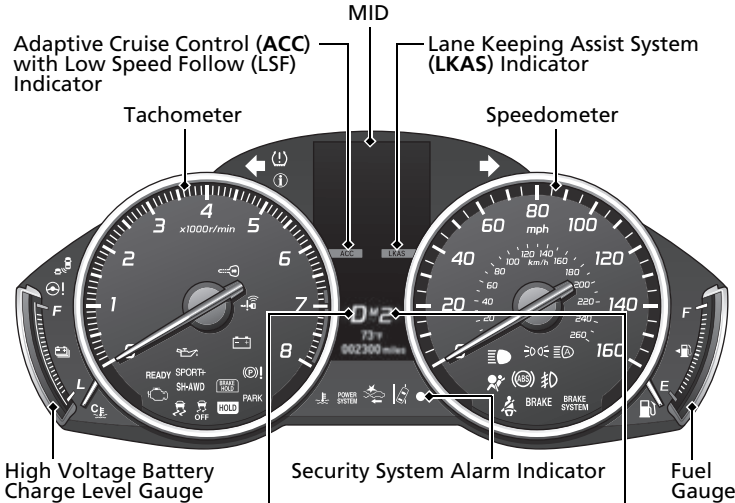



-  Blind spot information (BSI) Indicator
-  Speed-sensitive Electric Power Steering (EPS) System Indicator
-  Malfunction Indicator Lamp
-  Low Oil Pressure Indicator
- SPORT+** **SPORT+** Mode Indicator
- READY** **READY** Indicator
-  Vehicle Stability Assist (VSA®) System Indicator
-  VSA® OFF Indicator
-  Immobilizer System Indicator
-  Keyless Access System Indicator
-  12-Volt Battery Charging System Indicator
-  System Message Indicator
-  Automatic Brake Hold System Indicator
-  Automatic Brake Hold System Indicator
-  Automatic Brake Hold System Indicator













System Indicators

-  Low Tire Pressure/TPMS Indicator
-  High Temperature Indicator
-  Low Temperature Indicator

Lights Indicators

-  Lights On Indicator
-  High Beam Indicator
-  Fog Light Indicator*
-  Auto High-Beam Indicator





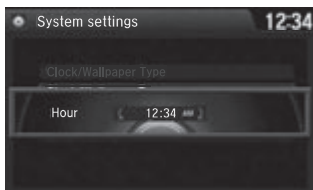

System Indicators

-  Electric Parking Brake System Indicator
- PARK** U.S. Electric Parking Brake Indicator
-  Canada Electric Parking Brake Indicator
-  Turn Signal and Hazard Warning Indicators
-  Supplemental Restraint System Indicator
-  Anti-lock Brake System (ABS) Indicator
-  Collision Mitigation Braking System™ (CMBS™) Indicator
-  Road Departure Mitigation (RDM) Indicator
- POWER SYSTEM** **POWER SYSTEM** Indicator
- BRAKE** U.S. Brake System Indicator (Red)
-  Canada Brake System Indicator (Red)
- BRAKE** U.S. Brake System Indicator (Amber)
-  Canada Brake System Indicator (Amber)
-  Low Fuel Indicator
-  Seat Belt Reminder Indicator

Controls P.135

Clock P.136



- 1** Enter the **Clock Adjustment** screen.
 **Adjusting the Clock**  P.136
- 2** Rotate  to change hour, then press .
- 3** Rotate  to change minute, then press .

The navigation system receives signals from GPS satellites, updating the clock automatically.

POWER Button P.164

Press the button to change the vehicle's power mode.



Turn Signals P.167

Turn Signal Control Lever

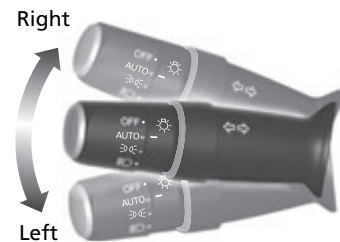

Lights P.168

Light Control Switches

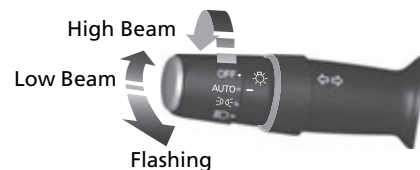

Wipers and Washers

➔ P.175

Wiper/Washer Control Lever

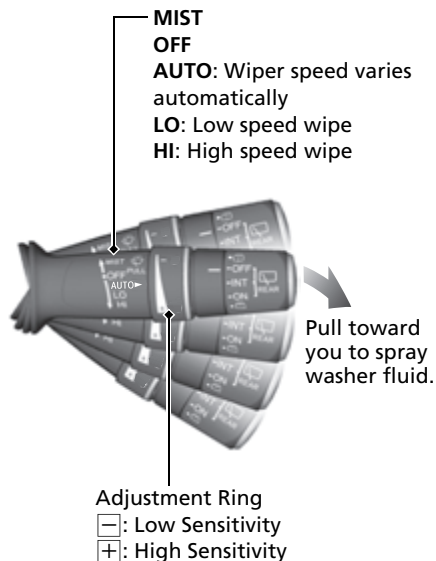

AUTO should **always** be turned **OFF** before cleaning the windshield or driving through a car wash.

Steering Wheel ➔ P.183

- To adjust, push and hold the adjustment switch to move the steering wheel to the desired position.

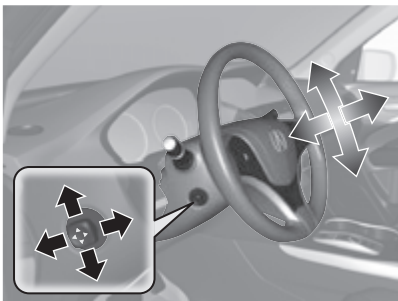

Unlocking the Front Doors from the Inside ➔ P.148

- Pull either front door inner handle to unlock and open it at the same time.



Tailgate ➔ P.152, 153

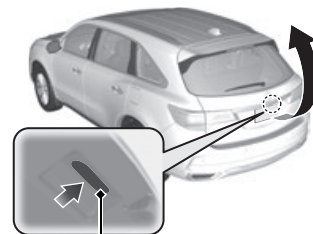

Tailgate Outer Handle

- Press the tailgate outer handle to unlock and open the tailgate when you carry the keyless access remote.
- Press the power tailgate button on the driver's door or the remote transmitter to open and close the power tailgate.

Power Door Mirrors

➔ P.185

- With the power mode in ON, move the selector switch to L or R.
- Push the appropriate edge of the adjustment switch to adjust the mirror.
- Press the fold button to fold the door mirrors.

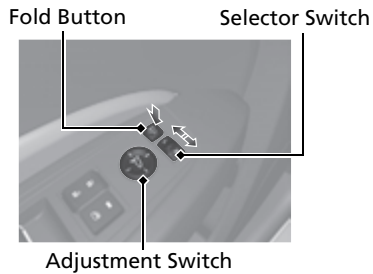

Power Windows ➔ P.161

- With the power mode in ON, open and close the power windows.
- If the power window lock button is in the off position, each passenger's window can be opened and closed with its own switch.
- If the power window lock button is in the on position (indicator is on), each passenger's window switch is disabled.

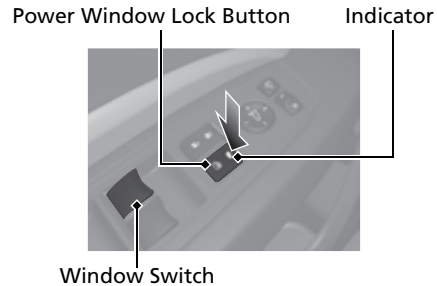

Climate Control System P.214

- Press the **AUTO** button to activate the climate control system.
- Press the button to turn the system on or off.
- Press the button to defrost the windshield.

The climate control system is voice operable. See the Navigation System Manual for complete details.



(On/Off) Button

AUTO Button

(Windshield Defroster) Button

- Air flows from dashboard vents.
- Air flows from floor and dashboard vents.
- Air flows from floor vents.
- Air flows from floor and windshield defroster vents.

Rear Climate Control P.225

- Press the **AUTO** button to activate the rear climate control system.
- Press the button to turn the system on or off.

Rear Temperature Control Buttons (Fan Control) Button



AUTO Button

(On/Off) Button

Mode Control Button

- Air flows from the rear console vents.
- Air flow from the rear console vents and floor vents.
- Air flows from the rear floor vents.

Audio System

For navigation system operation See the Navigation System Manual

Driving P.229

Electronic Gear Selector P.247

- Always depress the brake pedal before selecting **P** or changing the gear position from **P**.
- Select **P** and depress the brake pedal when turning on the power.
- Gear selection

Gear Position Indicator

The gear position indicator and the shift button indicator indicate the current gear selection.



Gear Position Indicator

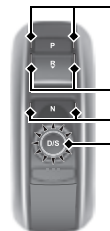
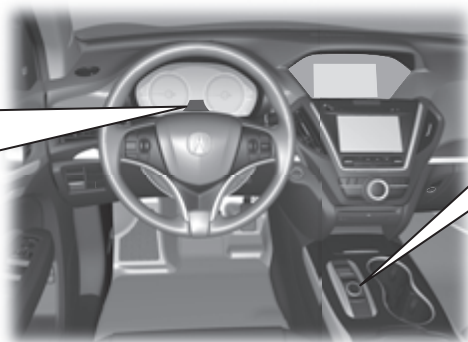

Shift Button Indicator

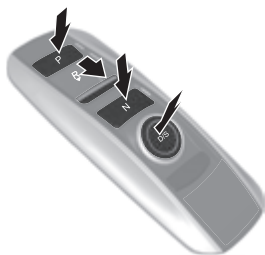

P **Park**
Press the **P** button.
Used when parking or before turning the power on or off.
Transmission is locked.

R **Reverse**
Pull back the **R** button.
Used when reversing.

N **Neutral**
Press the **N** button.
Transmission is not locked.

D **Drive**
Press the **D** button.
Used for normal driving.
D-paddle shift mode can be used.

S **S Position**
Press the **D** button twice.
Sequential shift mode can be used.

Paddle Shifters P. 254

- Paddle shifters allow you to shift gears much like a manual transmission (1st through 7th). This is useful for regenerative braking.

Gear Position Indicator

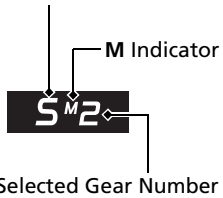

- D-paddle shift mode: The transmission will shift back to automatic mode once the system detects that the vehicle is cruising.
- Sequential mode gear selection: Holds the selected gear, and the **M** (sequential mode) indicator comes on.
- The sequential mode gear selection is shown in the instrument panel.

Shift Down 
Paddle Shifter



Shift Up 
Paddle Shifter

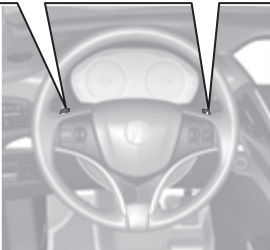

VSA® On and Off P.288

- The vehicle stability assist (VSA®) system helps stabilize the vehicle during cornering and helps maintain traction while accelerating on loose or slippery road surfaces.
- VSA® comes on automatically every time you turn on the power system.
- To partially disable or fully restore VSA® function, press and hold the button until you hear a beep.

Collision Mitigation Braking System™ (CMBS™) OFF Button

 P.307

- When a possible collision is likely unavoidable, the CMBS™ can help you to reduce the vehicle speed and the severity of the collision.
- To turn the CMBS™ on or off, press and hold the button until you hear a beep.

Tire Pressure Monitoring System (TPMS) with Tire Fill Assist P.294,416

- The TPMS monitors tire pressure.
- TPMS is turned on automatically every time you turn on the power system.
- TPMS fill assist provides audible and visual guidance during tire pressure adjustment.

Refueling P.327

Fuel recommendation: Unleaded premium gasoline with a pump octane number 91 or higher

Fuel tank capacity: 19.4 US gal (73.3 l)

- 1** Press the fuel fill door release button.



- 2** After refueling, wait for about five seconds before removing the filler nozzle.

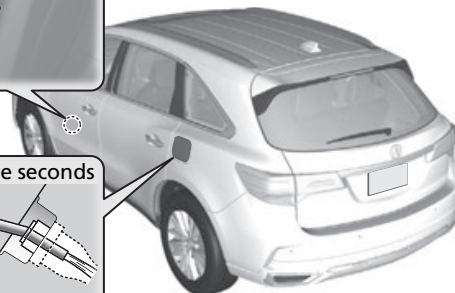
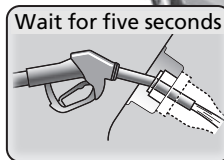

AcuraWatch™

AcuraWatch™ is a driver support system which employs the use of two distinctly different kinds of sensors, a radar sensor located in the front grille and a front sensor camera mounted to the interior side of the windshield, behind the rear view mirror.

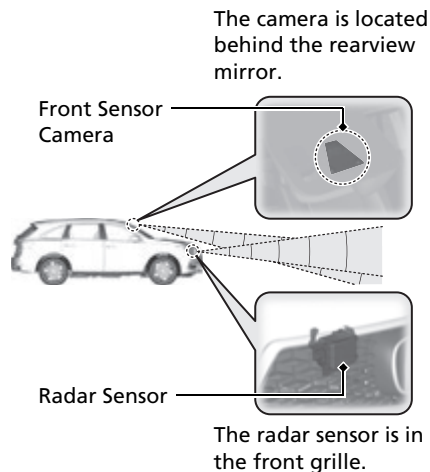

Adaptive Cruise Control (ACC) with Low Speed Follow (LSF) P.259

Helps maintain a constant vehicle speed and a set following interval behind a vehicle detected ahead of yours and, if the detected vehicle comes to a stop, can decelerate and stop your vehicle, without you having to keep your foot on the brake or the accelerator.

Road Departure Mitigation (RDM) System P.274

Alerts and helps to assist you when the system detects a possibility of your vehicle unintentionally crossing over detected lane markings.

Lane Keeping Assist System (LKAS) P.279

Provides steering input to help keep the vehicle in the middle of a detected lane and provides tactile and visual alerts if the vehicle is detected drifting out of its lane.

Collision Mitigation Braking System™ (CMBS™) P.307

Can assist you when there is a possibility of your vehicle colliding with a vehicle or a pedestrian detected in front of yours. The CMBS™ is designed to alert you when a potential collision is determined, as well as to reduce your vehicle speed to help minimize collision severity when a collision is deemed unavoidable.

Maintenance [↔ P. 331](#)

Under the Hood [↔ P. 339](#)

- Check engine oil, engine coolant, windshield washer fluid and inverter coolant. Add when necessary.
- Check brake fluid.
- Check the 12-volt battery condition monthly.

- 1** Pull the hood release handle under the corner of the dashboard.

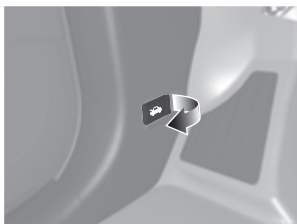

- 2** Locate the hood latch lever, pull it up, and then raise the hood. Once you have raised the hood slightly, you can release the lever.



- 3** When finished, close the hood and make sure it is firmly locked in place.

Wiper Blades [↔ P. 357](#)

- Replace blades if they leave streaks across the windshield.



Tires [↔ P. 361](#)

- Inspect tires and wheels regularly.
- Check tire pressures regularly.
- Install snow tires for winter driving.

Lights [↔ P. 352](#)

- Inspect all lights regularly.

Handling the Unexpected ➔ P.383

Flat Tire ➔ P.385

Vehicles with tire repair kit

- Park in a safe location and repair the flat tire using the tire repair kit.

Vehicles with compact spare tire

- Park in a safe location and replace the flat tire with the compact spare tire located under the cargo area.



Power System Won't Start ➔ P.404

- If the battery is dead, jump start using a booster battery.

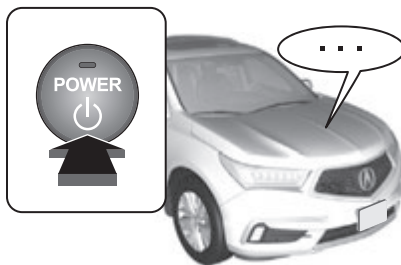

Overheating ➔ P.409

- Park in a safe location. If you do not see steam under the hood, open the hood, and let the engine cool down.



Indicators Come On ➔ P.412

- Identify the indicator and consult the owner's manual.



Blown Fuse ➔ P.418

- Check for a blown fuse if an electrical device does not operate.

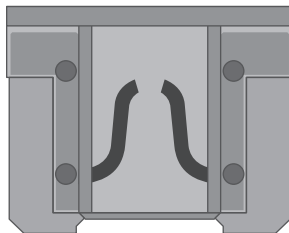

Emergency Towing ➔ P.427

- Call a professional towing service if you need to tow your vehicle.



What to Do If

Q Why do I hear an operating noise when applying the brakes?

A This can occur when the ABS activates, and does not indicate a problem. Apply firm, steady pressure on the brake pedal. Never pump the brake pedal.

➤ Anti-lock Brake System (ABS) ➔ P. 305

Q The rear door cannot be opened from inside the vehicle. Why?

A Check if the childproof lock is in the lock position. If so, open the rear door with the outside door handle. To cancel this function, slide the lever upwards to the unlock position.

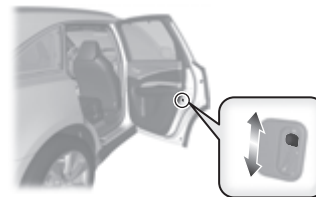

Q Why do the doors lock after I unlocked the doors?

A If you do not open the doors within 30 seconds, the doors are relocked automatically for security.

Q Why does the beeper sound when I open the driver's door?

A The beeper sounds when:

- The power mode is in ACCESSORY.
- The exterior lights are left on.

Q Why does the beeper sound when I start driving?

A The beeper sounds when the driver and/or front passenger are not wearing their seat belts.

Q Pulling the electric parking brake switch does not release the parking brake. Why?

A Pull the electric parking brake switch with the brake pedal depressed.

Q I'm seeing an amber indicator of a tire with an exclamation point. What is that?

A The Tire Pressure Monitoring System (TPMS) needs attention. Check tire pressure.

➤ If the Low Tire Pressure/TPMS Indicator Comes On or Blinks ➔ P.416

Q

Depressing the accelerator pedal does not release the parking brake automatically. Why?

A

- Fasten the driver's seat belt.
- Check if the transmission is in **P** or **N**. If so, select any other position.

Q

Why does the gear position automatically change to **P** when I open the driver's door to check for parking space lines when reversing?

A

- Fasten the driver's seat belt.
- Close the driver's door and manually change the gear position.
 - ▶ When opening the driver's door 

Q

Why do I hear a screeching sound when I apply the brake pedal?

A

The brake pads may need to be replaced. Have your vehicle inspected by a dealer.

Q

Unleaded gasoline with a Pump Octane Number (PON) of 91 or higher is recommended. Is it possible to use unleaded gasoline with a Pump Octane Number (PON) of 87 or lower on this vehicle?

A

Unleaded gasoline with a Pump Octane Number (PON) of 91 or higher is recommended. Use of lower octane gasoline can cause occasional metallic knocking noise in the engine and will result in decreased engine performance. Use of gasoline with a pump octane less than 87 can lead to engine damage.

Safe Driving

You can find many safety recommendations throughout this chapter, and throughout this manual.

For Safe Driving

Important Safety Precautions.....	32
Important Handling Information.....	34
Your Vehicle's Safety Features.....	35
Safety Checklist	36

Seat Belts

About Your Seat Belts	37
Fastening a Seat Belt	40
Seat Belt Inspection.....	44

Airbags

Airbag System Components.....	45
Types of Airbags	48
Front Airbags (SRS)	48
Driver's Knee Airbag	52
Side Airbags.....	54
Side Curtain Airbags	56
Airbag System Indicators.....	57
Airbag Care	59

Child Safety

Protecting Child Passengers	60
Safety of Infants and Small Children ..	62
Safety of Larger Children	73

Exhaust Gas Hazard

Carbon Monoxide Gas.....	75
--------------------------	----

Safety Labels

Label Locations.....	76
----------------------	----

The following pages explain your vehicle's safety features and how to use them properly. The safety precautions below are ones that we consider to be among the most important.

Important Safety Precautions

■ Always wear your seat belt

A seat belt is your best protection in all types of collisions. Airbags are designed to supplement seat belts, not replace them. So even though your vehicle is equipped with airbags, make sure you and your passengers always wear your seat belts, and wear them properly.

■ Restrain all children

Children ages 12 and under should ride properly restrained in a back seat, not the front seat. Infants and small children should be restrained in a child seat. Larger children should use a booster seat and a lap/shoulder seat belt until they can use the belt properly without a booster seat.

■ Be aware of airbag hazards

While airbags can save lives, they can cause serious or fatal injuries to occupants who sit too close to them, or are not properly restrained. Infants, young children, and short adults are at the greatest risk. Be sure to follow all instructions and warnings in this manual.

■ Don't drink and drive

Alcohol and driving don't mix. Even one drink can reduce your ability to respond to changing conditions, and your reaction time gets worse with every additional drink. So don't drink and drive, and don't let your friends drink and drive, either.

ⓘ Important Safety Precautions

Some states, provinces and territories prohibit the use of cell phones other than hands-free devices by the driver while driving.

■ **Pay appropriate attention to the task of driving safely**

Engaging in cell phone conversation or other activities that keep you from paying close attention to the road, other vehicles, and pedestrians could lead to a crash. Remember, situations can change quickly, and only you can decide when it is safe to divert some attention away from driving.

■ **Control your speed**

Excessive speed is a major factor in crash injuries and deaths. Generally, the higher the speed, the greater the risk, but serious injuries can also occur at lower speeds. Never drive faster than is safe for current conditions, regardless of the maximum speed posted.

■ **Keep your vehicle in safe condition**

Having a tire blowout or a mechanical failure can be extremely hazardous. To reduce the possibility of such problems, check your tire pressures and condition frequently, and perform all regularly scheduled maintenance.

Important Handling Information

Your vehicle has higher ground clearance than a passenger vehicle designed for use only on pavement. Higher ground clearance has many advantages for off-highway driving. It allows you to travel over bumps, obstacles, and rough terrain. It also provides good visibility so you can anticipate problems earlier.

These advantages come at some cost. Because your vehicle is taller and rides higher off the ground, it has a higher center gravity making it more susceptible to tripping or roll over if you make abrupt turns. Utility vehicles have a significantly higher rollover rate than other types of vehicles. In a rollover crash, an unbelted person is significantly more likely to die than a person wearing a seat belt. As a reminder, make sure you and your passengers always wear seat belts.

► Important Handling Information

For information on how to reduce the risk of rollover, read:

► **Driving Guidelines for Your Utility Vehicle**
P. 245

► **Off-Highway Driving Guidelines** P. 237
Failure to operate your vehicle correctly might result in a crash or a rollover.

Your Vehicle's Safety Features

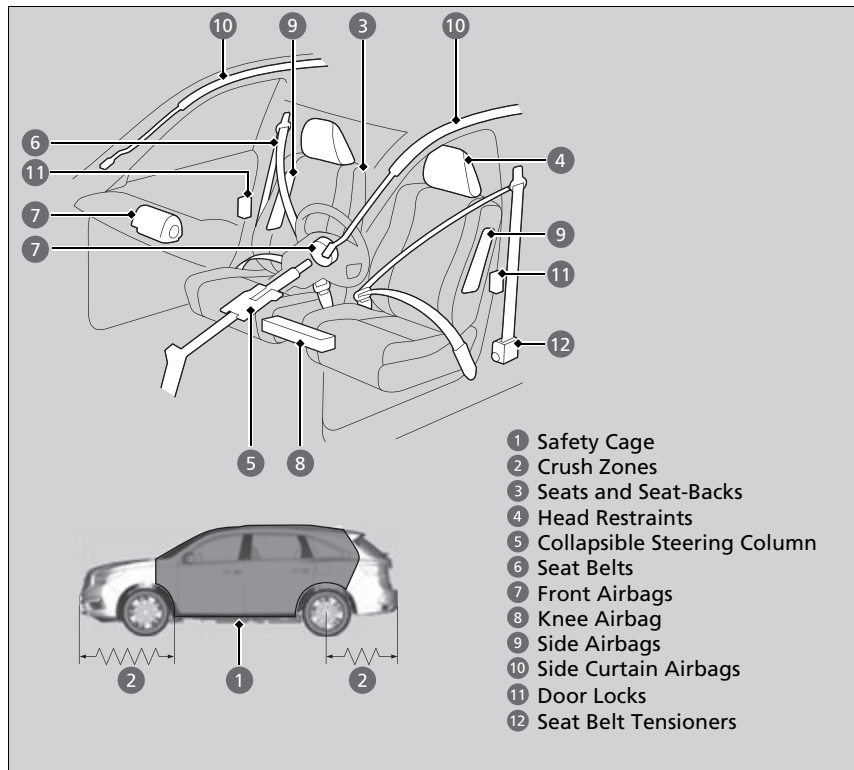

The following checklist will help you take an active role in protecting yourself and your passengers.

▣ Your Vehicle's Safety Features

Your vehicle is equipped with many features that work together to help protect you and your passengers during a crash.

Some features do not require any action on your part. These include a strong steel framework that forms a safety cage around the passenger compartment, front and rear crush zones, a collapsible steering column, and tensioners that tighten the front seat belts in a sufficient crash.

However, you and your passengers cannot take full advantage of these features unless you remain seated in the correct position and always wear your seat belts. In fact, some safety features can contribute to injuries if they are not used properly.

Safety Checklist

For the safety of you and your passengers, make a habit of checking these items each time before you drive.

- After everyone has entered the vehicle, be sure all doors and the tailgate are closed and locked. Locking the doors and the tailgate helps prevent an occupant from being ejected and an outsider from unexpectedly opening a door or the tailgate.
 - **Locking/Unlocking the Doors from the Inside** P. 147
- Adjust your seat to a position suitable for driving. Be sure the front seats are adjusted as far to the rear as possible while allowing the driver to control the vehicle. Sitting too close to a front airbag can result in serious or fatal injury in a crash.
 - **Adjusting the Seats** P. 187
- Adjust head restraints to the proper position. Head restraints are most effective when the center of the head restraint aligns with the center of your head. Taller persons should adjust their head restraint to the highest position.
 - **Adjusting the Front and Second Row Outer Head Restraint Positions** P. 193
- Always wear your seat belt, and make sure you wear it properly. Confirm that any passengers are properly belted as well.
 - **Fastening a Seat Belt** P. 40
- Protect children by using seat belts or child seats according to a child's age, height and weight.
 - **Child Safety** P. 60

☒ Safety Checklist

If the door and/or tailgate open message appears on the multi-information display (MID), a door and/or the tailgate is not completely closed. Close all doors and the tailgate tightly until the message disappears.

➤ **Multi-Information Display (MID) Warning and Information Messages** P. 99



About Your Seat Belts

Seat belts are the single most effective safety device because they keep you connected to the vehicle so that you can take advantage of many built-in safety features. They also help keep you from being thrown against the inside of the vehicle, against any passengers, or out of the vehicle. When worn properly, seat belts also keep your body properly positioned in a crash so that you can take full advantage of the additional protection provided by the airbags.

In addition, seat belts help protect you in almost every type of crash, including:

- frontal impacts
- side impacts
- rear impacts
- rollovers

■ Lap/shoulder seat belts

All six or seven seating positions are equipped with lap/shoulder seat belts with emergency locking retractors. In normal driving the retractor lets you move freely while keeping some tension on the belt. During a collision or sudden stop the retractor locks to restrain your body.

The front passenger's, second row and third row seat belts also have a lockable retractor for use with child seats.

➤ **Installing a Child Seat with a Lap/Shoulder Seat Belt** P. 68

ⓘ About Your Seat Belts

⚠ WARNING

Not wearing a seat belt properly increases the chance of serious injury or death in a crash, even though your vehicle has airbags.

Be sure you and your passengers always wear seat belts and wear them properly.

Seat belts cannot completely protect you in every crash. But in most cases, seat belts can reduce your risk of serious injury.

Most states and all Canadian provinces and territories require you to wear seat belts.

The emergency locking retractor may lock if you lean forward too quickly. Slower movements will allow the belt to extend fully without locking.

■ Proper use of seat belts

Follow these guidelines for proper use:

- All occupants should sit upright, well back in the seat, and remain in that position for the duration of the trip. Slouching and leaning reduce the effectiveness of the belt and can increase the chance of serious injury in a crash.
- Never place the shoulder part of a lap/shoulder seat belt under your arm or behind your back. This could cause very serious injuries in a crash.
- Two people should never use the same seat belt. If they do, they could be very seriously injured in a crash.
- Do not put any accessories on the seat belts. Devices intended to improve comfort or reposition the shoulder part of a seat belt can reduce the protective capability and increase the chance of serious injury in a crash.

⌘ About Your Seat Belts

If a rear seat passenger moves around and extends the seat belt, the lockable retractor may activate. If this happens, release the retractor by unfastening the seat belt and allow the belt to retract completely. Then refasten the belt.

Seat Belt Reminder



The seat belt system includes an indicator on the instrument panel to remind the driver or a front passenger or both to fasten their seat belts.

If you set the power mode to ON and a seat belt is not fastened, a beeper will sound and the indicator will blink. After a few seconds, the beeper will stop and the indicator will light up and remain illuminated until the seat belt is fastened.

The beeper will periodically sound and the indicator will blink while the vehicle is moving until the driver's and/or the front passenger's seat belt is fastened.

Automatic Seat Belt Tensioners

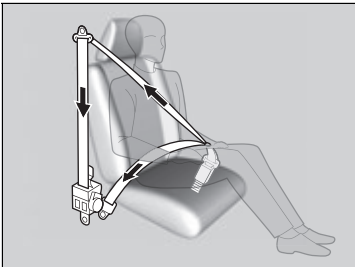

The front seats are equipped with automatic seat belt tensioners to enhance safety.

The tensioners automatically tighten the front seat belts during a moderate-to-severe frontal collision, sometimes even if the collision is not severe enough to inflate the front airbags or the driver's knee airbag.

⊗ Seat Belt Reminder

The indicator will also come on if a front passenger does not fasten their seat belt within six seconds after the power mode is set to ON.

When no one is sitting in the front passenger's seat, the indicator will not come on and the beeper will not sound.

The indicator also may not come on and the beeper may not sound when the occupant is not heavy enough to trigger the weight sensor. Such occupants (e.g., infants and smaller children) should be moved to the rear seat as a deploying front airbag likely will injure or kill them.

➤ **Protecting Child Passengers** P. 60

⊗ Automatic Seat Belt Tensioners

The seat belt tensioners can only operate once. If a tensioner is activated, the SRS indicator will come on. Have a dealer replace the tensioner and thoroughly inspect the seat belt system as it may not offer protection in a subsequent crash.

During a moderate-to-severe side impact, the tensioner on that side of the vehicle also activates.

Fastening a Seat Belt

After adjusting a front seat to the proper position, and while sitting upright and well back in the seat:

➤ **Adjusting the Seats** P. 187

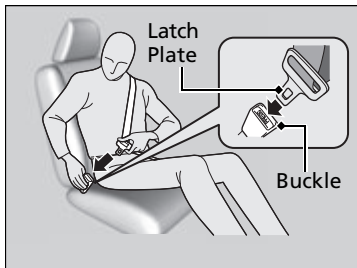
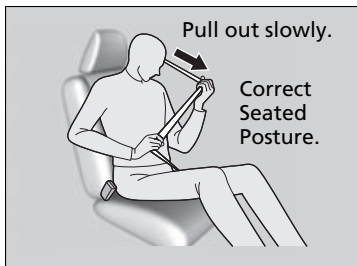

1. Pull the seat belt out slowly.

2. Insert the latch plate into the buckle, then tug on the belt to make sure the buckle is secure.

▶ Make sure that the belt is not twisted or caught on anything.

Fastening a Seat Belt

No one should sit in a seat with an inoperative seat belt or one that does not appear to be working correctly. Using a seat belt that is not working properly may not protect the occupant in a crash. Have a dealer check the belt as soon as possible.

Never insert any foreign objects into the buckle or retractor mechanism.

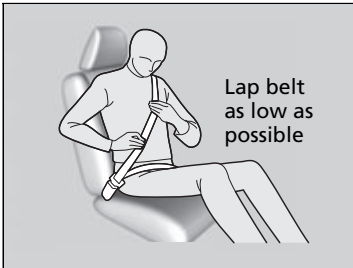

3. Position the lap part of the belt as low as possible across your hips, then pull up on the shoulder part of the belt so the lap part fits snugly. This lets your strong pelvic bones take the force of a crash and reduces the chance of internal injuries.
4. If necessary, pull up on the belt again to remove any slack, then check that the belt rests across the center of your chest and over your shoulder. This spreads the forces of a crash over the strongest bones in your upper body.

■ Adjusting the Shoulder Anchor

The front seats have adjustable shoulder anchors to accommodate taller and shorter occupants.

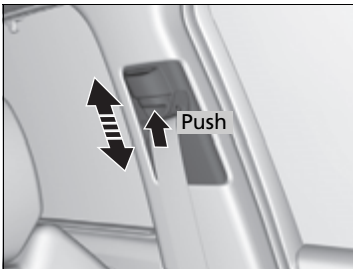

1. Move the anchor up and down while holding the release button.
2. Position the anchor so that the belt rests across the center of your chest and over your shoulder.

▶▶ Fastening a Seat Belt

⚠ WARNING

Improperly positioning the seat belts can cause serious injury or death in a crash.

Make sure all seat belts are properly positioned before driving.

To release the belt, push the red **PRESS** button then guide the belt by hand until it has retracted completely.

When exiting the vehicle, be sure the belt is out of the way and will not get caught by closing the door.

▶▶ Adjusting the Shoulder Anchor

The shoulder anchor height can be adjusted to four levels. If the belt contacts your neck, lower the height one level at a time.

After an adjustment, make sure that the shoulder anchor position is secure.

Models with second row bench seat

Seat Belt with Detachable Anchor

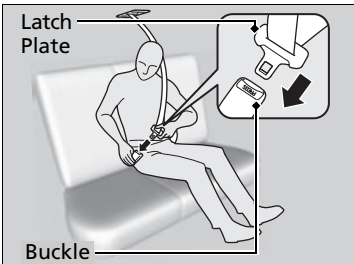
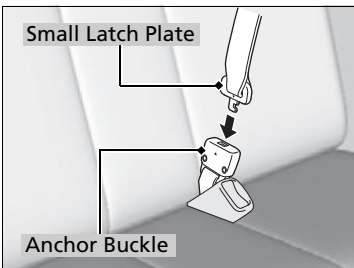
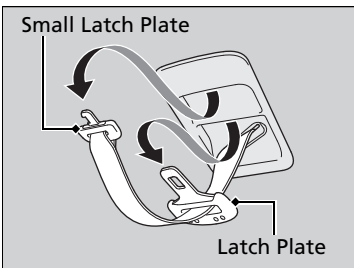

1. Pull out the seat belt's small latch plate and the latch plate from each holding slot in the ceiling.

2. Line up the triangle marks on the small latch plate and anchor buckle. Make sure the seat belt is not twisted. Attach the belt to the anchor buckle.

3. Insert the latch plate into the buckle. Properly fasten the seat belt the same way you fasten the lap/shoulder seat belt.

Seat Belt with Detachable Anchor

⚠ WARNING

Using the seat belt with the detachable anchor unlatched increases the chance of serious injury or death in a crash.

Before using the seat belt, make sure the detachable anchor is correctly latched.

To unlatch the detachable anchor, insert the latch plate into the slot on the side of the anchor buckle.

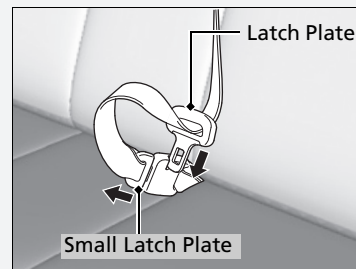

Advice for Pregnant Women

If you are pregnant, the best way to protect yourself and your unborn child when driving or riding in a vehicle is to always wear a seat belt and keep the lap part of the belt as low as possible across the hips.

Wear the shoulder belt across the chest avoiding the abdomen.



Wear the lap part of the belt as low as possible across the hips.

Advice for Pregnant Women

Each time you have a checkup, ask your doctor if it is okay for you to drive.

To reduce the risk of injuries to both you and your unborn child that can be caused by an inflating front airbag:

- When driving, sit upright and adjust the seat as far back as possible while allowing full control of the vehicle.
- When sitting in the front passenger's seat, adjust the seat as far back as possible.

Seat Belt Inspection

Regularly check the condition of your seat belts as follows:

- Pull each belt out fully, and look for frays, cuts, burns, and wear.
- Check that the latch plates and buckles work smoothly and the belts retract easily.
 - ▶ If a belt does not retract easily, cleaning the belt may correct the problem. Only use a mild soap and warm water. Do not use bleach or cleaning solvents. Make sure the belt is completely dry before allowing it to retract.

Any belt that is not in good condition or working properly will not provide proper protection and should be replaced as soon as possible.

A belt that has been worn during a crash may not provide the same level of protection in a subsequent crash. Have your seat belts inspected by a dealer after any collision.

▶▶ Seat Belt Inspection

WARNING

Not checking or maintaining seat belts can result in serious injury or death if the seat belts do not work properly when needed.

Check your seat belts regularly and have any problem corrected as soon as possible.

Airbag System Components

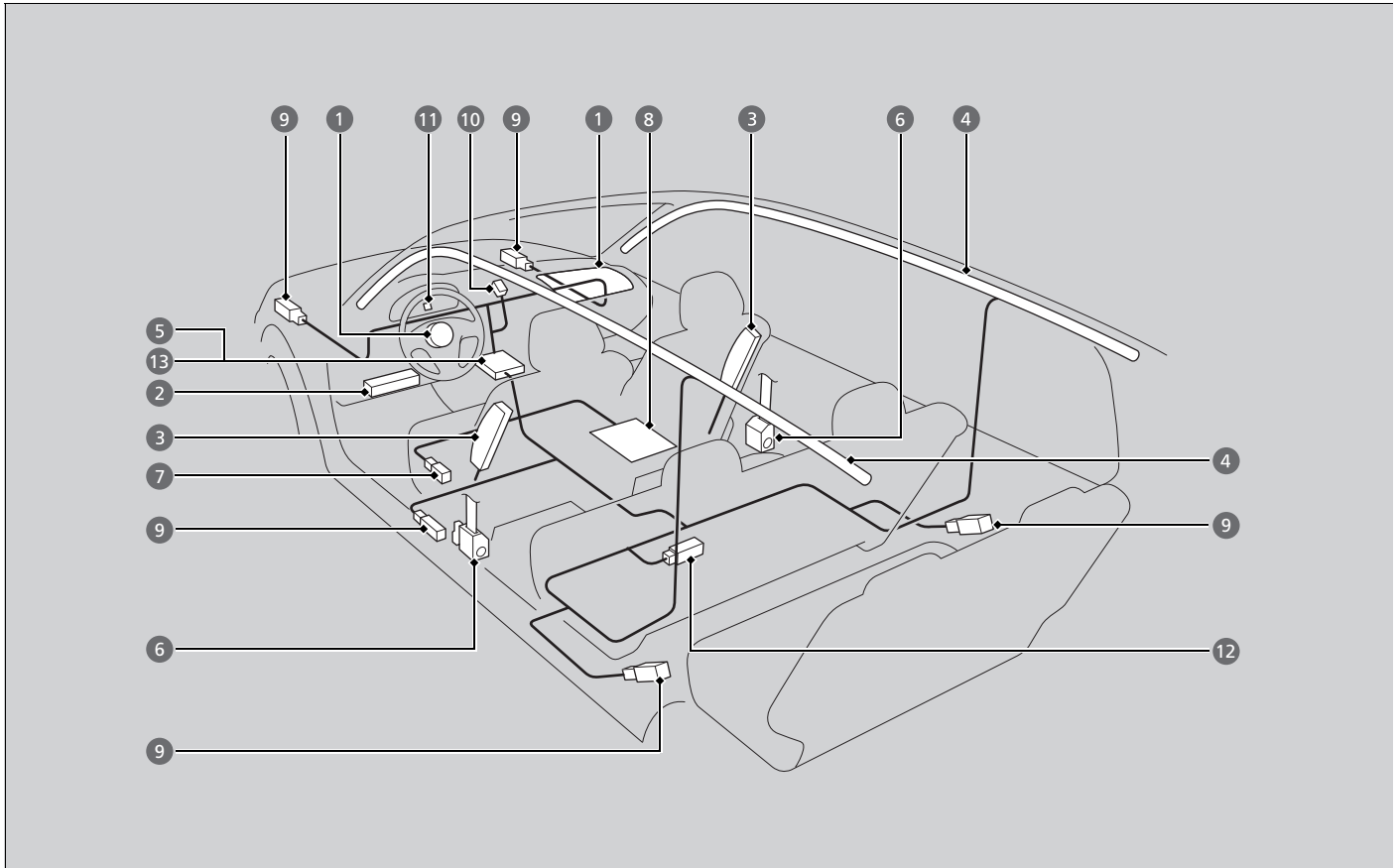

The front, driver's knee, front side, and side curtain airbags are deployed according to the direction and severity of impact. Both side curtain airbags are deployed in a rollover. The airbag system includes:

- 1 Two SRS (Supplemental Restraint System) front airbags. The driver's airbag is stored in the center of the steering wheel; the front passenger's airbag is stored in the dashboard. Both are marked **SRS AIRBAG**.
- 2 Driver's knee airbag. The knee airbag is stored under the steering column. It is marked **SRS AIRBAG**.
- 3 Two side airbags, one for the driver and one for a front passenger. The airbags are stored in the outer edges of the seat-backs. Both are marked **SIDE AIRBAG**.
- 4 Two side curtain airbags, one for each side of the vehicle. The airbags are stored in the ceiling, above the side windows. The front and rear pillars are marked **SIDE CURTAIN AIRBAG**.
- 5 An electronic control unit that, when the power mode is on, continually monitors information about the various impact sensors, seat and buckle sensors, airbag activators, seat belt tensioners, and other vehicle information. During a crash event the unit can record such information.
- 6 Automatic front seat belt tensioners. In addition, the driver's and front passenger's seat belt buckles incorporate sensors that detect whether or not the belts are fastened.
- 7 A driver's seat position sensor. If the seat is too far forward, the airbag will inflate with less force.
- 8 Weight sensors in the front passenger's seat. The front passenger's airbag will be turned off if the weight on the seat is approximately 65 lbs (29 kg) or less (the weight of an infant or small child).
- 9 Impact sensors that can detect a moderate-to-severe front or side impact.
- 10 An indicator on the dashboard that alerts you that the front passenger's front airbag has been turned off.
- 11 An indicator on the instrument panel that alerts you to a possible problem with your airbag system or seat belt tensioners.
- 12 Safing Sensor
- 13 A rollover sensor that can detect if your vehicle is about to roll over and signal the control unit to deploy both side curtain airbags.

Important Facts About Your Airbags

Airbags can pose serious hazards. To do their job, airbags must inflate with tremendous force. So, while airbags help save lives, they can cause burns, bruises, and other minor injuries, sometimes even fatal ones if occupants are not wearing their seat belts properly and sitting correctly.

What you should do: Always wear your seat belt properly, and sit upright and as far back from the steering wheel as possible while allowing full control of the vehicle. A front passenger should move their seat as far back from the dashboard as possible.

Remember, however, that no safety system can prevent all injuries or deaths that can occur in a severe crash, even when seat belts are properly worn and the airbags deploy.

Do not place hard or sharp objects between yourself and a front airbag.

Carrying hard or sharp objects on your lap, or driving with a pipe or other sharp object in your mouth, can result in injuries if your front airbag inflates.

Do not attach or place objects on the front and driver's knee airbag covers.

Objects on the covers marked **SRS AIRBAG** could interfere with the proper operation of the airbags or be propelled inside the vehicle and hurt someone if the airbags inflate.

Important Facts About Your Airbags

Do not attempt to deactivate your airbags. Together, airbags and seat belts provide the best protection.

When driving, keep hands and arms out of the deployment path of the front airbag by holding each side of the steering wheel. Do not cross an arm over the airbag cover.

Types of Airbags

Your vehicle is equipped with four types of airbags:

- **Front airbags:** Airbags in front of the driver's and front passenger's seats.
- **Driver's knee airbag:** Airbag under the steering column.
- **Side airbags:** Airbags in the driver's and front passenger's seat-backs.
- **Side curtain airbags:** Airbags above the side windows.

Each is discussed in the following pages.

Front Airbags (SRS)

The front SRS airbags inflate in a moderate-to-severe frontal collision to help protect the head and chest of the driver and/or front passenger.

SRS (Supplemental Restraint System) indicates that the airbags are designed to supplement seat belts, not replace them. Seat belts are the occupant's primary restraint system.

Housing Locations

The front airbags are housed in the center of the steering wheel for the driver, and in the dashboard for the front passenger. Both airbags are marked **SRS AIRBAG**.

Types of Airbags

The airbags can inflate whenever the power mode is in ON.

After an airbag inflates in a crash, you may see a small amount of smoke. This is from the combustion process of the inflator material and is not harmful. People with respiratory problems may experience some temporary discomfort. If this occurs, get out of the vehicle as soon as it is safe to do so.

Front Airbags (SRS)

During a frontal crash severe enough to cause one or both front airbags to deploy, the airbags can inflate at different rates, depending on the severity of the crash, whether or not the seat belts are latched, and/or other factors. Frontal airbags are designed to supplement the seat belts to help reduce the likelihood of head and chest injuries in frontal crashes.

■ Operation

Front airbags are designed to inflate during moderate-to-severe frontal collisions. When the vehicle decelerates suddenly, the sensors send information to the control unit which signals one or both front airbags to inflate.

A frontal collision can be either head-on or angled between two vehicles, or when a vehicle crashes into a stationary object, such as a concrete wall.

■ How the Front Airbags Work

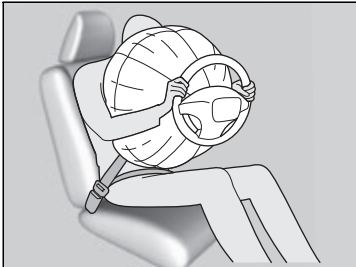

While your seat belt restrains your torso, the front airbag provides supplemental protection for your head and chest.

The front airbags deflate immediately so that they won't interfere with the driver's visibility or the ability to steer or operate other controls.

The total time for inflation and deflation is so fast that most occupants are not aware that the airbags deployed until they see them lying in front of them.

☒ How the Front Airbags Work

Although the driver's and front passenger's airbags normally inflate within a split second of each other, it is possible for only one airbag to deploy. This can happen if the severity of a collision is at the margin, or threshold that determines whether or not the airbags will deploy. In such cases, the seat belt will provide sufficient protection, and the supplemental protection offered by the airbag would be minimal.

■ When front airbags should not deploy

Minor frontal crashes: Front airbags were designed to supplement seat belts and help save lives, not to prevent minor scrapes, or even broken bones that might occur during a less than moderate-to-severe frontal crash.

Side impacts: Front airbags can provide protection when a sudden deceleration causes a driver or front passenger to move towards the front of the vehicle. Side airbags and side curtain airbags have been specifically designed to help reduce the severity of injuries that can occur during a moderate-to-severe side impact which can cause the driver or passenger to move towards the side of the vehicle.

Rear impacts: Head restraints and seat belts are your best protection during a rear impact. Front airbags cannot provide any significant protection and are not designed to deploy in such collisions.

Rollovers: In a rollover, your best form of protection is a seat belt or, if your vehicle is equipped with a rollover sensor, both a seat belt and a side curtain airbag. Front airbags, however, are not designed to deploy in a rollover as they would provide little if any protection.

■ When front airbags deploy with little or no visible damage

Because the airbag system senses sudden deceleration, a strong impact to the vehicle framework or suspension might cause one or more of the airbags to deploy. Examples include running into a curb, the edge of a hole, or other low fixed object that causes a sudden deceleration in the vehicle chassis. Since the impact is underneath the vehicle, damage may not be readily apparent.

■ When front airbags may not deploy, even though exterior damage appears severe

Since crushable body parts absorb crash energy during an impact, the amount of visible damage does not always indicate proper airbag operation. In fact, some collisions can result in severe damage but no airbag deployment because the airbags would not have been needed or would not have provided protection even if they had deployed.

Advanced Airbags

The airbags have advanced features to help reduce the likelihood of airbag related injuries to smaller occupants.

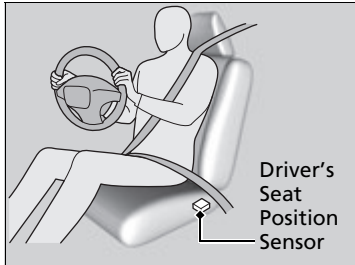

The driver's advanced airbag system includes a seat position sensor.

Based on information from this sensor and the severity of the impact, the advanced airbag system determines the optimal deployment of the driver's airbag.

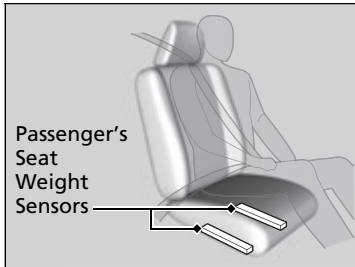

The front passenger's advanced airbag system has weight sensors.

We advise against allowing a child under the age of 12 to ride in the front passenger's seat. However, **if you do allow a child under 12 to ride in the front passenger's seat**, note that the system will automatically turn off the front passenger's airbag if the sensors detect that the child is approximately 65 lbs (29 kg) or less.

Advanced Airbags

If there is a problem with the driver's seat position sensor, the SRS indicator will come on and the airbag will inflate with full (normal) force, regardless of the driver's seating position.

For the advanced airbags to work properly:

- Do not spill any liquid on or under the seats.
- Do not put any object under the passenger's seat.
- Make sure any objects are positioned properly on the floor. Improperly positioned objects can interfere with the advanced airbag sensors.
- All occupants should sit upright and wear their seat belts properly.
- Do not cover the passenger's side dashboard with a cloth, towel, cover, etc.

Passenger Front Airbag Off Indicator

P. 58

Make sure the floor mat behind the front passenger's seat is hooked to the floor mat anchor. An improperly placed mat can interfere with the advanced airbag sensors.

Floor Mats P. 376

Driver's Knee Airbag

The driver's knee SRS airbag inflates in a moderate-to-severe frontal collision to help keep the driver in the proper position and to help maximize the benefit provided by the vehicle's other safety features.

SRS (Supplemental Restraint System) indicates that the airbag is designed to supplement seat belts, not replace them. Seat belts are the occupant's primary restraint system.

Housing Locations

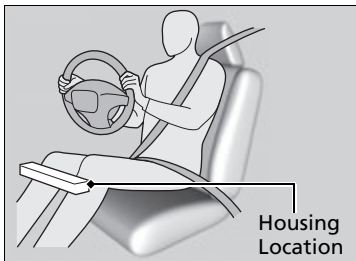

The driver's knee airbag is housed under the steering column.

The airbag is marked **SRS AIRBAG**.

Operation

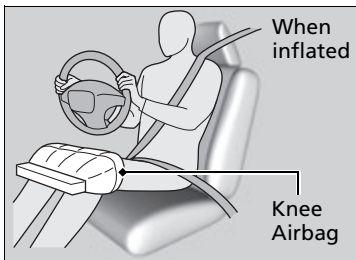

When the driver's front airbag inflates, the driver's knee airbag also inflates.

Driver's Knee Airbag

Do not attach accessories on or near the driver's knee airbag. They can interfere with the proper operation of the airbag, or hurt someone if an airbag inflates.

■ When driver's knee airbag deploys with little or no visible damage

Because the airbag system senses sudden deceleration, a strong impact to the vehicle framework or suspension might cause one or more of the airbags to deploy. Examples include running into a curb, the edge of a hole, or other low fixed object that causes a sudden deceleration in the vehicle chassis. Since the impact is underneath the vehicle, damage may not be readily apparent.

■ When driver's knee airbag may not deploy, even though exterior damage appears severe

Since crushable body parts absorb crash energy during an impact, the amount of visible damage does not always indicate proper airbag operation. In fact, some collisions can result in severe damage but no airbag deployment because the airbags would not have been needed or would not have provided protection even if they had deployed.

Side Airbags

The side airbags help protect the torso and pelvis of the driver or a front passenger during a moderate-to-severe side impact.

Housing Locations

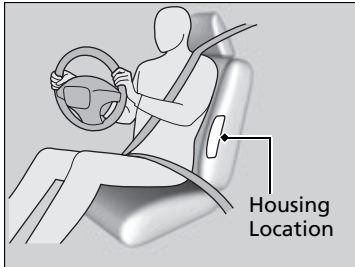

The side airbags are housed in the outside edge of the driver's and passenger's seat-backs.

Both are marked **SIDE AIRBAG**.

Operation

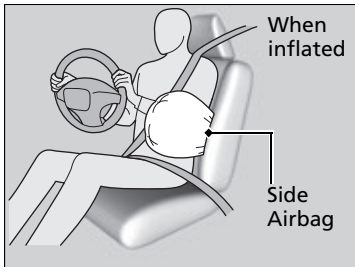

When the sensors detect a moderate-to-severe side impact, the control unit signals the side airbag on the impact side to immediately inflate.

Side Airbags

Make sure you and your front seat passenger always sit upright. Leaning into the path of a side airbag can prevent the airbag from deploying properly and increases your risk of serious injury.

Do not attach accessories on or near the side airbags. They can interfere with the proper operation of the airbags, or hurt someone if an airbag inflates.

Do not cover or replace the front seat-back covers without consulting a dealer. Improperly replacing or covering front seat-back covers can prevent your side airbags from properly deploying during a side impact.

■ When a side airbag deploys with little or no visible damage

Because the airbag system senses sudden acceleration, a strong impact to the side of the vehicle's framework can cause a side airbag to deploy. In such cases, there may be little or no damage, but the side impact sensors detected a severe enough impact to deploy the airbag.

■ When a side airbag may not deploy, even though visible damage appears severe

It is possible for a side airbag to not deploy during an impact that results in apparently severe damage. This can occur when the point of impact was toward the far front or rear of the vehicle, or when the vehicle's crushable body parts absorbed most of the crash energy. In either case, the side airbag would not have been needed nor provided protection even if it had deployed.

Side Curtain Airbags

The side curtain airbags help protect the heads of the driver and passengers in the outer seating positions during a moderate-to-severe side impact. The side curtain airbags equipped in this vehicle are also designed to help reduce the likelihood of partial and complete ejection of vehicle occupants through side windows in crashes, particularly rollover crashes.

Housing Locations

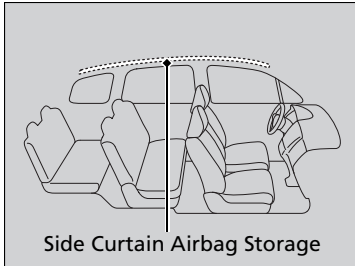

The side curtain airbags are located in the ceiling above the side windows on both sides of the vehicle.

Operation

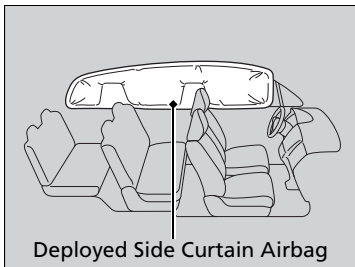

The side curtain airbag is designed to deploy in a rollover or a moderate-to-severe side impact.

Side Curtain Airbags

If the SRS control unit senses that your vehicle is about to rollover, it immediately deploys both side curtain airbags and activates both front seat belt tensioners.

If the impact is on the passenger's side, the passenger's side curtain airbag deploys even if there is no passenger in the passenger seat.

To get the best protection from the side curtain airbags, occupants should wear their seat belts properly and sit upright and well back in their seats.

Do not attach any objects to the side windows or roof pillars as they can interfere with the proper operation of the side curtain airbags.

■ When side curtain airbags deploy in a frontal collision

One or both side curtain airbags may also inflate in a moderate-to-severe angled frontal collision.

Airbag System Indicators

If a problem occurs in the airbag system, the SRS indicator will come on and a message appears on the multi-information display (MID).

■ Supplemental Restraint System (SRS) Indicator

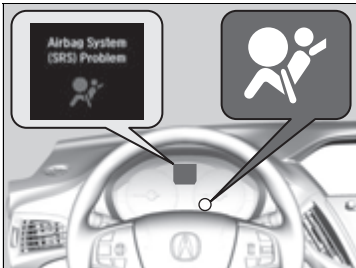

■ When the power mode is set to ON

The indicator comes on for a few seconds, then goes off. This tells you the system is working properly.

If the indicator comes on at any other time, or does not come on at all, have the system checked by a dealer as soon as possible. If you don't, your airbags and seat belt tensioners may not work properly when they are needed.

⊗ Supplemental Restraint System (SRS) Indicator

⚠ WARNING

Ignoring the SRS indicator can result in serious injury or death if the airbag systems or tensioners do not work properly.

Have your vehicle checked by a dealer as soon as possible if the SRS indicator alerts you to a possible problem.

Continued

■ Passenger Front Airbag Off Indicator

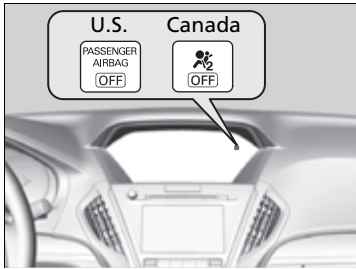

■ When the passenger front airbag off indicator comes on

The indicator comes on to alert you that the passenger's front airbag has been turned off. This occurs when the weight sensors detect about 65 lbs (29 kg) or less, the weight of an infant or small child, on the seat.

Children under the age of 12 should always ride properly restrained in a back seat.

📄 **Child Safety** P. 60

Objects placed on the seat can also cause the indicator to come on.

If the front passenger seat is empty, the passenger's front airbag will not deploy and the indicator will not come on.

📄 Passenger Front Airbag Off Indicator

If the indicator comes on with no front passenger and no objects on the passenger's seat, or with an adult riding there, something may be interfering with the weight sensors, such as:

- An object hanging on the seat or in the seat-back pocket.
- A child seat or other object pressing against the rear of the seat-back.
- A rear passenger pushing or pulling on the back of the front passenger's seat.
- The front seat or seat-back is forced back against an object on the seat or floor behind it.
- An object placed under the front passenger's seat.

If none of these conditions exist, have your vehicle checked by a dealer as soon as possible.

The passenger front airbag off indicator may come on and go off repeatedly if the total weight on the seat is near the airbag cutoff threshold.

Airbag Care

You do not need to, and should not, perform any maintenance on or replace any airbag system components yourself. However, you should have your vehicle inspected by a dealer in the following situations:

■ When the airbags have deployed

If an airbag has inflated, the control unit and other related parts must be replaced. Similarly, once an automatic seat belt tensioner has been activated, it must be replaced.

■ When the vehicle has been in a moderate-to-severe collision

Even if the airbags did not inflate, have your dealer inspect the following: the driver's seat position sensor, weight sensors in the passenger's seat, front seat belt tensioners, and each seat belt that was worn during the crash.

■ Do not remove or modify a front seat without consulting a dealer

This would likely disable or affect the proper operation of the driver's seat position sensor or the weight sensors in the passenger's seat. If it is necessary to remove or modify a front seat to accommodate a person with disabilities, contact an Acura dealer, or for U.S. vehicles, Acura Client Service at 1-800-382-2238 and for Canadian vehicles, Acura Client Service at 1-888-9-ACURA-9.

✘ Airbag Care

We recommend against the use of salvaged airbag system components, including the airbag, tensioners, sensors, and control unit.

Protecting Child Passengers

Each year, many children are injured or killed in vehicle crashes because they are either unrestrained or not properly restrained. In fact, vehicle crashes are the number one cause of death of children ages 12 and under.

To reduce the number of child deaths and injuries, every state, Canadian province and territory requires that infants and children be properly restrained when they ride in a vehicle.

Children should sit properly restrained in a rear seat. This is because:

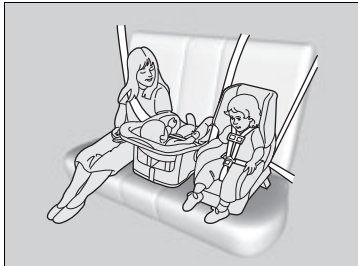

- An inflating front or side airbag can injure or kill a child sitting in the front seat.
- A child in the front seat is more likely to interfere with the driver's ability to safely control the vehicle.
- Statistics show that children of all sizes and ages are safer when they are properly restrained in a rear seat.

Protecting Child Passengers

WARNING

Children who are unrestrained or improperly restrained can be seriously injured or killed in a crash.

Any child too small for a seat belt should be properly restrained in a child seat. A larger child should be properly restrained with a seat belt, using a booster seat if necessary.

The National Highway Traffic Safety Administration and Transport Canada recommend that all children ages 12 and under be properly restrained in a rear seat. Some states or provinces/territories have laws restricting where children may ride.

- Any child who is too small to wear a seat belt correctly must be restrained in an approved child seat that is properly secured to the vehicle using either the seat belt or the lower anchors of the LATCH system.
- Never hold a child on your lap because it is impossible to protect them in the event of a collision.
- Never put a seat belt over yourself and a child. During a crash, the belt would likely press deep into the child and cause serious or fatal injuries.
- Never let two children use the same seat belt. Both children could be very seriously injured in a crash.
- Do not allow children to operate the doors, windows or seat adjustments.
- Do not leave children in the vehicle unattended, especially in hot weather when the inside of the vehicle can get hot enough to kill them. They could also activate vehicle controls causing it to move unexpectedly.

▶▶ Protecting Child Passengers

⚠ WARNING

Allowing a child to play with a seat belt or wrap one around their neck can result in serious injury or death.

Instruct children not to play with any seat belt and make sure any unused seat belt a child can reach is buckled, fully retracted, and locked.

To deactivate a lockable retractor, release the buckle and allow the seat belt to wind up all the way.

To remind you of the passenger's front airbag hazards and child safety, your vehicle has warning labels on the dashboard (U.S. models) and on the front visors. Please read and follow the instructions on these labels.

▶▶ **Safety Labels** P. 76

Safety of Infants and Small Children

■ Protecting Infants

An infant must be properly restrained in a rear-facing, reclining child seat until the infant reaches the seat manufacturer's weight or height limit for the seat, and the infant is at least one year old.

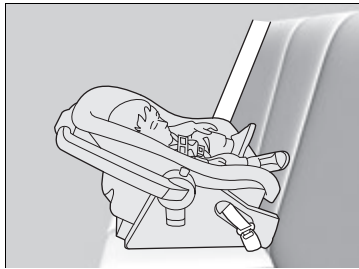

■ Positioning a rear-facing child seat

Child seats must be placed and secured in a rear seating position.

When properly installed, a rear-facing child seat may prevent the driver or a front passenger from moving their seat all the way back, or from locking their seat-back in the desired position.

It can also interfere with proper operation of the passenger's advanced front airbag system.

📄 **Airbags** P. 45

If this occurs, we recommend that you install the child seat directly behind the front passenger's seat, move the seat as far forward as needed, and leave it unoccupied. Or, you may wish to get a smaller rear-facing child seat.

📄 Protecting Infants

⚠️ WARNING

Placing a rear-facing child seat in the front seat can result in serious injury or death during a crash.

Always place a rear-facing child seat in the rear seat, not the front.

Many experts recommend use of a rear-facing seat for a child up to two years old if the child's height and weight are appropriate for a rear-facing seat.

Rear-facing child seats should never be installed in a forward facing position.

Always refer to the child seat manufacturer's instructions before installation.

■ Protecting Smaller Children

If a child is at least one year old and has exceeded the weight and height limitations of a rearward facing child seat, the child should be properly restrained in a firmly secured forward facing child seat until they exceed the weight and height limitations for the forward facing child seat.

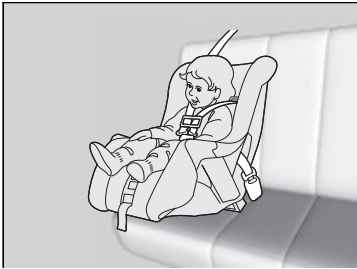

■ Forward-facing child seat placement

We strongly recommend placing a forward-facing child seat in a rear seating position.

Placing a forward-facing child seat in the front seat can be hazardous, even with advanced front airbags that automatically turn the passenger's front airbag off. A rear seat is the safest place for a child.

⌘ Protecting Smaller Children

⚠ WARNING

Placing a forward-facing child seat in the front seat can result in serious injury or death if the front airbag inflates.

If you must place a forward-facing child seat in front, move the vehicle seat as far back as possible, and properly restrain the child.

Educate yourself about the laws and regulations regarding child seat use where you are driving, and follow the child seat manufacturer's instructions.

■ Selecting a Child Seat

Most child seats are LATCH-compatible (Lower Anchors and Tethers for Children). Some have a rigid-type connector while others have a flexible-type connector. Both are equally easy to use. Some existing and previously owned child seats can only be installed using the seat belt. Whichever type you choose, follow the child seat manufacturer's use and care instructions including recommended expiration dates as well as the instructions in this manual. Proper installation is key to maximizing your child's safety.

In seating positions and vehicles not equipped with LATCH, a LATCH-compatible child seat can be installed using the seat belt and a top tether for added security. This is because all child seats are required to be designed so that they can be secured with a lap belt or the lap part of a lap/shoulder belt. In addition, the child seat manufacturer may advise that a seat belt be used to attach a LATCH-compatible seat once a child reaches a specified weight. Please read the child seat owner's manual for proper installation instructions.

■ Important consideration when selecting a child seat

Make sure the child seat meets the following three requirements:

- The child seat is the correct type and size for the child.
- The child seat is the correct type for the seating position.
- The child seat is compliant with Federal Motor Vehicle Safety Standard 213 or Canadian Motor Vehicle Safety Standard 213.

▶▶ Selecting a Child Seat

Installation of a LATCH-compatible child seat is simple.

LATCH-compatible child seats have been developed to simplify the installation process and reduce the likelihood of injuries caused by incorrect installation.

■ Installing a LATCH-Compatible Child Seat

A LATCH-compatible child seat can be installed in the second row seats. A child seat is attached to the lower anchors with either the flexible or rigid type of connectors.

1. Locate the lower anchors under the marks.

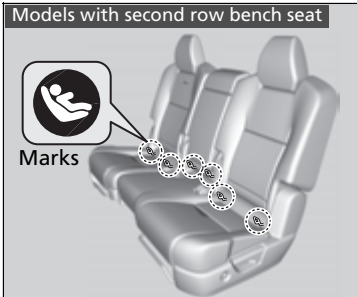
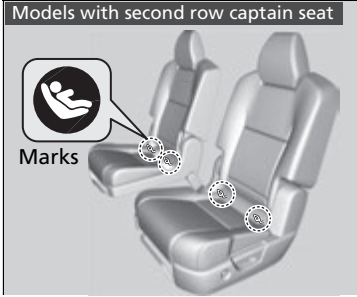

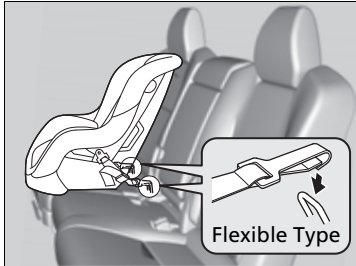
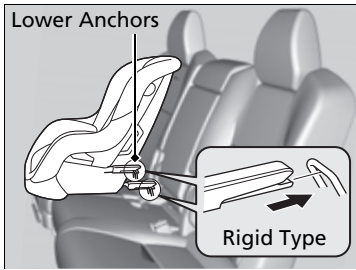

2. Place the child seat on the vehicle seat, then attach the child seat to the lower anchors according to the instructions that came with the child seat.
 - ▶ When installing the child seat, make sure that the lower anchors are not obstructed by the seat belt or any other object.

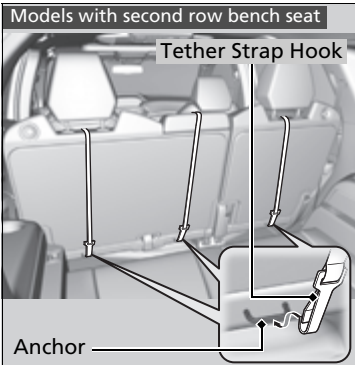
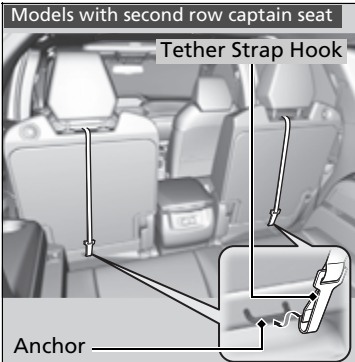

Outer positions

- Put the outer head restraint to its uppermost position, then route the tether strap between the head restraint legs, and secure the tether strap hook to the anchor. Make sure the strap is not twisted.

Center position of second row bench seat

- Put the center head restraint to its lowest position, then route the tether strap over the top of the head restraint and secure the tether strap hook to the anchor. Make sure the strap is not twisted.

All positions

- Tighten the tether strap as instructed by the child seat manufacturer.
- Make sure the child seat is firmly secured by rocking it forward and back and side to side; little movement should be felt.
- Make sure any unused seat belt that a child can reach is buckled, the lockable retractor is activated, and the belt is fully retracted and locked.

▶ **Protecting Child Passengers** P. 60

▶▶ **Installing a LATCH-Compatible Child Seat**

For your child's safety, when using a child seat installed using the LATCH system, make sure that the child seat is properly secured to the vehicle. A child seat that is not properly secured will not adequately protect a child in a crash and may cause injury to the child or other vehicle occupants.

■ Installing a Child Seat with a Lap/Shoulder Seat Belt

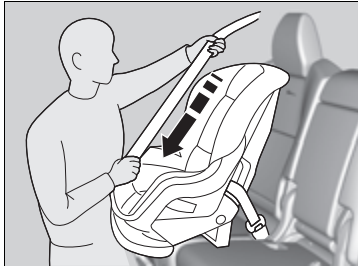
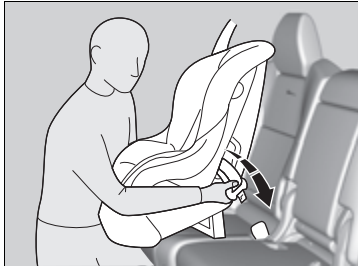

1. Place the child seat on the vehicle seat.
2. Route the seat belt through the child seat according to the seat manufacturer's instructions, and insert the latch plate into the buckle.
 - ▶ Insert the latch plate fully until it clicks.
3. Slowly pull the shoulder part of the belt all the way out until it stops. This activates the lockable retractor.
4. Let the seat belt retract a few inches and check that the retractor has switched modes by pulling on the webbing. It should not pull out again until it is reset by removing the latch plate from the buckle.
 - ▶ If you are able to pull the shoulder belt out, the lockable retractor is not activated. Slowly pull the seat belt all the way out, and repeat steps 3 – 4.

▣ Installing a Child Seat with a Lap/Shoulder Seat Belt

A child seat that is not properly secured will not adequately protect a child in a crash and may cause injury to the child or other vehicle occupants.

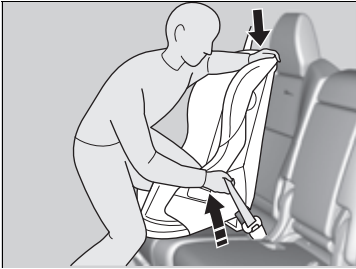

5. Grab the shoulder part of the seat belt near the buckle, and pull up to remove any slack from the lap part of the belt.

▶ When doing this, place your weight on the child seat and push it into the vehicle seat.

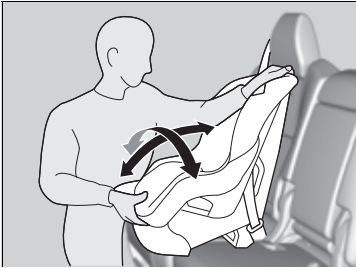

6. Make sure the child seat is firmly secured by rocking it forward and back and side to side; little movement should be felt.

7. Make sure any unused seat belt that a child can reach is buckled, the lockable retractor is activated, and the belt is fully retracted and locked.

▶▶ Installing a Child Seat with a Lap/Shoulder Seat Belt

To deactivate a lockable retractor, release the buckle and allow the seat belt to wind up all the way.

■ Adding Security with a Tether

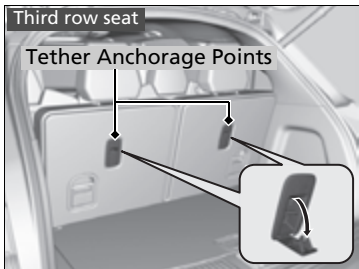
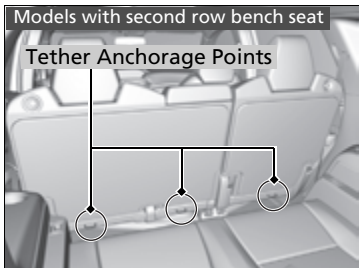
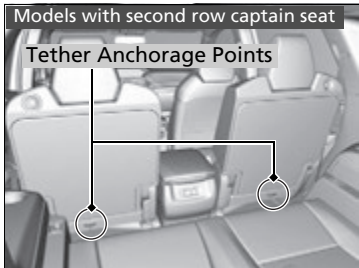

A tether anchorage point is provided behind each second and third row seating position. If you have a child restraint system that comes with a tether but can be installed with a seat belt, the tether may be used for additional security.

▶▶ Adding Security with a Tether

Always use a tether for forward facing child seats when using the seat belt or lower anchors.

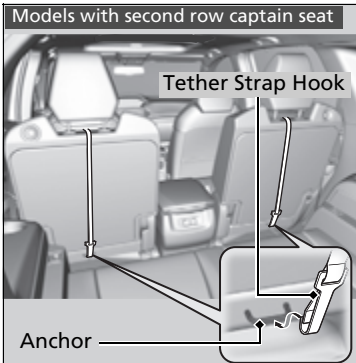

■ Using a second row anchor

Outer positions

1. Put the outer head restraint to its uppermost position, then route the tether strap between the head restraint legs, and secure the tether strap hook to the anchor. Make sure the strap is not twisted.

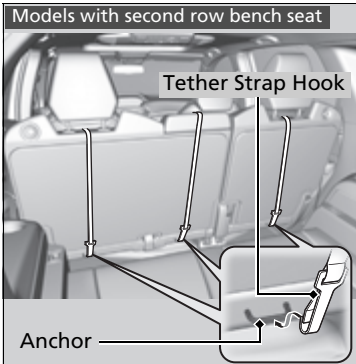

Center position of second row bench seat

1. Put the center head restraint to its lowest position, then route the tether strap over the top of the head restraint and secure the tether strap hook to the anchor. Make sure the strap is not twisted.

All positions

2. Tighten the tether strap as instructed by the child seat manufacturer.

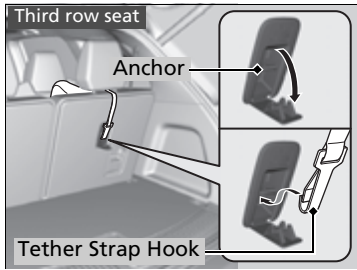

■ Using a third row anchor

1. Pull up the head restraint and push rearwards until it latches, then route the tether strap through the head restraint legs. Make sure the strap is not twisted.
2. Open the anchor cover.
3. Secure the tether strap hook to the anchor.
4. Tighten the tether strap as instructed by the child seat manufacturer.

Safety of Larger Children

■ Protecting Larger Children

The following pages give instructions on how to check proper seat belt fit, what kind of booster seat to use if one is needed, and important precautions for a child who must sit in front.

■ Checking Seat Belt Fit

When a child is too big for a child seat, secure the child in a rear seat using the lap/shoulder seat belt. Have the child sit upright and all the way back, then answer the following questions.



■ Checklist

- Do the child's knees bend comfortably over the edge of the seat?
- Does the shoulder belt cross between the child's neck and arm?
- Is the lap part of the seat belt as low as possible, touching the child's thighs?
- Will the child be able to stay seated like this for the whole trip?

If you answer yes to all these questions, the child is ready to wear the lap/shoulder seat belt correctly. If you answer no to any question, the child needs to ride on a booster seat until the seat belt fits properly without a booster seat.

▶▶ Safety of Larger Children

⚠ WARNING

Allowing a child age 12 or under to sit in front can result in injury or death if the passenger's front airbag inflates.

If a larger child must ride in front, move the vehicle seat as far to the rear as possible, have the child sit up properly and wear the seat belt properly, using a booster seat if needed.

Booster Seats



If a lap/shoulder seat belt cannot be used properly, position the child in a booster seat in the rear seat. For the child's safety, check that the child meets the booster seat manufacturer's recommendations.

Protecting Larger Children-Final Checks

Your vehicle has a rear seat where children can be properly restrained. If you ever have to carry a group of children, and a child must ride in front:

- Make sure you read and fully understand the instructions and safety information in this manual.
- Move the front passenger seat as far back as possible.
- Have the child sit upright and well back in the seat.
- Check that the seat belt is properly positioned so that the child is secure in the seat.

Monitoring child passengers

We strongly recommend that you keep an eye on child passengers. Even older, more mature children sometimes need to be reminded to fasten their seat belts and sit up properly.

Booster Seats

When installing a booster seat, make sure to read the instructions that came with it, and install the seat accordingly.

There are high- and low-type booster seats. Choose a booster seat that allows the child to wear the seat belt correctly.

Some U.S. states, and Canadian provinces and territories require children to use a booster seat until they reach a given age or weight (e.g. six years or 60 lbs). Be sure to check current laws in the state or province, or territory where you intend to drive.

Carbon Monoxide Gas

The engine exhaust from this vehicle contains carbon monoxide, a colorless, odorless, and highly toxic gas. As long as you properly maintain your vehicle, carbon monoxide gas will not get into the interior.

■ Have the exhaust system inspected for leaks whenever

- The exhaust system is making an unusual noise.
- The exhaust system may have been damaged.
- The vehicle is raised for an oil change.

When you operate a vehicle with the tailgate open, airflow can pull exhaust gas into the interior and create a hazardous condition. If you must drive with the tailgate open, open all the windows and set the climate control system as shown below.

1. Select the fresh air mode.
2. Select the  mode.
3. Set the fan speed to high.
4. Set the temperature control to a comfortable setting.

Adjust the climate control system in the same manner if you sit in your parked vehicle with the engine running.

☒ Carbon Monoxide Gas

⚠ WARNING

Carbon monoxide gas is toxic.

Breathing it can cause unconsciousness and even kill you.

Avoid any enclosed areas or activities that expose you to carbon monoxide.

An enclosed area such as a garage can quickly fill up with carbon monoxide gas. Do not run the engine with the garage door closed. Even when the garage door is open, drive out of the garage immediately after starting the engine.







Instrument Panel

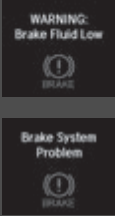



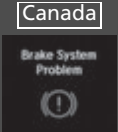

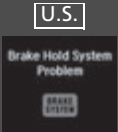

This chapter describes the buttons, indicators, and gauges that are used while driving.







Indicators	78
Multi-Information Display (MID) Warning and Information Messages	99
Gauges and Multi-Information Display (MID)	
Gauges	117
MID	119





Indicator	Name	On/Blinking	Explanation	Message
 <p>U.S. BRAKE Canada Brake System Indicator (Red)</p>	<p>Brake System Indicator (Red)</p>	<ul style="list-style-type: none"> • Comes on for a few seconds when you set the power mode to ON, then goes off. • Comes on when the brake fluid level is low. • Comes on if there is a problem with the brake system. 	<ul style="list-style-type: none"> • Comes on while driving - Check the brake fluid level. <ul style="list-style-type: none"> ➤ What to do when the indicator comes on while driving P. 414 • Comes on along with the brake system indicator (amber) - Immediately stop in a safe place. Contact a dealer for repair. The brake pedal becomes harder to operate. Depress the pedal further than you normally do. • Comes on along with the ABS indicator - Have your vehicle checked by a dealer. <ul style="list-style-type: none"> ➤ If the Brake System Indicator (Red) Comes On P. 414 	 <p>WARNING: Brake Fluid Low</p> <p>Brake System Problem</p>





Indicator	Name	On/Blinking	Explanation	Message
 <p>U.S. BRAKE SYSTEM Canada (Amber)</p>	<p>Brake System Indicator (Amber)</p>	<ul style="list-style-type: none"> • Comes on for a few seconds when you set the power mode to ON, then goes off. • Comes on if there is a problem with a system related to braking other than the conventional brake system. • Comes on if there is a problem with the electric parking brake system. • Comes on if there is a problem with the cooperative control with regenerative braking, the electric servo brake system, or the hill start assist system. 	<ul style="list-style-type: none"> • Comes on while driving - Have your vehicle checked by a dealer. • Stays on constantly - Avoid high speeds and sudden braking. Take the vehicle to a dealer immediately. • With this indicator on, your vehicle still has normal braking ability. 	  
		<ul style="list-style-type: none"> • Comes on if there is a problem with the automatic brake hold system. 	<p>➤ Automatic Brake Hold P. 303</p>	 

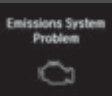



Indicator	Name	On/Blinking	Explanation	Message
	Electric Parking Brake Indicator	<ul style="list-style-type: none"> • Comes on for a few seconds when you set the power mode to ON, then goes off. • Comes on when the parking brake is applied, and goes off when it is released. • Comes on for about 15 seconds then goes off when you push the electric parking brake switch with the power mode in OFF. • Comes on for about 15 seconds then goes off when you set the power mode to OFF with the parking brake applied. 	<ul style="list-style-type: none"> • Blinks and the electric parking brake system indicator comes on at the same time - There is a problem with the electric parking brake system. The parking brake may not be set. 	
	Electric Parking Brake System Indicator	<ul style="list-style-type: none"> • Comes on when you pull the electric parking brake switch without depressing the brake pedal. 	<ul style="list-style-type: none"> • Depress the brake pedal to release the parking brake.  Parking Brake P. 299 	To Release Parking Brake: Brake + Pull 
	Electric Parking Brake System Indicator	<ul style="list-style-type: none"> • Comes on for a few seconds when you set the power mode to ON, then goes off. • Comes on if there is a problem with the electric parking brake system. 	<ul style="list-style-type: none"> • Comes on while driving - Avoid using the parking brake and have your vehicle checked by a dealer immediately.  If the Electric Parking Brake System Indicator Comes On P. 415 	Electric Parking Brake Problem 









Indicator	Name	On/Blinking	Explanation	Message
	Automatic Brake Hold System Indicator	<ul style="list-style-type: none"> • Comes on for a few seconds when you set the power mode to ON, then goes off. • Comes on when the automatic brake hold system is on. 	<p>➤ Automatic Brake Hold P. 303</p>	
	Automatic Brake Hold Indicator	<ul style="list-style-type: none"> • Comes on for a few seconds when you set the power mode to ON, then goes off. • Comes on when the automatic brake hold is activated. 	<p>➤ Automatic Brake Hold P. 303</p>	







Instrument Panel







Indicator	Name	On/Blinking	Explanation	Message
	Low Oil Pressure Indicator	<ul style="list-style-type: none"> • Comes on when you set the power mode to ON, and goes off when the power system starts. • Comes on when the engine oil pressure is low. 	<ul style="list-style-type: none"> • Comes on while driving - Immediately stop in a safe place. <ul style="list-style-type: none"> ➤ If the Low Oil Pressure Indicator Comes On P. 412 	
	Malfunction Indicator Lamp	<ul style="list-style-type: none"> • Comes on when you set the power mode to ON, and goes off either when the power system is on or after several seconds if the power system did not start. If "readiness codes" have not been set, it blinks five times before it goes off. • Comes on if there is a problem with the emissions control systems. • Blinks when a misfire in the engine's cylinders is detected. 	<ul style="list-style-type: none"> • Readiness codes are part of the on board diagnostics for the emissions control systems. <ul style="list-style-type: none"> ➤ Testing of Readiness Codes P. 437 • Comes on while driving - Have your vehicle checked by a dealer. • Blinks while driving - Stop in a safe place where there are no flammable objects. Stop the power system for 10 minutes or more, and wait for it to cool down. Then, take your vehicle to a dealer. <ul style="list-style-type: none"> ➤ If the Malfunction Indicator Lamp Comes On or Blinks P. 413 	
	12-Volt Battery Charging System Indicator	<ul style="list-style-type: none"> • Comes on when you set the power mode to ON, and goes off when the power system is on. • Comes on when the 12-volt battery is not charging. 	<ul style="list-style-type: none"> • Comes on while driving - Turn off the climate control system and rear defogger in order to reduce electricity consumption. <ul style="list-style-type: none"> ➤ If the 12-Volt Battery Charging System Indicator Comes On P. 412 	



Indicator	Name	On/Blinking	Explanation	Message
	Gear Position Indicator	<ul style="list-style-type: none"> Indicates the current gear selection. 	 Shifting P. 247	—
	M (sequential mode) Indicator/ Sequential Mode Gear Selection Indicator	<ul style="list-style-type: none"> Comes on when the manual sequential mode is applied. 	 Sequential Mode P. 253	—







Indicator	Name	On/Blinking	Explanation	Message
	Transmission System Indicator	<ul style="list-style-type: none"> The indicated current gear selection blinks if there is a problem with the transmission system. 	<ul style="list-style-type: none"> Avoid sudden start and acceleration, and stop in a safe place immediately. Have your vehicle checked by a dealer. 	
		<ul style="list-style-type: none"> All the gear positions may light for several seconds. 	<ul style="list-style-type: none"> When all the gear positions light, immediately stop your vehicle in a safe place. Indicators go off if there is no problem. However, even if they go off, take your vehicle to a dealer for inspection. 	
		<ul style="list-style-type: none"> The indicated current gear selection or all the gear positions blink if there is a problem with the transmission system, and the vehicle no longer moves. 	<ul style="list-style-type: none"> Immediately stop in a safe place. <ul style="list-style-type: none"> ➤ Emergency Towing P. 427 Have your vehicle checked by a dealer. 	
		<ul style="list-style-type: none"> The indicated current gear selection or all the gear positions blink if you cannot select P due to the transmission system failure. 	<ul style="list-style-type: none"> The power system can be activated as a temporary measure. <ul style="list-style-type: none"> ➤ If the Transmission System Indicator Blinks along with the Warning Message P. 416 Set the parking brake when parking. Have your vehicle checked by a dealer immediately. 	

Indicator	Name	On/Blinking	Explanation	Message
	Seat Belt Reminder Indicator	<ul style="list-style-type: none"> • Comes on and the beeper sounds if you are not wearing a seat belt when you set the power mode to ON. • If the front passenger is not wearing a seat belt, the indicator comes on about a few seconds later. • Blinks while driving if either you or the front passenger has not fastened a seat belt. The beeper sounds and the indicator blinks at regular intervals. 	<ul style="list-style-type: none"> • The beeper stops and the indicator goes off when you and the front passenger fasten their seat belts. • Stays on after you or the front passenger has fastened the seat belt - A detection error may have occurred in the sensor. Have your vehicle checked by a dealer. <ul style="list-style-type: none"> ▣ Seat Belt Reminder P. 39 	 
	Low Fuel Indicator	<ul style="list-style-type: none"> • Comes on when the fuel reserve is running low (approximately 2.5 U.S. gal./9.5 Liter left). • Blinks if there is a problem with the fuel gauge. 	<ul style="list-style-type: none"> • Comes on - Refuel your vehicle as soon as possible. • Blinks - Have your vehicle checked by a dealer. 	 
	POWER SYSTEM Indicator	<ul style="list-style-type: none"> • Comes on for a few seconds when you set the power mode to ON, then goes off. • Comes on if there is a problem with the electric vehicle system. 	<ul style="list-style-type: none"> • Comes on while driving - Have your vehicle checked by a dealer immediately. <ul style="list-style-type: none"> ▣ If the Power System Indicator Comes On P. 417 	



Indicator	Name	On/Blinking	Explanation	Message
	High Temperature Indicator	<ul style="list-style-type: none"> • Comes on for a few seconds when you set the power mode to ON, then goes off. • Blinks when the engine coolant temperature goes up, and stays on if the temperature continues to rise. 	<ul style="list-style-type: none"> • Blinks while driving - Drive slowly to prevent overheating. 	
			<ul style="list-style-type: none"> • Stays on while driving - Immediately stop in a safe place and allow the engine to cool. <ul style="list-style-type: none"> ➤ Overheating P. 409 	
	Low Temperature Indicator	<ul style="list-style-type: none"> • Comes on for a few seconds when you set the power mode to ON, then goes off. • Comes on when the engine coolant temperature is low. 	<ul style="list-style-type: none"> • If the indicator stays on after the engine has reached normal operating temperature, there may be problem with the temperature sensors. Have your vehicle inspected by a dealer. 	—
	SPORT+ mode Indicator	<ul style="list-style-type: none"> • Comes on for a few seconds when you set the power mode to ON, then goes off. • Comes on when you press the Dynamic Mode button if the Sport+ mode was selected. 	<ul style="list-style-type: none"> ➤ Integrated Dynamics System P. 256 	—
	READY Indicator	<ul style="list-style-type: none"> • Comes on when the vehicle is ready to drive. 	<ul style="list-style-type: none"> ➤ Turning on the Power P. 239 	





Indicator	Name	On/Blinking	Explanation	Message
	Anti-lock Brake System (ABS) Indicator	<ul style="list-style-type: none"> • Comes on for a few seconds when you set the power mode to ON, then goes off. • If it comes on at any other time, there is a problem with the ABS. 	<ul style="list-style-type: none"> • Stays on constantly - Have your vehicle checked by a dealer. With this indicator on, your vehicle still has normal braking ability but no anti-lock function.  Anti-lock Brake System (ABS) P. 305 	
	Supplemental Restraint System Indicator	<ul style="list-style-type: none"> • Comes on for a few seconds when you set the power mode to ON, then goes off. • Comes on if a problem with any of the following is detected: <ul style="list-style-type: none"> - Supplemental restraint system - Side airbag system - Side curtain airbag system - Seat belt tensioner 	<ul style="list-style-type: none"> • Stays on constantly or does not come on at all - Have your vehicle checked by a dealer. 	
	Auto High-Beam Indicator	<ul style="list-style-type: none"> • Comes on when all the operating conditions of the Auto high-beam are met. 	 Auto High-Beam P. 172	—







Indicator	Name	On/Blinking	Explanation	Message
	Vehicle Stability Assist (VSA®) System Indicator	<ul style="list-style-type: none"> • Comes on for a few seconds when you set the power mode to ON, then goes off. • Blinks when VSA® is active. • Comes on if there is a problem with the VSA®. 	<ul style="list-style-type: none"> • Stays on constantly - Have your vehicle checked by a dealer. <ul style="list-style-type: none"> ➤ Vehicle Stability Assist (VSA®), aka Electronic Stability Control (ESC), System P. 287 	
	VSA® OFF Indicator	<ul style="list-style-type: none"> • Comes on for a few seconds when you set the power mode to ON, then goes off. • Comes on when you partially disable VSA®. 	<ul style="list-style-type: none"> ➤ VSA® On and Off P. 288 	—

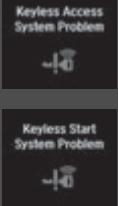

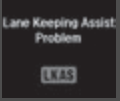



Indicator	Name	On/Blinking	Explanation	Message
	Speed-sensitive Electric Power Steering (EPS) System Indicator	<ul style="list-style-type: none"> Comes on when you set the power mode to ON, and goes off when the power system is on. Comes on if there is a problem with the EPS system. 	<ul style="list-style-type: none"> Stays on constantly or does not come on at all - Have your vehicle checked by a dealer. <ul style="list-style-type: none"> ☒ If the Speed-Sensitive Electric Power Steering (EPS) System Indicator Comes On P. 414 	
	Low Tire Pressure/TPMS Indicator	<ul style="list-style-type: none"> Comes on for a few seconds when you set the power mode to ON, then goes off. Comes on if the tire pressure of any of the tires becomes significantly low. Blinks for about one minute, and then stays on if there is a problem with the TPMS, or when a spare tire* is temporarily installed. 	<ul style="list-style-type: none"> Comes on while driving - Stop in a safe place, check tire pressures, and inflate the tire(s) if necessary. Blinks and remains on - Have your vehicle checked by a dealer. If the vehicle is fitted with a spare, get your regular tire repaired or replaced and put back on your vehicle as soon as you can. 	 
	Turn Signal and Hazard Warning Indicators	<ul style="list-style-type: none"> Blinks when you operate the turn signal lever. Blinks along with all turn signals if you press the hazard warning button. 	<ul style="list-style-type: none"> Does not blink or blinks rapidly <ul style="list-style-type: none"> ☒ Replacing Light Bulbs P. 352 	—
	High Beam Indicator	<ul style="list-style-type: none"> Comes on when the high beam headlights are on. 	—	—





* Not available on all models



Indicator	Name	On/Blinking	Explanation	Message
	Lights On Indicator	<ul style="list-style-type: none"> Comes on whenever the light switch is on, or in AUTO when the exterior lights are on. 	<ul style="list-style-type: none"> If you set the power mode to ACCESSORY or VEHICLE OFF while the lights are on, a chime sounds when the driver's door is opened. 	—
	Fog Light Indicator*	<ul style="list-style-type: none"> Comes on when the fog lights are on. 	—	—
	Immobilizer System Indicator	<ul style="list-style-type: none"> Comes on briefly when you set the power mode to ON, then goes off. Comes on if the immobilizer system cannot recognize the key information. 	<ul style="list-style-type: none"> Blinks - You cannot start the power system. Set the power mode to VEHICLE OFF, then select the ON mode again. Repeatedly blinks - The system may be malfunctioning. Have your vehicle checked by a dealer. Do not attempt to alter this system or add other devices to it. Electrical problems can occur. 	—



Indicator	Name	On/Blinking	Explanation	Message
	Security System Alarm Indicator	<ul style="list-style-type: none"> Blinks when the security system alarm has been set. 	<p> Security System Alarm P. 158</p>	—
	System Message Indicator	<ul style="list-style-type: none"> Comes on for a few seconds when you set the power mode to ON, then goes off. Comes on along with a beep when a problem is detected. A system message on the MID appears at the same time. 	<ul style="list-style-type: none"> While the indicator is on, roll the multi-function steering wheel control to see the message again. Refer to the Indicators information in this chapter when a system message appears on the MID. Take the appropriate action for the message. The MID does not return to the normal screen unless the warning is canceled, or the multi-function steering-wheel controls is rolled. 	—
	Keyless Access System Indicator	<ul style="list-style-type: none"> Comes on for a few seconds when you set the power mode to ON, then goes off. Comes on as soon as a problem is detected in the keyless access system or keyless starting system. 	<ul style="list-style-type: none"> Have your vehicle checked by a dealer. 	







Indicator	Name	On/Blinking	Explanation	Message
	Lane Keeping Assist System (LKAS) Indicator (Amber)	<ul style="list-style-type: none"> • Comes on for a few seconds when you set the power mode to ON, then goes off. • Comes on if there is a problem with the LKAS. 	<ul style="list-style-type: none"> • Stays on constantly - Have your vehicle checked by a dealer. 	
	Lane Keeping Assist System (LKAS) Indicator (Green)	<ul style="list-style-type: none"> • Comes on when you press the MAIN button. • Comes on when the LKAS is in operation, or the LKAS button is pressed, but the temperature inside the front sensor camera is too high. The LKAS cancels automatically. The beeper sounds simultaneously. • Comes on when the area around the camera is blocked by dirt, mud, etc. Stop your vehicle in a safe place, and wipe it off with a soft cloth. • May come on when driving in bad weather (rain, snow, fog, etc.) 	<ul style="list-style-type: none"> •  Lane Keeping Assist System (LKAS) P. 279 • Use the climate control system to cool down the camera. • Goes off - The camera has been cooled down and the system activates normally.  Front Sensor Camera P. 257 • Have your vehicle checked by a dealer if the indicator and message come back on after you cleaned the area around the camera. 	  





Indicator	Name	On/Blinking	Explanation	Message
	Road Departure Mitigation (RDM) Indicator	<ul style="list-style-type: none"> • Comes on for a few seconds when you set the power mode to ON, then goes off. • Comes on if there is a problem with the RDM system. 	<ul style="list-style-type: none"> • Stays on constantly - Have your vehicle checked by a dealer. 	
		<ul style="list-style-type: none"> • Comes on when the RDM system shuts itself off. 	<ul style="list-style-type: none"> • Stays on - The temperature inside the camera is too high. Use the climate control system to cool down the camera. The system activates when the temperature inside the camera cools down.  Front Sensor Camera P. 257 	
			<ul style="list-style-type: none"> • Stays on - The area around the camera is blocked by dirt, mud, etc. Stop your vehicle in a safe place, and wipe it off with a soft cloth. • Have your vehicle checked by a dealer if the indicator and message come back on after you cleaned the area around the camera.  Front Sensor Camera P. 257 	

Indicator	Name	On/Blinking	Explanation	Message
	Adaptive Cruise Control (ACC) with Low Speed Follow (LSF) Indicator (Amber)	<ul style="list-style-type: none"> • Comes on for a few seconds when you set the power mode to ON, then goes off. • Comes on if there is a problem with ACC with LSF. 	<ul style="list-style-type: none"> • Comes on while driving - Have your vehicle checked by a dealer. 	
	Adaptive Cruise Control (ACC) with Low Speed Follow (LSF) Indicator (Green)	<ul style="list-style-type: none"> • Comes on when you press the MAIN button. • Comes on if anything covers the radar sensor cover and prevents the sensor from detecting a vehicle in front. • May come on when driving in bad weather (rain, snow, fog, etc.) • ACC has been automatically canceled. 	<ul style="list-style-type: none"> •  Adaptive Cruise Control (ACC) with Low Speed Follow (LSF) P. 259 • When the radar sensor gets dirty, stop your vehicle in a safe place, and wipe off dirt using a soft cloth. • Have your vehicle checked by a dealer if the message does not disappear even after you clean the sensor cover. 	

Indicator	Name	On/Blinking	Explanation	Message
	Adaptive Cruise Control (ACC) with Low Speed Follow (LSF) Indicator (Green)	<ul style="list-style-type: none"> • Comes on when ACC with LSF is in operation, but the temperature inside the front sensor camera is too high. ACC with LSF cancels automatically. The beeper sounds simultaneously. 	<ul style="list-style-type: none"> • Use the climate control system to cool down the camera. • Goes off - The camera has been cooled down and the system activates normally. 	
		<ul style="list-style-type: none"> • Comes on when the area around the camera is blocked by dirt, mud, etc. Stop your vehicle in a safe place, and wipe it off with a soft cloth. • May come on when driving in bad weather (rain, snow, fog, etc.) 	<ul style="list-style-type: none"> • Have your vehicle checked by a dealer if the indicator and message come back on after you cleaned the area around the camera. 	





Indicator	Name	On/Blinking	Explanation	Message
	Collision Mitigation Braking System™ (CMBS™) Indicator	<ul style="list-style-type: none"> • Comes on for a few seconds when you set the power mode to ON, then goes off. • Comes on when you deactivate the CMBS™. A multi-information display message appears for five seconds. • Comes on if there is a problem with the CMBS™. 	<ul style="list-style-type: none"> • Stays on constantly without the CMBS™ off - Have your vehicle checked by a dealer. <ul style="list-style-type: none"> ▶ Collision Mitigation Braking System™ (CMBS™) P. 307 	 



Indicator	Name	On/Blinking	Explanation	Message
	Collision Mitigation Braking System™ (CMBS™) Indicator	<ul style="list-style-type: none"> Comes on when the CMBS™ system shuts itself off. 	<ul style="list-style-type: none"> Stays on - The area around the camera is blocked by dirt, mud, etc. Stop your vehicle in a safe place, and wipe it off with a soft cloth.  Front Sensor Camera P. 257 	
			<ul style="list-style-type: none"> When the radar sensor gets dirty, stop your vehicle in a safe place, and wipe off dirt using a soft cloth. Have your vehicle checked by a dealer if the message does not disappear even after you clean the sensor cover.  Collision Mitigation Braking System™ (CMBS™) P. 307 	
			<ul style="list-style-type: none"> Stays on - The temperature inside the camera is too high. Use the climate control system to cool down the camera. The system activates when the temperature inside the camera cools down.  Front Sensor Camera P. 257 	



Indicator	Name	On/Blinking	Explanation	Message
	Blind spot information (BSI) Indicator	<ul style="list-style-type: none"> • Comes on for a few seconds when you set the power mode to ON, then goes off. • Stays on while BSI is turned off. 	—	
		<ul style="list-style-type: none"> • Comes on when mud, snow, or ice accumulates in the vicinity of sensor. 	<ul style="list-style-type: none"> • Comes on while driving - Remove the obstacle in the vicinity of sensor. ➤ Blind spot information (BSI) System P. 291 	
		<ul style="list-style-type: none"> • Comes on if there is a problem with the system. 	<ul style="list-style-type: none"> • Comes on while driving - Have your vehicle checked by a dealer. 	

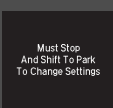

Multi-Information Display (MID) Warning and Information Messages



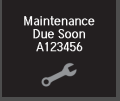

The following messages appear only on the MID. Roll the multi-function steering-wheel controls to see the message again with the system message indicator on.

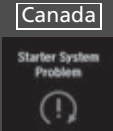

Message	Condition	Explanation
<div style="background-color: #333; color: white; padding: 5px; margin-bottom: 5px;">Door Open</div>  <div style="background-color: #333; color: white; padding: 5px; margin-bottom: 5px;">Tailgate Open</div>  <div style="background-color: #333; color: white; padding: 5px;">Door And Tailgate Open</div> 	<ul style="list-style-type: none"> Appears if any door or the tailgate is not completely closed. 	<ul style="list-style-type: none"> Goes off when all doors and the tailgate are closed.
<div style="background-color: #333; color: white; padding: 5px;">Hood Open</div> 	<ul style="list-style-type: none"> Appears when the hood is opened. 	<ul style="list-style-type: none"> Close the hood.

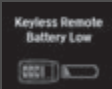

Message	Condition	Explanation
	<ul style="list-style-type: none"> • Appears when the washer fluid is low. 	<ul style="list-style-type: none"> • Refill washer fluid. <ul style="list-style-type: none"> ➤ Refilling Window Washer Fluid P. 351
	<ul style="list-style-type: none"> • Appears while you are customizing the settings and the transmission is in other than P. 	<ul style="list-style-type: none"> ➤ Customized Features P. 125
	<ul style="list-style-type: none"> • Appears when there is a problem with the sensor on the 12-volt battery. • Appears along with the battery charging system indicator when the battery is not charging. 	<ul style="list-style-type: none"> • Have your vehicle checked by a dealer. <ul style="list-style-type: none"> ➤ Checking the 12-Volt Battery P. 370 • Turn off the climate control system and rear defogger to reduce electricity consumption. <ul style="list-style-type: none"> ➤ If the 12-Volt Battery Charging System Indicator Comes On P. 412



Message	Condition	Explanation
	<ul style="list-style-type: none"> • Appears when the scheduled maintenance is due soon. • Consequently, Maintenance Due Now and Maintenance Past Due follow. 	<p>► Maintenance Minder Messages on the Multi-Information Display (MID) P. 336</p>
 	<ul style="list-style-type: none"> • Appears when there is a problem with the power tailgate system. 	<ul style="list-style-type: none"> • Manually open or close the power tailgate. • Have your vehicle checked by a dealer.



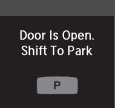

Message	Condition	Explanation
 	<ul style="list-style-type: none"> • Appears if there is a problem with the starter system. 	<ul style="list-style-type: none"> • Hold the POWER button up to 15 seconds to start the power system. <ul style="list-style-type: none"> ➤ Turning on the Power P. 239 Have your vehicle checked by a dealer.
	<ul style="list-style-type: none"> • Appears when you set the power mode to ACCESSORY or ON. 	<ul style="list-style-type: none"> ➤ Turning on the Power P. 239
	<ul style="list-style-type: none"> • Appears three seconds after you bring the keyless access remote in front of the POWER button when To Start, Hold Remote Near Start Button appears. To Start Engine: Brake + Push appears sequentially. 	<ul style="list-style-type: none"> • Unless you bring the keyless access remote in front of the POWER button, this message does not appear. <ul style="list-style-type: none"> ➤ If the Keyless Access Remote Battery is Weak P. 405

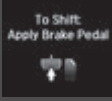
Message	Condition	Explanation
	<ul style="list-style-type: none"> • Appears when the power mode is in ACCESSORY. 	<p>—</p>
	<ul style="list-style-type: none"> • Appears after the driver's door is opened when the power mode is in ACCESSORY. 	<ul style="list-style-type: none"> • Press the POWER button twice with your foot off the brake pedal to change the power mode to VEHICLE OFF.
	<ul style="list-style-type: none"> • Appears when you close the door with the power mode is in ON without the keyless access remote inside the vehicle. 	<ul style="list-style-type: none"> • Disappears when you bring the keyless access remote back inside the vehicle and close the door. <ul style="list-style-type: none"> ► Keyless Access Remote Reminder P. 166
	<ul style="list-style-type: none"> • Appears when the keyless access remote's battery becomes weak. 	<ul style="list-style-type: none"> • Replace the battery as soon as possible. <ul style="list-style-type: none"> ► Replacing the Button Battery P. 371
	<ul style="list-style-type: none"> • Appears if the keyless access remote's battery is too weak to start the power system or the key is not within operating range to start the power system. The beeper sounds six times. 	<ul style="list-style-type: none"> • Bring the keyless access remote in front of the POWER button to be touched with. <ul style="list-style-type: none"> ► If the Keyless Access Remote Battery is Weak P. 405

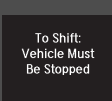
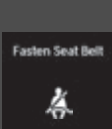
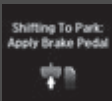

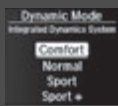

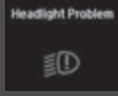
Message	Condition	Explanation
 <p>Stop Driving When Safe, Transmission Temperature Too Hot.</p>	<ul style="list-style-type: none"> • Appears when the transmission system temperature is too high. 	<ul style="list-style-type: none"> • Immediately stop in a safe place in P. • Let the engine idle until the message disappears.
 <p>To Start Vehicle: Shift To Park.</p> <p>P</p>	<ul style="list-style-type: none"> • Appears when you turn the power system on with the transmission not in P. 	<ul style="list-style-type: none"> • Press the P button.
 <p>Stop The Vehicle When Safe. Use Caution, Vehicle May Move When Parked.</p>	<ul style="list-style-type: none"> • Appears if there is a problem with the electric system. • Appears when you set the power mode to OFF while driving. 	<ul style="list-style-type: none"> • Immediately stop in a safe place and set the parking brake. • Continue driving if the message goes off soon after. • If there is a problem with the transmission system, the transmission system indicator comes on. ➤ Transmission System Indicator P. 84





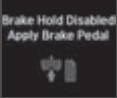
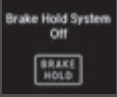

Message	Condition	Explanation
	<ul style="list-style-type: none"> Appears when you attempt to change to another gear position with the transmission in P and the engine OFF. 	<ul style="list-style-type: none"> To select another gear position while in P the engine must be ON.
	<ul style="list-style-type: none"> Appears when you try to change the gear position after the position has automatically been changed to P with the driver's door open and the driver's seat belt unfastened. 	<ul style="list-style-type: none"> Press the P button If you leave the vehicle.
	<ul style="list-style-type: none"> Appears when the vehicle is stopped with the driver's seat belt unfastened and there is a chance that the vehicle may roll unintentionally. 	<ul style="list-style-type: none"> Press the P button before release the brake pedal when idling, parking or exiting the vehicle. <ul style="list-style-type: none"> ➤ Shift Operation P. 249
	<ul style="list-style-type: none"> Appears when you change to N, then release the N button. 	<ul style="list-style-type: none"> ➤ If you want to keep the transmission in N position [car wash mode] P. 251





Message	Condition	Explanation
	<ul style="list-style-type: none"> Appears when you try to change the gear position without depressing the brake pedal. 	<ul style="list-style-type: none"> Depress the brake pedal, then select a shift button.
	<ul style="list-style-type: none"> Appears when you try to change the gear position without releasing your foot off the accelerator pedal. 	<ul style="list-style-type: none"> Release your foot off the accelerator pedal, then select a shift button.
	<ul style="list-style-type: none"> Appears when the P button is pressed while the vehicle is moving. Appears if you change the gear position to R while the vehicle is moving forward, or to D while the vehicle is reversing. 	<ul style="list-style-type: none"> Make sure that the vehicle comes to a stop before operating the select button.
	<ul style="list-style-type: none"> Appears when you set the power mode to ON without fastening the driver's seat belt. Appears when you change the gear position after P has been automatically selected with the driver's door open, the driver's seat belt unfastened, then the brake pedal is released. 	<ul style="list-style-type: none"> Fasten the seat belt properly before you start to drive. <ul style="list-style-type: none"> ➤ Shift Operation P. 249
	<ul style="list-style-type: none"> Appears when you press the P button but it is not engaged due to low ATF temperature. 	<ul style="list-style-type: none"> Depress the brake pedal until this message disappear.



Message	Condition	Explanation
	<ul style="list-style-type: none"> Appears when pressing the Dynamic Mode button. <ul style="list-style-type: none"> Press again to change the next mode. 	<p>► Integrated Dynamics System P. 256</p>
	<ul style="list-style-type: none"> Appears if there is a problem with the active damper system. 	<ul style="list-style-type: none"> Have your vehicle checked by a dealer. With this icon on, your vehicle has limited damping ability without the active damper system.
	<ul style="list-style-type: none"> Appears if there is a problem with the cooling system. 	<ul style="list-style-type: none"> Drive slowly to prevent overheating and have your vehicle checked by a dealer as soon as possible.
	<ul style="list-style-type: none"> Appears when there is a problem with the headlights. 	<ul style="list-style-type: none"> Appears while driving - The headlights may not be on. When conditions allow you to drive safely, have your vehicle checked by a dealer as soon as possible.
	<ul style="list-style-type: none"> Appears if there is a problem with the parking sensor system*. 	<ul style="list-style-type: none"> Check if the area around the sensor(s) is covered with mud, ice, snow, etc. If the indicator(s) stays on or the beeper does not stop even after you clean the area, have the system checked by a dealer.

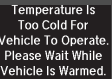



* Not available on all models



Message	Condition	Explanation
	<ul style="list-style-type: none"> • Appears if the automatic brake hold is automatically canceled while it is in operation. 	<ul style="list-style-type: none"> • Immediately depress the brake pedal.
	<ul style="list-style-type: none"> • Appears when the automatic brake hold system is turned off. 	<p>➤ Automatic Brake Hold P. 303</p>
	<ul style="list-style-type: none"> • Appears when the automatic brake hold button is pressed without wearing the driver's seat belt. 	<ul style="list-style-type: none"> • Fasten the driver's seat belt. <p>➤ Automatic Brake Hold P. 303</p>
	<ul style="list-style-type: none"> • Appears when the automatic brake hold button is pressed without depressing the brake pedal while the automatic brake hold is in operation. 	<ul style="list-style-type: none"> • Press the automatic brake hold button with the brake pedal depressed. <p>➤ Automatic Brake Hold P. 303</p>
	<ul style="list-style-type: none"> • Appears when the parking brake is applied automatically while it is in operation. 	<p>➤ Automatic Brake Hold P. 303</p> <p>➤ Parking Brake P. 299</p>



Message	Condition	Explanation
 <p>Auto High-Beam Problem</p>	<ul style="list-style-type: none"> Appears if there is a problem with the Auto high-beam. 	<ul style="list-style-type: none"> Manually operate the headlight switch. If you are driving with the high-beam headlights when this happens, the headlights are changed to low beams.
 <p>Some Driver Assist Systems Cannot Operate: Camera Temperature Too High</p>	<ul style="list-style-type: none"> Appears if the temperature inside the camera is too high and either the auto high beams are in operation or the headlight switch is turned to AUTO. 	<ul style="list-style-type: none"> Use the climate control system to cool down the camera. Goes off - The camera has cooled down. To resume the system, turn the headlight switch to AUTO.  Front Sensor Camera P. 257
 <p>Some Driver Assist Systems Cannot Operate: Clean Front Windshield</p>	<ul style="list-style-type: none"> Appears when the area around the camera is blocked by dirt, mud, etc. Stop your vehicle in a safe place, and wipe it off with a soft cloth. May appear when driving in bad weather (rain, snow, fog, etc.) 	<ul style="list-style-type: none"> Have your vehicle checked by a dealer if the message comes back on after you have cleaned the area around the camera.
 <p>12 Volt Battery Charging System Problem: Power Reduced</p>	<ul style="list-style-type: none"> Appears after the 12-volt battery charging system indicator comes on. 	<ul style="list-style-type: none"> Your vehicle has less ability to accelerate and may be harder to start on an incline. Contact a dealer immediately.
 <p>Acoustic Vehicle Alerting System Problem</p>	<ul style="list-style-type: none"> Appears if there is a problem with the acoustic vehicle alerting system. 	<ul style="list-style-type: none"> Have your vehicle checked by a dealer immediately.



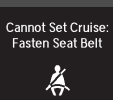

Message	Condition	Explanation
	<ul style="list-style-type: none"> Appears when the high voltage battery temperature is too low to operate (approx. -22°F [-30°C] or below). 	<ul style="list-style-type: none"> You can start the engine and use the climate control system to warm up the interior, which will also warm the high voltage battery enough for you to drive the vehicle. The engine speed does not increase even if you fully depress the accelerator pedal.
	<ul style="list-style-type: none"> Appears when the high voltage battery and other system control temperatures are too low to operate (approx. -40°F [-40°C] or below). 	<ul style="list-style-type: none"> You must wait for an increase in the ambient temperature or move the vehicle to a warmer location. Consult a dealer.
	<ul style="list-style-type: none"> Appears when the high voltage battery is running extremely low due to continuous slow driving. 	<ul style="list-style-type: none"> Driving at low speed for a long time decreases the amount of electricity generated, leading to high voltage battery drain.
	<ul style="list-style-type: none"> Appears when the high voltage battery is drained even further and a stop is needed to charge the battery. 	<ul style="list-style-type: none"> Stop in a safe place in P, then charge the high voltage battery by idling the engine. <ul style="list-style-type: none"> ➤ If the 12-Volt Battery Charging System Indicator Comes On P. 412
	<ul style="list-style-type: none"> Appears while the high voltage battery is being charged with the engine running after the vehicle is parked with an extremely low battery level. 	<ul style="list-style-type: none"> Do not drive the vehicle until Ready To Drive appears. <ul style="list-style-type: none"> ➤ READY Indicator P. 86

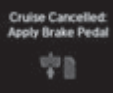

Message	Condition	Explanation
	<ul style="list-style-type: none"> Appears when the rear motor fluid temperature is extremely low. 	<ul style="list-style-type: none"> The vehicle speed is temporarily limited up to 81 mph (130 km/h). This is canceled after the fluid temperature rises.
	<ul style="list-style-type: none"> Appears if the AWD system has a problem due to a hybrid system or power distribution control failure. 	<ul style="list-style-type: none"> Set the power mode to OFF, then set it back to ON. Have your vehicle checked by a dealer if the message appears again.

Message	Condition	Explanation
	<ul style="list-style-type: none"> Flashes when the system senses a likely collision with a vehicle in front of you. 	<ul style="list-style-type: none"> Take the appropriate means to prevent a collision (apply the brakes, change lanes, etc.) <ul style="list-style-type: none"> ➤ Collision Mitigation Braking System™ (CMBS™) P. 307 ➤ Adaptive Cruise Control (ACC) with Low Speed Follow (LSF) P. 259
	<ul style="list-style-type: none"> Appears when ACC with LSF has been automatically canceled. 	<ul style="list-style-type: none"> You can resume the set speed after the condition that caused ACC with LSF to cancel improves. Press the RES/+SET/- switch up. <ul style="list-style-type: none"> ➤ Adaptive Cruise Control (ACC) with Low Speed Follow (LSF) P. 259
	<ul style="list-style-type: none"> Appears when the vehicle speed slows down to 25 mph (40 km/h) and the vehicle ahead of you goes out of the ACC with LSF range while ACC with LSF is in operation. 	<ul style="list-style-type: none"> ACC with LSF has been automatically canceled. <ul style="list-style-type: none"> ➤ Adaptive Cruise Control (ACC) with Low Speed Follow (LSF) P. 259
	<ul style="list-style-type: none"> Appears when pressing the RES/+SET/- switch down while the vehicle speed is less than 25 mph (40 km/h) and the vehicle ahead of you goes out of the ACC with LSF range. 	<ul style="list-style-type: none"> ACC with LSF cannot be set. <ul style="list-style-type: none"> ➤ Adaptive Cruise Control (ACC) with Low Speed Follow (LSF) P. 259
	<ul style="list-style-type: none"> Appears when the distance between your vehicle and the vehicle ahead of you is too close while ACC with LSF is in operation. 	<ul style="list-style-type: none"> ACC with LSF has been automatically canceled. <ul style="list-style-type: none"> ➤ Adaptive Cruise Control (ACC) with Low Speed Follow (LSF) P. 259

Message	Condition	Explanation
	<ul style="list-style-type: none"> Appears when pressing the RES/+SET/- switch down while the distance between your vehicle and the vehicle ahead of you is too close. 	<ul style="list-style-type: none"> ACC with LSF cannot be set. <ul style="list-style-type: none"> ➤ Adaptive Cruise Control (ACC) with Low Speed Follow (LSF) P. 259
	<ul style="list-style-type: none"> Appears when pressing the RES/+SET/- switch down while the driver's seat belt is unfastened. 	<ul style="list-style-type: none"> ACC with LSF cannot be set. <ul style="list-style-type: none"> ➤ Adaptive Cruise Control (ACC) with Low Speed Follow (LSF) P. 259
	<ul style="list-style-type: none"> Appears when pressing the RES/+SET/- switch down while the transmission is not in D. 	<ul style="list-style-type: none"> ACC with LSF cannot be set. <ul style="list-style-type: none"> ➤ Adaptive Cruise Control (ACC) with Low Speed Follow (LSF) P. 259

Message	Condition	Explanation
	<ul style="list-style-type: none"> • Appears when the vehicle is stopped on a very steep slope while ACC with LSF is in operation. 	<ul style="list-style-type: none"> • ACC with LSF has been automatically canceled. <ul style="list-style-type: none"> ➤ Adaptive Cruise Control (ACC) with Low Speed Follow (LSF) P. 259
	<ul style="list-style-type: none"> • Appears when pressing the RES/+SET/- switch down while the vehicle is stopped on a very steep slope. 	<ul style="list-style-type: none"> • ACC with LSF cannot be set. <ul style="list-style-type: none"> ➤ Adaptive Cruise Control (ACC) with Low Speed Follow (LSF) P. 259
	<ul style="list-style-type: none"> • Appears when pressing the RES/+SET/- switch down while the parking brake is applied. 	<ul style="list-style-type: none"> • ACC with LSF cannot be set. <ul style="list-style-type: none"> ➤ Adaptive Cruise Control (ACC) with Low Speed Follow (LSF) P. 259 ➤ Parking Brake P. 299

Message	Condition	Explanation
 <p>Cruise Cancelled: Apply Brake Pedal</p>	<ul style="list-style-type: none"> • Appears if ACC with LSF is canceled while your vehicle is automatically stopped by ACC with LSF. The beeper sounds. 	<ul style="list-style-type: none"> • Immediately depress the brake pedal.
 <p>Cannot Set Cruise: Brake Pedal Is Applied</p>	<ul style="list-style-type: none"> • Appears when pressing the RES/+/SET/- switch down while the vehicle is moving and the brake pedal is depressed. 	<ul style="list-style-type: none"> • ACC with LSF cannot be set. <ul style="list-style-type: none"> ▶ Adaptive Cruise Control (ACC) with Low Speed Follow (LSF) P. 259
 <p>To Start Driving: Brake + Push</p>  <p>To Enter Accessory Mode: Push</p>	<ul style="list-style-type: none"> • Appears when you unlock and open the driver's door while the power system is on by two-way keyless access remote. 	<ul style="list-style-type: none"> ▶ Remote Engine Start with Vehicle Feedback P. 241

Message	Condition	Explanation
	<p>Lane Keeping Assist System (LKAS)</p> <ul style="list-style-type: none"> • Appears when the vehicle is driving out of a detected lane. Rapid vibrations on the steering wheel. <p>Road Departure Mitigation (RDM) System</p> <ul style="list-style-type: none"> • Appears when the vehicle is driving out of a detected lane. <p>When you selected Warning Only</p> <ul style="list-style-type: none"> - Rapid vibrations on the steering wheel when the vehicle is drifting out of a detected lane. <p>When you selected Normal or Wide</p> <ul style="list-style-type: none"> - Rapid vibrations on the steering wheel with steering assist when the vehicle is drifting out of a detected lane. 	<ul style="list-style-type: none"> • Keep the vehicle within the lane you are driving. • The color of either line changes from white to amber as the vehicle gets closer to that side of the lane line. <ul style="list-style-type: none"> ➤ Lane Keeping Assist System (LKAS) P. 279 ➤ Road Departure Mitigation (RDM) System P. 274
	<ul style="list-style-type: none"> • Blinks when you fail to steer the vehicle. The beeper sounds simultaneously if selected by customization. 	<ul style="list-style-type: none"> • Operate the steering wheel to resume the LKAS.
	<ul style="list-style-type: none"> • Appears when the LKAS is in operation, or the LKAS button is pressed, but there is a problem with a system related to the LKAS. The LKAS cancels automatically. The beeper sounds simultaneously if selected by customization. 	<ul style="list-style-type: none"> • If any other system indicators come on, such as the VSA®, ABS and brake system, take appropriate action. <ul style="list-style-type: none"> ➤ Indicators P. 78

Gauges

Gauges include the speedometer, tachometer, fuel gauge, high voltage battery charge level gauge, and related indicators. They are displayed when the power mode is in ON.

■ Speedometer

Displays your driving speed in mph (U.S.) or km/h (Canada).

■ Tachometer

Shows the number of engine revolutions per minute.

■ Fuel Gauge

Displays the amount of fuel left in the fuel tank.

☞ Fuel Gauge

NOTICE

You should refuel when the reading approaches **E**. Running out of fuel can cause the engine to misfire, damaging the catalytic converter.

The actual amount of remaining fuel may differ from the fuel gauge reading.

■ High Voltage Battery Charge Level Gauge

Shows the remaining high voltage battery charge level.

▣ High Voltage Battery Charge Level Gauge

The high voltage battery charge level may decrease under the following conditions:

- When the 12-volt battery has been replaced.
- When the 12-volt battery has been disconnected.
- When the high voltage battery control system corrects its reading.

The charge level reading will be corrected automatically while driving.

Changes in the temperature of the high voltage battery can increase or decrease the battery's charging capacity. If temperature changes cause the battery's capacity to change, the number of indicators in the battery charge level gauge may also change, even if the amount of charging remains the same.

MID

The MID shows the odometer, trip meter, outside temperature indicator, and other gauges. It also displays important messages such as warnings and other helpful information.

Switching the Display

Main displays

Roll the multi-function steering-wheel controls to change the display.

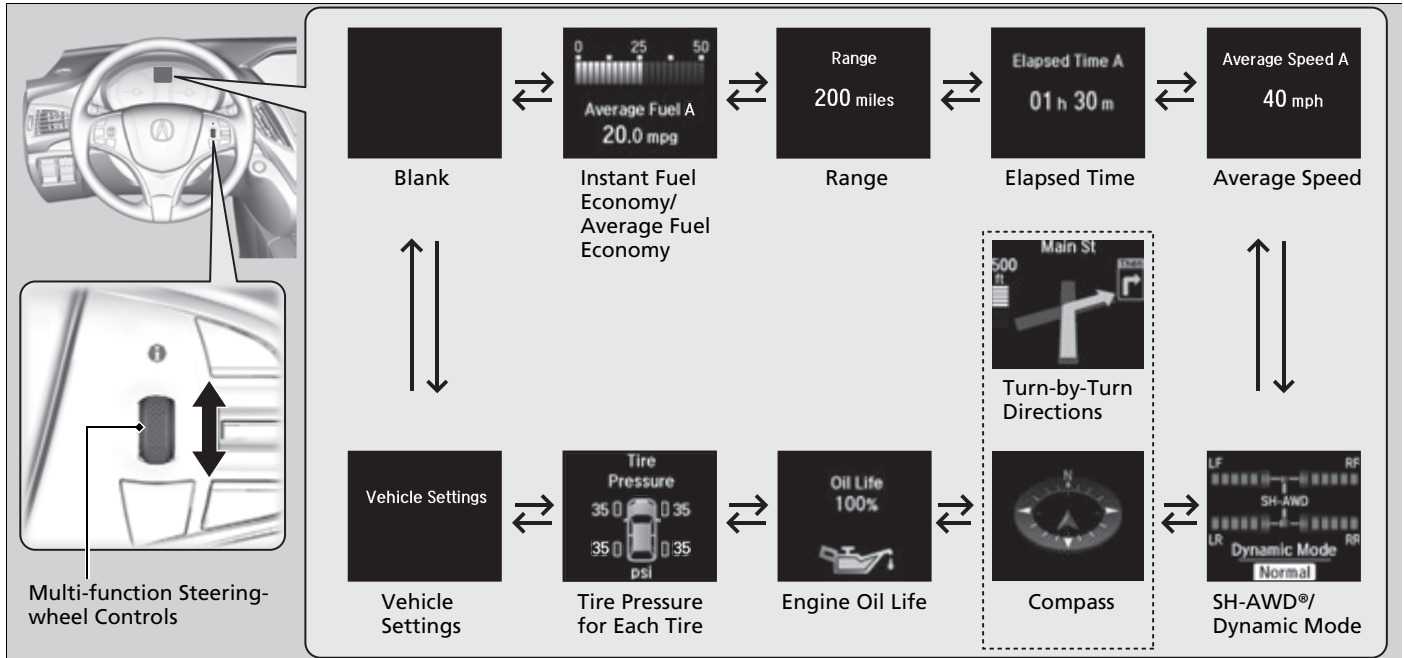

■ Lower displays

Press the **TRIP** button to change the display.

Instrument Panel

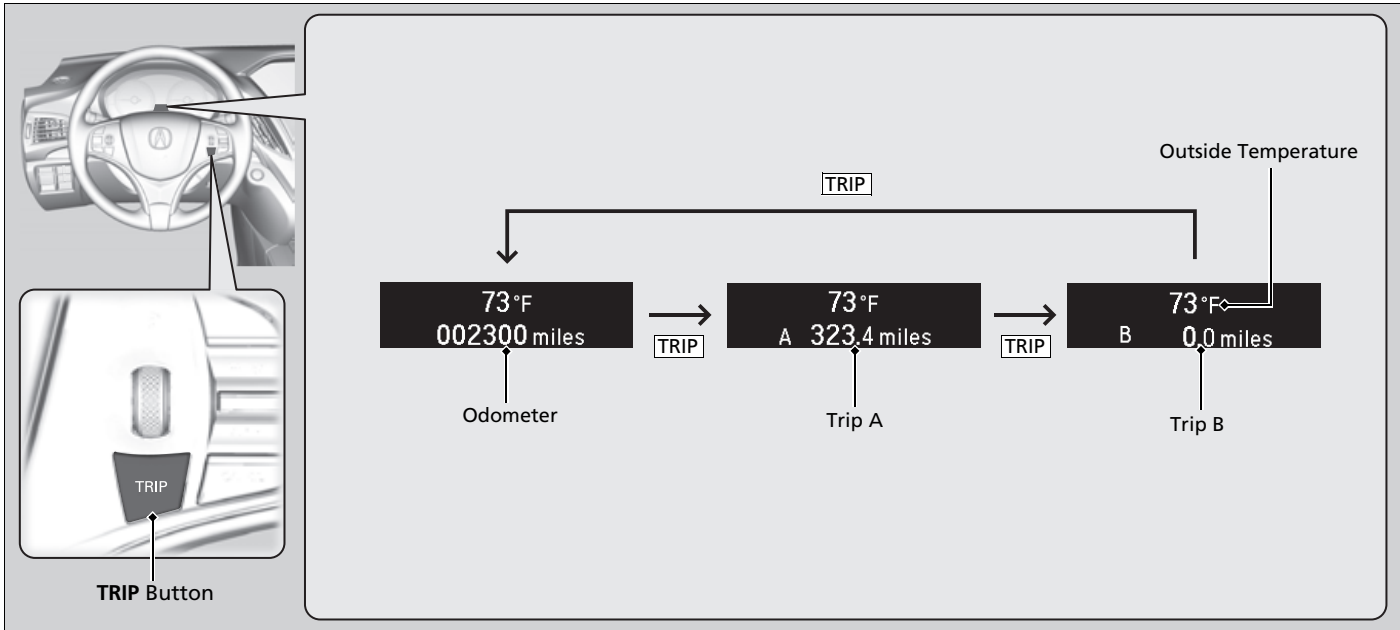

■ Odometer

Shows the total number of miles (U.S.) or kilometers (Canada) that your vehicle has accumulated.

■ Trip Meter

Shows the total number of miles (U.S.) or kilometers (Canada) driven since the last reset. Meters A and B can be used to measure two separate trips.

■ Resetting a trip meter

To reset a trip meter, display it, then press and hold the **TRIP** button until the trip meter is reset to **0.0**.

■ Outside Temperature

Shows the outside temperature in Fahrenheit (U.S.) or Celsius (Canada).

■ Adjusting the outside temperature display

Adjust the temperature reading up to $\pm 5^{\circ}\text{F}$ or $\pm 3^{\circ}\text{C}$ if the temperature reading seems incorrect.

■ Average Fuel Economy

Shows the estimated average fuel economy of each trip meter in mpg (U.S.) or l/100 km (Canada). The display is updated at set intervals. When a trip meter is reset, the average fuel economy is also reset.

⌘ Trip Meter

Switch between trip meter A and trip meter B by pressing the **TRIP** button.

⌘ Outside Temperature

The temperature sensor is located in the front bumper.

Road heat and exhaust from another vehicle can affect the temperature reading when your vehicle speed is less than 19 mph (30 km/h).

It may take several minutes for the display to be updated after the temperature reading has stabilized.

Use the MID's customized features to correct the temperature.

➤ **Customized Features** P. 125

⌘ Average Fuel Economy

You can change when to reset the average fuel economy.

➤ **Customized Features** P. 125

■ Instant Fuel Economy

Shows the instant fuel economy as a bar graph in mpg (U.S.) or l/100 km (Canada).

■ Range

Shows the estimated distance you can travel on the remaining power and fuel. This distance is estimated from the fuel economy of your previous trips.

■ Elapsed Time

Shows the time elapsed since Trip A or Trip B was reset.

■ Average Speed

Shows the average speed in mph (U.S.) or km/h (Canada) since Trip A or Trip B was reset.

⌘ Elapsed Time

You can change when to reset the elapsed time.

➤ **Customized Features** P. 125

⌘ Average Speed

You can change when to reset the average speed.

➤ **Customized Features** P. 125

■ SH-AWD® Torque Distribution Monitor

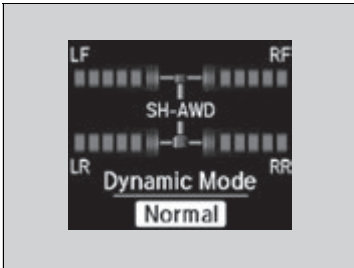

The indicators on the display show the amount of torque being transferred to the right front, left front, right rear, and left rear wheels.

► **SPORT HYBRID Super Handling-All Wheel Drive™ (SPORT HYBRID SH-AWD®)** P. 290

■ Current Mode for Dynamic Mode

Shows the current mode for Dynamic Mode.

► **Integrated Dynamics System** P. 256

■ Turn-by-Turn Directions

Shows you turn-by-turn driving directions to your destination linked with the navigation system.

► **Refer to the navigation system**

►► Turn-by-Turn Directions

The multi-information display shows a compass when the route guidance is not used.

You can select whether the turn-by-turn display comes on or not during the route guidance.

► **Customized Features** P. 125

► **Refer to the navigation system**

■ Engine Oil Life and Maintenance Items

Shows the remaining oil life and Maintenance Minder™.

➤ **Maintenance Minder™** P. 335

■ Tire Pressure Monitor

Shows each tire's pressure.

➤ **Tire Pressure Monitoring System (TPMS) with Tire Fill Assist** P. 294

■ Customized Features

Use the MID to customize certain features.

■ How to customize

Select the **Vehicle Settings** screen by rolling the multi-function steering-wheel controls while the power mode is in ON, and the vehicle is at a complete stop. Push the multi-function steering-wheel controls.

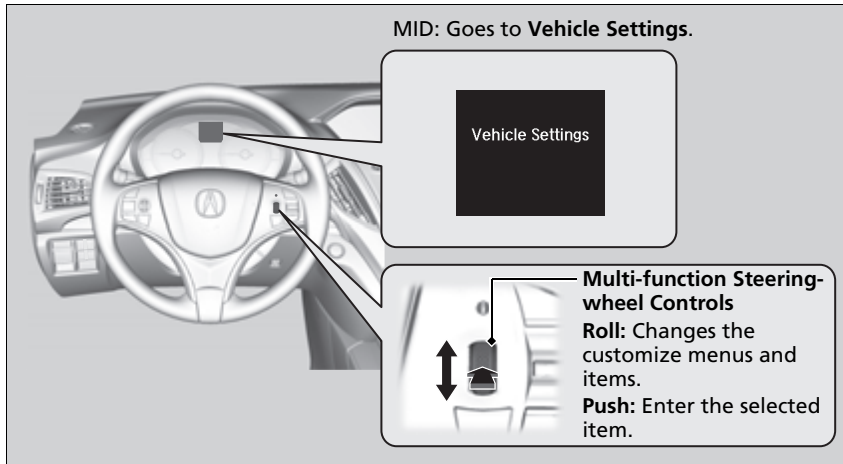

☒ Customized Features

To customize other features, roll the multi-function steering-wheel controls.

☒ **List of customizable options** P. 128

☒ **Example of customization settings** P. 133

Customization is possible when you see the driver's ID (**Driver 1** or **Driver 2**) on the screen.

The driver's ID indicates which remote transmitter you have used to unlock the driver's door. The customized settings are recalled every time you unlock the driver's door with that remote.

Change to **P** before you attempt to change any customized setting.

Customizing is also available from the audio/information screen.

You cannot have **Vehicle Settings** displayed on the multi-information display while the audio/information screen shows the same menu.

☒ **Customized Features** P. 125

■ **Customization flow**

Roll the multi-function steering-wheel controls to select **Vehicle Settings** and push the multi-function steering-wheel controls.

Instrument Panel

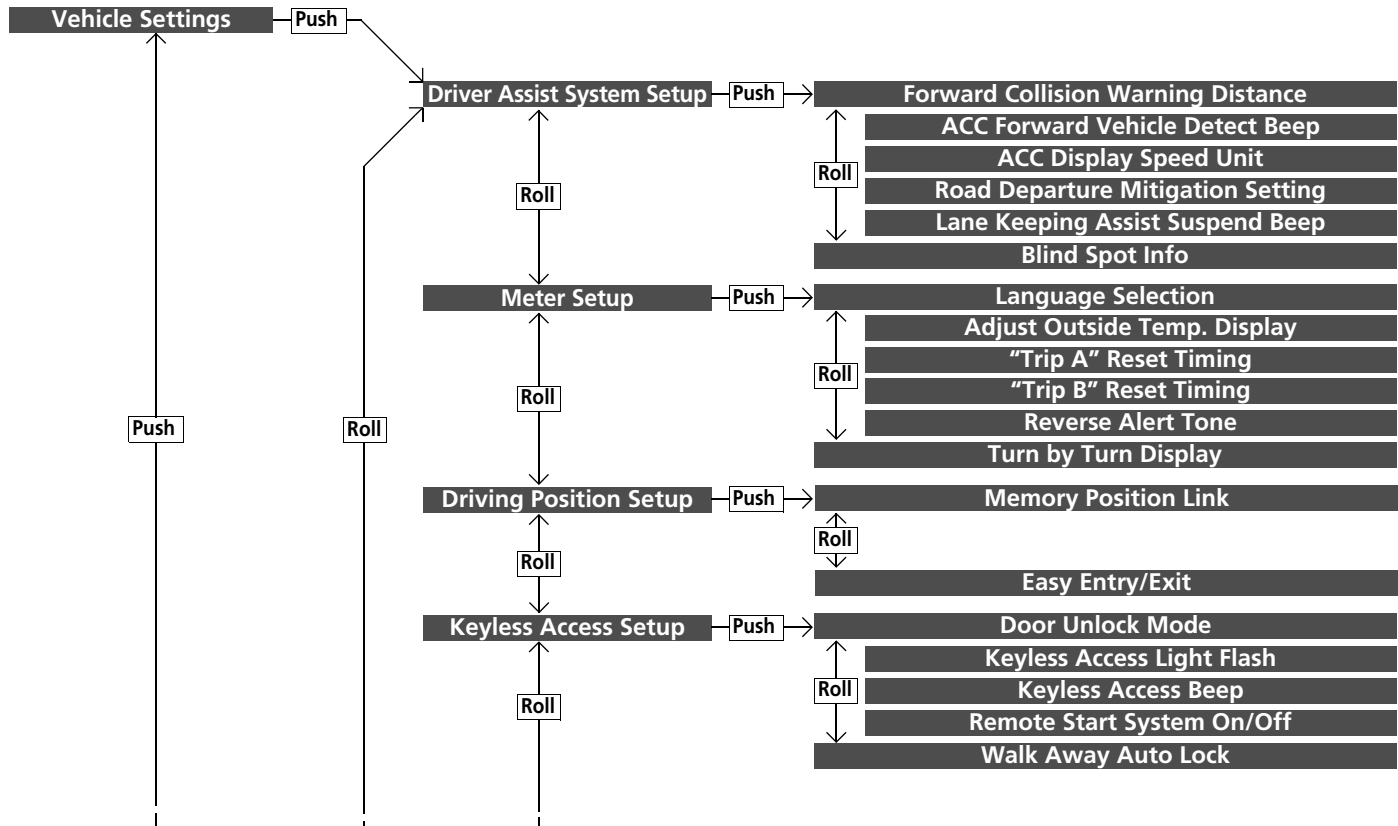

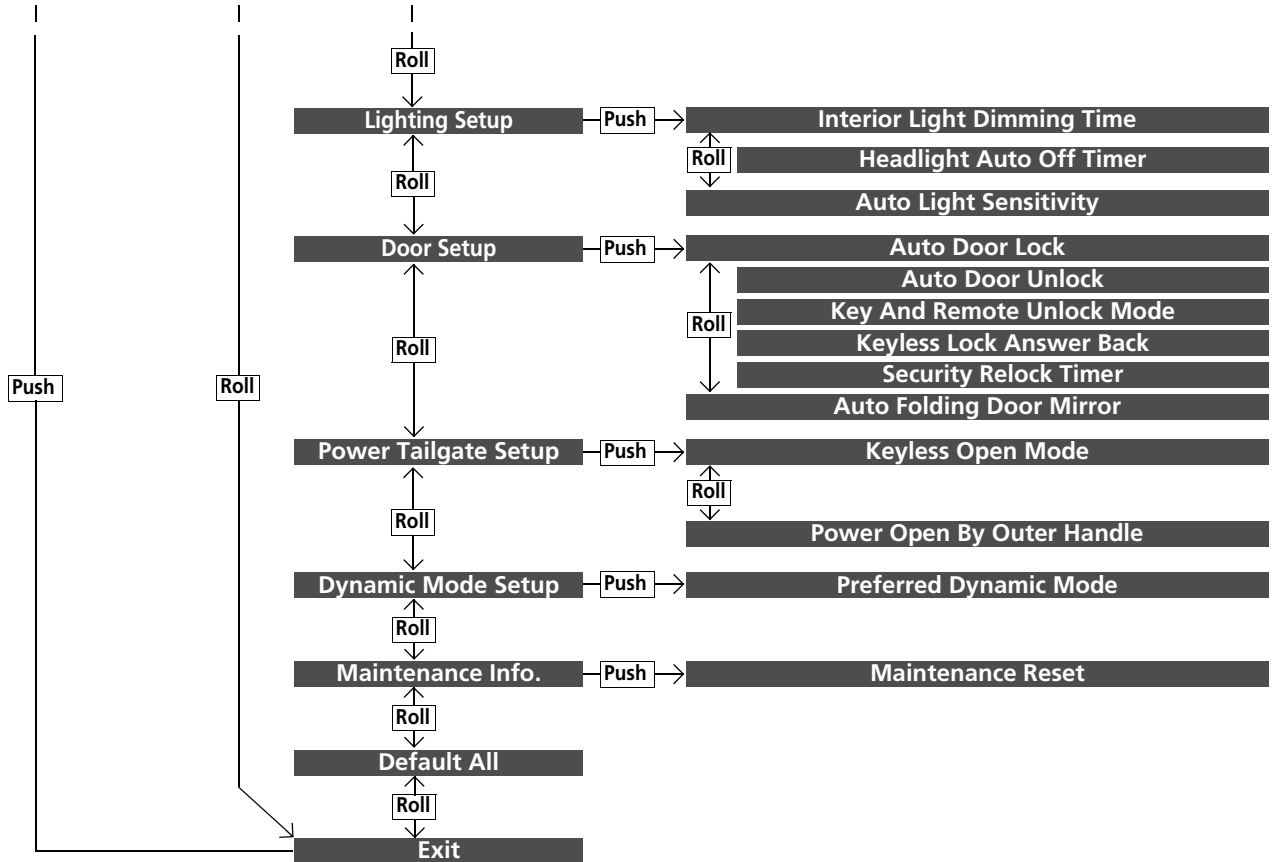

Instrument Panel

■ List of customizable options

Setup Group	Customizable Features	Description	Selectable Settings
Driver Assist System Setup	Forward Collision Warning Distance	Changes at which distance forward collision warning alerts.	Long/Normal^{*1}/Short
	ACC Forward Vehicle Detect Beep	Causes the system to beep when the system detects a vehicle, or when the vehicle goes out of the ACC with LSF range.	On/Off^{*1}
	ACC Display Speed Unit	Changes the speed unit for ACC with LSF on the MID.	mph^{*1}/km/h (U.S.) mph/km/h^{*1} (Canada)
	Road Departure Mitigation Setting	Changes the setting for the road departure mitigation system.	Normal^{*1}/Wide/Warning Only
	Lane Keeping Assist Suspend Beep	Causes the system to beep when the LKAS is suspended.	On/Off^{*1}
	Blind Spot Info	Changes the setting for the blind spot information.	Audible And Visual Alert^{*1}/ Visual Alert/Off

*1:Default Setting

Setup Group	Customizable Features	Description	Selectable Settings
Meter Setup	Language Selection	Changes the displayed language.	English^{*1}/Français/Español
	Adjust Outside Temp. Display	Adjusts the temperature reading by a few degrees.	-5°F ~ ±0°F^{*1} ~ +5°F (U.S.) -3°C ~ ±0°C^{*1} ~ +3°C (Canada)
	“Trip A” Reset Timing	Changes the setting of how to reset trip meter A, average fuel economy A, average speed A, and elapsed time A.	When Refueled/IGN Off/Manually Reset^{*1}
	“Trip B” Reset Timing	Changes the setting of how to reset trip meter B, average fuel economy B, average speed B, and elapsed time B.	When Refueled/IGN Off/Manually Reset^{*1}
	Reverse Alert Tone	Causes the beeper to sound once when the change the gear position to R .	On^{*1}/Off
	Turn by Turn Display	Select whether the turn-by-turn display comes on during the route guidance.	On^{*1}/Off

*1:Default Setting

Setup Group	Customizable Features	Description	Selectable Settings
Driving Position Setup	Memory Position Link	Turns the driving position memory system on and off.	On^{*1}/Off
	Easy Entry/Exit	Moves the seat rearward and steering wheel fully up when you get in/get out of the vehicle. Changes the setting for this feature.	Seat & Steering Wheel^{*1}/ Seat Only/Steering Wheel Only/Off
	Door Unlock Mode	Changes which doors unlock when you grab the driver's door handle.	Driver's Door or Tailgate Only^{*1}/All Doors
Keyless Access Setup	Keyless Access Light Flash	Causes some exterior lights to flash when you unlock/lock the doors.	On^{*1}/Off
	Keyless Access Beep	Causes the beeper to sound when you unlock/lock the doors.	On^{*1}/Off
	Remote Start System On/Off	Turns the remote engine start feature on and off.	On^{*1}/Off
	Walk Away Auto Lock	Changes the settings for the automatic locking the doors when you walk away from the vehicle while carrying the keyless access remote.	On/Off^{*1}

*1: Default Setting

Setup Group	Customizable Features	Description	Selectable Settings
Lighting Setup	Interior Light Dimming Time	Changes the length of time the interior lights stay on after you close the doors.	60sec/30sec^{*1}/15sec
	Headlight Auto Off Timer	Changes the length of time the exterior lights stay on after you close the driver's door.	60sec/30sec/15sec^{*1}/0sec
	Auto Light Sensitivity	Changes the timing for the headlights to come on.	Max/High/Mid^{*1}/Low/Min
Door Setup	Auto Door Lock	Changes the setting for when the doors automatically lock.	With Vehicle Speed^{*1}/Shift From P/Off
	Auto Door Unlock	Changes the setting for when the doors automatically unlock.	All Doors When Driver's Door Opens^{*1}/All Doors When Shifted To Park/All Doors When Ignition Switched Off/Off
	Key And Remote Unlock Mode	Sets up either the driver's door or all doors to unlock on the first operation of the remote or built-in key.	Driver Door^{*1}/All Doors
	Keyless Lock Answer Back	LOCK/UNLOCK- The exterior lights flash. LOCK (2nd push)- The beeper sounds.	On^{*1}/Off
	Security Relock Timer	Changes the time it takes for the doors to relock and the security system to set after you unlock the vehicle without opening any door.	90sec/60sec/30sec^{*1}
	Auto Folding Door Mirror	Changes how you can fold the door mirrors.	Auto Fold With Keyless^{*1}/Manual Only

*1: Default Setting

Setup Group	Customizable Features	Description	Selectable Settings
Power Tailgate Setup	Keyless Open Mode	Changes the keyless setting for when the power tailgate opens.	Anytime*¹/When Unlocked
	Power Open By Outer Handle	Changes the setting to open power tailgate by tailgate outer handle.	Off (Manual Only)/On (Power/Manual)*¹
Dynamic Mode Setup	Preferred Dynamic Mode	Changes the Dynamic Mode setting for when you set the power mode to ON.	Last Used*¹/Comfort/Normal/Sport
Maintenance Info.	Maintenance Reset	Resets/Cancel the engine oil life display when you have performed the maintenance service.	Cancel/Reset
Default All	—	Cancels/Resets all the customized settings as default.	Cancel/Set

*1: Default Setting

■ Example of customization settings

The steps for changing the **“Trip A” Reset Timing** setting to **When Refueled** are shown below. The default setting for **“Trip A” Reset Timing** is **Manually Reset**.

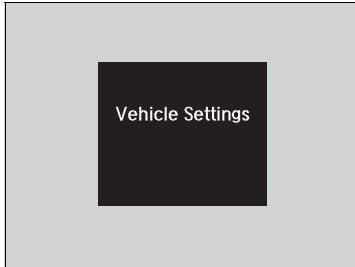

1. Roll the multi-function steering-wheel controls to select **Vehicle Settings**, then push the multi-function steering-wheel controls.



2. Roll the multi-function steering-wheel controls until **Meter Setup** appears on the display.

3. Push the multi-function steering-wheel controls.

▶ **Language Selection** appears first on the display.

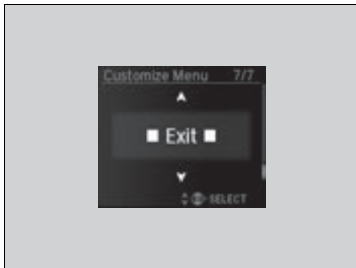

4. Roll the multi-function steering-wheel controls until **"Trip A" Reset Timing** appears on the display, then push the multi-function steering-wheel controls.
 - The display switches to the customization setup screen, where you can select **When Refueled**, **IGN Off**, **Manually Reset**, or **Exit**.
5. Roll the multi-function steering-wheel controls and select **When Refueled**, then push the multi-function steering-wheel controls.
 - The **When Refueled Setup** screen appears, then the display returns to the customization menu screen.
6. Roll the multi-function steering-wheel controls until **Exit** appears on the display, then push the multi-function steering-wheel controls.
7. Repeat Step 6 until you return to the normal screen.

Controls

This chapter explains how to operate the various controls necessary for driving.



Clock	136
Locking and Unlocking the Doors	
Key Types and Functions	137
Low Keyless Access Remote Signal Strength.....	138
Locking/Unlocking the Doors from the Outside	139
Locking/Unlocking the Doors from the Inside	147
Childproof Door Locks	149
Auto Door Locking/Unlocking	150
Opening and Closing the Tailgate ...	151
Security System	
Immobilizer System	158
Security System Alarm	158

Opening and Closing the Windows ...	161
Opening and Closing the Moonroof ..	163
Operating the Switches Around the Steering Wheel	
POWER Button.....	164
Turn Signals	167
Light Switches.....	168
Fog Lights*	171
Daytime Running Lights	171
Auto High-Beam	172
Wipers and Washers	175
Brightness Control	179
Rear Defogger/Heated Door Mirror Button..	180
Driving Position Memory System	181
Adjusting the Steering Wheel.....	183

Adjusting the Mirrors	
Interior Rearview Mirror	184
Power Door Mirrors	185
Adjusting the Seats	
Front Seats	187
Second Row Seats	189
Third Row Seats	198
Armrest	199
Interior Lights/Interior Convenience Items	
Interior Lights	201
Interior Convenience Items	203
Climate Control System	
Using Automatic Climate Control	214
Rear Climate Control System	222
Automatic Climate Control Sensors...	226

* Not available on all models

Adjusting the Clock

The clock is automatically updated through the navigation system, so the time does not need to be adjusted.

You can adjust the time manually in the audio/information screen, with the power mode in ON.

Adjusting the Time

Using the Settings menu on the audio/information screen

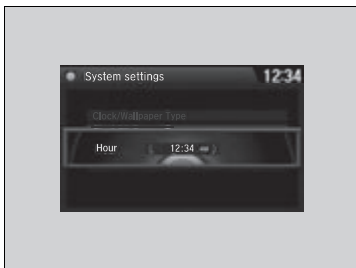

1. Press the **SETTINGS** button.
2. Rotate to select **System Settings**, then press .
 - ▶ Repeat the procedure to select **Clock Adjustment**.
3. Rotate to change hour, then press .
4. Rotate to change minute, then press .

⌂ Clock

These indications are used to show how to operate the interface dial.

Rotate to select.

Press to enter.

You can customize the clock display to show the 12 hour clock or 24 hour clock.

Refer to the Navigation System Manual

You can turn the clock display in the audio/information screen on and off.

Refer to the Navigation System Manual

Key Types and Functions

This vehicle comes with the following keys:



Use the keys to turn on and off the power system, and to lock and unlock all the doors and tailgate. You can also use the keyless access system to lock and unlock all the doors and tailgate.

Keyless Access Remote

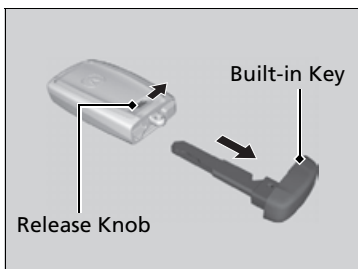

The built-in key can be used to lock/unlock the doors when the keyless access remote battery becomes weak and the power door lock/unlock operation is disabled.

To remove the built-in key, slide the release knob and then pull out the key. To reinstall the built-in key, push the built-in key into the keyless access remote until it clicks.

Key Types and Functions

All the keys have an immobilizer system. The immobilizer system helps to protect against vehicle theft.

➤ **Immobilizer System** P. 158

The keys contain precision electronics. Adhere to the following advice to prevent damage to the electronics:

- Do not leave the keys in direct sunlight, or in locations with high temperature or high humidity.
- Do not drop the keys or set heavy objects on them.
- Keep the keys away from liquids.
- Do not take the keys apart except for replacing the battery.

If the circuits in the keys are damaged, the power system may not activate, and the keyless access system may not work.

If the keys do not work properly, have them inspected by a dealer.

You can remotely turn the power system on using the two-way keyless access remote.

➤ **Remote Engine Start with Vehicle Feedback** P. 241

■ Key Number Tag

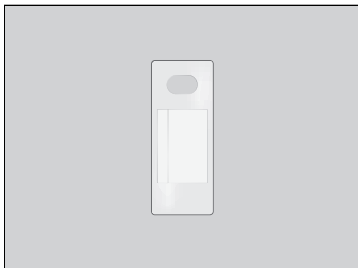

Contains a number that you will need if you purchase a replacement key.

Low Keyless Access Remote Signal Strength

The vehicle transmits radio waves to locate the keyless access remote when locking/unlocking the doors and tailgate, or to activate the power system.

In the following cases, locking/unlocking the doors and tailgate, or activating the power system may be inhibited or operation may be unstable:

- Strong radio waves are being transmitted by nearby equipment.
- You are carrying the keyless access remote together with telecommunications equipment, laptop computers, cell phones, or wireless devices.
- A metallic object is touching or covering the keyless access remote.

☒ Key Number Tag

Keep the key number tag separate from the key in a safe place outside of your vehicle. If you wish to purchase an additional key, contact a dealer.

If you lose your key and you cannot activate the power system, contact a dealer.

☒ Low Keyless Access Remote Signal Strength

Communication between the keyless access remote and the vehicle consumes the keyless access remote's battery.

Battery life is about two years, but this varies depending on regularity of use.

The battery is consumed whenever the keyless access remote is receiving strong radio waves. Avoid placing it near electrical appliances such as televisions and personal computers.

Locking/Unlocking the Doors from the Outside

■ Using the Keyless Access System

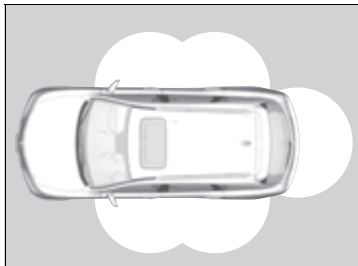

When you carry the keyless access remote, you can lock/unlock the doors and the tailgate.

You can lock/unlock the doors and tailgate within a radius of about 32 inches (80 cm) of the outside door handle or tailgate outer handle.

☒ Locking/Unlocking the Doors from the Outside

If the interior light switch is in the door activated position, the interior light comes on when you unlock the doors and tailgate.

No doors opened: The light fades out after 30 seconds.

Doors and tailgate relocked: The light goes off immediately.

➤ **Interior Lights** P. 201

☒ Using the Keyless Access System

If you do not open a door or the tailgate within 30 seconds of unlocking the vehicle with the keyless access system, the doors and tailgate will automatically relock.

You can lock or unlock doors using the keyless access system only when the power mode is in VEHICLE OFF.

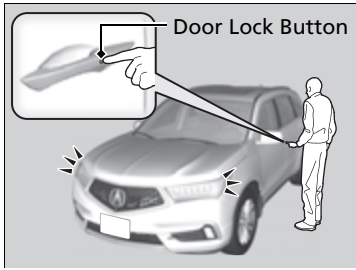

■ Locking the doors and tailgate

Press the door lock button on the front or rear doors, or on the tailgate.

- ▶ Some exterior lights flash; the beeper sounds; all the doors and tailgate lock; and the security system sets.

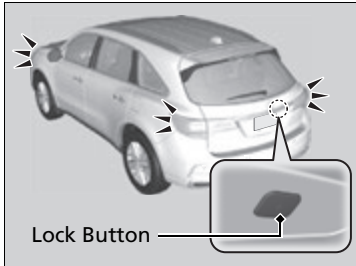

▣ Using the Keyless Access System

- Do not leave the keyless access remote in the vehicle when you get out. Carry it with you.
- Even if you are not carrying the keyless access remote, you can lock/unlock the doors and tailgate while someone else with the remote is within range.
- The door may be unlocked if the door handle is covered with water in heavy rain or in a car wash if the keyless access remote is within range.
- If you grip a door handle wearing gloves, the door sensor may be slow to respond or may not respond by unlocking the doors.
- After locking the door, you have up to two seconds during which you can pull the door handle to confirm whether the door is locked. If you need to unlock the door immediately after locking it, wait at least two seconds before gripping the handle, otherwise the door will not unlock.
- The door might not open if you pull it immediately after gripping the door handle. Grip the handle again and confirm that the door is unlocked before pulling the handle.
- Even within the 32 inches (80 cm) radius, you may not be able to lock/unlock the doors with the keyless access remote if it is above or below the outside handle.
- The keyless access remote may not operate if it is too close to the door and door glass.

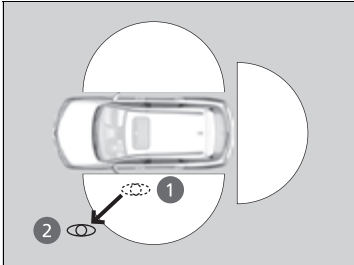
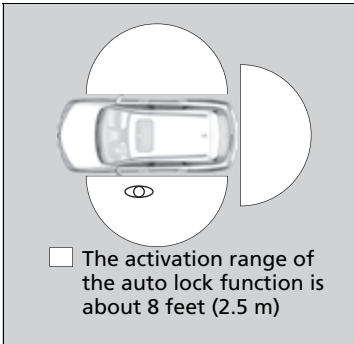

■ Locking the doors and tailgate (Walk away auto lock)

When you walk away from the vehicle while carrying the keyless access remote, the doors will automatically lock.

The auto lock function activates when all doors and tailgate are closed, and the keyless access remote is within about 8 feet (2.5 m) radius of the outside door handle.

Exit vehicle while carrying keyless access remote and close door(s).

1. While within about 8 feet (2.5 m) radius of the vehicle.
 - ▶ The beeper sounds; the auto lock function will be activated.
2. Carry the keyless access remote beyond about 5 feet (1.5 m) from the vehicle and remain outside this range for 2 or more seconds.
 - ▶ Some exterior lights flash; the beeper sounds; all doors and tailgate will then lock.

☒ Locking the doors and tailgate (Walk away auto lock)

The auto lock function is set to OFF as the factory default setting. The auto lock function can be set to ON using the audio/information screen or MID. Turning ON auto lock function using the audio/information screen or MID, shall only activate the function in remote transmitter that was used to unlock the driver's door.

▶ **Customized Features** P. 125

▶ **Refer to the Navigation System Manual**

After the auto lock function has been activated, when you stay within the locking/unlocking operation range, the indicator on the keyless access remote will continue to flash until the doors are locked.

When you stay beside the vehicle within the operation range, the doors will automatically lock approximately 30 seconds after the auto lock function activating beeper sounds.

When you open a door after the auto lock function activating beeper sounds, the auto lock function will be delayed until all doors and tailgate are closed.

When all doors and tailgate have been closed and the keyless access remote is inside the vehicle, or if the keyless access remote is not detected within about 8 feet (2.5 m) of the vehicle, auto lock function will not be activated.

To temporarily deactivate the function:

1. Set the power mode to OFF.
2. Open the driver's door.
3. Using the master door lock switch, operate the lock as follows:
Lock → Unlock → Lock → Unlock.
▶ The beeper sounds and the function is deactivated.

To restore the function:

- Set the power mode to ON.
- Lock the vehicle without using the auto lock function.
- Walk away at least more than about 8 feet (2.5 m) away from the vehicle while carrying the keyless access remote.
- Open any door.

🔒 Locking the doors and tailgate (Walk away auto lock)

You must wait until the power tailgate fully closes before the auto lock function will be activated.

The auto lock function does not operate when any of the following conditions are met.

- The keyless access remote is inside the vehicle.
- A door or the hood is not closed.
- The power mode is set to any mode other than OFF.
- The keyless access remote is not located within a radius of about 8 feet (2.5 m) from the vehicle when you get out of the vehicle and close the doors.

Auto lock function operation stop beeper

After the auto lock function has been activated, the auto lock operation stop beeper sounds for approximately two seconds in the following cases.

- The keyless access remote is put inside the vehicle through a window.
 - You are located too close to the vehicle.
 - The keyless access remote is put inside the tailgate.
- If the warning beeper sounds, check that you are carrying the keyless access remote. Then, open/close a door and confirm the auto lock activation beeper sounds once.

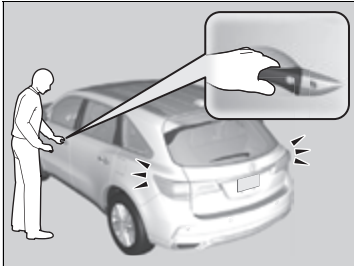

■ Unlocking the doors and tailgate

Grab the driver's door handle:

- ▶ The driver's door unlocks.
- ▶ Some exterior lights flash twice and the beeper sounds twice.

Grab the front passenger's door or rear door handle:

- ▶ All doors and the tailgate unlock.
- ▶ Some exterior lights flash twice and the beeper sounds twice.

Press and hold the tailgate outer handle:

- ▶ The tailgate unlocks and opens.
- ▶ Some exterior lights flash twice and the beeper sounds twice.

➤ **Using the Tailgate Outer Handle** P. 152

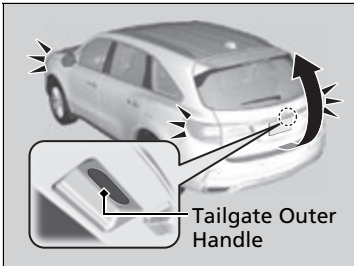

⊞ Using the Keyless Access System

The light flash, beep and door unlock mode settings can be customized using the audio/information screen or multi-information display (MID).

➤ **Customized Features** P. 125

➤ **Refer to the Navigation System Manual**

When you go into the keyless access system working range with all the doors locked, the LED puddle lights come on for 30 seconds.

The lights do not come on if you have previously stayed within the range for more than two minutes, or the doors have been locked for a few days.

The feature activates again after you drive the vehicle, then lock the doors.

You can also unlock and open with the power tailgate.

➤ **Using the Tailgate Outer Handle** P. 152

■ Using the Remote Transmitter

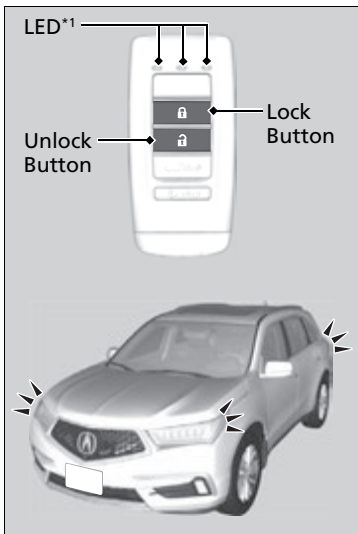

■ Locking the doors and tailgate

Press the lock button.

Once:

- ▶ Some exterior lights flash, all the doors and tailgate lock, and the security system sets.

Twice (within five seconds after the first push):

- ▶ The beeper sounds and verifies the security system is set.

■ Unlocking the doors and tailgate

Press the unlock button.

Once:

- ▶ Some exterior lights flash twice, and the driver's door unlocks.

Twice:

- ▶ The remaining doors and tailgate unlock.

*1: Checking Door Lock Status P. 146

▣ Using the Remote Transmitter

If you do not open a door or the tailgate within 30 seconds of unlocking the vehicle with the remote transmitter, the doors and tailgate will automatically relock.

You can change the relock timer setting.

- ▣ Customized Features P. 125
- ▣ Refer to the Navigation System Manual

You can lock or unlock doors using the remote transmitter only when the power mode is in VEHICLE OFF.

The remote transmitter uses low-power signals, so the operating range may vary depending on the surroundings.

The remote will not lock the vehicle when a door or the tailgate is open.

If the distance at which the remote transmitter works varies, the battery is probably low.

If the LED does not come on when you press a button, the battery is dead.

- ▣ Replacing the Button Battery P. 371

You can customize the door unlock mode setting.

- ▣ Customized Features P. 125
- ▣ Refer to the Navigation System Manual

■ Locking/Unlocking the Doors Using a Key

If the keyless access remote battery or the vehicle 12-volt battery is dead, use the key instead of the keyless access remote.

➤ **Replacing the Button Battery** P. 371

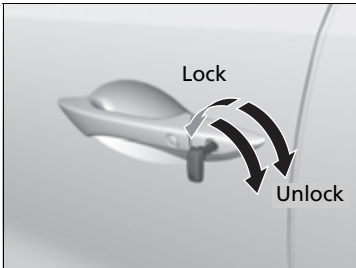

Fully insert the key and turn it.

■ Locking a Door Without Using a Key

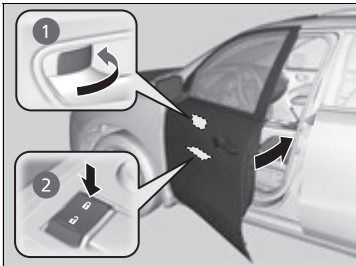

■ Locking the front doors

Push the lock tab forward ① or push the master door lock switch in the lock direction ②, and close the door.

■ Locking the rear doors

Push the lock tab forward and close the door.

■ Lockout prevention system

The doors and tailgate cannot be locked when the keyless access remote is inside the vehicle.

⊗ Locking/Unlocking the Doors Using a Key

When you lock the driver's door with a key, all the other doors and tailgate lock at the same time. When unlocking, the driver's door unlocks first. Turn the key a second time within a few seconds to unlock the remaining doors and the tailgate.

You can customize the door unlock mode setting.

➤ **Customized Features** P. 125

➤ **Refer to the Navigation System Manual**

⊗ Locking a Door Without Using a Key

When you lock the driver's door, all the other doors and tailgate lock at the same time.

Make sure you have the key in your hand when you lock the driver's door, any of the other doors or the tailgate, otherwise you may end up locking the key inside the vehicle.

■ Checking Door Lock Status

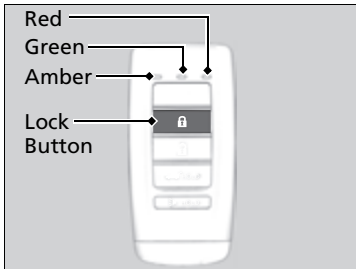

You can remotely check if your vehicle's doors are all locked or any are unlocked using the keyless access remote from extended distances.

Press the lock button, the Amber (LEFT) LED blinks once. Then after three seconds one of the following feedback will come:

- Green (center) comes on: Acknowledges that the doors are locked.
- Red (right) comes on: Acknowledges that doors are not locked, or any door is not completely closed.
- Red (right) blinks three times: The remote does not receive the door lock status from the vehicle.

▣ Checking Door Lock Status

Operate the remote in an open space. If there are buildings or other obstacles between your vehicle and the remote, the remote may not work even within the operable range. However, the range required for unlocking the tailgate and all the doors as well as activating the panic function is the same as that required for operating the standard keyless access remote.

▣ **Using the Remote Transmitter** P. 144

When checking the door lock status, you can also turn the power system on or off.

▣ **Remote Engine Start with Vehicle Feedback** P. 241

Locking/Unlocking the Doors from the Inside

■ Using the Lock Tab

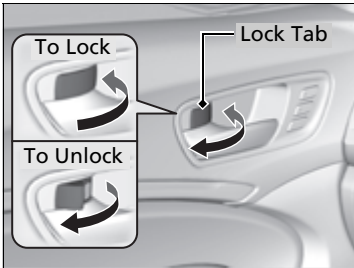

■ Locking a door

Push the lock tab forward.

■ Unlocking a door

Pull the lock tab rearward.

☒ Using the Lock Tab

When you lock the door using the lock tab on the driver's door, all of the other doors and the tailgate lock at the same time.

When you unlock the door using the lock tab on the driver's door, only the driver's door will unlock.

■ Unlocking Using the Front Door Inner Handle

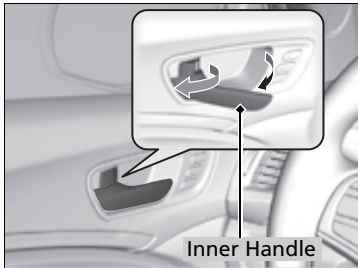

Pull the front door inner handle.

- ▶ The door unlocks and opens in one motion.

Unlocking and opening the driver's door from the inner handle unlocks all the other doors.

To avoid all the doors to be unlocked, use the lock tab on the driver's door to unlock, then lock again before opening the door.

- ▶ This setting works for one time only. If you do not want all the doors to be unlocked all the time, customize the **Auto Door Unlock** setting to **Off** using the MID or audio/information screen.

☒ Unlocking Using the Front Door Inner Handle

The front door inner handles are designed to allow front seat occupants to open the door in one motion. However, this feature requires that front seat occupants never pull a front door inner handle while the vehicle is in motion.

Children should always ride in a rear seat where childproof door locks are provided.

☒ **Childproof Door Locks** P. 149

■ Using the Master Door Lock Switch

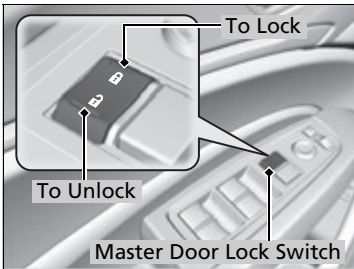

Press the master door lock switch in as shown to lock or unlock all the doors and the tailgate.

☒ Using the Master Door Lock Switch

When you lock/unlock either front door using the master door lock switch, all the other doors and the tailgate lock/unlock at the same time.

Childproof Door Locks

The childproof door locks prevent the rear doors from being opened from the inside regardless of the position of the lock tab.

☒ Childproof Door Locks

To open the door from the inside when the childproof door lock is on, put the lock tab in the unlock position, lower the rear window, put your hand out of the window, and pull the outside door handle.

■ Setting the Childproof Door Locks

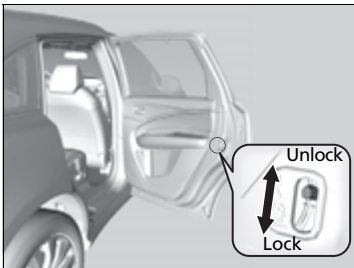

Slide the lever in the rear door to the lock position, and close the door.

■ When opening the door

Open the door using the outside door handle.

Auto Door Locking/Unlocking

Your vehicle locks or unlocks all doors automatically when a certain condition is met.

■ Auto Door Locking

■ Drive lock mode

All doors and tailgate lock when the vehicle's speed reaches about 10 mph (15 km/h).

■ Auto Door Unlocking

■ Driver's door open mode

All doors unlock when the driver's door is opened.

☒ Auto Door Locking/Unlocking

You can turn off or change to another auto door locking/unlocking setting using the audio/information screen or MID.

☒ **Customized Features** P. 125

☒ **Refer to the Navigation System Manual**

Precautions for Opening/Closing the Tailgate

Always make sure individuals and objects are clear of the tailgate before opening or closing it.

- Open the tailgate all the way.
 - ▶ If it is not fully opened, the tailgate may begin to close under its own weight.
- Be careful when it is windy. The wind may cause the tailgate to close.

Keep the tailgate closed while driving to:

- ▶ Avoid possible damage.
- ▶ Prevent exhaust gas from leaking into the vehicle.
- ▶ **Carbon Monoxide Gas** P. 75

⚠ Precautions for Opening/Closing the Tailgate

⚠ WARNING

Anyone caught in the path of a tailgate that is being opened or closed can be seriously injured.

Make sure that all people are clear of the tailgate before opening or closing it.

Be careful not to hit your head on the tailgate or to put your hands between the tailgate and the cargo area when closing the tailgate.

When you are storing or picking up luggage from the cargo area while the engine is idling, do not stand in front of the exhaust pipe. You may get burned.

Do not allow any passenger in the cargo space. They may get hurt during hard braking, a sudden acceleration, or a crash.

Using the Tailgate Outer Handle

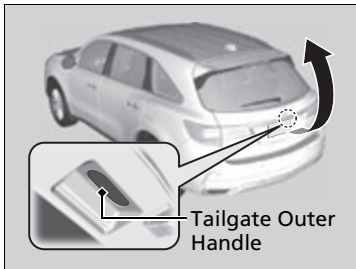

When all the doors are unlocked, the tailgate is unlocked.

Press the tailgate outer handle for more than one second, and lift open the tailgate.

If you are carrying the keyless access remote, you do not have to unlock the tailgate before opening it.

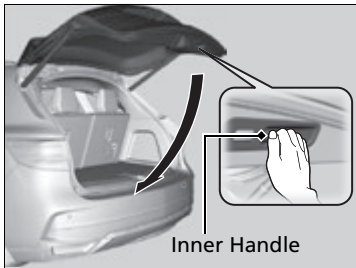

To close the tailgate, grab the inner handle, pull the tailgate down, and push it closed from outside.

⌘ Using the Tailgate Outer Handle

- Do not leave the keyless access remote in the vehicle when you get out. Carry it with you.
- Even if you are not carrying the keyless access remote, you can lock/unlock the tailgate while someone else with the remote is within range.
- Do not leave the keyless access remote inside the cargo area and close the tailgate. The beeper sounds repeatedly. You can open the tailgate and retrieve the key.

Opening/Closing the Power Tailgate

The power tailgate can be operated by pressing the power tailgate button on the remote transmitter or driver's door, or pressing the outer handle or button on the tailgate.

■ The power tailgate can be opened when:

- The tailgate is fully closed.
- The transmission is in **P**.
- Press and hold the tailgate button on the remote transmitter for about one second when the power mode is in VEHICLE OFF (LOCK).
 - ▶ If you have changed the **Keyless Open Mode** setting to **When Unlocked**, you need to unlock the tailgate before you press the tailgate button to open it.
 - **Customized Features** P. 125
 - **Refer to the Navigation System Manual**

■ The power tailgate can be closed when:

- The tailgate is fully open.
- Press and hold the tailgate button on the remote transmitter for about one second when the power mode is in VEHICLE OFF (LOCK).

ⓘ Opening/Closing the Power Tailgate

NOTICE

Do not push or pull on the power tailgate when it is being automatically opened or closed.

Forcibly opening or closing the power tailgate while in operation can deform the tailgate frame.

When operating the power tailgate, make sure there is enough space around your vehicle. People near the tailgate may be seriously hurt if the tailgate hits or closes on their heads. Be especially cautious if children are around.

The power tailgate may not open or close under the following conditions:

- You start the power system while the tailgate is automatically opening or closing.
- The vehicle is parked on a steep hill.
- The vehicle is swayed in a strong wind.
- The tailgate or the roof is covered with snow or ice.

If you close the power tailgate when all the doors are locked, the power tailgate locks automatically.

If you replace the 12-volt battery or the power tailgate fuse while the tailgate is open, the power tailgate may be disabled. The power tailgate resumes once you manually close the tailgate.

Remote Transmitter

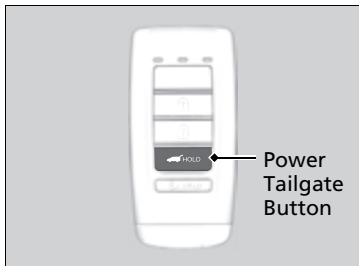

Press the power tailgate button for more than one second to operate when the power mode is in VEHICLE OFF (LOCK).

To reverse direction while the power tailgate is in operation, press the button again. The beeper sounds three times and the tailgate reverses direction.

Customizing when to open the tailgate

Anytime: The power tailgate unlocks and opens at the same time. This is the default setting.

When Unlocked: The tailgate opens when all doors are unlocked.

➤ **Customized Features** P. 125

➤ **Refer to the Navigation System Manual**

Opening/Closing the Power Tailgate

Installing aftermarket components other than Acura genuine accessories on the power tailgate may prevent it from fully opening or closing.

Make sure the power tailgate is fully open before you get your luggage in and out.

Make sure the power tailgate is fully closed before you start the vehicle.

If the power tailgate meets resistance while opening or closing, the auto reverse feature reverses the direction. The beeper sounds three times.

The auto reverse function stops sensing when the tailgate is almost closed to make sure that it fully closes.

Do not touch the sensors located on both sides of the tailgate. The power tailgate does not close if you touch either sensor when you are trying to close the tailgate.

Be careful not to scratch the sensors with a sharp object. If scratched, they can be damaged, and the power tailgate closing feature malfunctions.

■ Power Tailgate Button

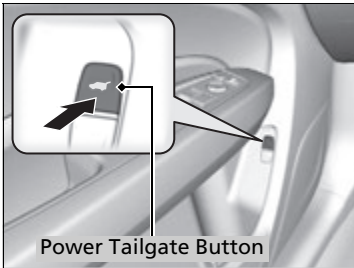

To open or close the power tailgate, press the power tailgate button for about one second. Some exterior lights flash and the beeper sounds.

To reverse direction while the power tailgate is in operation, press the button again. The beeper sounds three times and the tailgate reverses direction.

■ Power Tailgate Outer Handle

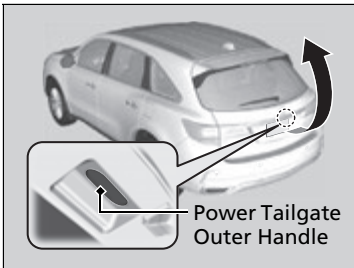

To open the power tailgate, press the outer handle for one second. Some exterior lights flash and the beeper sounds.

■ Power Tailgate Close Button

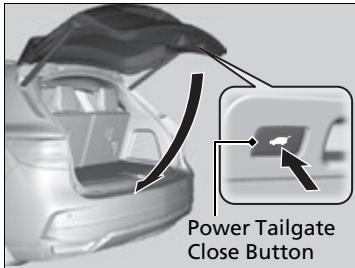

Press the button on the tailgate to close the power tailgate.
If you press the button again while the power tailgate is closing, it reverses direction.

■ Auto-Closer

If you manually close the power tailgate, it latches automatically.

⌘ Power Tailgate Close Button

If you press the power tailgate close button while the tailgate is automatically opening, the power tailgate operation reverses direction.

⌘ Auto-Closer

The auto-closer feature does not activate if you press the tailgate outer handle while the power tailgate is closing.

Do not put any force on the tailgate while the power tailgate is latching.

Keep your hands away from the tailgate when you manually close the tailgate and let it latch automatically. It is dangerous to put your hands around the tailgate as it starts to latch itself.

■ Power Tailgate Fall Detection

Automatically lowers the power tailgate when there is a possibility that the fully opened power tailgate can fall down by its own weight (for example, by snow on the tailgate). The beeper sounds while the power tailgate lowers.

☒ Power Tailgate Fall Detection

If you try to manually close the power tailgate immediately after it fully opens, the power tailgate fall detection may activate.

Once the power tailgate fall detection activates, wait until the power tailgate fully closes. Keep away from the power tailgate when it is in motion.

If the power tailgate fall detection constantly activates, consult at a dealer.

Immobilizer System

The immobilizer system prevents a key that has not been pre-registered from starting the power system. Each key contains electronic transmitters that use electronic signals to verify the key.

Pay attention to the following when pressing the **POWER** button:

- Do not allow objects that emit strong radio waves near the **POWER** button.
- Make sure the key is not covered by or touching a metal object.
- Do not bring a key from another vehicle's immobilizer system near the **POWER** button.
- Do not put the key near magnetic items. Electronic devices, such as televisions and audio systems emit strong magnetic fields. Note that even a key chain can become magnetic.

Security System Alarm

The security system alarm activates when the tailgate, hood or doors are forcibly opened. The alarm does not activate if the tailgate or doors are opened with the key, remote transmitter or keyless access system.

However, the alarm activates if a door is opened with the key and then the hood is opened before the power mode is set to ON.

■ When the security system alarm activates

The horn sounds intermittently, and some exterior lights flash.

■ To deactivate the security system alarm

Unlock the vehicle using the key, remote transmitter, or keyless access system. The system, along with the horn and flashing lights, is deactivated.

☒ Immobilizer System

NOTICE

Leaving the key in the vehicle can result in theft or accidental movement of the vehicle. Always take the key with you whenever you leave the vehicle unattended.

Do not alter the system or add other devices to it. Doing so may damage the system and make your vehicle inoperable.

☒ Security System Alarm

Do not alter the system or add other devices to it. Doing so may damage the system and make your vehicle inoperable.

The security alarm continues for a maximum of two minutes until the security system alarm deactivates.

■ Setting the security system alarm

The security system alarm automatically sets when the following conditions have been met:

- The power mode is set to VEHICLE OFF (LOCK).
- The hood is closed.
- All doors and the tailgate are locked from outside with the key, remote transmitter, or keyless access system.

■ When the security system alarm sets

The security system alarm indicator in the instrument panel blinks. When the blinking interval changes after about 15 seconds, the security system alarm is set.

■ To cancel the security system alarm

The security system alarm is canceled when the vehicle is unlocked using the key, remote transmitter, keyless access system, or the power mode is set to ON. The security system alarm indicator goes off at the same time.

▣ Security System Alarm

Do not set the security system alarm when someone is in the vehicle or a window is open. The system can accidentally activate when:

- Unlocking the door with the lock tab.
- Opening the hood with the hood release.

If the 12-volt battery goes dead after you have set the security system alarm, the security alarm may go off once the 12-volt battery is recharged or replaced.

If this occurs, deactivate the security system alarm by unlocking a door using the key, remote transmitter, or keyless access system.

■ Panic Mode

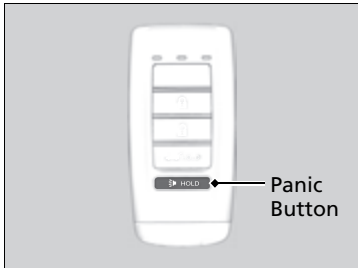

■ The panic button on the remote transmitter

If you press the panic button for approximately one second, the following will occur for about 30 seconds:

- The horn sounds.
- Some exterior lights flash.

■ Canceling panic mode

Press any button on the remote transmitter, or set the power mode to ON.

Opening/Closing the Power Windows

The power windows can be opened and closed when the power mode is in ON, using the switches on the doors.

The driver's side switches can be used to open and close all the windows. The power window lock button on the driver's side must be switched off (not pushed in, indicator off) to open and close the windows from anywhere other than the driver's seat.

When the power window lock button is pushed in, the indicator comes on and you can only operate the driver's window. Turn the power window lock button on if a child is in the vehicle.

Opening/Closing Windows with Auto-Open/Close Function

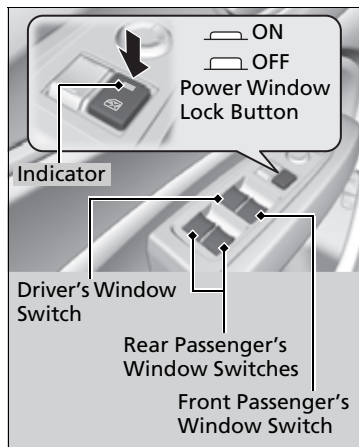

Manual operation

To open: Push the switch down lightly, and hold it until the desired position is reached.

To close: Pull the switch up lightly, and hold it until the desired position is reached.

Automatic operation

To open: Push the switch down firmly.

To close: Pull the switch up firmly.

The window opens or closes completely. To stop the window at any time, push or pull the switch briefly.

Opening/Closing the Power Windows

WARNING

Closing a power window on someone's hands or fingers can cause serious injury.

Make sure your passengers are away from the windows before closing them.

The power windows can be operated for up to 10 minutes after you set the power mode to VEHICLE OFF (LOCK).

Opening either front door cancels this function.

Auto Reverse

If a power window senses resistance when closing automatically, it will stop closing and reverse direction.

The driver's window auto reverse function is disabled when you continuously pull up the switch.

The auto reverse function stops sensing when the window is almost closed to ensure that it fully closes.

■ Opening the Windows and Moonroof with the Remote

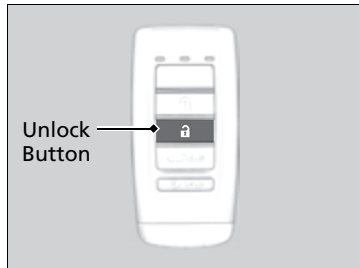

To open: Press the unlock button, and then within 10 seconds, press it again and hold it.

If the windows and moonroof stop midway, repeat the procedure.

■ Opening/Closing the Windows and Moonroof with the Key

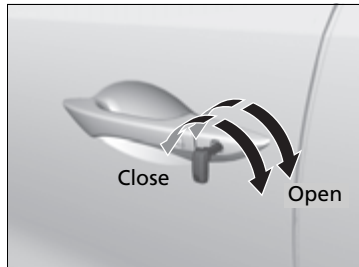

To open: Unlock the driver's door with the key. Within 10 seconds of returning the key to the central position, turn the key in the unlock direction and hold it there.

To close: Lock the driver's door with the key. Within 10 seconds of returning the key to the central position, turn the key in the lock direction and hold it there.

Release the key to stop the windows and moonroof at the desired position. If you want further adjustment, repeat the same operation.

Opening/Closing the Moonroof

You can only operate the moonroof when the power mode is in ON. Use the switch in the front of the ceiling to open and close the moonroof.

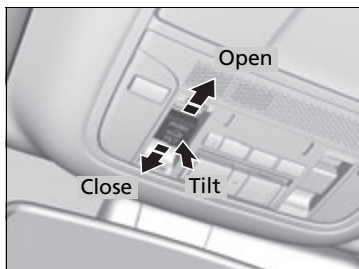

Automatic operation

To open: Pull the switch back firmly.

To close: Push the switch forward firmly.

The moonroof will automatically open or close all the way. To stop the moonroof midway, push the switch briefly.

Manual operation

To open: Pull the switch back lightly, and hold it until the desired position is reached.

To close: Push the switch forward lightly, and hold it until the desired position is reached.

Tilting the moonroof up

To tilt: Push on the center of the moonroof switch.

To close: Push the switch forward firmly, then release.

Opening/Closing the Moonroof

⚠ WARNING

Opening or closing the moonroof on someone's hands or fingers can cause serious injury.

Make sure all hands and fingers are clear of the moonroof before opening or closing it.

NOTICE

Opening the moonroof in below freezing temperature or when it is covered with snow or ice can damage the moonroof panel or motor.

The power moonroof can be operated for up to 10 minutes after you set the power mode to VEHICLE OFF (LOCK).

Opening either front door cancels this function.

When resistance is detected, the auto reverse function causes the moonroof to change directions, then stop. Auto reverse stops sensing when the moonroof is almost closed to ensure that it fully closes. Make sure that all objects, including fingers, are clear of the moonroof.

You can use the remote transmitter or the key to operate the moonroof.

➤ **Opening the Windows and Moonroof with the Remote** P. 162

➤ **Opening/Closing the Windows and Moonroof with the Key** P. 162

POWER Button

Changing the Power Mode

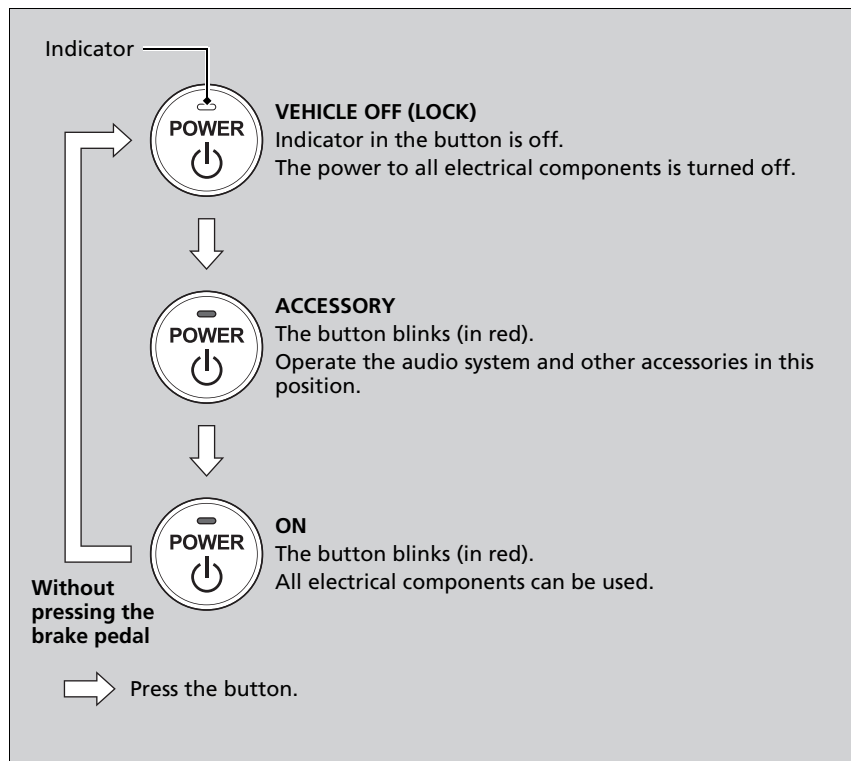

POWER Button

POWER Button Operating Range

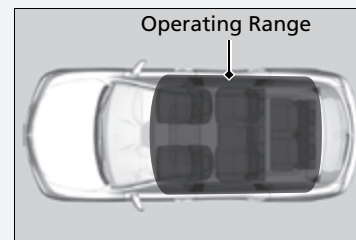

You can start the power system when the keyless access remote is inside the vehicle. The power system may also start if the keyless access remote is close to the door or window, even if it is outside the vehicle.

If the keyless access remote battery is weak, beeper sounds and the **To Start, Hold Remote Near Start Button** message appears on the MID.

If the Keyless Access Remote Battery is Weak P. 405

Do not leave the power mode in ACCESSORY or ON when you get out.

■ Automatic Power Off

If you leave the vehicle for 30 to 60 minutes with the transmission in **P** and the power mode in ACCESSORY, the vehicle automatically goes into the mode to VEHICLE OFF (LOCK) to avoid draining the 12-volt battery.

■ Power Mode Reminder

If you open the driver's door when the power mode is set to ACCESSORY, a warning buzzer sounds.

■ Keyless Access Remote Reminder

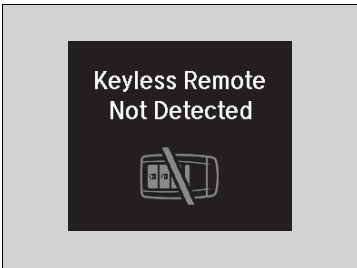

Warning buzzers may sound from inside and/or outside the vehicle to remind you that the keyless access remote is out of the vehicle. If the buzzer continues even after the remote is put back inside, place it to be within its operational range.

■ When the power mode is in ON

If the keyless access remote is taken out of the vehicle, and the driver's door is closed, a warning buzzer sounds from both inside and outside the vehicle. A warning message on the MID notifies the driver inside that the remote is outside of the vehicle.

■ When the power mode is in ACCESSORY

If the keyless access remote is taken out of the vehicle, and the driver's door is closed, a warning buzzer sounds from outside the vehicle.

▣ Keyless Access Remote Reminder

When the keyless access remote is within the system's operational range, and the driver's door is closed, the warning function cancels.

If the keyless access remote is taken out of the vehicle after the power system has been turned on, you can no longer change the **POWER** button mode or restart the power system. Always make sure if the remote is in your vehicle when you operate the **POWER** button.

Removing the keyless access remote from the vehicle through a window does not activate the warning buzzer.

Do not put the keyless access remote on the dashboard or in the glove box. It may cause the warning buzzer to go off. Under some other conditions that can prevent the vehicle from locating the remote, the warning buzzer may also go off even if the remote is within the system's operational range.

Turn Signals

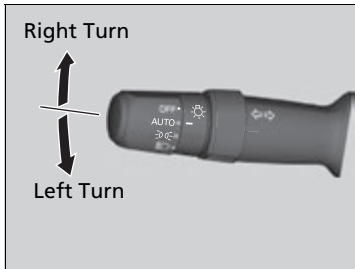

The turn signals can be used when the power mode is in ON.

■ One-touch turn signal

When you lightly push up or down and release the turn signal lever, the exterior turn signals and turn signal indicator blink three times. This feature can be used when signaling for a lane change.

Light Switches

Manual Operation

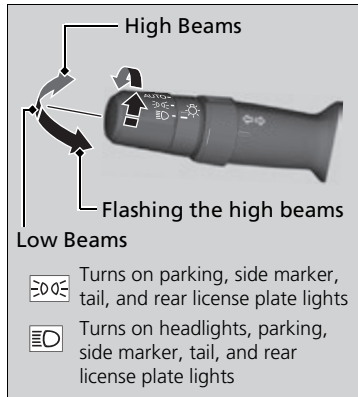

Rotating the light switch turns the lights on and off, regardless of the power mode setting.

■ High beams

Push the lever forward until you hear a click.

■ Low beams

When in high beams, pull the lever back to return to low beams.

■ Flashing the high beams

Pull the lever back, and release it.

■ Lights off

Turn the lever to **OFF** either when:

- The transmission is in **P**.
- The parking brake is applied.

To turn the lights on again, turn the lever to **OFF** to cancel the lights off mode. Even if you do not cancel the lights off mode, the lights come on automatically when:

- The gear position is changed out of **P** and the parking brake is released.
- The vehicle starts to move.

Light Switches

If you leave the power mode in VEHICLE OFF (LOCK) while the lights are on, a chime sounds when the driver's door is opened.

When the lights are on, the lights on indicator in the instrument panel will be on.

➤ Lights On Indicator P. 90

Do not leave the lights on when the power system is off because it will cause the 12-volt battery to discharge.

Models without automatic headlight adjusting system

If you sense that the level of the headlights is abnormal, have the vehicle inspected by a dealer.

Models with automatic headlight adjusting system

Your vehicle is equipped with the automatic headlight adjusting system that automatically adjusts the vertical angle of the high/low beam headlights. If you find a significant change in the vertical angle of the headlights, there may be a problem with the system. Have your vehicle checked by a dealer.

Automatic Operation (automatic lighting control)



Automatic lighting control can be used when the power mode is in ON.

When the light switch is in **AUTO**, the headlights and other exterior lights will switch on and off automatically depending on the ambient brightness.

- ▶ You can change the auto light sensitivity setting.
- ▶ **Customized Features** P. 125
- ▶ **Refer to the Navigation System Manual**

Automatic Operation (automatic lighting control)

We recommend that you turn on the lights manually when driving at night, in a dense fog, or in dark areas such as long tunnels or parking facilities.

The light sensor is in the location shown below.

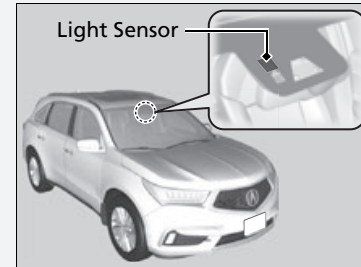

Adjust the auto light sensitivity as follows:

Setting	The exterior lights come on when the ambient light is at
Max	
High	
Mid	
Low	
Min	

■ Headlight Integration with Wiper

The headlights automatically come on when the wipers are used several times within a certain number of intervals with the headlight switch in **AUTO**. The headlights automatically go off a few minutes later if the wipers are stopped.

■ Automatic Lighting Off Feature

The headlights, all other exterior lights, and the instrument panel lights turn off 15 seconds after you set the power mode to VEHICLE OFF (LOCK), take the remote with you, and close the driver's door.

If you set the power mode to VEHICLE OFF (LOCK) with the headlight switch on, but do not open the door, the lights turn off after 10 minutes (3 minutes, if the switch is in the **AUTO** position).

The lights turn on again when you unlock or open the driver's door. If you unlock the door, but do not open it within 15 seconds, the lights go off. If you open the driver's door, you will hear a lights on reminder chime.

⌘ Headlight Integration with Wiper

This feature activates while the headlights are off in **AUTO**. The instrument panel brightness does not change when the headlights come on.

At dark ambient light levels, the automatic lighting control feature turns on the headlights, regardless of the number of wiper sweeps.

⌘ Automatic Lighting Off Feature

You can change the headlight auto off timer setting.

- ⌘ **Customized Features** P. 125
- ⌘ **Refer to the Navigation System Manual**

Fog Lights*

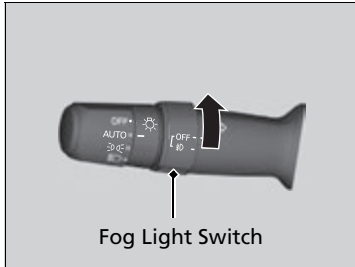

When the low beam headlights are on, turn the fog light switch on to use the fog lights.

Daytime Running Lights

The daytime running lights come on when the following conditions have been met:

- The power mode is in ON.
- The headlight switch is in **AUTO** or .
- The parking brake is released.

The lights remain on even if you set the parking brake. Setting the power mode to VEHICLE OFF (LOCK) will turn off the daytime running lights.

The daytime running lights are off once the headlight switch is turned on, or when the head light switch is in **AUTO** and it is getting darker outside.

☒ Fog Lights*

When the fog lights are on, the indicator in the instrument panel will be on. They go off when the headlights turn off, or when the daytime running lights are on.

➤ **Fog Light Indicator*** P. 90

* Not available on all models

Auto High-Beam

Uses the camera attached to the windshield, monitors the space ahead of your vehicle, and automatically changes the low beam headlights to high beam headlights when necessary.

The system operates when:

- The headlight switch is in **AUTO**.
- The lever is in the low beam position.
- The system recognizes that you are driving at night and the low beam headlights come on.
- The vehicle speed is above 35 mph (56 km/h).

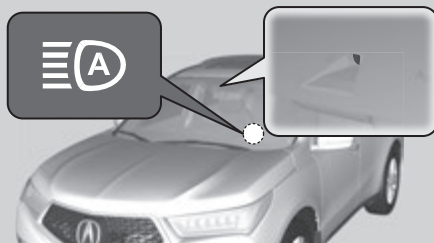

The system changes between high and low beam headlights when:

The camera is not detecting any lights coming from preceding or oncoming vehicles: The headlights change to high beams.

The camera detects lights coming from a preceding or oncoming vehicle: The headlights are returned to low beams.

The view angle or distance that the camera can detect lights ahead differs depending on conditions, such as the brightness of the lights and the weather.

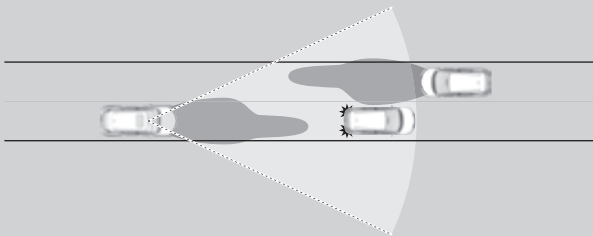

Auto High-Beam

The auto high-beam determines when to change the headlight beams by responding to the brightness of the lights ahead of your vehicle. In the following cases, the system may not respond to the lights properly:

- The brightness of the lights from the preceding or oncoming vehicle is intense or poor.
- Visibility is poor due to the weather (rain, snow, fog, windshield frost, etc.).
- Other light sources, such as street lights and electric billboards are illuminating the road ahead.
- The brightness level of the road ahead constantly changes.
- The road is bumpy or with many curves.
- A vehicle cuts in front of you, or a vehicle in front of you is not in the preceding or oncoming direction.
- Your vehicle is tilted with a heavy load in the rear.

If you find the timing of beam changes inconvenient for driving, change the headlight beams manually.

■ To Operate the System

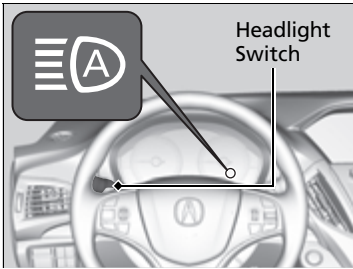

Turn the headlight switch in **AUTO** and pull the headlight lever to low beam.

☒ **Light Switches** P. 168

The auto high-beam indicator comes on.

■ Temporary cancellation

The auto high-beam operation is temporarily canceled while:

- You are continuously driving at a speed below 25 mph (40 km/h).
- The vehicle speed is below 15 mph (24 km/h).
- The windshield wipers run at high speed for more than a few seconds.

The system operation resumes once the condition that caused it to cancel improves.

☒ To Operate the System

For the auto high-beam to work properly:

- Do not place an object that reflects light on the dashboard.
- Keep the windshield around the camera clean. When cleaning the windshield, be careful not to apply the windshield cleanser to the camera lens.
- Do not attach an object, sticker or film to the area around the camera.
- Do not touch the camera lens.

If the camera receives a strong impact, or repairing of the area near the camera is required, consult a dealer.

If the **Some Driver Assist Systems Cannot Operate: Camera Temperature Too High** message appears:

- Use the climate control system to cool down the interior and, if necessary, also use defroster mode with the air flow directed towards the camera.
- Start driving the vehicle to lower the windshield temperature, which cools down the area around the camera.

If the **Some Driver Assist Systems Cannot Operate: Clean Front Windshield** message appears:

- Park your vehicle in a safe place, and clean the windshield. If the message does not disappear after you have cleaned the windshield and driven for a while, have your vehicle checked by a dealer.

■ To manually cancel the system temporarily

You can cancel the operation when you manually change the headlights to high beams. Push the lever forward until you hear a click, or lightly pull the lever towards you to flash high beams. The auto high-beam indicator goes off.

If you want the auto high-beam operation to resume at once, pull the lever towards you.

■ To Adjust the System

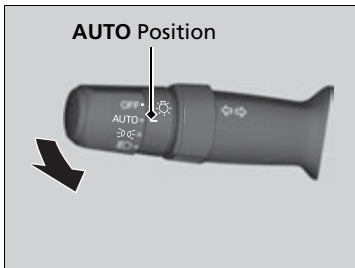

Adjust the system when the vehicle is parked with the power mode in ON and the light switch is in the **AUTO** position.

To disable the system: Pull the light switch lever towards you and hold it for 40 seconds. The auto high-beam indicator in the meter will blink twice.

To enable the system: Pull the light switch lever towards you and hold it for 30 seconds. The auto high-beam indicator in the meter will blink once.

To set the high sensitivity: Pull the light switch lever towards you and hold it for 2 minutes.

The auto high-beam indicator in the meter will blink three times. The setting is reset when the power mode is set to VEHICLE OFF (LOCK).

▶▶ To Adjust the System

The auto high-beam is in the previously selected disabled or enabled setting each time you start the power system.

Wipers and Washers

■ Windshield Wipers/Washers

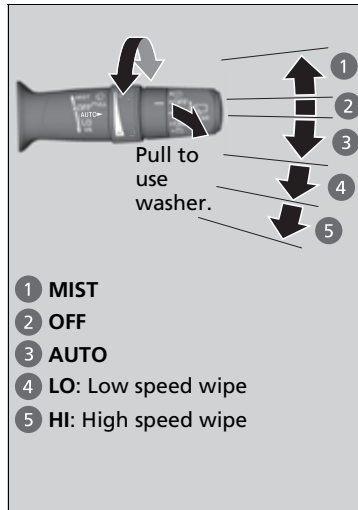

The windshield wipers and washers can be used when the power mode is in ON.

■ MIST

The wipers run at high speed until you release the lever.

■ Wiper switch (OFF, AUTO, LO, HI)

Move the lever up or down to change the wiper settings.

■ Washer

Sprays while you pull the lever toward you. When you release the lever for more than one second, the spray stops, the wipers sweep two or three more times to clear the windshield, then stop.

» Wipers and Washers

NOTICE

Do not use the wipers when the windshield is dry. The windshield will get scratched, or the rubber blades will get damaged.

Turn the washers off if no washer fluid comes out. The pump may get damaged.

The wiper motor may stop motor operation temporarily to prevent an overload. Wiper operation will return to normal within a few minutes, once the circuit has returned to normal.

NOTICE

In cold weather, the blades may freeze to the windshield. Operating the wipers in this condition may damage the wipers. Use the defroster or heated windshield* to warm the windshield, then turn the wipers on.

If the wipers stop operating due to an obstacle such as the build-up of snow, park the vehicle in a safe place.

Rotate the wiper switch to **OFF**, and set the power mode to ACCESSORY or VEHICLE OFF (LOCK), then remove the obstacle.

* Not available on all models

■ Automatic Intermittent Wipers

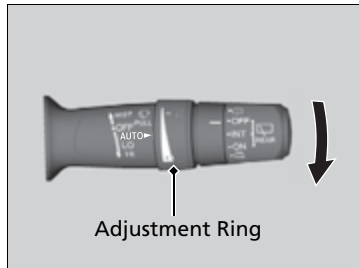

When you push the lever down to **AUTO**, the windshield wipers sweep once, and go into the automatic mode.

The wipers operate intermittently, at low speed, or at high speed and stops in accordance with the amount of rainfall the rainfall sensor detects.

■ Auto sensitivity adjustment

When the wiper function is set to **AUTO**, you can adjust the sensitivity of the rainfall sensor (using the adjustment ring) so that wipers will operate in accordance with your preference.

Sensor sensitivity

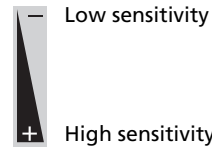

▶ Automatic Intermittent Wipers

The rainfall sensor is in the location shown below.

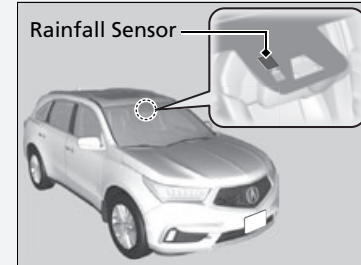

NOTICE

AUTO should always be turned **OFF** before the following situation in order to prevent severe damage to the wiper system:

- Cleaning the windshield
- Driving through a car wash
- No rain present

Rear Wiper/Washer

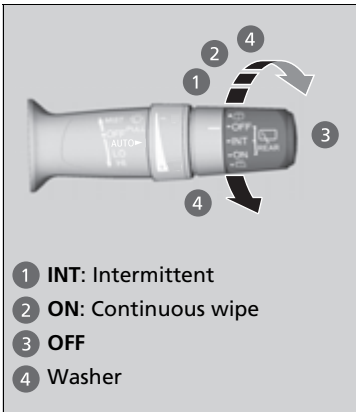

- 1 INT: Intermittent
- 2 ON: Continuous wipe
- 3 OFF
- 4 Washer

The rear wiper and washer can be used when the power mode is in ON.

Wiper switch (OFF, INT, ON)

Change the wiper switch setting according to the amount of rain.

Washer ()

Sprays while you rotate the switch to this position. Hold it to activate the wiper and to spray the washer. Once released, it stops operating after a few more sweeps.

Operating in reverse

When you select the transmission to **R** with the windshield wipers activated, the rear wiper operates automatically as follows even if its switch is off.

Windshield Wiper Operation	Rear Wiper Operation
Intermittent	Intermittent
Low speed wipe	Continuous
High speed wipe	

Canadian models

Headlight Washers

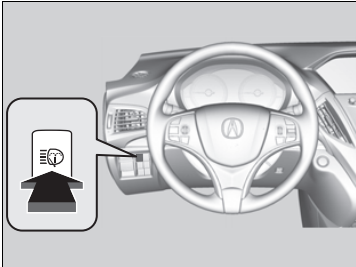

Turn the headlights on and press the headlight washer button to operate. The headlight washers also operate when you turn the windshield washers for the first time after the power mode is set to ON.

▶▶ Headlight Washers

The headlight washers use the same fluid reservoir as the windshield washers.

Brightness Control

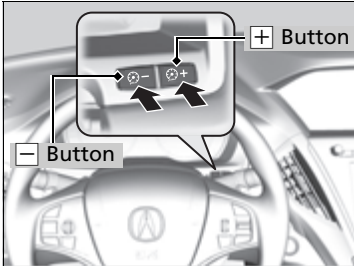

When the power mode is in ON, you can use the **+** or **-** button to adjust instrument panel brightness.

Brighten: Press the **+** button.

Dim: Press the **-** button.

You will hear a beep when the brightness reaches minimum or maximum. Several seconds after you have adjusted the brightness, you will be returned to the previous display.

■ Brightness level indicator

The brightness level is shown on the MID while you are adjusting it.

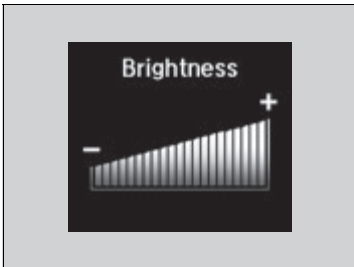

☒ Brightness Control

Instrument panel brightness varies, depending on whether the exterior lights are on or off. The instrument panel dims to reduce glare when they are on.

When it is bright outside and the headlight integration with the wiper is activated, the instrument panel brightness does not change.

To cancel the reduced instrument panel brightness when the exterior lights are on, press the **+** button until the brightness display is up to max, the beeper sounds.

The brightness can be set differently for when the exterior lights are on, and when they are off.

Rear Defogger/Heated Door Mirror Button

Press the rear defogger and heated door mirror button to defog the rear window and mirrors when the power mode is in ON.

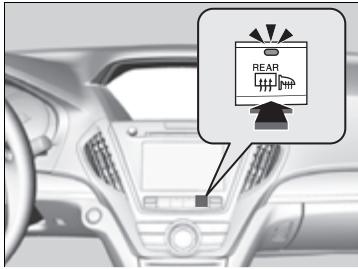

The rear defogger and heated door mirrors automatically switch off after 10-30 minutes depending on the outside temperature.

►► Rear Defogger/Heated Door Mirror Button

NOTICE

When cleaning the inside of the rear window, be careful not to damage the heating wires. It is critical to wipe the window from side to side along the defogger heating wires.

This system consumes a lot of power, so turn it off when the window has been defogged. Also, do not use the system for a long time while the power system is stopped. This may weaken the 12-volt battery, making it difficult to turn the power system on.

When the outside temperature is below 41°F (5°C), the heated door mirror may activate automatically for 10 minutes when you set the power mode to ON.

Heated Windshield Button *

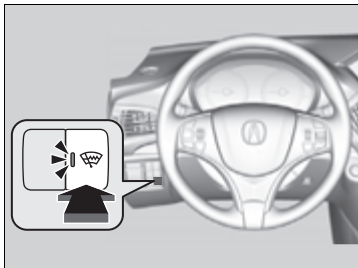

Press the heated windshield button to deice the windshield when the power mode is in ON.

►► Heated Windshield Button *

This system consumes a lot of power, so turn it off when the window has been deiced. Also, do not use the system for a long period when the power system is stopped. This may weaken the 12-volt battery, making it difficult to turn the power system on.

When the outside temperature is below 39°F (4°C), the heated windshield may automatically activate. The system deactivates itself once the outside temperature reaches 43°F (6°C).

Driving Position Memory System

You can store two driver's seat (except for power lumbar), steering wheel and door mirror positions with the driving position memory system.

When you unlock and open the driver's door with a remote transmitter, or keyless access system, the seat and door mirrors adjust automatically to one of the two preset positions.

The steering wheel will move to the stored position when you set the power mode to ACCESSORY.

When you enter the vehicle, the MID briefly shows you which remote transmitter you used to unlock the vehicle.

- **DRIVER 1** transmitter is linked to memory button 1.
- **DRIVER 2** transmitter is linked to memory button 2.



The driver's seat moves rearward and steering wheel fully up depending on the set seating position once you

- Stop the vehicle.
- Put the transmission in **P**.
- Turn the power system off.
- Then open the driver's door.

Once the power mode is in the ACCESSORY position, the driver's seat and steering wheel moves to the **DRIVER 1** or **2** preset position.

▣ Driving Position Memory System

Using the audio/information screen or MID, you can disable the automatic seat, steering wheel and door mirrors adjustment function.

- ▣ **Customized Features** P. 125
- ▣ **Refer to the Navigation System Manual**

The driver's seat easy exit feature can be turned ON/OFF.

- ▣ **Customized Features** P. 125
- ▣ **Refer to the Navigation System Manual**

When opening the driver's door, the customized features you have previously set using the same remote are also recognized. They include:

- Driving position memory
- Keyless memory settings
- Audio system settings
- Climate control settings
- Navigation system preferences

System Operation

The system will not operate if:

- The vehicle speed is above 3 mph (5 km/h).
- Either memory position button is pressed while the seat or steering wheel is in motion.
- The seat or steering wheel position is adjusted while in operation.
- The memory 1 or 2 position is set fully to the rear.

■ Storing a Position in Memory

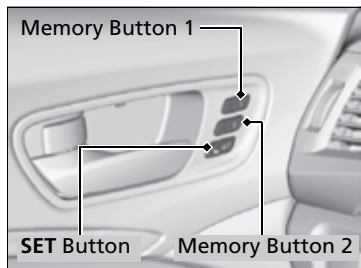

1. Set the power mode to ON. Adjust the driver's seat, the steering wheel and the door mirrors to the desired position.
2. Press the **SET** button.
 - ▶ You will hear the beeper, and the memory button indicator light will blink.
3. Press and hold memory button **[1]** or **[2]** within five seconds of pressing the **SET** button.
 - ▶ Once the seat, the steering wheel and the outside mirror positions have been memorized, the indicator light on the button you pressed stays on.

■ Recalling the Stored Position

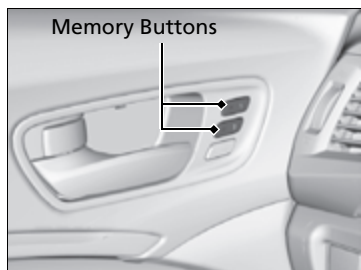

1. Change to **[P]**.
2. Apply the parking brake.
3. Press a memory button (**[1]** or **[2]**).
 - ▶ You will hear the beeper, and the indicator light will blink.

The seat, the steering wheel and the door mirrors will automatically move to the memorized positions. When it has finished moving, you will hear the beeper, and the indicator light stays on.

☒ Storing a Position in Memory

After you press the **SET** button, the storing operation will be canceled when:

- You do not press the memory button within five seconds.
- You readjust the seat, the steering wheel or the outside mirror position before the double-beep.
- You set the power mode to any position except ON.

☒ Recalling the Stored Position

The seat, the steering wheel and the door mirrors will stop moving if you:

- Press the **SET** button or memory button **[1]** or **[2]**.
- Adjust the seat position, door mirrors, or steering wheel.
- Select into a position other than **[P]**.

Adjusting the Steering Wheel

The steering wheel height and distance from your body can be adjusted so that you can comfortably grip the steering wheel in an appropriate driving posture.

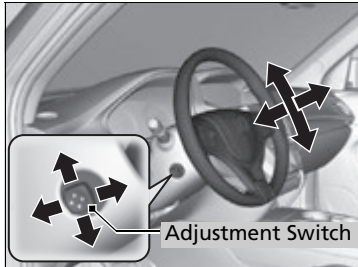

Push and hold the adjustment switch to move the steering wheel in, out, up or down.

- ▶ Make sure you can see the instrument panel gauges and indicators.

Adjusting the Steering Wheel

⚠ WARNING

Adjusting the steering wheel position while driving may cause you to lose control of the vehicle and be seriously injured in a crash.

Adjust the steering wheel only when the vehicle is stopped.

Interior Rearview Mirror

Adjust the angle of the rearview mirror when you are sitting in the correct driving position.

Automatic Dimming Rearview Mirror and Power Door Mirrors*

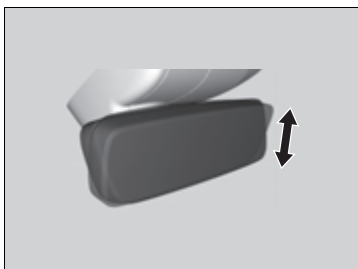

When you are driving after dark, the automatic dimming rearview mirror and power door mirrors* reduce the glare from headlights behind you, based on inputs from the mirror sensor. This feature is always active.

Adjusting the Mirrors

Keep the inside and outside mirrors clean and adjusted for best visibility.

Adjust the mirrors before you start driving.

➤ **Front Seats** P. 187

Automatic Dimming Rearview Mirror and Power Door Mirrors*

The auto dimming function cancels when the transmission is in **R**.

Power Door Mirrors

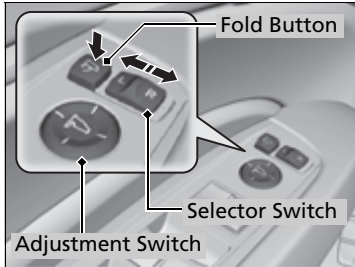

You can adjust the door mirrors when the power mode is set to ON.

■ Mirror position adjustment

L/R selector switch: Select the left or right mirror. After adjusting the mirror, return the switch to the center position.

Mirror position adjustment switch: Press the switch left, right, up, or down to move the mirror.

■ Folding door mirrors

Press the fold button to fold the door mirrors.

■ Reverse Tilt Door Mirror

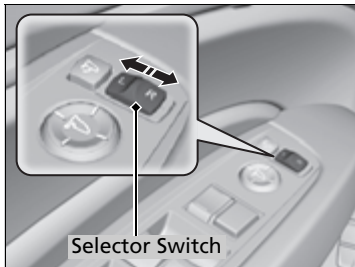

If activated, either side door mirror automatically tilts downward when you pull back **R**; this improves close-in visibility on the selected side of the vehicle when backing up. The mirror automatically returns to its original position when you select out of **R**.

To activate this feature, set the power mode to ON and slide the selector switch to the left or right side.

■ Automatic Folding Door Mirror Function

■ Folding the door mirrors

Lock all doors from outside the vehicle.

- ▶ The mirrors start folding automatically.
- **Locking and Unlocking the Doors** P. 137

■ Unfolding the door mirrors

Unlock the driver's or all doors from outside the vehicle.

- ▶ The mirrors start unfolding automatically.
- **Locking and Unlocking the Doors** P. 137

⌘ Automatic Folding Door Mirror Function

You can turn the automatic folding door mirror function on and off.

- **Customized Features** P. 125
- **Refer to the Navigation System Manual**

Door mirrors will not fold automatically when locking from inside the vehicle using lock tab or master door lock switch.

Door mirrors will not unfold automatically if fold button is pressed.

- **Folding door mirrors** P. 185

Front Seats

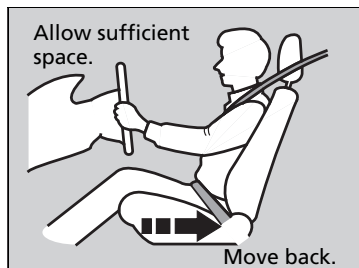

Adjust the driver's seat as far back as possible while allowing you to maintain full control of the vehicle. You should be able to sit upright, well back in the seat and be able to adequately press the pedals without leaning forward, and grip the steering wheel comfortably. The passenger's seat should be adjusted in a similar manner, so that it is as far back from the front airbag in the dashboard as possible.

Adjusting the Seats

⚠ WARNING

Sitting too close to a front airbag can result in serious injury or death if the front airbags inflate.

Always sit as far back from the front airbags as possible while maintaining control of the vehicle.

The National Highway Traffic Safety Administration and Transport Canada recommend that drivers allow at least 10 inches (25 cm) between the center of the steering wheel and the chest.

Always make seat adjustments before driving.

Adjusting the Seat Positions

Adjusting the front power seats

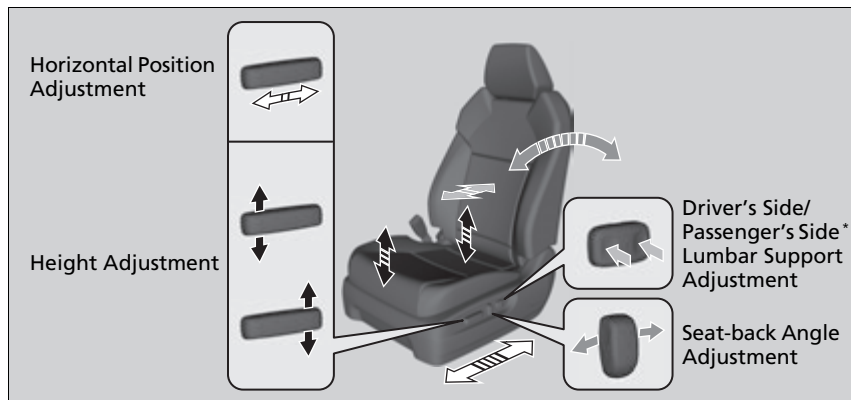

* Not available on all models

■ Adjusting the Seat-Backs

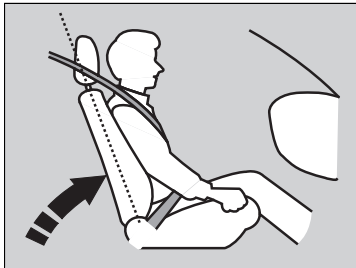

Adjust the driver's seat-back to a comfortable, upright position, leaving ample space between your chest and the airbag cover in the center of the steering wheel.

The front seat passenger should also adjust their seat-back to a comfortable, upright position.

Reclining a seat-back so that the shoulder part of the belt no longer rests against the occupant's chest reduces the protective capability of the belt. It also increases the chance of sliding under the belt in a crash and being seriously injured. The farther a seat-back is reclined, the greater the risk of injury.

► Adjusting the Seat-Backs

⚠ WARNING

Reclining the seat-back too far can result in serious injury or death in a crash.

Adjust the seat-back to an upright position, and sit well back in the seat.

Do not put a cushion, or other object, between the seat-back and your back. Doing so may interfere with proper seat belt or airbag operation.

If you cannot get far enough away from the steering wheel and still reach the controls, we recommend that you investigate whether some type of adaptive equipment may help.

Second Row Seats

■ Adjusting the Seat Positions

Models with bench seat



Horizontal Position Adjustment

Pull up the bar to move the seat, then release the bar.

Seat-back Angle Adjustment

Pull up the lever to change the angle.

▣ Second Row Seats

Once a seat is adjusted correctly, rock it back and forth to make sure it is locked in position.

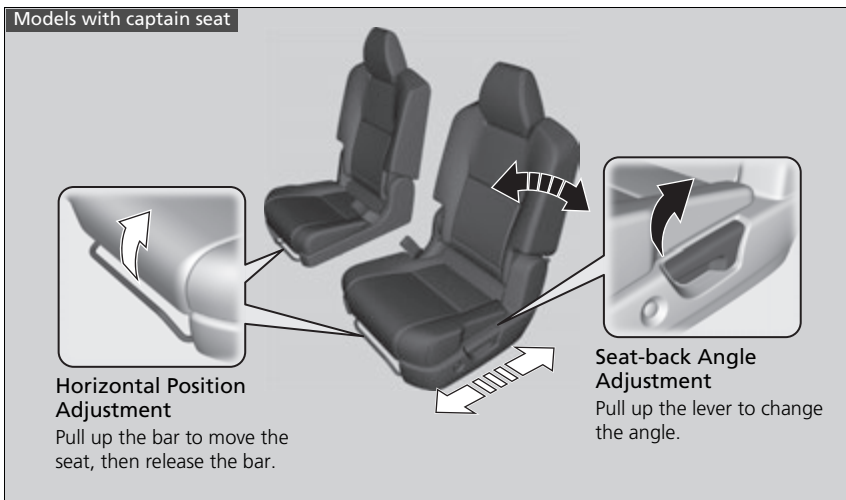

■ Third Row Seat Access

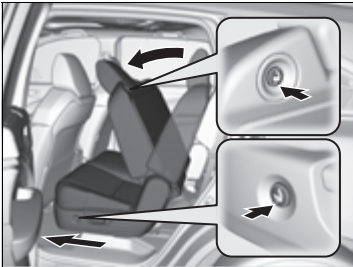

Pressing the button on the seat-back, or seat cushion tilts the second row outer seat's seat-back forward.

▶ The whole seat slides forward.

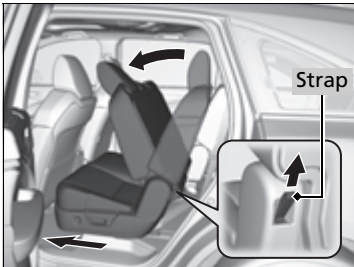

Pulling up on the strap also tilts the seat-back forward.

☒ Third Row Seat Access

The button is disabled when the vehicle is moving.

When you enter the third row seat, be careful not to trip over the second row seat belt.

■ Folding Down the Second Row Seat

Separately fold down the left and right halves of the second row seat to make room for cargo.

Models with bench seat

1. Store the center seat belt first. Insert the latch plate into the slot on the side of the anchor buckle.
➤ Seat Belt with Detachable Anchor P. 42
2. Retract the seat belt into the holder on the ceiling.
3. Lower the center head restraint to its lowest position. Put the armrest back into the seat-back.

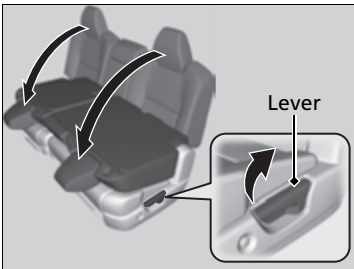

All Models

4. Pull up on the seat-back angle adjustment lever.

To return the seat to the original position, pull up the seat-back in the upright position.

►► Folding Down the Second Row Seat

Make sure that the folded seat-back does not press against the front passenger seat, as this can cause the weight sensors in the front passenger seat to work improperly.

➤ Passenger Front Airbag Off Indicator P. 58

The front seats must be far enough forward so they do not interfere with the second row seats as they fold down.

To lock the seat-back upright, push it backwards until it locks.

Make sure the seat-back, head restraints and seat cushion are securely latched back into place before driving. Also, make sure all rear shoulder belts are positioned in front of the seat-back.

Models with bench seat

Make sure the center shoulder belt is re-positioned in the holding slot.

Head Restraints

Your vehicle is equipped with head restraints in all seating positions.

Adjusting the Front and Second Row Outer Head Restraint Positions

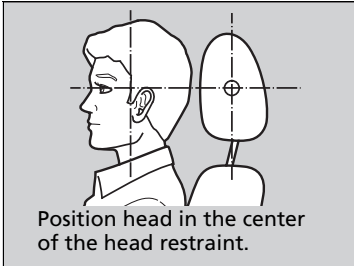

Head restraints are most effective for protection against whiplash and other rear-impact crash injuries when the center of the back of the occupant's head rests against the center of the restraint. The tops of the occupant's ears should be level with the center height of the restraint.

Head Restraints

⚠ WARNING

Improperly positioning head restraints reduces their effectiveness and increases the likelihood of serious injury in a crash.

Make sure head restraints are in place and positioned properly before driving.

In order for the head restraint system to work properly:

- Do not hang any items on the head restraints, or from the restraint legs.
- Do not place any objects between an occupant and the seat-back.
- Install each restraint in its proper location.

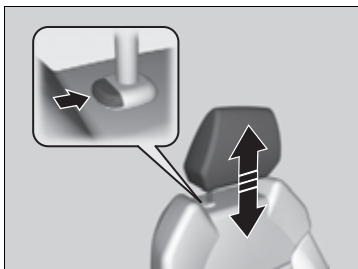

To raise the head restraint: Pull it upward.

To lower the head restraint: Push it down while pressing the release button.

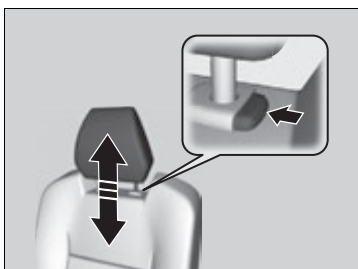

■ Changing the Second Row Center Seat Head Restraint Position *

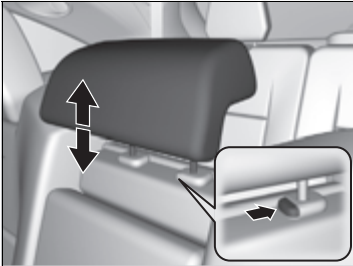

A passenger sitting in the second row center seating position should adjust the height of their head restraint to an appropriate position before the vehicle begins moving.

To raise the head restraint:

Pull it upward.

To lower the head restraint:

Push it down while pressing the release button.

■ Removing and Reinstalling the Head Restraints

Front and second row head restraints

Head restraints can be removed for cleaning or repair.

To remove a head restraint:

Pull the restraint up as far as it will go. Then push the release button, and pull the restraint up and out.

To reinstall a head restraint:

Insert the legs back in place, then adjust the head restraint to an appropriate height while pressing the release button. Pull up on the restraint to make sure it is locked in position.

☒ Removing and Reinstalling the Head Restraints

⚠ WARNING

Failure to reinstall, or correctly reinstall, the head restraints can result in severe injury during a crash.

Always replace the head restraints before driving.

* Not available on all models

■ Folding Down the Third Row Head Restraint

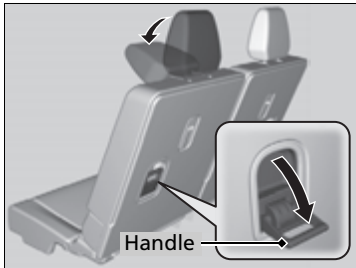

A passenger in the third row seating position should put the head restraint in the upright position before the vehicle begins moving.

To fold down the head restraint:

Pull the handle.

To put the head restraint back in the upright position:

Pull up the head restraint and push rearward until it latches.

Maintain a Proper Sitting Position

After all occupants have adjusted their seats and head restraints, and put on their seat belts, it is very important that they continue to sit upright, well back in their seats, with their feet on the floor until the vehicle is safely parked and the power system is off.

Sitting improperly can increase the chance of injury during a crash. For example, if an occupant slouches, lies down, turns sideways, sits forward, leans forward or sideways, or puts one or both feet up, the chance of injury during a crash is greatly increased.

In addition, an occupant who is out of position in the front seat can be seriously or fatally injured in a crash by striking interior parts of the vehicle or being struck by an inflating front airbag.

▶▶ Maintain a Proper Sitting Position

⚠ WARNING

Sitting improperly or out of position can result in serious injury or death in a crash.

Always sit upright, well back in the seat, with your feet on the floor.

Third Row Seats

■ Folding Down the Third Row Seat

Separately fold down the left and right halves of the third row seat to make room for cargo.

■ To fold down the seat

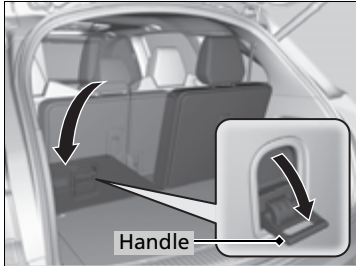

1. Pull the handle on the seat-back fully.
 - ▶ The head restraint tilts downward.
2. Push the seat-back forward while pulling the handle.

■ To return the seat to the original position

1. Pull the seat-back up with the handle pulled.
2. Push the head restraint up to its original position.

☒ Folding Down the Third Row Seat

Make sure all items in the cargo area or items extending to the third row seats are properly secured. Loose items can fly forward if you have to brake hard.

☒ To return the seat to the original position

Make sure the seat-back and head restraints are securely latched back into place before driving.

Armrest

■ Using the Front Seat Armrest

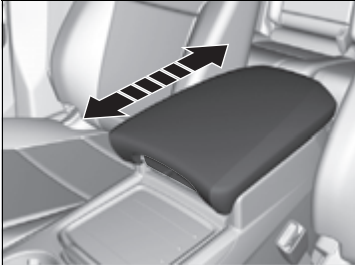

The console lid can be used as an armrest.

To adjust:

Slide the armrest to a desired position.

■ Using the Rear Seat Armrest

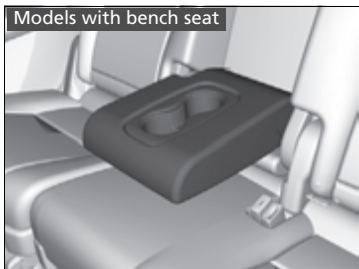

Pull down the armrest in the center backrest.

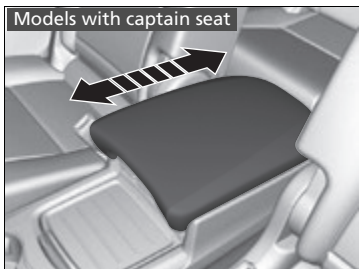

The console lid can be used as an armrest.

To adjust:

Slide the armrest to a desired position.

Interior Lights

Interior Light Switches

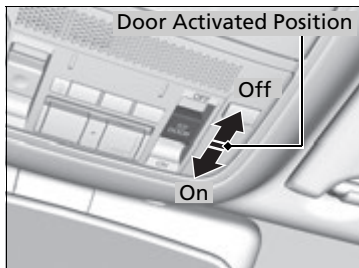

■ ON

The interior lights come on regardless of whether the tailgate and doors are open or closed.

■ Door activated

The interior lights come on in the following situations:

- When the tailgate or any of the doors are opened.
- You unlock the driver's door.
- When the power mode is set to VEHICLE OFF (LOCK).

■ OFF

The interior lights remain off regardless of whether the tailgate or any doors are open or closed.

Interior Light Switches

In the door activated position, the interior lights fade out and go off about 30 seconds after the doors are closed.

The lights go off after 30 seconds in the following situations:

- When you unlock the driver's door but do not open it.
- When you set the power mode to VEHICLE OFF (LOCK) but do not open a door.

You can change the interior lights dimming time.

➤ **Customized Features** P. 125

➤ **Refer to the Navigation System Manual**

The interior lights go off immediately in the following situations:

- When you lock the driver's door.
- When you close the driver's door in ACCESSORY mode.
- When you set the power mode to ON.

If you leave any of the tailgate or doors open in VEHICLE OFF (LOCK) mode, the interior lights go off after about 15 minutes.

■ Map Lights

Front

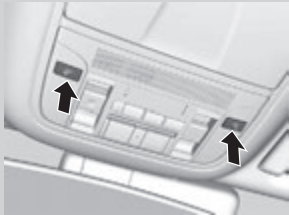

Second and third row



■ Front

The map lights can be turned on and off by pressing the  (map light) button.

■ Second and third row

The map lights can be turned on and off by pressing the  (map light) button when the front interior light switch is in the door activated position.

⌘ Interior Light Switches

When the interior light switch is in **ON**, if you close the tailgate and all doors in VEHICLE OFF (LOCK) mode, the interior lights go off after about 30 minutes.

However, when the 12-volt battery is weakened, the interior lights go off after about 30 minutes if any door is open.

⌘ Map Lights

When the interior light switch is in the door activated position and any door is open, the map light will not go off when you press the  button.

■ Cargo Area Lights

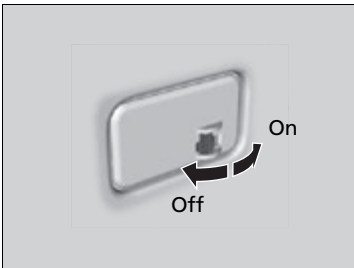

■ ON

The light comes on when you open the tailgate, and goes off when closed.

■ OFF

The light stays off with or without opening the tailgate.

Interior Convenience Items

■ Glove Box

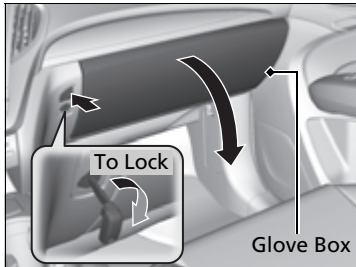

Press the button to open the glove box. You can lock the glove box with the built-in key.

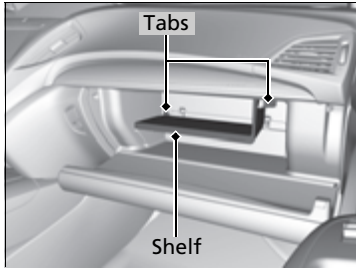

■ Removable shelf

The shelf in the glove box is detachable. To remove it, disengage the tabs.



The removed shelf can be stored upside down in the glove box.

☒ Glove Box

⚠ WARNING

An open glove box can cause serious injury to your passenger in a crash, even if the passenger is wearing the seat belt.

Always keep the glove box closed while driving.

■ Front and Rear* Console Compartment

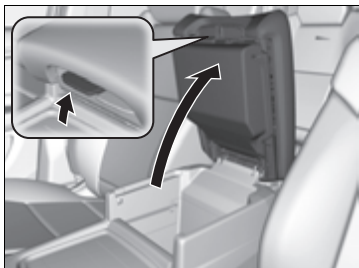

Pull the passenger's side handle to open the console compartment.

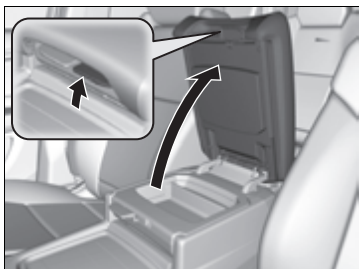

Pull the driver's side handle to open the utility tray in the console lid.

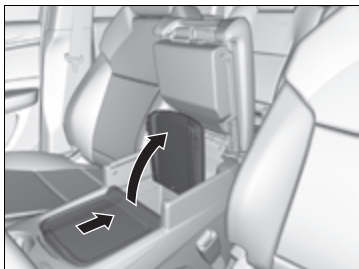

■ Console Tray

Slide or lift the tray when you use the console compartment.

- To lift this tray, slide it rearward, then pull it up.

■ Center Pocket

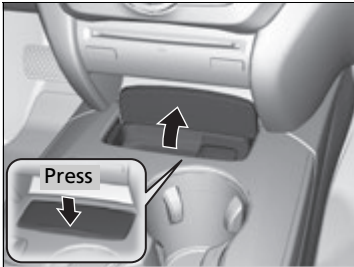

Press the raised detent to open the lid. To close the lid, push it down until it latches.

■ Under-floor Storage Area



Pull the handle to open the cargo floor lid.

■ Beverage Holders



■ Front seat beverage holders

Are located in the console between the front seats.

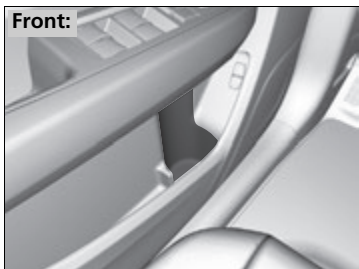

Front:

■ Door side beverage holders

Are located on the both of front and rear door side pockets.

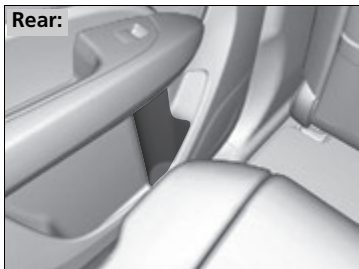

Rear:

» Beverage Holders

NOTICE

Spilled liquids can damage the upholstery, carpeting, and electrical components in the interior.

Be careful when you are using the beverage holders. Hot liquid can scald you.

Models with bench seat

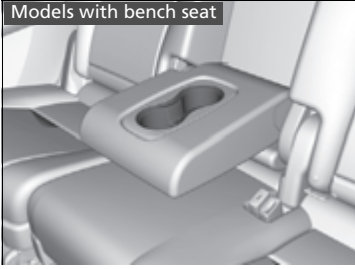

■ **Second row seat beverage holders**

Fold the armrest down to use the rear seat beverage holders.

Models with captain seat

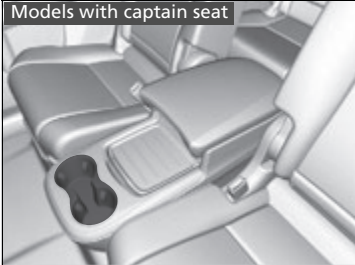

Are located in the console between the second row seats.



■ **Third row seat beverage holders**

■ Accessory Power Sockets

The accessory power sockets can be used when the power mode is in ACCESSORY or ON.



■ Accessory power socket (center pocket)

Open the lid and the cover to use it.

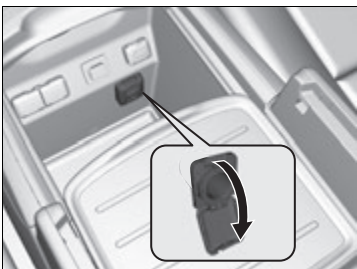

■ Accessory power socket (front console compartment)*

Pull the handle and open the cover to use it.

►► Accessory Power Sockets

NOTICE

Do not insert an automotive type cigarette lighter element: The power socket can overheat.

The accessory power sockets are designed to supply power for 12 volt DC accessories that are rated 180 watts (15 amps) or less.

To prevent 12-volt battery drain, use the power socket only when the power system is on.

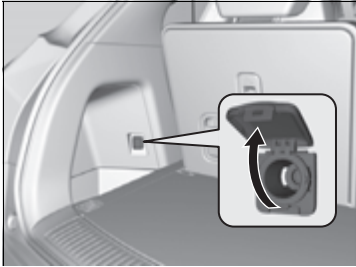

■ **Accessory power socket (cargo area)**

Open the cover to use it.

Canadian models

■ **AC Power Outlet**

The AC power outlet can be used when the power system is on.



Open the cover to use it. Plug in the appliance slightly, turn it 90° clockwise, then push it all the way.

⌘ AC Power Outlet

NOTICE

Do not use the AC power outlet for electric appliances that require high initial peak wattage, such as cathode-ray tube type televisions, refrigerators, electric pumps, etc. It is not suitable for devices that process precise data, such as medical equipment, and that require an extremely stable power supply, such as microcomputer-controlled electric blankets, touch sensor lamps, etc.

The AC power outlet is designed to supply power for up to 115 volt appliances that are rated 150 watts or less.

Continued use of any electric appliance/device exceeding these ratings may result in damage to the appliance/device.

■ Coat Hooks



There is a coat hook on the rear grab handle of both sides. Pull it down to use it.

■ Tie-down Anchors

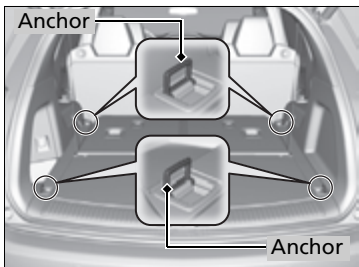

The tie-down anchors on the cargo area floor can be used to install a net for securing items.

☒ Coat Hooks

The coat hooks are not designed for large or heavy items.

☒ Tie-down Anchors

Do not let anyone access items in the cargo area while driving. Loose items can cause injury if you have to brake hard.

Sunglasses Holder



To open the sunglasses holder, press and release the indent. To close, press it again until it latches.

You can store eyeglasses and other small items in this holder.

☒ Sunglasses Holder

Keep the holder closed while driving except when accessing stored items.

Heated Steering Wheel*

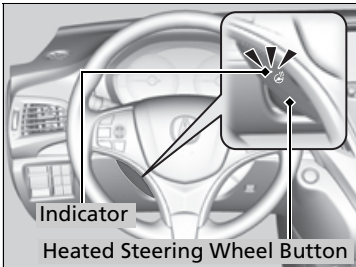

The power mode must be in ON to use the heated steering wheel.

Press the button on the left side of the steering wheel.

When a comfortable temperature is reached, press the button again to turn it off.

The heated steering wheel is turned off every time you start the power system, even if you turned it on the last time you drove the vehicle.

☒ Heated Steering Wheel*

Do not use the heated steering wheel continuously when the power system is off. Under such conditions, the 12-volt battery may be weakened, making the power system difficult to start.

* Not available on all models

■ Front Seat Heaters and Seat Ventilation*



The power mode must be in ON to use the seat heaters and ventilators*.

Models with seat ventilation



Models without seat ventilation



1. Select .
2. Change the setting with one of the following:

The **Heat/Cool*** level indicators: Select your desired level setting. The left is for a LO setting, the center is for a MID setting, and to the right for a HI setting.

: To go up or down one level at a time.

AUTO: The system automatically selects the setting most suitable to the ambient environment.

OFF: Turn off the system.

► Front Seat Heaters and Seat Ventilation*

WARNING

Heat induced burns are possible when using seat heaters.

Persons with a diminished ability to sense temperature (e.g., persons with diabetes, lower-limb nerve damage, or paralysis) or with sensitive skin should not use seat heaters.

Do not use the seat heaters and the seat ventilation even in LO when the power system is off. Under such conditions, the 12-volt battery may be weakened, making the power system difficult to start.

Second Row Outer Seat Heaters*



The power mode must be in ON to use the seat heaters.

Press the seat heater button:

Once - The HI setting (three indicators on)

Twice - The MID setting (two indicators on)

Three times - The LO setting (one indicator on)

Four times - The OFF setting (no indicators on)

Second Row Outer Seat Heaters*

⚠ WARNING

Heat induced burns are possible when using seat heaters.

Persons with a diminished ability to sense temperature (e.g., persons with diabetes, lower-limb nerve damage, or paralysis) or with sensitive skin should not use seat heaters.

Do not use the seat heaters even in LO when the power system is off. Under such conditions, the 12-volt battery may be weakened, making the power system difficult to start.

Integrated Sunshades*

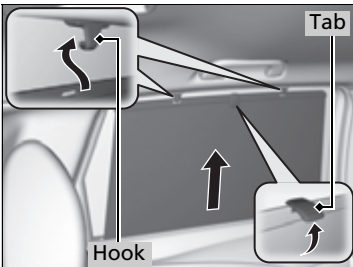

Pull the tab and roll up the sunshade all the way. Use the hooks to hang it.

Integrated Sunshades*

Use the sunshades only when the windows are fully closed. Using the shade while a window is open can unhook and blow off the shade, hitting and hurting anyone sitting near the window.

* Not available on all models

Using Automatic Climate Control

The automatic climate control system maintains the interior temperature you select. The system also selects the proper mix of heated or cooled air that raises or lowers the interior temperature to your preference as quickly as possible.

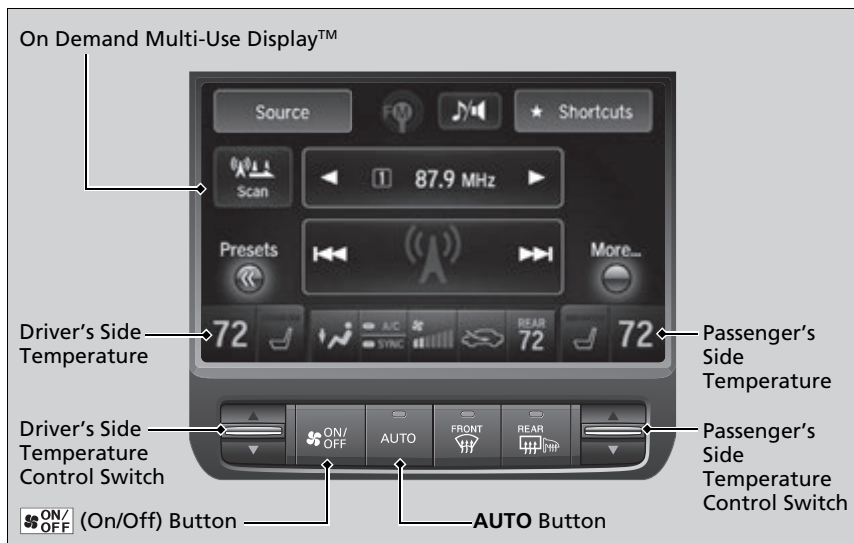

Use the system when the power system is on.

1. Press the **AUTO** button.
2. Adjust the interior temperature using the driver's side or passenger's side temperature control switch.
3. Press the **ON/OFF** (On/Off) button to cancel.

Using Automatic Climate Control

If any buttons/icons on the touch screen are pressed while using the climate control system in auto, the function of the button/icon that was pressed will take priority.

The AUTO indicator will go off, but functions unrelated to the button/icon that was pressed will be controlled automatically.

To prevent cold air from blowing in from outside, the fan may operate at low speed for a while after the **AUTO** button has been pressed.

If the interior is very warm, you can cool it down more rapidly by partially opening the windows, turning the system on auto, and setting the temperature to low. Change the fresh mode to recirculation mode until the temperature cools down.

When you set the temperature to the lower or upper limit, **Lo** or **Hi** is displayed.

Pressing the **ON/OFF** button switches the climate control system between on and off. When turned on, the system returns to your last selection.

■ Operating from the On Demand Multi-Use Display™

In addition to the button/switch controls, you can operate the climate control system from the On Demand Multi-Use Display™ touch screen.

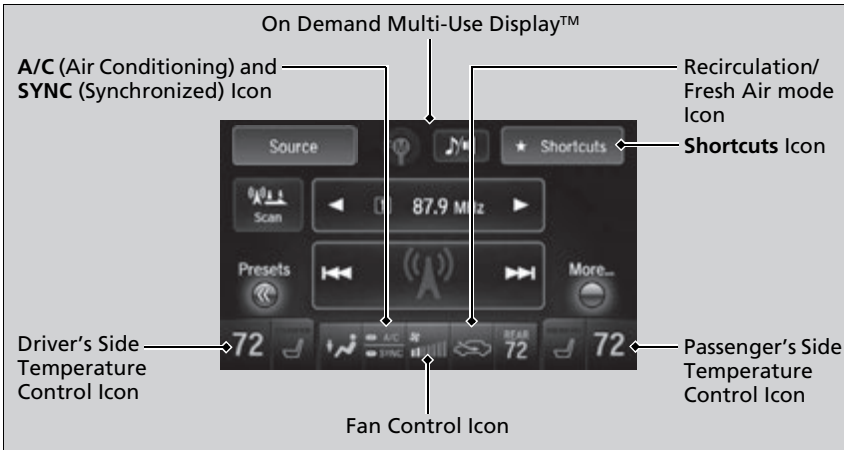

▣ Using Automatic Climate Control

When you unlock the doors with your remote, the driver's ID (**Driver 1** or **Driver 2**) is detected, and the climate control settings are turned to the respective mode automatically when you set the power mode to ON.

You can store two customized climate control settings to the system and recall them from the On Demand Multi-Use Display™.

➤ **Shortcuts** P. 220

■ Changing the Interior Temperature Setting

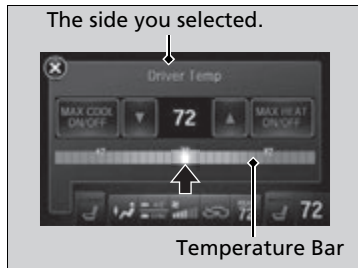

1. Select the driver's or passenger's side temperature control icon.
2. Change the temperature setting from the following:

Temperature bar: Select a point where your desired temperature setting is. Farther to the left is for a lower, and to the right for a higher setting.

▲/▼: To raise or lower the temperature setting one degree at a time. While you select and hold **▲/▼**, the temperature decreases or increases.

MAX COOL ON/OFF: To rapidly cool down the interior.

- The A/C indicator comes on. The setting returns to the previously selected value when you select it again.

MAX HEAT ON/OFF: To rapidly warm up the interior.

- The A/C indicator goes off. The setting returns to the previously selected value when you select it again.

▣ Using Automatic Climate Control

When you set the temperature to the lower or upper limit, **Lo** or **Hi** is displayed.

When you set the **MAX COOL** or **MAX HEAT**, **MAX COOL** or **MAX HEAT** is displayed.





If you select the **MAX HEAT ON/OFF** during Auto Engine Stop, the engine restarts automatically.

■ Switching the vent mode



Select a desired vent mode icon, or **Front Mode Auto**: The system automatically selects the vent mode most suitable to the ambient environment.

Vent mode

- : Dashboard vents
- : Dashboard and floor vents
- : Floor vents
- : Floor and defroster vents

■ A/C on and off



1. Select **A/C**.
2. Select **ON** or **OFF**.

▶▶ Switching the vent mode

While the climate control system is in auto, **Front Mode Auto** is highlighted.



■ SYNC on and off

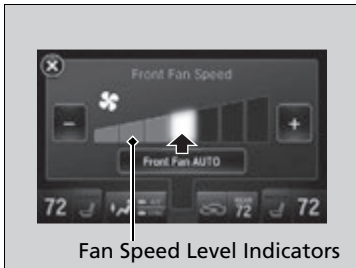

1. Select **SYNC**.
2. Select **ON** for synchronized mode.
 - When in synchronized mode, the front passenger's side temperature and the rear passenger compartment become the same as the driver's side settings.
3. Adjust the temperature or change the mode from the driver's side.

■ Changing the fan speed



1. Select .
2. Change the fan speed with one of the following:
The fan speed level indicators: Select your desired speed level. The smaller indicator is for a slower speed, and the larger for a faster speed.
/: To go up or down one level at a time.

Front Fan AUTO: The system automatically selects the fan speed most suitable to the ambient environment.

►► SYNC on and off

When you press the  button, the system synchronizes the driver's and front passenger's temperature settings.

When the system is not in SYNC mode, the driver's side temperature, the front passenger's side temperature and the rear passenger compartment (if it is on) can be set separately.



You can also turn off SYNC mode by changing the front passenger's side temperature or rear passenger's temperature.

►► Changing the fan speed

While the climate control system is in auto, **Front Fan AUTO** is highlighted.

Switching between the Recirculation and Fresh Air Modes



1. Select  or  currently shown.
2. Switch the mode depending on environmental conditions to the following:

 (Recirculation Mode): Recirculates air from the vehicle's interior through the system.

 (Fresh Air Mode): Maintains outside ventilation. Keep the system in fresh air mode in normal situations.

Shortcuts

You can store two sets of your preferred temperature, fan speed, and vent mode settings to the climate control system.



To store a set of the climate control settings:

1. Select **Shortcuts**.
2. Adjust the climate control system to your preference.
3. Select **Climate**.
4. Select **Edit**.
5. Select **Add**.
6. Select **Preset 1** or **Preset 2** you want to store your settings to.

To recall one of the settings:

1. Select **Shortcuts**.
2. Select **Climate**.
3. Select **Preset 1** or **Preset 2**.

To delete a preset:

1. Select **Shortcuts**.
2. Select **Climate**.
3. Select **Edit**.
4. Select **Delete**.
5. Select **Preset 1** or **Preset 2** you want to delete.

Shortcuts

You can also store a set by pressing and holding the preset number you want to store that setting after step 3.

Defrosting the Windshield and Windows

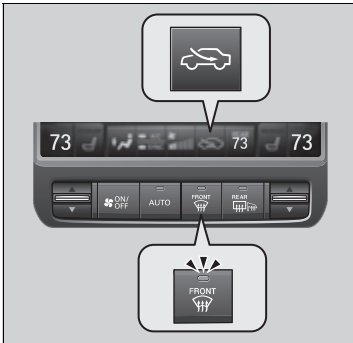

Press the  button to turn the air conditioning system on and automatically switch the system to fresh air mode.

Press the  button again to turn off, the system returns to the previous settings.

To rapidly defrost the windows

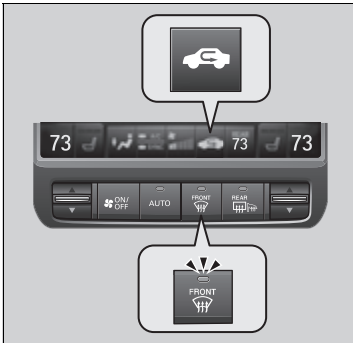

1. Press the  button.
2. Select the recirculation mode.
 - ▣ **Switching between the Recirculation and Fresh Air Modes** P. 219

Defrosting the Windshield and Windows

For your safety, make sure you have a clear view through all the windows before driving.

Do not set the temperature near the upper or lower limit.

When cold air hits the windshield, the outside of the windshield may fog up.

If the side windows fog up, adjust the vents so that the air hits the side windows.

To rapidly defrost the windows

After defrosting the windows, switch over to fresh air mode.

If you keep the system in recirculation mode, the windows may fog up from humidity. This impedes visibility.

Rear Climate Control System

■ Using the Rear Climate Control System From the Front Panel

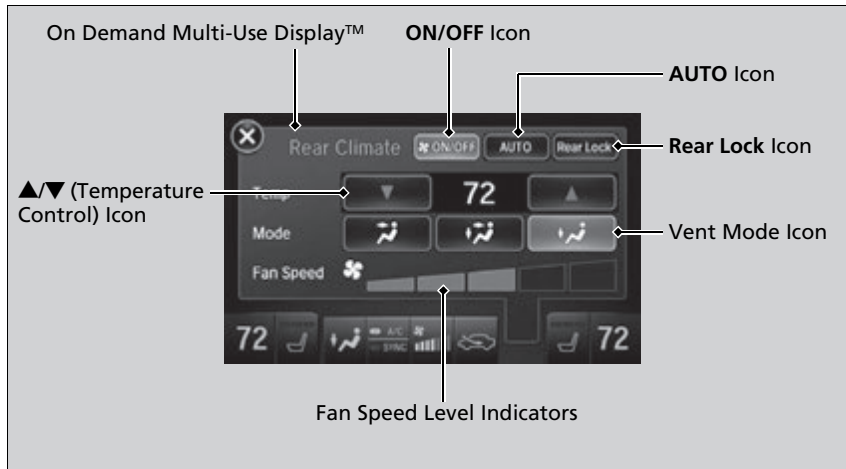

Use the system when the power system is on.

1. Select **REAR**.
2. Select **AUTO**.
 - The rear system changes to auto mode.
3. Adjust the rear passenger's compartment temperature using the temperature control icon.
4. Select the **ON/OFF** to cancel.
 - When the turned back on, the system returns to your last selection.

▣ Rear Climate Control System

If any icons on the touch screen are pressed while using the rear climate control system in auto, the function of the icon that was pressed will take priority.

Rear Lock: Appears on the front panel. When selected, it disables the rear panel control.

LOCK: Appears on the rear control panel while the rear lock is on.

If the rear lock is on while in SYNC mode, the rear control panel is disabled. **LOCK SYNC** appears on the rear control panel.

■ Changing the rear temperature setting

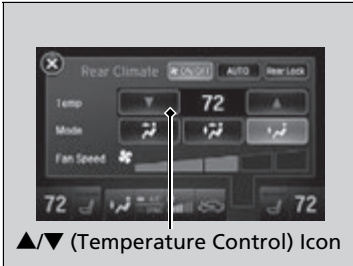

Change the temperature setting from the following:

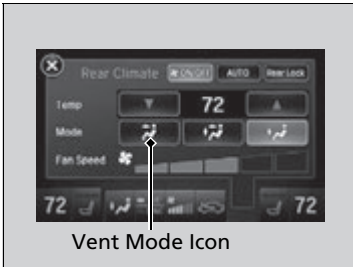

▲/▼: To raise or lower the temperature setting one degree at a time. While you select and hold ▲/▼, the temperature decreases or increases.

■ Switching the vent mode



Select a desired vent mode icon.

Vent mode

- : Rear console vents
- : Rear console vents and floor vents
- : Rear floor vents

☒ Changing the rear temperature setting

When you set the temperature to the lower or upper limit, **Lo** or **Hi** is displayed.

■ Changing the fan speed

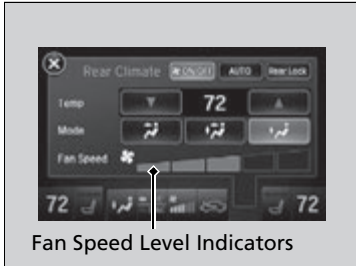

Select your desired speed level. The smaller indicator is for a slower speed, and the larger for a faster speed.

■ Using the Rear Climate Control System From the Rear Panel

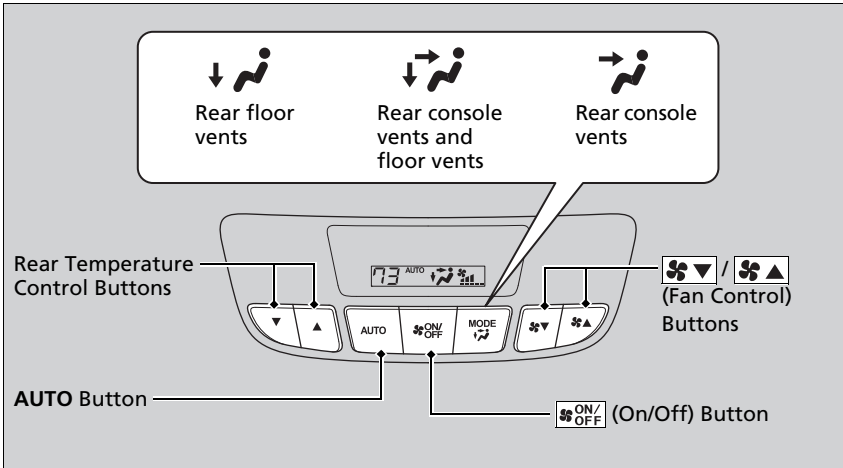

Use the system when the power system is on.

1. Press the **AUTO** button.
2. Adjust the interior temperature using the rear temperature control button.
3. To turn off the rear climate control system, press  button.

▣ Using the Rear Climate Control System From the Rear Panel

When the **Rear Lock** icon on the front control panel is off, the temperature of the rear passenger compartment can be controlled independently.

Automatic Climate Control Sensors

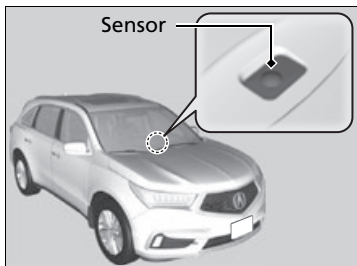

The automatic climate control system is equipped with sensors. Do not cover or spill any liquid on them.

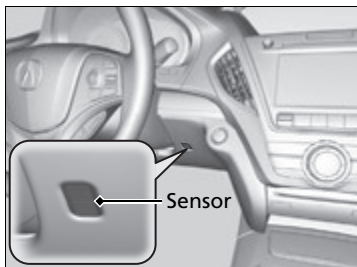

Features

This chapter describes how to operate technology features.



Audio System

About Your Audio System 228

About Your Audio System

See the Navigation System Manual for operation of the audio system, customized features, rear entertainment system*, *Bluetooth*® HandsFreeLink®, voice commands, multi-view rear camera system*, surround view camera system*, and HomeLink® Universal Transceiver.

Driving



This chapter discusses driving and refueling.

Before Driving	230
Towing a Trailer	236
Off-Highway Driving Guidelines	237
When Driving	
Turning on the Power	239
Dual Clutch Transmission	246
Shifting	247
Acoustic Vehicle Alerting System.....	255
Integrated Dynamics System.....	256
Front Sensor Camera	257
Adaptive Cruise Control (ACC) with Low Speed Follow (LSF)	259
Road Departure Mitigation (RDM) System ...	274
Lane Keeping Assist System (LKAS)...	279

Vehicle Stability Assist (VSA®), aka Electronic Stability Control (ESC), System	287
Agile Handling Assist	289
SPORT HYBRID Super Handling-All Wheel Drive™ (SPORT HYBRID SH-AWD®) ..	290
Blind spot information (BSI) System ..	291
Tire Pressure Monitoring System (TPMS) with Tire Fill Assist	294
Tire Pressure Monitoring System (TPMS) - Required Federal Explanation.....	296
High Voltage Battery.....	298
Braking	
Brake System	299
Anti-lock Brake System (ABS)	305

Brake Assist System	306
Collision Mitigation Braking System™ (CMBS™)	307
Parking Your Vehicle	
When Stopped	316
Parking Sensor System*	318
Cross Traffic Monitor	322
Multi-View Rear Camera	326
Refueling	
Fuel Information	327
How to Refuel	328
Fuel Economy and CO₂ Emissions	330

* Not available on all models

Driving Preparation

Check the following items before you start driving.

Exterior Checks

- Make sure there are no obstructions on the windows, door mirrors, exterior lights, or other parts of the vehicle.
 - ▶ Remove any frost, snow, or ice.
 - ▶ Remove any snow on the roof, as this can slip down and obstruct your field of vision while driving. If frozen solid, remove ice once it has softened.
 - ▶ When removing ice from around the wheels, be sure not to damage the wheel or wheel components.
- Make sure the hood is securely closed.
 - ▶ If the hood opens while driving, your front view will be blocked.
- Make sure the tires are in good condition.
 - ▶ Check air pressures, and check for damage and excessive wear.
 - ✦ **Checking and Maintaining Tires** P. 361
- Make sure there are no people or objects behind or around the vehicle.
 - ▶ There are blind spots from the inside.

Exterior Checks

NOTICE

When doors are frozen shut, use warm water around the door edges to melt any ice. Do not try to force them open, as this can damage the rubber trim around the doors. When done, wipe dry to avoid further freezing.

Do not pour warm water into the key cylinder. You will be unable to insert the key if the water freezes in the hole.

Heat from the engine and exhaust can ignite flammable materials left under the hood, causing a fire. If you've parked your vehicle for an extended period, inspect and remove any debris that may have collected, such as dried grass and leaves that have fallen or have been carried in for use as a nest by a small animal. Also check under the hood for leftover flammable materials after you or someone else has performed maintenance on your vehicle.

Interior Checks

- Store or secure all items on board properly.
 - ▶ Carrying too much cargo, or improperly storing it, can affect your vehicle's handling, stability, stopping distance, and tires, and make it unsafe.
 - ✦ **Maximum Load Limit** P. 233
- Do not pile items higher than the seat height.
 - ▶ They can block your view and may be thrown forward in the event of sudden braking.
- Do not place anything in the front seat footwells. Make sure to secure the floor mat.
 - ▶ An object or unsecured floor mat can interfere with your brake and accelerator pedal operation while driving.
- If you have any animals on board, do not let them move around in the vehicle.
 - ▶ They may interfere with driving and a crash could occur.
- Securely close and lock all doors and the tailgate.
 - ✦ **Locking/Unlocking the Doors from the Inside** P. 147
- Adjust your seating position properly.
 - ▶ Adjust the head restraint, too.
 - ✦ **Adjusting the Seats** P. 187
 - ✦ **Adjusting the Front and Second Row Outer Head Restraint Positions** P. 193
- Adjust the mirrors and steering wheel properly for your driving.
 - ▶ Adjust them while sitting in the proper driving position.
 - ✦ **Adjusting the Steering Wheel** P. 183
 - ✦ **Adjusting the Mirrors** P. 184

Interior Checks

The headlight aim is set by the factory, and does not need to be adjusted. However, if you regularly carry heavy items in the cargo area, have the aiming readjusted at a dealer or by a qualified technician.

- Be sure items placed on the floor behind the front seats cannot roll under the seats.
 - ▶ They can interfere with the driver's ability to operate the pedals, the operation of the seats, or the operation of the sensors under the seats.
- Everyone in the vehicle must fasten their seat belt.
 - 📄 **Fastening a Seat Belt** P. 40
- Make sure that the indicators in the instrument panel come on when you start the vehicle, and go off soon after.
 - ▶ Always have a dealer check the vehicle if a problem is indicated.
 - 📄 **Indicators** P. 78

Maximum Load Limit

Models with bench seat

The maximum load for your vehicle is 1,173 lbs (532 kg).

Models with captain seat

The maximum load for your vehicle is 1,005 lbs (456 kg).

See the Tire and Loading Information label attached to the driver's doorjamb.

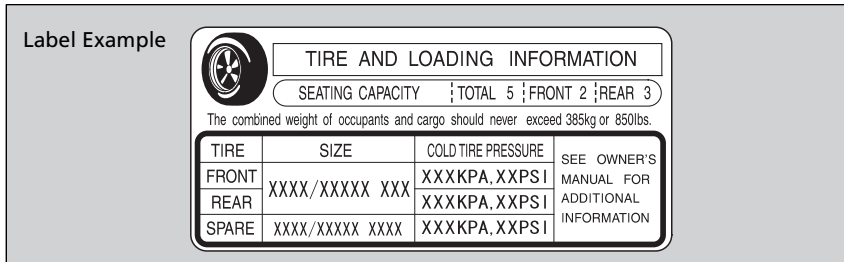

This figure includes the total weight of all occupants, cargo, and accessories, and the tongue load if you are towing a trailer.

Steps for Determining Correct Load Limit -

- (1) Locate the statement "The combined weight of occupants and cargo should never exceed XXX kg or XXX lbs." on your vehicle's placard.
- (2) Determine the combined weight of the driver and passengers that will be riding in your vehicle.
- (3) Subtract the combined weight of the driver and passengers from XXX kg or XXX lbs.

Continued

Maximum Load Limit

⚠ WARNING

Overloading or improper loading can affect handling and stability and cause a crash in which you can be hurt or killed.

Follow all load limits and other loading guidelines in this manual.

Gross Vehicle Weight Rating (GVWR):

The maximum allowable weight of the vehicle, all occupants, all accessories, all cargo.

➤ Specifications P. 432

Gross Axle Weight Rating (GAWR):







The maximum allowable weight of the vehicle axle.

➤ Specifications P. 432

- (4)** The resulting figure equals the available amount of cargo and luggage load capacity. For example, if the “XXX” amount equals 1,400 lbs. and there will be five 150 lb. passengers in your vehicle, the amount of available cargo and luggage load capacity is 650 lbs.
(1,400 - 750 (5 x 150) = 650 lbs.)
- (5)** Determine the combined weight of luggage and cargo being loaded on the vehicle. That weight may not safely exceed the available cargo and luggage load capacity calculated in step 4.
- (6)** If your vehicle will be towing a trailer, load from your trailer will be transferred to your vehicle. Consult this manual to determine how this reduces the available cargo and luggage load capacity of your vehicle.

In addition, the total weight of the vehicle, all occupants, accessories, cargo, and trailer tongue load must not exceed the Gross Vehicle Weight Rating (GVWR) or the Gross Axle Weight Rating (GAWR). Both are on a label on the driver's doorjamb.

Load Limits Example

Example1		\geq		+	
	<p>Max Load 1,173 lbs (532 kg)</p>		<p>Passenger Weight 150 lbs x 2 = 300 lbs (68 kg x 2 = 136 kg)</p>		<p>Cargo Weight 873 lbs (396 kg)</p>
Example2		\geq		+	
	<p>Max Load 1,173 lbs (532 kg)</p>		<p>Passenger Weight 150 lbs x 5 = 750 lbs (68 kg x 5 = 340 kg)</p>		<p>Cargo Weight 423 lbs (192 kg)</p>

Your vehicle is not designed to tow a trailer. Attempting to do so can void your warranties.

Towing Your Vehicle

Your vehicle is not designed to be towed behind a motor home. If your vehicle needs to be towed in an emergency, refer to the emergency towing information.

➤ **Emergency Towing** P. 427

General Information

Your vehicle has been designed primarily for use on pavement, however, its higher ground clearance allows you to occasionally travel on unpaved roads. It is not designed for trail-blazing, or other challenging off-road activities.

If you decide to drive on unpaved roads, you will find that it requires somewhat different driving skills and that your vehicle will handle somewhat differently than it does on pavement. Pay attention to the precautions and tips in this section, and get acquainted with your vehicle before leaving the pavement.

Important Safety Precautions

To avoid loss of control or rollover, be sure to follow all precautions and recommendations:

- Be sure to store cargo properly and do not exceed your cargo load limits.
 - **Maximum Load Limit** P. 233
- Whenever you drive, make sure you and your passengers always wear seat belts.
- Keep your speed low, and never go faster than the conditions allow.
- It's up to you to continually assess the situation and drive within the limits.

Off-Highway Driving Guidelines

⚠ WARNING

Improperly operating this vehicle on or the off pavement can cause a crash or rollover in which you and your passengers could be seriously injured or killed.

- Follow all instructions and guidelines in this owner's manual.
- Keep your speed low, and don't drive faster than conditions permit.

Failure to operate your vehicle correctly might result in a crash or a rollover.

- **Important Handling Information** P. 34
- **Precautions While Driving** P. 245

Spinning the tires can also damage the SPORT HYBRID Super Handling-All Wheel Drive™ system.

Avoiding Trouble

- **Check Out Your Vehicle** before you leave the pavement and make sure that all scheduled maintenance has been completed. Pay special attention to the condition of the tires, and check the tire pressures.
- **Remember** the route you choose presents limits (too steep or bumpy), you have limits (driving skill and comfort), and your vehicle has limits (traction, stability, and power). Failing to recognize these limits will likely put you and your passengers in a hazardous situation.
- **Accelerating and Braking** should be done slowly and gradually. Trying to start or stop too fast can cause a loss of traction and you could lose control.
- **Avoiding Obstacles and Debris** in the road reduces the likelihood of a rollover or damage to your suspension or other components.
- **Driving on Slopes** increases your risk of a rollover, particularly if you attempt to drive across a slope that is too steep. Going straight up or down a slope is usually the safest. If you can't clearly see all conditions or obstacles on a slope, walk it before you drive it. If there is any doubt whether you can safely pass, don't try it. Find another route. If you get stuck when climbing, do not try to turn around. Back down slowly following the same route you took up the hill.
- **Crossing a Stream** - Avoid driving through deep water. If you encounter water in your route (a small stream or large puddle, for example), evaluate it carefully before going ahead. Make sure it is shallow, flowing slowly, and has firm ground underneath. If you are not sure of the depth or the ground, turn around and find another route. Driving through deep water can also damage your vehicle. The water can get into the transmission and differential, diluting the lubricant and causing an eventual failure. It can also wash the grease out of the wheel bearings.
- **If You Get Stuck**, carefully go in the direction that you think will get you unstuck. Do not spin the tires as this will only make things worse and could damage the transmission. If you are unable to free yourself, your vehicle will need to be towed. Front and rear tow hooks are provided for this purpose.

Turning on the Power

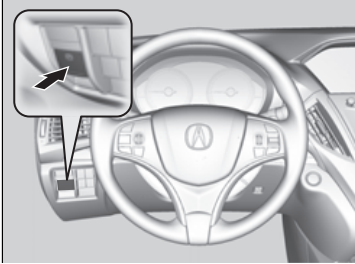

1. Make sure the parking brake is applied.
 - ▶ The electric parking brake indicator comes on for 15 seconds when you press the electric parking brake switch.

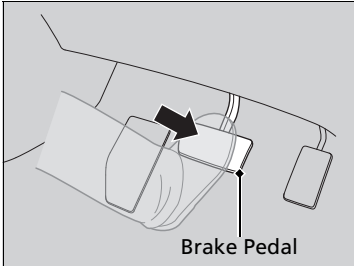

2. Depress the brake pedal.
 - ▶ Make sure the transmission is in **P**.

Turning on the Power

Keep your foot firmly on the brake pedal when starting the power system. The engine is harder to start in cold weather and in thinner air found at altitudes above 8,000 feet (2,400 meters).

When turning on the power system in cold weather, turn off all electrical accessories such as the lights, climate control system, and rear defogger in order to reduce 12-volt battery drain.

If you live in a region where winter is extremely cold, an engine block heater and transmission clutch actuator heater will improve starting and warming of the engine. Consult a dealer for details.

If the exhaust system sounds abnormal or you can smell exhaust gas inside the vehicle, have your vehicle checked by a dealer. There may be a problem with the engine or exhaust system.

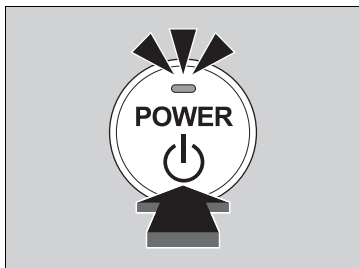

3. Press the **POWER** button without depressing the accelerator pedal.
 - ▶ The **Ready To Drive** message appears on the multi-information display (MID).
 - ▶ If the High Voltage battery is fully charged, the gasoline engine may not start.
 - ▶ If the High Voltage battery charge level is low, the gasoline engine starts.
 - ▶ When the ambient temperature is extremely low, the vehicle does not move until certain conditions are met. A warning message appears instead of **Ready To Drive**.

➤ **Multi-Information Display (MID)**
Warning and Information Messages
P. 99

Stopping the Power System

You can turn the power system off when the vehicle is completely stopped.

1. Select **P**.
2. Press and hold the **POWER** button.

Turning on the Power

Bring the keyless access remote close to the **POWER** button if the battery in the keyless access remote is weak.

➤ **If the Keyless Access Remote Battery is Weak** P. 405

The power system may not activate if the keyless access remote is subjected to strong radio waves. Do not hold the **POWER** button to start the power system.

If the power system does not start, wait at least 30 seconds before trying again.

The immobilizer system protects your vehicle from theft.

If an improperly coded key (or other device) is used, the power system does not activate.

➤ **Immobilizer System** P. 158



When you turn the power system on, you may feel the brake pedal slightly sink down. This is normal.

Remote Engine Start with Vehicle Feedback

You can remotely turn the power system on using the two-way keyless access remote from extended distances.

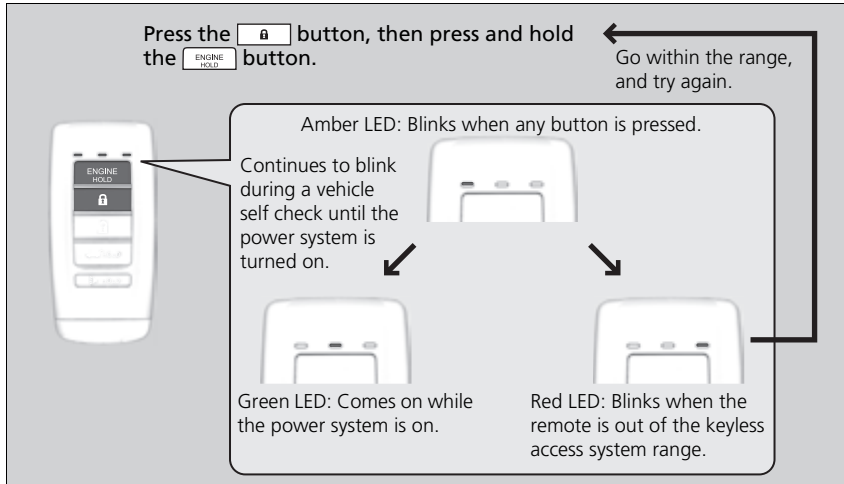
To turn the power system on



The power system is on for up to 10 minutes without you starting the vehicle. To extend the time for another 10 minutes during the first 10 minutes, press the  button, then press and hold the  button.

- ▶ The amber LED blinks, then the green LED comes back on if a 10-minute extension request was transmitted successfully.

After pressing the (lock) button, wait for the green LED to blink. This indicates that the all the doors and the tailgate are locked.

Remote Engine Start with Vehicle Feedback

WARNING: Carbon monoxide gas is toxic and can rapidly accumulate in closed or even partly enclosed areas. Breathing it can cause unconsciousness and even kill you. Never use the remote engine starter with the vehicle parked in a garage or other areas with limited ventilation.

Remote Engine Start run timer extension

The power system is on for another 10 minutes from the time of extension request. The max time is 20 minutes, if the extension request is made after 10 minutes of first 10 minutes.

The vehicle may start in EV mode depending on High Voltage battery conditions.

- ▶ If the High Voltage battery is fully charged, the gasoline engine may not start.
- ▶ If the High Voltage battery charge level is low, the gasoline engine starts.

■ To turn the power system off

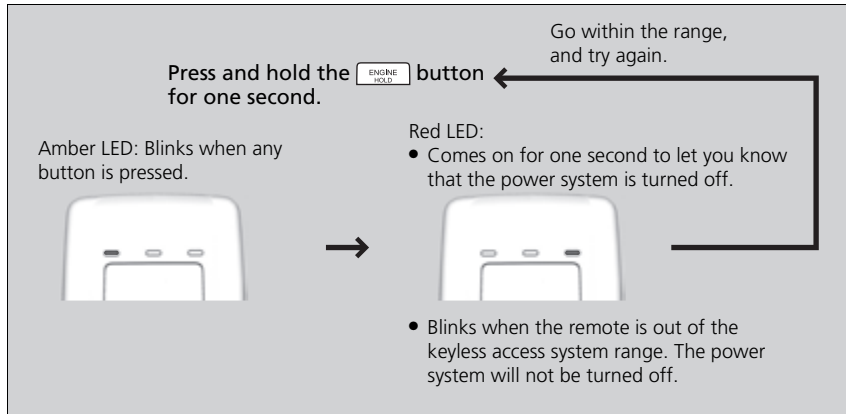

⊠ Remote Engine Start with Vehicle Feedback

If there are buildings and obstacles between your vehicle and the remote, the range will be reduced. This distance may vary by external electrical interference.

The power system may not be turned on by the remote engine start if:

- You have disabled a remote engine start setting using the multi-information display (MID).
- The power mode is not in VEHICLE OFF (LOCK).
- The gear is in a position other than **P**.
- The hood is open, or any door or the tailgate is unlocked.
- You have already used the remote twice to turn the power system on.
- Another registered keyless access remote is in the vehicle.
- There is any antenna failure.
- Door is unlocked with the built-in key.
- The engine oil pressure is low.
- The engine coolant temperature is extremely high.
- The telematics unit malfunctions.
- The security system alarm is not set.

Before turning the power system on, make sure to check the door lock status using the remote. When you press the **LOCK** button, wait for the green LED to blink. If the red LED turns on, the doors and tailgate did not lock, and the power system is not turned on.

▶▶ Remote Engine Start with Vehicle Feedback

While the power system is on, the vehicle will automatically precondition inside the vehicle.

When it is warm outside:

- The air conditioning is activated in recirculation mode.
- The seat ventilation is activated*.

When it is cold outside:

- The defroster is activated at a moderately warm temperature.
- The rear defogger and door mirror heaters are activated.
- The seat heaters and heated steering wheel are activated*.

▶▶ Heated Steering Wheel* P. 211

▶▶ Front Seat Heaters and Seat Ventilation* P. 212, 213

* Not available on all models

■ Starting to Drive

When the power system was started using the two-way keyless access remote

1. Depress the brake pedal and press the **POWER** button simultaneously.

When the power system was started in any case

2. Keeping your right foot on the brake pedal, press the **[D/S]** button. Select **[R]** when reversing.
3. With the parking brake applied, release the brake pedal and gently depress the accelerator pedal.
 - ▶ Make sure the electric parking brake indicator goes off.
 - **Parking Brake** P. 299
 - **If the Transmission System Indicator Blinks along with the Warning Message** P. 416

■ Hill start assist system

Hill start assist keeps the brake engaged briefly to help prevent the vehicle from rolling on inclines as you move your foot from the brake pedal to the accelerator.

Change the gear position to **[D]** or **[S]** when facing uphill, or **[R]** when facing downhill, then release the brake pedal.

▶▶ Starting to Drive

When the power system was started using the two-way keyless access remote

The power system is turned off when the gear position is changed from **[P]** before the **POWER** button is pressed. Follow the step 1 when starting to drive.

You can also release the parking brake by pulling the electric parking brake switch while depressing the brake pedal.

When facing downhill, you can start your vehicle more smoothly by manually releasing it with the electric parking brake switch than by releasing it with the accelerator pedal.

▶▶ Hill start assist system

Hill start assist may not prevent the vehicle from rolling downhill on a very steep or slippery slope, and will not operate on small inclines.

Hill start assist is not a replacement for the parking brake.

Precautions While Driving

■ Driving Guidelines for Your Utility Vehicle

Utility vehicles have a significantly higher rollover rate than other types of vehicles. To prevent rollovers or loss of control:

- Take corners at slower speeds than you would with a passenger vehicle.
- Avoid sharp turns and abrupt maneuvers whenever possible.
- Do not modify your vehicle in any way that you would raise the center of gravity.
- Do not carry heavy cargo on the roof.

Never carry more than 165 lbs (75 kg) of cargo on the roof rack (Acura accessory).

■ In Rain

Avoid driving in deep water and on flooded roads. This can damage the engine, driveline, or cause electrical component failure.

■ Other Precautions

If there is a strong impact with something under the vehicle, stop in a safe location. Check the underside of the vehicle for damage or any fluid leaks.

▣ Precautions While Driving

NOTICE

Do not select a shift button while pressing the accelerator pedal. You could damage the transmission.

NOTICE

If you repeatedly turn the steering wheel at an extremely low speed, or hold the steering wheel in the full left or right position for a while, the electric power steering (EPS) system heats up. The system goes into a protective mode, and limits its performance. The steering wheel becomes harder and harder to operate. Once the system cools down, the EPS system is restored. Repeated operation under these conditions can eventually damage the system.

If the power mode is set to ACCESSORY while driving, the power system will shut down and all steering and brake power assist functions will stop, making it difficult to control the vehicle.

Do not press the **[N]** button, as you will lose regenerative braking (and acceleration) performance.

During the first 600 miles (1,000 km) of operation, avoid sudden acceleration or full throttle operation so as not to damage the engine or powertrain.

Avoid hard braking for the first 200 miles (300 km). You should also follow this when the brake pads are replaced.

Dual Clutch Transmission

■ Creeping

As with a conventional gasoline-powered vehicle with an automatic transmission, this vehicle will creep.

Keep the brake pedal firmly depressed when stopped.

■ Kickdown

Quickly depressing the accelerator pedal while driving uphill may cause the transmission to drop to a lower gear, unexpectedly increasing vehicle speed. Depress the accelerator pedal carefully, especially on slippery roads and curves.

▶▶ Driving Guidelines for Your Utility Vehicle

Failure to operate your vehicle correctly might result in a crash or a rollover.

- ▶ **Important Handling Information** P. 34
- ▶ **Precautions While Driving** P. 245

Shifting

Change the gear position in accordance with your driving needs.

■ Shift button positions



- P** **Park**
Used when parking or starting the power system
- R** **Reverse**
Used when reversing
- N** **Neutral**
Used when idling
- D** **Drive**
Used for:
- Normal driving (gears change between 1st and 7th automatically)
 - Temporarily driving in the sequential mode
- S** **Drive (S)**
Used for:
- Automatically changing gears between 1st and 6th (6th gear is used only at high speed)
 - Driving in the sequential mode

▶ Shifting

To prevent malfunction and unintended engagement:

- Do not spill any liquids on or around shift buttons.
- Do not place or drop any objects on or around shift buttons.
- Do not let passengers or children operate the shift buttons.

You may occasionally find that it takes longer than usual for the vehicle to start moving when you select **[R]**, release the brake pedal, and/or depress the accelerator pedal. This may occur when the High Voltage battery level is extremely low, and does not indicate a vehicle malfunction.

⚠ WARNING

The vehicle can roll away if left unattended without confirming that Park is engaged.

Always keep your foot on the brake pedal until you have confirmed that **[P]** is shown on the gear position Indicator.

■ **P (park) button**

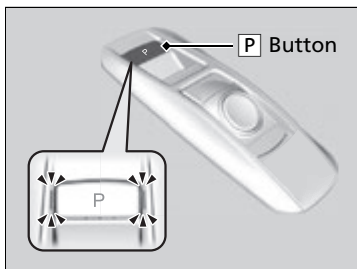

The gear position changes to **P** when you press the **P** button while the vehicle is parked with the power mode in ON. The indicators on the sides of the **P** button come on.

▶ Shifting

When shifting gears in extremely low temperatures (–22°F/–30°C), there may be a short delay before the shift is indicated in the display. Always confirm you are in the correct gear before driving.

Shift Operation

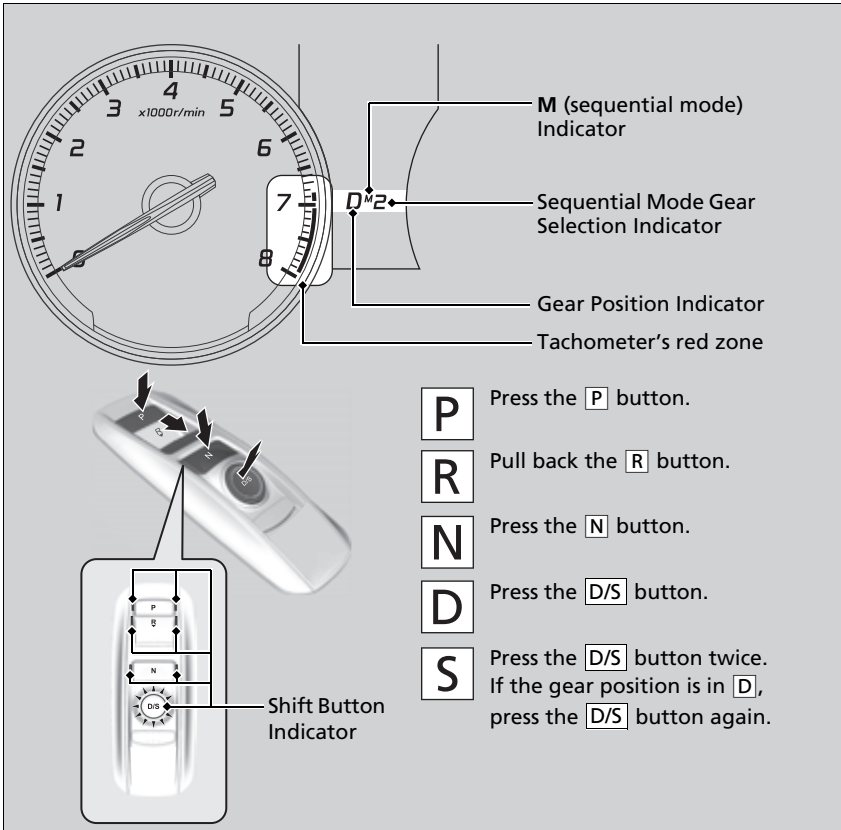

Continued

Shift Operation

NOTICE

When you change **D** to **R** and vice versa, come to a complete stop and keep the brake pedal depressed. Operating the shift button before the vehicle has come to a complete standstill can damage the transmission.

Use the gear position indicator and the shift button indicator to check the gear position before selecting a shift button.

If the indicator of the currently selected gear position, or all the gear position indicators are blinking simultaneously, there is a problem with the transmission.

Avoid sudden acceleration and have the transmission checked by a dealer as soon as possible.

The fuel supply may be cut off if you drive at engine speeds in or over the tachometer's red zone (engine speed limit). If this happens, you may experience a slight jolt.

When the engine speed is increased while the transmission is in **N**, **P** or **R**, the fuel supply may be cut off even without the engine speed entering the tachometer's red zone.

The beeper sounds once when you change to **R**.

In freezing or sub-freezing conditions, the gear selection response may be slow. Always depress the brake pedal before changing the gear position to **P**, and confirm that **P** is shown on the gear position indicator before releasing the brake.

■ When opening the driver's door

If you open the driver's door under the following conditions, the gear position automatically changes to **P**.

- The vehicle is in stationary with the power mode in ON, or moving at 1 mph (2 km/h) or slower.
- The transmission is in other than **P**.
- You have unfastened the driver side seat belt.

▶ If you manually change the gear position from **P** with the brake pedal depressed, the gear position will automatically return to **P** once you release the brake pedal.

■ When turning off the power mode

If you turn the power system off while the vehicle is stationary, and the transmission is in other than **P**, the gear position automatically changes to **P**.

⌘ When opening the driver's door

While the system is designed to automatically change the gear position to **P** under the described conditions, in the interest of safety you should always select **P** before opening the driver's door. Make sure to park the vehicle in a safe place.

⚠ When Stopped P. 316

If you want to drive the vehicle after the gear position has automatically changed to **P** under the described conditions, close the door, fasten the seat belt, depress the brake pedal, then change the gear position.

If you leave the vehicle, turn off the power system and lock the doors.

■ If you want to keep the transmission in **N** position [car wash mode]

With the **READY** indicator on:

1. Press and hold the brake pedal.
2. Select **N**, then release the button to display **N** (Neutral) hold mode on the MID.
3. Press and hold **N** again for two seconds.
 - ▶ This puts the vehicle in car wash mode which must be used when your vehicle is pulled through a conveyor type automatic car wash where you or an attendant do not remain in the vehicle.

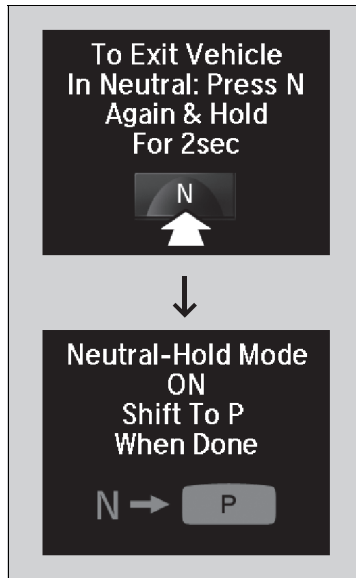

If the **POWER** button is pressed after car wash mode has been activated, the power mode will change to ACCESSORY and a message will be displayed on the MID.

- ▶ For 15 minutes the gear position remains in **N** with the power mode in ACCESSORY. After that, the position automatically changes to **P** and the power mode changes to OFF.
- ▶ Manually changing to **P** cancels ACCESSORY mode. The **P** indicator comes on and the power mode changes to OFF. You must always shift to **P** when car wash mode is no longer needed.

ⓘ If you want to keep the transmission in **N** position [car wash mode]

The transmission may not stay in **N** position while the following indicators are on or when the message below appears:

- Malfunction indicator lamp
- Transmission system indicator
- **POWER SYSTEM** indicator
- 12-Volt battery charging system indicator
- The **Charging System Problem** message on the MID.

Continued

■ Restriction on selecting a gear position

You cannot select a gear position under certain circumstances that may lead to a crash.

When the transmission is in:	1. Under the circumstances of that:	2. You cannot select:	3. The gear position remains in/changes to:	How to change the gear position
P	The brake pedal is not depressed. The accelerator pedal is depressed.	Other gear position	P	Release the accelerator pedal and depress the brake pedal.
N	The vehicle is moving at low speed without the brake pedal depressed. The vehicle is moving at low speed with the accelerator pedal depressed.		N	
N, D or S	The vehicle is moving forward.	R	P or N	Stop your vehicle in a safe place, depress the brake pedal, and select the appropriate gear position.
R or N	The vehicle is moving backward.	D, S		
R, N, D or S	The vehicle is moving.	P		
P or N	The READY indicator is not on.	A gear position other than P or N	P or N	Make sure that the READY indicator comes on.

Sequential Mode

Use the paddle shifters to change between 1st and 7th gears without removing your hands from the steering wheel. The transmission will switch to the sequential mode.

■ When the transmission is in **D**:

The vehicle will go into the sequential mode momentarily, and the sequential mode gear selection indicator will come on.

Once you start traveling at a constant speed, the sequential mode will automatically switch off, and the sequential mode gear selection indicator will go off.

Hold the **+** paddle shifter for two seconds or push the **D/S** button to return to normal drive.

■ When the transmission is in **S**

The vehicle will go into the sequential mode, and the **M** (sequential mode) indicator and sequential mode gear selection indicator will come on.

If the vehicle speed increases and the engine speed reaches near the tachometer's red zone, the transmission automatically shifts up to the next gear.

You can cancel this mode by holding the **+** paddle shifter for two seconds or push the **D/S** button. When the sequential mode is canceled, the sequential mode indicator and sequential mode gear selection indicator go off.

Sequential Mode

The vehicle is engine operated when SPORT+ mode is on.

Sequential Mode Operation

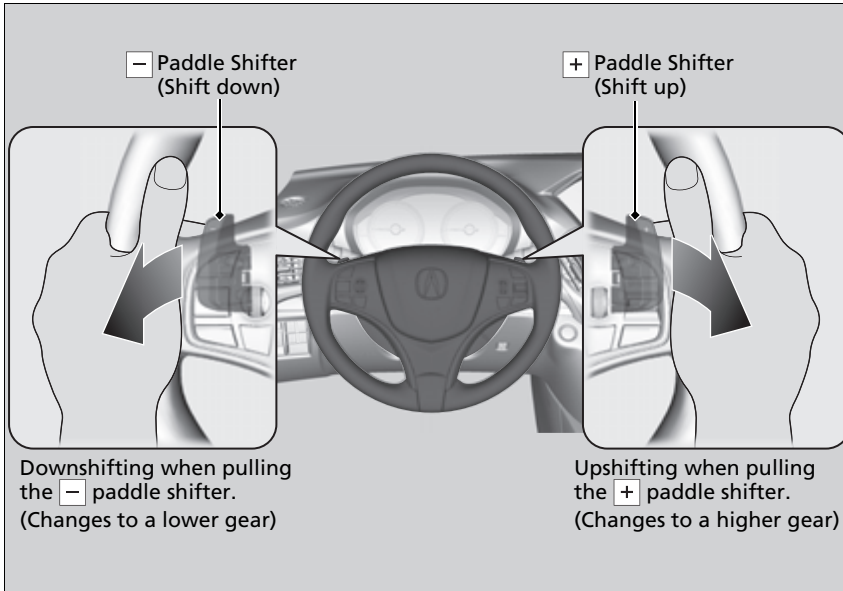

Sequential Mode Operation

Each paddle shift operation makes a single gear change.
To change gears continuously, release the paddle shifter before pulling it again for the next gear.

If the sequential mode gear selection indicator blinks when you try to shift up or down, this means your vehicle speed is not in its allowable gear range. Slightly accelerate to shift up and decelerate to shift down while the indicator is blinking.

In S range and SPORT+ mode, to prioritize the engine performance enhancement, the transmission may not allow for shifting up while the engine speed is low.

Acoustic Vehicle Alerting System

Alerts pedestrians when a vehicle is propelled solely by electricity, approaching at speeds around 12 mph (20 km/h) or less.

Integrated Dynamics System

Modifies the dynamic character of the vehicle. There are four modes to select from: **Comfort**, **Normal**, **Sport**, and **Sport+**. Press the **Dynamic Mode** button to select a mode. The mode you have selected appears on the MID. You can customize the mode default setting using the MID.

📄 **Customized Features** P. 125

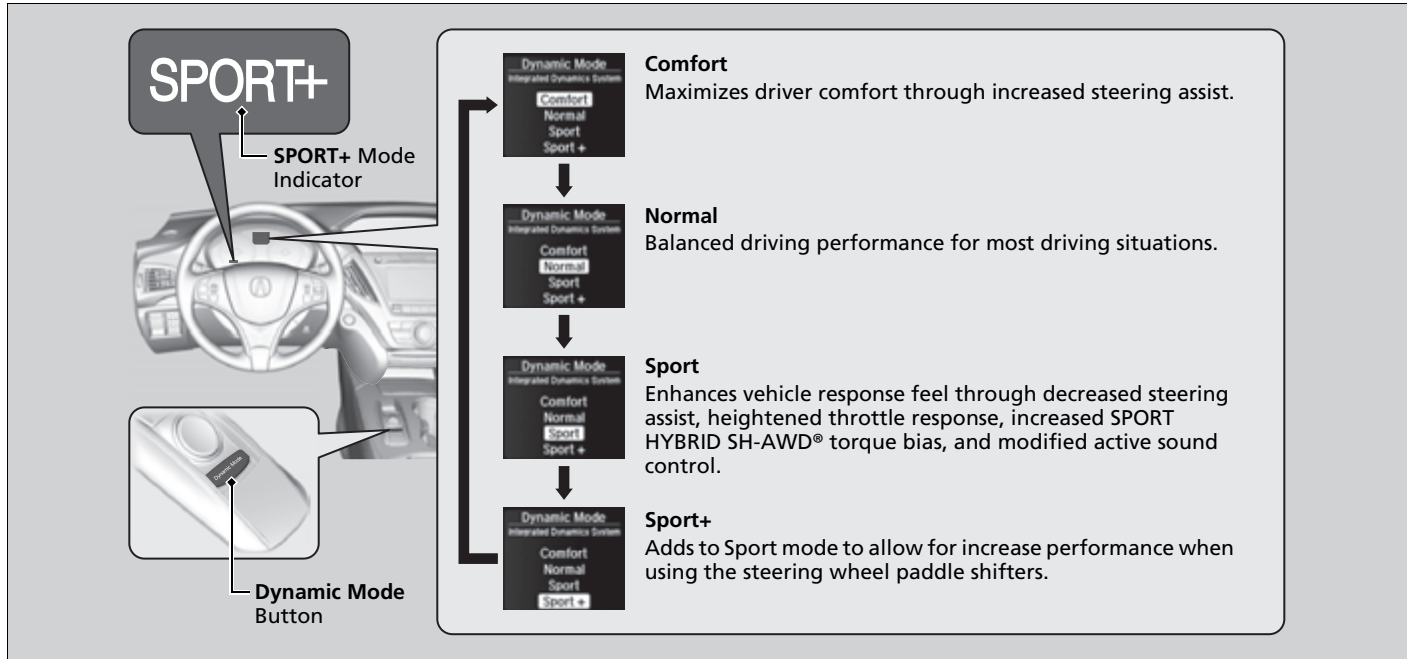

When you restart the power system with **Sport+** mode, the mode is changed to **Sport** automatically.

Front Sensor Camera

The camera, used in systems such as LKAS, RDM, ACC with LSF, and CMBS™, auto high-beam, is designed to detect an object that triggers any of the systems to operate its functions.

Camera Location and Handling Tips

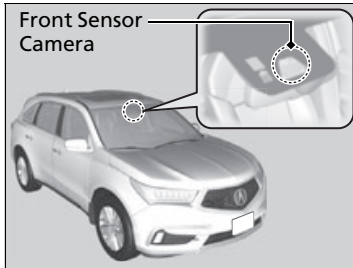

This camera is located behind the rearview mirror.

To help reduce the likelihood that high interior temperatures will cause the camera's sensing system to shut off, when parking, find a shady area or face the front of the vehicle away from the sun. If you use a reflective sun shade, do not allow it to cover the camera housing. Covering the camera can concentrate heat on it.

Front Sensor Camera

Never apply a film or attach any objects to the windshield, the hood, or the front grill that could obstruct the camera's field of vision and cause the system to operate abnormally.

Scratches, nicks, and other damage to the windshield within the camera's field of vision can cause the system to operate abnormally. If this occurs, we recommend that you replace the windshield with a genuine Acura replacement windshield. Making even minor repairs within the camera's field of vision or installing an aftermarket replacement windshield may also cause the system to operate abnormally. After replacing the windshield, have a dealer recalibrate the camera. Proper calibration of the camera is necessary for the system to operate properly.

Do not place an object on the top of the instrument panel. It may reflect onto the windshield and prevent the system from detecting lane lines properly.

📷 Front Sensor Camera

If the **Some Driver Assist Systems Cannot Operate: Camera Temperature Too High** message appears:

- Use the climate control system to cool down the interior and, if necessary, also use defroster mode with the airflow directed towards the camera.
- Start driving the vehicle to lower the windshield temperature, which cools down the area around the camera.

If the **Some Driver Assist Systems Cannot Operate: Clean Front Windshield** message appears:

- Park your vehicle in a safe place, and clean the windshield. If the message does not disappear after you have cleaned the windshield and driven for a while, have your vehicle checked by a dealer.

Adaptive Cruise Control (ACC) with Low Speed Follow (LSF)

Helps maintain a constant vehicle speed and a set following-interval behind a vehicle detected ahead of yours and, if the detected vehicle slows to a stop, decelerates and stops your vehicle, without you having to keep your foot on the brake or the accelerator.

When ACC with LSF slows your vehicle by applying the brakes, your vehicle's brake lights will illuminate.

When to use

The camera is located behind the rearview mirror.



The radar sensor is in the front grille.

- Vehicle speed for ACC with LSF: A vehicle is detected ahead within ACC with LSF range – ACC with LSF operates at speeds up to 90 mph (145 km/h).
No vehicle is detected within ACC with LSF range – ACC with LSF operates at the speed of about 25 mph (40 km/h) or above.
- Gear position for ACC with LSF: In **D** or **S**.

Adaptive Cruise Control (ACC) with Low Speed Follow (LSF)

⚠ WARNING

Improper use of ACC with LSF can lead to a crash.

Use ACC with LSF only when driving on expressways or freeways and in good weather conditions.

⚠ WARNING

ACC with LSF has limited braking capability and may not stop your vehicle in time to avoid a collision with a vehicle that quickly stops in front of you.

Always be prepared to apply the brake pedal if the conditions require.

Important Reminder

As with any system, there are limits to ACC with LSF. Use the brake pedal whenever necessary, and always keep a safe interval between your vehicle and other vehicles.

■ How to activate the system

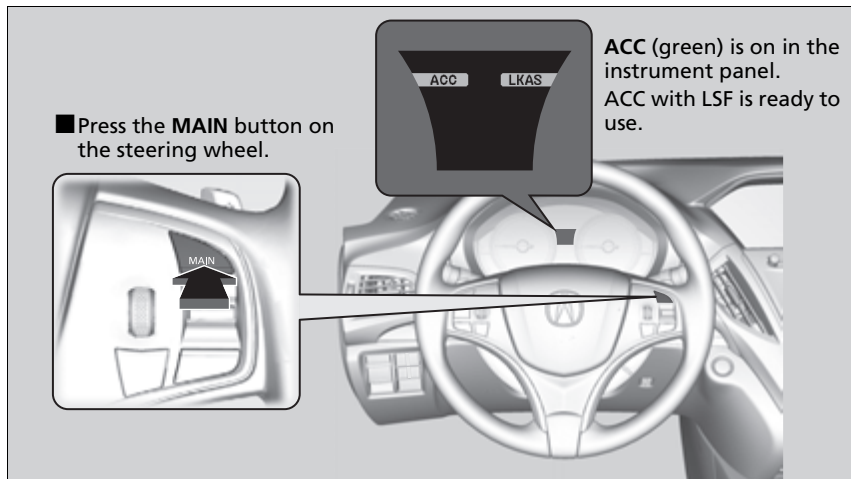

▶ Adaptive Cruise Control (ACC) with Low Speed Follow (LSF)

When the **MAIN** button is pressed, ACC with LSF and Lane Keeping Assist System (LKAS) are both turned on or off.

ACC with LSF may not work properly under certain conditions.

▶ **ACC with LSF Conditions and Limitations**
P. 265

When not using ACC with LSF: Turn off adaptive cruise by pressing the **MAIN** button. This also will turn off the Lane Keeping Assist System (LKAS).

Do not use ACC with LSF under the following conditions:

- On roads with heavy traffic or while driving in continuous stop and go traffic.
- On roads with sharp turns.
- On roads with steep downhill sections, as the set vehicle speed can be exceeded by coasting. In such cases, ACC with LSF will not apply the brakes to maintain the set speed.
- On roads with toll collection facilities or other objects between lanes of traffic, or in parking areas, or facilities with drive through access.

■ To Set the Vehicle Speed

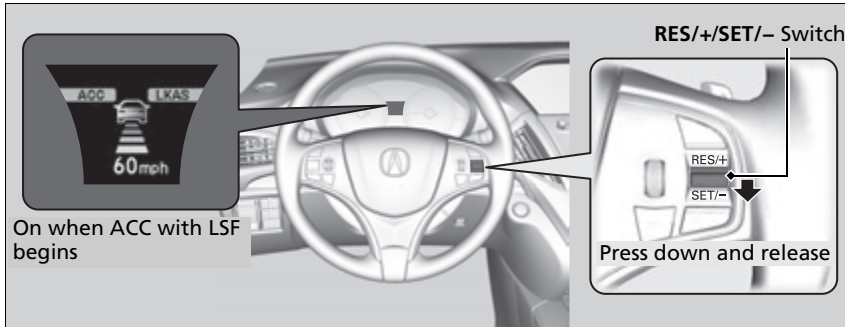

When driving at about 25 mph (40 km/h) or above: Take your foot off the pedal and press down the **RES/+ / SET/-** switch when you reach the desired speed. The moment you release the switch, the set speed is fixed, and ACC with LSF begins.

When driving at slower than about 25 mph (40 km/h): If the vehicle is moving and the brake pedal is not depressed, pressing the switch fixes the set speed to about 25 mph (40 km/h) regardless of current vehicle speed. If the vehicle is stationary, you can set the vehicle speed even with the brake pedal depressed.

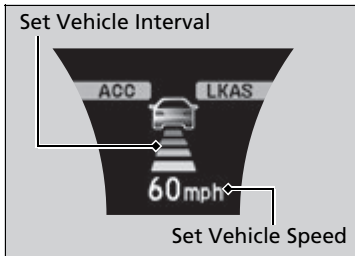

When ACC with LSF starts operating, the vehicle icon, interval bars and set speed appear on the MID.

Continued

■ When in Operation

■ There is a vehicle ahead

ACC with LSF monitors if a vehicle ahead of you enters the ACC with LSF range. If a vehicle is detected doing so, the ACC with LSF system maintains or decelerates your vehicle's set speed in order to keep the vehicle's set following-interval from the vehicle ahead.

➤ **To Set or Change Following-interval** P. 268

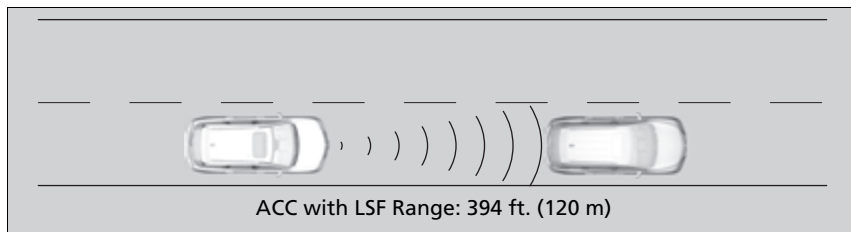

When a vehicle whose speed is slower than your set speed is detected in front of you, your vehicle starts to slow down.

⌘ When in Operation

If the vehicle detected ahead of you slows down abruptly, or if another vehicle is detected cutting in front of you, the beeper sounds, a message appears on the MID, and the head-up warning lights* come on.

Depress the brake pedal, and keep an appropriate interval from the vehicle ahead.

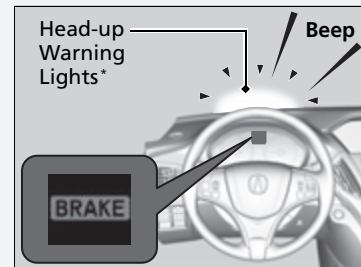

Even if the interval between your vehicle and the vehicle detected ahead is short, ACC with LSF may start accelerating your vehicle under the following circumstances:

- The vehicle ahead of you is going at almost the same speed as, or faster than, your vehicle.
- A vehicle that cuts in front of you is going faster than your vehicle, gradually increasing the interval between the vehicles.

■ **There is no vehicle ahead**

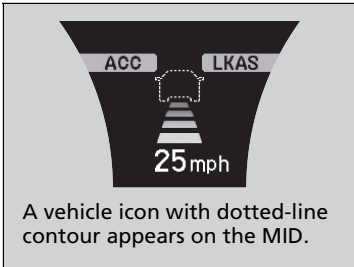

Your vehicle maintains the set speed without having to keep your foot on the brake or accelerator pedal.

If there previously was a vehicle detected ahead that kept your vehicle from traveling at the set speed, ACC with LSF accelerates your vehicle to the set speed, and then maintains it.

While stationary and no vehicle is detected, ACC with LSF automatically cancels and a beeper sounds.

■ **When you depress the accelerator pedal**

You can temporarily increase the vehicle speed. In this case, there is no audible or visual alert even if a vehicle is in the ACC with LSF range.

ACC with LSF stays on unless you cancel it. Once you release the accelerator pedal, the system resumes the set speed.

There are times when the vehicle speed will decrease when the accelerator pedal is lightly applied.

⌘When in Operation

You can also set the system to beep when a vehicle in front of you comes in and goes out of the ACC with LSF detecting range. Change the **ACC Forward Vehicle Detect Beep** setting.

➤ **Customized Features** P. 125

Limitations

You may need to use the brake to maintain a safe interval when using ACC with LSF. Additionally, ACC with LSF may not work properly under certain conditions.

➤ **ACC with LSF Conditions and Limitations**
P. 265

■ A vehicle detected ahead is within ACC with LSF range and slows to a stop



Your vehicle also stops, automatically. The **Stopped** message appears on the MID. When the vehicle ahead of you starts again, the vehicle icon on the MID blinks. If you press the **RES/+ / SET / -** switch up or down, or depress the accelerator pedal, ACC with LSF operates again within the prior set speed.

ⓘ A vehicle detected ahead is within ACC with LSF range and slows to a stop

⚠ WARNING

Exiting a vehicle that has been stopped while the ACC with LSF system is operating can result in the vehicle moving without operator control.

A vehicle that moves without operator control can cause a crash, resulting in serious injury or death.

Never exit a vehicle when the vehicle is stopped by ACC with LSF.

■ ACC with LSF Conditions and Limitations

The system may automatically shut off and the **ACC** indicator will come on under certain conditions. Some examples of these conditions are listed below. Other conditions may reduce some of the ACC functions.

➤ **Front Sensor Camera** P. 257

■ Environmental conditions

Driving in bad weather (rain, fog, snow, etc.).

■ Roadway conditions

Driving on a snowy or wet roadway (obscured lane marking, vehicle tracks, reflected lights, road spray, high contrast).

■ Vehicle conditions

- The outside of the windshield is blocked by dirt, mud, leaves, wet snow, etc.
- An abnormal tire or wheel condition (Wrong sized, varied size or construction, improperly inflated, compact spare tire*, etc.).
- The camera temperature gets too high.
- The parking brake is applied.
- When the front grille is dirty.
- When the front of the vehicle tilts up due to heavy cargo in the cargo area or rear seats.
- When tire chains are installed.

* Not available on all models

Continued

☒ ACC with LSF Conditions and Limitations

The radar sensor for ACC with LSF is shared with the Collision Mitigation Braking System™ (CMBS™).

➤ **Collision Mitigation Braking System™ (CMBS™)** P. 307

You can read about handling information for the camera equipped with this system.

➤ **Front Sensor Camera** P. 257

Always keep the radar sensor cover clean.

Never use chemical solvents or polishing powder for cleaning the sensor cover. Clean it with water or a mild detergent.

Do not put a sticker on the radar sensor cover or replace the radar sensor cover.

If you need the radar sensor to be repaired, or removed, or the radar sensor cover is strongly impacted, turn off the system by pressing the MAIN button and take your vehicle to a dealer.

■ Detection limitations

- A vehicle suddenly crosses in front of you.
- The interval between your vehicle and the vehicle ahead of you is too short.
- A vehicle cuts in front of you at a slow speed, and it brakes suddenly.
- When you accelerate rapidly and approach the vehicle ahead of you at high speed.
- The vehicle ahead of you is a motorcycle, bicycle, mobility scooter, or other small vehicle.
- When there are animals in front of your vehicle.
- When you drive on a curved or winding or undulating road that makes it difficult for the sensor to properly detect a vehicle in front of you.
- The speed difference between your vehicle and a vehicle in front of you is significantly large.
- An oncoming vehicle suddenly comes in front of you.
- Your vehicle abruptly crosses over in front of an oncoming vehicle.
- When driving through a narrow iron bridge.
- When the vehicle ahead of you brakes suddenly.
- When the vehicle ahead of you has a unique shape.
- When your vehicle or the vehicle ahead of you is driving on one edge of the lane.

▣ ACC with LSF Conditions and Limitations

Have your vehicle checked by a dealer if you find any unusual behavior of the system (e.g., the warning message appears too frequently).

If the front of the vehicle is impacted in any of the following situations, the radar sensor may not work properly. Have your vehicle checked by a dealer:

- The vehicle mounted onto a bump, curb, chock, embankment, etc.
- You drive the vehicle where the water is deep.
- Your vehicle has a frontal collision.

■ To Adjust the Vehicle Speed

Increase or decrease the vehicle speed using the **RES/+**/**SET/-** switch on the steering wheel.

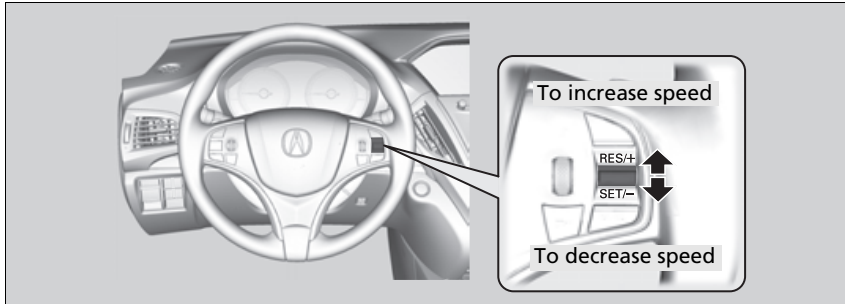

- Each time you press the switch up or down, the vehicle speed is increased or decreased by about 1 mph or 1 km/h accordingly.
- If you keep the switch pressed up or down, the vehicle speed increases or decreases by about 5 mph or 5 km/h accordingly.

☒ To Adjust the Vehicle Speed

If a vehicle detected ahead is going at a speed slower than your increased set speed, ACC with LSF may not accelerate your vehicle. This is to maintain the set interval between your vehicle and the vehicle ahead.

You can switch the displayed set speed measurements on the MID between mph and km/h.

➔ **Customized Features** P. 125

■ To Set or Change Following-interval

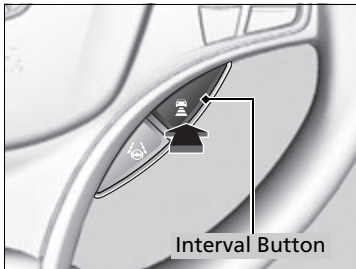





Press the  (interval) button to change the ACC with LSF following-interval.

Each time you press the button, the following-interval (the interval behind a vehicle detected ahead of you) setting cycles through short, middle, long, and extra long following-intervals.

Determine the most appropriate following-interval setting based on your specific driving conditions. Be sure to adhere to any following-interval requirements set by local regulation.

The higher your vehicle's following-speed is, the longer the short, middle, long or extra long following-interval becomes. See the following examples for your reference.

Following-interval		When the Set Speed is:	
		50 mph (80 km/h)	65 mph (104 km/h)
Short		83 feet 25 meters 1.1 sec	100 feet 31 meters 1.1 sec
Middle		110 feet 33 meters 1.5 sec	137 feet 42 meters 1.5 sec
Long		154 feet 47 meters 2.1 sec	200 feet 61 meters 2.1 sec
Extra Long		204 feet 62 meters 2.8 sec	265 feet 81 meters 2.8 sec

When your vehicle stops automatically because a vehicle detected ahead of you has stopped, the interval between the two vehicles will vary based on the ACC with LSF interval setting.

■ To Cancel

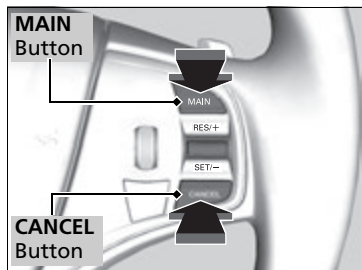

To cancel ACC with LSF, do any of the following:

- Press the **CANCEL** button.
- Press the **MAIN** button.
 - ▶ ACC with LSF indicator goes off.
- Depress the brake pedal.
 - ▶ When the LSF function has stopped the vehicle, you cannot cancel ACC with LSF by depressing the brake pedal.

☞ To Cancel

Resuming the prior set speed: After you have canceled ACC with LSF, you can resume the prior set speed while it is still displayed. Press the **RES/+ / SET / -** switch up.

The set speed cannot be set or resumed when ACC with LSF has been turned off using the **MAIN** button. Press the **MAIN** button to activate the system, then set the desired speed.

■ Automatic cancellation

The beeper sounds and a message appears on the MID when ACC with LSF is automatically canceled. Any of these conditions may cause the ACC with LSF to automatically cancel:

- Bad weather (rain, fog, snow, etc.)
- When the radar sensor in the front grille gets dirty.
- The vehicle ahead of you cannot be detected.
- An abnormal tire condition is detected, or the tires are skidding.
- Driving on a mountainous road, or driving off road for extended periods.
- Abrupt steering wheel movement.
- When the ABS, VSA® or CMBS™ is activated.
- When the ABS or VSA® system indicator comes on.
- When the vehicle is stopped on a very steep slope.
- When you manually apply the parking brake.
- When the detected vehicle within the ACC with LSF range is too close to your vehicle.
- When the detected vehicle goes out of the ACC with LSF range while your vehicle is stationary.
- The camera behind the rearview mirror, or the area around the camera, including the windshield, gets dirty.

The ACC with LSF automatic cancellation can be also triggered by the following causes. In these cases, the electric parking brake will be automatically applied.

- The driver's seat belt is unfastened when the vehicle is stationary.
- The vehicle stops for more than 10 minutes.
- The power system is turned off.

⌘ Automatic cancellation

Even though ACC with LSF has been automatically canceled, you can still resume the prior set speed. Wait until the condition that caused ACC with LSF to cancel improves, then press the **RES/+SET/-** switch up or down.

■ To Switch ACC with LSF to Cruise Control

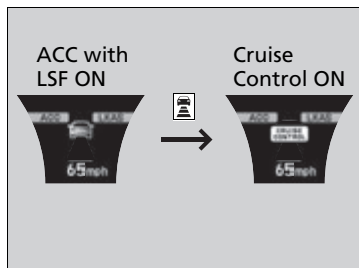

Press and hold the  (interval) button for one second. **Cruise Mode Selected** appears on the MID for two seconds, and then the mode switches to Cruise.

To switch back to ACC with LSF, press and hold the  button again for one second. **ACC Mode Selected** appears on the MID for two seconds.

■ When to use

Desired speed in a range above roughly 25 mph (40 km/h) ~.

■ To Set the Vehicle Speed

Take your foot off the pedal and press the **RES/+ / SET / -** switch down when you reach the desired speed.

The moment you release the **RES/+ / SET / -** switch, the set speed is fixed, and cruise control begins. The **CRUISE CONTROL** indicator comes on.

■ To Adjust the Vehicle Speed

Each time you press the **RES/+ / SET / -** switch up or down, the vehicle speed is increased or decreased by about 1 mph (1.6 km/h).

If you keep the **RES/+ / SET / -** switch pressed up or down, the vehicle speed increases or decreases until you release it. This speed is then set.

▶▶ To Switch ACC with LSF to Cruise Control

Always be aware which mode you are in. When you are driving in Cruise mode, the system will not assist you to maintain a following interval from a vehicle ahead of you.

You can switch the displayed set speed measurements on the MID between mph and km/h.

 **Customized Features** P. 125

■ To Cancel

To cancel cruise control, do any of the following:

- Press the **CANCEL** button.
- Press the **MAIN** button.
- Depress the brake pedal.

The **CRUISE CONTROL** indicator goes off.

☒ To Cancel

Resuming the prior set speed:

After cruise control has been canceled, you can still resume the prior set speed by pressing the **RES/+ / SET/-** switch up while driving at a speed of at least 25 mph (40 km/h) or more.

You cannot set or resume in the following situations:

- When vehicle speed is less than 25 mph (40 km/h).
- When the **MAIN** button is turned off.

At vehicle speeds of 22 mph (35 km/h) or less, cruise control canceled automatically.

Road Departure Mitigation (RDM) System

Alerts and helps to assist you when the system determines a possibility of your vehicle unintentionally crossing over detected lane markings.

How the System Works

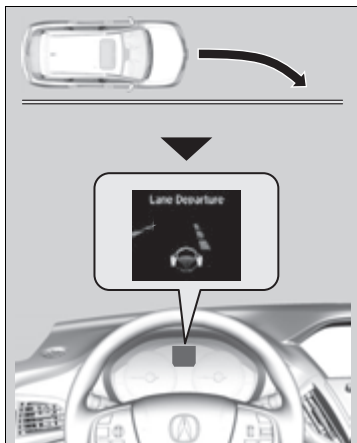

The front camera behind the rearview mirror monitors left and right lane markings (in white or yellow). If your vehicle is getting too close to detected lane markings without a turn signal activated, the system, in addition to a visual alert, applies steering torque and alerts you with rapid vibrations on the steering wheel, to help you remain within the detected lane.

▶ **Customized Features** P. 125

As a visual alert, the **Lane Departure** message appears on the MID.

If the system determines that its steering input is insufficient to keep your vehicle on the roadway, it may apply braking.

▶ Braking is applied only when the lane markings are solid continuous lines.

The system cancels assisting operations when you turn the steering wheel to avoid crossing over detected lane markings.

If the system operates several times without detecting driver response, the system beeps to alert you.

Road Departure Mitigation (RDM) System

Important Safety Reminder

Like all assistance systems, the RDM system has limitations.

Over-reliance on the RDM system may result in a collision. It is always your responsibility to keep the vehicle within your driving lane.

The RDM system only alerts you when lane drift is detected without a turn signal in use. The RDM system may not detect all lane markings or lane or roadway departures; accuracy will vary based on weather, speed and lane marker condition. It is always your responsibility to safely operate the vehicle and avoid collisions.

You can read about handling information for the camera equipped with this system.

▶ **Front Sensor Camera** P. 257

The RDM system may not work properly or may work improperly under the certain conditions:

▶ **RDM Conditions and Limitations** P. 277

There are times when you may not notice RDM functions due to your operation of the vehicle, or road surface conditions. If the **Lane Departure** message displays repeatedly and you do not apply responsive actions, the system beeps and cancels RDM functions.

How the System Activates

The system becomes ready to start searching for lane markings when all the following conditions are met:

- The vehicle is traveling between about 45 and 90 mph (72 and 145 km/h).
- The vehicle is on a straight or slightly curved road.
- The turn signals are off.
- The brake pedal is not depressed.
- The wipers are not in continuous operation.
- The vehicle is not accelerating or braking, and the steering wheel is not being turned.
- The system makes a determination that the driver is not actively accelerating, braking or steering.

How the System Activates

The RDM system may automatically shut off and the  indicator comes and stays on.

➤ **Indicators** P. 93

RDM system function can be impacted when the vehicle is:

- Not driven within a traffic lane.
- Driven on the inside edge of a curve, or outside of a lane.
- Driven in a narrow lane.

■ RDM On and Off

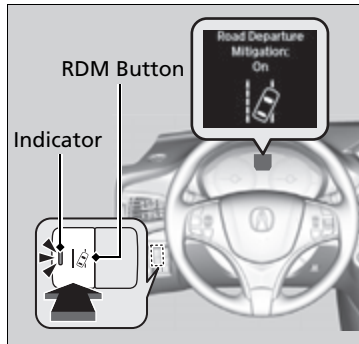

Press the RDM button to turn the system on and off.

- ▶ The indicator in the button comes on and the message appears on the MID when the system is on.

▣ RDM On and Off

When you have selected **Warning Only** from the customized options using the MID, the system does not operate the steering wheel and braking.

RDM Conditions and Limitations

The system may not properly detect lane markings and the position of your vehicle under certain conditions. Some examples of these conditions are listed below.

■ Environmental conditions

- Driving in bad weather (rain, fog, snow, etc.).
- Sudden changes between light and dark, such as an entrance or exit of a tunnel.
- There is little contrast between lane lines and the roadway surface.
- Driving into low sunlight (e.g., at dawn or dusk).
- Strong light is reflected onto the roadway.
- Driving in the shadows of trees, buildings, etc.
- Shadows of adjacent objects are parallel to lane markings.
- Roadway objects or structures are misinterpreted as lane markers.
- Reflections on the interior of the windshield.
- Driving at night or in a dark condition such as a tunnel.

■ **Roadway conditions**

- Driving on a snowy or wet roadway (obscured lane marking, vehicle tracks, reflected lights, road spray, high contrast).
- Driving on a road with temporary lane markings.
- Faint, multiple, or varied lane markings are visible on the roadway due to road repairs or old lane markings.
- The roadway has merging, split, or crossing lines (e.g., such as at an intersection or crosswalk).
- The lane markings are extremely narrow, wide, or changing.
- The vehicle in front of you is driving near the lane lines.
- The road is hilly or the vehicle is approaching the crest of a hill.
- Driving on rough or unpaved roads, or over bumpy surfaces.
- When objects on the road (curb, guard rail, pylons, etc.) are recognized as white lines (or yellow lines).
- Driving on roads with double lines.

■ **Vehicle conditions**

- Headlight lenses are dirty or the headlights are not properly adjusted.
- The outside of the windshield is streaked or blocked by dirt, mud, leaves, wet snow, etc.
- The inside of the windshield is fogged.
- The camera temperature gets too high.
- An abnormal tire or wheel condition (wrong sized, varied size or construction, improperly inflated, compact spare tire*, etc.).
- The vehicle is tilted due to a heavy load or suspension modifications.
- When tire chains are installed.

Lane Keeping Assist System (LKAS)

Provides steering input to help keep the vehicle in the middle of a detected lane and provides tactile and visual alerts if the vehicle is detected drifting out of its lane.

■ Steering input assist

The system applies torque to the steering to keep the vehicle between the left and right lane lines. The applied torque becomes stronger as the vehicle gets closer to either of the lane lines.

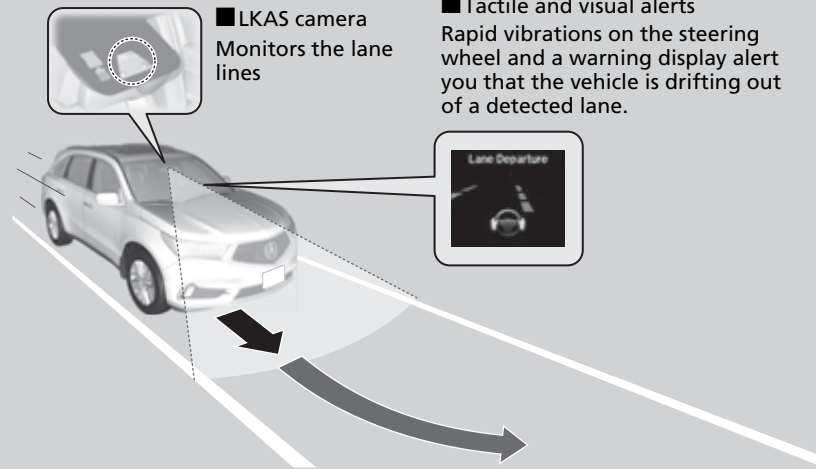

When you operate the turn signals to change lanes, the system is suspended, and resumes after the signals are off.

If you make a lane change without operating the turn signals, the LKAS alerts activate, and torque is applied to the steering.

☒ Lane Keeping Assist System (LKAS)

Important Safety Reminders

The LKAS is for your convenience only. It is not a substitute for your vehicle control. The system does not work if you take your hands off the steering wheel or fail to steer the vehicle.

☒ Multi-Information Display Warning and Information Messages P. 116

Do not place objects on the instrument panel. Objects may reflect on the front windshield and prevent correct detection of the traffic lanes.

The LKAS only alerts you when lane drift is detected without a turn signal in use. The LKAS may not detect all lane markings or lane departures; accuracy will vary based on weather, speed, and lane marker condition. It is always your responsibility to safely operate the vehicle and avoid collisions.

The LKAS is convenient when it is used on freeways.

The LKAS may not work properly or may work improperly under the certain conditions:

☒ LKAS Conditions and Limitations P. 285

The LKAS may not function as designed on while driving in frequent stop and go traffic, or on roads with sharp curves.

You can read about handling information for the camera equipped with this system.

☒ Front Sensor Camera P. 257

■ Lane Keep Support Function

Provides assistance to keep the vehicle in the center of the lane. When the vehicle nears a white or yellow line, steering force of the electric power steering will become stronger.

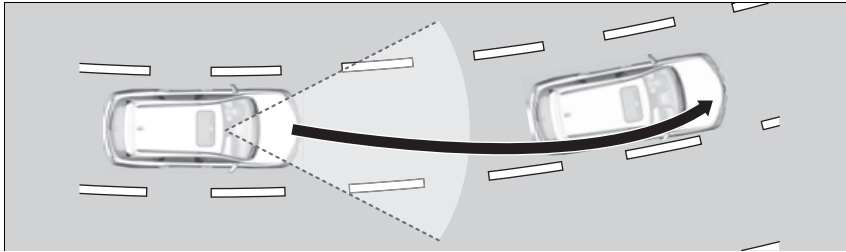

■ Lane Departure Warning Function

When the vehicle enters the warning area, the LKAS alerts you with slight steering wheel vibration as well as a warning display.

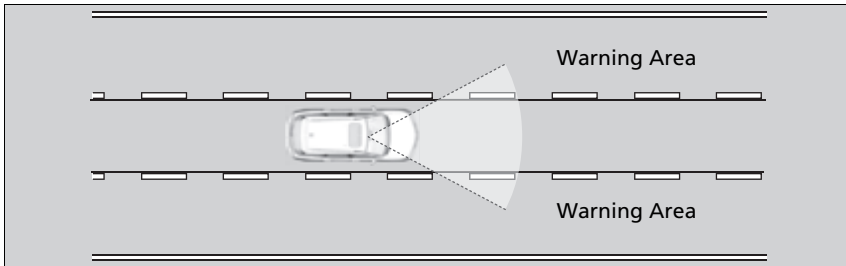

▶ Lane Keeping Assist System (LKAS)

When it fails to detect lanes, the system will temporarily be canceled. When lane is detected, system will recover automatically.

■ When the System can be Used

The system can be used when the following conditions are met.

- The lane in which you are driving has detectable lane markers on both sides, and your vehicle is in the center of the lane.
- The vehicle speed is between 45 and 90 mph (72 and 145 km/h).
- You are driving on a straight or slightly curved road.
- The turn signals are off.
- The brake pedal is not depressed.
- The wipers are not in continuous operation.

■ How to activate the system

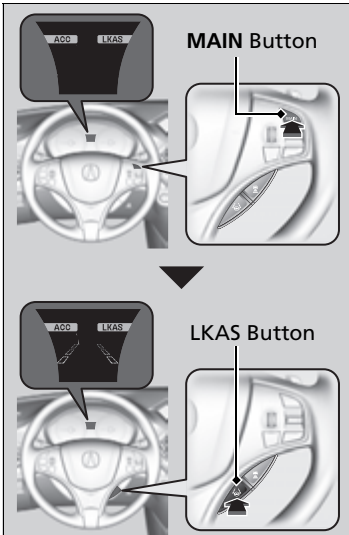

1. Press the **MAIN** button.
 - ▶ The LKAS is on in the MID.
The system is ready to use.
2. Press the LKAS button.
 - ▶ Lane outlines appear on the MID.
The system is activated.

☒ Lane Keeping Assist System (LKAS)

If the vehicle drifts toward either left or right lane line due to the system applying torque, turn off the LKAS and have your vehicle checked by a dealer.

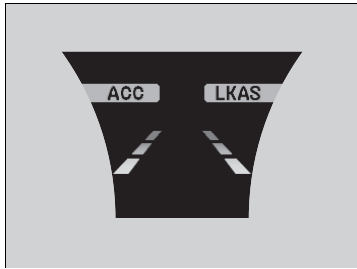

3. Keep your vehicle near the center of the lane while driving.
 - ▶ The dotted outer lines change to solid ones once the system starts operating after detecting the left and right lane markings.

▶▶ When the System can be Used

The LKAS temporarily deactivates when it fails to detect lane lines. When the system detects the lines again, it comes back on automatically.

▶▶ To cancel

Pressing the **MAIN** button also turns ACC with LSF on and off.

■ To cancel

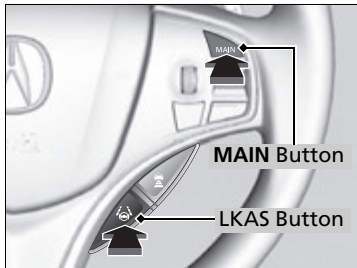

To cancel the LKAS:
Press the **MAIN** or LKAS button.

The LKAS is turned off every time you turn the power system off, even if you turned it on the last time you drove the vehicle.

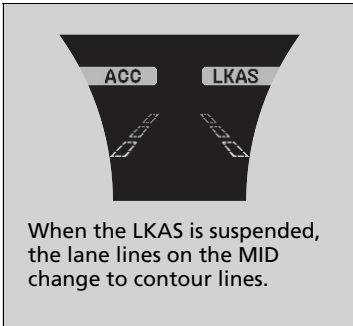

■ **The system operation is suspended if you:**

- Set the wipers to continuous operation.
 - ▶ Turning the wipers off resumes the LKAS.
- Decrease the vehicle speed to about 40 mph (64 km/h) or less.
 - ▶ Increasing the vehicle speed to about 45 mph (72 km/h) or more resumes the LKAS.
- Depress the brake pedal.
 - ▶ The LKAS resumes and starts detecting the lane lines again once you release the brake pedal.
- Set the wiper switch to **AUTO** and the wipers operate continuously.
 - ▶ The LKAS resumes when the wipers stop or operate intermittently.

■ **The LKAS may automatically be suspended when:**

- The system fails to detect lane lines.
- The steering wheel is quickly turned.
- You fail to steer the vehicle.
- The vehicle runs on a curved road over the speed limit.

Once these conditions no longer exist, the LKAS automatically resumes.

■ **The LKAS may automatically be canceled when:**

- The camera temperature gets extremely high or low.
- The camera behind the rearview mirror, or the area around the camera, including the windshield, gets dirty.
- Driving through a sharp curve.
- Driving at a speed in excess of approximately 90 mph (145 km/h).
- The ABS or VSA® system engages.

The beeper sounds if the LKAS is automatically canceled.

■ LKAS Conditions and Limitations

The system may not detect lane markings and therefore may not keep the vehicle in the middle of a lane under certain conditions, including the following:

■ Environmental conditions

- Driving in bad weather (rain, fog, snow, etc.).
- Sudden changes between light and dark, such as an entrance or exit of a tunnel.
- There is little contrast between lane lines and the roadway surface.
- Driving into low sunlight (e.g., at dawn or dusk).
- Strong light is reflected onto the roadway.
- Driving in the shadows of trees, buildings, etc.
- Shadows of adjacent objects are parallel to lane markings.
- Roadway objects or structures are misinterpreted as lane markers.
- Reflections on the interior of the windshield.
- Driving at night or in a dark condition such as a tunnel.

■ **Roadway conditions**

- Driving on a snowy or wet roadway (obscured lane marking, vehicle tracks, reflected lights, road spray, high contrast).
- Driving on a road with temporary lane markings.
- Faint, multiple, or varied lane markings are visible on the roadway due to road repairs or old lane markings.
- The roadway has merging, split, or crossing lines (e.g., such as at an intersection or crosswalk).
- The lane markings are extremely narrow, wide, or changing.
- The vehicle in front of you is driving near the lane lines.
- The road is hilly or the vehicle is approaching the crest of a hill.
- Driving on rough or unpaved roads, or over bumpy surfaces.
- When objects on the road (curb, guard rail, pylons, etc.) are recognized as white lines (or yellow lines).
- Driving on roads with double lines.

■ **Vehicle conditions**

- Headlight lenses are dirty or the headlights are not properly adjusted.
- The outside of the windshield is streaked or blocked by dirt, mud, leaves, wet snow, etc.
- The inside of the windshield is fogged.
- The camera temperature gets too high.
- An abnormal tire or wheel condition (wrong sized, varied size or construction, improperly inflated, compact spare tire*, etc.).
- The vehicle is tilted due to a heavy load or suspension modifications.

Vehicle Stability Assist (VSA®), aka Electronic Stability Control (ESC), System

VSA® helps to stabilize the vehicle during cornering if the vehicle turns more or less than what was intended. It also assists in maintaining traction on slippery surfaces. It does so by regulating engine and motor output and selectively applying the brakes.

■ VSA® Operation

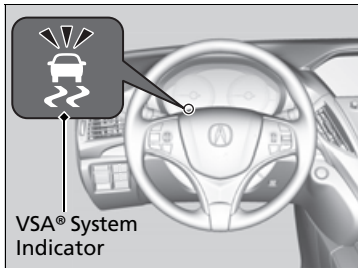

When VSA® activates, you may notice that the engine and motor do not respond to the accelerator. You may also notice some noise from the hydraulic system. You will also see the indicator blink.

▣ Vehicle Stability Assist (VSA®), aka Electronic Stability Control (ESC), System

The VSA® may not function properly if tire type and size are mixed. Make sure to use the same size and type of tire, and the air pressures as specified.

When the VSA® system indicator comes on and stays on while driving, there may be a problem with the system. While this may not interfere with normal driving, have your vehicle checked by a dealer immediately.

VSA® cannot enhance stability in all driving situations and does not control the entire braking system. You still need to drive and corner at speeds appropriate for the conditions and always leave a sufficient margin of safety.

The main function of the VSA® system is generally known as Electronic Stability Control (ESC). The system also includes a traction control function.

■ VSA® On and Off

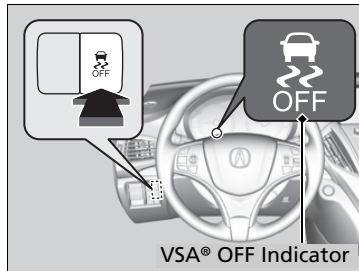

This button is on the driver side control panel. To partially disable VSA® functionality/features, press and hold it until you hear a beep.

The traction control stops fully functioning, allowing the wheels to spin more freely at low speed. The VSA® OFF indicator will also come on.

To restore VSA® functionality/features, press the  (VSA® OFF) button until you hear a beep.

VSA® is turned on every time you turn the power system on, even if you turned it off the last time you drove the vehicle.

▶▶ Vehicle Stability Assist (VSA®), aka Electronic Stability Control (ESC), System

With the  button pressed, your vehicle will have normal braking and cornering ability, but VSA® traction and stability enhancement becomes less effective.

In certain unusual conditions when your vehicle gets stuck in shallow mud or fresh snow, it may be easier to free it with the VSA® temporarily switched off.

When the  button is pressed, the traction control function becomes less effective. This allows for the wheels to spin more freely at low speed. You should only attempt to free your vehicle with the VSA® off if you are not able to free it when the VSA® is on.

Immediately after freeing your vehicle, be sure to switch VSA® on again. We do not recommend driving your vehicle with the VSA® system switched off.

You may hear a motor sound coming from the engine compartment while system checks are being performed immediately after turning the power system on or while driving. This is normal.

Agile Handling Assist

Lightly brakes each of the front and rear wheels, as needed, when you turn the steering wheel, and helps support the vehicle's stability and performance during cornering.

ⓘ Agile Handling Assist

The agile handling assist cannot enhance stability in all driving situations. You still need to drive and corner at speeds appropriate for the conditions and always leave a sufficient margin of safety.

When the VSA® system indicator comes on and stays on while driving, the agile handling assist does not activate.

You may hear a sound coming from the engine compartment while the agile handling assist is activated. This is normal.

SPORT HYBRID Super Handling-All Wheel Drive™ (SPORT HYBRID SH-AWD®)

The system controls and transfers varying amounts of motor and/or engine torque to each wheel in accordance with the driving conditions.

SPORT HYBRID SH-AWD® helps to enhance driving stability, and lets you handle situations like slippery surfaces, such as snow, sand, mud, and steep hills, better than when driving with standard two wheel drive. However, the system does not help to enhance braking. Be cautious about the following:

- It is still your responsibility to drive safely when you steer, accelerate, and apply brakes.
- Leave a sufficient margin when braking on slippery surfaces.

⚠ SPORT HYBRID Super Handling-All Wheel Drive™ (SPORT HYBRID SH-AWD®)

Do not drive through deep water.

The SPORT HYBRID SH-AWD® system may not function properly if tire type and size are mixed. Make sure to use the same size and type of tire, and the air pressures as specified.

➡ **Tire and Wheel Replacement** P. 367

Blind spot information (BSI) System

Is designed to detect vehicles in specified alert zones adjacent to your vehicle, particularly in harder to see areas commonly known as “blind spots.”

When the system detects vehicles approaching from behind in adjacent lanes, the appropriate indicator comes on for a few seconds, providing assistance when you change lanes.

■ How the system works

- The transmission is in **D** or **S**.
- Your vehicle speed is between 20 mph (32 km/h) and 100 mph (160 km/h)

Alert zone range

- A: Approx. 1.6 ft. (0.5 m)
- B: Approx. 10 ft. (3 m)
- C: Approx. 10 ft. (3 m)

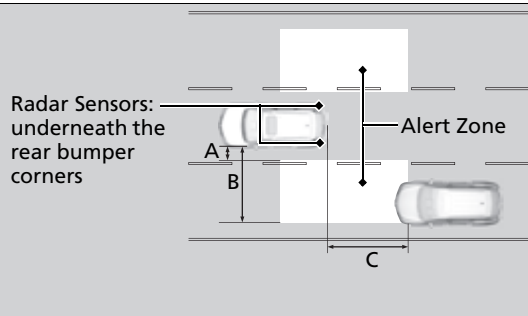

Blind spot information (BSI) System

⚠ WARNING

Failure to visually confirm that it is safe to change lanes before doing so may result in a crash and serious injury or death. Do not rely only on the blind spot information system when changing lanes.

Always look in your mirrors, to either side of your vehicle, and behind you for other vehicles before changing lanes.

Important Safety Reminder

Like all assistance systems, BSI has limitations. Over reliance on BSI may result in a collision.

The system is for your convenience only. Even if an object is within the alert zone, the following situations may occur.

- The BSI alert indicator may not come on due to obstruction (splashes, etc.) even without the **Blind Spot Info Not Available** MID appearing.
- The BSI alert indicator may come on even with the message appearing.

■ When the system detects a vehicle

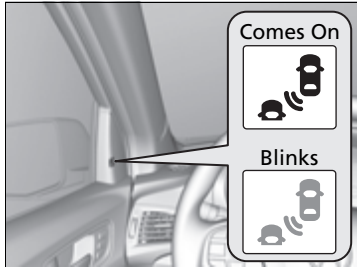

BSI Alert Indicator: Located near the outside rearview mirror on both sides.

Comes on when:

- A vehicle enters the alert zone from behind to overtake you with a speed difference of no more than 31 mph (50 km/h) from your vehicle.
- You pass a vehicle with a speed difference of no more than 12 mph (20 km/h).

Blinks and a beeper sounds when:

You move the turn signal lever in the direction of the detected vehicle. The beeper sounds three times.

▣ Blind spot information (BSI) System

The BSI alert indicator may not come on under the following conditions:

- A vehicle does not stay in the alert zone for more than two seconds.
- A vehicle is parked in a side lane.
- The speed difference between your vehicle and the vehicle you are passing is greater than 6 mph (10 km/h).
- An object not detected by the radar sensors approaches or passes your vehicle.
- A vehicle running in the adjacent lane is a motorcycle or other small vehicle.

You can turn off the audible alert, or all the BSI alert using the audio/information screen or MID.

▣ **Customizable Features** P. 128

BSI may be adversely affected when:

- Objects (guard rails, poles, trees, etc.,) are detected.
- An object that does not reflect radio waves well, such as a motorcycle, is in the alert zone.
- Driving on a curved road.
- A vehicle is moving from a far lane to the adjacent lane.
- The system picks up external electrical interference.
- The rear bumper or the sensors have been improperly repaired or the rear bumper has been deformed.
- The orientation of the sensors has been changed.
- In bad weather (Heavy rain, snow, and fog).

» Blind spot information (BSI) System

For a proper BSI operation:

- Always keep the rear bumper corner area clean.
- Do not cover the rear bumper corner area with labels or stickers of any kind.
- Take your vehicle to a dealer if you need the rear bumper corner area or the radar sensors to be repaired, or the rear bumper corner area is strongly impacted.

The system does not operate when in **R**.

Tire Pressure Monitoring System (TPMS) with Tire Fill Assist



Monitors the tire pressure while you are driving. If your vehicle's tire pressure becomes significantly low, the low tire pressure/TPMS indicator comes on and a message appears on the MID.

☒ Tire Pressure Monitoring System (TPMS) with Tire Fill Assist

Conditions such as low ambient temperature and altitude change directly affect tire pressure and can trigger the low tire pressure/TPMS indicator to come on.

☒ **If the Low Tire Pressure/TPMS Indicator Comes On or Blinks** P. 416

Tire pressure checked and inflated in:

- Warm weather can become under-inflated in colder weather.
- Cold weather can become over-inflated in warmer weather.

The low tire pressure/TPMS indicator will not come on as a result of over inflation.

The TPMS audibly and visually informs you of changes in tire pressure of the individual tire that you are adjusting using audible and visual indications.

If a change in tire pressure has been significant, the system beeps and the hazard lights flash continuously for five seconds when the specified tire pressure is reached. Stop filling the tire.

■ Tire Pressure Monitor

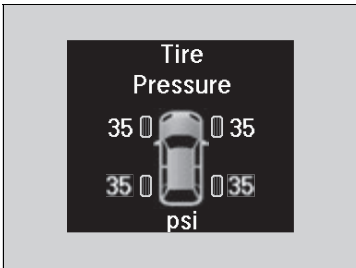

To select the tire pressure monitor, set the power mode to ON, and roll the multi-function steering-wheel controls until you see the tire pressure screen.

The pressure for each tire is displayed in psi (U.S.) or kPa (Canada).

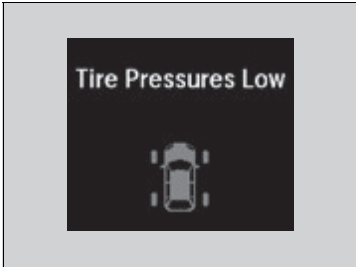

Tire Pressures Low is displayed when a tire has significantly low pressure. The specific tire is displayed on the screen.

☒ Tire Pressure Monitor

The pressure displayed on the MID can be slightly different from the actual pressure as measured by a gauge. If there is a significant difference between the two values, or if the low tire pressure/TPMS indicator and the message on the MID do not go off after you have inflated the tire to the specified pressure, have the system checked by a dealer.

Tire Pressure Monitor Problem may appear if you drive with the compact spare tire*, or there is a problem with the TPMS.

* Not available on all models

Tire Pressure Monitoring System (TPMS) - Required Federal Explanation

Each tire, including the spare (if provided), should be checked monthly when cold and inflated to the inflation pressure recommended by the vehicle manufacturer on the vehicle placard or tire inflation pressure label.

(If your vehicle has tires of a different size than the size indicated on the vehicle placard or tire inflation pressure label, you should determine the proper tire inflation pressure for those tires.)

As an added safety feature, your vehicle has been equipped with a tire pressure monitoring system (TPMS) that illuminates a low tire pressure telltale



when one or more of your tires is significantly under-inflated.

Accordingly, when the low tire pressure telltale illuminates, you should stop and check your tires as soon as possible, and inflate them to the proper pressure.

Driving on a significantly under-inflated tire causes the tire to overheat and can lead to tire failure. Under-inflation also reduces fuel efficiency and tire tread life, and may affect the vehicle's handling and stopping ability.

Please note that the TPMS is not a substitute for proper tire maintenance, and it is the driver's responsibility to maintain correct tire pressure, even if under-inflation has not reached the level to trigger illumination of the TPMS low tire pressure telltale.

Your vehicle has also been equipped with a TPMS malfunction indicator to indicate when the system is not operating properly. The TPMS malfunction indicator is combined with the low tire pressure telltale. When the system detects a malfunction, the telltale will flash for approximately one minute and then remain continuously illuminated. This sequence will continue upon subsequent vehicle start-ups as long as the malfunction exists.

When the malfunction indicator is illuminated, the system may not be able to detect or signal low tire pressure as intended.

TPMS malfunctions may occur for a variety of reasons, including the installation of replacement or alternate tires or wheels on the vehicle that prevent the TPMS from functioning properly.

Always check the TPMS malfunction telltale after replacing one or more tires or wheels on your vehicle to ensure that the replacement or alternate tires and wheels allow the TPMS to continue to function properly.

High Voltage Battery

The High Voltage battery gradually discharges when the vehicle is not in use. As a result, if your vehicle is parked for an extended period of time, the battery level may get low. Keeping your vehicle's battery level low can shorten the battery life. To maintain the battery, drive your vehicle for more than 30 minutes to recharge the battery at least once every three months.

To help maintain the battery life, when parking under the direct sunlight during summer, try find a shaded area.

Brake System

■ Parking Brake

Use the parking brake to keep the vehicle stationary when parked. When the parking brake is applied, you can manually or automatically release it.

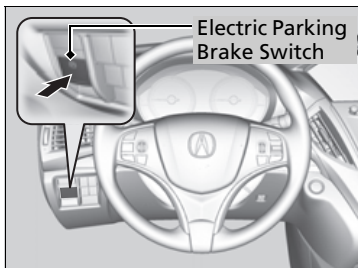

■ To apply

Press the electric parking brake switch.

- ▶ The electric parking brake indicator comes on.

☒ Brake System

When you depress the brake pedal, you may hear a whirling sound from the engine compartment. This is because the brake system is in operation, and it is normal.

☒ Parking Brake

You may hear the electric parking brake system motor operating from the rear wheel area when you apply or release the parking brake, or set the power mode to OFF. This is normal.

The brake pedal may slightly move due to the electric parking brake system operation when you apply or release the parking brake. This is normal.

You cannot apply or release the parking brake if the 12-volt battery goes dead.

☒ **Jump Starting** P. 407

If you press and hold the electric parking brake switch while driving the brakes on all four wheels are applied (by the VSA® system) until the vehicle come to a stop (at which point the electric parking brake is applied) or the switch is released.

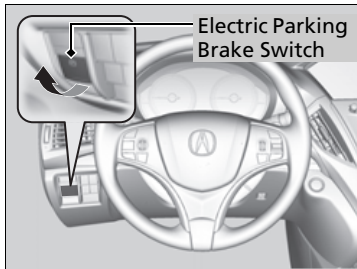

■ To release

1. Depress the brake pedal fully.
2. Pull the electric parking brake switch up gently and securely.
 - The electric parking brake indicator goes off.

Manually releasing the parking brake using the switch helps your vehicle start slowly and smoothly when facing down hill on steep hills.

▣ Parking Brake

In the following situations, the parking brake automatically operates.

- When the vehicle stops more than 10 minutes while ACC with LSF is activated.
- When the driver's seat belt is unfastened while your vehicle is stopped automatically by ACC with LSF.
- When the power system is turned off while ACC with LSF is activated.
- When the vehicle stops with the automatic brake hold system activated for more than 10 minutes.
- When the driver's seat belt is unfastened while your vehicle is stopped and brake hold system is applied.
- When the power system is turned off while brake hold system is applied.
- When there is a problem with the Brake Hold System while Brake Hold is applied.

■ To release automatically

Depressing the accelerator pedal releases the parking brake. Use the accelerator pedal to release the brake when you are starting the vehicle facing uphill, or in a traffic jam.

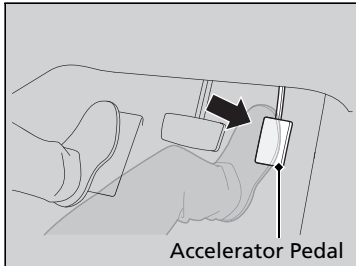

Gently depress the accelerator pedal. When on a hill, it may require more accelerator input to release.

- ▶ The electric parking brake indicator goes off.

You can release the parking brake automatically when:

- You are wearing the driver's seat belt.
- The power system is on.
- The transmission is not in **P** or **N**.

⊠ Parking Brake

If the parking brake cannot be released automatically, release it manually.

The parking brake cannot be released automatically while the following indicators are on:

- Malfunction indicator lamp
- Transmission system indicator

The parking brake may not be released automatically while the following indicators are on:

- Electric parking brake system indicator
- VSA® system indicator
- **ABS** indicator
- Supplemental restraint system indicator

■ Foot Brake

Your vehicle is equipped with disc brakes at all four wheels. The brake assist system increases the stopping force when you depress the brake pedal hard in an emergency situation. The anti-lock brake system (ABS) helps you retain steering control when braking very hard.

➤ **Brake Assist System** P. 306

➤ **Anti-lock Brake System (ABS)** P. 305

☒ Foot Brake

Check the brakes after driving through deep water, or if there is a buildup of road surface water. If necessary, dry the brakes by lightly depressing the pedal several times.

If you hear a continuous metallic friction sound when applying the brakes, this is caused by the brake wear indicator rubbing on the brake rotor and indicates that the brake pads need to be replaced. Have the vehicle checked by a dealer. If you hear only an occasional squeak or squeal when you initially apply the brake pedal, this may be normal and caused by high frequency vibration of the brake pads against the rotating brake disc.

Constantly using the brake pedal while going down a long hill builds up heat, which reduces the brake effectiveness. Apply regenerative braking by taking your foot off the accelerator pedal and downshifting to a lower gear.

Do not rest your foot on the brake pedal while driving, as it will lightly apply the brakes and cause them to lose effectiveness over time and reduce pad life. It will also confuse drivers behind you.

Automatic Brake Hold

Keeps the brake applied after releasing the brake pedal until the accelerator pedal is pressed. You can use this system while the vehicle is temporarily stopped, such as when you stop at a traffic light.

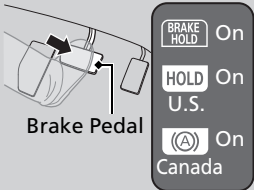
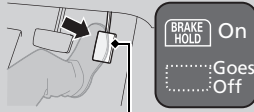
<p>■ Turning on the system</p>  <p>Automatic Brake Hold Button</p> <p>Fasten your seat belt properly, then start the power system. Press the automatic brake hold button.</p> <ul style="list-style-type: none"> • The automatic brake hold system indicator comes on. The system is turned on. 	<p>■ Activating the system</p>  <p>Brake Pedal</p> <p>Depress the brake pedal to come to a complete stop. The transmission must be in D or N.</p> <ul style="list-style-type: none"> • The automatic brake hold indicator comes on. Braking is kept for up to 10 minutes. • Release the brake pedal after the automatic brake hold indicator comes on. 	<p>■ Canceling the system</p>  <p>Accelerator Pedal</p> <p>Depress the accelerator pedal while the transmission is in D. The system is canceled and the vehicle starts to move.</p> <ul style="list-style-type: none"> • The automatic brake hold indicator goes off. The system continues to be on.
---	---	---

Automatic Brake Hold

⚠ WARNING

Activating the automatic brake hold system on steep hills or slippery roads may still allow the vehicle to move if you remove your foot from the brake pedal.

If a vehicle unexpectedly moves, it may cause a crash resulting in serious injury or death.

Never activate the automatic brake hold system or rely on it to keep a vehicle from moving when stopped on a steep hill or slippery roads.

⚠ WARNING

Using the automatic brake hold system to park the vehicle may result in the vehicle unexpectedly moving.

If a vehicle moves unexpectedly, it may cause a crash, resulting in serious injury or death.

Never leave the vehicle when braking is temporarily kept by automatic brake hold and always park the vehicle by putting the transmission in **P** and applying the parking brake.

■ **The system automatically cancels when:**

- You depress the brake pedal and change to **P** or **R**.
- You engage the parking brake.

Under the following conditions, the system automatically cancels, and the parking brake is applied:

- Braking is kept for more than 10 minutes.
- The driver's seat belt is unfastened.
- The power system is turned off.
- **Brake Hold System Problem** appears on the MID.

■ **Turning off the automatic brake hold system**

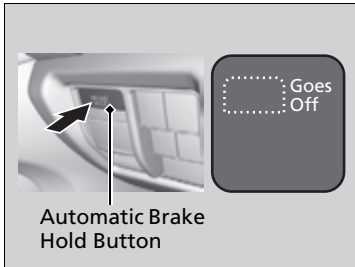

While the system is on, press the automatic brake hold button again.

- The automatic brake hold system indicator goes off.

If you want to turn off automatic brake hold while the system is in operation, press the automatic brake hold button with the brake pedal depressed.

⌘ Automatic Brake Hold

While the system is activated, you can turn off the power system or park the vehicle through the same procedure as you normally do.

⌘ **When Stopped** P. 316

Whether the system is on, or the system is activated, the automatic brake hold turns off once the power system is off.

⌘ Turning on the system

Make sure to turn off the automatic brake hold system before using an automated car wash.

You may hear an operating noise if the vehicle moves while the automatic brake hold system is in operation. The system generates sound while holding the vehicle and it moves.

Anti-lock Brake System (ABS)

■ ABS

Helps prevent the wheels from locking up, and helps you retain steering control by pumping the brakes rapidly, much faster than you.

The electronic brake distribution (EBD) system, which is part of the ABS, also balances the front-to-rear braking distribution according to vehicle loading.

You should never pump the brake pedal. Let the ABS work for you by always keeping firm, steady pressure on the brake pedal. This is sometimes referred to as “stomp and steer.”

■ ABS operation

You may hear an operating noise when the ABS is working. Keep holding the pedal firmly down. On dry pavement, you will need to press on the brake pedal very hard before the ABS activates. However, you may feel the ABS activate immediately if you are trying to stop on snow or ice.

ABS may activate when you depress the brake pedal when driving on:

- Wet or snow covered roads.
- Roads paved with stone.
- Roads with uneven surfaces, such as potholes, cracks, manholes, etc.

When the vehicle speed goes under 6 mph (10 km/h), the ABS stops.

▶▶ Anti-lock Brake System (ABS)

NOTICE

The ABS may not function correctly if you use an incorrect tire type and size.

When the **ABS** indicator comes on while driving, there may be a problem with the system. While normal braking is not affected, there is a possibility of the ABS not operating. Have the vehicle checked by a dealer immediately.

The ABS does not reduce the time or distance it takes to stop the vehicle. It only helps with steering control during hard braking.

In the following cases, your vehicle may need more stopping distance than a vehicle without the ABS:

- When driving on rough road surfaces, including when driving on uneven surfaces, such as gravel or snow.
- When snow chains are installed.

The following may be observed with the ABS system:

- Motor sounds coming from the engine compartment when the brakes are applied, or when system checks are being performed after the engine has been started and while vehicle is accelerates.
- Brake pedal and/or the vehicle body vibration when ABS activates.

These vibrations and sounds are normal to ABS systems and are no cause for concern.

Brake Assist System

■ Brake Assist System

Designed to assist the driver by generating greater braking force when you depress the brake pedal hard during emergency braking.

■ Brake assist system operation

Press the brake pedal firmly for more powerful braking.

Collision Mitigation Braking System™ (CMBS™)

Can assist you when there is a possibility of your vehicle colliding with a vehicle or a pedestrian detected in front of yours. The CMBS™ is designed to alert you when a potential collision is determined, as well as to reduce your vehicle speed to help minimize collision severity when a collision is deemed unavoidable.

■ How the system works

When to use

The camera is located behind the rearview mirror.

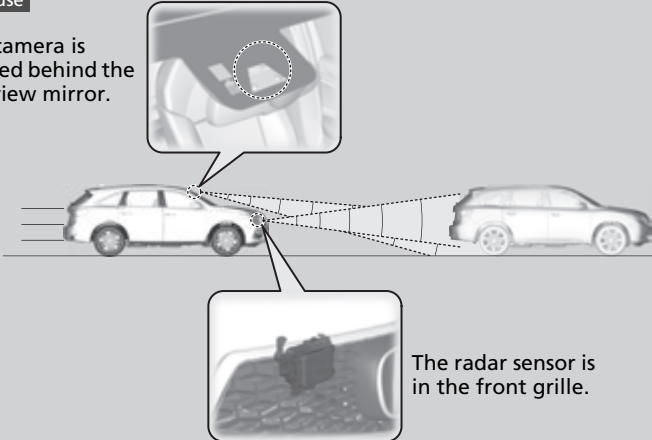

The radar sensor is in the front grille.

The system starts monitoring the roadway ahead when your vehicle speed is about 3 mph (5 km/h) and there is a vehicle in front of you.

The CMBS™ activates when:

- The speed difference between your vehicle and a vehicle or pedestrian detected in front of you becomes about 3 mph (5 km/h) and over with a chance of a collision.
- Your vehicle speed is about 62 mph (100 km/h) or less and there is a chance of a collision with an oncoming detected vehicle or a pedestrian in front of you.

⚠ Collision Mitigation Braking System™ (CMBS™)

Important Safety Reminder

The CMBS™ is designed to reduce the severity of an unavoidable collision. It does not prevent a collision nor stop the vehicle automatically. It is still your responsibility to operate the brake pedal and steering wheel appropriately according to the driving conditions.

The CMBS™ may not activate or may not detect a vehicle in front of your vehicle under certain conditions:

➤ **CMBS™ Conditions and Limitations** P. 311

You can read about handling information for the camera equipped with this system.

➤ **Front Sensor Camera** P. 257

⚠ How the system works

Rapid vibrations on the steering wheel alert you when your vehicle speed is between 19 and 62 mph (30 and 100 km/h) with an oncoming vehicle detected in front of you.

When the CMBS™ activates, it may automatically apply the brake. It will be canceled when your vehicle stops or a potential collision is not determined.

■ When the system activates

The system provides visual, audible and tactile alerts of a possible collision, and stops if the collision is avoided.

- ▶ Take appropriate action to prevent a collision (apply the brakes, change lanes, etc.)

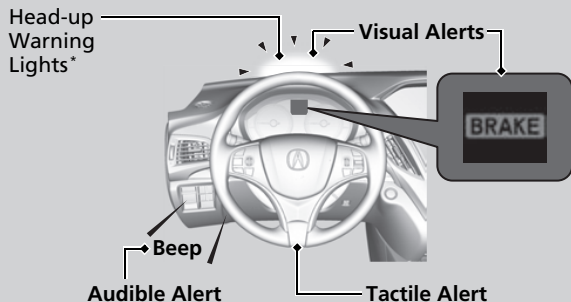

At system's earliest collision alert stage, you can change the distance (**Long/Normal/Short**) between vehicles at which alerts will come on through MID setting options.

- ▶ **List of customizable options** P. 128

■ Vibration alert on the steering wheel

When a potential collision to an oncoming detected vehicle is determined, the system alerts you with rapid vibration on the steering wheel, in addition to visual and audible alerts.

- ▶ Take appropriate action to prevent a collision (apply the brakes, operate the steering wheel, etc.).

▶▶ When the system activates

The camera in the CMBS™ is also designed to detect pedestrians.

However, this pedestrian detection feature may not activate or may not detect a pedestrian in front of your vehicle under certain conditions. Refer to the ones indicating the pedestrian detection limitations from the list.

- ▶ **CMBS™ Conditions and Limitations** P. 311

The head-up warning* uses a lens located at the front end of the dashboard.

Do not cover the lens or spill any liquid on it.

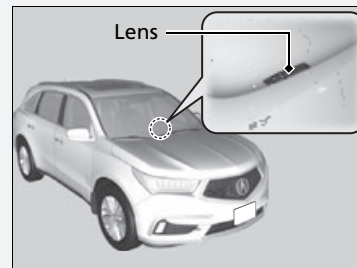

▶▶ Vibration alert on the steering wheel

Vibration alert function is disabled when the electric power steering (EPS) system indicator comes on.

- ▶ **Speed-sensitive Electric Power Steering (EPS) System Indicator** P. 89

■ Collision Alert Stages

The system has three alert stages for a possible collision. However, depending on circumstances, the CMBS™ may not go through all of the stages before initiating the last stage.

Distance between vehicles		CMBS™			
		The sensors detect a vehicle	Audible & Visual WARNINGS	Steering Wheel	Braking
Stage one		There is a risk of a collision with the vehicle ahead of you.	When in Long , visual and audible alerts come on at a longer distance from a vehicle ahead than in Normal setting, and in Short , at a shorter distance than in Normal .	In case of an oncoming vehicle detected, rapid vibration is provided.	—
Stage two		The risk of a collision has increased, time to respond is reduced.	Visual and audible alerts.	—	Lightly applied
Stage three		The CMBS™ determines that a collision is unavoidable.			Forcefully applied

■ CMBS™ On and Off

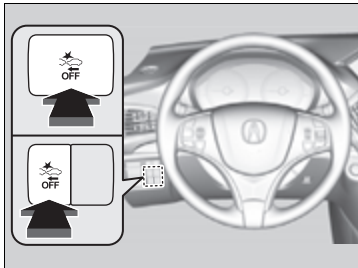

Press and hold the button until the beeper sounds to switch the system on or off.

When the CMBS™ is off:

- The CMBS™ indicator in the instrument panel comes on.
- A message on the MID reminds you that the system is off.

The CMBS™ is in the previously selected ON or OFF setting each time you start the power system.

► Collision Mitigation Braking System™ (CMBS™)

The CMBS™ may automatically shut off, and the CMBS™ indicator will come and stay on under certain conditions:

► **CMBS™ Conditions and Limitations** P. 311

■ CMBS™ Conditions and Limitations

The system may automatically shut off and the CMBS™ indicator will come on under certain conditions. Some examples of these conditions are listed below. Other conditions may reduce some of the CMBS™ functions.

📷 Front Sensor Camera P. 257

■ Environmental conditions

- Driving in bad weather (rain, fog, snow, etc.).
- Sudden changes between light and dark, such as an entrance or exit of a tunnel.
- There is little contrast between objects and the background.
- Driving into low sunlight (e.g., at dawn or dusk).
- Strong light is reflected onto the roadway.
- Driving in the shadows of trees, buildings, etc.
- Roadway objects or structures are misinterpreted as vehicles and pedestrians.
- Reflections on the interior of the front windshield.
- Driving at night or in a dark condition such as a tunnel.

■ Roadway conditions

- Driving on a snowy or wet roadway (obscured lane marking, vehicle tracks, reflected lights, road spray, high contrast).
- The road is hilly or the vehicle is approaching the crest of a hill.
- Driving on curvy, winding, or undulating roads.

■ **Vehicle conditions**

- Headlight lenses are dirty or the headlights are not properly adjusted.
- The outside of the windshield is blocked by dirt, mud, leaves, wet snow, etc.
- The inside of the windshield is fogged.
- An abnormal tire or wheel condition (wrong sized, varied size or construction, improperly inflated, compact spare tire*, etc.).
- When tire chains are installed.
- The vehicle is tilted due to a heavy load or suspension modifications.
- The camera temperature gets too high.
- Driving with the parking brake applied.
- When the radar sensor in the front grille gets dirty.

■ Detection limitations

- A vehicle or pedestrian suddenly crosses in front of you.
- The distance between your vehicle and the vehicle or pedestrian ahead of you is too short.
- A vehicle cuts in front of you at a slow speed, and it brakes suddenly.
- When you accelerate rapidly and approach the vehicle or pedestrian ahead of you at high speed.
- The vehicle ahead of you is a motorcycle, bicycle, mobility scooter or other small vehicle.
- When there are animals in front of your vehicle.
- When you drive on a curved, winding or undulating road that makes it difficult for the sensor to properly detect a vehicle in front of you.
- The speed difference between your vehicle and a vehicle or pedestrian in front of you is significantly large.
- An oncoming vehicle suddenly comes in front of you.
- Another vehicle suddenly comes in front of you at an intersection, etc.
- Your vehicle abruptly crosses over in front of an oncoming vehicle.
- When driving through a narrow iron bridge.
- When the lead vehicle suddenly slows down.

Limitations applicable to pedestrian detection only

- When there is a group of people in front of your vehicle walking together side by side.
- Surrounding conditions or belongings of the pedestrian alter the pedestrian's shape, preventing the system from recognizing that the person is a pedestrian.
- When the pedestrian is shorter than about 3.3 feet (1 meter) or taller than about 6.6 feet (2 meters) in height.
- When a pedestrian blends in with the background.
- When a pedestrian is bent over or squatting, or when their hands are raised or they are running.
- When several pedestrians are walking ahead in a group.
- When the camera cannot correctly identify that a pedestrian is present due to an unusual shape (holding luggage, body position, size).

■ Automatic shutoff

The CMBST™ may automatically shut itself off and the CMBST™ indicator comes and stays on when:

- The temperature inside the system is high.
- You drive off-road or on a mountain road, or curved and winding road for an extended period.
- An abnormal tire condition is detected (wrong tire size, flat tire, etc.).
- The camera behind the rearview mirror, or the area around the camera, including the windshield, gets dirty.

Once the conditions that caused CMBST™ to shut off improve or are addressed (e.g., cleaning), the system comes back on.

■ With Little Chance of a Collision

The CMBS™ may activate even when you are aware of a vehicle ahead of you, or when there is no vehicle ahead. Some examples of this are:

■ When Passing

Your vehicle approaches another vehicle ahead of you and you change lanes to pass.

■ At an intersection

Your vehicle approaches or passes another vehicle that is making a left or right turn.

■ On a curve

When driving through curves, your vehicle comes to a point where an oncoming vehicle is right in front of you.

■ Through a low bridge at high speed

You drive under a low or narrow bridge at high speed.

■ Speed bumps, road work sites, train tracks, roadside objects, etc.

You drive over speed bumps, steel road plates, etc., or your vehicle approaches train tracks or roadside objects [such as a traffic sign and guard rail] on a curve or, when parking, stationary vehicles and walls.

⌘ Collision Mitigation Braking System™ (CMBS™)

For the CMBS™ to work properly:

Always keep the radar sensor cover clean.

Never use chemical solvents or polishing powder for cleaning the sensor cover. Clean it with water or a mild detergent.

Do not put a sticker on the emblem or replace the emblem.

If you need the radar sensor to be repaired, or removed, or the radar sensor cover is strongly impacted, turn off the system by pressing the CMBS™ off button and take your vehicle to a dealer.

When Stopped

1. Depress the brake pedal firmly.
2. With the brake pedal depressed, press the electric parking brake switch slowly, but fully.
3. Change the gear position to **P**.
4. Turn off the power system.
The electric parking brake indicator goes off in about 15 seconds.

▣ Parking Your Vehicle

Do not park your vehicle near flammable objects, such as dry grass, oil, or timber. Heat from the exhaust can cause a fire.

▣ When Stopped

NOTICE

The following can damage the transmission:

- Depressing the accelerator and brake pedals simultaneously.
- Changing into **P** before the vehicle stops completely.

In extremely cold temperatures, the parking brake may freeze up if applied. If such temperatures are expected, do not apply the parking brake but, if parking on a slope, either turn the front wheels so they will contact the curb if the vehicle rolls down the slope or block the wheels to keep the vehicle from moving. If you do not take either precaution, the vehicle may roll unexpectedly, leading to a crash.

Always confirm the electric parking brake is set, particularly if you are parked on an incline.

If during in Auto Engine Stop, the gear position changes to **P** and the engine restarts automatically under the following conditions:

- The power system is on.
- The gear position is not in **P**.
- You unfasten the driver side seat belt and open the door.

ⓘ When Stopped

When facing uphill, do not hold the vehicle by depressing the accelerator pedal. Doing so may cause the items to malfunction or a fire inside the vehicle.

⚠ WARNING

The vehicle can roll away if left unattended without confirming that Park is engaged.

Always keep your foot on the brake pedal until you have confirmed that **P** is shown on the gear position Indicator.

Parking Sensor System *

The corner and center sensors monitor obstacles near your vehicle. The beeper and audio/information screen let you know the approximate distance between your vehicle and the obstacle.

■ The sensor location and range

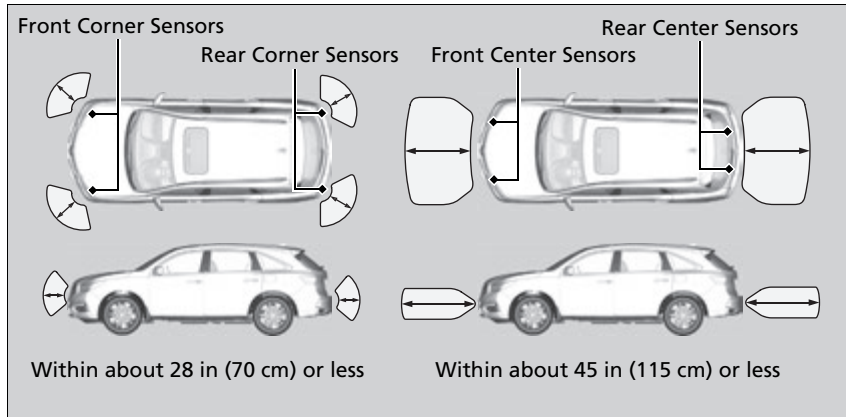

▣ Parking Sensor System *

Even when the system is on, always confirm if there is no obstacle near your vehicle before parking.

The system may not work properly when:

- The sensors are covered with snow, ice, mud or dirt, etc.
- The vehicle is on uneven surface, such as grass, bumpy road, or a hill.
- The vehicle has been out in hot or cold weather.
- The system is affected by devices that emit ultrasonic waves.
- Driving in bad weather.

The system may not sense:

- Thin or low objects.
- Sonic-absorptive materials, such as snow, cotton, or sponge.
- Objects directly under the bumper.

Do not put any accessories on or around the sensors.

■ Parking sensor system on and off

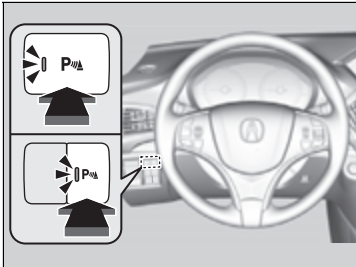

With the power mode in ON, press the parking sensor system button to turn on or off the system. The indicator in the button comes on when the system is on.

The rear center and corner sensors start to detect an obstacle when the transmission is in **R**, and the vehicle speed is less than 5 mph (8 km/h).

The front corner sensors start to detect an obstacle when the transmission is not in **P**, and the vehicle speed is less than 5 mph (8 km/h).

■ When the distance between your vehicle and obstacles behind becomes shorter

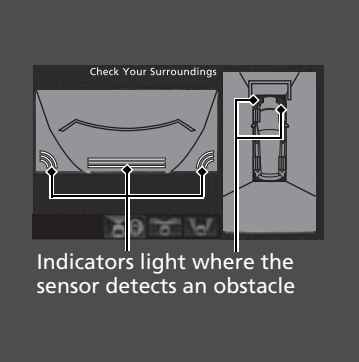
Length of the intermittent beep	Distance between the Bumper and Obstacle		Indicator	Audio/information screen
	Corner Sensors	Center Sensors		
Moderate	—	Rear: About 45-28 in (115-70 cm) Front: About 39-28 in (100-70 cm)	Blinks in Yellow*1	
Short	About 28-18 in (70-45 cm)	About 28-18 in (70-45 cm)	Blinks in Amber	
Very short	About 18-14 in (45-35 cm)	About 18-14 in (45-35 cm)		
Continuous	About 14 in (35 cm) or less	About 14 in (35 cm) or less	Blinks in Red	

*1: At this stage, only the center sensors detect obstacles.

■ Turning off All Rear Sensors

1. Make sure that the parking sensor system is not activated. Set the power mode to VEHICLE OFF (LOCK).
2. Press and hold the parking sensor system button, and set the power mode to ON.
3. Keep pressing the button for 10 seconds. Release the button when the indicator in the button flashes.
4. Press the button again. The indicator in the button goes off.
 - ▶ The beeper sounds twice. The rear sensors are now turned off.

To turn the rear sensors on again, follow the above procedure. The beeper sounds three times when the rear sensors come back on.

☒ Turning off All Rear Sensors

When you shift to **[R]**, the indicator in the parking sensor system button blinks as a reminder that the rear sensors have been turned off.

Cross Traffic Monitor

Monitors the rear corner areas using the radar sensors when reversing, and alerts you if a vehicle approaching from a rear corner is detected.

The system is convenient when you are backing out of a parking space.

ⓘ Cross Traffic Monitor

CAUTION

Cross Traffic Monitor cannot detect all approaching vehicles and may not detect an approaching vehicle at all.

Failure to visually confirm that it is safe to back up the vehicle before doing so may result in a collision.

Do not solely rely on the system when reversing; always also use your mirrors, and look behind and to the sides of your vehicle before reversing.

How the System Works

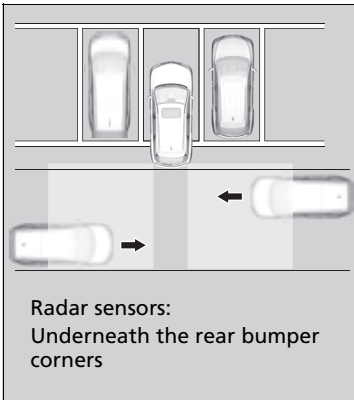

The system activates when:

- The power mode is in ON.
- The Cross Traffic Monitor is turned on.
 - **Cross Traffic Monitor On and Off** P. 325
 - **Refer to the navigation system**
- The transmission is in **R**.
- Your vehicle is moving at 3 mph (5 km/h) or lower.

When a vehicle is detected approaching from a rear corner, Cross Traffic Monitor alerts you with a buzzer and a displayed warning.

The system will not detect a vehicle that approaches from directly behind your vehicle, nor will it provide alerts about a detected vehicle when it moves directly behind your vehicle.

The system does not detect or provide alerts for a vehicle that is moving away from your vehicle, and it may not detect or alert for pedestrians, bicycles, or stationary objects.

⊠ Cross Traffic Monitor

Cross Traffic Monitor may not detect or may delay alerting an approaching vehicle, or may alert without an approaching vehicle under the following conditions:

- An obstacle, such as another vehicle and a wall, near your vehicle's rear bumper, is blocking the radar sensor's scope.
- Your vehicle is moving at the speed of about 3 mph (5 km/h) or higher.
- A vehicle is approaching at the speed other than between about 6 mph (10 km/h) and 16 mph (25 km/h).
- The system picks up external interference such as other radar sensors from another vehicle or strong radio wave transmitted from a facility nearby.
- Either corner of the rear bumper is covered with snow, ice, mud or dirt.
- When there is bad weather.
- Your vehicle is on an incline.
- Your vehicle is tilted due to a heavy load in the rear.
- Your vehicle is reversing towards a wall, a pole, a vehicle, and so on.
- The rear bumper or the sensors have been improperly repaired or the rear bumper has been deformed. Have your vehicle checked by a dealer.

For proper operation, always keep the rear bumper corner area clean.

Do not cover the rear bumper corner area with labels or stickers of any kind.

■ When the System Detects a Vehicle

Models with multi-view rear camera system

Arrow Icon



Normal View Wide View Top Down View

Models with surround view camera system

Arrow Icon

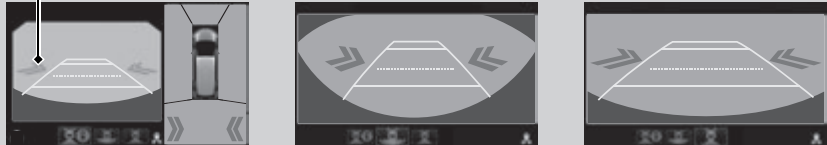

Rear Ground View Rear Wide View Rear Normal View



An arrow icon appears on the side a vehicle is approaching on the audio/information screen.

» Cross Traffic Monitor

■ Models with parking sensor system

The parking sensor system's alerting buzzer overrides the Cross Traffic Monitor buzzer when the sensors are detecting obstacles at the closest range.

» When the System Detects a Vehicle







If the  on the lower right changes to  in amber when the transmission is in **R**, mud snow or ice, etc. may have accumulated in the vicinity of the sensor. The system is temporarily canceled. Check the bumper corners for any obstructions, and thoroughly clean the area if necessary.

If the  comes on when the transmission is in **R**, there may be a problem with the Cross Traffic Monitor system. Do not use the system and have your vehicle checked by a dealer.

If the display remains the same with the transmission in **R**, there may be a problem with the rear camera system and the Cross Traffic Monitor system. Do not use the system and have your vehicle checked by a dealer.

■ Cross Traffic Monitor On and Off

You can switch on and off the system using the audio/information screen.

1. Press the **SETTINGS** button.
2. Rotate  to select **Camera Settings**, then press .
3. Rotate  to select **Cross Traffic Monitor**, then press .
4. Rotate  to select **On** or **Off**, then press .
5. Press the **BACK** button to exit the menu.

About Your Multi-View Rear Camera

See the Navigation System Manual.

Fuel Information

■ Fuel recommendation

Unleaded premium gasoline, pump octane number 91 or higher

Use of lower octane gasoline can cause occasional metallic knocking noise in the engine and will result in decreased engine performance.

Use of gasoline with a pump octane less than 87 can lead to engine damage.

■ Top tier detergent gasoline

Because the level of detergency and additives in gasoline vary in the market, Acura endorses the use of "TOP TIER Detergent Gasoline" where available to help maintain the performance and reliability of your vehicle. TOP TIER Detergent Gasoline meets a new gasoline standard jointly established by leading automotive manufacturers to meet the needs of today's advanced engines.

Qualifying gasoline retailers will, in most cases, identify their gasoline as having met "TOP TIER Detergent Gasoline" standards at the retail location. This fuel is guaranteed to contain the proper level of detergent additives and be free of metallic additives. The proper level of detergent additives, and absence of harmful metallic additives in gasoline, help avoid build-up of deposits in your engine and emission control system.

For further important fuel-related information for your vehicle, or on information on gasoline that does not contain MMT, visit Acura Owners at owners.acura.com In Canada, visit www.acura.ca for additional information on gasoline. For more information on top tier gasoline, visit www.toptiergas.com.

■ Fuel tank capacity: 19.4 US gal (73.3 liters)

⌘ Fuel Information

NOTICE

We recommend quality gasoline containing detergent additives that help prevent fuel system and engine deposits. In addition, in order to maintain good performance, fuel economy, and emissions control, we strongly recommend the use of gasoline that does NOT contain harmful manganese-based fuel additives such as MMT, if such gasoline is available.

Use of gasoline with these additives may adversely affect performance, and cause the malfunction indicator lamp on your instrument panel to come on. If this happens, contact a dealer for service. Some gasoline today is blended with oxygenates such as ethanol. Your vehicle is designed to operate on oxygenated gasoline containing up to 15% ethanol by volume. Do not use gasoline containing methanol. If you notice any undesirable operating symptoms, try another service station or switch to another brand of gasoline.

How to Refuel

Your fuel tank is not equipped with a fuel filler cap. You can insert the filler nozzle directly into the filler neck. The tank seals itself again when you pull out the filler nozzle.



1. Stop your vehicle with the service station pump on the left side of the vehicle in the rear.
2. Turn off the power system.
3. Press the fuel fill door release button.
 - ▶ The fuel fill door opens.

How to Refuel

⚠ WARNING

Gasoline is highly flammable and explosive. You can be burned or seriously injured when handling fuel.

- Turn the power system off, and keep heat, sparks, and flame away.
- Handle fuel only outdoors.
- Wipe up spills immediately.

The fuel filler opening is designed to accept only service station filler nozzles for refueling. Use of smaller diameter tubes (e.g., those used to siphon fuel for other uses) or other non-service station devices can damage the area in and around the filler opening.

The filler nozzle automatically stops to leave space in the fuel tank so that fuel does not overflow as a result of changes in air temperature.

If the filler nozzle keeps turning off when the tank is not full, there may be a problem with the pump's fuel vapor recovery system. Try filling at another pump. If this does not fix the problem, consult a dealer.

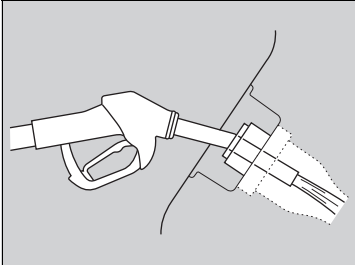

4. Place the end of the filler nozzle on the lower part of filler opening, then insert it slowly and fully.
 - ▶ Make sure that the end of the filler nozzle goes down along with the filler pipe.
 - ▶ Keep the filler nozzle level.
 - ▶ When the tank is full, the filler nozzle will click off automatically.
 - ▶ After filling, wait about five seconds before removing the filler nozzle.
5. Shut the fuel fill door by hand.

▶▶ How to Refuel

Do not continue to add fuel after the filler nozzle has automatically stopped. Additional fuel can exceed the full tank capacity.

If you have to refuel your vehicle from a portable container, use the funnel provided with your vehicle.

▶▶ **Refueling From a Portable Fuel Container**

P. 430

Improving Fuel Economy and Reducing CO₂ Emissions

Achieving fuel economy and reducing CO₂ emissions is dependent on several factors, including driving conditions, load weight, idling time, driving habits, and vehicle condition. Depending on these and other factors, you may not achieve the rated fuel economy of this vehicle.

Maintenance and Fuel Economy

You can optimize your fuel economy with proper maintenance of your vehicle. Always maintain your vehicle in accordance with the messages displayed on the MID.

- Use the recommended viscosity engine oil, displaying the API Certification Seal.
- Maintain the specified tire pressure.
- Do not load the vehicle with excess cargo.
- Keep your vehicle clean. A buildup of snow or mud on your vehicle's underside adds weight and increases wind resistance.

Improving Fuel Economy and Reducing CO₂ Emissions

Direct calculation is the recommended method to determine actual fuel consumed while driving.

$$\begin{array}{ccccccc} \boxed{\text{Miles driven}} & \div & \boxed{\text{Gallons of fuel}} & = & \boxed{\text{Miles per Gallon}} \\ \boxed{100} & \times & \boxed{\text{Liter}} & \div & \boxed{\text{Kilometers}} & = & \boxed{\text{L per 100 km}} \end{array}$$

In Canada, posted fuel economy numbers are established following a simulated test. For more information on how this test is performed, please visit <http://loee.nrcan.gc.ca/>

Maintenance

This chapter discusses basic maintenance.



Before Performing Maintenance

Inspection and Maintenance	332
Safety When Performing Maintenance...	333
Parts and Fluids Used in Maintenance Service...	334

Maintenance Minder™

335

Maintenance Under the Hood

Maintenance Items Under the Hood..	339
Opening the Hood	340
Engine Compartment Cover	341
Recommended Engine Oil	342
Oil Check	343
Adding Engine Oil	344
Changing the Engine Oil and Oil Filter...	345

Cooling System	347
Transmission Fluid	350
Brake Fluid	351
Refilling Window Washer Fluid	351

Replacing Light Bulbs

352

Checking and Maintaining Wiper Blades... ..

357

Checking and Maintaining Tires

Checking Tires	361
Tire and Loading Information Label ..	362
Tire Labeling	362
DOT Tire Quality Grading (U.S. Vehicles)..	364
Wear Indicators	366
Tire Service Life	366

Tire and Wheel Replacement	367
----------------------------------	-----

Tire Rotation	368
---------------------	-----

Winter Tires	369
--------------------	-----

12-Volt Battery

370

Remote Transmitter Care

Replacing the Button Battery	371
------------------------------------	-----

Remote Control and Wireless

Headphone Care*	372
-----------------------	-----

Climate Control System Maintenance ..

374

Cleaning

Interior Care	375
Exterior Care	377

Accessories and Modifications

380

* Not available on all models

Inspection and Maintenance

For your safety, perform all listed inspections and maintenance to keep your vehicle in good condition. If you become aware of any abnormality (noise, smell, insufficient brake fluid, oil residue on the ground, etc.), have your vehicle inspected by a dealer. (Note, however, that service at a dealer is not mandatory to keep your warranties in effect.) Refer to the separate maintenance booklet for detailed maintenance and inspection information.

Types of Inspection and Maintenance

■ Daily inspections

Perform inspections before long distance trips, when washing the vehicle, or when refueling.

■ Periodic inspections

- Check the brake fluid level monthly.
 - **Checking the Brake Fluid** P. 351
- Check the tire pressure monthly. Examine the tread for wear and foreign objects.
 - **Checking and Maintaining Tires** P. 361
- Check the operation of the exterior lights monthly.
 - **Replacing Light Bulbs** P. 352
- Check the condition of the wiper blades at least every six months.
 - **Checking and Maintaining Wiper Blades** P. 357

Inspection and Maintenance

U.S. models

Maintenance, replacement, or repair of emissions control devices and systems may be done by any automotive repair establishment or individuals using parts that are "certified" to EPA standards.

According to state and federal regulations, failure to perform maintenance on the maintenance main items marked with # will not void your emissions warranties. However, all maintenance services should be performed in accordance with the intervals indicated by the multi-information display (MID).

➤ **Maintenance Service Items** P. 337

If you want to perform complex maintenance tasks that require more skills and tools, you can purchase a subscription to the Service Express website at www.techinfo.honda.com.

➤ **Authorized Manuals** P. 440

If you want to perform maintenance yourself, make sure that you have the necessary tools and skills first. After performing maintenance, update the records in the separate maintenance booklet.

Safety When Performing Maintenance

Some of the most important safety precautions are given here. However, we cannot warn you of every conceivable hazard that can arise in performing maintenance. Only you can decide whether you should perform a given task.

Maintenance Safety

- To reduce the possibility of fire or explosion, keep cigarettes, sparks, and flames away from the 12-volt battery, all High Voltage system, and all fuel related parts.
- Never leave rags, towels, or other flammable objects under the hood.
 - ▶ Heat from the engine and exhaust can ignite them, causing a fire.
- To clean parts, use a commercially available degreaser or parts cleaner, not gasoline.
- Wear eye protection and protective clothing when working with the 12-volt battery or compressed air.
- Engine exhaust contains carbon monoxide, which is poisonous and can kill you.
 - ▶ Only operate the engine if there is sufficient ventilation.

ⓘ Safety When Performing Maintenance

WARNING

Improperly maintaining this vehicle or failing to correct a problem before driving can cause a crash in which you can be seriously hurt or killed.

Always follow the inspection and maintenance recommendations according to the schedules in this owner's manual.

WARNING

Failure to properly follow maintenance instructions and precautions can cause you to be seriously hurt or killed.

Always follow the procedures and precautions in this owner's manual.

Continued

■ Vehicle Safety

- The vehicle must be in a stationary condition.
 - ▶ Make sure your vehicle is parked on level ground, the parking brake is set, and the power system is turned off.
- Be aware that hot parts can burn you.
 - ▶ Make sure to let the power system including the engine and exhaust system cool thoroughly before touching vehicle parts.
- Be aware that moving parts can injure you.
 - ▶ Do not activate the power system unless instructed, and keep your hands and limbs away from moving parts. When the power system is on, the engine can automatically start, or the radiator fan may start operating without the engine running.

Parts and Fluids Used in Maintenance Service

The use of Acura genuine parts and fluids is recommended when maintaining and servicing your vehicle. Acura genuine parts are manufactured according to the same high quality standards used in Acura vehicles.

▣ Parts and Fluids Used in Maintenance Service

NOTICE

Do not press the engine cover forcibly. This may damage the engine cover and component parts.

If the engine oil life is less than 15%, you will see the Maintenance Minder messages appear on the multi-information display (MID) every time you set the power mode to ON. The messages notify you when to change the engine oil, or when to bring your vehicle to a dealer for indicated maintenance services.

To Use Maintenance Minder™

■ Displaying the Maintenance Minder Information

Maintenance items, which should be serviced at the same time that you replace the engine oil, appear on the MID.

You can view them on the engine oil life screen at any time.

1. Set the power mode to ON.
2. Roll the multi-function steering-wheel controls until the engine oil life appears on the MID.

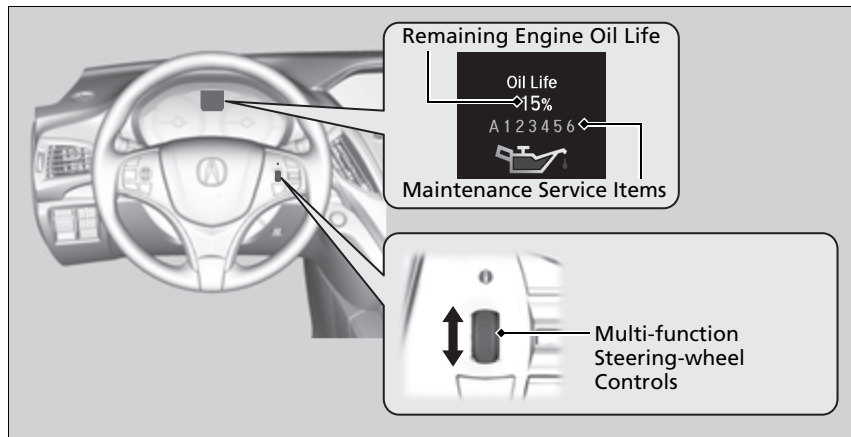

▣ Displaying the Maintenance Minder Information

Based on the engine operating conditions, the remaining engine oil life is calculated and displayed as a percentage.







Displayed Engine Oil Life (%)	Calculated Engine Oil Life (%)
100	100 to 91
90	90 to 81
80	80 to 71
70	70 to 61
60	60 to 51
50	50 to 41
40	40 to 31
30	30 to 21
20	20 to 16
15	15 to 11
10	10 to 6
5	5 to 1
0	0

There is a list of maintenance main and sub items you can view on the MID.

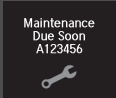
▣ **Maintenance Service Items P. 337**

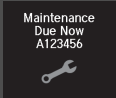
Continued

Maintenance Minder Messages on the Multi-Information Display (MID)

Maintenance Message	Oil Life Display	Explanation	Information
<p>Maintenance Due Soon</p> 	<p>15%</p> 	<p>The remaining engine oil life is 15 to 6 percent. Once you switch the display by rolling the multi-function steering-wheel controls, this message will go off.</p>	<p>The engine oil is approaching the end of its service life, and the maintenance items should be inspected and serviced soon.</p>
<p>Maintenance Due Now</p> 	<p>5%</p> 	<p>The remaining engine oil life is 5 to 1 percent. Roll the multi-function steering-wheel controls to switch to another display.</p>	<p>The engine oil has almost reached the end of its service life, and the maintenance items should be inspected and serviced as soon as possible.</p>
<p>Maintenance Past Due</p> 	<p>Negative Distance</p> <div style="display: flex; justify-content: space-around;"> <div style="text-align: center;"> <p>U.S.</p>  </div> <div style="text-align: center;"> <p>Canada</p>  </div> </div>	<p>The remaining engine oil life has passed its service life, and a negative distance appears after driving over 10 miles (U.S. models) or 10 km (Canadian models). Roll the multi-function steering wheel control to switch to another display.</p>	<p>The engine oil life has passed. The maintenance items must be inspected and serviced immediately.</p>

The system message indicator (ⓘ) comes on along with the Maintenance Minder message.

Maintenance Service Items

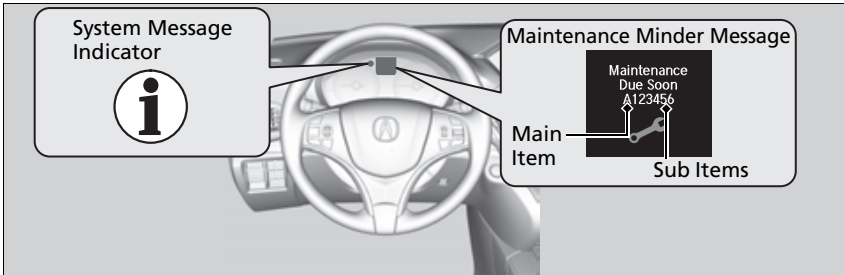

Maintenance Service Items

- Independent of the Maintenance Minder information, replace the brake fluid every 3 years.
- Inspect idle speed every 160,000 miles (256,000 km).
- Adjust the valves during services A, B, 1, 2, or 3 if they are noisy.

CODE	Maintenance Main Items
A	<ul style="list-style-type: none"> • Replace engine oil*¹
B	<ul style="list-style-type: none"> • Replace engine oil*¹ and oil filter • Inspect front and rear brakes • Check expiration date for Temporary Tire Repair Kit bottle* • Inspect tie rod ends, steering gearbox, boots, and drain plug • Inspect suspension components • Inspect driveshaft boots • Inspect brake hoses and lines (Including ABS/VA) • Inspect all fluid levels and condition of fluids • Inspect exhaust system# • Inspect fuel lines and connections#

*1: If the message **Maintenance Due Now** does not appear more than 12 months after the display is reset, change the engine oil every year.

#: See information on maintenance and emissions warranty.

*2: If you drive in dusty conditions, replace the air cleaner element every 15,000 miles (24,000 km).

*3: If you drive primarily in urban areas that have high concentrations of soot in the air from industry and from diesel-powered vehicles, replace the dust and pollen filter every 15,000 miles (24,000 km).

* Not available on all models

CODE	Maintenance Sub Items
1	<ul style="list-style-type: none"> • Rotate tires
2	<ul style="list-style-type: none"> • Replace air cleaner element*² • Replace dust and pollen filter*³ • Inspect drive belt
3	<ul style="list-style-type: none"> • Replace transmission fluid*⁴
4	<ul style="list-style-type: none"> • Replace spark plugs • Replace timing belt and inspect water pump*⁵ • Inspect valve clearance
5	<ul style="list-style-type: none"> • Replace engine coolant
6	<ul style="list-style-type: none"> • Replace twin motor unit fluid*⁶

*4: Driving in mountainous areas at very low vehicle speeds results in higher transmission temperature. This requires transmission fluid changes more frequently than recommended by the Maintenance Minder. If you regularly drive your vehicle under these conditions, have the transmission fluid changed at 30,000 miles (48,000 km), then every 25,000 miles (40,000 km).

*5: If you drive regularly in very high temperatures (over 110°F, 43°C), in very low temperatures (under -20°F, -29°C), replace every 60,000 miles/100,000 km.

*6: Driving in mountainous areas at very low vehicle speeds results in higher level of mechanical (Shear) stress to fluid. This requires twin motor unit fluid changes more frequently than recommended by the Maintenance Minder. If you regularly drive your vehicle under these conditions, have the twin motor unit fluid changed at 7,500 miles (12,000 km), then every 15,000 miles (24,000 km).

Continued

■ Resetting the Display

Reset the engine oil life display if you have performed the maintenance service.

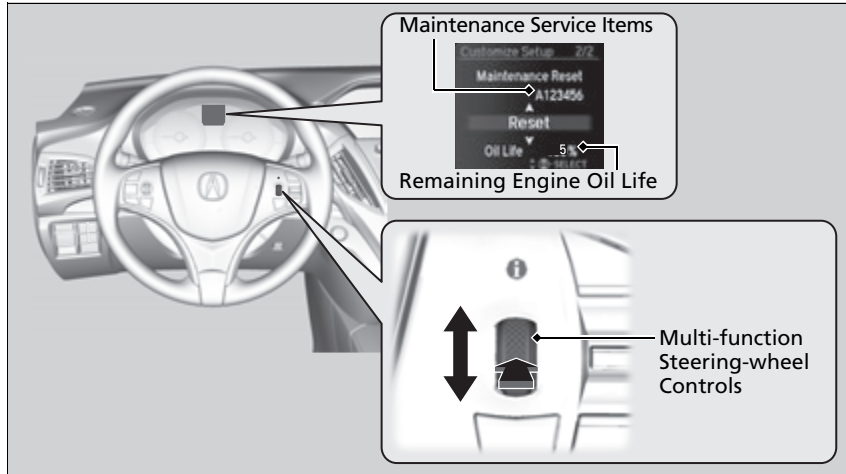

1. Set the power mode to ON.
2. Go to the **Maintenance Info.** group.
 - **Customized Features** P. 125
3. Push the multi-function steering-wheel controls.
 - The oil life reset mode is displayed on the MID.
4. Select **Reset** with the multi-function steering-wheel controls, then push the multi-function steering wheel control.
 - The displayed maintenance items disappear, and the engine oil life display returns to **100%**.
 - To cancel the oil life reset mode, select **Cancel**, then push the multi-function steering-wheel controls.

►► Resetting the Display

NOTICE

Failure to reset the engine oil life after a maintenance service results in the system showing incorrect maintenance intervals, which can lead to serious mechanical problems.

The dealer will reset the engine oil life display after completing the required maintenance service. If someone other than a dealer performs maintenance service, reset the engine oil life display yourself.

Maintenance Items Under the Hood

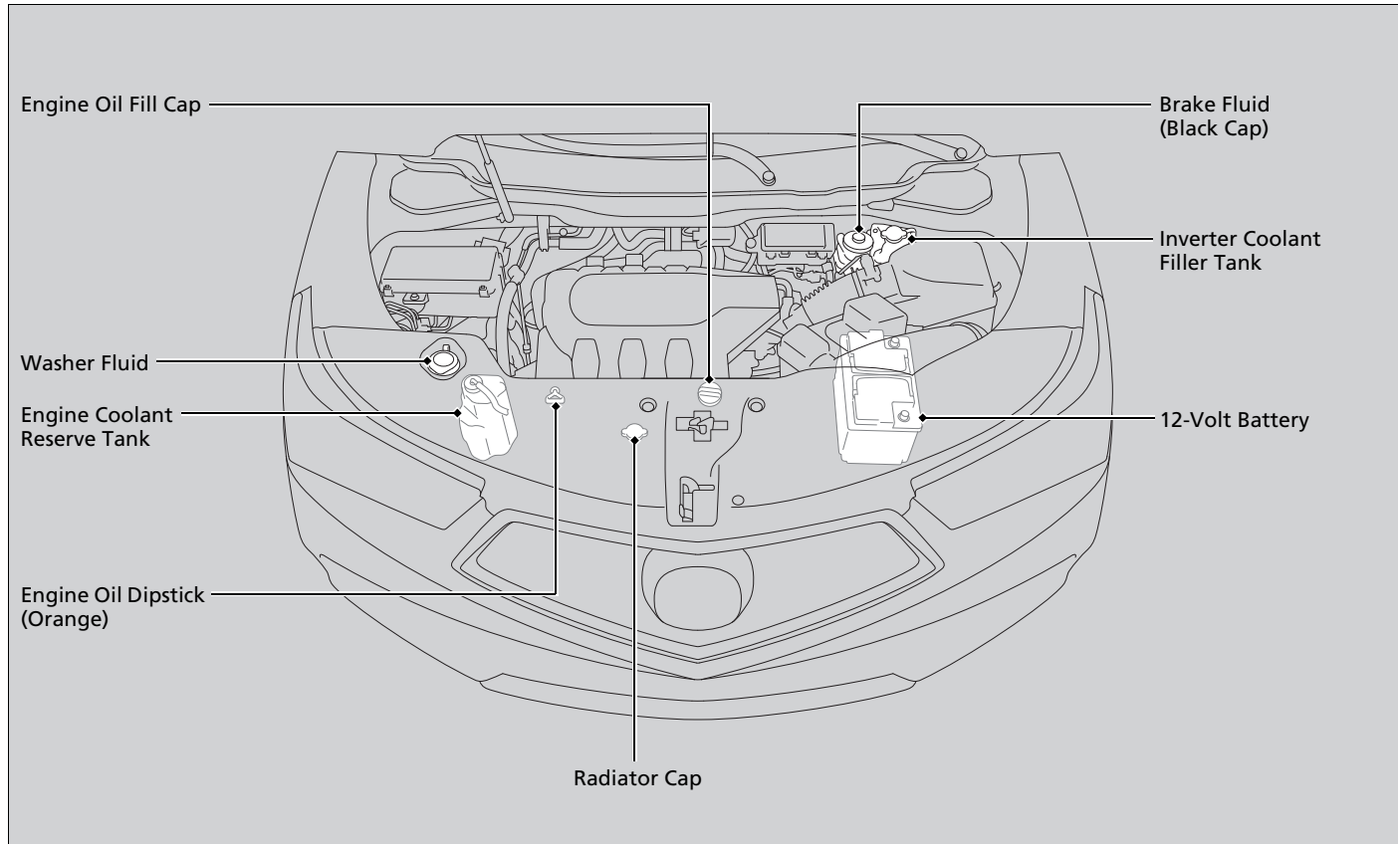

Opening the Hood

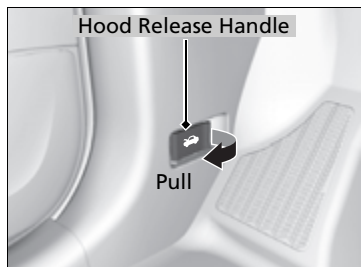

1. Park the vehicle on a level surface, and set the parking brake.
2. Pull the hood release handle under the driver's side lower corner of the dashboard.
 - The hood will pop up slightly.

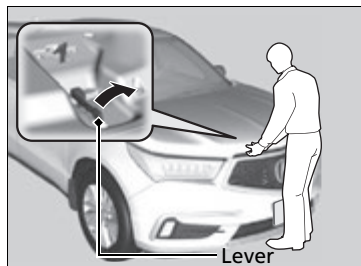

3. Pull up the hood latch lever (located under the front edge of the hood to the center) and raise the hood. Once you have raised the hood slightly, you can release the lever.



4. Lift the hood up most of the way.
 - The hydraulic supports will lift it up the rest of the way and hold it up.

When closing, lower it to approximately 12 inches (30 cm), then press down firmly with your hands.

►► Opening the Hood

NOTICE

Do not open the hood when the wiper arms are raised. The hood will strike the wipers, resulting in damage to the hood and/or the wipers.

Do not press the engine cover forcibly. This may damage the engine cover and component parts.

When closing the hood, check that the hood is securely latched.

If the hood latch lever moves stiffly, or if you can open the hood without lifting the lever, the latch mechanism should be cleaned and lubricated.

Engine Compartment Cover

The component parts in the engine compartment are protected by a cover. You may need to remove the cover when you perform certain maintenance work. Pull up on the engine compartment cover carefully until all pins are removed from their grommets.

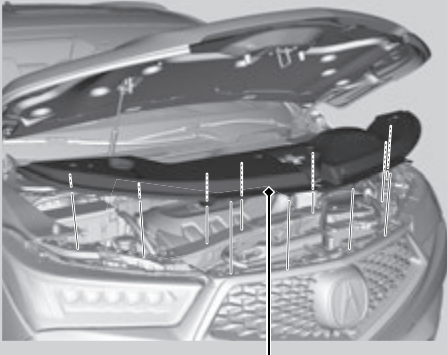

Remove the Engine Compartment Cover

Recommended Engine Oil

- **Genuine Acura Motor Oil**
- **Premium-grade 0W-20 detergent oil with an API Certification Seal on the container.**



Oil is a major contributor to your engine's performance and longevity. If you drive the vehicle with insufficient or deteriorated oil, the engine may fail or be damaged.

This seal indicates the oil is energy conserving and that it meets the American Petroleum Institute's latest requirements.

Use a Genuine Acura Motor Oil or another commercial engine oil of suitable viscosity for the ambient temperature as shown.

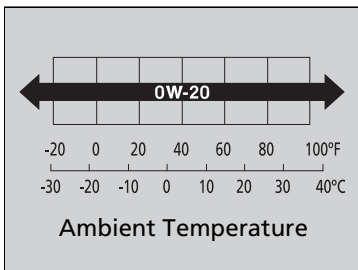

■ Synthetic oil

You may also use synthetic motor oil if it is labeled with the API Certification Seal and is the specified viscosity grade.

►► Recommended Engine Oil

Engine Oil Additives

Your vehicle does not require oil additives. In fact, they may adversely affect the engine performance and durability.

Oil Check

We recommend that you check the engine oil level every time you refuel.

Park the vehicle on level ground.

Turn off the power system. You can check the oil level without the engine having run beforehand. If the engine has been running, wait approximately three minutes before you check the oil.



1. Remove the dipstick (orange).
2. Wipe the dipstick with a clean cloth or paper towel.
3. Insert the dipstick back all the way into its hole.

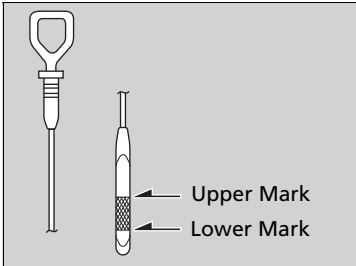

4. Remove the dipstick again, and check the level. It should be between the upper and lower marks. Add oil if necessary.

Oil Check

If the oil level is near or below the lower mark, slowly add oil, being careful not to overfill.

Adding Engine Oil

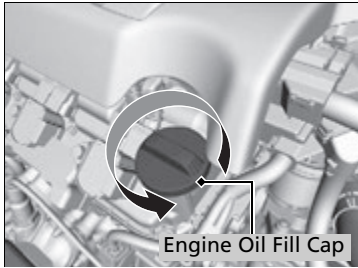

1. Unscrew and remove the engine oil fill cap.
2. Add oil slowly.
3. Reinstall the engine oil fill cap, and tighten it securely.
4. Wait for three minutes and recheck the engine oil dipstick.

► Adding Engine Oil

NOTICE

Do not fill the engine oil above the upper mark. Overfilling the engine oil can result in leaks and engine damage.

If any oil spills, wipe it away immediately. Spilled oil may damage the engine compartment components.

Changing the Engine Oil and Oil Filter

You must change the engine oil and oil filter regularly in order to maintain the engine's lubrication. The engine may be damaged if they are not changed regularly.

Change the oil and filter in accordance with the maintenance message on the multi-information display.

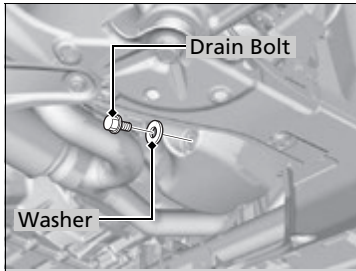

1. Run the engine until it reaches normal operating temperature, and then turn the engine off.
2. Open the hood and remove the engine oil fill cap.
3. Remove the drain bolt and washer from the bottom of the engine, and drain the oil into a suitable container.

Changing the Engine Oil and Oil Filter

NOTICE

You may damage the environment if you do not dispose of the oil in a suitable way. If you are changing the oil by yourself, appropriately dispose of the used oil. Put the oil in a sealed container and take it to a recycling center. Do not throw the oil away into a garbage can or onto the ground.

Continued

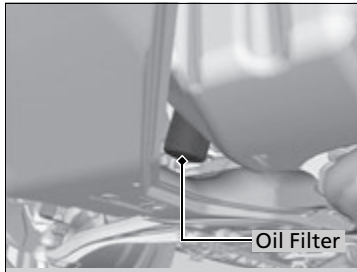

4. Remove the oil filter and dispose of the remaining oil.
5. Check that the filter gasket is not stuck to the engine contact surface.
 - If it is stuck, you must detach it.
6. Wipe away dirt and dust adhering to the contact surface of the engine block, and install a new oil filter.
 - Apply a light coat of new engine oil to the filter gasket.
7. Put a new washer on the drain bolt, then reinstall the drain bolt.
 - Tightening torque:
29 lbf·ft (39 N·m, 4.0 kgf·m)
8. Pour the recommended engine oil into the engine.
 - Engine oil change capacity (including filter):
4.5 US qt (4.3 ℓ)
9. Reinstall the engine oil fill cap securely and start the engine.
10. Run the engine for a few minutes, and then check that there is no leak from the drain bolt or oil filter.
11. Stop the engine, wait for three minutes, and then check the oil level on the dipstick.
 - If necessary, add more engine oil.

✎ Changing the Engine Oil and Oil Filter

You will need a special wrench to replace the oil filter. You can buy this wrench from a dealer.

When installing the new oil filter, follow the instructions supplied with the oil filter.

Reinstall the engine oil fill cap. Start the engine. The low oil pressure indicator should go off within five seconds. If it does not, turn off the engine, and check your work.

Cooling System

Specified coolant: Acura Long Life Antifreeze/Coolant Type 2

This coolant is premixed with 50% antifreeze and 50% water. Do not add any straight antifreeze or water.

We recommend you check the engine coolant level every time you refuel. Check the reserve tank first. If it is completely empty, also check the coolant level in the radiator. Add the engine coolant accordingly.

Reserve Tank

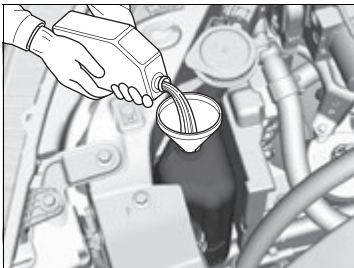
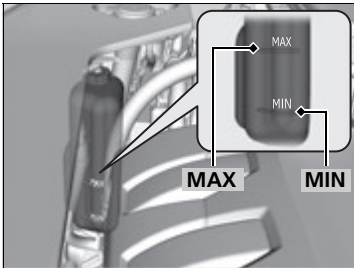

1. Make sure the engine and radiator are cool.
2. Check the amount of coolant in the reserve tank.
 - If the coolant level is below the **MIN** mark, add the specified coolant until it reaches the **MAX** mark.
3. Inspect the cooling system for leaks.

🔧 **Engine Compartment Cover** P. 341

⚠ Cooling System

⚠ WARNING

Removing the radiator cap while the engine is hot can cause the coolant to spray out, seriously scalding you.

Always let the engine and radiator cool down before removing the radiator cap.

NOTICE

Genuine Acura engine coolant is a 50/50 mixture of antifreeze and water that can withstand freezing at temperatures as low as about -31°F (-35°C). If your vehicle is consistently subjected to temperatures below this, the concentration of antifreeze in the coolant should be increased. Consult a dealer for details.

If Acura antifreeze/coolant is not available, you may use another major brand of non-silicate coolant as a temporary replacement. Check that it is a high quality coolant recommended for aluminum engines. Continued use of any non-Acura coolant can result in corrosion, causing the cooling system to malfunction or fail. Have the cooling system flushed and refilled with Acura antifreeze/coolant as soon as possible.

Do not add rust inhibitors or other additives to your vehicle's cooling system. They may not be compatible with the coolant or with the engine components.

Continued

■ Radiator

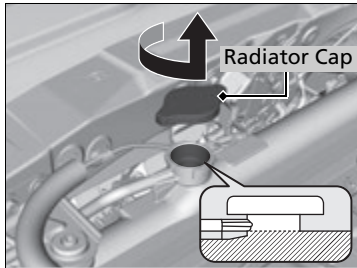

1. **Make sure the engine and radiator are cool.**
2. Remove the engine compartment cover.
 ➤ **Engine Compartment Cover** P. 341
3. Turn the radiator cap 1/8 turn counter-clockwise and relieve any pressure in the coolant system.
4. Push down and turn the radiator cap counter-clockwise to remove it.
5. The coolant level should be up to the base of the filler neck. Add coolant if it is low.
6. Put the radiator cap back on, and tighten it fully.

☞ Radiator

NOTICE

Pour the fluid slowly and carefully so you do not spill any. Clean up any spills immediately; they can damage components in the engine compartment.

Inverter Coolant

Specified coolant: Acura Long Life Antifreeze/Coolant Type 2

This coolant is premixed with 50% antifreeze and 50% water. Do not add any straight antifreeze or water.

We recommend you check the inverter coolant level every time you refuel. Check the filler tank. Add the inverter coolant accordingly.

Have a dealer replace the inverter coolant.

Checking the Coolant

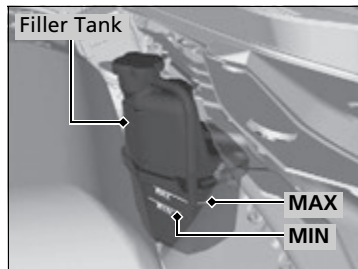

1. Check the fluid level in the tank.
2. If the coolant level has dropped below the **MIN** level, have your vehicle serviced at a dealer.
 - Only a properly trained technician can refill the coolant and check the system for leaks.

⌘ Inverter Coolant

NOTICE

Genuine Acura engine coolant is a 50/50 mixture of antifreeze and water that can withstand freezing at temperatures as low as about -31°F (-35°C). If your vehicle is consistently subjected to temperatures below this, the concentration of antifreeze in the coolant should be increased. Consult a dealer for details.

If Acura antifreeze/coolant is not available, you may use another major brand of non-silicate coolant as a temporary replacement. Check that it is a high quality coolant recommended for aluminum engines. Continued use of any non-Acura coolant can result in corrosion, causing the cooling system to malfunction or fail. Have the cooling system flushed and refilled with Acura antifreeze/coolant as soon as possible.

Do not add rust inhibitors or other additives to your vehicle's coolant system. They may not be compatible with the coolant or with the motor components.

Transmission Fluid

■ Dual Clutch Transmission Fluid

Specified fluid: Acura Automatic Transmission Fluid ATF DW-1

Have a dealer check the fluid level and replace if necessary.

Do not attempt to check or change the dual clutch transmission fluid yourself.

⌘ Dual Clutch Transmission Fluid

NOTICE

Do not mix Acura ATF DW-1 with other transmission fluids.

Using a transmission fluid other than Acura ATF DW-1 may adversely affect the operation and durability of your vehicle's transmission, and damage the transmission.

Any damage caused by using a transmission fluid that is not equivalent to Acura ATF DW-1 is not covered by Acura's new vehicle limited warranty.

Brake Fluid

Specified fluid: Acura Heavy Duty Brake Fluid DOT 3

Checking the Brake Fluid

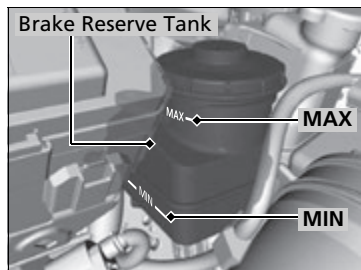

The fluid level should be between the **MIN** and **MAX** marks on the side of the reserve tank.

Refilling Window Washer Fluid

If the washer fluid is low, a message appears on the MID. Pour the washer fluid carefully. Do not overflow the reservoir.

Brake Fluid

NOTICE

Brake fluid marked DOT 5 is not compatible with your vehicle's braking system and can cause extensive damage.

If the specified brake fluid is not available, you should use only DOT 3 or DOT 4 fluid from a sealed container as a temporary replacement.

Using any non-Acura brake fluid can cause corrosion and decrease the longevity of the system. Have the brake system flushed and refilled with Acura Heavy Duty Brake Fluid DOT 3 as soon as possible.

If the brake fluid level is at or below the **MIN** mark, have a dealer inspect the vehicle for leaks or worn brake pads as soon as possible.

Refilling Window Washer Fluid

NOTICE

Do not use engine antifreeze or a vinegar/water solution in the windshield washer reservoir. Antifreeze can damage your vehicle's paint. A vinegar/water solution can damage the windshield washer pump.

Headlights

Headlights are LED type. Have an authorized Acura dealer inspect and replace the light assembly.

Front Turn Signal/Parking, Daytime Running and Front Side Marker Lights

Front turn signal/parking, daytime running and front side marker lights are LED type. Have an authorized Acura dealer inspect and replace the light assembly.

Fog Lights*

Fog lights are LED type. Have an authorized Acura dealer inspect and replace the light assembly.

Side Turn Signal/Emergency Indicator Lights

Door mirror side turn lights are LED type. Have an authorized Acura dealer inspect and replace the light assembly.

Headlights

The headlight aim is set by the factory, and does not need to be adjusted. However, if you regularly carry heavy items in the cargo area, have the aiming readjusted at a dealer or by a qualified technician.

Brake Light and Rear Turn Signal Light Bulbs

When replacing, use the following bulbs.

Brake Light: 21 W
Rear Turn Signal Light: 21 W

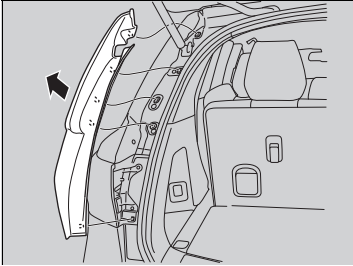

1. Remove the cover.
 - ▶ Starting at the bottom, carefully pull the cover straight out, working upward until all pins are removed from their grommets.
 - ▶ The grommets should remain in the body.

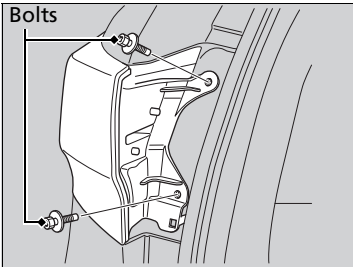

2. Use a Phillip-head screwdriver to remove the bolts.
3. Pull the light assembly out of the rear pillar.

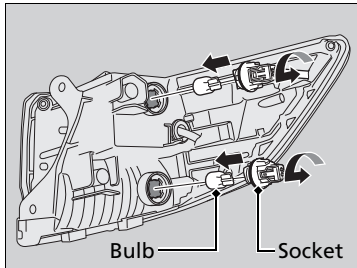

4. Turn the socket counter-clockwise and remove it. Remove the old bulb.
5. Insert a new bulb.
6. Slide the light assembly onto the guide on the body.
7. Align the pins with the body grommets, then push in until they fully seat.

Taillights/Rear Side Maker Lights

Taillights/rear side maker lights are the LED type. Have an authorized Acura dealer inspect and replace the light assembly.

Back-Up Light Bulbs

When replacing, use the following bulbs.

Back-Up Light: 21 W

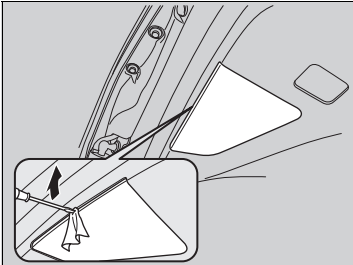

1. Remove the cover by prying on the edge using a flat-tip screwdriver.
 - ▶ Wrap the flat-tip screwdriver with a cloth to prevent scratches.

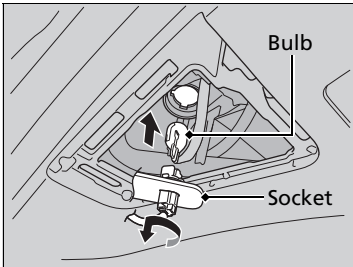

2. Turn the socket counter-clockwise and remove it. Remove the old bulb.
3. Insert a new bulb.

Taillights

Taillights are the LED type. Have an authorized Acura dealer inspect and replace the light assembly.

Rear License Plate Lights

Rear license plate lights are LED type. Have an authorized Acura dealer inspect and replace the light assembly.

High-Mount Brake Light

High-mount brake light is LED type. Have an authorized Acura dealer inspect and replace the light assembly.

Puddle Lights

Puddle lights are LED type. Have an authorized Acura dealer inspect and replace the light assembly.

Checking Wiper Blades

If the wiper blade rubber has deteriorated, it will leave streaks and the hard surfaces of the blade may scratch the window glass.

Changing the Front Wiper Blade Rubber

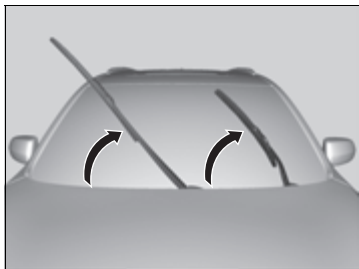

1. Lift the driver side wiper arm first, then the passenger side.

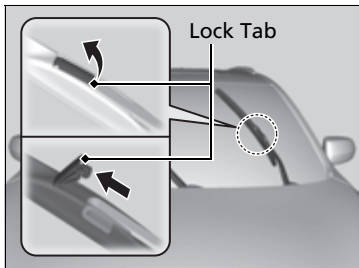

2. Pry on the edge of the lock tab using a flat-tip screwdriver to push it up. Wrap the flat-tip screwdriver with a cloth to prevent scratches.
3. Slide the holder off the wiper arm.

✘ Changing the Front Wiper Blade Rubber

NOTICE

Avoid dropping the wiper arm onto the windshield, it may damage the wiper arm and/or the windshield.

Continued

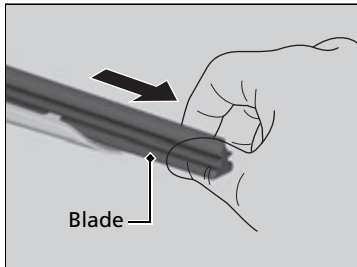

4. Slide the wiper blade out of the holder by pulling the tabbed end out.

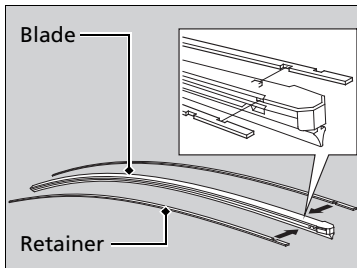

5. Remove the retainers from the wiper blade that has been removed, and mount to a new wiper blade.
 - ▶ Correctly align the wiper blade protrusion and the retainer grooves.

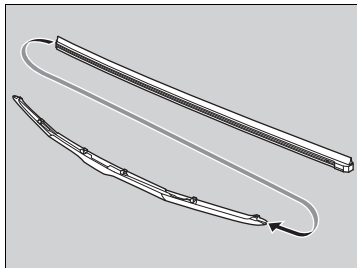

6. Slide the new wiper blade onto the holder from the bottom end.
 - ▶ The tab on the holder should fit in the indent of the wiper blade.
7. Slide the holder onto the wiper arm, then push down the lock tab.
8. Lower the passenger side wiper arm first, then the driver side.

Changing the Rear Wiper Blade Rubber

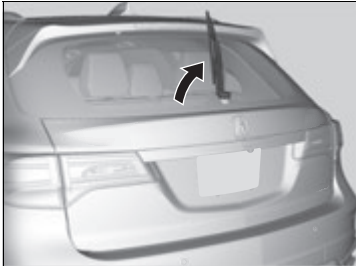

1. Raise the wiper arm off.

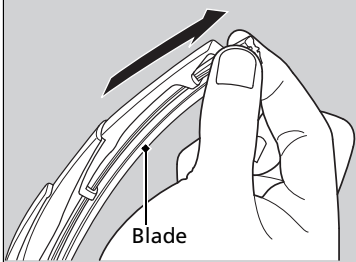

2. Slide the wiper blade out from the end with the indent.

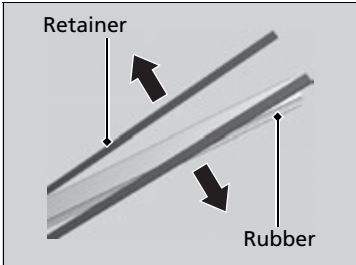

3. Remove the retainers from wiper blade and mount to a new rubber blade.

Changing the Rear Wiper Blade Rubber

NOTICE

Avoid dropping the wiper arm, it may damage the rear window.

Continued

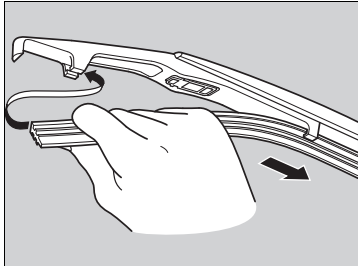

4. Slide the new wiper blade onto the holder.
 - ▶ Make sure it is engaged correctly, then install the wiper blade assembly onto the wiper arm.

Checking Tires

To safely operate your vehicle, your tires must be of the proper type and size, in good condition with adequate tread, and properly inflated.

■ Inflation guidelines

Properly inflated tires provide the best combination of handling, tread life, and comfort. Refer to the driver's doorjamb label or specifications page for the specified pressure.

Underinflated tires wear unevenly, adversely affect handling and fuel economy, and are more likely to fail from overheating.

Overinflated tires make your vehicle ride harshly, are more prone to road hazards, and wear unevenly.

Every day before you drive, look at each of the tires. If one looks lower than the others, check the pressure with a tire gauge.

At least once a month or before long trips, use a gauge to measure the pressure in all tires, including the spare*. Even tires in good condition can lose 1–2 psi (10–20 kPa, 0.1–0.2 kgf/cm²) per month.

■ Inspection guidelines

Every time you check inflation, also examine the tires and valve stems. Look for:

- Bumps or bulges on the side or in the tread. Replace the tire if you find any cuts, splits, or cracks in the side of the tire. Replace it if you see fabric or cord.
- Remove any foreign objects and inspect for air leaks.
- Uneven tread wear. Have a dealer check the wheel alignment.
- Excessive tread wear.

➤ **Wear Indicators** P. 366

- Cracks or other damage around valve stem.

* Not available on all models

☒ Checking Tires

⚠ WARNING

Using tires that are excessively worn or improperly inflated can cause a crash in which you can be seriously hurt or killed.

Follow all instructions in this owner's manual regarding tire inflation and maintenance.

Measure the air pressure when tires are cold. This means the vehicle has been parked for at least three hours, or driven less than 1 mile (1.6 km). If necessary, add or release air until the specified pressure is reached.

If checked when hot, tire pressure can be as much as 4–6 psi (30–40 kPa, 0.3–0.4 kgf/cm²) higher than if checked when cold.

Have a dealer check the tires if you feel a consistent vibration while driving. New tires and any that have been removed and reinstalled should be properly balanced.

Tire and Loading Information Label

The label attached to the driver’s doorjamb provides necessary tire and loading information.

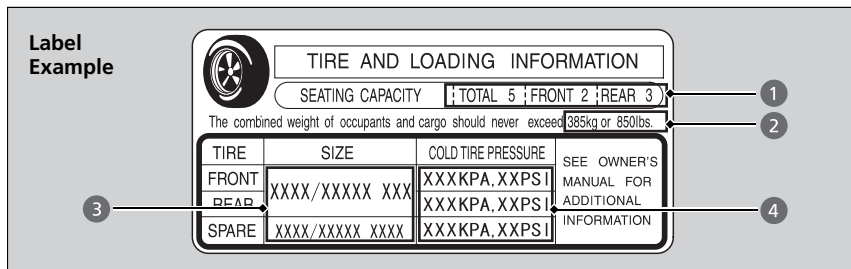

▶▶ Tire and Loading Information Label

The tire and loading information label attached to the driver’s doorjamb contains:

- 1 The number of people your vehicle can carry.
- 2 The total weight your vehicle can carry. Do not exceed this weight.
- 3 The original tire sizes for front, rear, and spare.
- 4 The proper cold tire pressure for front, rear, and spare.

Tire Labeling

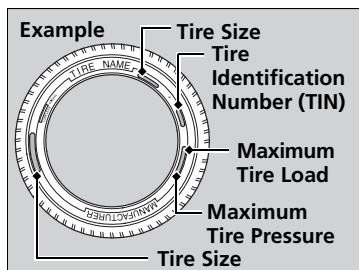

The tires that came on your vehicle have a number of markings. Those you should be aware of are described below.

▶▶ Tire Sizes

Following is an example of tire size with an explanation of what each component means.

P235/60R18 102T

P: Vehicle type (P indicates passenger vehicle).

235: Tire width in millimeters.

60: Aspect ratio (the tire’s section height as a percentage of its width).

R: Tire construction code (R indicates radial).

18: Rim diameter in inches.

102: Load index (a numerical code associated with the maximum load the tire can carry).

T: Speed symbol (an alphabetical code indicating the maximum speed rating).

Tire Sizes

Whenever tires are replaced, they should be replaced with tires of the same size.

■ Tire Identification Number (TIN)

The tire identification number (TIN) is a group of numbers and letters that look like the example in the side column. TIN is located on the sidewall of the tire.

■ Glossary of Tire Terminology

Cold Tire Pressure – The tire air pressure when the vehicle has been parked for at least three hours or driven less than 1 mile (1.6 km).

Load Rating – Means the maximum load that a tire is rated to carry for a given inflation pressure.

Maximum Inflation Pressure – The maximum tire air pressure that the tire can hold.

Maximum Load Rating – Means the load rating for a tire at the maximum permissible inflation pressure for that tire.

Recommended Inflation Pressure – The cold tire inflation pressure recommended by the manufacturer.

Treadwear Indicators (TWI) – Means the projections within the principal grooves designed to give a visual indication of the degrees of wear of the tread.

☒ Tire Identification Number (TIN)

DOT B97R FW6X 2209

DOT: This indicates that the tire meets all requirements of the U.S. Department of Transportation.

B97R: Manufacturer's identification mark.

FW6X: Tire type code.

22 09: Date of manufacture.

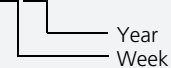

DOT Tire Quality Grading (U.S. Vehicles)

The tires on your vehicle meet all U.S. Federal Safety Requirements. All tires are also graded for treadwear, traction, and temperature performance according to Department of Transportation (DOT) standards. The following explains these gradings.

■ Uniform Tire Quality Grading

Quality grades can be found where applicable on the tire sidewall between tread shoulder and maximum section width.

■ Treadwear

The treadwear grade is a comparative rating based on the wear rate of the tire when tested under controlled conditions on a specified government test course. For example, a tire graded 150 would wear one and one-half (1 1/2) times as well on the government course as a tire graded 100. The relative performance of tires depends upon the actual conditions of their use, however, and may depart significantly from the norm due to variations in driving habits, service practices and differences in road characteristics and climate.

▣ Uniform Tire Quality Grading

For example:
Treadwear 200
Traction AA
Temperature A

All passenger car tires must conform to Federal Safety Requirements in addition to these grades.

■ Traction

The traction grades, from highest to lowest, are AA, A, B, and C. Those grades represent the tire's ability to stop on wet pavement as measured under controlled conditions on specified government test surfaces of asphalt and concrete. A tire marked C may have poor traction performance.

■ Temperature

The temperature grades are A (the highest), B, and C, representing the tire's resistance to the generation of heat and its ability to dissipate heat when tested under controlled conditions on a specified indoor laboratory test wheel. Sustained high temperature can cause the material of the tire to degenerate and reduce tire life, and excessive temperature can lead to sudden tire failure. The grade C corresponds to a level of performance which all passenger car tires must meet under the Federal Motor Vehicle Safety Standard No. 109. Grades B and A represent higher levels of performance on the laboratory test wheel than the minimum required by law.

⌘ Traction

Warning: The traction grade assigned to this tire is based on straight-ahead braking traction tests, and does not include acceleration, cornering, hydroplaning, or peak traction characteristics.

⌘ Temperature

Warning: The temperature grade for this tire is established for a tire that is properly inflated and not overloaded. Excessive speed, underinflation, or excessive loading, either separately or in combination, can cause heat buildup and possible tire failure.

Wear Indicators

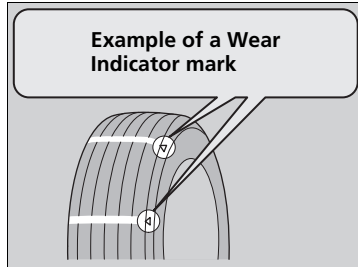

The groove where the wear indicator is located is 1/16 inch (1.6 mm) shallower than elsewhere on the tire. If the tread has worn so that the indicator is exposed, replace the tire.

Worn out tires have poor traction on wet roads.

Tire Service Life

The life of your tires is dependent on many factors, including driving habits, road conditions, vehicle loading, inflation pressure, maintenance history, speed, and environmental conditions (even when the tires are not in use).

In addition to regular inspections and inflation pressure maintenance, it is recommended that you have annual inspections performed once the tires reach five years old. All tires, including the spare*, should be removed from service after 10 years from the date of manufacture, regardless of their condition or state of wear.

Tire and Wheel Replacement

Replace your tires with radials of the same size, load range, speed rating, and maximum cold tire pressure rating (as shown on the tire's sidewall). Using tires of a different size or construction can cause certain vehicle systems such as the ABS and Vehicle Stability Assist (VSA®) system to work incorrectly.

It is best to replace all four tires at the same time. If that isn't possible, replace the front or rear tires in pairs.

If you replace a wheel, only use TPMS specified wheels approved for your vehicle. Make sure that the wheel's specifications match those of the original wheels.

⚠ Tire and Wheel Replacement

⚠ WARNING

Installing improper tires on your vehicle can affect handling and stability. This can cause a crash in which you can be seriously hurt or killed.

Always use the size and type of tires recommended in this owner's manual.

Tire Rotation

Rotating tires according to the maintenance messages on the MID helps to distribute wear more evenly and increase tire life.

■ Tires without rotation marks

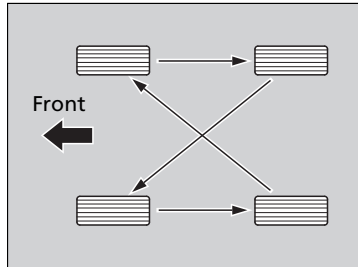

Rotate the tires as shown here.

■ Tires with rotation marks

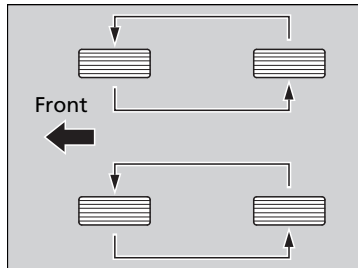

Rotate the tires as shown here.

►► Tire Rotation

Tires with directional tread patterns should only be rotated front to back (not from one side to the other). Directional tires should be mounted with the rotation indication mark facing forward, as shown below.

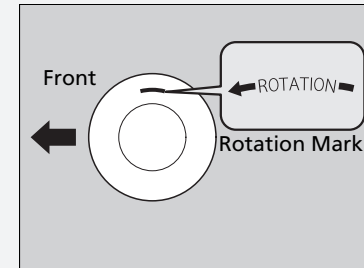

Winter Tires

If driving on snowy or frozen roads, mount all season marked **M+S** tires, snow tires, or tire chains; reduce speed; and maintain sufficient distance between vehicles when driving.

Be particularly careful when operating the steering wheel or brakes to prevent skidding.

Use tire chains, snow tires, or all season tires when necessary or according to the law.

When mounting, refer to the following points.

For winter tires:

- Select the size and load ranges that are the same as the original tires.
- Mount the tires to all four wheels.

For tire chains:

- Install them on the front tires only.
- Because your vehicle has limited tire clearance, we strongly recommend using the chains listed below:

Cable-type: SCC Cable Chain Super Z LT - ZT735

- Follow the chain manufacturer's instruction when installing. Mount them as tightly as you can.
- Check that the chains do not touch the brake lines or suspension.
- Drive slowly.

ⓘ Winter Tires

⚠ WARNING

Using the wrong chains, or not properly installing chains, can damage the brake lines and cause a crash in which you can be seriously injured or killed.

Follow all instructions in this owner's manual regarding the selection and use of tire chains.

NOTICE

Traction devices that are the wrong size or improperly installed can damage your vehicle's brake lines, suspension, body, and wheels. Stop driving if they are hitting any part of the vehicle.

When tire chains are mounted, follow the chain manufacturer's instructions regarding vehicle operational limits.

If your vehicle is equipped with summer tires, be aware that these tires are not designed for winter driving conditions. For more information, contact a dealer.

Checking the 12-Volt Battery

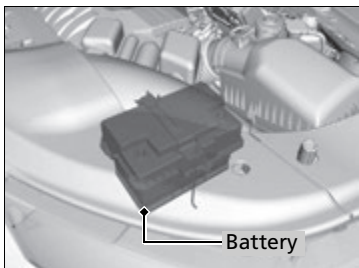

The condition of the battery is monitored by a sensor located on the negative terminal of the battery. If there is a problem with this sensor, the multi-information display (MID) will display a warning message. If this happens, have your vehicle inspected by a dealer.

Check the battery terminals for corrosion monthly.

If your vehicle's battery is disconnected or goes dead:

- The audio system is disabled.
➤ **Refer to navigation system manual**
- The clock resets.
➤ **Clock P. 136**
- The navigation system is disabled.
➤ **Refer to navigation system manual**

Charging the AGM Battery

AGM labeled batteries like those installed in your vehicle require a compatible charger to be properly charged. Damage to the battery can result if the battery is charged improperly or with the wrong equipment. For more information on how to charge your vehicle's AGM battery, consult a dealer.

12-Volt Battery

⚠ WARNING

The battery gives off explosive hydrogen gas during normal operation.

A spark or flame can cause the battery to explode with enough force to kill or seriously hurt you.

When conducting any battery maintenance, wear protective clothing and a face shield, or have a skilled technician do it.

WARNING: Battery post, terminals, and related accessories contain lead and lead compounds.

Wash your hands after handling.

When you find corrosion, clean the battery terminals by applying a baking powder and water solution. Clean the terminals with a damp towel. Cloth/towel dry the battery. Coat the terminals with grease to help prevent future corrosion.

When replacing the battery, the replacement must be of the same specifications.

Consult a dealer for more information.

Replacing the Button Battery

If the indicator does not come on when the button is pressed, replace the battery.

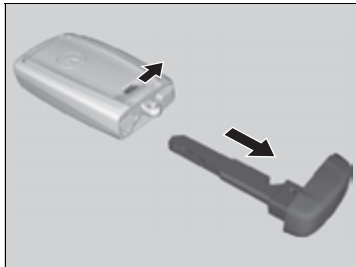

Battery type: CR2032

1. Remove the built-in key.
 - ▶ As a convenience, lightly place masking tape over the remote buttons to hold them in place.
2. Remove the upper half of the cover by carefully prying on the edge with a coin.
 - ▶ Wrap a coin with a cloth to prevent scratching the transmitter.
3. Press down on the center of the assembly and remove the battery.
 - ▶ When removing the button battery, be careful not to touch parts around it.
4. Make sure to replace the battery with the correct polarity.

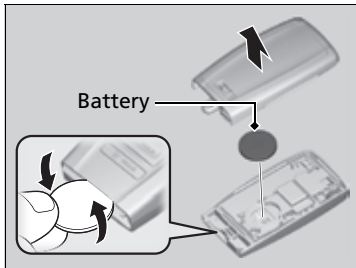

Replacing the Button Battery

NOTICE

An improperly disposed of battery can damage the environment. Always confirm local regulations for battery disposal.

Replacement batteries are commercially available or at a dealer.

NOTICE

The Remote transmitter is equipped with two batteries: A standard replaceable CR2032 coin button battery and an integral non-replaceable rechargeable battery. To prevent permanent damage to the rechargeable battery, replace the CR2032 battery every three to four years.

Models with Rear Entertainment System

Replacing the Battery

Remote Control

If it takes several pushes on the remote control buttons to operate the rear entertainment system, replace the battery.

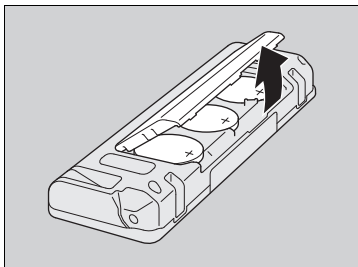

Battery type: BR3032

1. Remove the cover.
2. Make sure to replace the battery with the correct polarity.

Replacing the Battery

NOTICE

An improperly disposed of battery can damage the environment. Always confirm local regulations for battery disposal.

Replacement batteries are commercially available or at a dealer.

■ Wireless Headphone

If there is no sound coming from the wireless headphone, replace the battery.

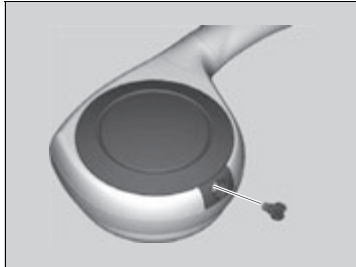

Battery type: AAA

1. Remove the screw.

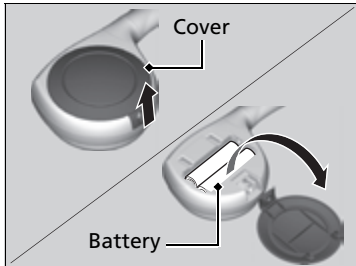

2. Open the cover.

3. Make sure to replace the battery with the correct polarity.

Dust and Pollen Filter

The climate control system is equipped with a dust and pollen filter that collects pollen, dust, and other debris in the air. The Maintenance Minder™ messages will let you know when to replace the filter.

We recommend that you replace the dust and pollen filter sooner when using your vehicle in areas with high concentrations of dust.

» Dust and Pollen Filter

If the airflow from the climate control system deteriorates noticeably, and the windows fog up easily, the filter may need to be replaced. Please contact a dealer for replacement.

Interior Care

Use a damp cloth with a mixture of mild detergent and warm water to remove dirt. Use a clean cloth to remove detergent residue.

Cleaning Seat Belts

Use a soft brush with a mixture of mild soap and warm water to clean the seat belts. Let the belts air dry. Wipe the openings of the seat belt anchors using a clean cloth.

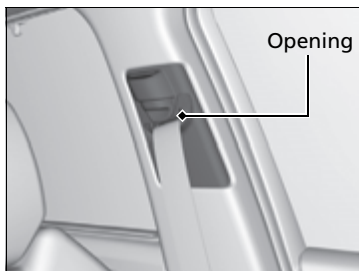

Interior Care

Do not spill liquids inside the vehicle. Electrical devices and systems may malfunction if liquids are splashed on them.

Do not use silicone based sprays on electrical devices such as audio devices and switches. Doing so may cause the items to malfunction or cause a fire inside the vehicle.

If a silicone based spray is inadvertently used on electrical devices, consult a dealer.

Depending on their composition, chemicals and liquid aromatics may cause discoloration, wrinkles, and cracking to resin-based parts and textiles. Do not use alkali solvents or organic solvents such as benzene or gasoline.

After using chemicals, make sure to gently wipe them away using a dry cloth.

Do not place used cloths on top of resin based parts or textiles for long periods of time without washing.

■ Cleaning the Window

Wipe using a glass cleaner.

■ Floor Mats

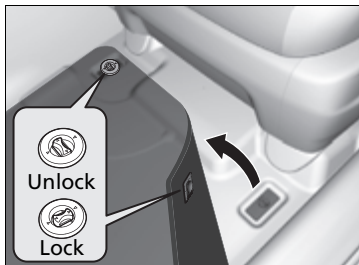

The front and second row passenger's floor mats hook over floor anchors, which keep them from sliding forward. To remove a mat for cleaning, turn the anchor knobs to the unlock position. When reinstalling the mat after cleaning, turn the knobs to the lock position.

Do not put additional floor mats on top of the anchored mats.

■ Maintaining Genuine Leather

To properly clean leather:

1. Use a vacuum or soft dry cloth first to remove any dirt or dust.
2. Clean the leather with a soft cloth dampened with a solution comprised of 90% water and 10% neutral soap.
3. Wipe away any soap residue with a clean damp cloth.
4. Wipe away residual water and allow leather to air dry in the shade.

▣ Cleaning the Window

Wires are mounted to the inside of the rear window. Wipe along the same direction as the wires with a soft cloth so as not to damage them.

Be careful not to spill fluids, such as water or glass cleaner, on or around the cover of both the front sensor camera and the rainfall/light sensor.

► **Automatic Operation (automatic lighting control)** P. 169

► **Automatic Intermittent Wipers** P. 176

► **Front Sensor Camera** P. 257

▣ Floor Mats

If you use any floor mats that were not originally provided with your vehicle, make sure they are designed for your specific vehicle, fit correctly, and are securely anchored by the floor anchors. Position the rear seat floor mat properly. If they are not properly positioned, the floor mat can interfere with the front seat functions.

▣ Maintaining Genuine Leather

It is important to clean or wipe away dirt or dust as soon as possible. Spills can soak into leather resulting in stains. Dirt or dust can cause abrasions in the leather. In addition, please note that some dark colored clothing can rub onto the leather seats resulting in discoloration or stains.

Exterior Care

Dust off the vehicle body after you drive.

Regularly inspect your vehicle for scratches on painted surfaces. A scratch on a painted surface can result in body rust. If you find a scratch, promptly repair it.

■ Washing the Vehicle

Wash the vehicle regularly. Wash more frequently when driving in the following conditions:

- If driving on roads with road salt.
- If driving in coastal areas.
- If tar, soot, bird droppings, insects, or tree sap are stuck to painted surfaces.

■ Using an Automated Car Wash

- Make sure to follow the instructions indicated on the automated car wash.
- Fold in the door mirrors.
- Automatic intermittent wiper equipment vehicles, wipers switch to OFF.

▶▶ Washing the Vehicle

Do not spray water into the air intake vents. It can cause a malfunction.



Do not spray water onto the capless unit when the fuel fill door is open. It can cause damage to the fuel system or engine.

▶▶ Using an Automated Car Wash

When using an automated car wash that pulls the vehicle through with a conveyor, make sure vehicle is in car wash mode.

▶ **If you want to keep the transmission in **N** position [car wash mode]** P. 251

Continued

■ Using High Pressure Cleaners

- Keep sufficient distance between the cleaning nozzle and the vehicle body.
- Take particular care around the windows. Standing too close may cause water to enter the vehicle interior.
- Do not spray high pressure water directly into the engine compartment. Instead, use low pressure water and a mild detergent.

■ Applying Wax

A good coat of automotive body wax helps protect your vehicle's paint from the elements. Wax will wear off over time and expose your vehicle's paint to the elements, so reapply as necessary.

■ Maintaining the Bumpers and Other Resin Coated Parts

If you get gasoline, oil, engine coolant, or battery fluid on resin coated parts, they may be stained or the coating may peel. Promptly wipe it away using a soft cloth and clean water.

■ Cleaning the Window

Wipe using a glass cleaner.

✎ Applying Wax

NOTICE

Chemical solvents and strong cleaners can damage the paint, metal, and plastic on your vehicle. Wipe away spills immediately.

✎ Maintaining the Bumpers and Other Resin Coated Parts

Ask a dealer about the correct coating material when you want to repair the painted surface of the parts made of resin.

■ Maintaining Aluminum Wheels

Aluminum is susceptible to deterioration caused by salt and other road contaminants. When necessary, as early as possible use a sponge and mild detergent to wipe away these contaminants. Do not use a stiff brush or harsh chemicals (including some commercial wheel cleaners). These can damage the protective finish on aluminum alloy wheels, resulting in corrosion. Depending on the type of finish, the wheels also may lose their luster or appear burnished. To avoid water stains, wipe the wheels dry with a cloth while they are still wet.

■ Fogged Exterior Light Lenses

The inside lenses of exterior lights (headlights, brake lights, etc.) may fog temporarily if you have driven in the rain, or after the vehicle has been run through a car wash. Dew condensation also may build up inside the lenses when there is a significant enough difference between the ambient and inside lens temperatures (similar to vehicle windows fogging up in rainy conditions). These conditions are natural processes, not structural design problems in the exterior lights. Lens design characteristics may result in moisture developing on the light lens frame surfaces. This also is not a malfunction. However, if you see large amounts of water accumulation, or large water drops building up inside the lenses, have your vehicle inspected by a dealer.

Accessories

When installing accessories, check the following:

- Do not install accessories on the windshield. They can obstruct your view and delay your reaction to driving conditions.
- Do not install any accessories over areas marked **SRS AIRBAG**, on the sides or backs of the front seats, on front or side pillars, or near the side windows. Accessories installed in these areas may interfere with proper operation of the vehicle's airbags or may be propelled into you or another occupant if the airbags deploy.
- Be sure electronic accessories do not overload electrical circuits or interfere with proper operation of your vehicle.
 - **Fuses** P. 418
- Before installing any electronic accessory, have the installer contact a dealer for assistance. If possible, have a dealer inspect the final installation.

Accessories and Modifications

WARNING

Improper accessories or modifications can affect your vehicle's handling, stability, and performance, and cause a crash in which you can be seriously hurt or killed.

Follow all instructions in this owner's manual regarding accessories and modifications.

WARNING

Use of improperly designed, engineered or manufactured high-voltage battery assemblies could cause a fire in your vehicle.

A vehicle fire could result in a crash or injury.

Only use a genuine Acura high-voltage battery assembly, or its equivalent, in your vehicle.

Acura Genuine accessories are recommended to ensure proper operation on your vehicle.

Modifications

Do not modify your vehicle in a manner that may affect its handling, stability, or reliability, or install non-genuine Acura parts or accessories that may have a similar effect.

The on-board diagnostic port (OBD-II/J2534 connector) installed on this vehicle only is intended to be used with automobile system diagnostic devices. Use of any other type of device may adversely affect the vehicle's electronic systems or allow them to be compromised, and could result in a system malfunction, drained battery or other unexpected problem.

Even minor modifications to vehicle systems can affect overall vehicle performance. Always make sure all equipment is properly installed and maintained, and do not make any modification to your vehicle or its systems that might cause your vehicle to no longer meet federal, state, province, territory, and local regulations.

Do not modify or attempt to repair your vehicle's high-voltage hybrid power system or otherwise modify vehicle electrical systems. Disassembling or modifying electrical equipment can result in a crash or a fire.

If you ever need to replace your vehicle's high-voltage battery assembly outside of warranty coverage, we highly recommend that you only use a genuine Acura high-voltage battery assembly. Genuine Acura high-voltage battery assemblies are designed to work with your vehicle's hybrid power system and have been designed, engineered and manufactured to avoid overcharging situations. Non-genuine high-voltage battery assemblies may not have been similarly designed, engineered and manufactured, and installation of such assemblies could result in overcharging, fires, loss of power, or other conditions that may increase the likelihood of a crash or injury.

Handling the Unexpected

This chapter explains how to handle unexpected troubles.



Tools

Types of Tools 384

If a Tire Goes Flat

Changing a Flat Tire* 385

Temporarily Repairing a Flat Tire* 392

Power System Won't Start

Checking the Procedure 404

If the Keyless Access Remote Battery is

Weak 405

Emergency Power System Off 406

Jump Starting

Overheating

How to Handle Overheating 409

Indicator, Coming On/Blinking

If the Low Oil Pressure Indicator Comes On... 412

If the 12-Volt Battery Charging System

Indicator Comes On 412

If the Malfunction Indicator Lamp Comes

On or Blinks 413

If the Brake System Indicator (Red) Comes

On 414

If the Speed-Sensitive Electric Power

Steering (EPS) System Indicator Comes

On 414

If the Low Tire Pressure/TPMS Indicator

Comes On or Blinks 416

If the Transmission System Indicator Blinks

along with the Warning Message 416

If the Power System Indicator Comes On.. 417

Fuses

Fuse Locations 418

Inspecting and Changing Fuses 426

Emergency Towing

When You Cannot Unlock the Fuel Fill

Door 428

When You Cannot Open the Tailgate

Refueling 429

Refueling

Refueling From a Portable Fuel

Container 430

* Not available on all models

Types of Tools

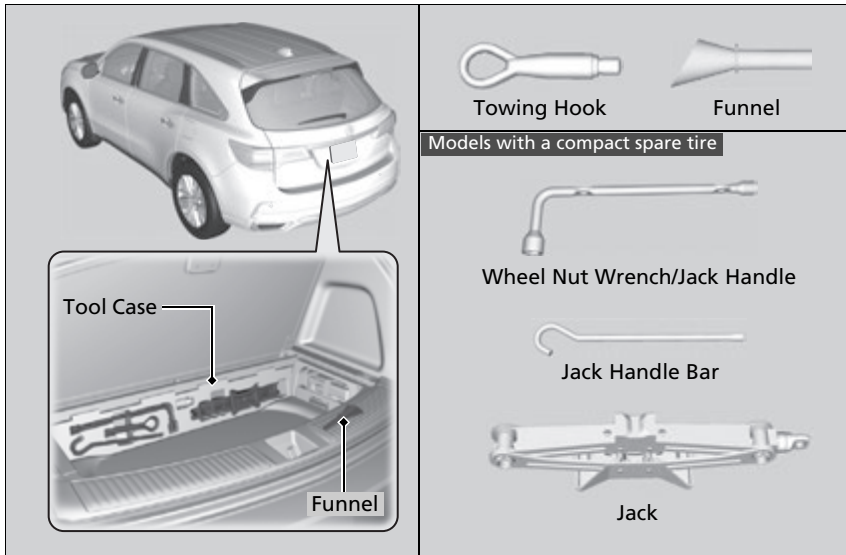

Types of Tools

The tools are stored in the cargo area.

Changing a Flat Tire*

If a tire goes flat while driving, grasp the steering wheel firmly, and brake gradually to reduce speed. Then, stop in a safe place. Replace the flat tire with a compact spare tire. Go to a dealer as soon as possible to have the full-size tire repaired or replaced.

1. Park the vehicle on a firm, level, non-slippery surface, and apply the parking brake.
2. Change the gear position to **P**.
3. Turn on the hazard warning lights and set the power mode to VEHICLE OFF.

Changing a Flat Tire*

Follow compact spare precautions:
Periodically check the tire pressure of the compact spare. It should be set to the specified pressure.
Specified Pressure: 60 psi (420 kPa, 4.2 kgf/cm²)

When driving with the compact spare tire, keep the vehicle speed under 50 mph (80 km/h). Replace with a full-size tire as soon as possible.

The compact spare tire and wheel in your vehicle are specifically for this model. Do not use them with another vehicle. Do not use another type of compact spare tire or wheel with your vehicle.

Do not mount tire chains on a compact spare tire. If a chain-mounted front tire goes flat, remove one of the full-size rear tires and replace it with the compact spare tire. Remove the flat front tire and replace it with the full-size tire that was removed from the rear. Mount the tire chains on the front tire.

Do not use a puncture-repairing agent other than the one provided in the kit that came with your vehicle (if equipped). If a different agent is used, you may permanently damage the tire pressure sensor.

* Not available on all models

■ Getting Ready to Replace the Flat Tire

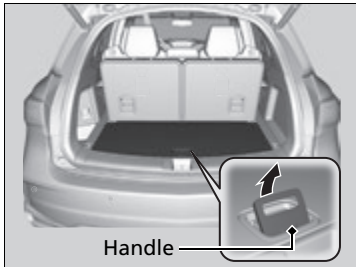

1. Push the rear edge of the handle on the floor lid and open the lid.

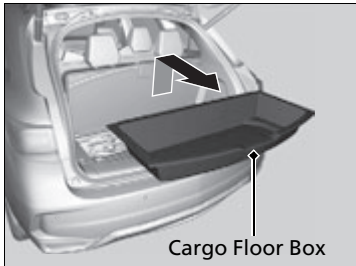

2. Take out the cargo floor box.

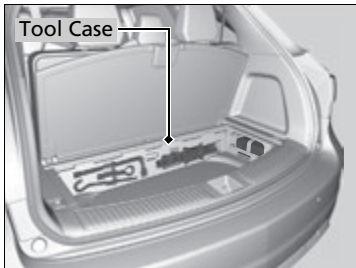

3. Take the jack, wheel nut wrench, and jack handle bar out of the tool case.

✎ Changing a Flat Tire*

NOTICE

Do not use the jack if it doesn't work properly. Call your dealer or a professional towing service.

The wheel nut wrench supplied with your vehicle is specially adapted to fit the holder shaft. Do not use any other tool.

The subwoofer is located on the rear right side. Do not store anything in this area. Doing so may compromise vehicle audio performance.

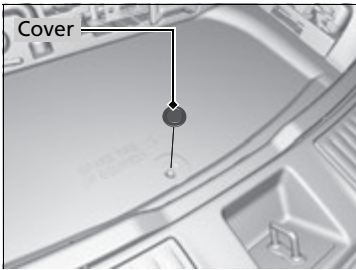

4. Remove the cover on the cargo area lining to access the shaft for the spare tire hoist.

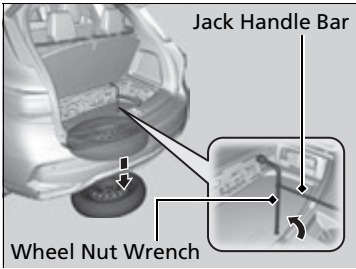

5. Put the wheel nut wrench with the jack handle bar on the hoist shaft. Turn the wrench to the left to lower the spare tire to the ground.

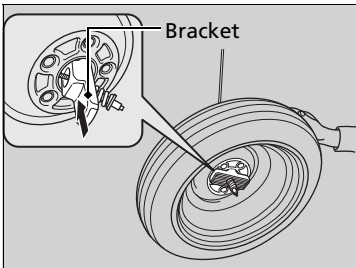

6. Keep turning the wheel nut wrench to create slack in the cable.
7. Remove the bracket from the spare tire.

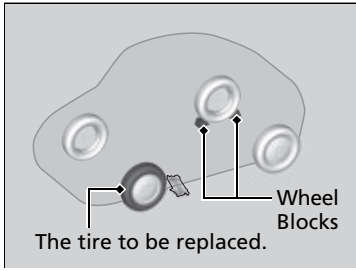

- 8.** Place a wheel block or rock in front and rear of the wheel diagonal to the flat tire.

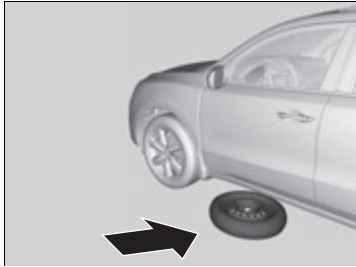

- 9.** Place the compact spare tire (wheel side up) under the vehicle body, near the tire that needs to be replaced.



- 10.** Loosen each wheel nut about one turn using the wheel nut wrench.

How to Set Up the Jack

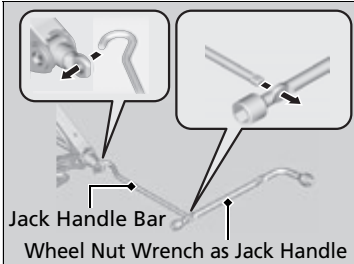
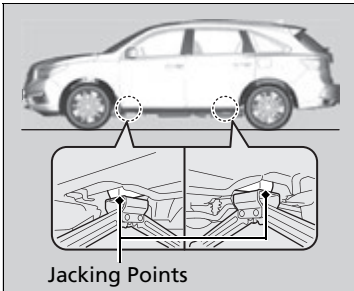

1. Place the jack under the jacking point closest to the tire to be changed.

2. Turn the end bracket (as shown in the image) clockwise until the top of the jack contacts the jacking point.
▶ Make sure that the jacking point tab is resting in the jack notch.

3. Raise the vehicle, using the jack handle bar and the jack handle, until the tire is off the ground.

How to Set Up the Jack

⚠ WARNING

The vehicle can easily roll off the jack, seriously injuring anyone underneath.

Follow the directions for changing a tire exactly, and never get under the vehicle when it is supported only by the jack.

Do not use the jack with people or luggage in the vehicle.

Use the jack provided in your vehicle. Other jacks may not support the weight ("load") or their shape may not match.

The following instructions must be followed to use the jack safely:

- Do not use while the power system is on.
- Use only where the ground is firm and level.
- Use only at the jacking points.
- Do not get in the vehicle while using the jack.
- Do not put anything on top of or underneath the jack.

■ Replacing the Flat Tire

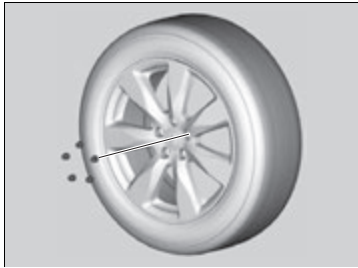

1. Remove the wheel nuts and flat tire.

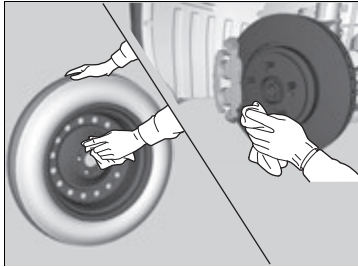

2. Wipe the mounting surfaces of the wheel with a clean cloth.

3. Mount the compact spare tire.

4. Screw the wheel nuts until they touch the lips around the mounting holes, then stop rotating.

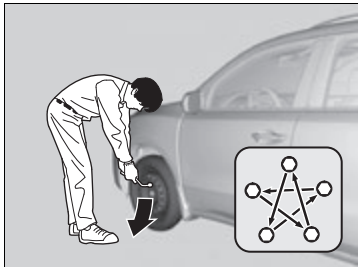

5. Lower the vehicle and remove the jack. Tighten the wheel nuts in the order indicated in the image. Go around, tightening the nuts, two to three times in this order.

Wheel nut torque:

94 lbf-ft (127 N·m, 13.0 kgf·m)

▣ Replacing the Flat Tire

Do not over tighten the wheel nuts by applying extra torque using your foot or a pipe.

Storing the Flat Tire

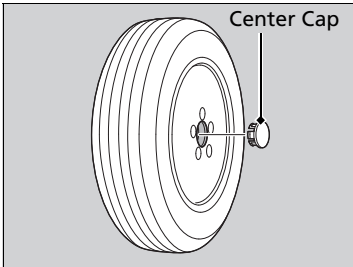

1. Remove the center cap.
2. Place the flat tire face up under the hoist.
3. Insert the hoist bracket into the center hole of the flat tire.

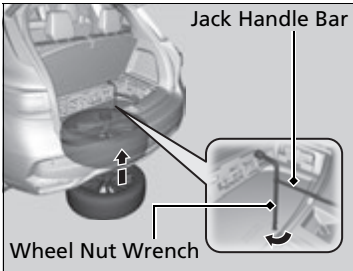

4. Turn the wheel nut wrench with the jack handle bar (clockwise) until the flat tire rests against the underbody of the vehicle, and you hear the hoist click.
5. Securely store the jack, wheel nut wrench, and jack handle bar back in the tool case. Store the case in the cargo area.

TPMS and the Spare Tire

If you replace a flat tire with the spare tire, the low tire pressure/TPMS indicator comes on while you are driving. After driving for a few miles (kilometers), the indicator will start blinking for a short time and then stay on. **Tire Pressure Monitor Problem** appears on the multi-information display (MID), but this is normal.

If you replace the tire with a specified regular tire, the warning message on the MID and the low tire pressure/TPMS indicator will go off after a few miles (kilometers).

Storing the Flat Tire

⚠ WARNING

Loose items can fly around the interior in a crash and can seriously injure the occupants.
Store the jack and tools securely before driving.

TPMS and the Spare Tire

The system cannot monitor the pressure of the spare tire. Manually check the spare tire pressure to be sure that it is correct.

Use TPMS specific wheels. Each is equipped with a tire pressure sensor mounted inside the tire behind the valve stem.

Temporarily Repairing a Flat Tire*

If the tire has a large cut or is otherwise severely damaged, you will need to have the vehicle towed. If the tire only has a small puncture, from a nail for instance, you can use the temporary tire repair kit so that you can drive to the nearest service station for a more permanent repair.

If a tire goes flat while driving, grasp the steering wheel firmly, and brake gradually to reduce speed. Then stop in a safe place.

1. Park the vehicle on a firm, level, and non-slippery surface, and apply the parking brake.
2. Change the gear position to **P**.
3. Turn on the hazard warning lights and set the power mode to VEHICLE OFF.

▶▶ Temporarily Repairing a Flat Tire*

The kit should not be used in the following situations (Instead, contact a dealer or roadside assistance to have the vehicle towed):

- The tire sealant has expired.
- More than one tire is punctured.
- The puncture or cut is larger than 3/16 inch (4mm).
- The tire side wall is damaged or the puncture is outside the contact area.

 <p>Contact Area</p>	When the puncture is:	Use Kit
	Smaller than 3/16 inch (4 mm)	Yes
	Larger than 3/16 inch (4 mm)	No

- Damage has been caused by driving with the tire extremely under inflated.
- The tire bead is no longer seated.
- The rim is damaged.

Do not remove a nail or screw that punctured the tire. If you remove it from the tire, you may not be able to repair the puncture using the kit.

NOTICE

Do not use a puncture-repairing agent other than the one provided in the kit that came with your vehicle. If a different agent is used, you may permanently damage the tire pressure sensor.

■ Getting Ready to Temporarily Repair the Flat Tire

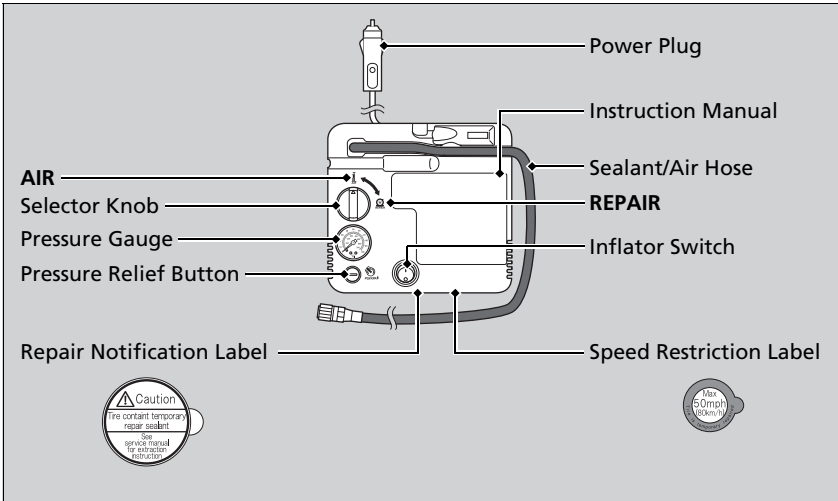

▣ Getting Ready to Temporarily Repair the Flat Tire

Repair notification label and speed restriction label are applied to the side of temporary tire repair kit.

When making a temporary repair, carefully read the instruction manual provided with the kit.

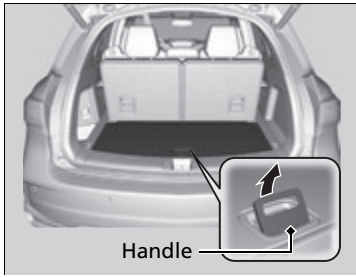

1. Pull the handle on the cargo area floor lid and open the lid.

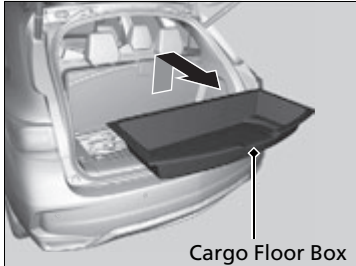

2. Take out the cargo floor box.

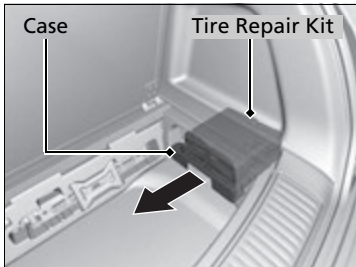

3. Take the kit out of the case.
4. Place the kit face up, on flat ground near the flat tire, and away from traffic. Do not place the kit on its side.

Injecting Sealant and Air

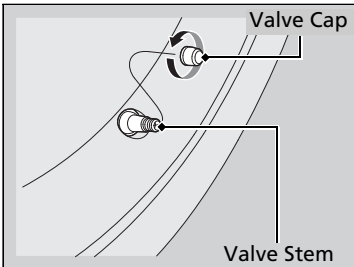

1. Remove the valve cap from the tire valve stem.

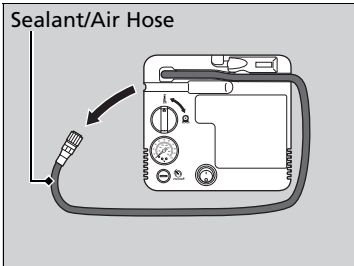

2. Remove the sealant/air hose from the packaging.

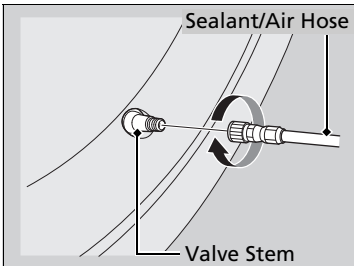

3. Attach the sealant/air hose onto the tire valve stem. Screw it until it is tight.

Injecting Sealant and Air

⚠ WARNING

Tire sealant contains substances that are harmful and can be fatal if swallowed.

If accidentally swallowed, do not induce vomiting. Drink plenty of water and get medical attention immediately.

For skin or eye contact, flush with cool water and get medical attention if necessary.

In cold temperatures, the sealant may not flow easily. In this situation, warm it up for five minutes before using.

The sealant can permanently stain clothing and other materials. Be careful during handling and wipe away any spills immediately.

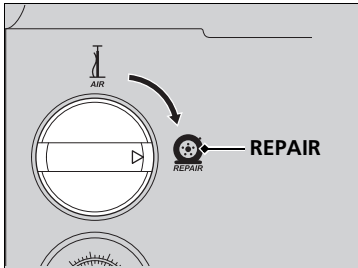
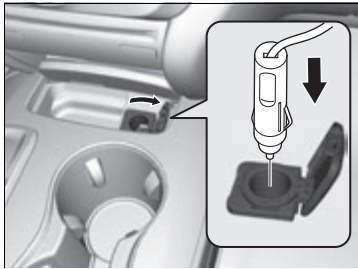

4. Plug in the compressor to the accessory power socket.
 - ▶ Be careful not to pinch the cord in a door or window.
 - ▶ Do not plug any other electronic devices into other accessory power sockets.
 - **Accessory Power Sockets** P. 208
5. Turn the power system on.
 - ▶ Keep the power system on while injecting sealant and air.
 - **Carbon Monoxide Gas** P. 75
6. Turn the selector knob to **REPAIR**.

▶▶ Injecting Sealant and Air

⚠ WARNING

Running the engine with the vehicle in an enclosed or even partly enclosed area can cause a rapid build-up of toxic carbon monoxide.

Breathing this colorless, odorless gas can cause unconsciousness and even death. Only run the engine to power the air compressor with the vehicle outdoors.

NOTICE

Do not operate the temporary tire repair kit compressor for more than 15 minutes. The compressor can overheat and become permanently damaged.

There are three accessory power sockets:

- In the console compartment
- In the front of the center pocket
- In the left side panel in the cargo area

➤ **Accessory Power Sockets** P. 208

Until the sealant injection is complete, the pressure shown on the pressure gauge will appear higher than actual. After the sealant injection is complete the pressure will drop and then begin to rise again as the tire is inflated with air. This is normal. To accurately measure the air pressure using the gauge, turn the air compressor off only after the sealant injection is complete.

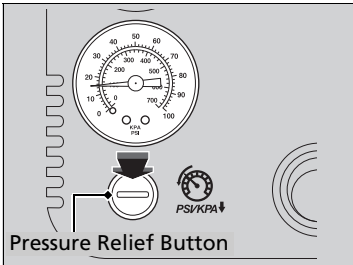
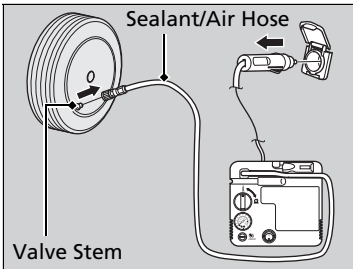
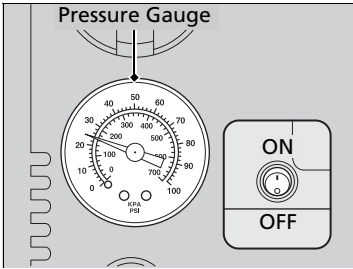

7. Press the inflator switch to turn on the compressor.
 - ▶ The compressor starts injecting sealant and air into the tire.
 - ▶ When the sealant injection is complete, continue to add air.
8. After the air pressure reaches 35 psi (240 kPa), turn off the kit.
 - ▶ To check the pressure, occasionally turn off the compressor and read the gauge.
9. Unplug the power plug from the accessory power socket.
10. Unscrew the sealant/air hose from the tire valve stem. Reinstall the valve cap.
11. Press the pressure relief button until the gauge returns to 0 psi (0 kPa).

✘ Injecting Sealant and Air

If the required air pressure is not reached within 10 minutes, the tire may be too severely damaged for the kit to provide the necessary seal, and your vehicle will need to be towed.

See an Acura dealer for a replacement sealant bottle and proper disposal of an empty bottle.

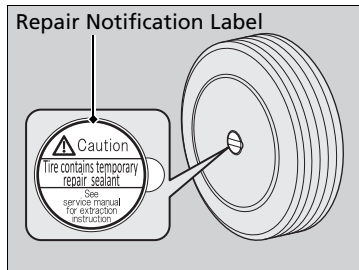

12. Apply the repair notification label to the flat surface of the wheel.
 - ▶ The wheel surface must be clean to ensure the label adheres properly.

■ Distributing the Sealant in the Tire

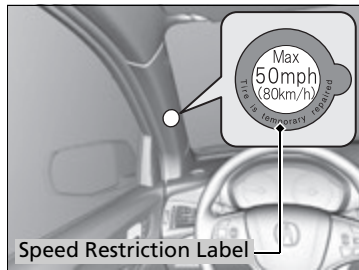

1. Apply the speed restriction label to the location as shown.
2. Drive the vehicle for about 10 minutes.
 - ▶ Do not exceed 50 mph (80 km/h).
3. Stop the vehicle in a safe place.

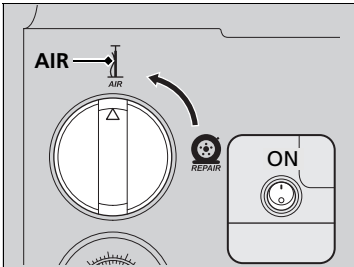
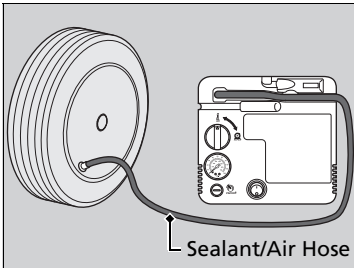

4. Recheck the air pressure using the sealant/air hose on the compressor.

5. Turn the selector knob to **AIR**.

▶ Do not turn the air compressor on to check the pressure.

✘ **Inflating an Under-inflated Tire** P. 401

6. If the air pressure is

- Less than 25 psi (175 kPa):

Do not add air or continue driving. The leak is too severe. Call for help and have your vehicle towed.

✘ **Emergency Towing** P. 427

- 35 psi (240 kPa) or more:

Continue driving for another 10 minutes or until you reach the nearest service station, whichever is sooner. Do not exceed 50 mph (80 km/h). If you have not reached a service station, stop and check the tire pressure.

▶ If the air pressure does not go down after 10 minutes of driving, you do not need to check the tire pressure again.

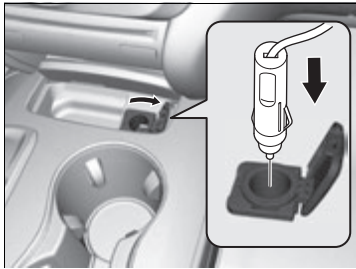

- Greater than 25 psi (175 kPa), but less than 35 psi (240 kPa):

Turn the air compressor on to inflate the tire until the tire pressure reaches 35 psi (240 kPa).

▶ **Inflating an Under-inflated Tire** P. 401

Then drive carefully for 10 more minutes or until you reach the nearest service station, whichever is sooner. Do not exceed 50 mph (80 km/h). If you have not reached a service station, stop and check the tire pressure.

▶ You should repeat this procedure as long as the air pressure is within this range.

7. Unscrew the sealant/air hose from the tire valve stem.

Reinstall the valve cap.

8. Press the pressure relief button until the gauge returns to 0 psi (0 kPa).

9. Repackage and properly stow the kit.

▶▶ Distributing the Sealant in the Tire

⚠ WARNING

Running the engine with the vehicle in an enclosed or even partly enclosed area can cause a rapid build-up of toxic carbon monoxide.

Breathing this colorless, odorless gas can cause unconsciousness and even death.

Only run the engine to power the air compressor with the vehicle outdoors.

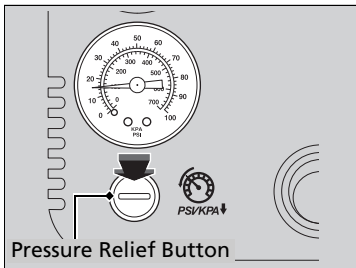

Inflating an Under-inflated Tire

You can use the kit to inflate a non-punctured, under-inflated tire.

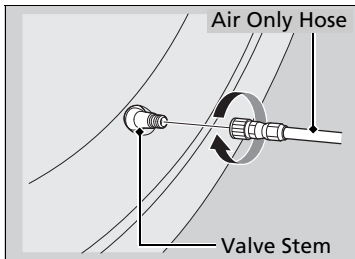
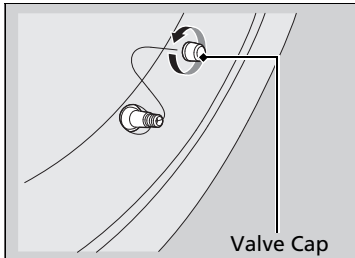
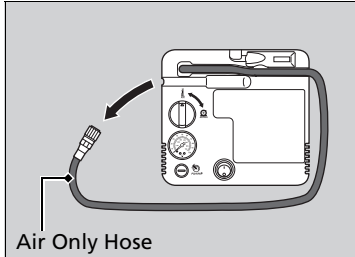

1. Open the cargo area floor lid.

➤ Getting Ready to Temporarily Repair the Flat Tire P. 393

2. Remove the kit from the case.
3. Place the kit, face up, on flat ground near the flat tire, away from traffic. Do not place the kit on its side.
4. Remove the sealant/air hose from the kit.
5. Remove the valve cap.

6. Attach the sealant/air hose onto the tire valve stem. Screw it until it is tight.

▶▶ Inflating an Under-inflated Tire

NOTICE

Do not operate the temporary tire repair kit compressor for more than 15 minutes. The compressor can overheat and become permanently damaged.

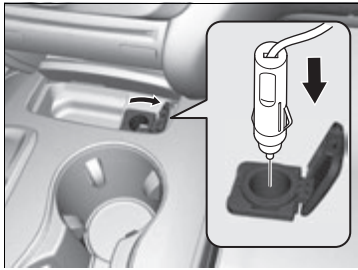

7. Plug in the kit to the accessory power socket.

- ▶ Be careful not to pinch the cord in a door or window.
- ▶ Do not plug any other electronic devices into other accessory power sockets.

🔧 **Accessory Power Sockets** P. 208

8. Turn the power system on.

- ▶ Keep the power system on while injecting air.

🔧 **Carbon Monoxide Gas** P. 75

9. Turn the selector knob to **AIR ONLY**.

10. Press the inflator switch to turn on the kit.

- ▶ The compressor starts to inject air into the tire.

11. Inflate the tire to the specified air pressure.

🔧 **Inflating an Under-inflated Tire**

⚠️ WARNING

Running the engine with the vehicle in an enclosed or even partly enclosed area can cause a rapid build-up of toxic carbon monoxide.

Breathing this colorless, odorless gas can cause unconsciousness and even death. Only run the engine to power the air compressor with the vehicle outdoors.

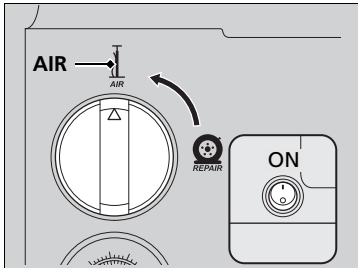

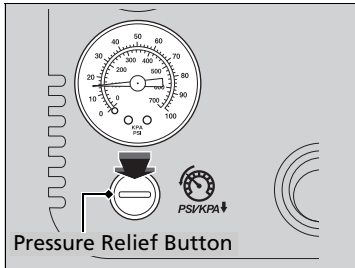

- 12.** Turn off the kit.
 - ▶ Check the pressure gauge on the air compressor.
 - ▶ If overinflated, press the pressure relief button.
- 13.** Unplug the kit from the accessory power socket.
- 14.** Unscrew the sealant/air hose from the tire valve stem. Reinstall the valve cap.
- 15.** Press the pressure relief button until the gauge returns to 0 psi (0 kPa).
- 16.** Repackage and properly stow the kit.

Checking the Procedure

When the **READY** indicator does not come on and the **Ready To Drive** message does not appear on the multi-information display, check the following items and take appropriate action:

☒ Checking the Procedure

If you must start the vehicle immediately, use an assisting vehicle to jump start it.

☒ **Jump Starting** P. 407

Checklist	Condition	What to Do
Check if the related indicator or multi-information display messages come on.	The Temperature Is Too Cold For Vehicle To Operate message appears.	☒ Multi-Information Display (MID) Warning and Information Messages P. 99
	The To Start, Hold Remote Near Start Button message appears. ▶ Make sure the keyless access remote is in its operating range. ☒ POWER Button Operating Range P. 164	☒ If the Keyless Access Remote Battery is Weak P. 405
	The POWER SYSTEM indicator comes on.	Have your vehicle checked by a dealer.
	The transmission system indicator blinks and Transmission Problem Apply Parking Brake When Parked message appears.	The power system can be activated as a temporary measure. ☒ If the Transmission System Indicator Blinks along with the Warning Message P. 416
Check the brightness of the interior lights.	The interior lights are dim or do not come on at all.	Have the 12-volt battery checked by a dealer.
	The interior lights come on normally.	Check all fuses, or have your vehicle checked by a dealer. ☒ Inspecting and Changing Fuses P. 426
Check the gear position.	The transmission is not in P .	Change the gear position to P .
Check the immobilizer system indicator.	When the immobilizer system indicator is blinking, the power system cannot be turned on.	☒ Immobilizer System Indicator P. 90

If the Keyless Access Remote Battery is Weak

If the beeper sounds, the **To Start, Hold Remote Near Start Button** message appears on the multi-information display, the indicator on the **POWER** button flashes, and the **READY** indicator does not come on.

Turn on the power system as follows:

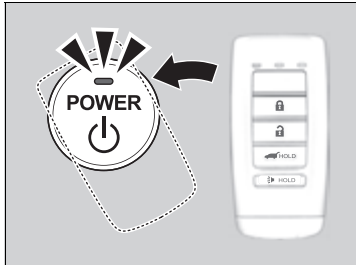

1. Touch the center of the **POWER** button with the **A** logo on the keyless access remote while the indicator on the **POWER** button is flashing. The buttons on the keyless access remote should be facing you.
 - ▶ The indicator flashes for about 30 seconds.

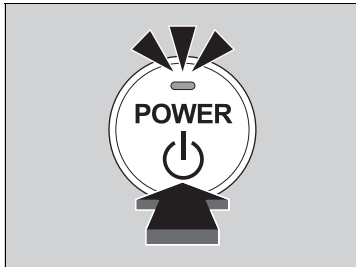

2. Depress the brake pedal and press the **POWER** button within 10 seconds after the beeper sounds while the indicator stays on.
 - ▶ If you don't depress the pedal, the mode will change to ACCESSORY.

Emergency Power System Off

The **POWER** button may be used to turn the power system off due to an emergency situation even while driving. If you must turn the power system off, do either of the following operations:

- Press and hold the **POWER** button for about two seconds.
- Firmly press the **POWER** button three times.

The steering wheel will not lock. However, because turning off the power system disables the power assist the power system provides to the steering and braking systems, it will require significantly more physical effort and time to steer and slow the vehicle. Use both feet on the brake pedal to slow down the vehicle and stop immediately in a safe place.

The gear position automatically changes to **P** after the vehicle comes to a complete stop. Then, the power mode changes to VEHICLE OFF.

⌘ Emergency Power System Off

Do not press the button while driving unless it is absolutely necessary for the power system to be switched off.

Jump Starting Procedure

Turn off the power to electric devices, such as audio and lights. Turn off the power system, then open the hood.

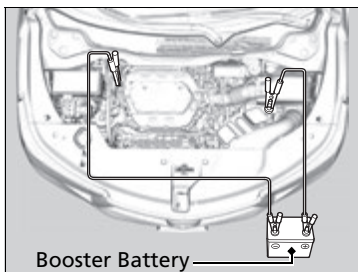
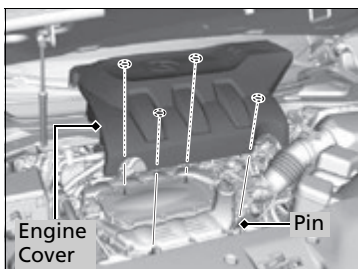

1. Pull up on the engine cover, remove it from the pins.
 - ▶ Start on the passenger side and lift up on the outermost edge of the cover.
 - ▶ Move towards the driver side while applying uniform upward pressure.
2. Connect the first jumper cable to your vehicle's 12-volt battery \oplus terminal.
3. Connect the other end of the first jumper cable to the booster battery \oplus terminal.
 - ▶ Use a 12-volt booster battery only.
 - ▶ When using an automotive battery charger to boost your 12-volt battery, select a lower charging voltage than 15 volts. Check the charger manual for the proper setting.
4. Connect the second jumper cable to the booster battery \ominus terminal.

Jump Starting

⚠ WARNING

A 12-volt battery can explode if you do not follow the correct procedure, seriously injuring anyone nearby.

Keep all sparks, open flames, and smoking materials away from the 12-volt battery.

Securely attach the jumper cables clips so that they do not come off when the engine vibrates. Also be careful not to tangle the jumper cables or allow the cable ends to touch each other while attaching or detaching the jumper cables.

12-volt Battery performance degrades in cold conditions and may prevent the engine from starting.

Continued

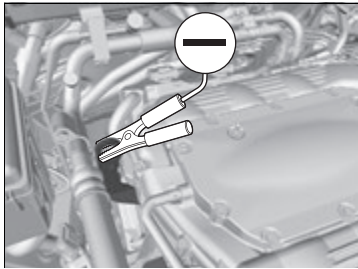

5. Connect the other end of the second jumper cable to the engine hanger as shown. Do not connect this jumper cable to any other part.
6. If your vehicle is connected to another vehicle, start the assisting vehicle's engine and increase its rpm slightly.
7. Attempt to start your vehicle's engine. If it turns over slowly, check that the jumper cables have good metal-to-metal contact.

■ What to Do After the Engine Starts

Once your vehicle's engine has started, remove the jumper cables in the following order:

1. Disconnect the jumper cable from your vehicle's ground.
2. Disconnect the other end of the jumper cable from the booster battery ⊖ terminal.
3. Disconnect the jumper cable from your vehicle's 12-volt battery ⊕ terminal.
4. Disconnect the other end of the jumper cable from the booster battery ⊕ terminal.

Have your vehicle inspected by a nearby service station or a dealer.

How to Handle Overheating

Overheating symptoms are as follows:

- The high temperature indicator comes on or the engine suddenly loses power.
- The **Stop Driving When Safe. Engine Temperature Too Hot** message appears on the multi-information display (MID).
- Steam or spray comes out of the engine compartment.

■ The Stop Driving When Safe. Engine Temperature Too Hot Message Appears on the Multi-Information Display (MID)

■ First thing to do

1. Immediately park the vehicle in a safe place.
2. Turn off all accessories and turn on the hazard warning lights.
 - ▶ **No steam or spray present:** Keep the power system on and open the hood.
 - ▶ **Steam or spray is present:** Turn off the power system and wait until it subsides. Then open the hood.

⌘ The Stop Driving When Safe. Engine Temperature Too Hot Message Appears on the Multi-Information Display (MID)

WARNING

Steam and spray from an overheated engine can seriously scald you.

Do not open the hood if steam is coming out.

NOTICE

Continuing to drive with the **Stop Driving When Safe. Engine Temperature Too Hot** message on the multi-information display may damage the engine.

■ Next thing to do

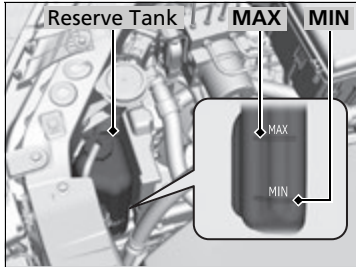

1. Check that the cooling fan is operating and turn the power system off once the **Stop Driving When Safe. Engine Temperature Too Hot** message on the multi-information display goes off.
 - ▶ If the cooling fan is not operating, immediately turn the power system off.
2. Once the engine has cooled down, inspect the coolant level and check the cooling system components for leaks.
 - ▶ If the coolant level in the reserve tank is low, add coolant until it reaches the **MAX** mark.
 - ▶ If there is no coolant in the reserve tank, check that the radiator is cool. Cover the radiator cap with a heavy cloth and open the cap. If necessary, add coolant up to the base of the filler neck, and put the cap back on.

■ Last thing to do

Once the engine has cooled sufficiently, turn the power system on, and check the high temperature indicator.

If the **Stop Driving When Safe. Engine Temperature Too Hot** message does not appear, resume driving. If it appears again, contact a dealer for repairs.

☒ The Stop Driving When Safe. Engine Temperature Too Hot Message Appears on the Multi-Information Display (MID)

⚠ WARNING

Removing the radiator cap while the engine is hot can cause the coolant to spray out, seriously scalding you.

Always let the engine and radiator cool down before removing the radiator cap.

If the coolant is leaking, contact a dealer for repairs.

Use water as an emergency/temporary measure only. Have a dealer flush the system with proper antifreeze as soon as possible.

If the Low Oil Pressure Indicator Comes On



■ Reasons for the indicator to come on

Comes on when the engine oil pressure is low.

■ What to do as soon as the indicator comes on

1. Immediately park the vehicle on level ground in a safe place.
2. If necessary, turn the hazard warning lights on.

■ What to do after parking the vehicle

1. Turn the power system off and let it sit for about three minutes.
2. Open the hood and check the oil level.

➤ **Oil Check** P. 343

3. Turn the power system on and check the low oil pressure indicator.

- ▶ The indicator goes off: Start driving again.
- ▶ The indicator does not go off within 10 seconds: Turn the power system off and contact a dealer for repairs immediately.

If the 12-Volt Battery Charging System Indicator Comes On



■ Reasons for the indicator to come on

Comes on when the 12-Volt battery is not being charged.

■ What to do when the indicator comes on

Turn off the climate control system, rear defogger, and other electrical systems, and immediately contact a dealer for repairs.

⚠ If the Low Oil Pressure Indicator Comes On

NOTICE

Running the engine with low oil pressure can cause serious mechanical damage almost immediately.

⚠ If the 12-Volt Battery Charging System Indicator Comes On

If you need to stop temporarily, do not turn off the power system. Restarting the power system may rapidly discharge the battery.

If the Malfunction Indicator Lamp Comes On or Blinks



■ Reasons for the indicator lamp to come on or blink

- Comes on when there is a problem with the engine emissions control system.
- Blinks when engine misfiring is detected.

■ What to do when the indicator lamp comes on

Avoid high speeds and immediately get your vehicle inspected at a dealer.

■ What to do when the indicator lamp blinks

Park the vehicle in a safe place with no flammable items and wait at least 10 minutes or more with the engine stopped until it cools.

⚠ If the Malfunction Indicator Lamp Comes On or Blinks

NOTICE

If you drive with the malfunction indicator lamp on, the emissions control system and the engine could be damaged.

If the malfunction indicator lamp blinks again when restarting the power system, drive to the nearest dealer at 31 mph (50 km/h) or less. Have your vehicle inspected.

If the Brake System Indicator (Red) Comes On

U.S.



Canada



■ Reasons for the indicator to come on

- The brake fluid is low.
- There is a malfunction in the brake system.

■ What to do when the indicator comes on while driving

Depress the brake pedal lightly to check pedal pressure.

- If normal, check the brake fluid level the next time you stop.
- If abnormal, take immediate action. If necessary, downshift the transmission to slow the vehicle using regenerative braking.

If the Speed-Sensitive Electric Power Steering (EPS) System Indicator Comes On



■ Reasons for the indicator to come on

- Comes on when there is a problem with the EPS system.
- If you depress the accelerator pedal repeatedly to increase the engine speed while the engine is idling, the indicator comes on, and sometimes the steering wheel becomes harder to operate.

■ What to do when the indicator comes on

Stop the vehicle in a safe place and restart the power system.

If the indicator comes on and stays on, immediately have your vehicle inspected by a dealer.

▶▶ If the Brake System Indicator (Red) Comes On

Have your vehicle repaired immediately.

It is dangerous to drive with low brake fluid. If there is no resistance from the brake pedal, stop immediately in a safe place. If necessary downshift the gears.

If the brake system indicator and **ABS** indicator come on simultaneously, the electronic brake distribution system is not working. This can result in vehicle instability under sudden braking.

Have your vehicle inspected by a dealer immediately.

If both red and amber brake system indicators come on, stop the vehicle in a safe place and have it inspected by a dealer immediately.

If the Electric Parking Brake System Indicator Comes On



■ Reasons for the indicator to come on

Comes on when there is a problem with the electric parking brake system.

■ What to do when the indicator comes on

Avoid using the parking brake and immediately get your vehicle inspected at a dealer.

■ What to do when the electric parking brake indicator comes on or blinks at the same time

Release the parking brake.

➤ Parking Brake P. 299

- If the electric parking brake indicator remains on or blinks, even after releasing the parking brake, immediately stop the vehicle in a safe place, and call a dealer.
 - ▶ Preventing the vehicle from moving, change the gear position to **P**.
- If only the electric parking brake indicator goes off, immediately get your vehicle inspected at a dealer.

⚠ If the Electric Parking Brake System Indicator Comes On

If you apply the parking brake, it may not release.

If the electric parking brake indicator also turns on, the parking brake is still applied.

When the electric parking brake indicator blinks at the same time as the electric parking brake system indicator, the system must be checked. The parking brake may not operate under these conditions.

If the Low Tire Pressure/TPMS Indicator Comes On or Blinks



■ Reasons for the indicator to come on or blink

A tire pressure is significantly low. If there is a problem with the TPMS with Tire Fill Assist or the compact spare tire* is installed, the indicator blinks for about one minute, and then stays on.

■ What to do when the indicator comes on

Drive carefully and avoid abrupt cornering and hard braking. Stop your vehicle in a safe place. Check the tire pressure and adjust the pressure to the specified level. The specified tire pressure is on a label on the driver side doorjamb.

■ What to do when the indicator blinks

Have the tire inspected by a dealer as soon as possible. If the compact spare tire* causes the indicator to blink, change the tire to a full-size tire. The indicator goes off after driving for a few miles (kilometers).

If the Transmission System Indicator Blinks along with the Warning Message



■ Reasons for the indicator to blink

The transmission is malfunctioning.

■ What to do when the indicator blinks

- Immediately have your vehicle inspected by a dealer.
- Change to **[N]** when you turn the power system on.
 - ▶ Check if the **[N]** position on the instrument panel and the indicator on the **[N]** button is light/blink.
 - ▶ The power system cannot be turned on unless the parking brake is set.

📖 **Turning on the Power** P. 239

▶▶ If the Low Tire Pressure/TPMS Indicator Comes On or Blinks

NOTICE

Driving on an extremely underinflated tire can cause it to overheat. An overheated tire can fail. Always inflate your tires to the prescribed level.

TPMS Fill Assist provides visual and audible assistance during tire pressure adjustment. With the power mode in ON, while you adjust tire pressure up or down, the system alerts you as follows:

Below recommended pressure: The beeper sounds and exterior lights flash once every five seconds.

At recommended pressure: The beeper sounds and the exterior lights flash rapidly for five seconds.

Above recommended pressure: The beeper sounds and lights flash twice every three seconds.

▶▶ If the Transmission System Indicator Blinks along with the Warning Message

You may not be able to turn on the power system.

Make sure to set the parking brake when parking your vehicle.

Call a professional towing service if you need to tow your vehicle.

📖 **Emergency Towing** P. 427

If the Power System Indicator Comes On

POWER SYSTEM

■ Reasons for the indicator to come on

Comes on when there is a problem with the hybrid system.

■ What to do when the indicator comes on

Avoid high speeds and immediately have your vehicle inspected by a dealer.

Fuse Locations

If any electrical devices are not working, set the power mode to VEHICLE OFF and check the fuse in question by the fuse number and box cover number. Located near the brake fluid reservoir. Push the tabs to open the box.

Engine Compartment Fuse Box Type A

Fuse locations are shown on the fuse box cover. Locate the fuse in question by the fuse number and box cover number. Located near the brake fluid reservoir. Push the tabs to open the box.

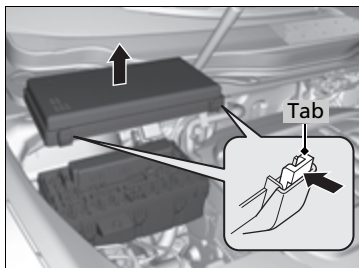

Handling the Unexpected

■ Circuit protected and fuse rating

	Circuit Protected	Amps
1	–	–
2	–	–
3	ACG FR	15 A
4	Washer	15 A
5	IG1 OP	(7.5 A)
6	ECU FR	7.5 A
7	VBSOL	(10 A)
8	FI Sub	15 A
9	DBW	15 A
10	FI Main	15 A
11	IG Coil	15 A
12	DRL R	10 A
13	DRL L	10 A
14	Injector	20 A
15	Radio	20 A

	Circuit Protected	Amps
16	Back Up	10 A
17	MG Clutch	(7.5 A)
18	FR Fog*	(7.5 A)
19	–	–
20	H/L HI R	7.5 A
21	–	–
22	Small LT	10 A
23	–	–
24	H/L HI L	7.5 A
25	SBW	15 A
26	H/L LO R	10 A
27	H/L LO L	10 A
28	Oil LVL	7.5 A
29	Main Fan	30 A
30	Sub Fan	30 A
31	Wiper Main	30 A

■ Engine Compartment Fuse Box Type B

Fuse locations are shown on the fuse box cover. Locate the fuse in question by the fuse number and box cover number. Located near the battery. Push the tabs to open the box.

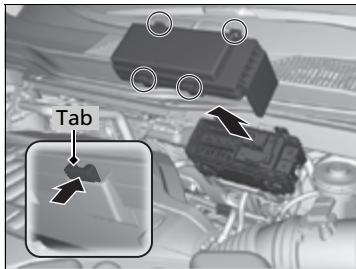

■ Circuit protected and fuse rating

	Circuit Protected	Amps
1	Main Fuse	200 A
	AS F/B-1	50 A
	DR F/B-2	50 A
	DR F/B-1	50 A
2	RR DEF	40 A
	RR F/B-2	60 A
	FR Blower	40 A
	H/L Washer*	(30 A)
	RR BLOWER & BMS	30 A

	Circuit Protected	Amps
3	SUB F/B-1	60 A
	VSA MTR	40 A
	AS F/B-2	60 A
	R/B Main	60 A
	EPS	70 A
	SUB F/B-2	60 A
	VSA FSR	20 A
	ESB	40 A
4	Stop & Horn Hazard	30 A
5	EOP RLY	30 A
6	RR F/B-1	40 A
7	FI Main	40 A
8	Stop & Horn	20 A
9	Hazard	10 A
10	BMS	7.5 A
11	-	-

* Not available on all models

■ Engine Compartment Fuse Box Type C

Located near the ⊕ terminal on the battery.

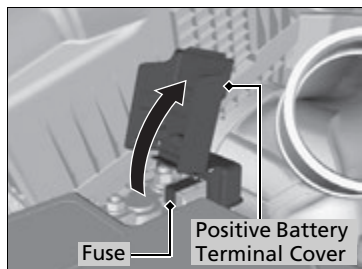

Pull up the cover.

Replacement of this fuse should be done by a dealer.

Fuse location is shown on the back of the positive battery terminal cover.

■ Circuit protected and fuse rating

	Circuit Protected	Amps
	Fan Main	60 A

■ Driver's Side Interior Fuse Box Type A

Located under the dashboard.

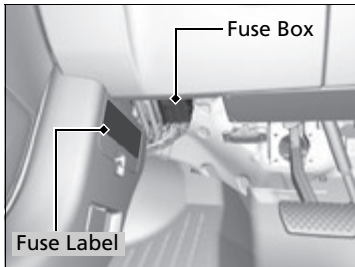

Fuse locations are shown on the label on the outer side of the side panel cover. Locate the fuse in question by the fuse number and label number.

■ Circuit protected and fuse rating

	Circuit Protected	Amps
1	AS Door Lock	10 A
2	RR DR Door Lock	7.5 A
3	DR Door Lock	7.5 A
4	FR AS Door Unlock	10 A
5	RR DR Door Unlock	7.5 A
6	DR Door Unlock	(7.5 A)
7	D/L Main	20 A
8	–	–
9	ETS TELE	20 A
10	IG1 RR	15 A
11	Meter	7.5 A
12	IG1 FR	20 A
13	ACC	7.5 A
14	–	–
15	DR P/Seat (SLI)	20 A
16	S/R	20 A

	Circuit Protected	Amps
17	RR DR P/W	20 A
18	Smart	10 A
19	FR DR P/W	20 A
20	–	–
21	Fuel Pump	20 A
22	IG1 AS	15 A
23	VSA	7.5 A
24	ACG AS	7.5 A
25	STRLD	7.5 A
26	IG2 HAC	7.5 A
27	DRL	7.5 A
28	ACC Key Lock	7.5 A
29	DR P/Seat (LUM)	7.5 A
30	INT Lights	7.5 A
31	ETS TILT	20 A
32	DR P/Seat (REC)	20 A
33	–	–
34	–	–

■ Driver's Side Interior Fuse Box Type B

Located under the type A driver's side interior fuse box. Take off the cover to open.

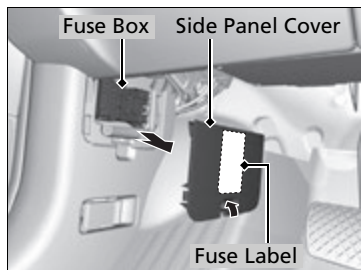

Fuse locations are shown on the label on the back side of the side panel cover. Locate the fuse in question by the fuse number and label number.

■ Circuit protected and fuse rating

	Circuit Protected	Amps
1	DCT	20 A
2	–	–
3	DCT	20 A
4	IG Main	30 A
5	Hybrid System	10 A
6	Hybrid System	15 A
7	Hybrid System	15 A
8	DCT	30 A

■ Driver's Side Interior Fuse Box Type C

Located under the type A driver's side interior fuse box. Take off the cover to open.

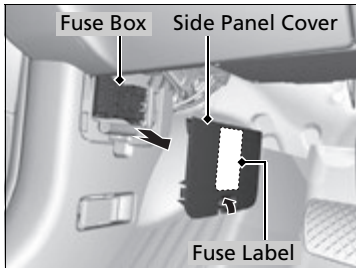

Fuse locations are shown on the label on the back side of the side panel cover. Locate the fuse in question by the fuse number and label number.

■ Circuit protected and fuse rating

	Circuit Protected	Amps
1	ADS	30 A
2	–	–
3	–	–
4	IG Main	30 A
5	Smart	10 A
6	A/C Water Pump	10 A
7	–	–
8	Starter Motor	30 A

■ Passenger's Side Interior Fuse Box

Located on the lower side panel. Take off the cover to open.

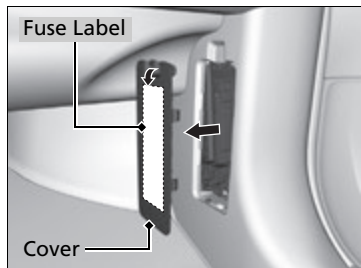

Fuse locations are shown on the cover.

■ Circuit protected and fuse rating

	Circuit Protected	Amps
1	EPTR*	(30 A)
2	RR AS P/W	20 A
3	ACM	20 A
4	FR DEF*	(15 A)
5	AVS Heated Seat	20 A
6	FR AS P/W	20 A
7	AS P/Seat (SLI)	20 A
8	AS P/Seat (REC)	20 A
9	AS P/Seat (LUM)	(7.5 A)
10	Spare	5 A
11	Heated Steering*	(10 A)
12	–	–
13	–	–

	Circuit Protected	Amps
14	RR ACC Socket	20 A
15	FR ACC Socket	20 A
16	–	–
17	–	–
18	AMP	30 A
19	SRS	10 A
20	AS ECU	7.5 A
21	Option	7.5 A
22	–	–
23	–	–
24	OPDS	7.5 A
25	ILLUMI (INT)	5 A
26	EPTL*	(30 A)
27	CTR ACC Socket	20 A
28	AC INVTR	(30 A)

■ Rear Fuse Box

Located on the left side of cargo area.
Remove the cover by prying on the edge of the cover using a flat-tip screwdriver.

- Wrap the flat-tip screwdriver with a cloth to prevent scratches.

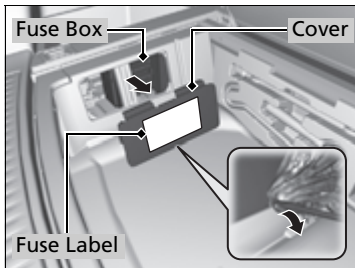

Fuse locations are shown on the cover.
Locate the fuse in question by the fuse number and box cover number.

■ Circuit protected and fuse rating

	Circuit Protected	Amps
1	PTG Closer	20 A
2	–	–
3	USB CHARGE	15 A
4	Fuel Lid	7.5 A
5	Seat Slide	20 A
6	–	–
7	RR Heat Seat*	(20 A)
8	–	–
9	–	–
10	–	–
11	–	–
12	Rear Wiper	10 A
13	Rear ECU	7.5 A
14	SH-AWD	(20 A)
15	EPB-R	30 A
16	EPB-L	30 A
17	–	–
18	PTG MTR	40 A

* Not available on all models

Inspecting and Changing Fuses

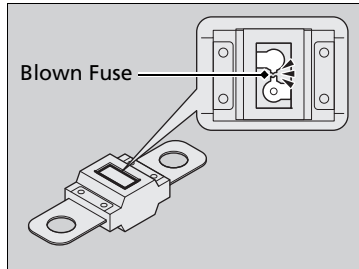
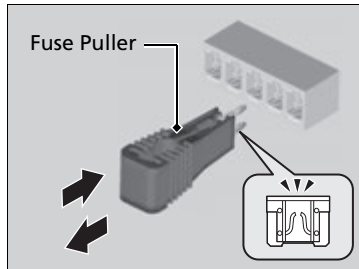
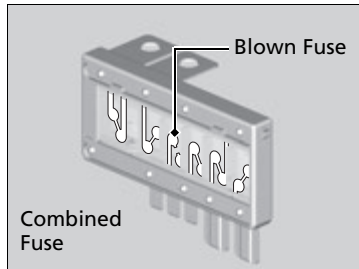

1. Set the power mode to VEHICLE OFF. Turn headlights and all accessories off.
2. Remove the fuse box cover.
3. Check the large fuse in the engine compartment.
 - If the fuse is blown, use a Phillips-head screwdriver to remove the screw and replace it with a new one.
4. Inspect the small fuses in the engine compartment and the vehicle interior.
 - If there is a burned out fuse, remove it with the fuse puller and replace it with a new one.

Inspecting and Changing Fuses

NOTICE

Replacing a fuse with one that has a higher rating greatly increases the chances of damaging the electrical system.

Replace fuse with a spare fuse of the same specified amperage.

Confirm the specified amperage using the charts on P. 418 to P. 425.

There is a fuse puller in the engine compartment fuse box.

Call a professional towing service if you need to tow your vehicle.

■ Flat bed equipment

The operator loads your vehicle on the back of a truck.

This is the only way you can safely transport your vehicle.

Any other towing method will damage the vehicle's drive system.

» Emergency Towing

NOTICE

Trying to lift or tow your vehicle by the bumpers will cause serious damage. The bumpers are not designed to support the vehicle's weight.

NOTICE

Improper towing such as towing behind a motorhome or other motor vehicle can damage the transmission.

Never tow your vehicle with just a rope or chain. It is very dangerous since ropes or chains may shift from side to side or break.

When You Cannot Unlock the Fuel Fill Door

What to Do When Unable to Unlock the Fuel Fill Door

If you cannot unlock the fuel fill door, use the following procedure:

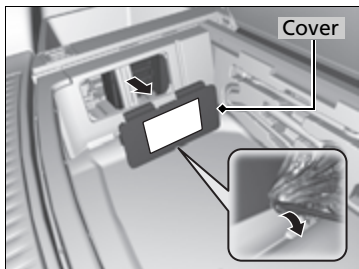

1. Open the tailgate.
2. Lift the cargo floor lid by the handle in the center.
3. Remove the cargo floor box and set it aside.
4. Wrap a cloth around the flat-tip screwdriver. Put it into the cover slot (as shown in the image) and remove the cover.



5. Pull the release lever toward you.
 - ▶ The release lever unlocks the fuel fill door when it is pulled.

What to Do When Unable to Unlock the Fuel Fill Door

After taking these steps, contact a dealer to have the vehicle checked.

When You Cannot Open the Tailgate

What to Do When Unable to Open the Tailgate

If you cannot open the tailgate, use the following procedure:

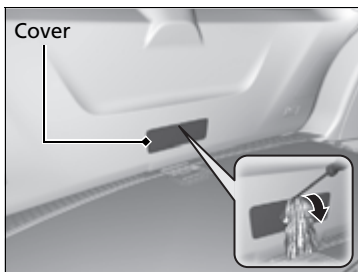

1. Wrap a cloth around the flat-tip screwdriver. Put it into the cover (as shown in the image) and remove the cover.

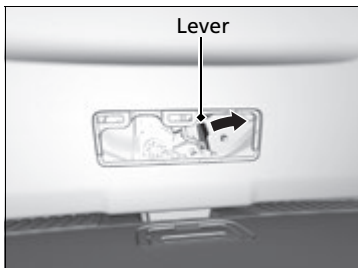

2. To open the tailgate, push the tailgate while sliding the lever to the right.

What to Do When Unable to Open the Tailgate

What to do-following up

After taking these steps, contact a dealer to have the vehicle checked.

When you open the tailgate from inside, make sure there is enough space around the tailgate, and it does not hit anyone or any object.

Refueling From a Portable Fuel Container

If you have run out of fuel and need to refuel your vehicle from a portable fuel container, use the funnel provided with your vehicle.

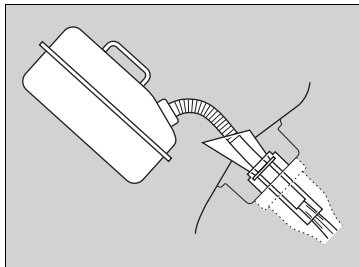
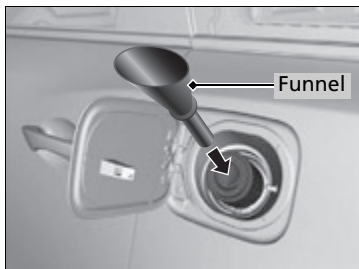

1. Turn off the power system.
2. Press the fuel fill door release button.
 - ▶ The fuel fill door opens.
3. Take the funnel out of its clip in the cargo area.
 - ▶ **Types of Tools** P. 384
4. Place the end of the funnel on the lower part of filler opening, then insert it slowly and fully.
 - ▶ Make sure that the end of the funnel goes down along with the filler pipe.
5. Fill the tank with fuel from the portable fuel container.
 - ▶ Pour fuel carefully so you do not spill any.
6. Remove the funnel from the filler neck.
 - ▶ Wipe up any fuel from the funnel before storing it.
7. Shut the fuel fill door by hand.

Refueling From a Portable Fuel Container

WARNING

Gasoline is highly flammable and explosive. You can be burned or seriously injured when handling fuel.

- Turn the power system off, and keep heat, sparks, and flame away.
- Handle fuel only outdoors.
- Wipe up spills immediately.

NOTICE

Do not insert the nozzle of a portable fuel container or any funnel other than the one provided with your vehicle. Doing so can damage the fuel system. Do not try to pry open or push open the sealed fuel tank with foreign objects. This can damage the fuel system and its seal.

Make sure the fuel in the portable fuel container is gasoline before you refuel.

Information

This chapter includes your vehicle's specifications, locations of identification numbers, and other information required by regulation.

Specifications	432
Identification Numbers	
Vehicle Identification Number (VIN), Engine Number, Motor Number, and Transmission Number.....	434
Devices that Emit Radio Waves	435
Reporting Safety Defects	436
Emissions Testing	
Testing of Readiness Codes.....	437
Warranty Coverages	438
Authorized Manuals	440
Client Service Information	441

■ Vehicle Specifications

Model	MDX Sport Hybrid	
No. of Passengers:		
Front	2	
Rear (2nd)	2 ^{*1}	
Rear (3rd)	3 ^{*2}	
Total	2	
	6 ^{*1}	
	7 ^{*2}	
Weights:		
Gross Vehicle Weight Rating	U.S.:	5,952 lbs (2,700 kg)
	Canada:	2,700 kg
Gross Axle Weight Rating (Front)	U.S.:	2,976 lbs (1,350 kg)
	Canada:	1,350 kg
Gross Axle Weight Rating (Rear)	U.S.:	3,042 lbs (1,380 kg)
	Canada:	1,380 kg

*1: Models with second row captain seat

*2: Models with second row bench seat

■ Air Conditioning

Refrigerant Type	HFC-134a (R-134a)	
Charge Quantity	23.8 – 25.6 oz (675 – 725 g)	
Lubricant Type	ND-OIL11 (POE)	
Quantity	8.54 – 9.46 cu-in (140 – 155 cm ³)	

■ Engine Specifications

Displacement	182.8 cu-in (2,997 cm ³)	
Spark Plugs	NGK	ILZKR7B11
	DENSO	SXU22HCR11

■ Fuel

Type	Unleaded premium gasoline, Pump octane number of 91 or higher	
Fuel Tank Capacity	19.4 US gal (73.3 L)	

■ Washer Fluid

Tank Capacity	U.S.: 4 US qt (3.8 L)	
	Canada: 5.6 US qt (5.3 L)	

■ Light Bulbs

Headlights (High/Low Beam)	LED
Fog Lights*	LED
Front Turn Signal/Side Marker/Parking Lights	LED
Daytime Running Lights	LED
Side Turn Signal Lights (on Door Mirrors)	LED
Brake Lights	21 W
Rear Side Marker Lights	LED
Taillights	LED
Back-Up Lights	21 W
Rear Turn Signal Lights	21 W
High-Mount Brake Light	LED
Rear License Plate Lights	LED
Puddle Lights	LED
Interior Lights	
Front, Second Row and Third Row Lights	LED
Front and Rear Ambient Lights	LED
Vanity Mirror Lights	1.4 W
Door Courtesy Lights	3.4 W
Door Inner Handle Lights	LED
Front and Rear* Console Compartment Lights	LED
Glove Box Light	1.4 W
Foot Lights	5 W
Cargo Area Lights	5 W

■ Brake Fluid

Specified	Acura Heavy Duty Brake Fluid DOT 3
-----------	------------------------------------

■ Dual Clutch Transmission Fluid

Specified	Acura ATF DW-1 (automatic transmission fluid)
Capacity	Change 3.7 US qt (3.5 L)

■ Twin Motor Unit Fluid

Specified	Acura ATF DW-1 (automatic transmission fluid)
Capacity	Change 2.56 US qt (2.42 L)

■ Engine Oil

Recommended	-Genuine Acura Motor Oil 0W-20 -API Premium-grade 0W-20 detergent oil
Change	4.2 US qt (4.0 L)
Capacity	Change including filter 4.5 US qt (4.3 L)

■ Engine Coolant

Specified	Acura Long Life Antifreeze/Coolant Type 2
Ratio	50/50 with distilled water
Capacity	2.03 US gal (7.68 L) (change including the remaining 0.22 US gal (0.82 L) in the reserve tank)

■ Inverter Coolant

Specified	Acura Long Life Antifreeze/Coolant Type 2
Ratio	50/50 with distilled water
Capacity	0.44 US gal (1.67 L) (change including the remaining 0.108 US gal (0.409 L) in the expansion tank)

■ Tire

Regular	Size	245/50R20 102H
	Pressure psi (kPa [kgf/cm ²])	35 (240 [2.4])
Compact Spare*	Size	T165/80D17 104M
	Pressure psi (kPa [kgf/cm ²])	60 (420 [4.2])
Wheel Size	Regular	20 x 8J
	Compact Spare*	17 x 4T

* Not available on all models

Vehicle Identification Number (VIN), Engine Number, Motor Number, and Transmission Number

Your vehicle has a 17-digit vehicle identification number (VIN) used to register your vehicle for warranty purposes, and for licensing and insuring your vehicle. The locations of your vehicle's VIN, engine number, motor number, and transmission number are shown as follows:

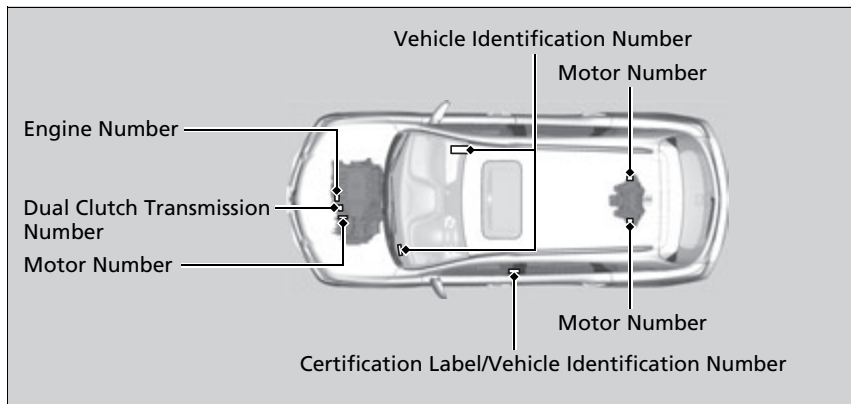

Vehicle Identification Number (VIN), Engine Number, Motor Number, and Transmission Number

The interior vehicle identification number (VIN) is located under the cover.



Devices that Emit Radio Waves

The following products and systems on your vehicle emit radio waves when in operation.

AcuraLink

Audio System

Blind Spot Information System

Bluetooth® Audio

Bluetooth® HandsFreeLink®

HomeLink® Universal Transceiver

Collision Mitigation Braking System™

Immobilizer System

Remote Transmitter

Keyless Access System

Tire Pressure Monitoring System (TPMS)

Remote Engine Start with Vehicle Feedback

Each of the above complies with the appropriate requirements or the required standards of FCC (Federal Communications Commission) and Industry Canada Standard, described below:

As required by the FCC:

This device complies with Part 15 of the FCC rules. Operation is subject to the following two conditions: (1) This device may not cause harmful interference, and (2) this device must accept any interference received, including interference that may cause undesired operation.

Changes or modifications not expressly approved by the party responsible for compliance could void the user's authority to operate the equipment.

This device complies with Industry Canada licence-exempt RSS standard(s). Operation is subject to the following two conditions: (1) this device may not cause interference, and (2) this device must accept any interference, including interference that may cause undesired operation of the device.

In the U.S.

If you believe that your vehicle has a defect which could cause a crash or could cause injury or death, you should immediately inform the National Highway Traffic Safety Administration (NHTSA) in addition to notifying American Honda Motor Co., Inc.

If NHTSA receives similar complaints, it may open an investigation, and if it finds that a safety defect exists in a group of vehicles, it may order a recall and remedy campaign. However, NHTSA cannot become involved in individual problems between you, your dealer, or American Honda Motor Co., Inc.

To contact NHTSA, you may call the Vehicle Safety Hotline toll-free at 1-888-327-4236 (TTY: 1-800-424-9153); go to <http://www.safercar.gov>; or write to: Administrator, NHTSA, 1200 New Jersey Avenue, SE., Washington, DC 20590. You can also obtain other information about motor vehicle safety from <http://www.safercar.gov>.

In Canada

If you believe that your vehicle has a defect which could cause a crash or could cause injury or death, you should immediately inform Honda Canada Inc. and you may also inform Transport Canada.

If Transport Canada receives similar complaints, it may open an investigation, and if it finds that a safety defect exists in a group of vehicles, it may lead to a recall and remedy campaign. However, Transport Canada cannot become involved in individual problems between you, your dealer, or Honda Canada Inc.

To contact Transport Canada's Defect Investigations and Recalls Division, you may call 1-800-333-0510. For more information on reporting safety defects or about motor vehicle safety, go to <http://www.tc.gc.ca/roadsafety>.

Testing of Readiness Codes

Your vehicle has readiness codes as part of the onboard self diagnostic system. Some States use these codes for testing to verify whether your vehicle's emissions components are working properly. The codes may not be read properly if testing is performed just after the 12-volt battery has gone dead or been disconnected.

To check if they are set, set the power mode to ON, without turning the power system on. The malfunction indicator lamp will come on for several seconds. If it then goes off, the readiness codes are set. If it blinks five times, the readiness codes are not set.

If you are required to have your vehicle tested before the readiness codes are ready, prepare the vehicle for retesting by doing the following:

1. Fill the gas tank to approximately 3/4 full.
2. Park the vehicle and leave the power system off for 6 hours or more.
3. Make sure the ambient temperature is between 40°F and 95°F (4°C and 35°C).
4. Turn the power system on.
5. Select a nearby, lightly traveled major highway where you can maintain a speed of 50 mph (80 km/h) over for at least 20 minutes. Drive on the highway in **D** with SPORT+ mode. Do not use cruise control.
6. Drive in city or suburban traffic for at least 10 minutes. When traffic conditions allow, let the vehicle coast for several seconds without using the accelerator pedal or the brake pedal.
7. Park the vehicle and leave the power system off for 40 minutes.

Testing of Readiness Codes

The readiness codes are erased when the 12-volt battery is disconnected, and set again only after several days of driving under a variety of conditions.

If a testing facility determines that the readiness codes are not set, you may be requested to return at a later date to complete the test.

If the testing facility determines the readiness codes are still not set, see a dealer.

■ U.S. Owners

Your new vehicle is covered by these warranties:

New Vehicle Limited Warranty – covers your new vehicle, except for the emissions control systems and accessories, against defects in materials and workmanship.

Emissions Control Systems Defects Warranty and Emissions Performance Warranty – these two warranties cover your vehicle's emissions control systems. Time, mileage, and coverage are conditional. Please read your warranty booklet for exact information.

Seat Belt Limited Warranty – a seat belt that fails to function properly is covered by a limited warranty. Please read your warranty booklet for details.

Rust Perforation Limited Warranty – all exterior body panels are covered against rusting from the inside out for the specified time period, regardless of mileage.

Accessory Limited Warranty – Acura accessories are covered under this warranty. Time and mileage limits depend on the type of accessory and other factors. Please read your warranty booklet for details.

Replacement Parts Limited Warranty – covers all Acura replacement parts against defects in materials and workmanship.

Replacement 12-Volt Battery Limited Warranty – provides prorated coverage for a replacement battery purchased from your dealer.

Replacement Muffler Lifetime Limited Warranty – provides coverage for as long as the purchaser of the muffler owns the vehicle.

Restrictions and exclusions apply to all these warranties. Please read the Acura warranty information booklet that came with your vehicle for precise information on warranty coverages. Your vehicle's original tires are covered by their manufacturer. Tire warranty information is in a separate booklet.

■ Canadian Owners

Please refer to the warranty manual that came with your vehicle.

■ EPA Contact Information

An owner may obtain further information concerning emission warranties or report violations of the terms of the emission warranties by contacting:

U.S. Environmental Protection Agency
Office of Transportation and Air Quality
Compliance Division, Light-Duty Vehicle Group
Attn: Warranty Complaints
2000 Traverwood Drive
Ann Arbor, MI 48105
Email: complianceinfo@epa.gov

■ Service Express

For electronic copies of service publications, you can purchase a subscription to Service Express. Visit www.techinfo.honda.com for pricing and options.

■ For U.S. Owners

Manuals can be purchased from Helm Incorporated. You can order a manual by phone at 1 (800) 782-4356 (credit card orders only), or online at www.helminc.com.

■ For Canadian Owners

Please contact a dealer to order any manuals that you may require.

Acura dealership personnel are trained professionals who should be able to deal with any problems you may encounter with your vehicle. If, however, you are faced with a problem that they cannot resolve to your satisfaction, contact Acura Client Relations/Services.

U.S. Owners

American Honda Motor Co., Inc.
Acura Client Relations
Mail Stop 500-2N-7E
1919 Torrance Blvd.
Torrance, CA 90501-2746
Tel: 1 (800) 382-2238

Canadian Owners

Honda Canada Inc.
Acura Client Services
180 Honda Boulevard
Markham, ON
L6C 0H9
Tel: 1-888-9-ACURA-9
Fax: 1-877-939-0909
E-mail: acura_cr@ch.honda.com

In Puerto Rico and the U.S. Virgin Islands

Bella International
P.O. Box 190816
San Juan, PR 00919-0816
Tel: (787) 620-7546

Client Service Information

When you call or write, please give us the following information:

- Vehicle Identification Number
 - ▣ **Vehicle Identification Number (VIN), Engine Number, Motor Number, and Transmission Number** P. 434
- Date of purchase
- Odometer reading of your vehicle
- Your name, address, and telephone number
- A detailed description of the problem
- Name of the dealer who sold the vehicle to you

- A**
- ABS (Anti-lock Brake System)..... 305
 - AC Power Outlet..... 209
 - Accessories and Modifications..... 380
 - Accessory Power Sockets..... 208
 - Acoustic Vehicle Alerting System 255
 - AcuraWatch™ 24
 - Adaptive Cruise Control (ACC) with Low Speed Follow (LSF)..... 259
 - Indicator..... 94
 - Additives
 - Coolant..... 347
 - Engine Oil..... 342
 - Washer..... 351
 - Additives, Engine Oil..... 342
 - Adjusting
 - Armrest..... 199
 - Front Seats..... 187
 - Head Restraints..... 193, 195, 196
 - Headlights..... 352
 - Mirrors..... 184
 - Rear Seats..... 198
 - Steering Wheel..... 183
 - Temperature..... 121
 - Agile Handling Assist..... 289
 - Air Conditioning System (Climate Control System)..... 214
 - Changing the Mode..... 217
 - Defrosting the Windshield and Windows..... 221
 - Dust and Pollen Filter..... 374
 - Rear Climate Control System..... 222
 - Sensors..... 226
 - Synchronized Mode..... 218
 - Using Automatic Climate Control..... 214
 - Air Pressure..... 362, 433
 - Airbags..... 45
 - Advanced Airbags..... 51
 - After a Collision..... 49
 - Airbag Care..... 59
 - Driver's Knee Airbag..... 52
 - Event Data Recorder..... 0
 - Front Airbags (SRS)..... 48
 - Indicator..... 57, 87
 - Passenger Front Airbag Off Indicator..... 58
 - Sensors..... 45
 - Side Airbags..... 54
 - Side Curtain Airbags..... 56
 - Anti-lock Brake System (ABS)..... 305
 - Indicator..... 87
 - Armrest..... 199
 - Audio System..... 228
 - Authorized Manuals..... 440
 - Auto Door Locking/Unlocking..... 150
 - Customize..... 131
 - Auto Engine Stop/Start..... 13
 - Auto High-Beam..... 172
 - Indicator..... 87
 - Automatic Brake Hold..... 303
 - Indicator..... 303
 - Automatic Brake Hold System
 - Indicator..... 303
 - Automatic Folding Door Mirror..... 186
 - Automatic Intermittent Wipers..... 176
 - Automatic Lighting..... 169
 - Average Fuel Economy..... 121
 - Average Speed..... 122
- B**
- Back-Up Light..... 355
 - Battery..... 370
 - 12-Volt..... 370
 - 12-Volt Battery Charging System
 - Indicator..... 82, 412
 - High Voltage..... 298
 - Jump Starting..... 407
 - Maintenance (Checking the 12-Volt Battery)..... 370
 - Maintenance (Replacing)..... 371
 - Battery Types..... 12
 - Belts (Seat)..... 37
 - Beverage Holders..... 206
 - Blind Spot Information (BSI) System..... 291
 - Indicator..... 98
 - Booster Seats (For Children)..... 74
 - Brake System..... 299
 - Anti-lock Brake System (ABS)..... 305
 - Automatic Brake Hold..... 303
 - Brake Assist System..... 306
 - Brake System Indicator..... 79
 - Fluid..... 351
 - Foot Brake..... 302

Indicator	78, 79, 414
Parking Brake	299
Brake System (Amber)	
Indicator	79
Brake System (Red)	
Indicator	78, 414
Brightness Control (Instrument Panel) ...	179
BSI (Blind Spot Information) System	291
Bulb Replacement	352
Back-Up Light	355
Brake Light and Rear Turn Signal Light ...	353
Fog Lights	352
Front Turn Signal/Parking, Daytime	
Running and Front Side Marker Lights ...	352
Headlights	352
High-Mount Brake Light	356
Puddle Lights	356
Rear License Plate Lights	356
Side Turn Signal/Emergency Indicator	
Lights	352
Taillights	355
Taillights/Rear Side Marker Lights	354
Bulb Specifications	432
C	
Car Wash Mode	251
Carbon Monoxide Gas	75
Carrying Cargo	231, 233
Center Pocket	205
Certification Label	434

Changing Bulbs	352
Charging System Indicator	82, 412
Child Safety	60
Childproof Door Locks	149
Child Seat	60
Booster Seats	74
Child Seat for Infants	62
Child Seat for Small Children	63
Installing a Child Seat with a Lap/Shoulder	
Seat Belt	68
Larger Children	73
Rear-facing Child Seat	62
Selecting a Child Seat	64
Childproof Door Locks	149
Cleaning the Exterior	377
Cleaning the Interior	375
Client Service Information	441
Climate Control System	214
Changing the Mode	217
Defrosting the Windshield and	
Windows	221
Dust and Pollen Filter	374
Rear Climate Control System	222
Sensors	226
Synchronized Mode	218
Using Automatic Climate Control	214
Clock	136
CMBS™ (Collision Mitigation Braking	
System™)	307
Coat Hook	210

Collision Mitigation Braking System™	
(CMBS™)	307
Compact Spare Tire	385, 433
Console Compartment	204
Controls	135
Coolant (Engine)	347
Adding to the Radiator	348
Adding to the Reserve Tank	347
Overheating	409
Creeping (Dual Clutch Transmission)	246
Cross Traffic Monitor	322
Cup Holders	206
Customized Features	125

D

Daytime Running Lights	171
Dead Battery	407
Defrosting the Windshield and	
Windows	221
Detachable Anchor	42
Devices that Emit Radio Waves	435
Dimming	
Headlights	168
Rearview Mirror	184
Dipstick (Engine Oil)	343
Directional Signals (Turn Signal)	167
Door Mirrors	185

Doors	137	Electric Parking Brake	
Auto Door Locking	150	Indicator	80
Auto Door Unlocking	150	Switch	299
Door Open Message	36	Electric Parking Brake System	
Keys	137	Indicator	80
Locking/Unlocking the Doors from the		Electronic Stability Control (ESC)	287
Inside	18, 147	Emergency	427
Locking/Unlocking the Doors from the		Emissions Testing (Readiness Codes)	437
Outside	139	Energy Efficiency	12
Lockout Prevention System	145	Engine	434
DOT Tire Quality Grading	364	Coolant	347
Driver's Knee Airbag	52	Jump Starting	407
Driving	229	Oil	342
Braking	299	Remote Engine Start	241
Dual Clutch Transmission	246	Starting	239
Off-Highway Driving Guidelines	237	Engine Compartment Cover	341
Shifting Gear	247	Engine Coolant	347
Turning on the Power	239	Adding to the Radiator	348
Driving Position Memory System	181	Adding to the Reserve Tank	347
Dual Clutch Transmission	246	Overheating	409
Creeping	246	Engine Oil	342
Fluid	350	Adding	344
Kickdown	246	Checking	343
Operating the Shift Button	21, 249	Displaying Oil Life	335
Shifting	247	Low Oil Pressure Indicator	82, 412
Dust and Pollen Filter	374	Recommended Engine Oil	342
Dynamic Mode button	256	EPS (Electric Power Steering)	
		System	89, 414
		Exhaust Gas Hazard (Carbon Monoxide) ..	75
		Exterior Care (Cleaning)	377
		Exterior Mirrors	185
		F	
		Features	227
		Filters	
		Dust and Pollen	374
		Oil	345
		Flat Tire	385, 392
		Floor Mats	376
		Fluids	
		Brake	351
		Dual Clutch Transmission	350
		Engine Coolant	347
		Windshield Washer	351
		Fog Lights	171
		Folding Down the Second Row Seat	192
		Folding Down the Third Row Seat	198
		Foot Brake	302
		Front Airbags (SRS)	48
		Front Seats	187
		Adjusting	187
		Front Sensor Camera	257
		Fuel	23, 327
		Fuel Economy and CO ₂ Emissions	330
		Gauge	117
		Instant Fuel Economy	122
		Low Fuel Indicator	85
		Range	122
		Recommendation	327
		Refueling	327
		Fuel Economy and CO₂ Emissions	330
		Fuel Fill Cap	23
		E	
Elapsed Time	122		

Fuel Fill Door	23, 328
Unable to Unlock	428
Fuses	418
Inspecting and Changing	426
Locations	418, 421, 424, 425

G

Gasoline (Fuel)	
Economy	330
Gauge	117
Information	327
Low Fuel Indicator	85
Refueling	327
Gauges	117
Gear Position Indicator	83, 249
Gear Shift Positions	
Dual Clutch Transmission	247
Glass (care)	378
Glove Box	203

H

Handling the Unexpected	383
Hazard Warning Button	4
Head Restraints	193, 195, 196
Headlight Washers	178
Headlights	168
Aiming	352
Auto High-Beam System	172
Automatic Operation	169

Dimming	168, 171
Operating	168
Heated Door Mirrors	180
Heated Steering Wheel	211
Heated Windshield	180
Heater (Steering Wheel)	211
Heaters (Seat)	212, 213
High Beam Indicator	89
High Voltage Battery	298
Hill Start Assist System	244
Hybrid Vehicle	
SPORT HYBRID Super Handling-All Wheel Drive™ (SPORT HYBRID SH-AWD®)	9

I

Identification Numbers	434
Engine, Motor, and Transmission	434
Vehicle Identification	434
IDS (Integrated Dynamics System)	256
Illumination Control	179
Button	179
Immobilizer System	158
Indicator	90
Indicators	78
12-Volt Battery Charging System	82, 412
Adaptive Cruise Control (ACC) with Low Speed Follow (LSF)	94, 259
Anti-lock Brake System (ABS)	87
Auto High-Beam	87
Automatic Brake Hold	81, 303

Automatic Brake Hold System	81, 303
Blind Spot Information (BSI)	98
Brake System (Amber)	79
Brake System (Red)	78, 414
Collision Mitigation Braking System™ (CMBS™)	96, 97
Electric Parking Brake	80
Electric Parking Brake System	80, 415
Fog Lights	90
Gear Position	83
High Beam	89
High Temperature	86
Immobilizer System	90
Keyless Access System	91
Lane Keeping Assist System (LKAS)....	92, 281
Lights On	90
Low Fuel	85
Low Oil Pressure	82, 412
Low Temperature	86
Low Tire Pressure/TPMS	89, 416
M (sequential mode) Indicator/Sequential Mode Gear Selection	83
Malfunction Indicator Lamp	82, 413
POWER SYSTEM Indicator	85, 417
READY	86
Road Departure Mitigation (RDM)	93
Seat Belt Reminder	39, 85
Security System Alarm	91
Speed-sensitive Electric Power Steering (EPS) System	89, 414
SPORT+ mode	86

- Supplemental Restraint System 57, 87
 - System Message 91
 - Transmission System 84, 416
 - Turn Signal 89
 - Vehicle Stability Assist (VSA®)
 - System 88, 287
 - VSA® OFF 88, 288
 - Information** 431
 - Instrument Panel** 77
 - Brightness Control 179
 - Integrated Dynamics System (IDS)** 256
 - Dynamic Mode button 256
 - Interior Lights** 201
 - Interior Rearview Mirror** 184
- J**
- Jack (Wheel Nut Wrench)** 389
 - Jump Starting** 407
- K**
- Key Number Tag** 138
 - Keyless Access System** 139
 - Keyless Lockout Prevention** 145
 - Keys** 137
 - Lockout Prevention 145
 - Number Tag 138
 - Rear Door Won't Open 149
 - Remote Transmitter 144
 - Types and Functions 137
 - Kickdown (Dual Clutch Transmission)** 246
- L**
- Lane Keeping Assist System (LKAS)** 279
 - Indicator 92
 - LATCH (Child Seats)** 65, 70
 - LED Puddle Light** 143
 - Lights** 168, 352
 - Automatic 169
 - Bulb Replacement 352
 - Daytime Running Lights 171
 - High Beam Indicator 89
 - Interior 201
 - Light Switches 168
 - Lights On Indicator 90
 - Turn Signals 167
 - Load Limits** 233
 - Locking/Unlocking** 137
 - Auto Door Locking/Unlocking 150
 - Childproof Door Locks 149
 - From Inside 147
 - From Outside 139
 - Keys 137
 - Using a Key 145
 - Lockout Prevention System** 145
 - Low Battery Charge** 412
 - Low Fuel Indicator** 85
 - Low Oil Pressure Indicator** 82, 412
 - Lower Anchors** 65, 70
 - Lubricant Specifications Chart** 433
 - Luggage (Maximum Load Limit)** 233
 - Lumbar Support** 187
- M**
- Maintenance** 331
 - 12-Volt Battery 370
 - Brake Fluid 351
 - Cleaning 375
 - Climate Control System 374
 - Coolant 347
 - Maintenance Minder™ 335
 - Oil 343
 - Precautions 332
 - Radiator 348
 - Remote Control 372
 - Remote Transmitter 371
 - Replacing Light Bulbs 352
 - Safety 333
 - Service Items 337
 - Tires 361
 - Transmission Fluid 350
 - Under the Hood 339
 - Wireless Headphone 373
 - Malfunction Indicator Lamp** 82, 413
 - Map Lights** 202
 - Maximum Load Limit** 233
 - Meters, Gauges** 117
 - MID (Multi-information Display)** 119
 - Mirrors** 184
 - Adjusting 184

Door	185	Operating the Switches Around the		Rear Climate Control System	222
Exterior	185	Steering Wheel	164	From the Front Panel	222
Interior Rearview	184	Outside Temperature Display	121	From the Rear Panel	225
Modifications (and Accessories)	380	Overheating	409	Rear Defogger/Heated Door Mirror	
Moonroof	163			Button	180
Multi-function Steering-wheel				Rear Seats	198
Controls	119	P		Second Row Seat	191, 192
Multi-Information Display (MID)	119	Paddle Shifters (Sequential Mode)	254	Third Row Seat	198
Multi-View Rear Camera	326	Panic Mode	160	Rearview Mirror	184
		Parking	316	Refueling	327
N		Parking Brake	299	Fuel Gauge	117
Numbers (Identification)	434	Parking Brake and Brake System		Gasoline	327, 432
		Indicator	78, 414	Low Fuel Indicator	85
		Parking Sensor System	318	Regenerative Energy and Regenerative	
		Passenger Front Airbag Off Indicator	58	Braking	12
		Passing Indicators	168	Regulations	296, 364, 435
		POWER Button	164	Remote Engine Start with Vehicle	
		Power Tailgate	153	Feedback	241
		Power Windows	161	Checking Door Lock Status	146
		Precautions While Driving	245	Remote Transmitter	144
		Driving Guidelines for Your Utility		Replacement	
		Vehicle	245	Battery	371, 372, 373
		Rain	245	Bulbs	352
		Pregnant Women	43	Front Wiper Blade Rubber	357
		Puncture (Tire)	385, 392	Fuses	418, 421, 424, 425
				Rear Wiper Blade Rubber	359
				Tires	367
		R		Reporting Safety Defects	436
		Radiator	348	Resetting a Trip Meter	121
		Range	122	Reverse Tilt Door Mirror	185
		Readiness Codes (Emissions Testing)	437	Right Selector Wheel	119, 125
O					
Odometer	120				
Off-Highway Driving Guidelines	237				
Oil (Engine)	342				
Adding	344				
Checking	343				
Displaying Oil Life	335				
Low Oil Pressure Indicator	82, 412				
Recommended Engine Oil	342				
Viscosity	342				
Opening/Closing					
Hood	340				
Moonroof	163				
Power Windows	161				
Tailgate	151				

Road Departure Mitigation (RDM).....	274
On and Off.....	276

S

Safe Driving.....	31
Safety Checklist.....	36
Safety Labels.....	76
Safety Message.....	1
Seat Belts.....	37
Adjusting the Shoulder Anchor.....	41
Automatic Seat Belt Tensioners.....	39
Checking.....	44
Detachable Anchor.....	42
Fastening.....	40
Installing a Child Seat with a Lap/Shoulder Seat Belt.....	68
Pregnant Women.....	43
Reminder.....	39
Warning Indicator.....	39, 85
Seat Heaters.....	212, 213
Seat Ventilation.....	212
Seats.....	187
Adjusting.....	187
Driver's Seat Lumbar Support.....	187
Front Seats.....	187
Rear Seats.....	198
Seat Heaters.....	212, 213
Seat Ventilation.....	212
Second Row Seat.....	191, 192
Third Row Seat.....	198

Second Row Outer Seats Heaters.....	213
Second Row Seat (Folding Down).....	192
Security System.....	158
Immobilizer System Indicator.....	90
Security System Alarm Indicator.....	91
Selecting a Child Seat.....	64
Sequential Mode.....	253
Sequential Mode Operation.....	254
Setting the Clock.....	136
SH-AWD® Torque Distribution Monitor..	123
Shift Button.....	21, 247
Operation.....	249
Shifting (Transmission).....	21, 247
Shoulder Anchor.....	41
Side Airbags.....	54
Side Curtain Airbags.....	56
Snow Tires.....	369
Sounds Unique to the SPORT HYBRID SH-AWD® System.....	13
Spare Tire.....	385, 433
Spark Plugs.....	432
Specifications.....	432
Specified Fuel.....	327, 432
Speedometer.....	117
Speed-sensitive Electric Power Steering (EPS) System.....	89, 414
SPORT HYBRID Super Handling-All Wheel Drive™ (SPORT HYBRID SH-AWD®).....	290
SRS Airbags (Airbags).....	48

Steering Wheel.....	183
Adjusting.....	183
Heater.....	211
Stopping.....	316
Summer Tires.....	369
Sunglasses Holder.....	211
Supplemental Restraint System (SRS).....	48
Switches (Around the Steering Wheel).....	4, 5, 164
Synchronized Mode.....	218
System Message Indicator.....	91

T

Tachometer.....	117
Tailgate.....	151
Unable to Open.....	429
Temperature.....	
Outside Temperature Display.....	121
Temperature Sensor.....	121, 226
Temporary Tire Repair Kit.....	393
Third Row Seat (Folding Down).....	198
Third Row Seat Access.....	191
Tie-down Anchors.....	210
Time (Setting).....	136
Tire Fill Assist.....	294, 416
Tire Pressure Monitoring System (TPMS) with Tire Fill Assist.....	294
Indicator.....	89, 416
Tire Repair Kit.....	392

Wipers and Washers	175
Automatic Intermittent Wipers.....	176
Checking and Replacing Wiper Blades	357
Front	175
Rear.....	177
Worn Tires	361

