



08/09/25 13:11:14 31HP2630 0001



This manual should be considered a permanent part of the ATV and should remain with the ATV when it is resold.

This publication includes the latest production information available before printing. Honda Motor Co., Ltd. reserves the right to make changes at any time without notice and without incurring any obligation.

No part of this publication may be reproduced without written permission.

The vehicle pictured on the front cover may not match your vehicle.

© Honda Motor Co., Ltd. 2008





**2009
Honda TRX90X
SPORTRAX 90X
OWNER'S MANUAL**

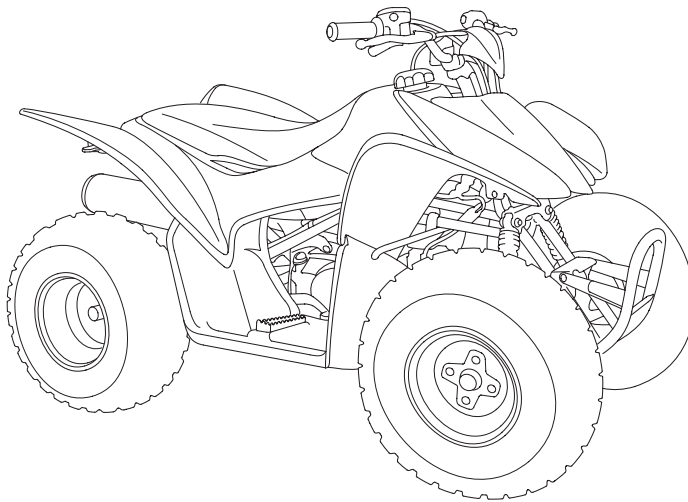

FOR OFF-ROAD USE ONLY

This vehicle is designed and manufactured for off-road use only.

USA only:

It conforms to US EPA Noise Emission regulations, but does not conform to Federal Motor Vehicle Safety Standards or US EPA On Highway Exhaust Emission regulations, and operation on public streets, roads, or highways is illegal. The vehicle is equipped with a USDA qualified spark arrester. Obey local laws and regulations.

It conforms to US EPA, California, and Environment Canada emission regulations for ATVs.



Introduction

Congratulations on choosing your Honda ATV.

When you own a Honda, you're part of a worldwide family of satisfied customers — people who appreciate Honda's reputation for building quality into every product.

Your Honda was designed as a recreational ATV for off-road use by one rider only.

Before riding, take time to get acquainted with your ATV and how it works. To protect your investment, we urge you to take responsibility for keeping your ATV well maintained. Scheduled service is a must, of course. But it's just as important to observe the break-in guidelines, and perform all pre-ride and other periodic checks detailed in this manual.



We also recommend that you read this owner's manual before you ride. It's full of facts, instructions, safety information, and helpful tips. To make it easy to use, the manual contains a detailed list of topics at the beginning of each section, and both an in-depth table of contents and an index at the back of the book.



As you read this manual, you will find information that is preceded by a **NOTICE** symbol. This information is intended to help you avoid damage to your Honda, other property, or the environment.

Read the Warranties Booklet (page 197) thoroughly so you understand the coverages that protect your new Honda and are aware of your rights and responsibilities.

Whenever you ride, tread lightly. By staying on established trails and riding only in approved areas, you help protect the environment and keep off-road riding areas open for the future.

Introduction

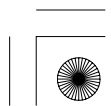
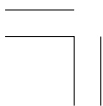



Introduction

If you have any questions, or if you ever need special service or repairs, remember that your Honda dealer knows your ATV best and is dedicated to your complete satisfaction.

Please report any change of address or ownership to your Honda dealer so we will be able to contact you concerning important product information.

You may also want to visit our website at www.honda.com.

Happy riding!

California Proposition 65 Warning

WARNING: This product contains or emits chemicals known to the State of California to cause cancer and birth defects or other reproductive harm.



A Few Words About Safety

Your safety, and the safety of others, is very important. And operating this ATV safely is an important responsibility.

To help you make informed decisions about safety, we have provided operating procedures and other information on labels and in this manual. This information alerts you to potential hazards that could hurt you or others.

Of course, it is not practical or possible to warn you about all hazards associated with operating or maintaining an ATV. You must use your own good judgment.

You will find important safety information in a variety of forms, including:

Safety Labels — on the ATV.

Safety Messages — preceded by a safety alert symbol  and one of three signal words: **DANGER**, **WARNING**, or **CAUTION**.

A Few Words About Safety



A Few Words About Safety

These signal words mean:

 **DANGER**

You **WILL** be **KILLED** or **SERIOUSLY HURT** if you don't follow instructions.

 **WARNING**

You **CAN** be **KILLED** or **SERIOUSLY HURT** if you don't follow instructions.

 **CAUTION**

You **CAN** be **HURT** if you don't follow instructions.

 **Safety Headings** — such as Important Safety Reminders or Important Safety Precautions. 

Safety Section — such as ATV Safety.

Instructions — how to use this ATV correctly and safely.

This entire manual is filled with important safety information — please read it carefully.

A Few Words About Safety





Contents

These pages give an overview of the contents of your owner’s manual. The first page of each section lists the topics covered in that section.

ATV Safety 1
Important safety information and a special message for parents you should know, plus a look at the safety-related labels on your ATV.

Indicator & Controls..... 13
The location and function of indicators and controls on your ATV and operating instructions for various controls and features.

Before Riding..... 29
The importance of wearing a helmet and other protective gear, how to make sure you and your ATV are ready to ride, and important information about loading.

Basic Operation & Riding 43
How to start and stop the engine, shift gears, and brake. Also, riding precautions.



Contents





Contents

Servicing Your Honda 79
 Why your ATV needs regular maintenance, what you need to know before servicing your Honda, an owner maintenance schedule, and instructions for specific maintenance and adjustment items.

Tips 151
 How to store and transport your ATV and how to be an environmentally responsible rider.

Taking Care of the Unexpected 161
 What to do if you have a flat tire, your engine won't start, etc.

Technical Information 179
 ID numbers, technical specifications, and other technical facts.

Consumer Information 193
 Information on warranties, emission controls, how to get Honda service manuals.

Table of Contents 202
 Sequential listing of topics in this owner's manual.

Index 208

Quick Reference
 Handy facts about fuel, engine oil, tire sizes, and air pressures.



08/09/25 13:12:02 31HP2630 0009

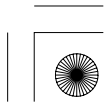
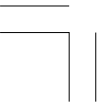



ATV Safety

This section presents some of the most important information and recommendations to help you ride your ATV safely. Please take a few moments to read these pages. This section also includes information about the location of safety labels on your ATV.

Important Safety Information	2
Important Message to Parents	5
Safety Labels.....	9

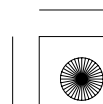



Important Safety Information

Your ATV can provide many years of service and pleasure if you take responsibility for your own safety and understand the challenges you can meet while riding.

This ATV has been designed for younger riders. However, not all youngsters are physically or emotionally ready to ride. Therefore, before parents allow any youngster to ride this ATV, we urge them to carefully read the *Important Message to Parents* beginning on page 5 and the *Parents, Youngsters & ATVs* booklet that came with the ATV (USA only).

There is much that you can do to protect yourself when you ride. You'll find many helpful recommendations throughout this manual. The following are a few that we consider to be most important.

Follow the Age Recommendation

The minimum recommended age for this ATV model is 10. For safety, children under age 10 should never operate this ATV. Refer to the age warnings provided in this manual and on the ATV.

Always Wear a Helmet

It's a proven fact: helmets significantly reduce the number and severity of head injuries. So always wear an approved motorcycle helmet. We also recommend that you wear eye protection, sturdy boots, gloves, and other protective gear (page 30).

Never Carry a Passenger

Your ATV is designed for one person only. There are no handholds, footrests, or seat for a second person, so never carry a passenger. A passenger could interfere with your ability to move around to maintain your balance and control of the ATV.

2 ATV Safety

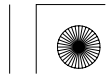



Important Safety Information

Ride Off-road Only

Your ATV is designed and manufactured for off-road use only. The tires are not made for pavement, and the ATV does not have turn signals and other features required for use on public roads. If you need to cross a paved or public road, get off and walk your ATV across.

Take Time to Learn & Practice

Even if you have ridden other ATVs, take time to become familiar with how this ATV works and handles. Practice in a safe area until you build your skills and get accustomed to the ATV's size and weight.

Because many accidents involve inexperienced or untrained riders, we urge all riders to take a training course approved by the ATV Safety Institute (ASI). See page 32.

Contact an authorized ATV dealer or call 1-800-887-2887 (USA only) to find out about the training courses nearest you.

Be Alert for Off-road Hazards

The terrain can present a variety of challenges when you ride off-road. Continually "read" the terrain for unexpected turns, drop-offs, rocks, ruts, and other hazards. Always keep your speed low enough to allow time to see and react to hazards.



Important Safety Information

Ride within Your Limits

Pushing limits is another major cause of ATV accidents. Never ride beyond your personal abilities or faster than conditions warrant. Remember that alcohol, drugs, fatigue, and inattention can significantly reduce your ability to make good judgments and ride safely.

Don't Drink and Ride

Alcohol and riding don't mix. Even one drink can reduce your ability to respond to changing conditions, and your reaction time gets worse with every additional drink. So don't drink and ride, and don't let your friends drink and ride either.

Keep Your Honda in Safe Condition

It's important to keep your ATV properly maintained and in safe riding condition. Having a breakdown can be difficult, especially if you are stranded off-road far from your base. To help avoid problems, inspect your ATV before every ride and perform all recommended maintenance.

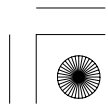

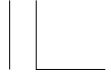

Important Message to Parents

Your child's safety is very important to Honda. That's why we urge you to read this message before you let any young person ride this ATV. Off-road riding can be fun. But, as with riding a bicycle, bad judgment can result in injury, and we don't want that to happen! As a parent, you can help prevent accidents by making good decisions about if, when, and how your youngster rides this ATV.

Riding Readiness

The first decision you'll need to make is whether your youngster is ready to ride. Riding readiness varies widely from one person to another, and while the minimum age recommended for this ATV is 10 years old, there are other factors that you should consider.



PHYSICAL ABILITY are important considerations. To help determine whether a youngster is big enough for this ATV, have them stand up on the footpegs and grasp the handgrips. While the youngster holds this position, check that they have at least three inches of clearance between the ATV seat and the youngster's "seat of the pants." A rider needs at least three inches of clearance so they can stand up for balance and comfort, and to shift their body forward, backward and from side to side.

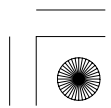
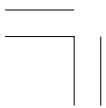



Important Message to Parents

Also make sure your youngster can comfortably reach and work all the controls. For example, can they turn the handlebars all the way to the right and left? Can they easily use their feet to work the brake pedal and gearshift lever? Can they operate the throttle and brake levers while they hold onto the handgrips? If not, the youngster is not physically ready to ride this ATV.

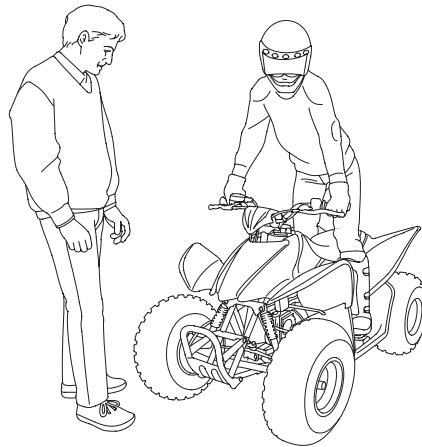

Before you let a youngster ride an ATV, decide whether they are physically, mentally and emotionally ready to ride.

ATHLETIC ABILITY is another requirement for riding an ATV. Generally speaking, your youngster should be good at riding a bicycle before they get on an ATV. Can your youngster judge speeds and distances while riding a bicycle and react with proper hand and foot actions? Anyone who does not have good coordination, balance, and agility is not ready for this ATV.

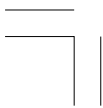



Important Message to Parents

MENTAL AND EMOTIONAL MATURITY maturity are also necessary for safe riding. Does your youngster think through problems and come to logical solutions? On a bicycle, does your youngster obey safe riding rules? Be honest! Young people who take unnecessary risks, make bad judgments and don't obey rules are not ready to ride this ATV.

Instruction and Supervision

If you decide that your youngster is ready to safely operate this ATV, make sure both of you first carefully read and understand the instructions and warnings in this owner's manual.

Also be sure that your youngster always wears a helmet and other appropriate riding equipment when operating or sitting on it (page 30).

Because good instruction is an important part of learning how to ride, we strongly recommend that young riders take the free hands-on training course Honda offers to all new ATV owners and immediate family members. We also recommend that you take or observe the course with your youngster. This will enable you to better understand proper riding techniques and safety messages.

To enroll in a class in your area, call 1-800-887-2887 (USA only).

Even if a youngster takes a certified training course, it's up to you to ensure your youngster's safety. Remember, learning to ride an ATV is a gradual step-by-step process. It takes time, patience and practice.

To help you regulate your youngster's rate of learning, your ATV was delivered with an adjustable throttle limiter and an air restrictor. We recommend that all beginning riders start off with the throttle limiter adjusted as delivered. The limiter may be adjusted to gradually increase maximum speed as the beginner becomes more familiar with operating the ATV. For adjustment and removal instructions, see pages 46 – 48 .



Important Message to Parents

SUPERVISION is another important obligation of parents. Even after youngsters have become skilled off-road riders, make sure they always have adult supervision while riding. It also helps to regularly remind young riders to follow the instructions and warnings in this manual. And remember, it's the parents' responsibility to see that the ATV is properly maintained and kept in safe operating condition.

If you choose to lend your ATV, do make sure that any riders under 16 years old will have adult supervision. Your youngster should understand that the decision to lend the ATV is yours.

SAFE AND RESPONSIBLE RIDING must be an on-going commitment — by you and your youngster. When you both put safety first, you can enjoy more peace of mind, and your youngster can enjoy many hours of safe off-road riding.

In Summary

Children differ in skills, physical abilities, and judgement. Some children may not be able to operate an ATV safely. Parents should supervise their child's use of the ATV at all times.

Parents should permit continued use only if they determine that the child has the ability to operate the ATV safely.





Safety Labels

Your ATV comes with a hang tag and several labels containing important safety information. Anyone who rides the vehicle should read and understand this information before riding.

Parents of young riders should make sure their youngsters read and understand the hang tag and label information before allowing them to ride.

The labels should be considered permanent parts of the vehicle. If a label comes off or becomes hard to read, contact your Honda dealer for replacements.



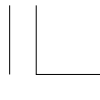

Safety Labels

WARNING

Improper ATV use can result in SEVERE INJURY or DEATH

ALWAYS USE AN APPROVED HELMET AND PROTECTIVE GEAR. NEVER USE ON PUBLIC ROADS. NEVER CARRY PASSENGERS. NEVER USE WITH DRUGS OR ALCOHOL.

NEVER operate:

- without proper training or instruction
- at speeds too fast for your skills or the conditions
- on public roads - a collision can occur with another vehicle
- with a passenger - passengers affect balance and steering and increase risk of losing control

ALWAYS:

- use proper riding techniques to avoid vehicle overturns on hills and rough terrain and in turns
- avoid paved surfaces - pavement may seriously affect handling and control

LOCATE AND READ OWNER'S MANUAL.
FOLLOW ALL INSTRUCTIONS AND WARNINGS.

Y-10+
YOUTH MODEL

This ATV is for
**RECREATIONAL USE
BY YOUNG OPERATORS
UNDER
ADULT SUPERVISION**

**NO OPERATOR
UNDER AGE 10**

**OPERATOR ONLY
-NO PASSENGERS**

Training courses to teach ATV riding are available.
For information contact your dealer.

Check with your dealer to find out about
state or local laws regarding ATV operation.

This hanging tag is not to be removed before use.

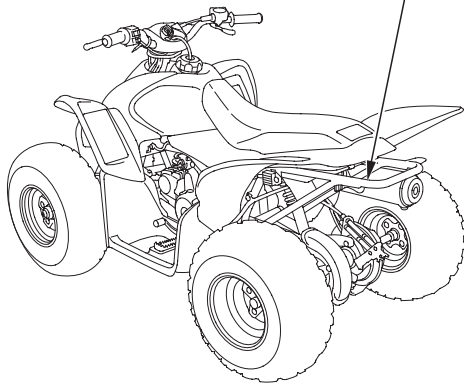

10 ATV Safety

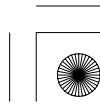
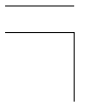



Safety Labels



(For Canada)

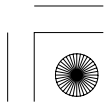
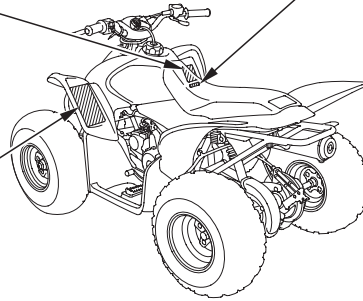
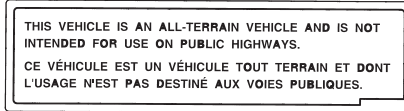



Safety Labels

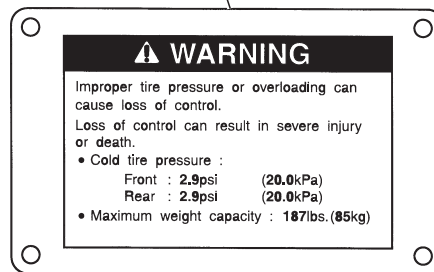
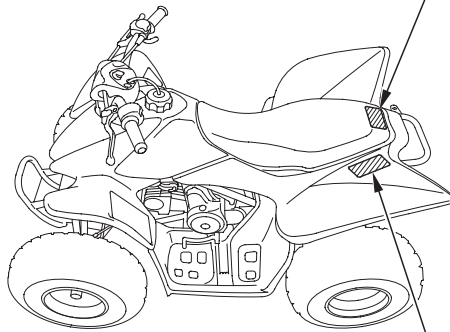



Indicator & Controls

This section shows the location of all indicators and controls you would normally use before or while riding your ATV.

The items listed on this page are described in this section. Instructions for other components are presented in other sections of this manual where they will be most useful.

Operation Component Locations	14
Indicator	17
Neutral Indicator Lamp	17
Controls & Features	18
Fuel Valve	18
Choke Lever	19
Ignition Switch	20
Start button	21
Engine Stop Switch	22
Throttle Lever	23
Front Brake Lever	24
Rear Brake Lever	24
Rear Brake Pedal	25
Parking Brake	26
Flag Pole Bracket	27

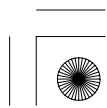
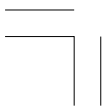



Operation Component Locations

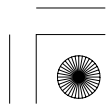
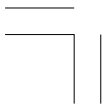
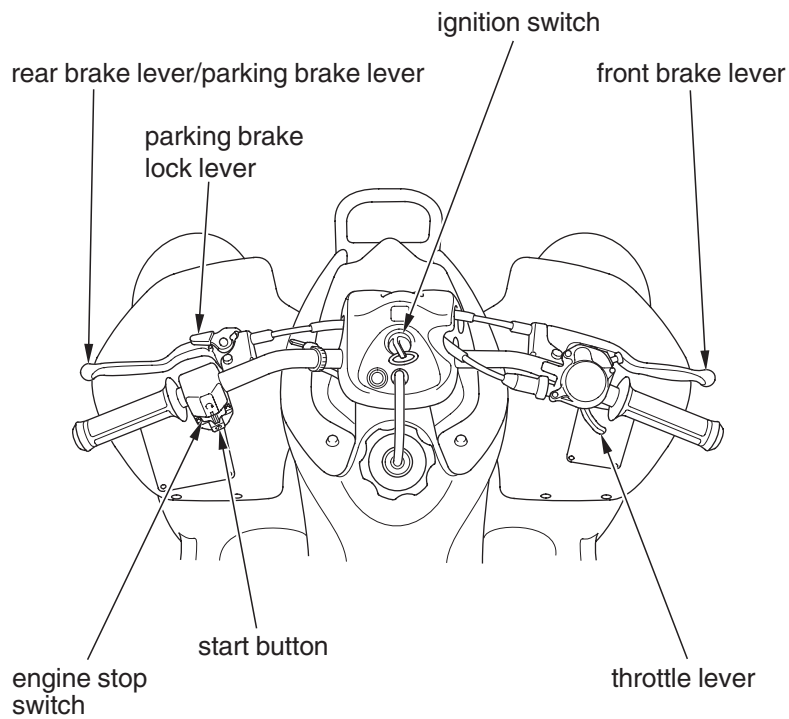



Operation Component Locations

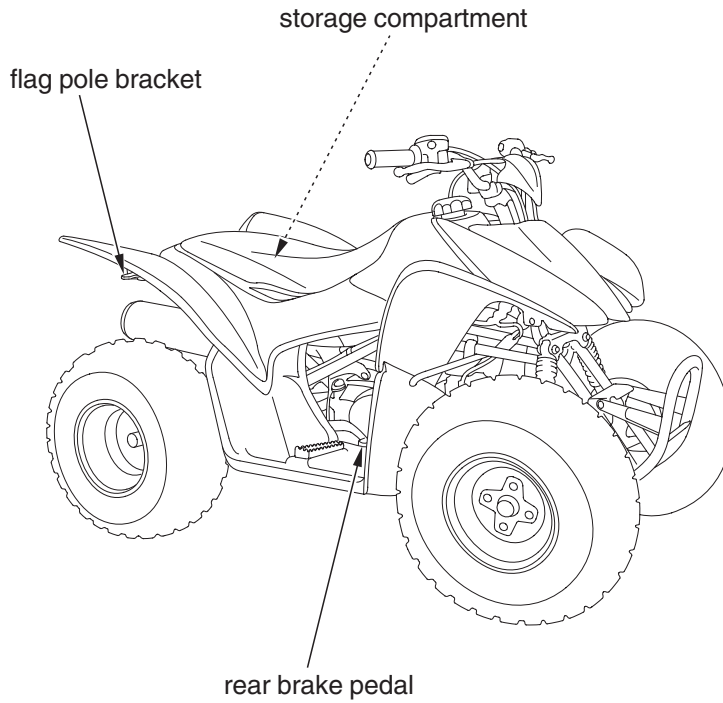



Operation Component Locations

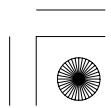
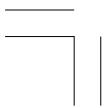
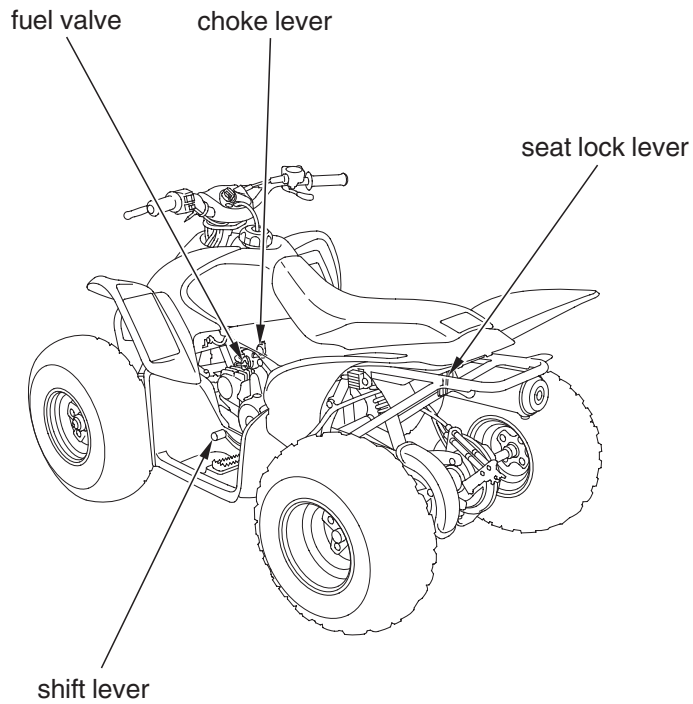



Indicator

Neutral Indicator Lamp

The neutral indicator lamp (1) is located on the handlebar case.

The neutral indicator lamp will light when the transmission is in neutral and the ignition switch is ON (I).

If the indicator does not come on when it should, have your Honda dealer check for a burned-out bulb or other problems.

FRONT

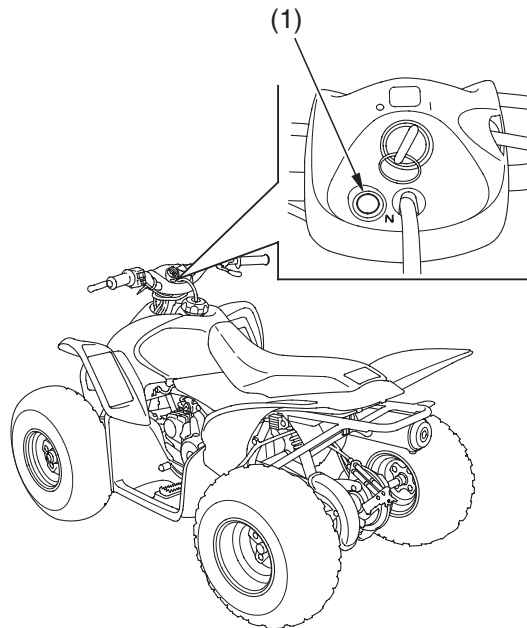

(1) neutral indicator lamp



Controls & Features

Fuel Valve

LEFT SIDE

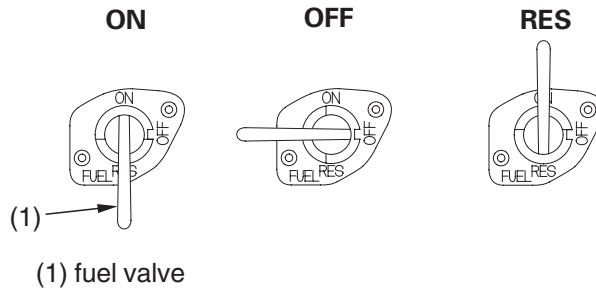

The manual fuel valve (1) is located on the left side under the fuel tank.

The three-way fuel valve is used to control the flow of fuel from the fuel tank to the carburetor.

ON—normal position for riding.

OFF—for parking, storing, or transportation.

RES—for extra fuel to get to a gas supply for refueling.

Reserve Fuel

Remember to check that the fuel valve is in the ON position each time you refuel. If the fuel valve is left in the RES position, you may run out of fuel with no reserve.

For complete information about fueling your ATV, see page 97 .

18 Indicator & Controls

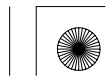



Controls & Features

Choke Lever



LEFT SIDE

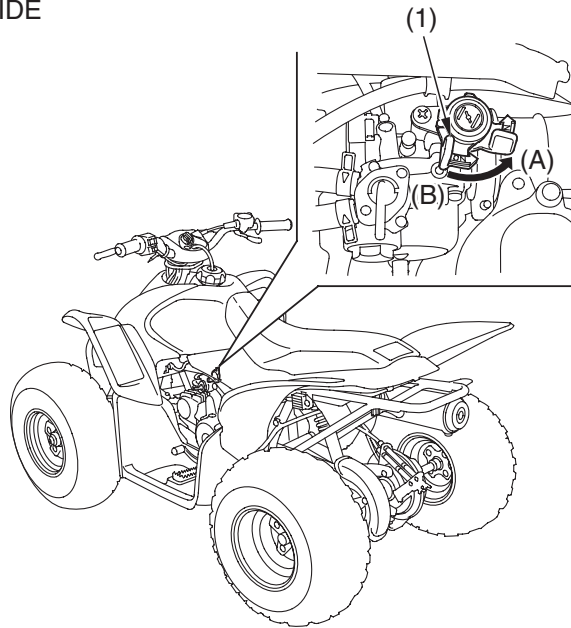

(1) choke lever

(A) fully ON
(B) fully OFF

The choke lever (1) may be used when starting the engine. See page 56 .



Controls & Features

Ignition Switch

The ignition switch (1) is used for starting and stopping the engine (page 55). Insert the key and turn it to the right for the ON (I) position.

Key Position	Function
ON (I)	Electrical circuits on.
OFF (O)	No electrical circuits function.

CENTER OF HANDLEBAR

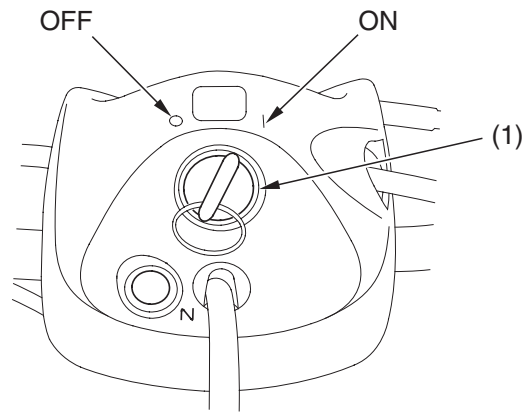

(1) ignition switch

I ON
O OFF

20 Indicator & Controls





Controls & Features

Start Button



LEFT HANDLEBAR

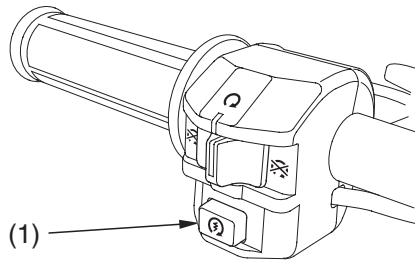

(1) start button

 START

The start button (1) is used for starting the engine. Pushing the button in starts the engine. See *Starting Procedure*, page 56.

When the start button is pushed, the starter motor will crank the engine. The starter motor will not operate if the engine stop switch is in the OFF () position when the start button is pushed.

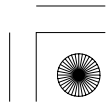
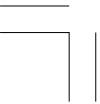



Controls & Features

Engine Stop Switch

The engine stop switch (1) is used to stop the engine in an emergency. To operate, slide the switch to the OFF (⊗) position. The switch must be in the RUN (○) position to start the engine, and it should normally remain in the RUN (○) position even when the engine is OFF.

If your ATV is stopped with the ignition switch ON (I) and the engine stop switch OFF (⊗), the battery will discharge. Turn the ignition switch OFF (O) to prevent battery discharge.

LEFT HANDLEBAR

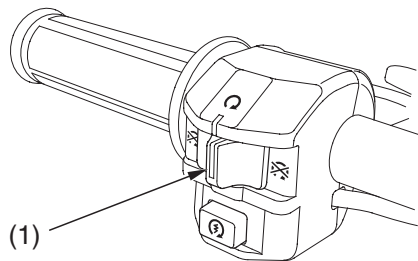

(1) engine stop switch

⊗ OFF
○ RUN

22 Indicator & Controls

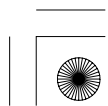
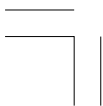



Controls & Features

Throttle Lever

The throttle controls engine rpm (speed). To increase engine rpm, press the throttle lever (1) with your thumb. To reduce engine rpm, release pressure on the throttle lever. The throttle will automatically return to the closed position (engine idle) when you remove your thumb.

RIGHT HANDLEBAR

OPEN

CLOSE

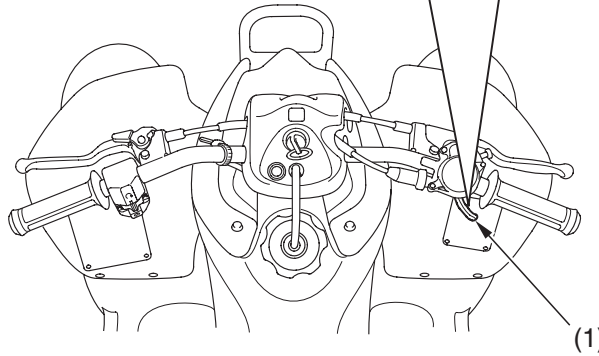
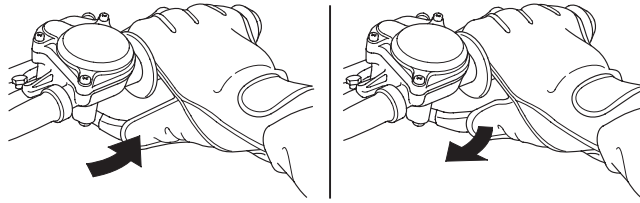

(1) throttle lever



Controls & Features

Front Brake Lever

The front brake lever (1) is used to slow or stop your ATV. To operate, pull the lever. For information on braking techniques, see page 63 .

Rear Brake Lever

The rear brake lever/parking brake lever (2) is used to slow or stop your ATV. To operate, pull the lever. For information on braking techniques, see page 63 .

LEFT & RIGHT HANDLEBAR

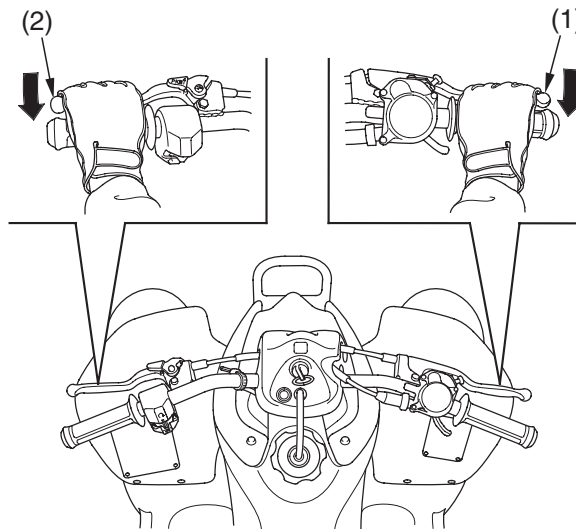

- (1) front brake lever
- (2) rear brake lever/parking brake lever

24 Indicator & Controls

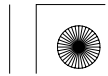



Controls & Features

Rear Brake Pedal

The rear brake pedal (1) is used to slow or stop your ATV. To operate, depress the pedal. For information on braking techniques, see page 63 .

RIGHT SIDE

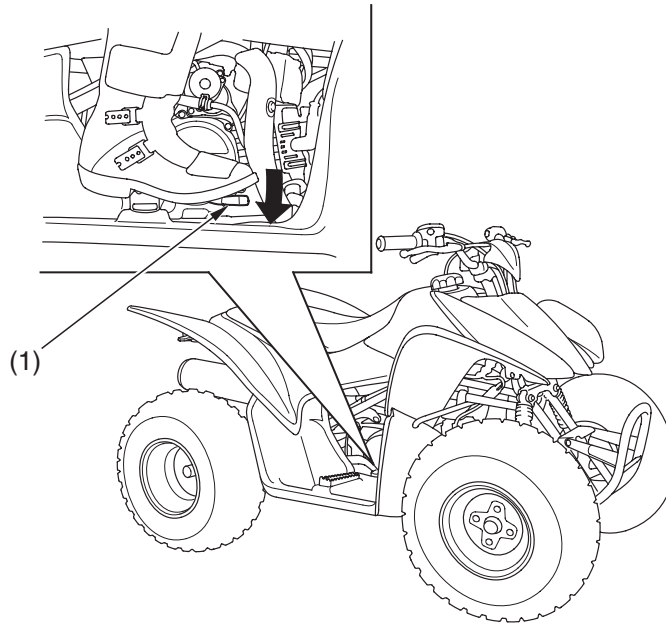

(1) rear brake pedal





Controls & Features

Parking Brake

The lock lever (1) on the rear brake lever/parking brake lever (2) allows it to be used as a parking brake.

LEFT HANDLEBAR

1. Squeeze the rear brake lever/parking brake lever.

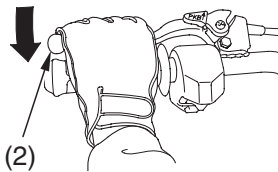

(2) rear brake lever/parking brake lever

2. Lock it with the lock lever.

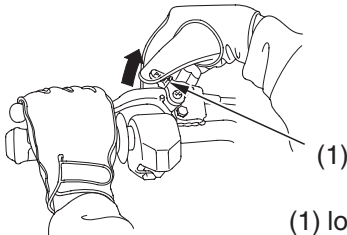

(1) lock lever

3. Unlock the parking brake by squeezing the rear brake lever/parking brake lever until the lock lever releases.

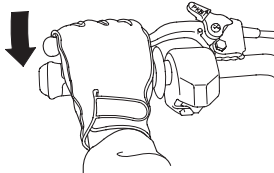

26 Indicator & Controls





Controls & Features

Flag Pole Bracket

RIGHT REAR

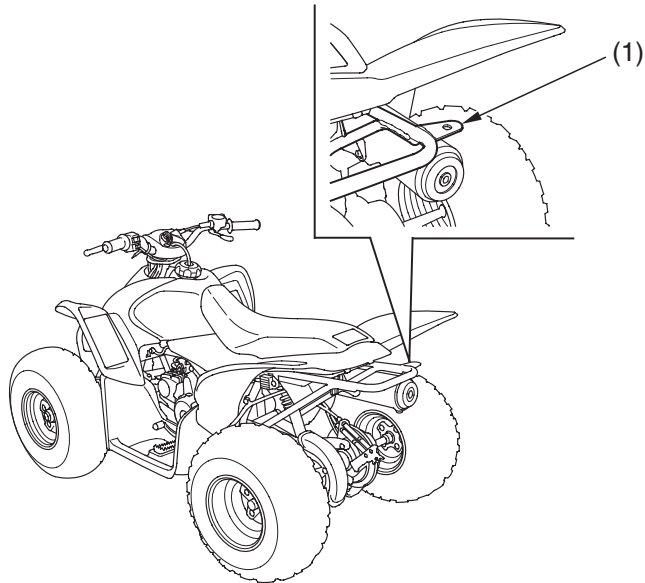

(1) flag pole bracket

Flag poles are optional equipment available from your Honda dealer. To mount a pole in the bracket (1), follow the instructions that come with the flag pole kit.

Flag poles are required in some riding areas. Check local regulations before riding.



08/09/25 13:14:48 31HP2630 0037

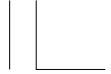

28 Indicator & Controls

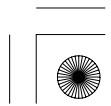



Before Riding

Before each ride, you need to make sure you and your Honda are both ready to ride. To help get you prepared, this section discusses how to evaluate your riding readiness, what items you should check on your ATV, and adjustments to make for your comfort, convenience, or safety. This section also includes important information about loading.

Are You Ready to Ride ?	30
Protective Apparel.....	30
Rider Training	32
Age Recommendation	33
No Passengers	33
No Alcohol or Drugs.....	34
Is Your ATV Ready to Ride ?.....	35
Pre-ride Inspection	36
Load Limits & Guidelines.....	38
Loading	38
Load Limits	39
Loading Guidelines	39
Accessories & Modifications	40
Accessories.....	40
Modifications	41

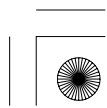



Are You Ready to Ride?

Before you ride your ATV for the first time, we urge you to:

- Read this owner's manual and the labels on your ATV carefully.
- Make sure you understand all the safety messages.
- Know how to operate all the controls.

Before each ride, be sure:

- You feel well and are in good physical and mental condition.
- You are wearing an approved motorcycle helmet (with chin strap tightened securely), eye protection, and other protective clothing.
- You don't have any alcohol or drugs in your system.

Protective Apparel

For your safety, we strongly recommend that you always wear an approved motorcycle helmet, eye protection, boots, gloves, long pants, and a long-sleeved shirt or jacket whenever you ride.

Although complete protection is not possible, wearing proper gear can reduce the chance of injury when you ride.

Following are suggestions to help you choose the proper gear.

Helmets and Eye Protection

Your helmet is your most important piece of riding gear because it offers the best protection against head injuries. A helmet should fit your head comfortably and securely.

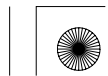



Are You Ready to Ride?

An open-face helmet offers some protection, but a full-face helmet offers more. Regardless of the style, look for a DOT (Department of Transportation) sticker on any helmet you buy (USA only). Always wear a face shield or goggles to protect your eyes and help your vision.

WARNING

Operating this ATV without wearing an approved motorcycle helmet, eye protection, and protective clothing could increase your chances of severe injury or death in the event of an accident.

Always wear an approved motorcycle helmet that fits properly and wear eye protection (goggles or face shield), gloves, boots, long-sleeved shirt or jacket and long pants.



Additional Riding Gear

In addition to a helmet and eye protection, we also recommend:

- Sturdy off-road motorcycle boots to help protect your feet, ankles, and lower legs.
- Off-road motorcycle gloves to help protect your hands.
- Riding pants with knee and hip pads, a riding jersey with padded elbows, and a chest/shoulder protector.

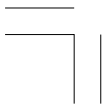



Are You Ready to Ride?

Rider Training

Developing your riding skills is an on-going process. Even if you have ridden other ATVs, take time to become familiar with how this ATV works and handles. Practice riding the ATV in a safe area to build your skills. Do not ride in rough terrain until you get accustomed to the ATV's controls, and feel comfortable with its size and weight.

We urge all riders to take a certified course approved by the ATV Safety Institute (ASI). For information about the ASI training course nearest you, call the national toll-free number; (800) 887-2887 (USA only).

Other riding tips can be found in the *Parents, Youngster & ATVs* booklet that came with your ATV (USA only).



WARNING

Operating this ATV without proper instruction could increase your risk of an accident which could lead to serious injury or death.

Beginning and inexperienced operators should complete the certified training course offered by Honda. They should then regularly practice the skills learned in the course and the operating techniques described in the owner's manual.

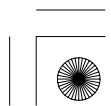
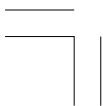



Are You Ready to Ride?

Age Recommendation

The minimum recommended age for this ATV model is 10. For safety, never let children under 10 years old operate this vehicle. Children under 16 should be supervised by an adult.

WARNING

A child using an ATV that is not recommended for their age could lose vehicle control while riding, resulting in severe injury or death.

A child under 10 should never operate this ATV.



No Passengers

This ATV is designed as an operator-only vehicle. The long seat is designed to allow the rider to change body position, not for carrying a passenger. Never let a passenger ride on the seat or on the front or rear cargo racks.



WARNING

Carrying a passenger on this ATV greatly reduces your ability to balance and control this ATV and could cause a crash and you or your passenger could be injured or killed.

Never carry a passenger on this ATV.

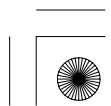
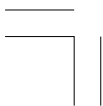



Are You Ready to Ride?

No Alcohol or Drugs

Alcohol, drugs and ATVs don't mix. Even a small amount of alcohol can impair your ability to operate an ATV safely. Likewise, drugs – even if prescribed by a physician – can be dangerous while operating an ATV. Consult your doctor to be sure it is safe to operate a vehicle after taking medication.

WARNING

Operating this ATV after consuming alcohol or drugs can seriously affect your judgement, cause you to react more slowly, affect your balance and perception, and result in serious injury or death.

Never consume alcohol or drugs before or while operating this ATV.

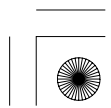
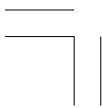



Is Your ATV Ready to Ride?

Before each ride, it's important to inspect your ATV and make sure any problem you find is corrected. A pre-ride inspection is a must, not only for safety, but because having a breakdown, or even a flat tire, can be a major inconvenience.

If your ATV has overturned or been involved in a collision, do not ride the vehicle until it has been inspected by your Honda dealer. There may be damage or other problems you cannot see.

WARNING

Improperly maintaining this ATV or failing to correct a problem before riding can cause a crash in which you can be seriously hurt or killed.

Always perform a pre-ride inspection before every ride and correct any problems.

Note to Parents:

If a youngster will be performing any of the following pre-ride inspection procedures, it's your responsibility to provide careful supervision and make sure they are performed safely.



Is Your ATV Ready to Ride?

Pre-ride Inspection

Check the following items before you get on the ATV:

Engine Oil

Check the level and add oil if needed (page 100).
Check for leaks.

Fuel

Check the level and add fuel (page 97) if needed. Also make sure the fuel fill cap is securely fastened.
Check for leaks.

Tires

Use a gauge to check the air pressure. Adjust if needed. Also look for signs of damage or excessive wear (page 126).

Drive Chain

Check the condition and slack. Adjust and lubricate if needed. Also check the chain slider and chain roller for wear and replace if needed (page 135).

Nuts & Bolts

Check the wheels to see that the axle nuts are tightened. Use a wrench to make sure all accessible nuts, bolts, and fasteners are tight.

Underbody & Exhaust System

Check for, and remove, any dirt, vegetation or other debris that could be a fire hazard or interfere with the proper operation of the vehicle.

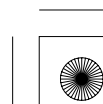
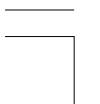



Is Your ATV Ready to Ride?

Leaks, Loose Parts Walk around your ATV and look for anything that appears unusual, such as a leak or loose cable.

Cable Check the cable housings for wear. Check the fittings for looseness. Replace or tighten as needed.

Check these items after you get on the ATV:

Throttle Check the freeplay and adjust if needed. Press the throttle to make sure it moves smoothly without sticking, and snaps shut automatically when it is released, in all steering positions (page 109).



Brakes Squeeze the front and rear brake levers and step on the rear brake pedal to check that the controls operate normally. Check for proper freeplay (pages 118 – 123).



Engine Stop Switch Check for proper function (page 22).

Steering Check that the wheels turn properly as you steer the handlebar. Move the handlebar right and left and check that there is no excessive backlash.

Remember, be sure to take care of any problem you find, or have your Honda dealer correct it before you ride.

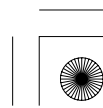
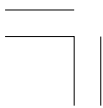



Load Limits & Guidelines

Your Honda was designed as a rider-only ATV. It was not designed to carry a passenger or cargo. A passenger or cargo could interfere with your ability to move around to maintain your balance and control of the ATV.

In addition, exceeding the weight limits or carrying an unbalanced load can seriously affect your ATV's handling, braking and stability. Adding accessories or making modifications that change this ATV's design and performance can also make it unsafe. Also, the weight of any accessories will reduce the maximum load the ATV can carry.

More specific information on load limits, accessories, and modifications follows.

Loading

How much weight you put on your ATV, and how you load it, are important to your safety. You should be aware of the following information.

WARNING

Overloading, improper loading, or carrying a passenger can cause a crash and you can be seriously hurt or killed.

Follow all load limits and other loading guidelines in this manual.

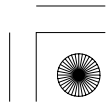



Load Limits & Guidelines

Load Limits

Following is the load limit for your ATV:

There is a limit to how much weight can be carried on your ATV.

The following load limit applies to standard equipment only. Modifying your ATV, using non-standard equipment, or riding on terrain that is not flat and smooth could further reduce this limit.

maximum weight capacity 187 lbs (85 kg)
(includes the weight of the rider, and all accessories.)

The weight of added accessories will reduce the maximum cargo weight you can carry.



Loading Guidelines

As discussed on page 38, we recommend that you do not carry any cargo on this ATV. However, if you decide to carry cargo, ride at reduced speeds and follow these common-sense guidelines.

- Check that the tires are properly inflated.
- Never ride with a passenger. The ATV is not designed to carry a passenger.
- Balance cargo weight evenly on both sides.
- Never exceed the maximum weight limit.





Accessories & Modifications

Modifying your ATV or using non-Honda accessories can make your ATV unsafe.

Before you consider making any modifications or adding an accessory, be sure to read the following information.

WARNING

Improper accessories or modifications can cause a crash in which you can be seriously hurt or killed.

Follow all instructions in this owner's manual regarding accessories and modifications.



Accessories



We strongly recommend that you use only Honda Genuine Accessories that have been specifically designed and tested for your ATV. Because Honda cannot test all other accessories, you must be personally responsible for proper selection, installation, and use of non-Honda accessories.

Check with your Honda dealer for assistance and always follow these guidelines:

- Make sure the accessory does not reduce ground clearance, limit suspension travel or steering travel, or interfere with operating any controls.
- Make sure the accessory does not interfere with your ability to shift body position on the seat or operate hand and foot controls.
- Do not add any electrical equipment that will exceed the vehicle's electrical system capacity (page 184). A blown fuse can cause a loss of engine power (page 171).

40 Before Riding

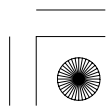
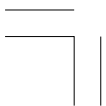



Accessories & Modifications

Modifications

We strongly advise you not to remove any original equipment or modify your ATV in any way that would change its design or operation. Such changes could seriously impair your ATV's handling, stability, and braking, making it unsafe to ride.

We also advise you not to make any modifications or remove any equipment (such as the USDA qualified spark arrester or emission control system components) that would make your ATV illegal in your area.

Removing or modifying your exhaust system, emission control system, or other equipment can also make your ATV illegal.





08/09/25 13:16:22 31HP2630 0051



42 Before Riding

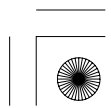
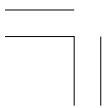



Basic Operation & Riding

This section gives basic riding instructions, including how to start and stop your engine, and how to use the throttle and brakes. It also provides important information on riding with cargo.

To protect your new engine and enjoy optimum performance and service life, refer to Break-in Guidelines (page 185).

For information about carburetor adjustment for riding at high altitude, see page 186.

Safe Riding Precautions	45
Speed Restrictors for New Riders	45
Off-road Use Only	49
Keep Hands and Feet on Controls.....	50
Control Speed.....	51
Use Care on Unfamiliar or Rough Terrain.....	52
Do Not Perform Stunts.....	54
Ride Only When Visibility Is Good.....	54
Starting & Stopping the Engine	55
Preparation	55
Starting Procedure.....	56
Flooded Engine	59
How to Stop the Engine	59
Shifting Gears	60

(cont'd)





Basic Operation & Riding

Braking.....	63
Riding Your ATV	66
Making Turns.....	66
Skidding or Sliding	68
Riding Up Hills	69
Riding Down Hills	73
Crossing or Turning on Hills or Slopes.....	74
Riding Over Obstacles	76
Riding Through Water	77
Parking	78





Safe Riding Precautions

Before riding your ATV for the first time, please review the *ATV Safety* section beginning on page 1, and the *Before Riding* section beginning on page 29.

Even if you have ridden other ATVs, take time to become familiar with how this ATV works and handles. Practice in a safe area until you build your skills and get accustomed to the ATV's size and weight.

Your ATV is not equipped with lights. Do not ride at night.

Speed Restrictors for New Riders

To limit top speed to about one half of normal in every gear, your ATV has an adjustable throttle limiter and air intake restrictor.

The screw and lock nut in the lower throttle housing can be adjusted to limit throttle lever movement. The air intake restrictor is used to restrict air flow to the engine, which reduces engine power.

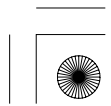
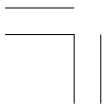



Safe Riding Precautions

Practice with the throttle limiter adjusted as delivered (approximately 15 mph (24 km/h) top speed) until you are confident in shifting gears, braking, and making turns.

Throttle Limiter Adjustment

1. Remove the screw (1) and stay (2).
2. Loosen the lock nut (3).
3. Turn the throttle limiter screw (4) clockwise to reduce throttle lever movement or counterclockwise to increase throttle lever movement.
Hold the throttle limiter screw in place and tighten the lock nut.
4. Reinstall the stay and screw.

RIGHT HANDLEBAR

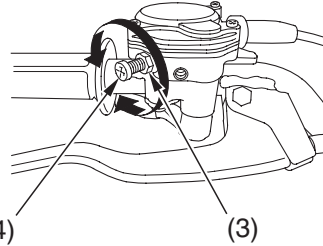
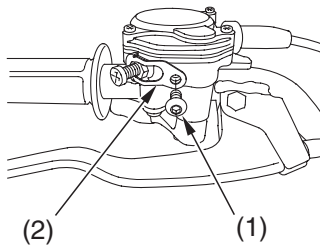

(1) screw
(2) stay

(3) lock nut
(4) throttle limiter screw

For higher top speed, removing the air intake restrictor is required. Adjusting for increased throttle lever movement without removing the air intake restrictor will cause the engine to run roughly at higher speeds.

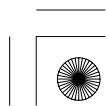
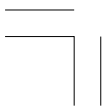



Safe Riding Precautions

Factory Setting

To restore the original setting (approximately 15 mph (24 km/h) top speed) follow the procedure below:

1. Reinstall the air intake restrictor.
2. Adjust the throttle lever freeplay to the specified range (1/8 – 5/16 in (3 – 8 mm)).
3. Remove the screw and stay.
4. Loosen the lock nut and turn it until it rests against the head of the throttle limiter screw.
5. Gently press the throttle lever to remove the freeplay in the cable.
6. While holding the throttle lever in this position, turn the throttle limiter screw clockwise until you feel it contact the throttle lever.
7. Release the throttle lever and turn the throttle limiter screw counterclockwise 3/4 turn.
8. Hold the throttle limiter screw in place and tighten the lock nut.
9. Reinstall the stay and tighten the screw.



Full Throttle Operation

1. Remove the air intake restrictor (page 48).
2. Loosen the lock nut and remove the throttle limiter screw.
3. Install the standard screw supplied with your ATV (in the owner's manual bag) to prevent moisture or debris (dirt, sand, pebbles, sticks, etc.) from entering the throttle housing.
Moisture and debris may interfere with proper throttle operation.

Store the throttle limiter screw and air intake restrictor in the owner's manual bag so you can install them whenever you want to reduce the top speed.





Safe Riding Precautions

Air Intake Restrictor Removal

1. Remove the seat (page 95).
 2. Unlatch the four retainer clips (5).
 3. Remove the air cleaner housing cover (6).
 4. Remove the air intake restrictor (7).
- Reinstall in the reverse order of removal.

UNDER SEAT

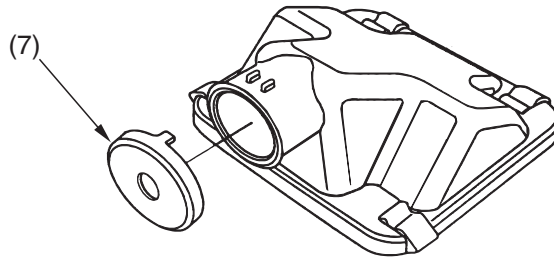
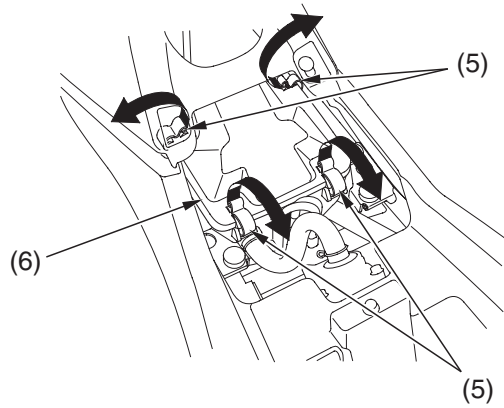

(5) retainer clips
(6) air cleaner housing cover

(7) air intake restrictor

48 Basic Operation & Riding

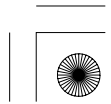
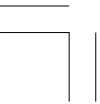



Safe Riding Precautions

Off-road Use Only

Your ATV and its tires are designed and manufactured for off-road use only, not for pavement. Riding on pavement can affect handling and control. You should not ride your ATV on pavement.

WARNING

Operating this ATV on paved surfaces may seriously affect handling and control of the ATV, and may cause the vehicle to go out of control.

Never operate the ATV on any paved surfaces, including sidewalks, driveways, parking lots and streets.



When riding off-road, also remember to always obey local off-road riding laws and regulations. Obtain permission to ride on private property. Avoid posted areas and obey “no trespassing” signs.

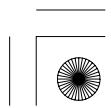
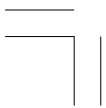



Safe Riding Precautions

You should never ride your ATV on public streets, roads or highways, even if they are not paved. Drivers of street vehicles may have difficulty seeing and avoiding you, which could lead to a collision. In many states it is illegal to operate ATVs on public streets, roads and highways.

WARNING

Operating this ATV on public streets, roads or highways could cause you to collide with another vehicle.

Never operate this ATV on any public street, road or highway, even a dirt or gravel one.



Keep Hands and Feet on Controls



Always keep both hands on the handlebars and both feet on the footpegs when riding your ATV. This is important to maintain your balance and to control the vehicle. Removing even one hand from the handlebars or one foot from the footpegs can reduce your ability to control the ATV or could cause you to lose your balance and fall off the ATV.

WARNING

Removing hands from handlebars or feet from footpegs during operation can reduce your ability to control the ATV or could cause you to lose your balance and fall off of the ATV.

Always keep both hands on the handlebars and both feet on the footpegs of your ATV during operation.

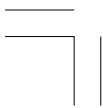



Safe Riding Precautions

Control Speed

Riding at excessive speed increases the chance of an accident. In choosing a proper speed, you need to consider the capability of your vehicle, the terrain, visibility and other operating conditions, plus your own skills and experience.

WARNING

Operating this ATV at excessive speeds increases your chances of losing control of the ATV, which can result in an accident.

Always go at a speed that is proper for your vehicle, the terrain, visibility and other operating conditions, and your experience.





Safe Riding Precautions

Use Care on Unfamiliar or Rough Terrain

Before riding in a new area, always check the terrain thoroughly. Don't ride fast on unfamiliar terrain or when visibility is limited. (It's sometimes difficult to see obstructions like hidden rocks, bumps, or holes in time to react.)

WARNING

Failure to use extra care when operating this ATV on unfamiliar terrain could result in the ATV overturning or going out of control.

Go slowly and be extra careful when operating on unfamiliar terrain. Always be alert to changing terrain conditions when operating the ATV.





Safe Riding Precautions

Never ride past the limit of visibility. Maintain a safe distance between your ATV and other off-road vehicles. Always exercise caution, and use extra care on rough, slippery and loose terrain.

WARNING

Failure to use extra care when operating on excessively rough, slippery or loose terrain could cause loss of traction or vehicle control, which could result in an accident, including an overturn.

Do not operate on excessively rough, slippery or loose terrain until you have learned and practiced the skills necessary to control the ATV on such terrain. Always be especially cautious on these kinds of terrain.





Safe Riding Precautions

Do Not Perform Stunts

You should always operate your ATV in a safe and reasonable manner. When riding, always keep all four wheels on the ground.

WARNING

Attempting wheelies, jumps, and other stunts increases the chance of an accident, including an overturn.

Never attempt stunts, such as wheelies or jumps. Don't try to show off.



Ride Only When Visibility Is Good

Your ATV is not equipped with lights. It is intended to be used only during the daytime. You should ride only when visibility is good. Plan to stop riding well before it gets dark. Operation at night without lights may be illegal in some states.





Starting & Stopping the Engine

Always follow the proper starting procedure described below.

For your safety, avoid starting or operating the engine in an enclosed area such as a garage. Your ATV's exhaust contains poisonous carbon monoxide gas which can collect rapidly in an enclosed area and cause illness or death.

Preparation

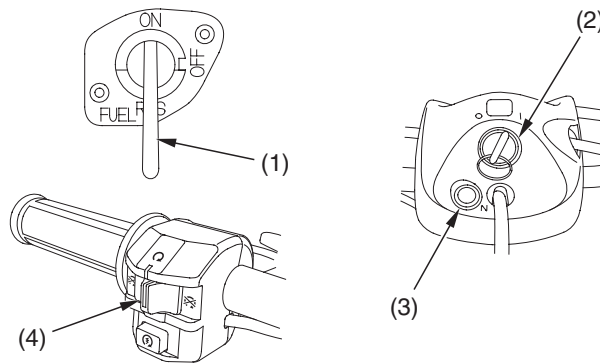

(1) fuel valve
(2) ignition switch

(3) neutral indicator
(4) engine stop switch

1. Before starting, select a level surface and lock the parking brake (page 26).
2. Turn the fuel valve (1) and ignition switch (2) to ON (I).

Confirm the following:

- The transmission is in neutral, and the neutral indicator (3) is ON.
- The engine stop switch (4) is set to RUN (O).



Starting & Stopping the Engine

Starting Procedure

To restart a warm engine, follow the procedure for “*High Air Temperature.*”

The starter motor will operate only when the transmission is in neutral.

Normal Air Temperature 10°–35°C (50°–95°F)

1. Pull the choke lever (1) up all the way to fully ON (A) if the engine is cold.
2. With the throttle 1/8–1/4 open, press the start button (2).
(If the throttle limiter is adjusted as delivered, open the throttle fully.)

LEFT SIDE

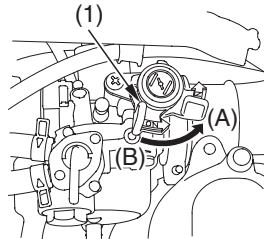

- (1) choke lever
- (A) fully ON
- (B) fully OFF

LEFT HANDLEBAR

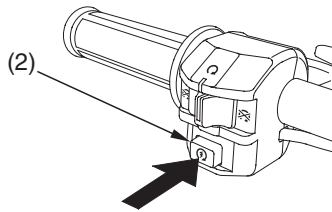

- (2) start button

- Pressing the electric start button for more than 5 seconds at a time may cause the starter to overheat and damage the starter. Release the start button for approximately 10 seconds before pressing it again.

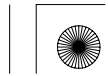



Starting & Stopping the Engine

3. Warm up the engine by opening and closing the throttle slightly.
4. After the engine has warmed up, push the choke lever down all the way to fully OFF (B).
5. If idling is unstable, open the throttle slightly.





Starting & Stopping the Engine

High Air Temperature 35°C (95°F) or above

1. Do not use the choke.
2. With the throttle closed, start the engine.

Low Air Temperature 10°C (50°F) or below

1. Pull the choke lever (1) up all the way to fully ON (A) if the engine is cold.
2. With the throttle 1/8 – 1/4 open, start the engine.
3. Warm up the engine by opening and closing the throttle slightly.
4. Continue warming up the engine until it runs smoothly and responds to the throttle, when the choke lever down all the way to fully OFF.
5. If idling is unstable, open the throttle slightly.

NOTICE

Extended use of the choke may impair piston and cylinder wall lubrication and shorten the life of the engine.

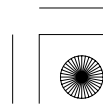



Starting & Stopping the Engine

Flooded Engine

If the engine fails to start after repeated attempts, it may be flooded with excess fuel. To clear a flooded engine:

1. Leave the engine stop switch set to RUN ().
2. Push the choke lever down all the way to fully OFF.
3. Open the throttle fully.
4. Press the start button for 5 seconds.
5. If the engine starts, quickly close the throttle, then, if idling is unstable, open it slightly.
If the engine does not start, wait 10 seconds, then follow the *High Air Temperature* procedure (page 58).



If the engine still won't start, refer to *If Your Engine Quits or Won't Start*, page 164 .

How to Stop the Engine

Normal Engine Stop

To stop the engine, make sure the transmission is in neutral by checking that the neutral indicator light is on, then turn the ignition switch OFF ().

The engine stop switch should normally remain in the RUN () position even when the engine is OFF.

If your ATV is stopped with the engine stop switch OFF () and the ignition switch ON (), the battery will discharge.

Emergency Engine Stop

To stop the engine in an emergency, use the engine stop switch. To operate, slide the switch to the OFF () position.





Shifting Gears

UPSHIFTING SEQUENCE

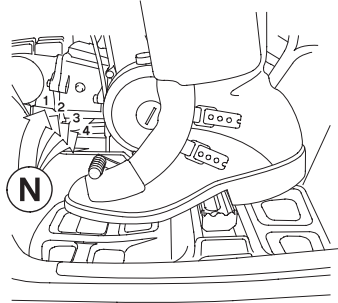

DOWNSHIFTING SEQUENCE

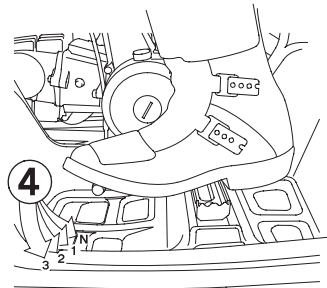

Your ATV has four forward gears: 1, 2, 3, and 4.

The shift lever is located near the left footpeg. One full stroke of the shift lever shifts the transmission to the next higher or lower gear in the shifting sequence. The shift lever automatically returns to the horizontal position when released.

To upshift to a higher gear, put the toe of your boot under the shift lever and raise it one full stroke. To downshift, step on the shift lever and depress it one full stroke.

60 Basic Operation & Riding

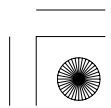



Shifting Gears

With the engine stop switch at RUN and the transmission in neutral, the engine can be started.

1. With the transmission in neutral, release the parking brake, but continue squeezing the rear brake lever.
2. With the throttle closed, raise the shift lever one full stroke to shift into 1st (first) gear.
3. Release the rear brake lever and increase engine speed by gradually opening the throttle.
4. When speed increases, release the throttle and shift to 2nd gear by raising the shift lever one full stroke.
5. Repeat this sequence to progressively upshift to 3rd and 4th (top) gear.
6. To downshift, reverse this sequence. Remember to close the throttle each time you shift to the next lower gear.

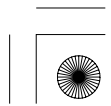



Shifting Gears

Learning when to shift gears comes with experience. Keep the following tips in mind:

- As a general rule, shift while moving in a straight line.
- Close the throttle completely before shifting. Improper shifting may damage the engine, transmission, and drivetrain.
- Upshift to a higher gear or reduce throttle before engine rpm (speed) gets too high. Learn the relationship between engine sound and the normal shifting points.
- Downshift to a lower gear before you feel the engine laboring (lugging) at low rpm.
- Avoid downshifting to help slow your ATV when engine rpm is high. Downshifting when engine speed is near its allowable maximum may over-rev the engine and possibly cause damage.
- To prevent transmission damage, do not coast or tow the ATV for long distances with the engine off.



Recommended Shift Points

Ride in the highest gear that lets the engine run and accelerate smoothly. This will give you good fuel economy and effective emissions control.





Braking

Your ATV is equipped with drum brakes on both front wheels which are mechanically activated by operating the right brake lever. A single drum brake on the rear axle housing is mechanically activated by depressing the brake pedal or operating the left brake lever.

As a general rule, the front braking system provides about 70 percent of total stopping power.

For full braking effectiveness, use both the pedal and lever simultaneously. Using both braking systems will stop your ATV faster with greater stability.

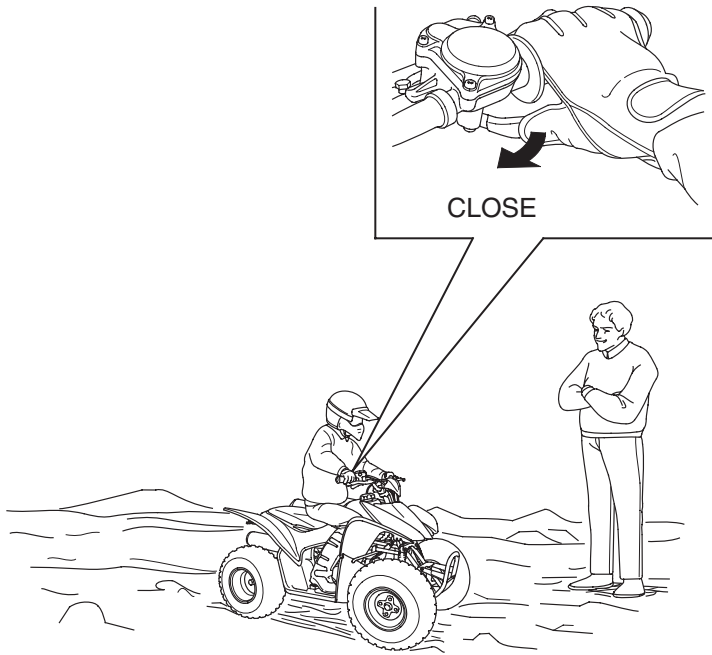



Braking

To slow or stop, apply the brake lever and brake pedal smoothly, while downshifting to match your speed.

Gradually increase braking as you feel the brakes slowing your speed. The increase in engine compression from downshifting will help slow your ATV.

DEPRESS

PULL

PULL

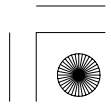
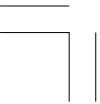
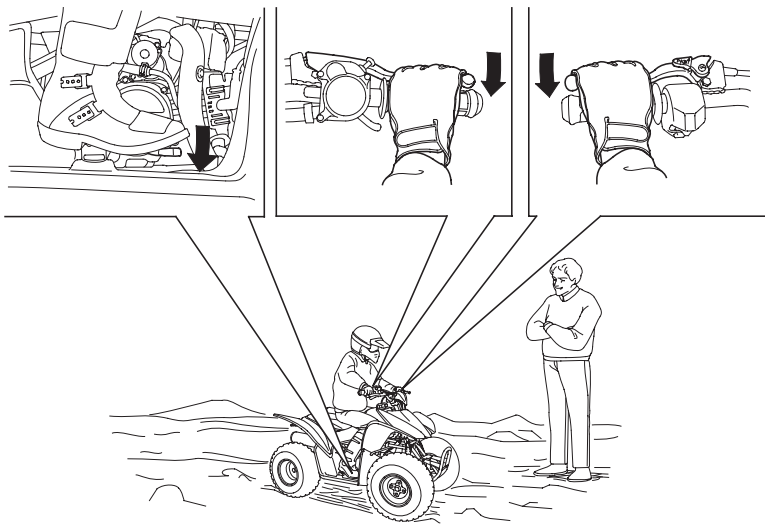



Braking

Applying the brakes too hard may cause the wheels to lock and slide, reducing control of your ATV. If this happens, release the brake controls, steer straight ahead until you regain control, then reapply the brakes more gently.

When possible, reduce your speed or complete braking before entering a turn. Avoid braking or closing the throttle quickly while turning. Either action may cause one or more wheels to slip and reduce your control of your ATV.

Your ability to brake in a turn and to brake hard in an emergency situation are important riding skills.

When descending a long, steep grade, use engine compression braking by downshifting, with intermittent use of both brakes. Continuous brake application can overheat the brakes and reduce their effectiveness.

Riding with your foot resting on the brake pedal or your hands on the brake levers may overheat the brakes, reducing effectiveness.

For information on how to apply the brakes in various riding situations, see the following section, *Riding Your ATV*.



Riding Your ATV

Making Turns

Learn how to turn your ATV properly. Practice the techniques outlined in this section on level ground and at low speeds until you are confident in making turns.

WARNING

Turning improperly can make the ATV go out of control, causing a collision or overturn.

- Always follow proper procedures for turning as described in this owner's manual.
- Practice turning at low speeds before attempting to turn at faster speeds.
- Do not turn at excessive speeds.





Riding Your ATV

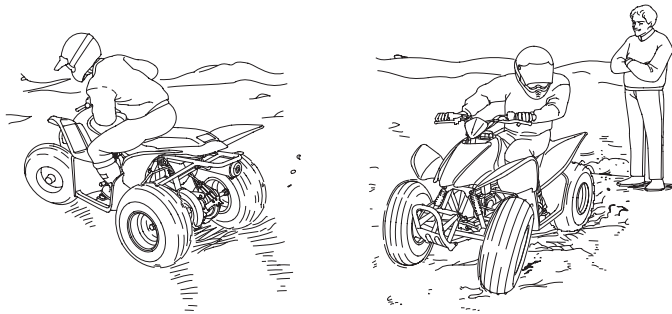

Lean your body to the inside of a turn and forward.

To make a turn on level ground: Steer the handlebar and lean your body toward the inside of the turn. Leaning helps balance the vehicle, and it feels more comfortable. Leaning into a turn is an important technique to master in riding an ATV.

To make a sharp turn at low speed: It helps to shift your body slightly forward on the seat, and lean inside, as you steer the handlebar. Shifting weight forward allows the rear wheels to turn easier, and it also improves front-wheel steering.

To make a turn from a full stop: Apply the throttle gradually when you turn and start up at the same time. Remember to shift your body forward to make sharp low-speed turns and whenever you turn while accelerating from a full stop.





Riding Your ATV

Skidding or Sliding

The terrain surface can be a major factor affecting turns. Skidding during a turn is more likely to occur on slippery surfaces, such as snow, ice, mud and loose gravel. If you skid on ice, you may lose all directional control. To avoid skidding on slippery terrain, keep your speed low and ride with caution.

WARNING

Skidding or sliding improperly may cause you to lose control of this ATV. You may also regain traction unexpectedly, which may cause the ATV to overturn.

Learn to safely control skidding by practicing at low speeds and on level, smooth terrain.



If your ATV skids sideways during a turn, steer in the direction of the skid. Avoid hard braking or accelerating until you have regained directional control.

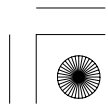
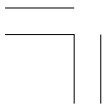

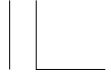

Riding Your ATV

Riding Up Hills

The ATV's ability to safely climb hills largely depends on the rider's skill and judgment. Begin by practicing on smooth, gentle slopes. As you gain experience, you'll learn the hazards and your own limitations. You may then proceed to ride on more difficult terrain. However, you must be able to decide which hills or hazards might cause the ATV to overturn. Avoid excessively steep hills.

WARNING

Operating on excessively steep hills can cause the vehicle to overturn more easily than operating on level surfaces or small hills.

Never operate the ATV on hills too steep for the ATV or for your abilities.



When climbing hills, you must shift weight toward the front wheels to help keep them on the ground. To do this, shift your body slightly forward on the seat and lean forward. For greater weight shift, move your body farther forward and lean forward.

WARNING

Climbing hills improperly could cause loss of control or cause the ATV to overturn.

Always follow proper procedures for climbing hills as described in this owner's manual.

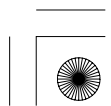
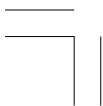



Riding Your ATV

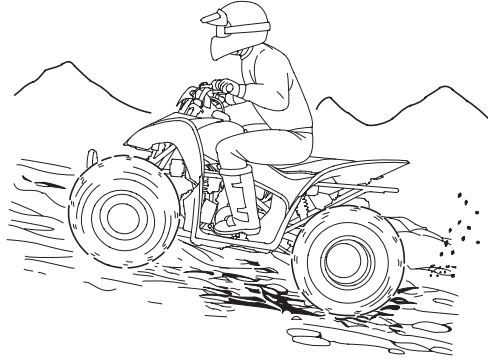

Shift weight forward when climbing hills.



- Always check the terrain carefully before you start up any hill.
- Never climb hills with excessively slippery or loose surfaces.
- To climb a hill, take a running start in an appropriate gear and speed for the conditions. Maintain a steady speed as you ascend the hill.
- Never open the throttle suddenly or make sudden gear changes. The ATV could flip over backward.
- Never go over the top of any hill at high speed. An obstacle, a sharp drop, or another vehicle or person could be on the other side of the hill.

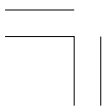



Riding Your ATV

Stalling the ATV and/or Rolling Backwards:

If you incorrectly estimate climbing capability or terrain conditions, the ATV may not have enough power or traction to continue uphill. If this happens, the ATV can stall and/or roll backwards.

⚠ WARNING

Stalling, rolling backwards or improperly dismounting while climbing a hill could result in the ATV overturning.

Always follow proper procedures for climbing a hill as described in this owner's manual.

What to do if the ATV stalls or rolls backwards when climbing a hill:

If you are about to lose all forward speed:

1. Using the front and rear brakes together, bring the ATV to a stop with the vehicle pointed straight uphill.
2. Get off the ATV while you continue holding the brakes.
3. Shift into neutral, set the parking brake and turn the engine off.
4. Then assess the situation.

If the ATV starts rolling backwards before you begin braking:

1. Keep your weight uphill.
2. Carefully apply the front brakes first, then carefully apply the rear brake. Do not apply either brake abruptly if you are rolling backwards, or the vehicle may overturn.

If the ATV continues sliding backwards:

After you've applied the brakes, get off and away from the vehicle.



Riding Your ATV

What to do after the ATV has stalled or rolled backwards:

If the hill is too steep or too slippery, or if you have any doubt whether you can safely walk the ATV back down the hill, leave the vehicle where it is and get help. If possible, block the wheels so the vehicle doesn't roll backwards.

If the hill is not too steep and you have good footing, you may be able to walk the ATV back down the hill. Make sure your intended path is clear in case you lose control of the ATV.

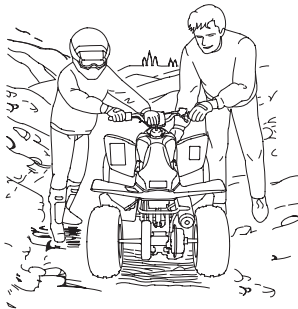

Be sure your legs are clear of the wheels.

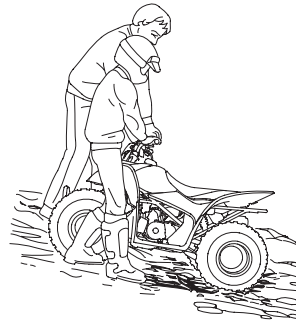

Body position for backing down a hill.

1. Stand with your body facing downhill, beside the vehicle so you can reach the rear brake lever with your right hand.
2. Be sure your legs are clear of the wheels.
Check your footing.
3. Slowly and carefully back the ATV down the hill using the rear brake lever to control speed.
4. If you lose control of the ATV, for your safety, get away from the vehicle.





Riding Your ATV

Riding Down Hills

It's usually advisable to descend hills with the ATV pointed straight downhill. Avoid angles that would cause the vehicle to lean sharply to one side.

⚠ WARNING

Going down a hill improperly could cause loss of control or cause the ATV to overturn.

Always follow proper procedures for going down hills as described in this owner's manual.

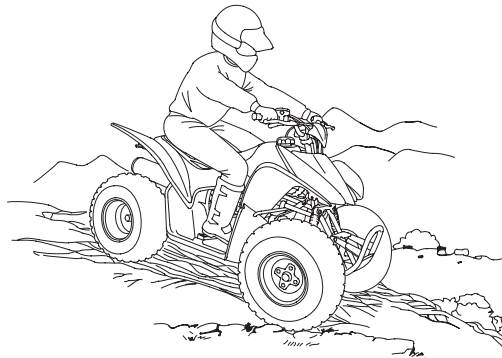

On downhills, shift your weight back.

As you approach a downhill, stop and survey the terrain below. Never ride past the limit of your visibility. Never go down a hill at high speed.

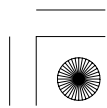



Riding Your ATV

When you've selected a safe downhill path, shift into a lower gear, shift your weight back with your arms extended and braced against the handlebar, then go down slowly with the throttle closed.

Use mainly the rear brake to control speed. Avoid using either the front brake or rear brake hard or abruptly when riding down hills.

Remember, braking effectiveness is reduced on any hill with a loose surface.

Crossing or Turning on Hills or Slopes

Riding on hills or slopes is different from riding on level terrain. Be careful when riding on any hill. Make sure that you practice on gentle, smooth slopes before attempting to ride on steeper or more difficult terrain.



WARNING

Improperly crossing hills or turning on hills could cause loss of control or cause the ATV to overturn.

Always follow proper procedures for crossing or turning on slopes as described in this owner's manual. Avoid crossing steep hills if possible.

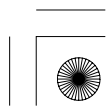

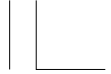

Riding Your ATV

Crossing Hills or Slopes

- To maintain balance and stability when riding across a slope, you need to shift weight toward the uphill side of the vehicle. To do this, move your body off the center of the seat and lean toward the uphill side.
- On a slippery or loose surface, you may also need to steer slightly uphill to maintain a straight course across the slope.
- Avoid crossing hills that are excessively steep, slippery or rough.

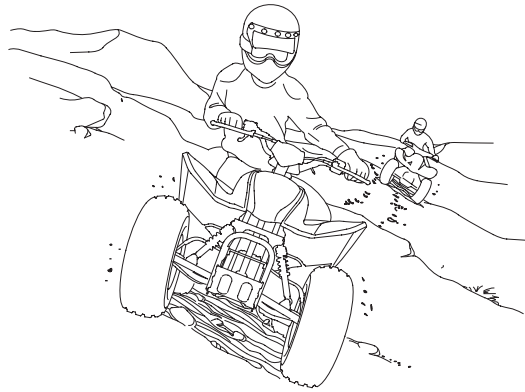

Shift weight uphill when crossing slopes.

Making Turns on Slopes

- Compared to riding on level ground, you may need to shift more weight and lean more when making turns on slopes.
- Do not make turns on any slopes until you have first mastered the techniques for making turns on level terrain.

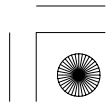
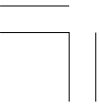



Riding Your ATV

Riding Over Obstacles

Before operating in a new area, check for obstacles. Watch out for bumps, rain ruts, potholes and other obstacles in the terrain. When you approach any obstacle, reduce your speed and be prepared to stop. Never try to ride over large obstacles, such as large rocks or fallen logs.

WARNING

Improperly operating over obstacles could cause loss of control or a collision and could cause the ATV to overturn.

When you go over obstacles, always follow proper procedures as described in this owner's manual.

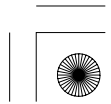
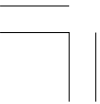



Riding Your ATV

Riding Through Water

Your ATV is designed to travel through water up to approximately 8 inches (200 mm) deep. Before crossing a stream, make sure the water is not too deep or flowing too fast.

WARNING

The ATV tires have some ability to float. Operating this ATV through deep or fast-flowing water may cause a loss of traction and loss of control, which could lead to an accident.

Never operate this ATV in fast-flowing water or in water deeper than that specified in this owner's manual.

1. Choose a path where both banks have gradual slopes.
2. Proceed through the water at a slow, steady speed.
3. Watch out for submerged obstacles and slippery rocks.
4. Avoid getting the spark plug or air cleaner wet, as this would cause the engine to stop.
5. After leaving the water, always test both the front and rear brakes.
 - Riding through water can make the brakes less effective than normal, and may reduce stopping ability.
 - If necessary, apply the brakes repeatedly until they dry out and operate normally.
 - If the brakes don't regain effectiveness, stop your ATV and follow the procedures on page 125 .



Parking

1. Look for level parking area. Make sure the ground surface is firm.
2. After bringing your ATV to a stop, hold the brakes while you shift into neutral.
3. Set the parking brake.
4. Turn the ignition switch OFF (O).
5. If you're finished riding for the day, turn the fuel valve OFF.

If it is necessary to start the engine when your ATV is in gear and is stopped on a grade, rock the vehicle back and forth to allow shifting the transmission into neutral.

Parking on a Steep Incline or a Loose or Slippery Surface

If you must park your ATV on a steep incline or loose or slippery surface, use the following procedure:

1. While holding the brakes, set the parking brake.
2. Turn the ignition switch OFF (O) and release the brakes.
3. If the ATV begins to move, either while sitting on it or after you dismount, find a better parking location.
4. If rocks or other objects are available, you can block the wheels as shown for additional security.

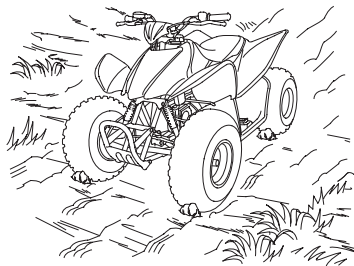
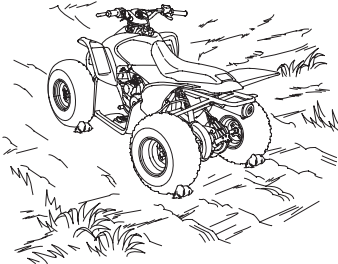



Servicing Your Honda

To help keep your ATV in good shape, this section includes a Maintenance Schedule for required service and step-by-step instructions for specific maintenance tasks. You'll also find important safety precautions, information on fuels and oils, and tips for keeping your Honda looking good.

For information about replacing fuses, see page 171 .

For information about the exhaust emission and noise requirements of the U.S. Environmental Protection Agency (EPA), the California Air Resources Board (CARB), and Environment Canada (EC), see page 187 .

USA Only

Maintenance, replacement or repair of the emission control devices and systems may be performed by any ATV repair establishment or individual using parts that are "certified" to EPA standards.



Before You Service Your Honda

The Importance of Maintenance	81
Maintenance Safety	83
Important Safety Precautions	84
Maintenance Schedule	85
Maintenance Record.....	89

Service Preparations

Maintenance Component Locations	90
Tool Kit.....	93
Owner's Manual Storage.....	94
Seat Removal	95

(cont'd)

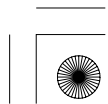
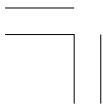



Servicing Your Honda

Service Procedures

Fluids & Filters

Fuel	96
Engine Oil	99
Air Cleaner.....	105

Engine

Throttle.....	109
Clutch System	111
Engine Idle Speed	112
Spark Plug	113
Valves.....	116
Spark Arrester	117

Chassis

Brakes.....	118
Tires	126
Skid Plates.....	133
Drive Chain.....	134

Electrical

Battery.....	142
--------------	-----

Appearance Care	147
-----------------------	-----

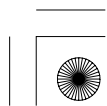
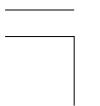



The Importance of Maintenance

A well-maintained ATV is essential for safe, economical, and trouble-free riding. It will also help reduce air pollution. Careful pre-ride inspections and good maintenance are especially important because your ATV is designed to be ridden over rough off-road terrain.

To help you properly care for your ATV, this section of the manual provides a Maintenance Schedule. The service intervals in this schedule are based on average riding conditions.

More frequent service is needed if you subject your ATV to severe use or ride in unusually wet or dusty areas.

WARNING

Improperly maintaining this ATV or failing to correct a problem before you ride can cause a crash in which you can be seriously hurt or killed.

Always follow the inspection and maintenance recommendations and schedules in this owner's manual.

Frequent servicing of the air cleaner is especially important to help you avoid a possible costly engine repair.

If your ATV overturns or is involved in a crash, be sure your Honda dealer inspects all major parts, even if you are able to make some repairs.

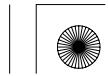



The Importance of Maintenance

Note to Parents:

As a parent, it's up to you to make sure that this ATV is properly maintained and kept in safe operating condition. For youngsters, learning how to take care of an ATV and perform basic maintenance can be an important part of their riding experience. However, if you allow a youngster to perform or assist in any maintenance task, such as filling the tank with gasoline, you should provide close supervision to make sure that it is performed safely.

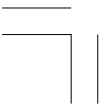



Maintenance Safety

This section includes instructions on how to perform some important maintenance tasks. If you have basic mechanical skills, you can perform many of these tasks with the tools provided with your ATV.

Other tasks that are more difficult and require special tools are best performed by professionals. Removing the wheels should normally be handled only by a Honda technician or other qualified mechanic. Instructions are included in this manual only to assist in emergency service.

Some of the most important safety precautions follow. However, we cannot warn you of every conceivable hazard that can arise in performing maintenance. Only you can decide whether or not you should perform a given task.

WARNING

Failure to properly follow maintenance instructions and precautions can cause you to be seriously hurt or killed.

Always follow the procedures and precautions in this owner's manual.

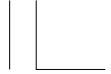

Maintenance Safety

Important Safety Precautions

- Make sure the engine is off before you begin any maintenance or repairs. This will help eliminate several potential hazards:
 - Carbon monoxide poisoning from engine exhaust.** Be sure there is adequate ventilation whenever you operate the engine.
 - Burns from hot ATV parts.** Let the engine and exhaust system cool before touching.
 - Injury from moving parts.** Do not run the engine unless instructed to do so.
- Read the instructions before you begin, and make sure you have the tools and skills required.
- To reduce the possibility of a fire or explosion, be careful when working around gasoline. Use only non-flammable solvent, not gasoline, to clean parts. Keep cigarettes, sparks, and flames away from all fuel-related parts.



Remember that your Honda dealer knows your ATV best and is fully equipped to maintain and repair it. To ensure the best quality and reliability, use only new Honda Genuine Parts or other equivalents for repair and replacement. If you have the tools and skills required for additional maintenance jobs, you can purchase an official Honda Service Manual (page 194).

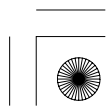
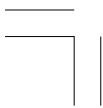



Maintenance Schedule

The required Maintenance Schedule that follows specifies how often you should have your ATV serviced, and what things need attention. It is essential to have your ATV serviced as scheduled to maintain safe, dependable performance and proper emission control.

The service intervals in this Maintenance Schedule are based on average riding conditions. Some items will need more frequent service if you ride in unusually wet or dusty areas or at full throttle. Consult your Honda dealer for recommendations applicable to your individual needs and use.

Some items in the Maintenance Schedule can be performed with basic mechanical skills and hand tools. Procedures for these items are provided in this manual. Other items involve more extensive procedures and may require special training, tools, and equipment. We recommend that you have your Honda dealer perform these tasks unless you have advanced mechanical skills and the required tools and equipment. Procedures for such items in this schedule are provided in an official Honda Service Manual available for purchase (page 194).

If you do not feel capable of performing a given task or need assistance, remember that your Honda dealer knows your ATV best and is fully equipped to maintain and repair it. If you decide to do your own maintenance, use only Honda Genuine Parts or their equivalents for repair or replacement to ensure the best quality and reliability.



Maintenance Schedule

Perform the pre-ride inspection (page 36) at each scheduled maintenance period.

Each item on the maintenance schedule requires some mechanical knowledge. Certain items (particularly those marked * and **) may require more technical information and tools. Consult your Honda dealer.

- * Should be serviced by your Honda dealer, unless the owner has proper tools and service data and is mechanically qualified. Refer to the official Honda Service Manual (page 194).
- ** In the interest of safety, we recommend these items be serviced only by your Honda dealer.

Summary of Maintenance Schedule Notes & Procedures:



NOTES:

1. Service more frequently when riding in dusty areas, sand or snow.
2. Service more frequently after riding in very wet or muddy conditions.





Maintenance Schedule

Maintenance Procedures:

I: inspect and clean, adjust, lubricate, or replace, if necessary

C: clean

A: adjust

L: lubricate

R: replace

ITEMS	FREQUENCY	WHICHEVER COMES FIRST ⇒ NOTE	INITIAL MAINT. INTERVAL			Refer to page
			mi	600	1200	
			km	1000	2000	
			HOURS	20	200	
* FUEL LINE				I	—	
* THROTTLE OPERATION				I	109	
AIR CLEANER	NOTE 1			C	C	105
SPARK PLUG				I	I	113
* VALVE CLEARANCE			I	I	I	116
ENGINE OIL			INITIAL=100 mi (150 km), 20 operating hours or 1 month: R REGULAR=Every 600 mi (1000 km), 100 operating hours or 12 months: R			99
** ENGINE OIL STRAINER SCREEN					C	—
** ENGINE OIL CENTRIFUGAL FILTER					C	—
* ENGINE IDLE SPEED			I	I	I	112
* SECONDARY AIR SUPPLY SYSTEM					I	—

* Should be serviced by your Honda dealer, unless the owner has proper tools and service data and is mechanically qualified. Refer to the official Honda Service Manual (page 194).

** In the interest of safety, we recommend these items be serviced only by your Honda dealer.





Maintenance Schedule

ITEMS	FREQUENCY	WHICHEVER COMES FIRST ⇒ NOTE	INITIAL MAINT.		REGULAR MAINT. INTERVAL		Refer to page
			mi	100	600	1200	
			km	150	1000	2000	
		HOURS	20	100	200		
DRIVE CHAIN		NOTE 1, NOTE 2	I, L	I, L; EVERY 300 mi (500 km) or 50 operating hours			134
DRIVE CHAIN SLIDER				I	I		136
* BRAKE SHOE WEAR		NOTE 1			I		124
BRAKE SYSTEM			I	I	I		118
SKID PLATES				I	I		133
* CLUTCH SYSTEM			I	I	I		111
* SUSPENSION				I	I		—
* SPARK ARRESTER				C	C		117
* NUTS, BOLTS, FASTENERS			I		I		—
** WHEELS/TIRES			I	I	I		—
** TIE-ROD AND JOINT BOOTS			I	I	I		—
** STEERING SHAFT HOLDER BEARINGS					I		—
** STEERING SYSTEM					I		—

- * Should be serviced by your Honda dealer, unless the owner has proper tools and service data and is mechanically qualified. Refer to the official Honda Service Manual (page 194).
- ** In the interest of safety, we recommend these items be serviced only by your Honda dealer.





Maintenance Record

Keeping an accurate maintenance record will help ensure that your ATV is properly maintained. Retain detailed receipts to verify the maintenance was performed. If the ATV is sold, these receipts should be transferred with the ATV to the new owner. Make sure whoever performs the maintenance completes this record. All scheduled maintenance, including the 100 mile (150 km) or 20 hours initial maintenance, is considered a normal owner operating cost and will be charged for by your dealer. Use the space under Notes to record anything you want to remind yourself about or mention to your dealer.

Miles (km) or hours	Date	Performed By:	Notes
100 (150) or 20			
600 (1,000) or 100			
1,200 (2,000) or 200			
1,800 (3,000) or 300			
2,400 (4,000) or 400			
3,000 (5,000) or 500			
3,600 (6,000) or 600			
4,200 (7,000) or 700			
4,800 (8,000) or 800			



Maintenance Component Locations

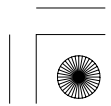
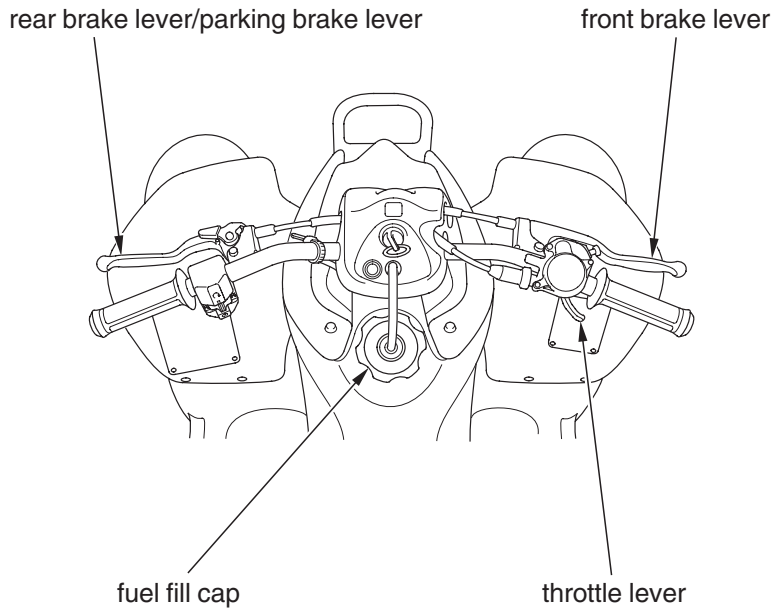



Maintenance Component Locations

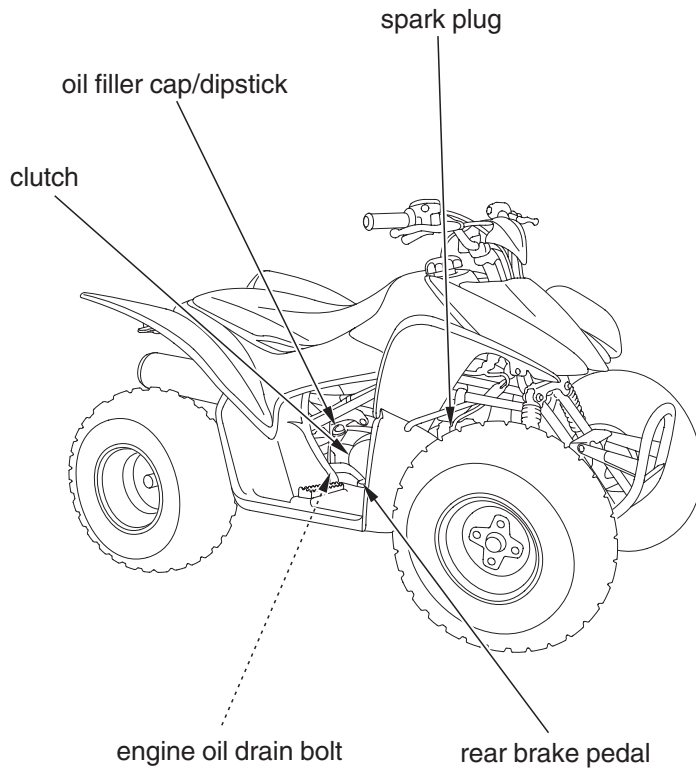



Maintenance Component Locations

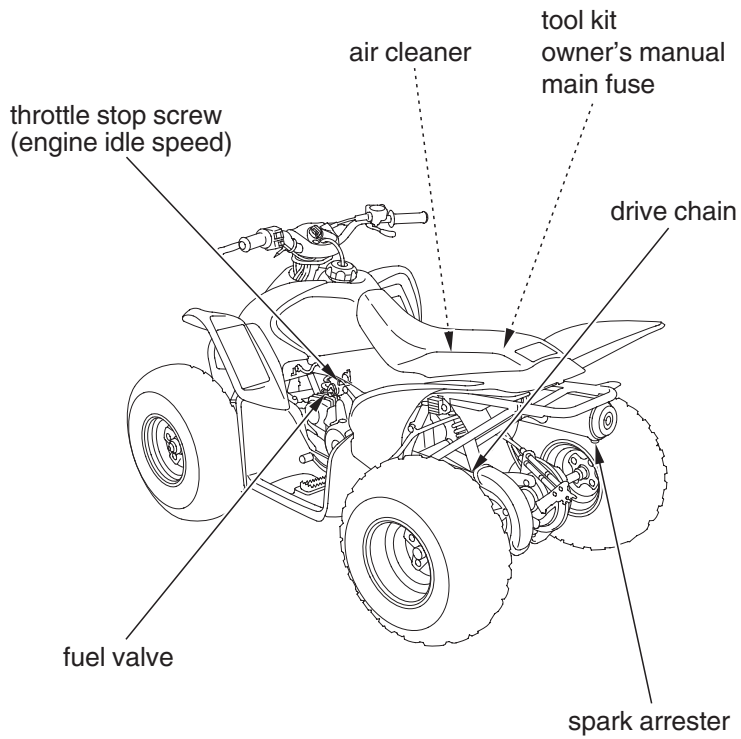



Tool Kit

The tool kit (1) is stored under the seat (page 95).
After using the tools, be sure to use the rubber band (2) to fasten the tool kit securely.

The tools in the kit are sufficient to perform routine maintenance and simple repairs. Any extensive work requiring additional tools should be performed by your Honda dealer.

The tool kit includes the following items:

- * spark plug wrench and handlebar
- * air pressure gauge
- * tool bag

UNDER THE SEAT

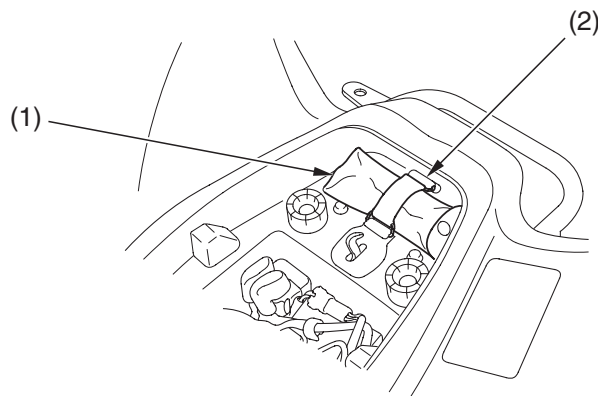

(1) tool kit

(2) rubber band



Owner's Manual Storage

Your ATV provides storage for the owner's manual so you'll have it with you for easy reference. Store your owner's manual (1) in the plastic document bag underside of the seat (2).

The owner's manual, spare fuse (3) and screw (4) should be stored in the plastic document bag (5) and fastened with the rubber band (6).

Be careful not to flood this area when washing your ATV.

SEAT UNDERSIDE

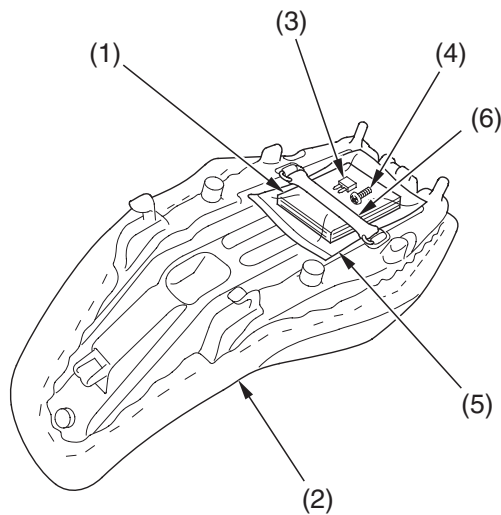

- (1) owner's manual
- (2) seat
- (3) spare fuse

- (4) screw
- (5) plastic document bag
- (6) rubber band





Seat Removal

Refer to *Safety Precautions* on page 84 .

The seat must be removed for air cleaner, battery and fuse maintenance.

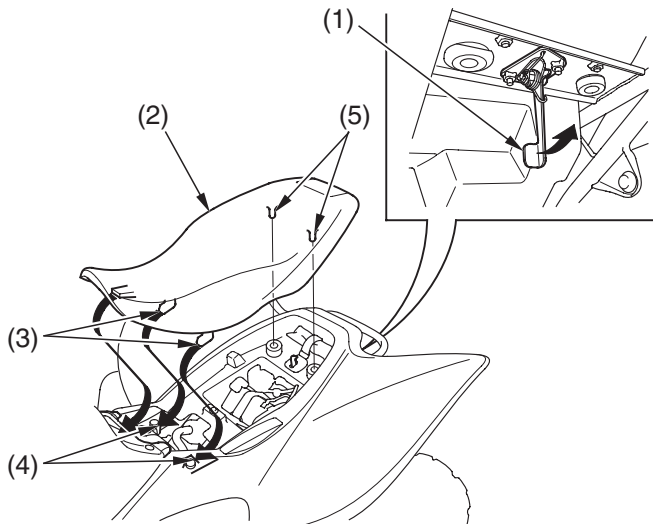

- | | |
|---------------------|-----------|
| (1) seat lock lever | (4) hooks |
| (2) seat | (5) studs |
| (3) front prongs | |

Removal

1. Pull the seat lock lever (1) up behind the seat.
2. Slide the seat (2) back and lift it.

Installation

1. Insert the front prongs (3) into the hooks (4) on the frame and press the studs (5) into the grommets on the storage compartment.
2. Press down on the seat until it locks.





Fuel

Refer to *Safety Precautions* on page 84.

Fuel Recommendation

type	unleaded
pump octane number	86 (or higher)

We recommend that you use unleaded fuel because it produces fewer engine deposits and extends the life of exhaust system components.

Your engine is designed to use any gasoline that has a pump octane number of 86 or higher. Gasoline pumps at service stations normally display the pump octane number. For information on the use of oxygenated fuels, see page 191.

Use of lower octane gasoline can cause persistent “pinging” or “spark knock” (a loud rapping noise) which, if severe, can lead to engine damage. Light pinging experienced while operating under a heavy load, such as climbing a hill, is no cause for concern.

If pinging or spark knock occurs at a steady engine speed under normal load, change brands of gasoline. If pinging or spark knock persists, consult your Honda dealer.

Never use stale or contaminated gasoline or an oil/gasoline mixture. Avoid getting dirt, dust, or water in the fuel tank.



Fuel

Fuel Capacity

Fuel tank capacity, including reserve:

1.66 US gal (6.3 ℓ)

Reserve capacity:

0.26 US gal (1.0 ℓ)

The tank should be refilled as soon as possible after switching to reserve, and the fuel valve should be returned to the ON position after refueling to avoid running out of fuel with no reserve.

Refueling Procedure

Refer to *Safety Precautions* on page 84.

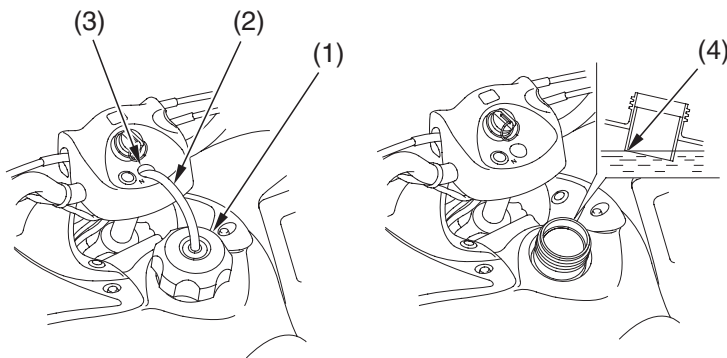

(1) fuel fill cap
(2) breather tube

(3) handlebar cover hole
(4) filler neck

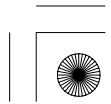
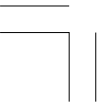



Fuel

1. To open the fuel fill cap (1), turn it counterclockwise.
2. Pull the breather tube (2) out of the handlebar cover hole (3).
3. Add fuel until the level reaches the bottom of the filler neck (4).
Avoid over filling the tank. There should be no fuel in the filler neck.

WARNING

Gasoline is highly flammable and explosive. You can be burned or seriously injured when handling fuel.

- Stop the engine and keep heat, sparks and flame away.
- Handle fuel only outdoors.
- Wipe up spills immediately.



4. After refueling, turn the fuel fill cap clockwise until it clicks.
5. Insert the breather tube into the handlebar cover hole.
6. If the fuel valve was set to RES, turn the fuel valve ON.



If you replace the fuel fill cap, use only a Honda Genuine replacement part.

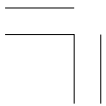



Engine Oil

Engine oil quality is a major factor that affects both the performance and the service life of the engine.

Using the proper oil (page 100) and filter, and regularly checking, adding, and changing oil will help extend your engine's life. Even the best oil wears out. Changing oil helps get rid of dirt and deposits in the engine. Operating the engine with old or dirty oil can damage your engine. Running the engine with insufficient oil can cause serious damage to the engine and transmission.

Change the engine oil as specified in the maintenance schedule on page 87. When running in very dusty conditions, oil changes should be performed more frequently than specified in the maintenance schedule.

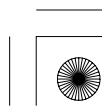
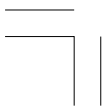



Engine Oil

Oil Recommendation

API classification	SG or higher except oils labeled as energy conserving on the circular API service label
viscosity (weight)	SAE 10W-30
JASO T 903 standard	MA
suggested oil*	Pro Honda GN4 4-stroke oil (USA & Canada), or Honda 4-stroke oil (Canada only), or an equivalent motorcycle oil.

* Suggested oils are equal in performance to SJ oils that are not labeled as energy conserving on the circular API service label.

- Your ATV does not need oil additives. Use the recommended oil.
- Do not use oils with graphite or molybdenum additives. They may adversely affect clutch operation.
- Do not use API SH or higher oils displaying a circular API “energy conserving” service label on the container. They may affect lubrication and clutch performance.



NOT RECOMMENDED



OK

- Do not use non-detergent, vegetable, or castor based racing oils.

100 Servicing Your Honda





Engine Oil

Other viscosities shown in the following chart may be used when the average temperature in your riding area is within the indicated range.

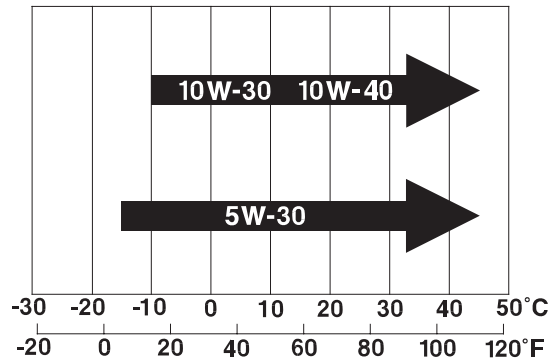

JASO T 903 standard

The JASO T 903 standard is an index for engine oils for 4-stroke motorcycle engines.

There are two classes: MA and MB.

Oil conforming to the standard is labeled on the oil container. For example, the following label shows the MA classification.

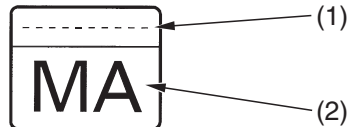

PRODUCT MEETING JASO T 903
COMPANY GUARANTEEING THIS MA PERFORMANCE:

(1) code number of the sales company of the oil

(2) oil classification

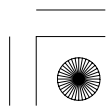
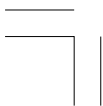



Engine Oil

Checking & Adding Oil

Refer to *Safety Precautions* on page 84 .

Check the engine oil level each day before operating your ATV and add if needed.

Before starting the engine to check the engine oil level

1. Park your ATV on a firm, level surface.
2. Start the engine in a well-ventilated area and let it idle for 3–5 minutes. Stop the engine and wait 2–3 minutes.
3. Remove the oil filler cap/dipstick (1) from the right crankcase cover and wipe it clean.
4. Insert the oil filler cap/dipstick without screwing it in, then remove the oil filler cap/dipstick and check the oil level. The oil level should be between the upper level mark (2) and the lower level mark (3) on the oil filler cap/dipstick.
5. If required, add the specified oil into the filler cap hole, up to the upper level mark on the oil filler cap/dipstick. Do not overfill.
6. Reinstall the oil filler cap/dipstick.

NOTICE

Running the engine with an improper oil level can cause serious engine damage.

RIGHT SIDE

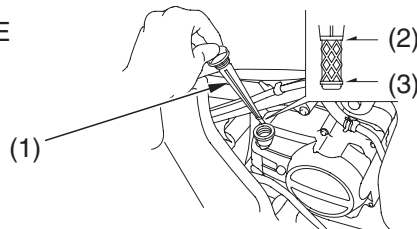

(1) oil filler cap/dipstick
(2) upper level mark

(3) lower level mark

102 Servicing Your Honda



Engine Oil

Changing Engine Oil

Refer to *Safety Precautions* on page 84 .

This procedure requires mechanical skill and professional tools such as a torque wrench as well as a means for disposing of the drained fluid (page 160). If you do not have the skills or the tools, see your Honda dealer.

Drain the Engine Oil:

1. With the ATV on the level ground, remove the oil filler cap/dipstick from the right crankcase cover.
2. Place an oil drain pan under the crankcase and remove the oil drain plug (1).

UNDER ENGINE

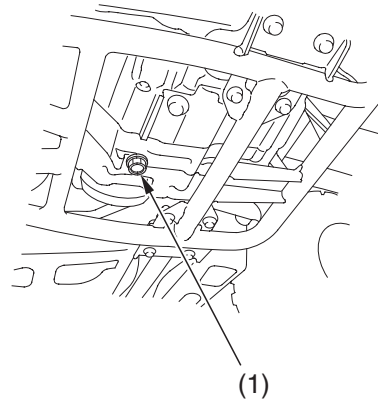

(1) oil drain plug

(cont'd)



Engine Oil

3. Pour the drained oil into a suitable container and dispose of it in an approved manner (page 160).

NOTICE

Improper disposal of drained fluids is harmful to the environment.

Add Engine Oil:

1. Check that the drain plug sealing washer is in good condition. If necessary, replace the sealing washer.
2. Reinstall the oil drain plug and tighten it to the specified torque:
17 lbf·ft (24 N·m , 2.4 kgf·m)
3. Fill the crankcase with the recommended grade oil approximately:
0.7 US qt (0.7 ℓ)
4. Reinstall the oil filler cap/dipstick.
5. Start the engine and let it idle for 3 – 5 minutes.
6. Stop the engine and check the oil level. Make sure the oil is between the upper and lower level marks on the oil filler cap/dipstick. If necessary, add more oil but do not overfill.
7. Check that there are no oil leaks.



If a torque wrench is not used for installation, see your Honda dealer as soon as possible to verify proper assembly.





Air Cleaner

Refer to *Safety Precautions* on page 84.

Proper air cleaner maintenance is very important for off-road vehicles. A dirty, water-soaked, worn-out, or defective air cleaner will allow dirt, dust, mud, and other impurities to pass into the engine.

Service the air cleaner more frequently if you ride in unusually wet or dusty areas. Your Honda dealer can help you determine the correct service interval for your riding conditions.

Your ATV's air cleaner has very specific performance requirements. Use a new Honda Genuine air cleaner specified for your model or an air cleaner of equal quality.

NOTICE

Using the wrong air cleaner may result in premature engine wear.

Proper air cleaner maintenance can prevent premature engine wear or damage, expensive repairs, low engine power, poor gas mileage, and spark plug fouling.

NOTICE

Improper or lack of proper air cleaner maintenance can cause poor performance and premature engine wear.



Air Cleaner

Cleaning

1. Remove the seat by pulling the seat lock lever (1) up.

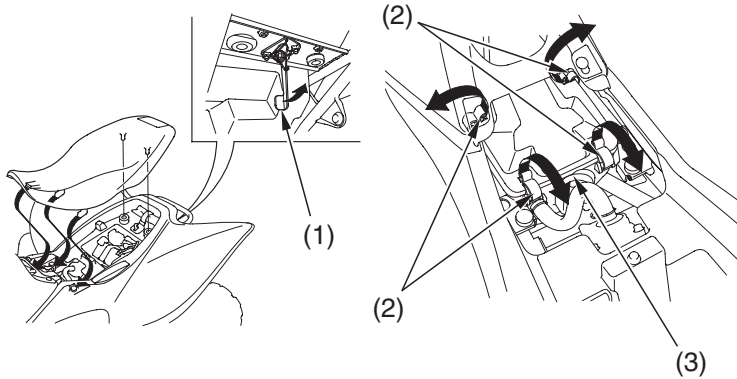

(1) seat lock lever
(2) retainer clips

(3) air cleaner housing cover

2. Unlatch the four retainer clips (2).
3. Remove the air cleaner housing cover (3).
4. Remove the set plate (4) and remove the air cleaner assembly (5) from the case.

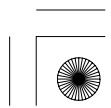
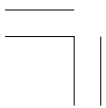



Air Cleaner

5. Remove the air cleaner (6) from the air cleaner body (7).
6. Remove the sub air cleaner (8) from the air cleaner joint (9).
7. Gently wash the air cleaner and sub air cleaner in clean, non-flammable (high flash point) solvent such as kerosene—not gasoline. After cleaning, gently squeeze out the remaining solvent. Avoid twisting or wringing the air cleaner. This can tear the foam.

UNDER SEAT

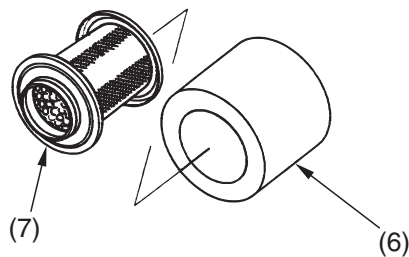
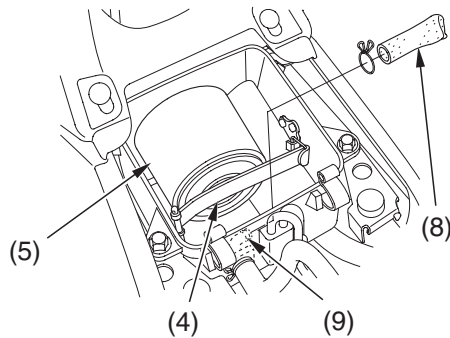

- | | |
|--------------------------|-----------------------|
| (4) set plate | (7) air cleaner body |
| (5) air cleaner assembly | (8) sub air cleaner |
| (6) air cleaner | (9) air cleaner joint |

(cont'd)

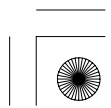
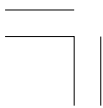

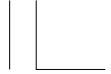

Air Cleaner

8. Inspect for tears or cracks in the foam or seams of the air cleaner and/or sub air cleaner. Replace the air cleaner and/or sub air cleaner if it is damaged.
9. Allow the sub air cleaner to dry thoroughly before installing.
10. Install the sub air cleaner.
11. Allow the air cleaner to dry thoroughly before applying oil. A wet air cleaner will not fully absorb the oil.
12. Pour clean Pro Honda Foam Filter Oil or an equivalent (Canada: Honda Foam Filter Oil or an equivalent) over the entire surface of the air cleaner. Use both hands to evenly spread the oil into the air cleaner. Gently squeeze out any excess oil. (To keep your hands dry, place the air cleaner in a clean plastic bag before spreading the oil into the air cleaner.)
13. Install the air cleaner on the air cleaner body.
14. Apply a thin coat of grease to the sealing surface of the air cleaner assembly.
15. Insert the air cleaner assembly into the air cleaner housing.
16. Install the set plate.
17. Install the air cleaner housing cover.
18. Latch the four retainer clips.

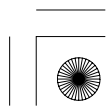



Throttle

Throttle Freeplay

Refer to *Safety Precautions* on page 84.
For throttle limiter adjustment, see page 46.

RIGHT HANDLEBAR

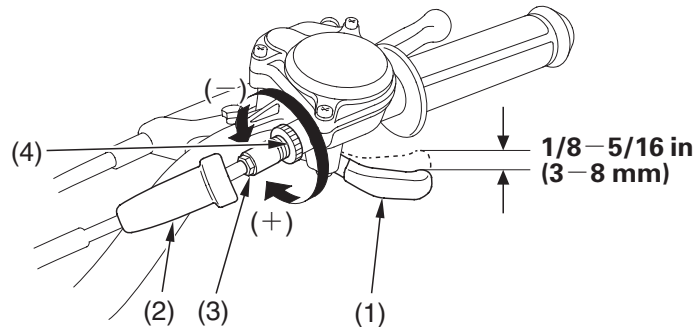

- | | |
|-----------------------------|-----------------------|
| (1) throttle lever | (4) lock nut |
| (2) rubber sleeve | (+) increase freeplay |
| (3) throttle cable adjuster | (-) decrease freeplay |

Inspection

Check freeplay at the throttle lever (1).

Freeplay:

1/8–5/16 in (3–8 mm)

Adjustment

1. Slide the rubber sleeve (2) back to expose the throttle cable adjuster (3).
2. Loosen the lock nut (4).
3. Turn the adjuster to obtain the correct freeplay.
4. Tighten the lock nut and reinstall the sleeve.
5. After adjustment, check for smooth operation of the throttle lever from fully closed to fully open in all steering positions.



Throttle

Throttle Inspection

Refer to *Safety Precautions* on page 84.
For throttle limiter adjustment, see page 46.

1. Check that the throttle assembly is positioned properly and the securing bolts are tight.
2. Check for smooth operation of the throttle lever from fully open to fully closed in all steering positions. If there is a problem, see your Honda dealer.
3. Inspect the condition of the throttle cables from the throttle lever down to the carburetor. If the cable is kinked or chafed, have it replaced.
4. Check the cables for tension or stress in all steering positions.
5. Lubricate the cables with a commercially available cable lubricant to prevent premature wear and corrosion.





Clutch System

Your ATV's shift-activated, wet, multiplate clutch is part of the primary drive system. Proper adjustment allows a smooth, gradual engagement when shifting gears.

Clutch Adjustment

Refer to *Safety Precautions* on page 84.

RIGHT SIDE

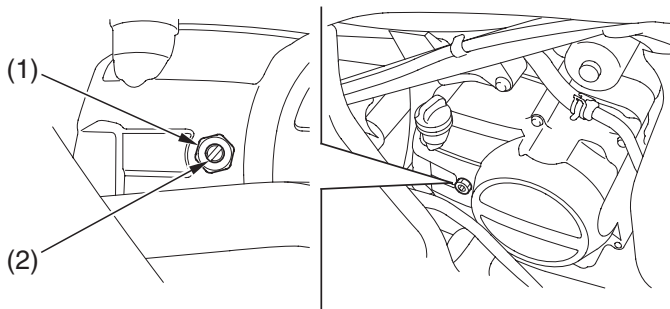

(1) lock nut

(2) clutch adjuster

1. Make sure the ignition switch is OFF (\circ).
2. Loosen the lock nut (1).
3. Turn the clutch adjuster (2) counterclockwise until you feel slight resistance.
4. Turn the adjuster 1/8 turn clockwise, then tighten the lock nut to hold the adjuster in this position.
5. After adjustment, start the engine and test ride your ATV to be sure the clutch is operating properly.

If you cannot get proper adjustment, or the clutch does not work properly, the cable or clutch friction discs may be worn. See your Honda dealer or refer to official Honda Service Manual (page 194).



Engine Idle Speed

The best way to assure proper carburetion is to see your Honda dealer for regularly scheduled servicing, including carburetor adjustment.

Remember, idle speed adjustment is not a “cure-all” for other problems in your engine’s fuel-delivery system. Adjusting the idle will not compensate for a fault elsewhere.

The engine must be at normal operating temperature for accurate idle speed adjustment.

For information about high altitude carburetor adjustment, see page 186.

Idle Speed Adjustment

Refer to *Safety Precautions* on page 84.

LEFT SIDE

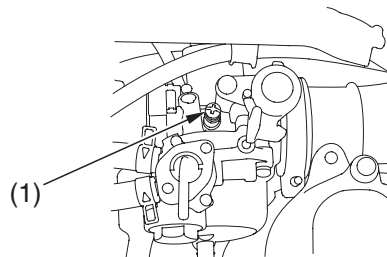

(1) throttle stop screw

1. If the engine is cold, start it and warm it up with 10 minutes of stop-and-go riding. Stop the engine.
2. Park your ATV on a firm, level surface.
3. Connect a tachometer to the engine.
4. Shift into neutral. Start the engine.
5. Adjust idle speed using a screwdriver to turn the throttle stop screw
(1). Idle speed (in neutral):
 $1,600 \pm 100$ rpm

112 Servicing Your Honda





Spark Plug

Spark Plug Recommendation

standard spark plug	CR7HSA (NGK) or U22FSR-U (DENSO)
for cold climate (below 5°C, 41°F)	CR6HSA (NGK) or U20FSR-U (DENSO)
for extended high speed riding	CR8HSA (NGK) or U24FSR-U (DENSO)

Use only the recommended type of spark plug in the recommended heat range.

NOTICE

Using spark plugs with an improper heat range can cause engine damage.

Spark Plug Inspection & Replacement

Refer to *Safety Precautions* on page 84.

1. Clean any dirt from around the spark plug base.
2. Disconnect the spark plug cap. Take care to avoid damaging the spark plug wire when disconnecting the cap.
3. Using a spark plug wrench provided in the tool kit, remove the spark plug.

(cont'd)



Spark Plug

4. Inspect the electrodes and center porcelain for deposits, corrosion, or carbon fouling. If the corrosion or deposits are heavy, replace the plug. Clean a carbon or wet-fouled plug with a plug cleaner, if available, or a wire brush. Inspect the spark plug electrodes for wear. The center electrode (1) should have a flat tip and sharp edges, and the side electrode (2) should not be eroded. If the electrodes and insulator tip appear unusually fouled or burned, we suggest that you contact your Honda dealer.
5. Discard the spark plug if there is apparent wear or if the insulator is cracked or chipped.
6. Using a wire-type feeler gauge, check the spark plug gap (3). If adjustment is necessary, bend the side electrode carefully.

The gap should be:

0.024–0.028 in (0.60–0.70 mm)

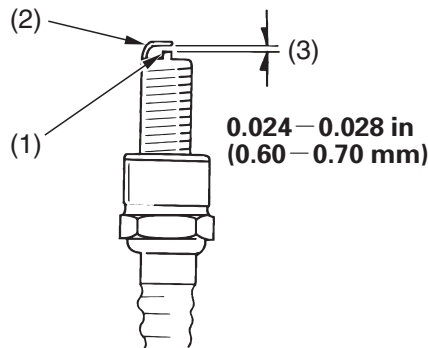

(1) center electrode
(2) side electrode

(3) spark plug gap





Spark Plug

7. With the plug washer attached, thread the spark plug in by hand to prevent cross-threading.
8. Tighten the spark plug:
 - If the old plug is good:
 - 1/8 turn after it seats.
 - If installing a new plug, tighten it twice to prevent loosening:
 - a) First, tighten the plug:
 - NGK: 1 turn after it seats.
 - DENSO: 3/4 turn after it seats.
 - b) Then loosen the plug.
 - c) Next, tighten the plug again:
 - 1/8 turn after it seats.

NOTICE

An improperly tightened spark plug can damage the engine. If a plug is too loose, a piston may be damaged. If a plug is too tight, the threads may be damaged.

9. Reinstall the spark plug caps. Take care to avoid pinching any cables or wires.



Valves

Valve Inspection

Refer to *Safety Precautions* on page 84.

Valve clearance should be:

intake: 0.002 in (0.05 mm)

exhaust: 0.002 in (0.05 mm)

Excessive clearance will cause noise. Insufficient clearance will cause loss of power and possibly damage the valves.

For those who are mechanically proficient and have the proper tools, instructions on adjusting valve clearances are given in the official Honda Service Manual (page 194). Otherwise, the valves should be adjusted by your Honda dealer.





Spark Arrester

Refer to *Safety Precautions* on page 84.

Regular servicing prevents carbon build up (which can diminish engine performance) and also complies with USDA regulations for regular maintenance to assure proper function. The spark arrester prevents random sparks from the combustion process in your engine from reaching the environment.

The use of safety glasses is recommended for this procedure.

Because of the possible fire hazard, check that there are no combustible materials in the area before purging the spark arrester.

REAR

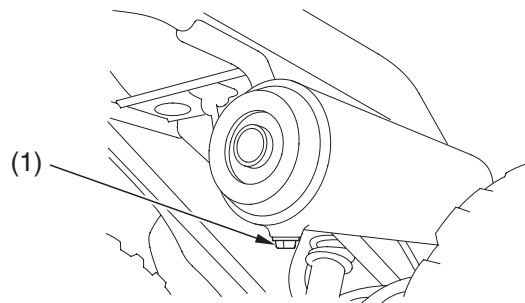

(1) bolt

1. Select a well-ventilated area free of combustible materials and make sure the exhaust pipe is cool.
2. Remove the bolt (1).
3. Start the engine and rev it up approximately twenty times while momentarily creating exhaust system back pressure by blocking the end of the muffler with a shop towel.
4. Stop the engine and allow the exhaust pipe to cool.
5. Reinstall the bolt securely.





Brakes

The mechanical drum brakes on your ATV dissipate heat generated by the friction of the brake shoes on the drums as the wheels are slowed.

Front Brake Lever Freeplay

Refer to *Safety Precautions* on page 84.

Inspection

RIGHT HANDLEBAR

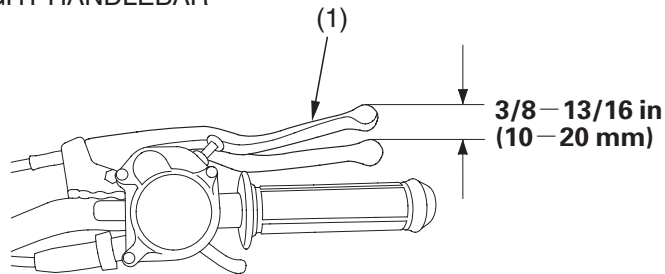

(1) front brake lever

Measure the distance the brake lever moves before the brakes start to take hold. Freeplay, measured at the tip of the front brake lever (1) should be:

3/8 – 13/16 in (10 – 20 mm)

Adjust the freeplay of the front brake lever with the front wheel pointed straight ahead.





Brakes

Adjustment

UNDER FRONT FENDER

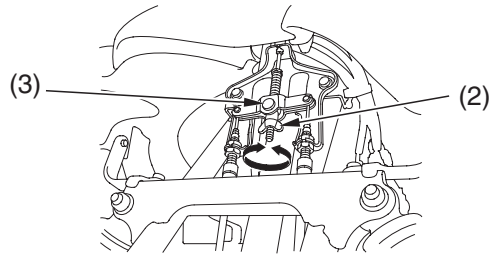

- (2) front brake lever adjusting nut
- (3) brake arm pin

1. Turn the front brake lever adjusting nut (2), located under the front fender. Make sure the cutout on the adjusting nut is properly seated on the brake arm pin (3).
2. Adjust the freeplay of the front brake lever.
Push the brake arm (4) then check the brake arm freeplay.

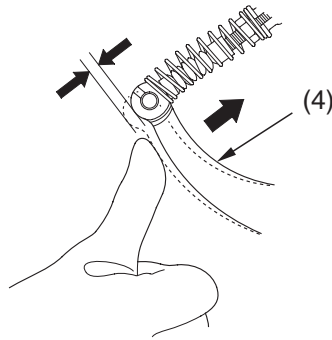

- (4) brake arm



Brakes

Rear Brake Pedal Freeplay

RIGHT SIDE

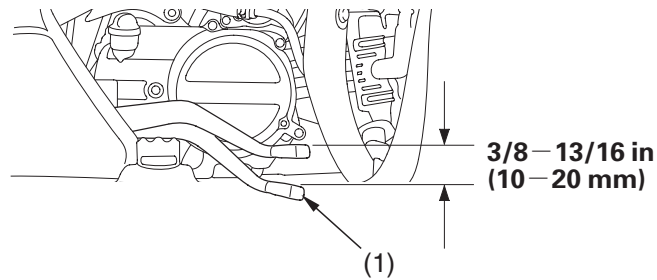

(1) rear brake pedal

Inspection

Measure the distance the rear brake pedal (1) moves before the brake starts to take hold. Freeplay (measurement at the tip of the end of the brake pedal) should be:

3/8 – 13/16 in (10 – 20 mm)

If necessary, adjust to the specified range.



Brakes

Adjustment

RIGHT REAR

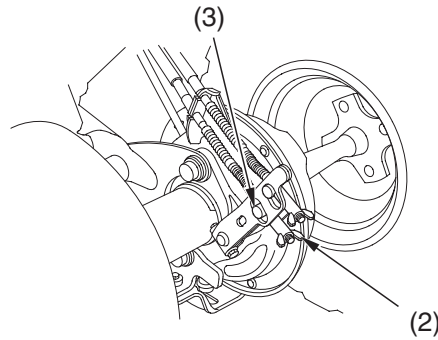

- (2) brake pedal adjusting nut
- (3) brake arm pin

1. Turn the brake pedal adjusting nut (2), located on the brake operating rod at the rear of the frame. Make sure the cutout on the adjusting nut is properly seated on the brake arm pin (3).
2. Adjust the freeplay of the rear brake pedal. Push the brake arm (4), then check the clearance between the brake arm and the brake arm pin.

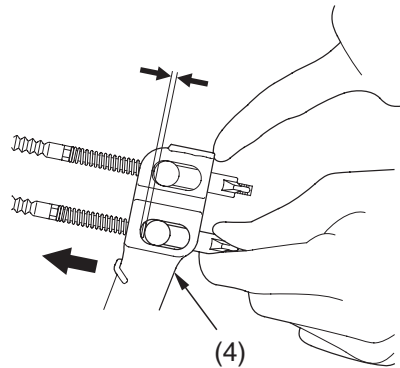

(4) brake arm



Brakes

Rear Brake Lever Freeplay

LEFT HANDLEBAR

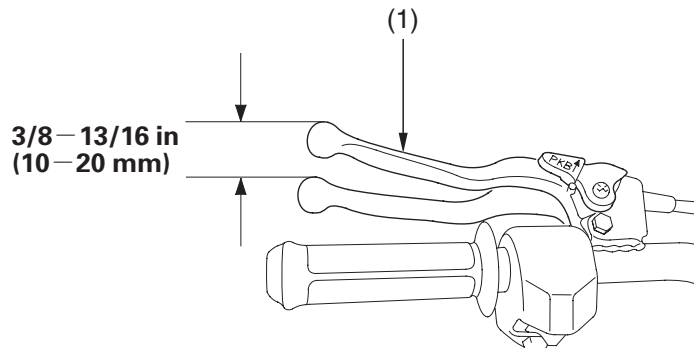

(1) rear brake lever/parking brake lever

Inspection

Measure the distance the rear brake lever/parking brake lever (1) moves before the brake starts to take hold. Freeplay (measurement at the tip of the end of the brake lever) should be:

3/8 - 13/16 in (10 - 20 mm)

If necessary, adjust to the specified range.

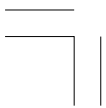



Brakes

Adjustment

RIGHT REAR

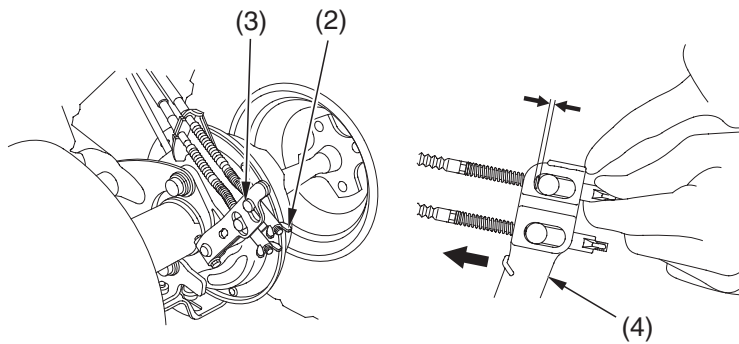

(2) brake lever adjusting nut
(3) brake arm pin

(4) brake arm

Adjust the freeplay of the rear brake lever/parking brake lever with the front wheels pointed straight ahead.

1. Turn the brake lever adjusting nut (2), located on the brake operating rod at the rear of the frame. Make sure the cutout on the adjusting nut is properly seated on the brake arm pin (3).
2. Adjust the freeplay of the rear brake lever/parking brake lever. Push the brake arm (4) then check the clearance between the brake arm and the brake arm pin.

Other Inspections

- Check that the rear brake lever and brake pedal assemblies are positioned properly and the securing bolts are tight.
- Make sure that the brake cables, brake arm, spring, parking, and fasteners are in good condition.



Brakes

Brake Shoe Wear

Refer to *Safety Precautions* on page 84.

The front and rear brakes are equipped with external brake wear indicators that let you check brake wear without disassembly. Application of the brake control (lever or pedal) causes the arrow on the brake arm to move toward a reference mark on the brake panel.

RIGHT FRONT

LEFT FRONT

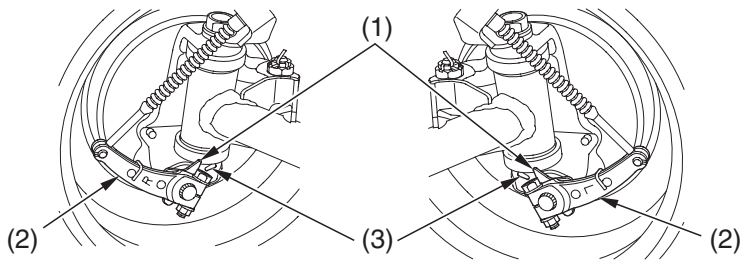

REAR

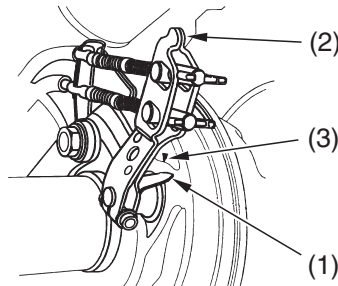

(1) arrow

(2) brake arm

(3) reference mark

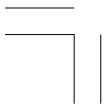



Brakes

1. Apply the brake control (lever and pedal) and check the movement of the arrow (1) on the brake arm (2).
2. Replace the brake shoe if the arrow aligns with the reference mark (3) on the brake panel upon full application of the brake. If replacement is necessary, see your Honda dealer.

Draining Water from Brakes

Refer to *Safety Precautions* on page 84.

REAR

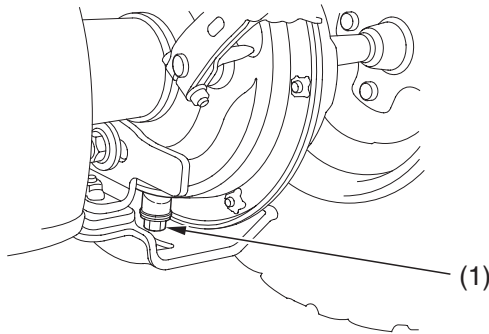

(1) brake drain bolt

1. Make sure the engine is OFF and the parking brake is set.
2. Remove the rear brake drain bolt (1) from the bottom of the rear brake panel.
If any water drains, see your Honda dealer as soon as possible for a check of the rear brake system and the left crankcase cover for water intrusion.



Tires

To safely operate your ATV, your tires must be the proper type and size, in good condition with adequate tread, and correctly inflated.

WARNING

Using tires that are excessively worn or improperly inflated can cause a crash in which you can be seriously hurt or killed.

Follow all instructions in this owner's manual regarding tire inflation and maintenance.

This ATV is equipped with low pressure tubeless tires. Although the tires are designed specifically for off-road use, they are not immune to punctures. Always select your riding area with care.

The following pages give detailed information on how and when to check your air pressure, how to inspect your tires for wear and damage, and our recommendations for tire repair and replacement.

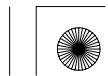



Tires

Air Pressure

Refer to *Safety Precautions* on page 84.

Properly inflated tires provide the best combination of handling, tread life, and riding comfort. Generally, underinflated tires wear unevenly, adversely affect handling, and are more likely to fail from being overheated. Overinflated tires make your ATV ride harshly, are more prone to damage from surface hazards, and wear unevenly.

Make sure the valve stem caps are secure. If necessary, install new caps.

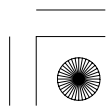
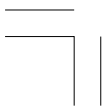



Tires

Always check air pressure when your tires are “cold.” If you check air pressure when your tires are “warm” — even if your ATV has only been ridden for a few miles — the readings will be higher. If you let air out of warm tires to match the recommended cold tire pressures, the tires will be underinflated. Be sure to check tire pressure at the riding site, since changes in altitude can affect air pressure.

The recommended “cold” tire pressures are:

	FRONT	REAR
RECOMMENDED PRESSURE	2.9 psi (20.0 kPa)	2.9 psi (20.0 kPa)

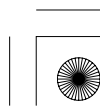
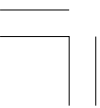



Tires

A manually operated tire pump should be used rather than the high pressure system found in service stations. This will minimize the possibility of tire damage from overinflation. If you use a high pressure system at a service station, add air in small amounts and check the pressure increase frequently to prevent possible tire damage from overinflation.

WARNING

Operating this ATV with improper tires, or with uneven tire pressure may cause loss of control, and you could be seriously injured or killed.

- Always use the size and type tires specified in this owner's manual for this vehicle.
- Always maintain proper tire pressure as described in this owner's manual.

Inspection

Refer to *Safety Precautions* on page 84.

Whenever you check the tire pressures, you should also look for:

- Bumps or bulges in the side of the tire or the tread. Replace any tire that has a bump or bulge.
- Cuts, slits, or cracks in the tires. Replace the tire if you can see fabric or cord.
- Nails or other foreign objects embedded in the side of the tire or tread.
- Excessive tread wear.



Tires

Also, if you hit a pothole or other hard object while riding, stop as soon as you safely can and carefully inspect the tires for damage.

Tread Wear

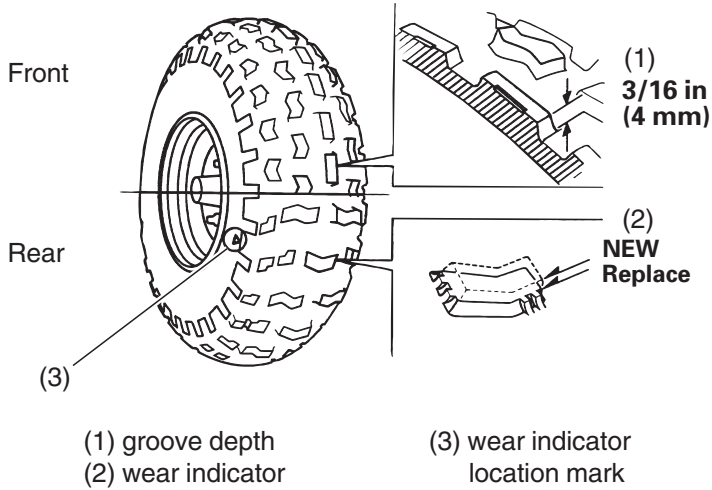

To check the condition of a tire tread, measure the groove depth (1) in the center of the tire, or check the wear indicator (2). For best performance, you should replace a tire before the tread depth at the center reaches the following limits:

front	3/16 in (4 mm)
rear	3/16 in (4 mm)

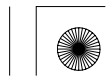



Tires

Tire Repair

Refer to *Safety Precautions* on page 84.

A tire that is repaired, either temporarily or permanently, will have lower speed and performance limits than a new or undamaged tire.

A temporary repair can sometimes be made in an emergency situation. However, since a temporary repair may not hold, you must ride very slowly, preferably without any cargo, and have the tire replaced or permanently repaired as soon as possible. (For more information on temporary repairs, see *If You Have a Flat Tire*, page 167.)

A permanent repair, such as an internal plug patch, can be made if a tire has only a small puncture in the tread area. However you may not be able to safely carry as much weight. If you choose to have a tire repaired, be sure the repair work is performed by a professional.

If you have a tire professionally repaired at a non-Honda facility, we recommend that you have the work checked by your Honda dealer.



Tires

Tire Replacement

Refer to *Safety Precautions* on page 84.

The tires that came on your ATV were designed to match the performance capabilities of your ATV and provide the best combination of handling, braking, and comfort.

It is best to replace all four tires, however if that is not possible, you must replace the tires in pairs (front or rear) with tires of the same size and type as the originals. Never replace just one tire.

WARNING

Installing improper tires on your ATV can affect handling and stability. This can cause a crash in which you can be seriously hurt or killed.

Always use the size and type of tires recommended in this owner's manual.



The recommended tires for your ATV are:

front	AT 20 × 7-8 ★ CHENG SHIN MAXXIS M953
rear	AT 19 × 8-8 ★ CHENG SHIN MAXXIS M954

When you replace a tire, remember:

Have the tire replaced by your Honda dealer if possible.

If you have a tire professionally replaced at a non-Honda facility, we recommended that you have the work checked by your Honda dealer.

132 Servicing Your Honda

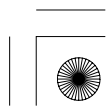
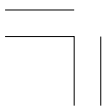



Skid Plates

Refer to *Safety Precautions* on page 84.

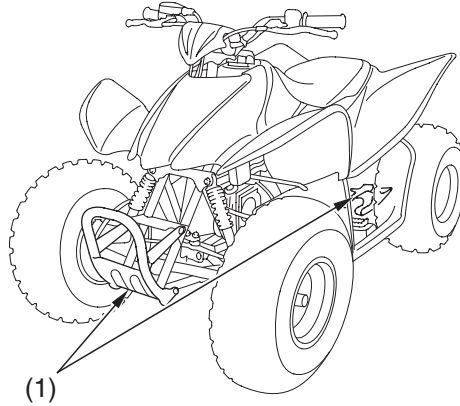

(1) skid plates

The skid plates (1) protect the frame/lower arm, the drive components and the rear brake. Check the plates for cracks, damage or looseness at intervals shown in the Maintenance Schedule.

Have the skid plates replaced if they are cracked or damaged. If the plate bolts are loose, tighten them securely.



Drive Chain

Refer to *Safety Precautions* on page 84.

An endless (riveted master link) chain connects the front and rear wheel sprockets. The O-ring chain uses rubber rings between the side plates of the pin and roller links to seal in the manufacturer-installed lubricating grease and keep out moisture and dirt.

The service life of the chain depends on proper lubrication and adjustment. Poor maintenance can cause premature wear or damage to the drive chain or sprockets.

Under severe usage, or when the ATV is ridden in unusually dusty or muddy areas, more frequent maintenance will be necessary.

Before servicing your drive chain, turn the engine OFF and check that your transmission is in neutral.

It is not necessary to remove or replace the drive chain to perform the recommended service in the Maintenance Schedule.





Drive Chain

Inspection

LEFT SIDE

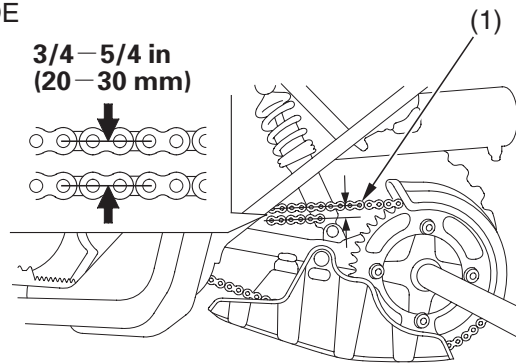

(1) drive chain

1. Measure the amount of chain slack midway between the sprockets. Drive chain slack should allow the following vertical movement by hand:
3/4 – 5/4 in (20 – 30 mm)
2. Check drive chain slack at several points along the chain. The slack should remain constant. If it isn't, some links may be kinked and binding. Lubricating the chain will often eliminate binding and kinking.

NOTICE

Excessive chain slack may allow the drive chain to damage the engine cases.

(cont'd)



Drive Chain

3. Inspect the drive chain for:

- damaged rollers
- loose pins
- dry or rusted links
- kinked or binding links
- excessive wear
- damaged or missing O-rings

Replace the drive chain (page 141) if it has damaged rollers, loose pins, or kinks that cannot be freed. Lubricate the drive chain (page 140) if it appears dry or shows signs of rust. Lubricate any kinked or binding links and work them free. Adjust chain slack if needed.

4. Check the drive chain slider (2) at the intervals specified in the Maintenance Schedule.

The chain slider must be replaced if it is worn to the wear limit line (3). For replacement, see your Honda dealer.

Replace the slider when the depth of the grooves reaches the limit.

Service limit:

0.24 in (6.0 mm)

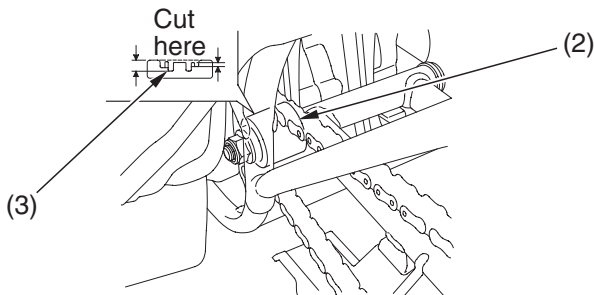

(2) drive chain slider

(3) wear limit line

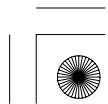
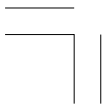



Drive Chain

5. With the upper or lower section of drive chain tight between the sprockets measure the distance between a span of 21 pins from pin center to pin center. If the distance exceeds the service limit, the chain is worn out and should be replaced.

Service limit:

10.6 in (268 mm)

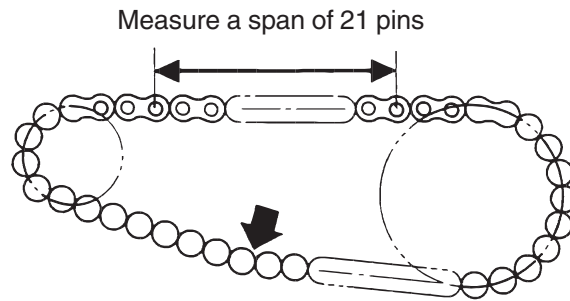

(cont'd)



Drive Chain

6. Inspect the front and rear sprocket teeth for excessive wear or damage.
If necessary, have your Honda dealer replace a worn sprocket.

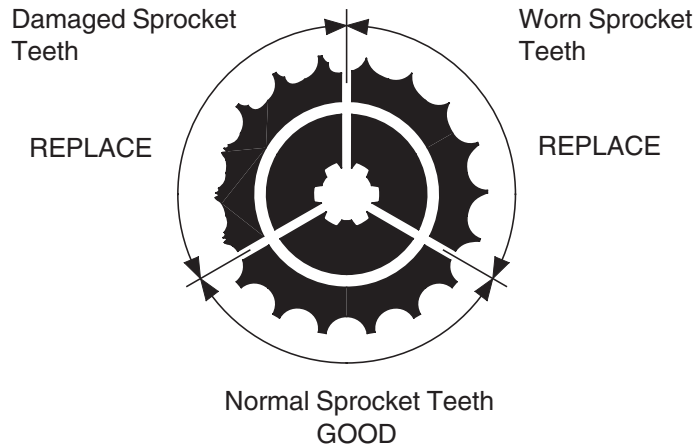

NOTICE

Use of a new chain with worn sprockets will cause rapid chain wear.





Drive Chain

Adjustment

Refer to *Safety Precautions* on page 84 .

1. To adjust slack, loosen the rear axle holder fixing bolts (1).
2. Turn the adjusting nut (2) to decrease or increase chain slack.
3. Retighten the rear axle holder fixing bolts.
4. Rear axle holder fixing bolts torque:
65 lbf·ft (88 N·m , 9.0 kgf·m)

If a torque wrench is not used for this installation, see your Honda dealer as soon as possible to verify proper assembly.

REAR

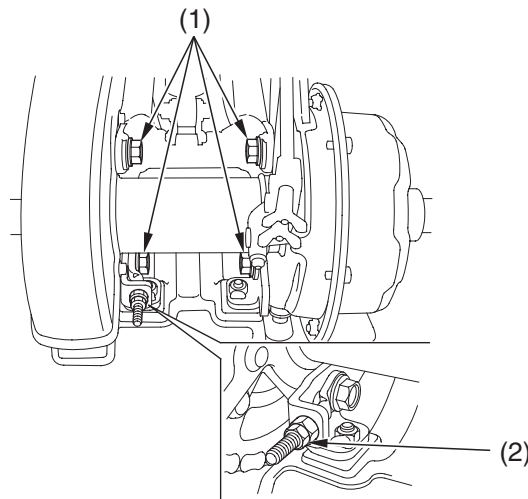

- (1) rear axle holder fixing bolts
(2) adjusting nut



Drive Chain

Lubrication

Refer to *Safety Precautions* on page 84 .

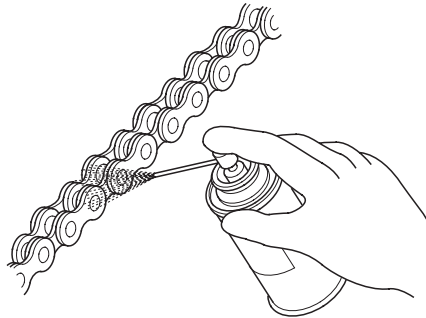

Lubricate every 30 days of riding or sooner if chain appears dry.

Lubricant: Pro Honda HP Chain Lube or an equivalent chain lubricant designed specifically for use on O-ring chains.

Commercial chain lubricants not designed for motorcycle drive chains may contain solvents which could damage the O-rings.





Drive Chain

Removal, Cleaning & Replacement

Refer to *Safety Precautions* on page 84.

Your ATV has an endless (riveted master link) type chain. It should only be removed or replaced by your Honda dealer.

The O-rings can be damaged by steam cleaning, high pressure washers, and certain solvents.

1. Clean the side surfaces of the chain with a dry cloth. Use a high flashpoint solvent such as kerosene — not gasoline.
Do not brush the rubber O-rings.
Brushing will damage them. Use of a solvent may also damage the O-rings.
2. Inspect the drive chain for possible wear or damage.

Replace the drive chain if it has damaged rollers, loose fitting links, damaged O-rings, or otherwise appears unserviceable.

Replacement Chain:

DID 428V-98LE or RK428 HOZ1-98LE



Battery

Your ATV has a maintenance-free type battery. You do not have to check the battery electrolyte level or add distilled water as you would with a conventional-type battery.

NOTICE

Your battery is a maintenance-free type and can be permanently damaged if the cap strip is removed.

Electrical accessories use current from the battery, even when the ignition is OFF. Limited operation also allows the battery to discharge. If you have electrical accessories on your ATV or do not ride frequently, we recommend that you charge the battery frequently (see *Battery Charging*, page 146).

If you do not expect to ride your ATV for at least two weeks, we recommend you remove the battery, or at least disconnect the battery cables (negative cable first).

If you plan to store your ATV, see *Battery Storage*, page 143.

If your battery seems weak and/or is leaking electrolyte (causing slow starting or other electrical problems), see your Honda dealer.

WARNING: Battery posts, terminals and related accessories contain lead and lead compounds. **Wash your hands after handling.**





Battery

Battery Storage

Refer to *Safety Precautions* on page 84.

If you plan to store your ATV, we recommend you remove the battery and store it where it can be charged at least every 30 days to maintain its service life.

If you do not remove the battery, we recommend disconnecting the battery cables (negative cable first).

You will get the best storage results from removing the battery and slow (trickle) charging it every 30 days (see *Battery Charging*, page 146).

Before you remove the battery, be sure to read all the information that follows, as well as the information on the battery label.



WARNING

The battery gives off explosive hydrogen gas during normal operation.

A spark or flame can cause the battery to explode with enough force to kill or seriously hurt you.

Wear protective clothing and a face shield, or have a skilled mechanic do the battery maintenance.

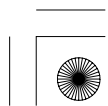



Battery

The battery is located in a compartment under the seat.

UNDER SEAT

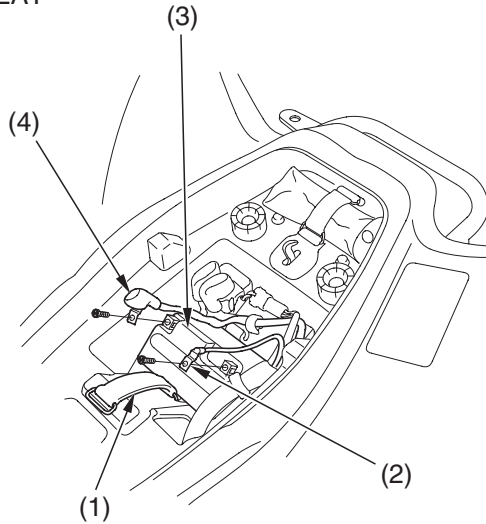

- | | |
|--------------------------------|--------------------------------|
| (1) rubber band | (3) battery |
| (2) negative (-) terminal lead | (4) positive (+) terminal lead |

Removal

1. Make sure the ignition switch is OFF (\circ).
2. Remove the seat (page 95).
3. Release the rings and remove the rubber band (1).
4. Disconnect the negative (-) terminal lead (2) from the battery (3) first, then disconnect the positive (+) terminal lead (4).
5. Remove the battery.

144 Servicing Your Honda





Battery

6. Charge the battery (see following section), unless you have been riding regularly.
7. Store your battery in an easy-to-reach location off the floor, in an area protected from freezing temperature and direct sunlight.
8. Clean the battery box after removing the battery for storage. Dry the battery box and, if paint is missing, re-paint the area.
9. Slow charge the battery (see following section) once every 30 days.

Installation

1. Reinstall in the reverse order of removal.
Be sure to connect the positive (+) terminal first, then the negative (-) terminal.
2. Make sure all bolts and other fasteners are secure.

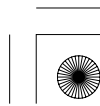



Battery

Battery Charging

Refer to *Safety Precautions* on page 84.

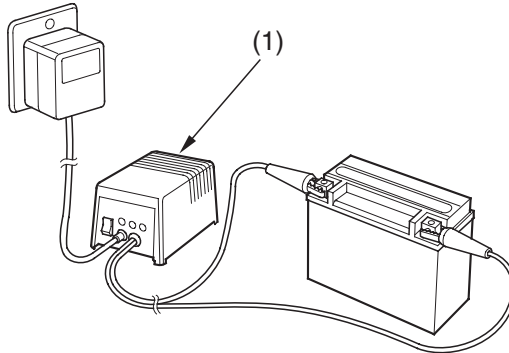

(1) “trickle” charger

Be sure to read the information that came with your battery charger and follow the instructions on the battery. Improper charging may damage the battery.

We recommend using a “trickle” charger (1) for home charging. These units can be left connected for long periods without risking damage to the battery. However, do not intentionally leave the charger connected longer than the time period recommended in the charger’s instructions.

Avoid using an automotive-type battery charger. An automotive charger can overheat an ATV battery and cause premature damage.

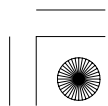
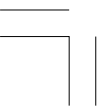



Appearance Care

Frequent cleaning and polishing will keep your Honda looking newer longer.

Frequent cleaning also identifies you as an owner who values his ATV. A clean ATV is also easier to inspect and service.

General Recommendations

Refer to *Safety Precautions* on page 84.

- To clean your ATV, you may use:
 - water
 - a mild, neutral detergent and water
 - a mild spray and wipe cleaner/polisher
 - a mild spray and rinse cleaner/degreaser and water
- Avoid products that contain harsh detergents or chemical solvents that could damage the metal, paint, and plastic on your ATV.
- If your ATV is still warm from recent operation, give the engine and exhaust system time to cool off.
- Park in a shady area. Washing your ATV in bright sunlight may cause the finish to fade because water droplets intensify the sun's brightness.
- Spotting is also more likely because surface water can dry before you have time to wipe it off.
- Clean your ATV regularly to protect surface finishes.
- We recommend the use of a garden hose to wash your ATV. High pressure washers (like those at coin-operated car washers) can damage certain parts of your ATV.

NOTICE

High pressure water (or air) can damage certain parts of your ATV.

- After cleaning, inspect for damage, wear, and leaks (fuel and oil).

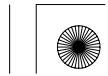



Appearance Care

Washing Your ATV with a Mild Detergent

Refer to *Safety Precautions* on page 84.

1. Rinse your ATV thoroughly with cool water to remove loose dirt.
2. Fill a bucket with cool water. Mix in a mild, neutral detergent, such as dish washing liquid or a product made especially for washing motorcycles or automobiles.
3. Wash your ATV with a sponge or soft towel. As you wash, check for heavy grime. If necessary, use a mild cleaner/degreaser to remove the grime.
4. After washing, rinse your ATV thoroughly with plenty of clean water to remove any residue. Detergent residue can corrode alloy parts.
5. Dry your ATV with a chamois or a soft towel. Leaving water on the surface to air dry can cause dulling and water spots. As you dry, inspect for chips and scratches.
6. Start the engine and let it idle for several minutes. The engine heat will help dry moist areas.
7. As a precaution, ride your ATV at a slow speed and apply the brakes several times. This will help dry the brakes and restore normal braking performance.

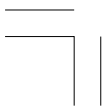



Appearance Care

Spray Cleaning Your ATV

Refer to *Safety Precautions* on page 84.

Avoid using spray cleaner products on the tires or suspension components.

Suggestions for using spray cleaner(s) follow:

ATV condition	Recommended Cleaning
Dust and fingerprint smudges.	Apply a spray cleaner/polish and wipe paint, chrome, glass, and clear plastic.
Light road grimes.	Spray any difficult-to-reach or very dirty areas with a spray cleaner/degreaser. Rinse and dry. Apply a spray cleaner/polish and wipe with a non-abrasive cloth.
Heavy grime. Oil leaks. Brake dust.	Use a spray cleaner/degreaser. If necessary, rub with a sponge. Rinse and dry. Apply a spray cleaner/polish and wipe with a non-abrasive cloth.
Dull, corroded chrome or aluminum.	Apply a high quality chrome/aluminum polish and wipe with a non-abrasive cloth.





Appearance Care

Finishing Touches

Refer to *Safety Precautions* on page 84.

After washing your ATV, consider using a commercially available spray cleaner/polish or quality liquid or paste wax to finish the job. Use only a non-abrasive polish or wax made specifically for motorcycles or automobiles. Apply the polish or wax according to the instructions on the container.

If a surface on your ATV is chipped or scratched, your Honda dealer has touch-up paint to match your ATV's color. Be sure to use your ATV's color code (page 181) when you buy touch-up paint.

If the frame has a chip that exposes the metal, first apply primer (to prevent corrosion) and then apply the touch-up paint. Several thin layers of touch-up paint are better than one thick coat.

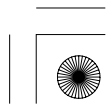



Tips

Here's helpful advice on how to prepare for an off-road adventure, how to transport and store your Honda, and how to be an environmentally responsible ATV owner.

Preparing for a Ride	152
What to Take to The Riding Area	152
What to Take on The Trail	153
Transporting Your Honda	154
Storing Your Honda	156
Preparation for Storage	157
Removal from Storage	159
You & the Environment	160

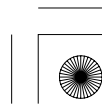
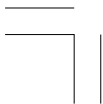



Preparing for a Ride

A safe and enjoyable ride begins with good planning and preparation. Always ride with at least one other person in case you have trouble, and let someone know where you're going and when you expect to return.

Before riding in an unfamiliar area, find out in advance if you need special permits, get maps so you can study the terrain, and talk to other riders who know the area. The Forest Service and the Bureau of Land Management (USA only), the Ministry of Natural Resources (Canada only), riding clubs, and off-road magazines are good sources of information.

What to Take to the Riding Area

Along with your ATV and riding gear, you should take along some tools and supplies in case you have a problem. For some of the difficulties you might encounter, see *Taking Care of the Unexpected*, which begins on page 161.

We recommend that you always take water, food, a first aid kit, and your owner's manual. Other items you should consider loading on your truck or trailer include:

- a tool kit
- tire repair supplies and tools, and tires
- extra parts, control levers, cables, and spark plugs
- wire, duct tape, and rope
- extra gasoline

For safety, all refueling should be done at a gas station on the way to the riding area or at your base camp.

152 Tips





Preparing for a Ride

What to Take on the Trail

What you take with you during a ride depends on the kind of terrain, how long you expect to ride, how far you might go from your base camp or help, and how experienced you or your companions are in making repairs.

This ATV is not designed to carry cargo. Also, be sure to follow the loading guidelines and weight limit (page 39).

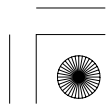
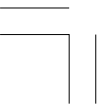



Transporting Your Honda

Do not tow your ATV behind a car or other vehicle.

When you transport your ATV, we recommend that you carry the vehicle in its normal operating position (on all four wheels). Do not incline the vehicle upright on its rear end. This can damage the vehicle, and leaking gasoline could be a hazard.

Follow these procedures:

1. Set the parking brake and place the transmission in gear.
2. Turn the fuel valve OFF.

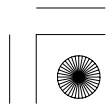



Transporting Your Honda

3. Secure the vehicle with tie-down straps in the areas shown.
 - Suitable tie-down straps are available from your Honda dealer.
 - Ordinary rope is not recommended because it can stretch under load.
 - Using tie-down straps in any other areas can damage your ATV.
4. Rock the vehicle back and forth to make sure the tie-down straps are tight and the vehicle is secure.

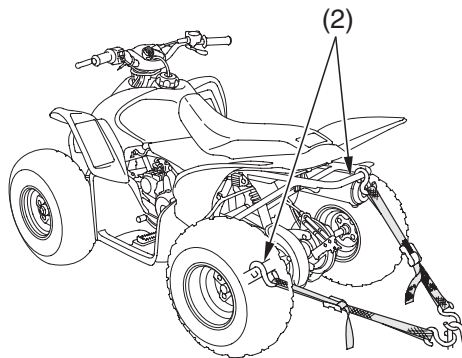
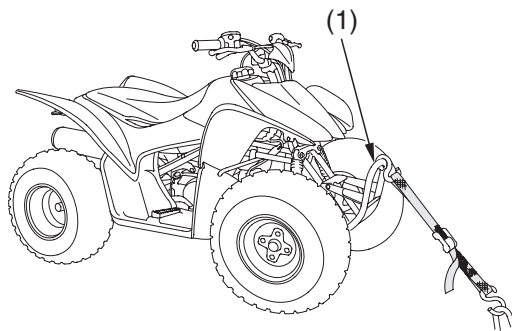

(1) front carry pipe (2) rear carry pipe or rear axle shaft

Tips 155



Storing Your Honda

If you won't be riding for an extended period, such as during the winter, thoroughly inspect your ATV and correct any problem before storing it. That way, needed repairs won't be forgotten and it will be easier to get your ATV running again.

For more information about storage, refer to the *Honda Motorcycle Winter Storage Guide*, available from your Honda dealer (USA only).

We suggest you perform the following procedures to keep your ATV in top condition. These storage procedures will reduce the deterioration that can occur during storage.

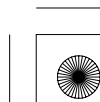
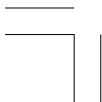



Storing Your Honda

Preparation for Storage

Refer to *Safety Precautions* on page 84.

This procedure requires a means for draining and disposing of drained fuel (page 160).

1. Change the engine oil (page 103).
2. Fill the fuel tank. Make sure the fuel fill cap is properly installed.
3. Check that the fuel valve is OFF.
4. Drain the carburetor into an approved gasoline container and dispose of it in an approved manner (page 160).

If storage will last longer than one month, carburetor draining is important to assure proper performance after storage.

WARNING

Gasoline is highly flammable and explosive. You can be burned or seriously injured when handling fuel.

- Stop the engine and keep heat, sparks and flame away.
- Handle fuel only outdoors.
- Wipe up spills immediately.

(cont'd)

Tips 157



Storing Your Honda

5. To prevent rusting in the cylinders, perform the following:
 - Remove the spark plug from the spark plug.
 - Remove the spark plug.
 - Do not connect the spark plug to the spark plug cap.
 - Pour a tablespoon (15 – 20 cc) of clean engine oil into the cylinder and cover the spark plug hole with a piece of cloth.
 - With the engine stop switch in the RUN () position, press the start button several times to crank the engine and distribute the oil.
 - Reinstall the spark plug and spark plug cap.
6. Remove the battery and charge it fully. Store it in an area protected from freezing temperatures and direct sunlight. Slow charge the battery (page 146) once a month.

WARNING

The battery gives off explosive hydrogen gas during normal operation.

A spark or flame can cause the battery to explode with enough force to kill or seriously hurt you.

Wear protective clothing and a face shield, or have a skilled mechanic do the battery maintenance.

7. Wash and dry your ATV. Wax all painted surfaces.
8. Lubricate the drive chain (page 140).



Storing Your Honda

9. Inflate the tires to their recommended pressures (page 128).
10. Store your ATV in an unheated area, free of dampness, away from sunlight, with a minimum of daily temperature variation.
11. Place your ATV on blocks to lift all tires off the floor.
12. Cover your ATV with a porous material. Avoid using plastic or similar non-breathing, coated materials that restrict air flow and allow heat and moisture to accumulate.

Removal from Storage

Refer to *Safety Precautions* on page 84 .

1. Uncover and clean your ATV.
2. If your ATV has been stored for more than four months — change the engine oil (page 103).
3. If your ATV has been stored for more than two months — ask your Honda dealer to drain and replace the fuel.
4. Charge the battery (page 146) as required. Install the battery.
5. Lubricate the drive chain (page 140).
6. Perform a pre-ride inspection (page 36), then test-ride your ATV at low speeds.

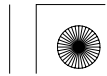



You & the Environment

Owning and riding an ATV can be enjoyable, but you must do your part to protect nature. When you show respect for the land, wildlife, and other people, you also help preserve the sport of off-road riding.

Following are tips on how you can be an environmentally responsible ATV owner.

- **Tread Lightly.** Stay on existing roads and trails, avoid surfaces that are easily damaged, and ride only in areas approved for off-road vehicles.
- **Keep the Noise Down.** Loud vehicles can be offensive. Ride as quietly as possible, don't remove your spark arrester, and don't modify the muffler or any other part of your air intake and exhaust systems. Such modifications not only increase noise, they also reduce engine performance and may be illegal.
- **Choose Sensible Cleaners.** Use a biodegradable detergent when you wash your ATV. Avoid aerosol spray cleaners that contain chlorofluorocarbons (CFCs) which damage the atmosphere's protective ozone layer. Don't throw cleaning solvents away; see the following guidelines for proper disposal.
- **Recycle Wastes.** It's illegal and thoughtless to put used engine oil in the trash, down a drain, or on the ground. Used oil, gasoline, and cleaning solvents contain poisons that can hurt refuse workers and contaminate our drinking water, lakes, rivers, and oceans. Before changing your oil, make sure you have the proper containers. Put oil and other toxic wastes in separate sealed containers and take them to a recycling center. Call your local or state office of public works or environmental services to find a recycling center in your area, and to get instructions on how to dispose of non-recyclable wastes.





Taking Care of the Unexpected

With all the challenges you can encounter off-road, there's a chance that sometime something may go wrong. This section gives practical advice to help you deal with a wide range of problems. Take time to read this section before you ride. Also review the tips in *Preparing for a Ride* (page 152).

- General Guidelines..... 162
- If Your Engine Quits or Won't Start..... 164
- If You Have a Flat Tire 167
- If a Fuse Blows 171
- If You Crash..... 174
- If You Lose Your Key 175
- If the Battery Is Low (or Dead) 176
- If a Component Fails..... 177





Taking Care of the Unexpected

General Guidelines

Keeping your ATV well-maintained is the best way to reduce the possibility of having a problem while riding. However, problems can arise even with well-maintained machines.

Remember to take along your owner's manual, the tool kit that came with your ATV, and any other items (such as tire repair supplies and additional tools) that might help you solve a problem on your own.

If something goes wrong during a ride, the first thing to do is stop as soon as you safely can. Do not continue riding if you have a flat tire, or you hear an unusual noise, or your ATV just doesn't feel right. If you continue riding, you could cause more damage and endanger your own safety.

After stopping, take time to assess the situation. Carefully inspect your ATV to identify the problem, then consider your options before you decide what to do.

If a problem is relatively minor and you have the tools, supplies, and skills to make a permanent repair, you may be able to fix it on the trail and continue riding. Or, you may be able to make a temporary repair that allows you to slowly ride back to your base where you can make a permanent repair or get help.

When a problem is more serious — or you don't have the tools, supplies, experience, or time to deal with it — you need to choose the safest way to get yourself and your ATV back to base. For example, if you are close enough, you (or you and another person) might be able to push it back.

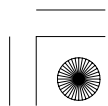



Taking Care of the Unexpected

Should you ever have a problem while riding, please follow these guidelines:

- Always put personal safety first.
- Take time to assess the situation and your options before deciding what to do.
- If the problem is relatively minor and you have the tools, supplies, and skills to make a temporary repair, be sure to have permanent repairs made as soon as possible.
- Do not continue riding if you are hurt or your ATV is not in safe riding condition.

Additional recommendations for specific problems follow.

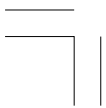

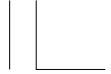

If Your Engine Quits or Won't Start

Proper operation and maintenance can prevent starting and engine performance problems. In many cases, the cause of the problem may be a simple operational oversight.

If you have a problem starting the engine—or experience poor engine performance—the following information may help you. If you can't correct the problem, see your Honda dealer.

If your ATV won't start, listen as you press the start button. If you don't hear the starter motor turning, refer to the *Starter motor doesn't operate* symptom. If you can hear the starter motor working normally, refer to the *Starter motor works, but the engine won't start* symptom.

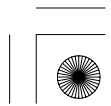



If Your Engine Quits or Won't Start

SYMPTOM: Starter motor doesn't operate.	
POSSIBLE CAUSE	WHAT TO DO
ignition switch OFF	Turn the ignition switch ON.
transmission not in neutral	Shift into neutral.
blown fuse	Replace with a new fuse of the same rating (page 171).
battery lead loose	Tighten the battery lead.
low (or dead) battery	Charge the battery (page 146). If charging doesn't help, see your Honda dealer.
faulty starter motor	If all possible causes are negative, the starter motor may be faulty. See your Honda dealer.



SYMPTOM: Starter motor works, but the engine won't start.	
POSSIBLE CAUSE	WHAT TO DO
engine stop switch OFF	Turn the engine stop switch to RUN.
out of fuel	Fill the fuel tank.
flooded engine	See <i>Flooded Engine</i> (page 59).
loose or unconnected spark plug cap	Install the spark plug cap securely. If the engine still won't start, see your Honda dealer.
loose battery cables	Tighten the battery terminal bolts.
weak battery	Charge the battery (page 146). If charging doesn't help, see your Honda dealer.

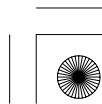
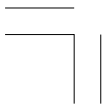



If Your Engine Quits or Won't Start

SYMPTOM: Engine starts, but runs poorly.	
POSSIBLE CAUSE	WHAT TO DO
idles roughly, too fast, stalls	Check engine idle adjustment (page 112). If the problem persists, see your Honda dealer.
poor engine performance at altitudes above 3,000 feet.	Ask your Honda dealer to modify the carburetion with a high altitude jet. Refer to <i>High Altitude Carburetor Adjustment</i> , page 186.
runs erratically, misfires	See your Honda dealer.
blubbers (rich fuel mixture)	See your Honda dealer.
sooty exhaust (rich fuel mixture)	See your Honda dealer.
detonates or pings under load	If applicable, switch to the recommended octane gasoline (page 96) or change your brand of gasoline. If the problem persists, see your Honda dealer.
afterfires (backfires)	See your Honda dealer.
pre-ignition (runs on after ignition switched OFF)	See your Honda dealer.





If You Have a Flat Tire

How you handle a flat tire on the trail depends on how serious the tire damage is, and what tools and supplies you have with you.

If you have a slow leak or a minor puncture, use the plug method to make a temporary repair. (The plug method is applied from the outside of the tire and is the same as that for conventional tubeless tires.)

A plug-type repair kit, available at most auto parts stores or service stations, provides a plug, an installation tool, tire cement, and an instruction sheet. Follow the instructions provided with the repair kit to make a temporary repair.

As soon as possible, have the tire permanently repaired by your Honda dealer. Any tire that cannot be repaired should be replaced.



Whenever the ATV is to be operated far from service facilities or available transportation, we recommend that you carry a tire pump and a repair kit.



If the leak is more serious, or a temporary repair doesn't hold, the tire must be replaced. The tire will also need to be replaced if it is damaged (page 131). Replacing a tire involves removing and re-installing the wheel (page 169).

If you are unable to repair a flat tire on the trail, you will need to send for help. We strongly recommend that you do not try to ride with a flat tire. The ATV will be hard to handle, and if the tire comes off the rim, it may lock up the wheel and cause you to crash.

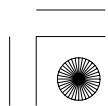
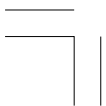



If You Have a Flat Tire

WARNING

Riding your ATV with a temporary tire repair can be risky.

If the temporary repair fails, you can crash and be seriously injured or killed. If you must ride with a temporary tire repair, ride slowly and carefully until the tire is permanently repaired or replaced.

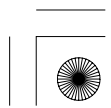



If You Have a Flat Tire

Emergency Wheel Removal/Installation

Refer to *Safety Precautions* on page 84 .

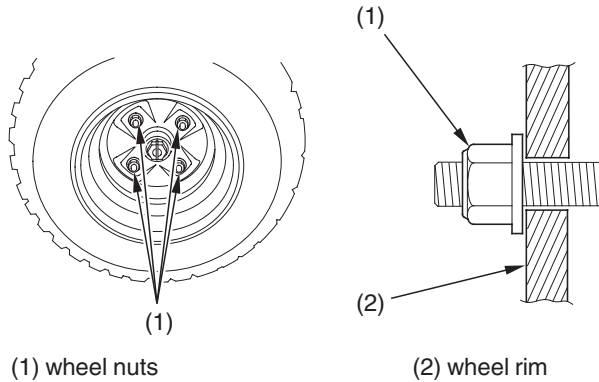

Removal

1. Park your ATV on a firm, level surface.
2. Loosen — but do not remove — the wheel nuts (1).
3. Raise the front (or rear) wheels off the ground and place a support block under the vehicle.
4. Remove the wheel nuts.
5. Remove the wheel.



If You Have a Flat Tire

Installation

1. Position the wheel.
2. Position the wheel nuts.
3. Hand-tighten the wheel nuts on the wheel, then lower the ATV to the ground before tightening the nuts in a crisscross (rather than circular) pattern to the specified torque:
40 lbf·ft (54 N·m , 5.5 kgf·m)

If a torque wrench was not used for installation, see your Honda dealer as soon as possible to verify proper assembly. Improper assembly may lead to loss of braking capability.





If a Fuse Blows

All of the electrical circuits on your ATV have fuses to protect them from damage caused by excess current flow (short circuit or overload).

If something electrical on your ATV stops working, the first thing you should check for is a blown fuse (1).

Check the fuse before looking elsewhere for another possible cause of the problem. Replace a blown fuse and check component operation.

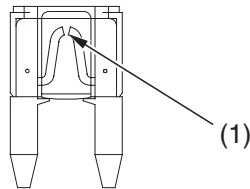

(1) blown fuse



The fuse is located next to the air cleaner case cover behind the seat.

Recommended Fuses

main fuse	7.5A
-----------	------

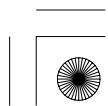
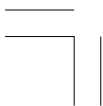



If a Fuse Blows

Main Fuse Access

UNDER SEAT

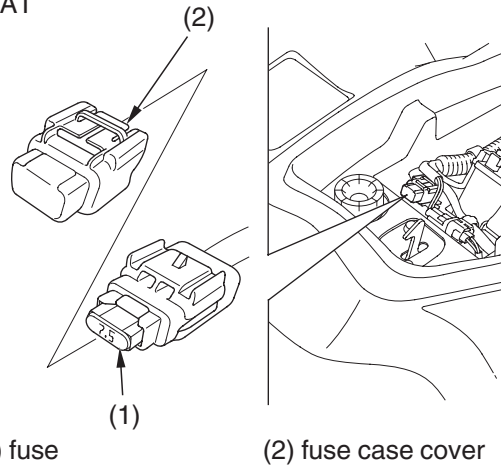

1. To prevent an accidental short circuit, turn the ignition switch OFF (\circ) before checking or replacing the fuse.
2. To access the fuse (1), remove the seat (page 95).
3. Remove the fuse case cover (2).

172 Taking Care of the Unexpected





If a Fuse Blows

4. Replace the old fuse.

If you do not have a replacement fuse with the proper rating for the circuit, install one with a lower rating.

NOTICE

Replacing a fuse with one that has a higher rating greatly increases the chance of damage to the electrical system.

5. Reinstall the fuse case cover.

6. Install the seat.

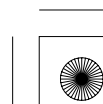
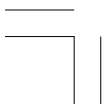



If You Crash

Personal safety is your first priority after a crash. If you or anyone else has been injured, take time to assess the severity of the injuries and whether it is safe to continue riding. If you cannot ride safely, send someone for help. Do not ride if you will risk further injury.

If you decide you are capable of riding safely, carefully inspect your ATV for damage and determine if it is safe to ride. Check the tightness of critical nuts and bolts securing such parts as the handlebar, control levers, brakes, and wheels.

If there is minor damage, or you are unsure about possible damage but decide to try riding the ATV back to your base, ride slowly and cautiously.

Sometimes, crash damage is hidden or not immediately apparent. When you get home, thoroughly check your ATV and correct any problems you find. Also, be sure to have your Honda dealer check the frame and suspension after any serious crash.

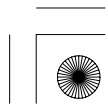



If You Lose Your Key

Be sure to record your key number (1) in the Quick Reference section at the rear of the manual. You'll need this number to have a duplicate key made.

If you lose your key and aren't carrying a duplicate, either get your spare or have one made. If you don't know your key number, call the dealer where you purchased your Honda ATV. They may have it listed in their records. If they don't, transport your ATV to them or the nearest Honda dealer. The dealer will probably have to remove the ignition switch assembly to find the key number so they can make a key for you.

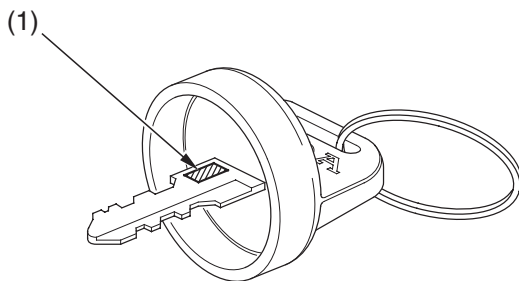

(1) key number

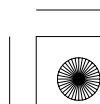
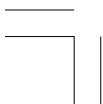



If the Battery Is Low (or Dead)

Jump starting is not recommended, especially if you use an automobile battery. The greater amperage of an automobile battery when the car engine is running can damage your ATV's electrical system.

Bump starting is also not recommended.

If you can't charge the battery or it appears unable to hold a charge, contact your Honda dealer.





If a Component Fails

The brake levers or pedal, control cables, and other components can be damaged as you ride in dense brush or over rocky terrain. Making a trailside repair depends on how serious the damage is and what tools and supplies you have with you.

- If any component of the brake system is damaged, you may be able to ride carefully back to your base using the other brake components for slowing or stopping.
- If you damage a throttle cable or other critical component, your ATV may be unsafe to ride. Carefully assess the damage and make any repairs that you can. But if there is any doubt, it's best to be conservative and safe.





08/09/25 13:32:40 31HP2630 0187



178 Taking Care of the Unexpected

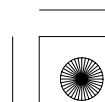
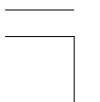



Technical Information

This section contains dimensions, capacities, and other technical data, plus information on government requirements and how to break-in your ATV.

Vehicle Identification.....	180
Specifications.....	182
Break-in Guidelines	185
High Altitude Carburetor Adjustment.....	186
Emission Control Systems.....	187
Oxygenated Fuels.....	191

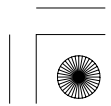



Vehicle Identification

Serial Numbers

The VIN, engine serial number, and key number may be required when ordering replacement parts. You may record these numbers in the Quick Reference section at the rear of this manual.

The VIN (1) is stamped on the front of the frame.

FRONT

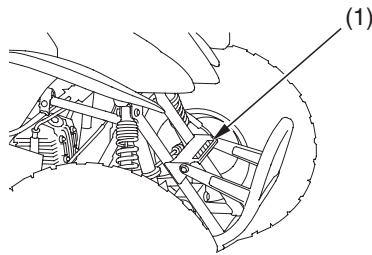

(1) VIN

The engine number (2) is stamped on the lower side of the rear crankcase.

LEFT SIDE

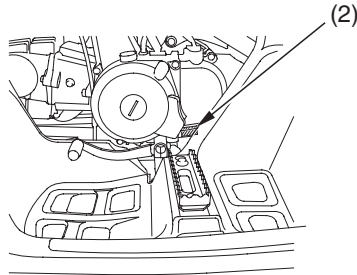

(2) engine number

180 Technical Information

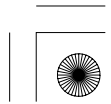
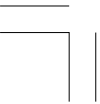



Vehicle Identification

Color Label & Code

The color label (1) is attached to the frame under the seat. Remove the seat (page 95) to check the label.

The color code is helpful when ordering replacement parts. You may record the color and code in the Quick Reference section at the rear of this manual.

UNDER SEAT

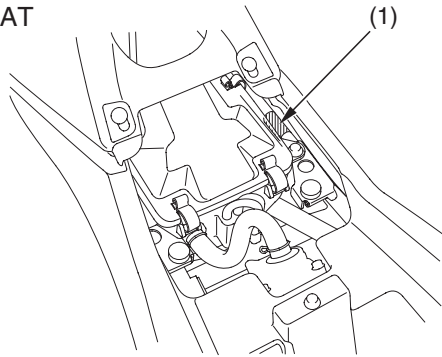

(1) color label

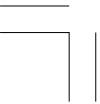



Specifications

Dimensions	
overall length	58.6 in (1,489 mm)
overall width	35.2 in (895 mm)
overall height	36.5 in (928 mm)
wheelbase	38.7 in (983 mm)
ground clearance	3.9 in (100 mm)

Fuel & Lubricants	
fuel recommendation	unleaded gasoline, pump octane number of 86 or higher
fuel tank capacity	1.66 US gal (6.3 ℓ) including reserve
fuel tank reserve	0.26 US gal (1.0 ℓ)
engine oil capacity	after disassembly: 1.0 US qt (0.9 ℓ) after draining: 0.7 US qt (0.7 ℓ)
engine oil recommendation	API Service Classification SG or higher except oils labeled as energy conserving on the circular API service label, SAE 10W-30, JASO T 903 standard MA, Pro Honda GN4 4-stroke oil (USA & Canada) or Honda 4-stroke oil (Canada only), or an equivalent motorcycle oil

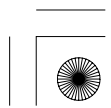



Specifications

Capacities	
passenger capacity	operator only
maximum weight capacity	187 lbs (85 kg) rider and all accessories

Engine Specifications	
displacement	5.2 cu-in (86 cm ³)
bore & stroke	1.85 × 1.95 in (47 × 49.5 mm)
compression ratio	9.2 : 1
spark plug (standard)	CR7HSA (NGK) or U22FSR-U (DENSO)
spark plug (cold climate)	CR6HSA (NGK) or U20FSR-U (DENSO)
spark plug (high speed riding)	CR8HSA (NGK) or U24FSR-U (DENSO)
spark plug gap	0.024 – 0.028 in (0.60 – 0.70 mm)
valve clearance (cold)	0.002 in (0.05 mm)
idle speed	1,600 ± 100 rpm

Power Transmission		
primary reduction	4.058	
final reduction	3.846	
gear ratio	1st	2.833
	2nd	1.937
	3rd	1.300
	4th	0.958
final drive	chain DID 428V-98LE or RK428 HOZ1-98LE	





Specifications

Chassis & Suspension	
caster	4°
trail	0.6 in (16 mm)
tire size, front	AT 20 × 7-8 ★ CHENG SHIN MAXXIS M953
tire size, rear	AT 19 × 8-8 ★ CHENG SHIN MAXXIS M954
tire pressure, front & rear (cold)	2.9 psi (20.0 kPa)

Electrical	
battery	12V – 4Ah
generator	0.056 kW/5,000 rpm

Lights	
neutral indicator lamp	12V – 3.4W

Fuse	
main	7.5A

Torque Specification	
oil drain bolt	17 lbf·ft (24 N·m , 2.4 kgf·m)
wheel nuts	40 lbf·ft (54 N·m , 5.5 kgf·m)





Break-in Guidelines

Help assure your ATV's future reliability and performance by paying extra attention to how you ride during the first operating day or 15 miles (25 km).

During this period, avoid full-throttle starts, rapid acceleration, and constant rpm operation.

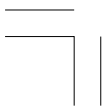



High Altitude Carburetor Adjustment

At high altitude, the standard carburetor air-fuel mixture will be too rich. Performance will decrease, and fuel consumption will increase. A very rich mixture will also foul the spark plug and cause hard starting. Operation at an altitude that differs from that at which this engine was certified, for extended periods of time, may increase emissions.

High altitude performance can be improved by specific modifications to the carburetor. If you always operate your engine at altitudes above 6,500 feet (2,000 meters), have your servicing dealer perform this carburetor modification. This engine, when operated at high altitude with the carburetor modifications for high altitude use, will meet each emission standard throughout its useful life.

Even with carburetor modification, engine horsepower will decrease about 3.5% for each 1,000-foot (300-meter) increase in altitude. The effect of altitude on horsepower will be greater than this if no carburetor modification is made.



NOTICE

When the carburetor has been modified for high altitude operation, the air-fuel mixture will be too lean for low altitude use. Operation at altitudes below 5,000 feet (1,500 meters) with a modified carburetor may cause the engine to overheat and result in serious engine damage. For use at low altitudes, have your servicing dealer return the carburetor to original factory specifications.





Emission Control Systems

Exhaust Emission Requirements

The U.S. Environmental Protection Agency (EPA), the California Air Resources Board (CARB), and Environment Canada (EC) require that your ATV comply with applicable exhaust emissions standards during its useful life, when operated and maintained according to the instructions provided.

The Vehicle Emission Control Information Label (1) (2) is attached on the front of the frame.

FRONT

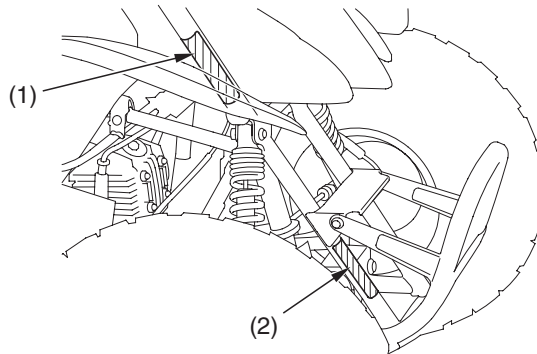

- (1) vehicle emission control information label
- (2) vehicle emission control information label (Canada only)



Emission Control Systems

Source of Exhaust Emissions

The combustion process produces carbon monoxide (CO), oxides of nitrogen (NO_x) and hydrocarbons (HC). Control of hydrocarbons and oxides of nitrogen is very important because, under certain conditions, they react to form photochemical smog when subjected to sunlight. Carbon monoxide does not react in the same way, but it is toxic.

Honda Motor Co., Ltd. utilizes various systems to reduce carbon monoxide, oxides of nitrogen and hydrocarbons.

Exhaust Emission Control System

The exhaust emission control system is composed of appropriate carburetor settings. No adjustments should be made except for an idle speed adjustment with the throttle stop screw or carburetor adjustment for high altitude operation.

The exhaust emission control system is separate from the crankcase emission control system.





Emission Control Systems

Crankcase Emission Control System

The engine is equipped with a closed crankcase system to prevent discharging crankcase emissions into the atmosphere. Blow-by gas is returned to the combustion chamber through the air cleaner and the carburetor.

Problems That May Affect ATV Exhaust Emissions

If you are aware of any of the following symptoms, have the vehicle inspected and repaired by your Honda ATV dealer.

Symptoms:

1. Hard starting or stalling after starting
2. Rough idle
3. Misfiring or backfiring during acceleration
4. After-burning (backfiring)
5. Poor performance (driveability) and poor fuel economy



Federal regulations prohibit removing or disabling a device or element of design that may affect your engine's emission performance unless your ATV will be used exclusively in competition. If you modify your engine for use in sanctioned competition events, you must deface or destroy the emission control information label.





Emission Control Systems

Noise Emission Control System

TAMPERING WITH THE NOISE CONTROL SYSTEM IS PROHIBITED:

State laws prohibit, or Canadian provincial laws may prohibit, the following acts or the causing thereof: (1) The removal or rendering inoperative by any person, other than for purposes of maintenance, repair or replacement, of any device or element of design incorporated into any new vehicle for the purpose of noise control prior to its sale or delivery to the ultimate purchaser or while it is in use; or (2) the use of the vehicle after such device or element of design has been removed or rendered inoperative by any person.

AMONG THOSE ACTS PRESUMED TO CONSTITUTE TAMPERING ARE THE FOLLOWING ACTS:

1. Removal of, or puncturing the muffler, baffles, header pipes or any other component which conducts exhaust gases.
2. Removal of, or puncturing of any part of the intake system.
3. Lack of proper maintenance.
4. Replacing any moving parts of the vehicle, or parts of the exhaust or intake system, with parts other than those specified by the manufacturer.



Fuel Permeation Emission Control System

This vehicle complies with the Fuel Permeation Emission Control regulations of the U.S. Environmental Protection Agency (EPA), the California Air Resources Board (CARB), and Environment Canada (EC).

The fuel tank, fuel hoses, and fuel vapor charge hoses used on this vehicle incorporate fuel permeation control technologies.

Tampering with the fuel tank, fuel hoses, or fuel vapor charge hoses to reduce or defeat the effectiveness of the fuel permeation technologies is prohibited by federal regulations.

190 Technical Information

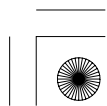
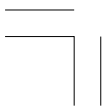



Oxygenated Fuels

Some conventional gasolines are being blended with alcohol or an ether compound. These gasolines are collectively referred to as oxygenated fuels. To meet clean air standards, some areas of the United States and Canada use oxygenated fuels to help reduce emissions.

If you use an oxygenated fuel, be sure it is unleaded and meets the minimum octane rating requirement.

Before using an oxygenated fuel, try to confirm the fuel's contents.

Some states/provinces require this information to be posted on the pump.

The following are the EPA-approved percentages of oxygenates:

ETHANOL (ethyl or grain alcohol) 10% by volume

You may use gasoline containing up to 10% ethanol by volume.

Gasoline containing ethanol may be marketed under the name "Gasohol".

MTBE (Methyl Tertiary Butyl Ether) 15% by Volume

You may use gasoline containing up to 15% MTBE by volume.

METHANOL (methyl or wood alcohol) 5% by Volume

You may use gasoline containing methanol containing up to 5% methanol by volume as long as it also contains cosolvents and corrosion inhibitors to protect the fuel system. Gasoline containing more than 5% methanol by volume may cause starting and/or performance problems. It may also damage metal, rubber, and plastic parts of your fuel system.



Oxygenated Fuels

If you notice any undesirable operating symptoms, try another service station or switch to another brand of gasoline.

Fuel system damage or performance problems resulting from the use of an oxygenated fuel containing more than the percentages of oxygenates mentioned above are not covered under warranty.

Oxygenated fuels can damage paint and plastic. Be careful not to spill fuel when filling the fuel tank. Wipe up any spills immediately.

NOTICE

Oxygenated fuels can damage paint and plastic. Damage caused by spilled fuel is not covered by warranty.

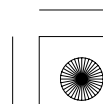
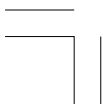



Consumer Information

This section contains information on your warranty and how to get an official Honda service manual.

Authorized Manuals	194
Warranty Coverage	197
Warranty Service.....	198
Contacting Honda	199
Your Honda Dealer	200
The Honda Rider's Club (USA only).....	201

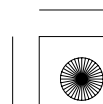



Authorized Manuals

The Service Manual used by your authorized Honda dealer is available from Helm, Inc. (USA only, Canada: See your Honda dealer to order authorized manuals.)

Also available but not necessary to service your model is the Honda Common Service Manual which explains theory of operation and basic service information for various systems common to all Honda motorcycles, motor scooters and ATVs.

These Honda manuals are written for the professional technician, but most mechanically capable owners should find them easy to use if they have the proper tools and observe proper safety standards. Special Honda tools are necessary for some procedures.

Publication Item No.	Description	Price Each*
61HP203	2009 TRX90X Service Manual	\$32.00
61CM002	Common Service Manual	\$48.00
31HP2630	2009 TRX90X Owner's Manual	\$16.00

** Prices are subject to change without notice and without incurring obligation.*



Order On-Line: www.helminc.com

Order Toll Free: 1-888-CYCLE93 (1-888-292-5393)

(NOTE: For Credit Card Orders Only)

Monday — Friday 8:00 AM — 6:00 PM EST

OR

By completing this form you can order the materials desired. You can pay by check or money order, or charge to your credit card. Mail to Helm, Inc. at the address shown on the back of this order form (USA only).

Canada: See your Honda dealer to order authorized manuals.

Publication Item No.	Item Description	Qty.	Price Each*	Total Price
*Prices are subject to change without notice and without incurring obligation. Orders are mailed within 10 days. Please allow adequate time for delivery.			Sub Total	
			Purchaser's Sales Tax	
			Mich. add 6 %	
			Calif. add 7.25 %	
			Handling Charge	\$3.75
			Grand Total	

Consumer Information 195



08/09/25 13:35:10 31HP2630 0205



**S
H
I
P
T
O**

NOTE: Dealers and Companies please provide dealer or company name, and also the name of the person to whose attention the shipment should be sent.

Customer Name _____

Attention _____

Street address/P. O. BOX _____ Apartment Number _____

City _____ State _____ Zip Code _____

Daytime Telephone Number () _____



**P
A
Y
M
E
N
T**

Check or money order enclosed payable to Helm Inc. U. S. funds only. Do not send cash.

Check here if your billing address is different from the shipping address shown above.

VISA MasterCard Discover

Account Number Expiration: Mo. Yr. -

Security Code

Customer Signature _____ Date _____



These Publications cannot be returned for credit without receiving advance authorization within 14 days of delivery. For returns, a restocking fee may be applied against the original order.

HELM P. O. BOX 07280, DETROIT, MICHIGAN 48207

196 Consumer Information

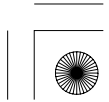



Warranty Coverage

Your new Honda is covered by these warranties:

- TRX Limited Warranty
- Emission Control System Warranty

There are responsibilities, restrictions, and exclusions which apply to these warranties. Please read the Warranties Booklet given to you by your Honda dealer at the time of purchase. Be sure to keep your Honda owner's card with your Warranties Booklet (USA only).

It is important to realize that your warranty applies to defects in material or workmanship of your Honda. Your warranty coverage does not apply to normal wear or deterioration associated with using the ATV.

Your warranty coverage will not be voided if you choose to perform your own maintenance. However, you should have the proper tools and service information, and be mechanically qualified. Failures that occur due directly to improper maintenance are not covered.

Almost all of your warranty coverage can be extended through the Honda Protection Plan (USA only). For more information, see your Honda dealer.



Warranty Service

Please remember that recommended maintenance interval servicing is not included in your warranty coverage. Additionally, your warranty does not apply to the normal wear of items (such as brakes, tires, etc.).

If you believe you have a problem with your ATV, call the service department of your Honda dealer. Make an appointment for an inspection and diagnosis. Remember, as the owner of the ATV, you will be asked to authorize that inspection. Your dealer will give you the results of the inspection. If the problem is covered under warranty, your dealer will perform the warranty repairs for you.

If you have questions about warranty coverage or the nature of the repair, it is best to talk to the Service Manager of your Honda dealer.

Sometimes, in spite of the best intentions of all concerned, a misunderstanding may occur. If you aren't satisfied with your dealer's handling of the situation, we suggest you discuss your problem with the appropriate member of the dealership's management team. If the problem has already been reviewed with the Service Manager, Parts Manager, Sales Manager, etc., contact the Owner of the dealership or their designated representative.

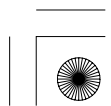
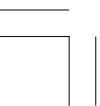



Contacting Honda

Your owner's manual was written to cover most of the questions you might ask about your Honda. Any questions not answered in the owner's manual can be answered by your Honda dealer. If your dealer doesn't have the answer right away, they will get it for you.

If you have a difference of opinion with your dealer, please remember that each dealership is independently owned and operated. That's why it's important to work to resolve any differences at the dealership level.

If you wish to comment on your experiences with your Honda or with your dealer, please send your comments to the following address (USA only):

Motorcycle Division, American Honda Motor Co., Inc., P.O. Box 2200, Torrance, CA 90509-2200, mailstop: 100-4C-7B, telephone: (866) 784-1870.



Canada: Refer to the Warranties Booklet that was supplied with your vehicle.



Please include the following information in your letter:

- name, address, and telephone number
- product model, year, and VIN
- date of purchase
- dealer name and address

We will likely ask your Honda dealer to respond, or possibly acknowledge your comments directly.

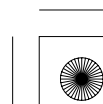
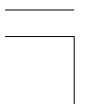



Your Honda Dealer

Once you purchase your new Honda, get familiar with the organization of your Honda dealer so you can utilize the full range of services available.

The service department is there to perform regular maintenance and unexpected repairs. It has the latest available service information from Honda. The service department will also handle warranty inspections and repairs.

The parts department offers Honda Genuine Parts, Pro Honda products, Honda Genuine Accessories (USA only), and Honda accessories and products (Canada only). The same quality that went into your Honda can be found in Honda Genuine replacement parts. You'll also find comparable quality in the accessories and products available from the parts department.



The sales department offers the Honda Protection Plan to extend almost all of your warranty coverage (USA only).



Your Honda dealer can inform you about competition and other riding events in your area. You'll also find that your dealer is a source of information about safety training available in your local area and the Honda Rider's Club of America (USA only).

We're sure you'll be as pleased with the service your Honda dealer continues to provide after the sale as you are with the quality and dependability of your Honda.

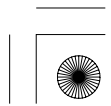



The Honda Rider's Club (USA only)

You may be eligible for a Honda Rider's Club of America (HRCA) membership with the purchase of your new Honda. You can log on to the HRCA Clubhouse website for details at www.hrca.honda.com.

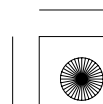
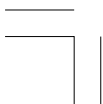



Table of Contents

The following presents the contents of each section of your owner’s manual.

ATV SAFETY	1
Important Safety Information	2
Important Message to Parents	5
Safety Labels.....	9
INDICATOR & CONTROLS.....	13
Operation Component Locations	14
Indicator	17
Neutral Indicator	17
Controls & Features	18
Fuel Valve	18
Choke Lever.....	19
Ignition Switch.....	20
Start button.....	21
Engine Stop Switch.....	22
Throttle lever.....	23
Front Brake Lever	24
Rear Brake Lever	24
Rear Brake Pedal.....	25
Parking Brake.....	26
Flag Pole Bracket	27

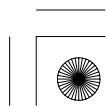



Table of Contents

BEFORE RIDING	29
Are You Ready to Ride ?	30
Protective Apparel.....	30
Rider Training	32
Age Recommendation	33
No Passengers	33
No Alcohol or Drugs.....	34
Is Your ATV Ready to Ride ?.....	35
Pre-ride Inspection	36
Load Limits & Guidelines.....	38
Loading	38
Load Limits	39
Loading Guidelines	39
Accessories & Modifications	40
Accessories.....	40
Modifications	41

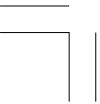



Table of Contents

BASIC OPERATION & RIDING	43
Safe Riding Precautions	45
Speed Restrictors for New Riders	45
Off-road Use Only	49
Keep Hands and Feet on Controls.....	50
Control Speed.....	51
Use care on Unfamiliar or Rough Terrain.....	52
Do Not Perform Stunts.....	54
Ride Only When Visibility Is Good	54
Starting & Stopping the Engine	55
Preparation	55
Starting Procedure.....	56
Flooded Engine	59
How to Stop the Engine	59
Shifting Gears	60
Braking.....	63
Riding Your ATV	66
Making Turns.....	66
Skidding or Sliding	68
Riding Up Hills	69
Riding Down Hills	73
Crossing or Turning on Hills or Slopes.....	74
Riding Over Obstacles	76
Riding Through Water	77
Parking	78

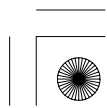



Table of Contents

SERVICING YOUR HONDA.....	79
<i>Before You Service Your Honda</i>	
The Importance of Maintenance	81
Maintenance Safety	83
Important Safety Precautions	84
Maintenance Schedule	85
Maintenance Record.....	89
 <i>Service Preparations</i>	
Maintenance Component Locations	90
Tool Kit.....	93
Owner's Manual Storage.....	94
Seat Removal	95
 <i>Service Procedures</i>	
<u>Fluids & Filters</u>	
Fuel	96
Engine oil	99
Air Cleaner.....	105
 <u>Engine</u>	
Throttle.....	109
Clutch System	111
Engine Idle Speed	112
Spark Plug	113
Valves.....	116
Spark Arrester	117

(cont'd)

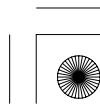
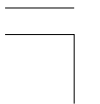



Table of Contents

Chassis
 Brakes..... 118
 Tires 126
 Skid Plates..... 133
 Drive Chain..... 134

Electrical
 Battery..... 142

Appearance Care 147

TIPS..... 151

Preparing for a Ride 152
 What to Take to The Riding Area 152
 What to Take on The Trail 153
 Transporting Your Honda 154
 Storing Your Honda 156
 Preparation for Storage 157
 Removal from Storage 159
 You & the Environment..... 160

TAKING CARE OF THE UNEXPECTED..... 161

General Guidelines..... 162
 If Your Engine Quits or Won't Start..... 164
 If You Have a Flat Tire 167
 If a Fuse Blows 171
 If You Crash..... 174
 If You Lose Your Key 175
 If the Battery Is Low (or Dead) 176
 If a Component Fails..... 177

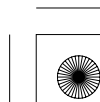
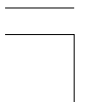
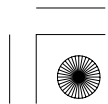
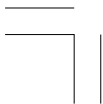



Table of Contents

TECHNICAL INFORMATION.....	179
Vehicle Identification.....	180
Specifications.....	182
Break-in Guidelines.....	185
High Altitude Carburetor Adjustment.....	186
Emission Control Systems.....	187
Oxygenated Fuels.....	191
CONSUMER INFORMATION.....	193
Authorized Manuals.....	194
Warranty Coverage.....	197
Warranty Service.....	198
Contacting Honda.....	199
Your Honda Dealer.....	200
The Honda Rider's Club (USA only).....	201
TABLE OF CONTENTS.....	202
INDEX.....	208
QUICK REFERENCE	





Index

A

accessories..... 40
age recommendation 33
air cleaner,
 filter..... 105
air pressure,
 gauge 93
 tire 127
altitude, high..... 186
American Honda, contacting..... 199
apparel, protective 30
appearance care 147
authorized manuals..... 194

B

Battery..... 142
Brakes,
 cables..... 123
 draining water from..... 125
 front brake lever..... 24
 front brake lever freeplay..... 118
 parking 26
 rear brake lever.....24
 rear brake lever freeplay 122
 rear brake pedal..... 25
 rear brake pedal freeplay..... 120
 shoe wear..... 124
braking 63
break-in guidelines 185

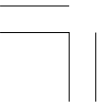



Index

C

capacity, fuel..... 97

carburetor, altitude adjustment..... 186

care, appearance..... 147

choke lever..... 19

cleaning, appearance care..... 149

climbing hills..... 69

clutch system..... 111

color label..... 181

compartment,
 owner's manual..... 94
 tool kit..... 93

component fails..... 177

consumer information..... 193

crash, if you..... 174

crossing or turning on hills or slopes..... 74

customer service..... 199





Index

D

drive chain..... 134

E

emission control system 187

engine

 flooded 59

 idle speed..... 112

 number 180

 oil 99

 pinging 96

 starting..... 55

 stop switch..... 22

 stopping 59

 won't start 164

environment 160

exhaust system

 cleaning 36

 purging 117





Index

F

flag pole bracket.....27

flat tire..... 167

flooded engine..... 59

fuel,

 fill cap 97

 high altitude fuel mixture adjustment..... 186

 oxygenated 191

 recommendation..... 96

 refueling 97

 reserve fuel supply 97

 tank capacity 97

 valve..... 18

fuse..... 171

G

gap, spark plug 114

gasohol 191

gasoline 96

gear shifting 60



Index

H

high altitude carburetor adjustment..... 186

hills,

- crossing or turning on slopes..... 74
- riding down hills 73
- riding up hills 69
- stopping on hills 71

Honda,

- contacting 199
- Rider's Club 201
- dealer 200

Honda service manual 194

I

identification, vehicle..... 180

idle speed, engine 112

ignition switch..... 20

indicator, neutral indicator 17

inspection, pre-ride..... 36

K

key,

- lost..... 175
- number 175

kit, tool 93

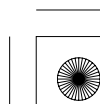
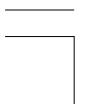



Index

L

labels, safety..... 9

limit, weight 39

load limits..... 39

loading guidelines 39

lubrication,
 engine oil..... 99

M

maintenance,
 component location 90

 importance..... 81

 precautions 84

 record 89

 safety 83

 schedule..... 85

manual, service.....194

maximum weight limit 39

modifications..... 41





Index

N

neutral indicator17
 noise emission control systems 190
 numbers, serial 180

O

obstacles, riding over 76
 oil, engine..... 99
 operating controls..... 18
 operation component location 14
 owner’s manual storage.....94
 oxygenated fuels 191

P

parking 78
 passenger, no carrying..... 33
 pavement, no riding on..... 49
 pinging, engine..... 96
 plug, spark..... 113
 pre-ride inspection..... 36
 problems, unexpected..... 161
 protective apparel 30





Index

R

removal, seat 95

rider training..... 32

Rider's Club, Honda..... 201

riding,

- basic operations 43
- clothing..... 30
- precautions 45
- preparing for 152
- over obstacles 76
- safety 2
- safety precautions..... 45
- through water 77

S

safety,

- important precautions..... 84
- labels 9
- riding precautions..... 45

schedule, maintenance..... 85

seat removal 95

serial numbers 180

service,

- customer 199
- manuals 194
- warranty 198

(cont'd)



Index

- shifting gears 60
- skid plates..... 133
- skidding or sliding..... 68
- spark arrester 117
- spark knock 96
- spark plug 113
- specifications..... 182
- speed restrictor 45
- stalling on a hill 71
- start button..... 21
- starting,
 - engine 55
 - troubleshooting..... 164
- stop switch, engine 22
- stopping engine 59
- storage,
 - ATV 156
 - owner's manual 94
- switch, ignition..... 20





Index

T

throttle,
 cable 109
 lever..... 23

tires,
 air pressure 127
 flat 167
 repairing 131
 replacing..... 132
 thread conditions 130

tool kit 93

training, rider 32

transporting your ATV 154

trouble, unexpected 161

troubleshooting, starting 164

turning,
 on level ground..... 66
 on hills or slopes..... 74

V

valve, fuel..... 18

valve clearance 116

vehicle identification no. (VIN) 180

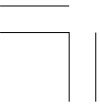



Index

W

warning labels 10

warranty,

- coverage 197
- extended 197
- service 198

washing your ATV 148

water,

- draining from brakes 125
- riding through 77

weight limit 39

wheel removal 169





08/09/25 13:36:59 31HP2630 0228



Memo 219

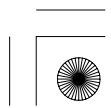
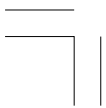



Quick Reference

The following is a brief, but important collection of information you need to know about your Honda. You'll also find space to record important notes.

How To Avoid Costly Repairs

The engine of your Honda can be the most expensive component to repair. Proper maintenance, especially the use of the recommended fluids and filters, prevents premature wear and damage.

Frequent causes of costly repairs are:

- Engine oil — insufficient quantity, improper oil.
- Air cleaner — dirty, leaking because of improper installation (poor seal).

Record important information on the following page:



Quick Reference

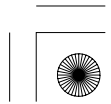



08/09/25 13:37:10 31HP2630 0230

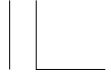

Quick Reference

Engine No.	
VIN	
Ignition Key No.	
Color Label	
Owner's Name	
Address	
City/State	
Phone	
Dealer's Name	
Address	
City/State	
Phone	
Service Mgr.	



Quick Reference

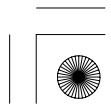
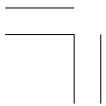



Quick Reference

Scheduled Maintenance	Initial: 100 miles (150 km) Regular: every 600 miles (1,000 km)
Pre-ride Inspection	Check the following items each time before you ride (page 36): engine oil, fuel, tires, drive chain, nuts & bolts, underbody & exhaust system, air cleaner housing drain tube, leaks, loose parts, cables, throttle, brakes, switches, steering.
Fuel/Capacity	unleaded gasoline, pump octane number 86 or higher 1.66 US gal (6.3 l) reserve: 0.26 US gal (1.0 l)
Engine Oil	API Service Classification SG or higher except oils labeled as energy conserving on the circular API service label, SAE 10W-30, JASO T 903 standard MA, Pro Honda GN4 4-stroke oil or equivalent
Maximum Weight Capacity	187 lbs (85 kg) rider and all accessories



Quick Reference

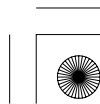



Quick Reference

Tires	Front: AT 20 × 7-8 ★ CHENG SHIN MAXXIS M953 Rear: AT 19 × 8-8 ★ CHENG SHIN MAXXIS M954
Tire Pressure (cold)	Front: 2.9 psi (20.0 kPa) Rear: 2.9 psi (20.0 kPa)
Spark Plugs	standard: CR7HSA (NGK) or U22FSR-U (DENSO) cold climate: CR6HSA (NGK) or U20FSR-U (DENSO) high speed riding: CR8HSA (NGK) or U24FSR-U (DENSO)
Fuse	main: 7.5A







Quick Reference





Quick Reference

These symbols are used in Controls & Features section:

SYMBOL	COMPONENT	SEE PAGE
	choke lever	19
	ON – ignition switch	20
	OFF – ignition switch	20
	START button	21
	RUN – engine stop switch	21
	OFF – engine stop switch	22



Quick Reference

