

2011 Civic Hybrid Navigation Manual (Unlinked)

This document does not contain hyperlinks and may be formatted for printing instead of web use. This is due to changes in content and specifications of the vehicle that happen throughout the model year. This manual will be replaced with a hyperlinked version at the end of the model year.

Introduction	4	Entering a Destination	22	By Address Book.....	43
Manual Overview	4	By Address	23	<i>Adding Addresses to the Personal</i>	
System Overview	4	<i>Selecting the State or Province</i>	23	<i>Address Book</i>	44
Accessories Precautions	5	<i>Selecting the City</i>	23	By Go Home.....	44
Important Safety Information.....	5	<i>Selecting the Street</i>	25		
Map Overview	6	<i>Entering the Street Number</i>	27	Driving to Your Destination	46
<i>Current Street</i>	6	By Intersection.....	27	Driving to Your Destination	46
<i>Verified/Unverified Street</i>	6	By Intersection.....	27	Calculate Route to Screen.....	46
		<i>Selecting the State or Province</i>	28	<i>Changing the Routing Method</i>	47
		<i>Selecting the City</i>	28	<i>Viewing the Routes</i>	48
		<i>Selecting the Street</i>	30	<i>Viewing the Destination Map</i>	49
		By Places	32	Map Screen	49
		<i>Finding the Place by Category</i>	33	<i>Route Line</i>	49
		<i>Finding the Place by Name</i>	36	<i>Guidance Prompts</i>	50
		<i>Finding the Place by Phone</i>		<i>Map Screen Legend</i>	51
		<i>Number</i>	37	Guidance Screen	52
		By Map Input.....	37	<i>Guidance Screen Legend</i>	52
		<i>Showing the Map of Current</i>		Distance and Time to	
		<i>Position</i>	37	Destination.....	53
		<i>Showing the Map of City</i>	39	Direction List	53
		<i>Showing the Map of State</i>	39	<i>Exit Info.</i>	
		<i>Showing the Map of Continental</i>		<i>(Freeway Exit Information)</i>	54
		<i>USA</i>	40	Guidance Mode.....	54
		By Previous Destinations.....	41	Map Scale	55
		By Today's Destinations	42	Map Orientation.....	56
		<i>Editing Today's Destinations List</i> ...	42	Destination Icon.....	56
		<i>Adding Destinations to the List</i>	42		
User Agreement	8				
Getting Started	10				
System Controls	10				
Voice Control Basics.....	12				
<i>Using the Voice Control System</i>	13				
<i>Improving Voice Recognition</i>	13				
Selecting an Item (Button) on the					
Screen	14				
Selecting an Item in a List.....	14				
Using the On-screen Keyboard	15				
System Start-up	16				
Bluetooth® HandsFreeLink®.....	18				
Map Screen Legend.....	19				
Map Screen Description	20				
<i>Zoom In/Out</i>	20				
<i>Map Scrolling</i>	20				
Displaying Current Location	20				
System Function Diagram	21				

Table of Contents

Landmark Icons	57
<i>Showing Icons on the Map</i>	59
<i>Icon Options</i>	59
Going Off the Route	61
Off-road Tracking.....	61
Viewing/Saving the Current Location.....	62
Pop-Ups and Disclaimers	63
Changing the Route	64
<i>Change Route By Screen</i>	64
<i>Waypoints</i>	64
<i>Reroute: Avoid Streets</i>	66
<i>Reroute: Detour</i>	66
<i>Reroute: Change Routing</i> <i>Method</i>	66
<i>Cancel Current Route</i>	67
<i>Back to Current Route</i>	67
Changing Your Destination.....	67
<i>Find Nearest (Voice command)</i>	67
<i>Go Home (Voice command)</i>	67
<i>Using Joystick to Change</i> <i>Destination</i>	67
<i>Entering a Destination from the Menu</i> <i>Screen (while en route)</i>	69
Continue Trip Screen.....	69

Information Features	70
Information Screen	70
Cellular Phonebook	70
Voice Command Help	70
Map Legend.....	71
Calendar.....	72
<i>Entering Your Schedule</i>	72
Calculator.....	73
<i>Unit Conversion</i>	74
System Setup	75
Setup Mode.....	75
Setup Screen (first)	75
<i>Brightness</i>	75
<i>Volume</i>	75
<i>Display</i>	76
<i>Guidance Prompts</i>	77
<i>Contrast</i>	77
Setup Screen (second)	78
Personal Information	78
<i>Address Book</i>	78
<i>Home Address</i>	82
<i>PIN Number</i>	82
<i>User Name</i>	83
<i>Previous Destinations</i>	83
Routing & Guidance	84
<i>Rerouting</i>	84
<i>Unverified Area Routing</i>	85

<i>Edit Avoid Area</i>	89
<i>Edit Waypoint Search Area</i>	91
<i>Guidance Mode</i>	92
Vehicle	92
<i>Off-road Tracking</i>	92
<i>Correct Vehicle Position</i>	93
System Information	94
Basic Settings.....	94
<i>Keyboard Layout</i>	94
<i>Units (mile or km)</i>	94
<i>Voice Recognition Feedback</i>	94
Clock Settings.....	95
<i>Clock Adjustment</i>	95
<i>Clock Type</i>	96
Color	97
<i>Map Color</i>	97
<i>Menu Color</i>	97
System Initialization	98
System Initialization	98
Entering the Security Code.....	98
GPS Initialization.....	99
Map Matching.....	99
System Limitations	100
Database Limitations.....	102

Customer Assistance104	Frequently Asked	Index 149
Reporting Errors 104	Questions 125	
Honda Automobile Customer	Troubleshooting..... 135	
Service 104	Glossary 137	
Visiting Your Dealer 105	Glossary 137	
Obtaining a Navigation Update	Voice Command Index..... 140	
DVD 105	Global Commands 140	
Changing the DVD 106	Navigation General	
PC Card Operation 107	Commands 140	
<i>Inserting the PC Card..... 107</i>	Navigation Display	
<i>Voice Control of PC Card</i>	Commands 141	
<i>Functions..... 107</i>	Find Place Commands 142	
CD/CD-R Operation..... 107	Climate Control Commands 143	
<i>Voice Control of CD Functions..... 108</i>	Temperature Voice	
Coverage Areas.....109	Commands 144	
Map Coverage 109	Radio Voice Commands 144	
<i>U.S. Detailed Coverage Areas..... 109</i>	CD Voice Commands 145	
<i>Canada Detailed Coverage</i>	PC Card Voice Commands 145	
<i>Areas 114</i>	AUX Voice Commands 145	
Operation in Alaska and	Information Screen Voice	
Hawaii 123	Commands 146	
Alaska 123	Setup Screen (first)	
Hawaii 123	Commands 146	
<i>Shipping a Vehicle To or From</i>	On-Screen Commands 147	
<i>Hawaii..... 124</i>	<i>On-Screen Commands Assist..... 147</i>	

Introduction

Manual Overview

The manual is divided into the following sections:

- Getting Started - A basic introduction that discusses the controls and how to communicate with the system.
- Entering a Destination - How to enter an address or locate a point of interest (POI).
- Driving to Your Destination - An explanation of the map features, guidance, and cautions.
- Information Features - Cellular Phonebook, Voice Command Help, Map Legend, Calendar, and Calculator.
- System Setup - How to set up and tailor the system for your personal use and use the Address Book.

The back of this manual contains:

- Map Coverage (page 109)
- Frequently Asked Questions (FAQs) (page 125)
- Troubleshooting Guide (page 135)
- Glossary of Terms (page 137)
- Voice Command List (page 140)
- Operation Specific to Alaska and Hawaii (page 123)

System Overview

Your navigation system is a highly sophisticated location system with voice control that uses satellites and a map database to show you where you are and to help guide you to a desired destination.

The navigation system receives signals from the global positioning system (GPS), a network of 24 satellites in orbit around the earth. By receiving signals from several of these satellites, the navigation system can determine the latitude, longitude, and elevation of your vehicle. In addition, a gyroscopic yaw sensor and a vehicle speed sensor in your vehicle keep track of the direction and speed of travel at all times.

NOTICE

This vehicle's navigation display, if so equipped, includes mercury-containing components. Upon removal, please reuse, recycle, or dispose of as hazardous waste.

The navigation system applies location, direction, and speed information to the maps and calculates a route to the destination you enter. As you drive to that destination, the system provides map and voice guidance.

The navigation system is easy to use. The locations of many places of business and entertainment are already entered in the system. You can select any of them as a destination by using the touch screen, joystick, or voice control.

There are several ways to enter a destination, such as by point of interest (POI), by address, by phone number, and by selecting it from the map. The last 50 destinations are saved for reuse at a later date. The system also allows you to store a home address to simplify returning home from your destination.

Accessories Precautions

If you have front or side window tinting installed, be aware that if the tint has metallic properties, it can seriously degrade or prevent GPS reception. This is because the GPS antenna is located under the dashboard.

If you plan to install electronic components, such as radar detectors, vehicle tracking devices, remote starters, additional amplifiers, or other audio components, ensure that they are not located near the navigation control unit under the dashboard, near the navigation screen in the dash, or near the GPS antenna under the dashboard. Signal noise emanating from these devices can cause intermittent disruption of the navigation system.

Important Safety Information

The navigation system can distract your attention from the road if you focus on the screen or operate the system's controls while driving.

Enter as much information as possible into the system before you begin driving, or when the vehicle is stopped. Then, as you drive, listen to the audio instructions and use voice commands when possible.

WARNING

Using the navigation system while driving can take your attention away from the road, causing a crash in which you could be seriously injured or killed.

Only operate system controls when the conditions permit you to safely do so.

While driving, do not look at the screen or operate the system controls for more than a second or so at a time, and only after deciding you can do so safely. Pull to the side of the road if you need more time to look at the screen or operate the controls.

The navigation system is designed to provide route information to help you reach your destination. However, this route guidance may sometimes conflict with current road conditions such as street closures, road construction, detours, and out-of-date map data.

Additionally, the system itself has certain limitations (see page 100). Therefore, you must verify the audio and visual route information provided by the system by carefully observing the roadway, signs and signals, etc. If you are unsure, proceed with caution. Always use your own good judgment, and obey traffic laws while driving.

Map Overview

Current Street

The current street on which your vehicle is located appears at the bottom of the map screen (see page 19). A message saying “Not on a digitized road” may appear instead when you drive half a mile away from a mapped road. For more details, see *Off-road Tracking* on page 61.

Verified/Unverified Street

Your navigation system has two kinds of streets: verified (dark colored) and unverified (light colored). The differences between the two types of streets are contrasted in the chart on page 7.



	Verified streets (dark colored)	Unverified streets (light colored)
When displayed	These roads are found within metropolitan areas, and include interstate freeways and major roads connecting cities.	These roads are found in rural areas, and typically include residential streets away from the center of a town.
Street color	Shown on daytime map screen as black or red, such as interstate freeways.	Shown on the daytime map screen as light brown.
Map quality	The database vendor has verified these streets. Information like turn restrictions, average speed, and whether it is a one-way street have been gathered and used when creating your route to a destination.	These streets have not been verified by the database vendor. The system does not contain information on one-way streets, turn restrictions, or the road's average speed. They are shown on the map for reference and may have errors in map location, naming, and address range.
Routing differences	While driving to your destination, the displayed route line is solid blue. The system provides voice and map guidance to your destination.	Your route line is either a blue dotted "vector line," or a dashed pink/blue line. For information on selecting this option, and the routing differences, see <i>Unverified Area Routing</i> on page 85.
Cautions	There are no pop-up boxes urging extra caution during a route. However, because roads constantly change, you are urged to use common sense, and always obey posted traffic restrictions.	Regardless of whether the user chooses route guidance, there are cautionary screens before and during the route urging the user to be extra cautious, and obey all traffic restrictions. See <i>Unverified Area Routing</i> on page 85.
Guidance voice	Voice guidance issues instructions such as "In a half-mile, make a right turn."	The phrase "if possible" is added to each guidance instruction. For example: "In a half-mile, make a right turn, if possible."
Time and distance "to go"	The time and distance "to go," displayed while en route to a destination, is based on the average speed and distance for the roads used for your route.	Because the average speed of these roads is not known, the time and distance "to go" is based on a fixed average speed of 25 mph for these roads.

User Agreement

In using this DVD “Satellite Linked Navigation System” (the “DVD”), which includes HONDA MOTOR CO., LTD. software, ALPINE ELECTRONICS, INC. software, NAVTEQ database contents, INFO USA CORPORATION database, and ZENRIN CO. database contents (hereinafter referred to as “Licensors”), you are bound by the terms and conditions set forth below. By using your copy of the DVD, you have expressed your Agreement to the terms and conditions of this Agreement. You should, therefore, make sure that you read and understand the following provisions. If for any reason you do not wish to be bound by the terms of this Agreement, please return the DVD to your dealer.

- The DVD may not be copied, duplicated, or otherwise modified, in whole or in part, without the express written permission of the Licensors.
- The DVD may not be transferred or sublicensed to any third party for profit, rent or loan, or licensed for reuse in any manner.
- The DVD may not be decompiled, reverse engineered or otherwise disassembled, in whole or in part.
- The DVD may not be used in a network or by any other manner of simultaneous use in multiple systems.
- The DVD is intended solely for personal use (or internal use where the end-user is a business) by the consumer. The DVD is not to be used for commercial purposes.
- The Licensors do not guarantee to the customer that the functions included in the DVD meet the specific objectives of the user.
- Licensor shall not be responsible for any damages caused by the use of the DVD to the actual user or to any third party.
- The warranty on the DVD shall not extend to an exchange or refund due to misspelling, omission of letters, or any other cosmetic discrepancy in the contents of the DVD.
- The right to use the DVD shall expire either when the user destroys the DVD or software, or when any of the terms of this Agreement are violated and the Licensors exercise the option to revoke the license to use the DVD or software.

- The terms and conditions hereof apply to all subsequent users and owners as well as to the original purchaser.
- The logos of oil companies, hotels, convenience stores, and other businesses are displayed for your information and convenience, and in no way imply any sponsorship, approval or endorsement of these companies, or their products. The logos are trademarks of their respective owners.

The user shall indemnify and save harmless the Licensors, and their officers, employees and agents, from and against any claim, demand or action, irrespective of the nature of the cause of the claim, demand or action, alleging loss, costs, expense, damages or injuries (including injuries resulting in death) arising out of the use or possession of the DVD or software.

Use, duplication, or disclosure of this DVD by or on behalf of the United States government is subject to “Restricted Rights” as set forth at FAR 52.227-14, -19 or DFARS 252.227-7013, as applicable. Manufacturers are the Licensors, including HONDA MOTOR CO., LTD., 2-1-1 Minami Aoyama Minato-Ku Tokyo 107-8556 JAPAN., Alpine Electronics, Inc., 20-1 Yoshima Kogyodanchi, Iwaki, Fukushima 970-1192 JAPAN., NAVTEQ Corporation, 222 Merchandise Mart, Suite 900, Chicago, IL, 60654, INFO USA CORPORATION, 5711 South 86th Circle, Omaha, NE 68127., and ZENRIN CO., LTD., 1-1-1 Muromachi, Kokurakita-ku, Kitakyushu, Fukuoka 803-8630, JAPAN.

Getting Started

System Controls

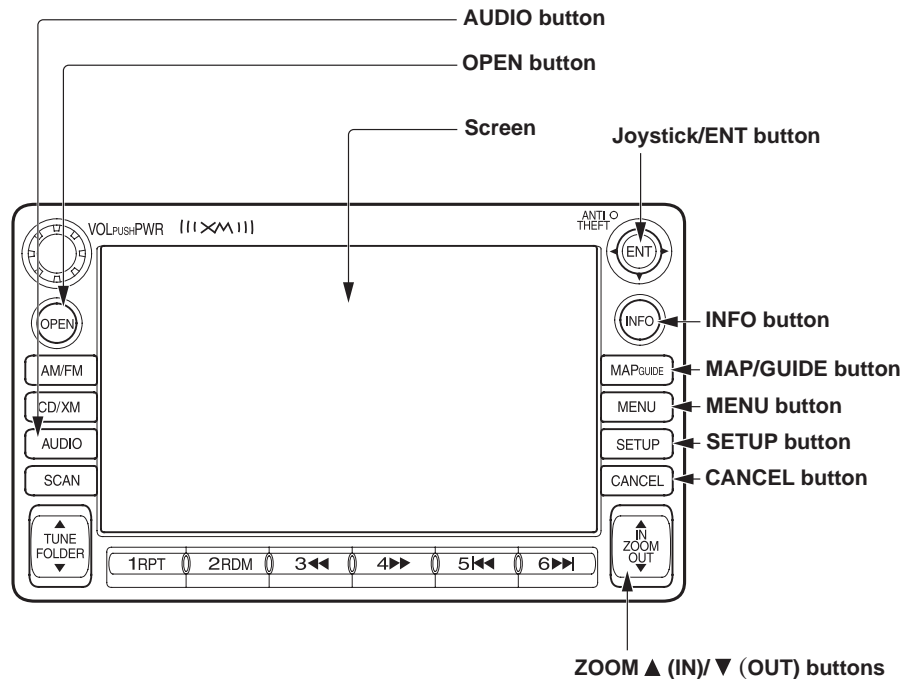

OPEN button

Tilts the screen down to access the CD, DVD, and PC Card slots.

CLOSE button

Return the screen to the original position.

Pressing the **OPEN** button tilts the screen down.

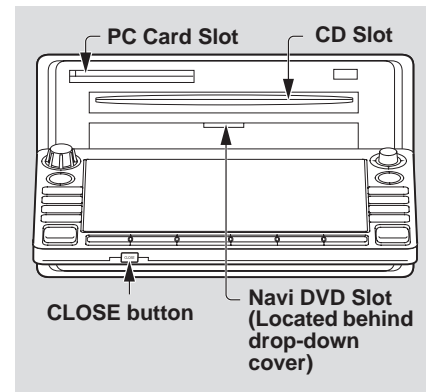

NOTE:

- Voice commands are disabled when the screen is tilted down.
- Press the **CLOSE** button to return the screen to the upright position.

Joystick/ENT button

Moves left, right, up, and down to move the highlighting around the display, to scroll through lists, or to look around a displayed map. After making a selection in a menu or list, push in on the joystick to enter the selection into the system. In almost all cases, you can enter a selection into the system by using the voice control system, highlighting the item and pushing in on the joystick, or by touching the appropriate item you wish to select.

INFO button

Displays the screen for selecting Cellular Phonebook, Voice Command Help, Map Legend, Calendar, and Calculator. See page 70.

MAP/GUIDE button

Displays the map. When en route, switches between the map, guidance, and Direction list screens. See page 19 or 51.

MENU button

Displays the Enter destination by screen. When en route, displays the Change route by screen.

SETUP button

Displays the Setup screens where you can customize information in the system. See page 75.

CANCEL button

Cancels the current screen and returns to the previous screen display.

NOTE:

The NAVI BACK button on the steering wheel performs the same basic function.

ZOOM ▲ (IN)/▼ (OUT) buttons

Press ZOOM ▲ to zoom in (to show more detail), or ZOOM ▼ to zoom out (to show more area and less detail) while a map screen is displayed. ZOOM IN reduces the scale (showing less area with greater detail). ZOOM OUT increases the scale (showing more area with less detail).

AUDIO button

Press to display the audio screen. For information on audio system features, see the *Audio* section of your Owner's Manual.

Other buttons

See the Audio section of your Owner's Manual.

Screen

All selections and instructions are displayed on the screen. In addition, the display is a “touch screen” – you can enter information into the system by touching the images (icons) on the screen with your finger.

For example, if you need to enter a street name, a keyboard will be displayed. You can type in the street name by saying or selecting the individual characters on the screen.

Clean the screen with a soft damp cloth. You may use a mild cleaner intended for use on liquid crystal displays (LCDs). Harsher chemicals may damage the screen.

Getting Started

Voice Control Basics

Your vehicle has a voice control system that allows hands-free operation of most of the navigation system functions. You can also control the audio and climate control system. The voice control system uses the **NAVI TALK** and **NAVI BACK** buttons on the steering wheel and a microphone near the map lights on the ceiling.

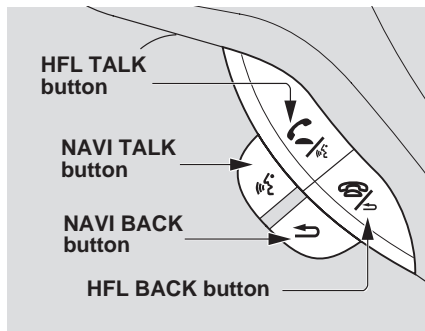

NOTE:

While using the voice control system, all of the speakers are muted.

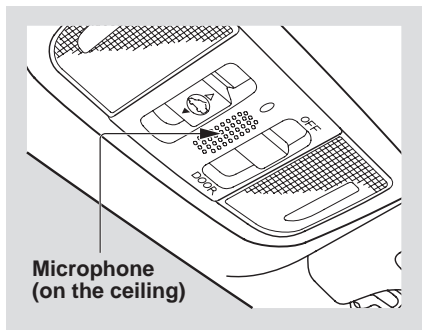

NAVI TALK button

This button activates the voice control system. Press and release it when you want to give a voice command. See *Voice Command Index* on page 140 for a list of voice commands.

NAVI BACK button

This button has the same function as the **CANCEL** button. When you press and release it, the display returns to the previous screen. When the previous screen appears, the system replays the last prompt. This button is enabled for navigation system commands only. However, it can be used to cancel an audio or climate control voice command up to one second after the command confirmation.

NOTE:

The **NAVI TALK** and **NAVI BACK** buttons are deactivated while using the *Bluetooth® HandsFreeLink®* feature. See your Owner's Manual and the official website (handsfreelink.honda.com) for information on this system.

Using the Voice Control System

You should use the voice control system as much as possible, and consider manual entry using the joystick as a backup method of entry.

Most of the system's functions can be controlled by voice commands activated with the **NAVI TALK** button. To control the navigation system by voice:

- Press and release the **NAVI TALK** button.
- Wait for the beep.
- Give a voice command.

Once the microphone picks up your command, the system changes the display in response to the command and prompts you for the next command. Using the **NAVI TALK** button, answer the prompts as required.

If the system does not understand a command or you wait too long to give a command, it responds with "Pardon," "Please repeat," or "Would you say again." If the system cannot perform a command or the command is not appropriate for the screen you are on, it sounds a beep.

Anytime you are unsure of what voice commands are available on a screen, you can always say "Help." The system will then read the list of available commands to you.

When you give a command, the system generally either repeats the command as a confirmation or asks you for further information. If you do not wish to hear this feedback, you can turn it off. However, hearing the feedback will familiarize you with the way the system expects commands to be phrased. See the **Voice Recognition Feedback** setting in Setup.

If you hear a prompt such as "Please use the touch screen to..." or "Please choose an area with the joystick," the system is asking for input that cannot be performed using the voice control system.

Improving Voice Recognition

To achieve optimum voice recognition when using either the navigation or *Bluetooth*® HandsFreeLink® voice control system, the following guidelines should be followed:

NOTE:

Make sure the correct screen is displayed for the voice command that you are using. See Voice Command Index on page 140.

- Adjust the dashboard and side vents so air does not blow against the microphone on the ceiling.
- Close the windows and the sunroof.
- If more than one person is speaking at the same time, the system may misinterpret your command.

Getting Started

- After pressing and releasing the **NAVI TALK** button, wait for the beep, then give a voice command.
- Give a voice command in a clear, natural speaking voice without pausing between words.
- If the system cannot recognize your command because of background noise, speak louder.
- If you are still having trouble with the voice control system, refer to **Voice Command Help** on the Information screen.

Selecting an Item (Button) on the Screen

On most screens, there are items that can be selected (like buttons with titles such as **OK** or **Return**). To select an item on any screen, do one of the following:

- Use the voice control system and say the name of the desired item. Almost all selectable items on the screen, including some listed items, are recognized by the voice control system.
- Touch the desired item on the screen.
- Move the highlighting to the desired item with the joystick, then push in on the joystick.

Tip:

If items are grayed out, this means that they cannot be selected.

Selecting an Item in a List

To scroll through a list, do one of the following:

- Use the joystick to scroll through the list item by item.
- Use the voice control system and say “Next” or “Previous” or use the “on-screen” scroll up or down buttons, or the **ZOOM** buttons to scroll through the list page by page.

If you cannot find the desired name, or have made an error, return to the previous screen by pressing the **CANCEL** or the **NAVI BACK** button on the steering wheel.

To select the desired item in the list, do one of the following:

- Use the voice control system, and say the item number of the desired item.
- Touch the item on the screen.
- Use the joystick to move the highlighting to the item, then push in on the joystick.

Using the On-screen Keyboard

When the system needs input from you, the display changes to a keyboard. Use the displayed letters to enter the information. Enter each letter by one of the following methods:

- Using the voice control system, say the desired letter on the screen.
- Move the highlighting to the desired letter using the joystick, then push in on the joystick.
- Touch the desired letter on the screen.

When speaking the letters or using “spell mode,” you can substitute the name that represents each letter or symbol. This improves recognition. The system will only respond to the names shown in the following graphic. For example:

- To select the letter “A”: Say, “**A**”; “**Alpha**”; or “**Apple**.”
- To select the letter “M”: Say, “**M**”; “**Mike**”; or “**Mary**.”

The names that can be used for each letter are shown below. For additional keyboard symbols, see page 147.

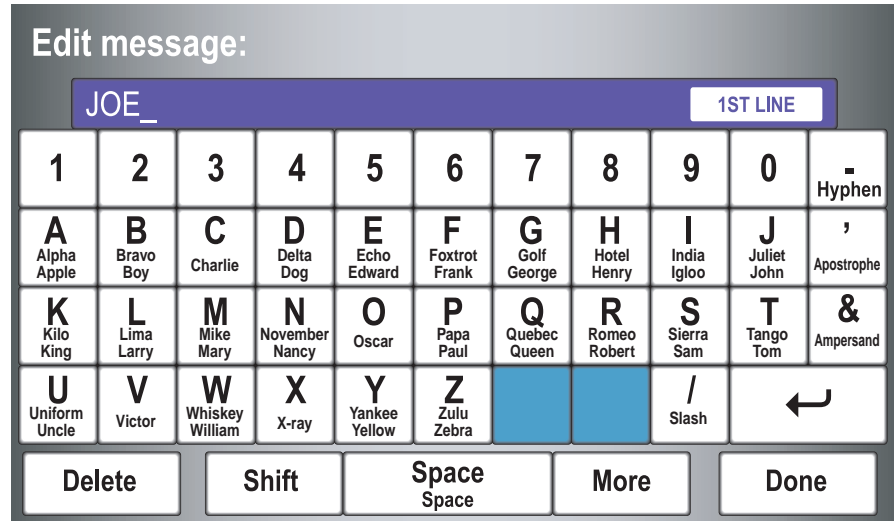

Getting Started

Each entered letter will appear at the top of the display. Say or select **Space** to enter a space between words. Say or select **Delete** to erase a letter entered incorrectly.

When entering an address, the system searches the database for words that match the letters you are entering. As a result, you will notice that some letters are no longer available.

When the system finds only one entry that matches, it completes the entry of the name for you. If the system finds more than one entry that matches your input, the system displays a list.

Tip:

*If you are unsure of the spelling of a name, enter the letters that you are sure of, and then select **List**. The system displays a list of names that most closely matches your input.*

You can choose to have your keyboard displayed in alphabetized format as shown below:



Or in a regular keyboard (QWERTY) format as shown below:



See **Keyboard Layout** in the Setup screen (second).

System Start-up

When you turn the ignition to ON (II), it takes several seconds for the navigation system to boot up.

The first screen to appear is the navigation system **globe** screen. The screen then changes to the Disclaimer screen:

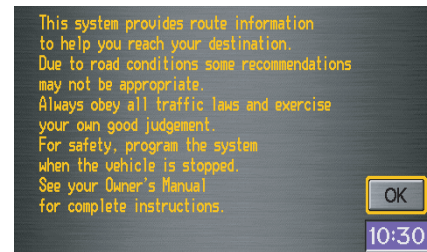

NOTE:

*The **OK** button does not appear immediately. It appears after the software is loaded.*

Read this disclaimer carefully so you understand it before continuing. Push in on the joystick, or touch **OK**, and the map screen will appear on the display. The “OK” cannot be activated by voice.

NOTE:

If you do not select **OK**, and then enter the Setup or Information screens, some items are not available and will show up as darkened buttons (grayed out). See System Function Diagram on page 21.

If you do not press the joystick or touch **OK**, the screen will turn to the clock screen after 30 seconds.



If you are not planning to use the navigation system at this time, touch **DISPLAY OFF** to turn off the screen.

By touching **CLOCK TYPE**, you can change the design of the clock screen. For details of the clock type, see page 77.

Tip:

For information on clock adjustment, see page 95.

To return to the Disclaimer screen, press the **MENU** or **MAP/GUIDE** button.

If you have entered any Calendar reminders, they are displayed after you select **OK**.

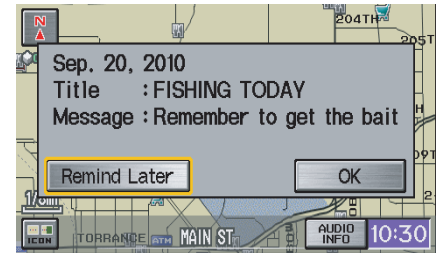

The Calendar reminder screen remains displayed until you select **OK** or **Remind Later**, or press the **CANCEL** button.

Getting Started

If you select **OK**, the reminder will not show up again. If you wish to have the reminder show up again later in the day, touch the **Remind Later** button.

If you press the **CANCEL** button, the message will be displayed the next time you start the vehicle.

NOTE:

The system will display the current message and any older or previously unread messages, with the newest message listed first.

Bluetooth® HandsFreeLink®

If you have a Bluetooth-compatible cell phone that is paired, then **CALL** on the Calculate route to screen is enabled.

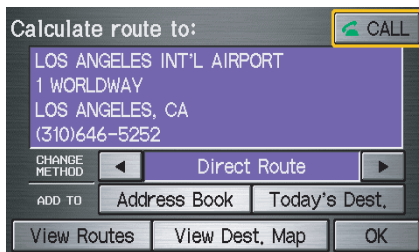

When you select **CALL**, the system dials the number shown on the screen. If **CALL** is not available (grayed out), and your phone is paired, then make sure the phone has service or that HFL is not in use; press the **HFL BACK** button.

For more information on **Bluetooth® HandsFreeLink®**, see your Owner's Manual and the official website (handsfreelink.honda.com).

Map Screen Legend

Map Orientation
(see page 56)

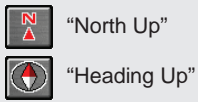

GPS Signal Strength

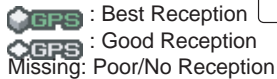

Current Map Scale
(see page 55)

No Entry Icon



ICON Button
(see page 59)



Vehicle Position (see page 62)
(Use voice command "Display the current location," or touch the icon to show current location.)

Status Bar

Current street name or audio information is displayed. You can switch this information by touching **CURRENT STREET/AUDIO INFO**.
(For information on the Current Street, see page 6.)

NOTE:

See **Map Legend** on the Information screen for further explanation.

Breadcrumbs



(see *Off-road Tracking* on page 61)

Landmark Icon - Generic (see page 57)

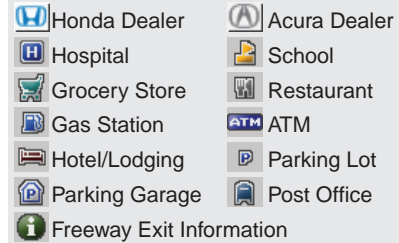

Streets

(see *Map Overview* on page 6)



One-Way Traffic Icon (1/20 mile scale only)
(see page 57)

Map Features

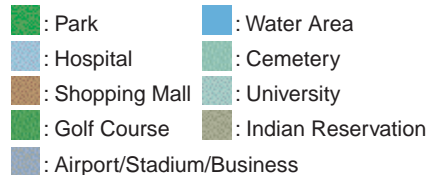

NOTE:

If you move the joystick over an area (map features shown above), the name is displayed on the screen.



MANHATTAN BEACH BLVD

AUDIO INFO

10:30

CURRENT STREET/AUDIO INFO

Clock
(see page 95)

Getting Started

Map Screen Description

Zoom In/Out

Use the **ZOOM** buttons to change the scale of the map. Zooming in increases the detail, while zooming out gives you a wide area view. After changing the scale, give the system a few moments to update the display.

Map Scrolling

To view other areas on the map, move the joystick left, right, up, or down. The map will shift in that direction. To return the map to your current location, press either the **MAP/GUIDE**, **CANCEL**, or **NAVI BACK** button on the steering wheel.

Displaying Current Location

You can say “Display current location” or touch the vehicle position icon at any time to see the current address, latitude, longitude, and elevation. The screen will change to:

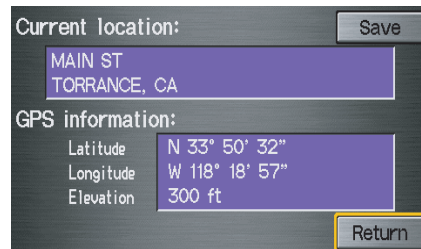

NOTE:

The elevation will not appear when the system is temporarily lacking proper GPS information. The system elevation may not agree with elevations shown on roadside elevation signs, and may fluctuate plus or minus 100 feet or more.

You can say “Save current location” or select **Save** on the screen to save the current location in your Address Book.

Select **Return** to return to the previous screen.

Entering a Destination

When you press the **MENU** button, the display changes to:



Address (see page 23)

This selection requires you to enter the city (and possibly the state) and the address that you want to go to.

Intersection (see page 27)

This selection allows you to enter the names of two intersecting streets in a city. This is useful if you know the general location of your destination, but not the exact address.

Places (see page 32)

The system has been programmed with the locations of many businesses, parks, hospitals, etc. This selection lets you search these by category, name, or phone number.

Map Input (see page 37)

This selection allows you to point to a destination on the map using the joystick. This allows you to enter a destination or address that may not be listed in the database.

Previous Destinations (see page 41)

When you enter a destination with any of the available selections (except **Address Book** and **Go Home**), the last 50 destinations are saved by the system. Use this selection to choose a destination again.

NOTE:

*If **Previous Destinations** is grayed out, there are no Previous Destinations entered.*

Today's Destinations (see page 42)

You can enter and sort up to five destinations and store them in the Today's Destinations list. You can then use the Today's Destination selection.

NOTE:

*If **Today's Destinations** is grayed out, there are no Today's Destinations entered.*

Address Book (see page 43)

This selection allows you to select a stored address. The system can store up to a combined total of 200 User 1 and User 2 addresses.

Go Home (see page 44)

This selection allows you to select your home or a common place as a destination.

NOTE:

If you have no home address entered, the system prompts you for one.

By Address

After you select **Address** from the Enter destination by screen, the display changes to:



Tip:

- When entering an address by voice, it is more efficient to say the city name first, then the street name.
- When entering an address by touch, it is usually easier to enter the street first. A city or cities that the street appears in will be displayed. For your convenience, you do not have to enter both city and street.

NOTE:

- If you find that your city is not listed, it may be part of a larger metropolitan area. Try entering the street first.
- Prior to departure, you can set areas to avoid. The system then includes them in its calculations for the destination you have entered. See Edit Avoid Area on page 89.

Selecting the State or Province

The state you are in is displayed at the top of the screen. If your desired destination is in another state, select **Change State**.

The display then changes to the Enter state name screen. Use the voice control system and say the name of the state or use the on-screen keyboard to enter the name of the state.

Selecting the City

This is helpful if the street runs through several cities, and you know what city includes the street. The city you are in is displayed on the screen. If the city you want is displayed on the screen, say “Select current city.” If your desired destination is in another city, say or enter that city.

By Voice Control:

Say “City” on the Find address by screen, and the display changes to the Say city name screen. Say the city name and the searching will begin.

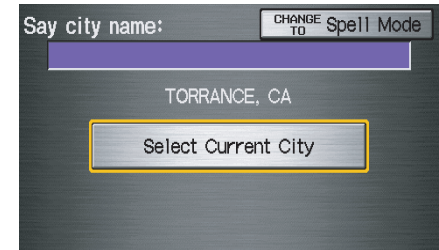

NOTE:

To improve voice recognition when saying the city name, pronounce the syllables as clearly as possible.

Entering a Destination

To enter the city name by voice spelling, say or select **CHANGE TO Spell Mode** on the **Say city name** screen, and the display will change to the **Enter city name** screen. Say the city name by saying individual letters, or words that represent the letters, one at a time.



The system has a talk back function. If your spoken letter is not recognized, the system will talk back to you. For example, if you say “E” but the system does not recognize the command, it will ask you, “Please select the number of the input letter from the list,” and the following pop-up box will appear:

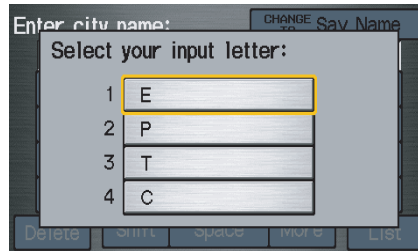

You should select a letter by saying the number.

Alternatively, to improve voice recognition, you can say “Echo” or “Edward” instead of “E.”

See page 15 for a list of available words for each letter.

By Touch Control:

Select **City**, and the display then changes to the **Enter city name** screen. Use the on-screen keyboard to enter the name of the city.

The system will display a list of city names, with the closest match to the name you entered at the top of the list. Select the number (1-6) of the desired city from the list.



If the system does not find an exact match, select **List** when you finish entering the name of the city. Most of the cities and towns for that state are listed.

Listings of cities and towns in the non-detailed coverage area may have an asterisk "*" next to their names. If you select one, a pop-up box is displayed saying, "No detailed street data...", and a street address cannot be entered (see *Map Coverage* on page 109). Try entering the street first, and then select the city if available.

Select **View Dest. Map** and use the joystick to select an icon, approximate area, or street you wish to choose as your destination. Otherwise, a central location of the city will be selected. If you select a point of interest (POI) or road in an unverified area, you may or may not have routing in these areas. See *Map Overview* on page 6.

Selecting the Street

By Voice Control:

After you have selected the city, or if you say "Street" on the Find address by screen, the display changes to the Say street name screen. Say the street name and the searching will begin.

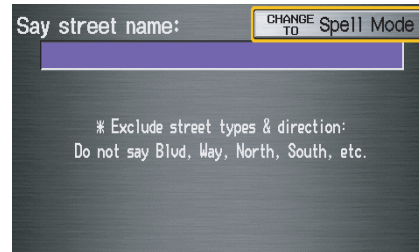

To enter the street name by voice spelling, say or select **CHANGE TO Spell Mode** on the Say street name screen, and the display will change to the Enter street name screen.

Say the street name by saying individual letters or numbers, or words that represent the letters, one at a time.



Entering a Destination

The system has a talk back function. If your spoken letter is not recognized, the system will talk back to you. For example, if you say “E” but the system does not recognize the command, it will ask you, “Please select the number of the input letter from the list,” and the following pop-up box will appear:

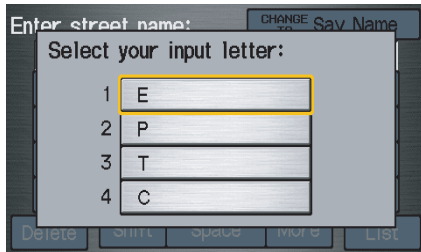

You should select a letter by saying the number.

Alternatively, to improve voice recognition, you can say “Echo” or “Edward” instead of “E.” See page 15 for a list of available words for each letter.

By Touch Control:

After you have selected the city, or if you selected **Street** in the beginning, the display changes to the **Enter street name** screen. Use the on-screen keyboard to enter the name of the street (like ELM or 42ND) that is your destination.

To enter the name of a major highway, you must use the full name, including a hyphen. For interstates, use an “I” (I-10). For U.S. highways, use “US” (US-18). For state highways, use the two character state designation (CA-101). For county roads, use the appropriate designation (G-2, for example).

Tip:

When entering a street, you do not need to enter the direction (N, S, E, W) or the type (St, Ave, etc.). The system will automatically determine that for you, based on your entered city and street number.

The system will display a list of street names, with the closest match to the name you entered at the top of the list. Select the number (1-6) of the desired street from the list.



Entering the Street Number

After you have completed the street name, the display changes to the **Enter street number** screen. Use the voice control system and say the address number as a continuous string of numbers. For example, the address 1527 should be spoken as “One, five, two, seven.” You can also use the on-screen keyboard to enter the street number.

Some address numbers may not be available on the selected street. For example, let’s say the individual address ranges for a selected street name are 1 - 20 and 9,000 - 10,000, with an overall range shown on the display of 1 to 10,000. If you try to enter a number outside the individual address ranges such as 500, the system will show this number as unavailable (grayed out).

- When using the on-screen keyboard, the system only allows you to choose available address numbers.
- When using voice control, the system beeps if you try to select an unavailable (grayed out) address number.

If you did not select a city in the beginning, the street name you selected might appear in more than one city. The system will give you a list of cities that the street appears in. Select the desired city from the list. The system then displays the **Calculate route** to screen (see *Driving to Your Destination* on page 46).

Tip:

*If the particular address you want cannot be found, select **Map Input** and use the joystick to select the appropriate location on the map (see *By Map Input* on page 37).*

Select **View Dest. Map** and use the joystick to select an icon, approximate area, or street you wish to choose as your destination. Otherwise, a central location of the street will be selected. If you select a point of interest (POI) or road in an unverified area, you may or may not have routing in these areas. See *Map Overview* on page 6.

By Intersection

After you select **Intersection** from the **Enter destination** by screen, the display changes to:



Tip:

When entering an address, it is usually easier to enter the street first. A city or cities that the street appears in will be displayed. For your convenience, you do not have to enter both city and street.

Entering a Destination

NOTE:

- *If you find that your city is not listed, it may be part of a larger metropolitan area. Try entering the street first.*
- *Prior to departure, you can set areas to avoid. The system then includes them in its calculations for the destination you have entered. See Edit Avoid Area on page 89.*

Selecting the State or Province

The state you are in is displayed at the top of the screen. If your desired destination is in another state, select **Change State**.

The display then changes to the Enter state name screen. Use the voice control system and say the name of the state or use the on-screen keyboard to enter the name of the state.

Selecting the City

This is helpful if the street runs through several cities, and you know what city includes the street. The city you are in is displayed on the screen. If the city you want is displayed on the screen, say “Select current city.” If your desired destination is in another city, say or enter another city.

By Voice Control:

Say “City” on the Find intersection by screen, and the display changes to the Say city name screen. Say the city name and the searching will begin.

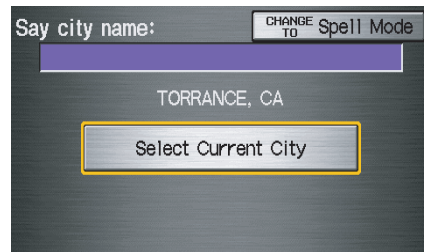

To enter the city name by voice spelling, say or select **CHANGE TO Spell Mode** on the Say city name screen, and the display will change to the Enter city name screen.

Say the city name by saying individual letters, or words that represent the letters, one at a time.



The system has a talk back function. If your spoken letter is not recognized, the system will talk back to you. For example, if you say “E” but the system does not recognize the command, it will ask you, “Please select the number of the input letter from the list,” and the following pop-up box will appear:

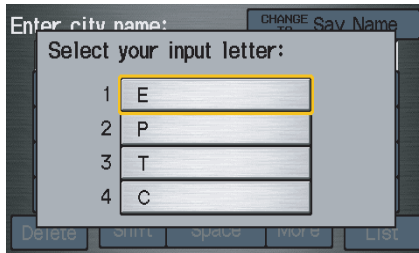

You should select a letter by saying the number.

Alternatively, to improve voice recognition, you can say “Echo” or “Edward” instead of “E.” See page 15 for a list of available words for each letter.

By Touch Control:

Select **City**, and the display then changes to the **Enter city name** screen. Use the on-screen keyboard to enter the name of the city.

The system will display a list of city names, with the closest match to the name you entered at the top of the list. Select the number (1-6) of the desired city from the list.



If the system does not find an exact match, select **List** when you finish entering the name of the city. Most of the cities and towns for that state are listed.

Listings of cities and towns in the non-detailed coverage area may have an asterisk “*” next to their names. If you select one, a pop-up box is displayed saying, “No detailed street data...”, and a street address cannot be entered (see *Map Coverage* on page 109).

Select **View Dest. Map** and use the joystick to select an icon, approximate area, or street you wish to choose as your destination. Otherwise, a central location of the city will be selected. If you select a point of interest (POI) or road in an unverified area, you may or may not have routing in these areas. See *Map Overview* on page 6.

Entering a Destination

Selecting the Street

By Voice Control:

After you have selected the city, or if you say “Street” on the Find intersection by screen, the display changes to the Say street name screen. Say the street name and the searching will begin.

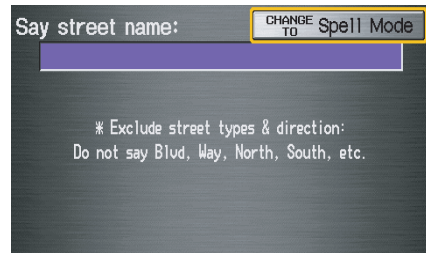

To enter the street name by voice spelling, say or select **CHANGE TO Spell Mode** on the Say street name screen, and the display will change to the Enter street name screen.

Say the street name by saying individual letters or numbers, or words that represent the letters, one at a time.



After you have completed the first name, the display changes to the Say intersecting street screen. Say the name of the other intersecting street.

The system has a talk back function. If your spoken letter is not recognized, the system will talk back to you. For example, if you say “E” but the system does not recognize the command, it will ask you, “Please select the number of the input letter from the list,” and the following pop-up box will appear:

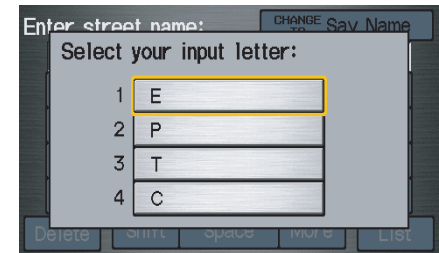

You should select a letter by saying the number.

Alternatively, to improve voice recognition, you can say “Echo” or “Edward” instead of “E.” See page 15 for a list of available words for each letter.

By Touch Control:

After you have selected the city, or if you select **Street** in the beginning, the display changes to the **Enter street name** screen. Use the on-screen keyboard to enter one of the names (like ELM or 42ND) of the intersecting streets.

To enter the name of a major highway, you must use the full name, including a hyphen. For interstates, use an “I” (I-10). For U.S. highways, use “US” (US-18). For state highways, use the two character state designation (CA-101). For county roads, use the appropriate designation (G-2, for example).

Tip:

When entering a street, you do not need to enter the direction (N, S, E, W) or the type (St, Ave, etc.). The system will automatically determine that for you.

The system will display a list of street names, with the closest match to the name you entered at the top of the list. Select the number (1-6) of the desired street from the list.



After you have completed the first street name, the display changes to the **Enter intersecting street** screen.

Enter the name of the other intersecting street using the on-screen keyboard.

If you did not select a city in the beginning, and the intersection appears in more than one city, you will see the **Select a city** screen. The system will give you a list of cities that the intersection appears in. Select the desired city from the list. If more than one intersection appears in a city, select the desired intersection from the **Select an intersection** screen. The system then displays the **Calculate route to** screen (see *Driving to Your Destination* on page 46).

Tip:

*If the particular intersection you want cannot be found, select **Map Input** and use the joystick to select the appropriate location on the map (see *By Map Input* on page 37).*

Select **View Dest. Map** and use the joystick to select an icon, approximate area, or street you wish to choose as your destination. Otherwise, a central location of the street will be selected. If you select a point of interest (POI) or road in an unverified area, you may or may not have routing in these areas. See *Map Overview* on page 6.

Entering a Destination

By Places

After you select **Places** from the Enter destination by screen, the display changes to:

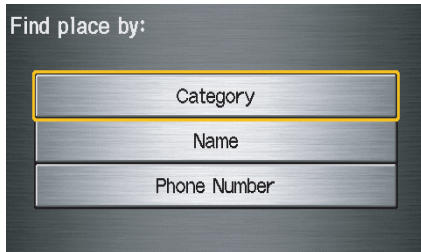

There are three ways to find a place or point of interest (POI), by **Category**, **Name**, or **Phone Number**.

Let's assume you want to find a coffee shop (restaurant) called "Bucks."

- If you know the phone number of the coffee shop, select **Phone Number**, then enter the 10-digit number with area code. This is the quickest way to find it.
- The second best method is to select **Category**, **Restaurant**, and **CAFÉ/COFFEE SHOP**. After you select **Place Name by Keyword** and search method, enter the keyword "Bucks." The list will include all restaurants that have the letters "bucks" anywhere in the name.
- You can try to enter "Bucks" using **Name**, but you may have to search through a list that might include Bucks Welding, Bucks Surplus, etc.

NOTE:

- *Prior to departure, you can set areas to avoid. The system then includes them in its calculations for the destination you have entered. See Edit Avoid Area on page 89.*
- *You can enter the desired destination using the voice control system. For information on the available voice commands, see Voice Command Index on page 140.*

Finding the Place by Category

The **Category** option gives you a list of categories or types of businesses to select from with the following screen:

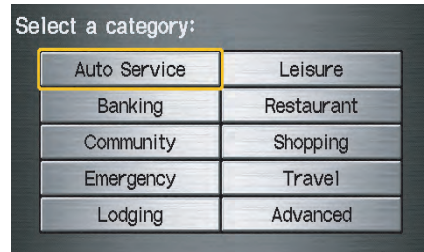

Tip:

*If you are not sure of the spelling of a place, the best way to find it is to use the keyword search. Select **Category**, choose a category and subcategory from the menus, then select **Place Name by Keyword**, and enter the partial name.*

After selecting a category and subcategory, the system will give you the options of **Place Name by Keyword**, **Sort by Distance to Travel**, **City Vicinity**, or **Place Name** with the following screen:



Entering a Destination

Auto Service		Lodging		Shopping	
Honda Dealers	Auto Repair & Maintenance	Bed & Breakfast	Resort	All Shopping*2	Office Supplies/Electronics
Acura Dealers	Car Wash & Detailing	Hotel/Motel		Accessories/Jewelry	Pharmacy/Drug Store
Gas Station	Motorcycle Dealers	Leisure		Auto Parts & Electronics	Pet Food/Supplies
Hydrogen Station	Other Car Dealers	Amusement Park	Museum	Books/Music/Video	Sewing/Linen
Auto Parts & Electronics	Roadside Assistance	Golf Course	Park/Recreation Area	Clothing	Shoes/Bags
Banking		Historical Monument	Performing Arts	Groceries	Sporting Goods
ATM	Check Cashing/Money Transfer	Marina	Sports Complex	Home Improvement	Toys/Arts/Crafts
Bank	Currency Exchange	Movie Theater	Tourist Attraction	Mall/Department Store	
Community		Restaurant		Travel	
Business	Higher Education	All Types*1	Italian	Airport	Parking Lot
City Hall	Library	American	Japanese	Automobile Club	Rental Car Agency
Civic/Community Center	Post Office	Café/Coffee Shop	Korean	Bed & Breakfast	Resort
Convention/Exhibition Center	School	Californian	Mexican	Bus Station	Rest Area
Court House		Chinese	Pizza	Camping	Ski Area
Emergency		Continental	Seafood	Commuter Rail Station	Tourist Attraction
Hospital	Roadside Assistance	Fast Food	Thai	Ferry Terminal	Tourist Information
Police Station	Veterinarian	French	Vegetarian	Hotel/Motel	Train Station
		German	Vietnamese	Named Place	Travel Agency
		Greek	Other	Park & Ride	Truck Stop/Plaza
		Indian		Parking Garage/House	
				Advanced	

*1 When trying to find a specific restaurant, select the category **ALL TYPES**. Some restaurants may be miscategorized.

*2 When trying to find a specific store, select the category **ALL SHOPPING**. Some stores may be miscategorized.

If the category you want is not listed, you can try to find it with a keyword. When you select this option, the display changes to the **Enter keyword for category** screen. If the system finds any categories with the keyword you entered, the display changes to the **Select a category** screen. Select the desired category.

Place Name by Keyword

If you do not know the exact name of the destination, you can find the place with a keyword. When you select this option, the display changes to:

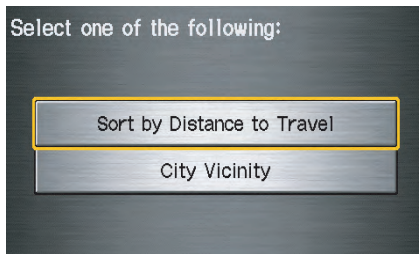

You can find your destination with a keyword using the **Sort by Distance to Travel** option or **City Vicinity** option.

If you select the **Sort by Distance to Travel** option, the **Enter keyword for place** screen appears. Enter the keyword using the on-screen keyboard. If the system does not find an exact match, select **List** when you finish entering the keyword. The system starts searching for places that match the entered keyword. If you see your desired place, select it from the list. If not, scroll through the list to find the desired place.

If you select the **City Vicinity** option, the **Enter city name** screen appears. Enter the name of the city using the on-screen keyboard. The system will display a list of city names, with the closest match to the name you entered at the top of the list. Select your desired city name from the list. Once you have selected your desired city name, the **Enter keyword for place** screen appears. Enter the keyword using the on-screen keyboard to specify the desired place.

Once you select a place, the system then displays the **Calculate route to screen** (see *Driving to Your Destination* on page 46).

Entering a Destination

Sort by Distance to Travel

When you select this option, the system gives you a list of all the places in the subcategory. This list is arranged by distance from your current location, with the closest at the top of the list.

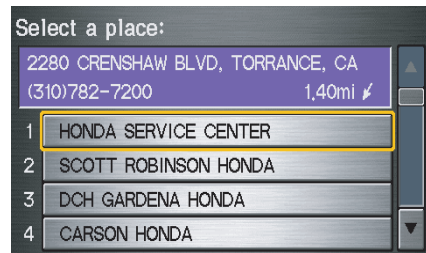

The distance and direction to the destination at the top of the list are shown in the screen. The distance shown is straight line distance (as the crow flies), not driving distance. Select the number (1-4) of the desired destination from the list.

Once you select a place, the system then displays the **Calculate route** to screen (see *Driving to Your Destination* on page 46).

City Vicinity

The system allows you to find points of interest in the vicinity of the city you entered. When you select this option, the display changes to the **Enter city name** screen. Enter the name of the city using the on-screen keyboard. If the system does not find an exact match, select **List** when you finish entering the name of the city. Select a desired city from the list.

Once you have selected the city, the display changes to the **Enter a place name** screen. Enter the name of the place using the on-screen keyboard.

Once you select a place, the system then displays the **Calculate route** to screen (see *Driving to Your Destination* on page 46).

Place Name

When you select this option, the display changes to the **Enter a place name** screen. Enter your selection, using the on-screen keyboard.

Once you select a place, the system then displays the **Calculate route** to screen (see *Driving to Your Destination* on page 46).

Finding the Place by Name

The **Name** option allows you to enter the name of a business, and then shows you a list of businesses with the same or similar names to select from. Use the name option only if you know the exact spelling of the place. If unsure, use the **Category** option.

Finding the Place by Phone Number

The **Phone Number** option allows you to select a destination by its telephone number. Only telephone numbers stored in the system under the **Places** (of business) option are recognized. The system does not contain residential telephone numbers, or numbers you may have entered in your personal Address Book.

Tip:

If you know the phone number of a point of interest (POI), its uniqueness makes it the fastest entry method. When using the voice control system, the entry should be spoken as a continuous string of numbers. For example, the telephone number (310) 555-4000 should be spoken as “Three, one, zero, five, five, five, four, zero, zero, zero.”

By Map Input

After you select **Map Input** from the Enter destination by screen, the display changes to:

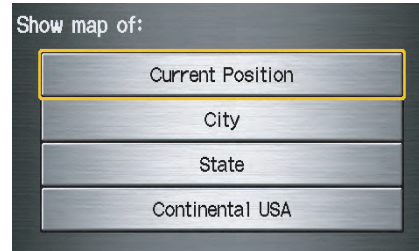

NOTE:

- Prior to departure, you can set areas to avoid. The system then includes them in its calculations for the destination you have entered. See *Edit Avoid Area on page 89*.
- For information on the available voice commands, see *Voice Command Index on page 140*.

Showing the Map of Current Position

The **Current Position** selection assumes that you are looking for a destination in the immediate area. The display changes to:

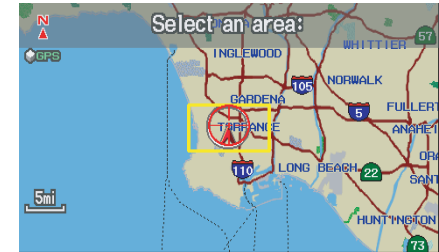

The red arrow indicates your vehicle position. Find your desired destination by moving the joystick left, right, up, or down. The map and crosshairs will move in the same direction.

The yellow box indicates the area you will see when you click on the current map with the joystick. The scale will decrease each time you push in on the joystick, until **Select a destination** appears at the top of the screen.

Entering a Destination

If desired, use the **ZOOM** buttons to change the map scale. When you have the crosshairs on the desired icon, map feature, or road, push in on the joystick. The address of the location will appear at the top of the screen.

NOTE:

The selected icon or road segment is displayed on the 1/2 mile (800 meter) or less map scale.

If this is the desired destination, push in on the joystick again. If not, use the joystick to reposition the crosshairs, then push in on the joystick again to display the new address.

If you selected a single icon or road segment within the target mark, the following screen appears. Push in on the joystick again to calculate a route to the selected destination.



If you selected multiple icons within the cursor radius, the following screen appears. Select an item from the list. Then select **OK** to calculate a route to the selected destination.



Once you select an address, the system then displays the Calculate route to screen (see *Driving to Your Destination* on page 46).

Showing the Map of City

With the **City** selection, the display changes to the Enter city name screen.

When you have entered the desired city, the display changes to a map. The starting location will be the central position in the selected city.

See *Showing the Map of Current Position* on page 37 for instructions on finding and entering your desired destination.

Showing the Map of State

With the **State** selection, the display changes to the Enter state name screen.

After you select the desired state, the display changes to a map of the state, with the crosshairs located near the middle.

The yellow box indicates the area you will see when you click on the current map with the joystick. The scale will decrease each time you push in on the joystick, until **Select a destination** appears at the top of the screen.



Use the joystick to move the crosshairs to the area of the state close to your intended destination. If desired, use the **ZOOM** buttons to change the map scale. When you have the crosshairs in the desired area, push in on the joystick. The address of the location you have selected will appear at the top of the screen.

NOTE:

The selected icon or road segment is displayed on the 1/2 mile (800 meter) or less map scale.

Entering a Destination

If this is the desired address, push in on the joystick again. If not, use the joystick to reposition the crosshairs, then push in on the joystick again to display the new address.

If you selected a single icon or road segment, push in on the joystick again to select the new address. If you selected multiple icons within the cursor radius, select an item from the list on the screen.

Once you select an address, the system then displays the **Calculate route** to screen (see *Driving to Your Destination* on page 46).

Showing the Map of Continental USA

With the **Continental USA** selection, the display changes to:



The yellow box indicates the area you will see when you click on the current map with the joystick. The scale will decrease each time you push in on the joystick, until **Select a destination** appears at the top of the screen.

Use the joystick to move the crosshairs to the area of the country for your intended destination. Then push in on the joystick.

If desired, use the **ZOOM** buttons to change the map scale. When you have the crosshairs on the desired icon, map feature, or road, push in on the joystick. The address of the location you have selected will appear at the top of the screen.

NOTE:

The selected icon or road segment is displayed on the 1/2 mile (800 meter) or less map scale.

If this is the desired address, push in on the joystick again. If not, use the joystick to reposition the crosshairs, then push in on the joystick again to display the new address.

If you selected a single icon or road segment, push in on the joystick again to select the new address. If you selected multiple icons within the cursor radius, select an item from the list on the screen.

Once you select an address, the system then displays the **Calculate route** to screen (see *Driving to Your Destination* on page 46).

By Previous Destinations

Every time you route to a destination, that destination is saved by the system. Up to 50 destinations can be stored. Select **Previous Destinations** from the Enter destination by screen to choose one of those destinations.

After you select **Previous Destinations**, the display lists the last 50 destinations entered, with the most recent appearing first.



NOTE:

- *If **Previous Destinations** is grayed out, there are no **Previous Destinations** entered.*
- *When finishing a "Today's Destinations" trip, the Today's Destinations list entries are stored to this list, beginning with the date (e.g., item 1 shown on the previous screen).*
- *Because both the Home address and personal Address Book list can be protected by a PIN, they do not show up in the previous destination list.*

Scroll through the list and say the line number (1-6) of the destination, or touch the desired destination you want.

Once you select the desired destination, the system then displays the **Calculate route to screen** (see *Driving to Your Destination* on page 46).

NOTE:

- *Prior to departure, you can set areas to avoid. The system then includes them in its calculations for the destination you have entered. See *Edit Avoid Area* on page 89.*
- *For information on the available voice commands, see *Voice Command Index* on page 140.*

Entering a Destination

By Today's Destinations

You can create a “trip” by combining up to five destinations previously selected on the Calculate route to screen.

Select **Today's Destinations** from the Enter destination by screen and the display changes to:

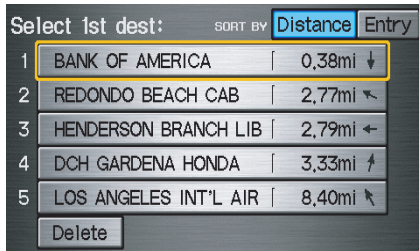

NOTE:

If **Today's Destinations** is grayed out, there are no Today's Destinations entered.

Editing Today's Destinations List

If you change your plans, you can modify the Today's Destinations list order by distance, or by order of entry.

Say or select **Input** to sort the list by the entry order, and say or select **Distance** to sort the list by the distance order. To delete a destination, say or select **Delete** and the display changes to Select a destination to delete screen. Select the destination to delete and say or select **Done** to perform the deletion, and the display returns to the previous screen. To cancel the deletion, press the **CANCEL** button.

NOTE:

For information on the available voice commands, see Voice Command Index on page 140.

Adding Destinations to the List

After you have used any of the other selections from the Enter destination by screen to select a destination, the display changes to:



To add this to the Today's Destinations list, select ADD TO **Today's Dest.**

NOTE:

If **ADD TO Today's Dest** is grayed out, the Today's Destinations list is already full (five destinations have been stored).

The display then changes to show you all the current entries on the Today's Destinations list. Press the **MENU** button to return to the Enter destination by screen.

The system automatically sorts the destinations stored in the Today's Destinations list for the best path.

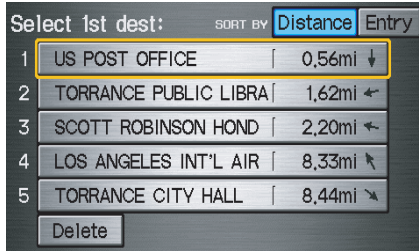

If the displayed list shows your plans, select the first destination. The system will guide you to the destination according to the order of the list. When you reach the destination, it will be automatically removed from the list.

NOTE:

When finishing a "Today's Destinations" trip, the Today's Destinations list entries are stored to the Previous Destinations list, beginning with the date (e.g., item 1 shown below). This entry contains all the destinations that were included in the Today's Destinations itinerary. This allows you to reselect the entire Today's Destinations content at a later date.



By Address Book

This selection allows you to choose a personal address entry for a destination. After you select **Address Book** from the Enter destination by screen, the display changes to:

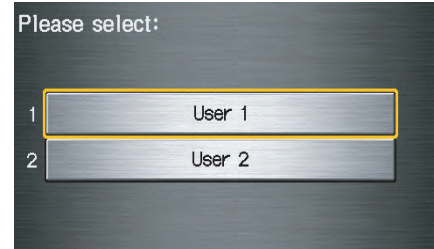

If an **Address Book PIN** has been set in Setup, the system prompts you to enter your PIN after you select **User 1** or **User 2**. Say or enter your PIN, and say or select **Done**.

If the PIN has not been entered, the system displays the list after you select **User 1** or **User 2**.

Entering a Destination

The system then displays a list of the places entered in your personal Address Book. Selecting **Category**, you can sort the displayed addresses by **ALL**, **BUSINESS**, **PERSONAL**, or by other categories you may create.

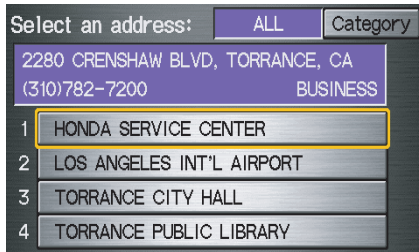

Scroll through the list to find your desired destination. After you select it, the system then displays the **Calculate route** to screen (see *Driving to Your Destination* on page 46).

Adding Addresses to the Personal Address Book

There are two ways to enter addresses to the personal Address Book:

- Entering them in the personal Address Book feature in Setup (see page 78).
- Adding them in the Address Book directly from the **Calculate route** to screen (see page 46).

NOTE:

- *Destinations chosen from the Address Book do not show up in Previous Destinations.*
- *Prior to departure, you can set areas to avoid. The system then includes them in its calculations for the destination you have entered. See Edit Avoid Area on page 89.*
- *For information on the available voice commands, see Voice Command Index on page 140.*

By Go Home

Selecting **Go Home** from the Enter destination by screen takes you home or to a frequently used address you have chosen.

If a **Go Home PIN** has been set in Setup, the system prompts you to enter your PIN. Say or enter your PIN, and say or select **Done**. The system will then display the **Calculate route** to screen (see *Driving to Your Destination* on page 46).

If a **Go Home PIN** has not been set, the system displays the **Calculate route** to screen after you select **Go Home** (see *Driving to Your Destination* on page 46).

NOTE:

- *To edit Home Address, see Home Address in System Setup on page 82.*
- *Prior to departure, you can set areas to avoid. The system then includes them in its calculations for the destination you have entered. See Edit Avoid Area on page 89.*
- *PINs are optional. If you choose to use a PIN, make sure you remember it. If you forget your PIN, your dealer will have to reset it for you.*
- *If a PIN is desired, enter it using the Personal preference PIN number feature in Setup. See page 83 for information on entering your Go Home PIN.*

Driving to Your Destination

Driving to Your Destination

A route typically has three phases.

- Initial route calculation (Calculate route to screen) (see page 46).
- Change the route while en route (see page 64).
- Resume the route when restarting the engine (see *Continue Trip Screen* on page 69).

Calculate Route to Screen

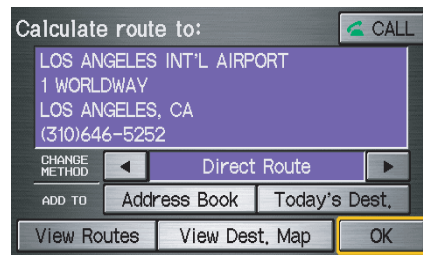

Say or select **OK**. The system calculates the route using the method shown on the screen (see *Map Screen* on page 49).

NOTE:

- *Prior to departure, you can set areas to avoid. The system then includes them in its calculations for the destination you have entered. See Edit Avoid Area on page 89.*
- *For information on the available voice commands, see Voice Command Index on page 140.*

Further selections from the Calculate route to screen include:

ADD TO Address Book

Allows you to add the destination to your Address Book. See *By Address Book* on page 43.

NOTE:

If the button is grayed out, the destination is already in your Address Book.

ADD TO Today's Destinations

Allows you to add the destination to your Today's Destinations list. See *By Today's Destinations* on page 42.

NOTE:

If the button is grayed out, the Today's Destinations list is already full (five destinations have been stored).

CALL

Dials the number on the screen when available. See *Bluetooth® HandsFreeLink®* on page 18.

Changing the Routing Method

The system lets you select the way you want to drive to your destination. Before selecting **OK** to calculate a route, you can change the routing method by using the **CHANGE METHOD** scroll bar back (◀) or forward (▶) buttons. The route choices will appear in the address box.

NOTE:

*When you are en route and want to change the routing method, press the **MENU** button, and select **Change Routing Method** on the Change route by screen.*

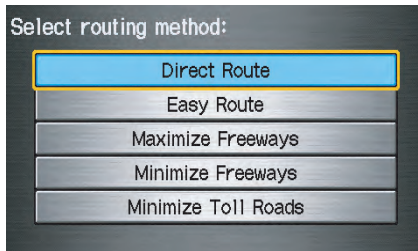

- “Direct Route” (the factory default) is the route that is the quickest (least time) and is usually the best choice. If you choose any other method, it becomes the new default for all future routing. Make sure to check the routing method if the displayed route is not what you expected to see.
- “Easy Route” produces a route with the least turns.
- “Maximize Freeways,” “Minimize Freeways,” and “Minimize Toll Roads” are also available.

NOTE:

If the trip is greater than 100 miles, then “Minimize Freeways” and “Minimize Toll Roads” may be grayed out. This is normal.

The generated route may not be the route you would choose. For safety reasons, the system generally applies the following rules to your route:

- It tries to avoid shortcuts through residential areas.
- Right turns are favored over left turns or U-turns.
- Restricted turns (turns that cannot be made during certain hours) are not used for routing.

Driving to Your Destination

Viewing the Routes

Touching **View Routes** on the Calculate route to screen allows you to scroll through and view the various routes (Direct, Easy, Maximize Freeways, etc.) to your destination. If you select **View Routes**, the display changes to:



NOTE:

- You may only view routes as shown above from the Calculate route to screen.
- The selected route method is shown at the top of the screen.

- It may take several minutes (the system displays an hourglass while it is calculating) to show all route methods, and it is not unusual for the different methods to pick the same route. Voice commands cannot be used while the system is calculating.
- If the trip is greater than 100 miles, then “Minimize Freeways” and “Minimize Toll Roads” may be grayed out. This is normal.

Say or select **Summary** to display the distance and time to go for each route. Based on the route data, you can change the routing by using the **Next** and **Prev.** buttons. Once you confirm your selection, say or select **OK** on the screen.

NOTE:

Distances and times shown for each method in the Summary are approximate.

After calculating the route with the new method, the system displays a map of your current location. The calculated route will be highlighted as a blue line, and a voice prompt will tell you how to proceed along the highlighted route. Touch **VOICE** to have the guidance repeated.



Viewing the Destination Map

Touching **View Dest. Map** displays a map of the destination vicinity. Press the **CANCEL** or **NAVI BACK** button to return. You can view the destination map anytime while en route by saying, “Display destination map.”



Map Screen

When you select **OK** on the Calculate route to screen, the map screen appears, showing your highlighted route in real time.

Route Line

When driving to a destination on verified roads in a metropolitan area, the route line is displayed as a blue line. When driving in rural areas on unverified streets (light brown color), the route line changes to either a blue dotted “vector line” pointing to your destination, or a blue-pink line. See *Unverified Area Routing* on page 85 for a detailed explanation of how to enable unverified routing, and the related cautions and disclaimers.

NOTE:

You can always view the entire route by simply saying, “Display entire route.”



“Vector line” (unverified routing off)



Blue-pink unverified route line (unverified routing on)

Driving to Your Destination

Guidance Prompts

As you get near the maneuver, you will hear a voice reminder and see a pop-up window showing you the maneuver.

The number of reminders that you will hear before a maneuver is determined by **Guidance Prompts** in Setup on page 77.

With the factory default (Max), typically you will hear two prompts:

- The first is about 1/4 mile from the maneuver.
- The final maneuver is close to your actual turn.

If the distance between the next two driving maneuvers is very small, both maneuvers are displayed on the screen in a single window, and the voice will remind you of both of them at the same time.

NOTE:

- *You can say “Voice” or select **VOICE** on the screen at any time to be reminded of the next maneuver.*
- *Typically, a pop-up guidance window shows your next turn, and a voice guidance prompt is heard. The timing of these prompts varies, depending on the type of road you are on, and the distance to your next maneuver.*

When given guidance in unverified areas, the words “if possible” are inserted before each guidance prompt. See *Unverified Area Routing* on page 85 for more details about unverified routing.

Map Screen Legend

Distance to Destination
(see page 53)

Direction of Destination
(When en route)
(see page 53)

Map Orientation
(see page 56)

 "North Up"
 "Heading Up"

Map Scale Adjustment
(Mile or km per half-inch
appears only when you
ZOOM IN or OUT.)
(see page 55)

Current Map Scale
(see page 55)

ICON Button
(see page 59)

VOICE Button (see page 50)
(Announces next driving instruction)

Vehicle Position (see page 62)
(Use voice command, "Display
current location," or touch the icon
to show the current location.)

NOTE:

See **Map Legend** from the Information screen for further explanation (see page 71).

Time to Destination
(see page 53)

Waypoint
(When en route)
(see page 64)

Breadcrumbs
(see *Off-road
Tracking* on
page 61)

No Entry Icon



Current Street (see page 6)
(When audio information is displayed,
touch **CURRENT STREET/AUDIO INFO**
to display the current street name.)

**CURRENT STREET/
AUDIO INFO**
Blue Line
Calculated route
(see page 49)

Map Features

-  : Park
-  : Water Area
-  : Hospital
-  : Cemetery
-  : Shopping Mall
-  : University
-  : Golf Course
-  : Indian Reservation
-  : Airport/Stadium/Business



NOTE:

If you move the joystick over an area (map features shown above), the name is displayed on the screen.













One-Way Traffic Icon (1/20 mile scale only)
(see page 57)

Destination Icon
(see page 56)

Streets
(see *Map Overview* on page 6)

-  Interstates or Freeways
-  Verified Streets
-  Unverified Streets

Landmark Icon - Generic (see page 57)

- | | |
|---|--|
|  Honda Dealer |  Acura Dealer |
|  Hospital |  School |
|  Grocery Store |  Restaurant |
|  Gas Station |  ATM |
|  Hotel/Lodging |  Parking Lot |
|  Parking Garage |  Post Office |
|  Freeway Exit Information | |

Driving to Your Destination

Guidance Screen

The guidance screen offers an alternative way to view your route information. Many of the icons and screen features are similar to those on the map screen. While driving to your destination, press the **MAP/GUIDE** button to switch between the map and guidance screens. The guidance screen shows you:

Milestone to Destination – The position of the small circular icon shows your trip progress. As you get closer to your destination, the indicator will approach “DEST.”

Vehicle Heading – The white portion of the compass symbol indicates north.

NOTE:

- *The map and voice guidance in unverified areas differ from those in verified areas.*
- *Current maneuvers and those within 1000 feet will show on the Countdown bar, indicating the distance until the next maneuver.*

Guidance Screen Legend

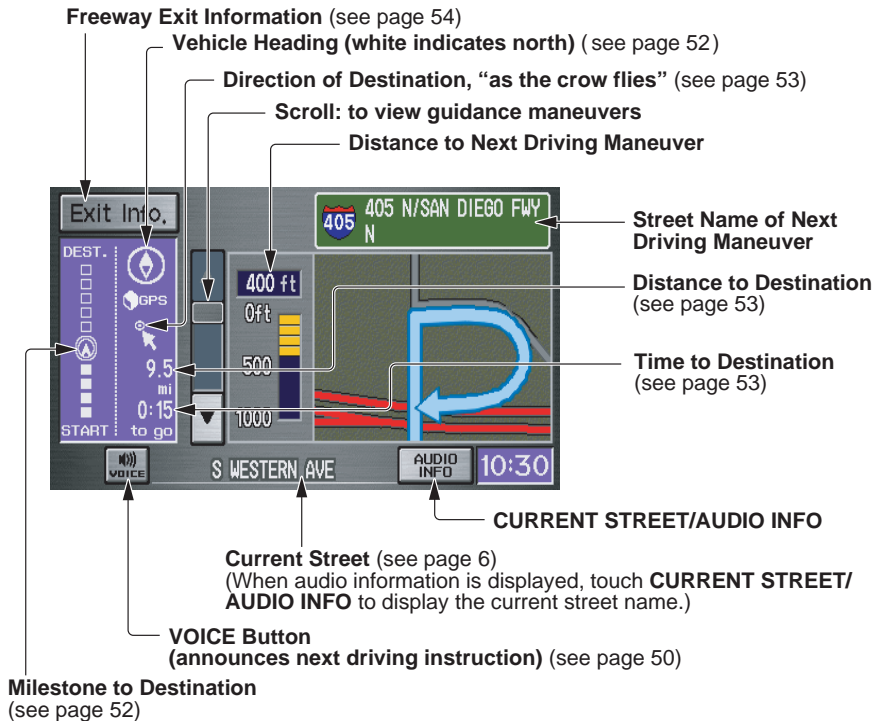

Distance and Time to Destination

When you select a destination, the distance to the destination is the actual road distance of the calculated route, and not “as the crow flies.” When viewing a list of destinations (points of interest), such as restaurants, the distance is “as the crow flies” (see *Sort by Distance to Travel* on page 36).

The displayed time to the destination may differ from the actual travel time because the time is calculated based on the posted road speed data and your current speed. If part of your route includes unverified roads, the “distance” and “time to go” for that portion is estimated using 25 mph as an average speed.

Direction List

When you press the **MAP/GUIDE** button on the guidance screen, the display changes to:

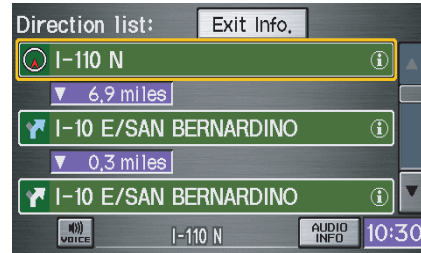

NOTE:

- *The map and voice guidance in unverified areas differ from those in verified areas. See Unverified Area Routing on page 85.*
- *Only maneuvers that occur at freeway exits or contain freeway exit information will show the exit info icon (i) on the right end of the items in the Direction list. If no exit info icon is shown on the list, the **Exit Info.** is grayed out.*

You can see the Direction list and the distance to each maneuver. Press the **MAP/GUIDE** button to return to the previous screen.

You can scroll through the Direction list screen by screen using the scroll bar, or one instruction at a time using the joystick.

Driving to Your Destination

Exit Info. (Freeway Exit Information)

You can search freeway exit information and add new destinations or waypoints to the calculated route as a new destination or waypoint. The exit info icon (i) on the right end of the items in the direction list indicates that there is freeway exit information available. Say or select **Exit Info.**, and choose the exit and place to set as a new destination or waypoint.

On the map screen, you can display freeway exit information using the joystick. The exit info icon will only be displayed on the map screen if there is any freeway exit information available. Choose the 1/4, 1/2, or 1 mile scale, then move the crosshairs to the desired exit info icon and click on it. Choose a place from the list and set it as a new destination or waypoint.

NOTE:

To turn on “Freeway exit information” on the map screen, display the icon bar and select the i icon (see page 59).

Guidance Mode

When en route to a destination, you have two display options: single-screen mode (the factory default) and split-screen mode.

Single-screen mode – A map is displayed with occasional guidance pop-up windows as you approach a maneuver.

Split-screen mode – The map is always displayed on the left of the screen, and the maneuver or direction list is displayed on the right-hand side of the screen.

Guidance mode can be changed in either Setup (see *Guidance Mode* on page 92), or by accessing the icon bar (see *Guidance Mode* on page 59).

When you get near the maneuver, the map screen changes to:



On the map screen, the location of the maneuver is marked with a small yellow square. The guidance window is simply an enlargement of the area indicated by the yellow square. After you complete the maneuver, the display returns to a full map screen when the single-screen mode is set, or to a map and direction list screen when the split-screen mode is set.

Map Scale

Use the **ZOOM** buttons or say a voice command such as “Display 1/2 mile scale” (see page 141) to change the scale of the map. Zooming in increases the detail, while zooming out gives you a view of a wider area. After changing the scale, give the system a few moments to update the display.

Functions available at various map scales

Map Scale (English and Metric) For selecting units, see page 94.		1/20 mi.	1/8 mi.	1/4 mi.	1/2 mi.	1 mi.	2 mi.	5 mi.	15 mi.	50 mi.	150 mi.	350 mi.
		80 m	200 m	400 m	800 m	1.6 km	3 km	8 km	24 km	80 km	240 km	560 km
POI icon symbols (like ATM)	page 57	X	X									
Breadcrumbs (off-road tracking dots)	page 61	X	X	X	X							
Freeway exit information icons	page 54			X	X	X						
One-way traffic icon	page 57	X										
Unverified road display (light brown)	page 85	X	X	X								
Map orientation “Heading-up”	page 56	X	X	X	X	X						
Map orientation “North-up”	page 56	X	X	X	X	X	X	X	X	X	X	X
Map features (park, golf course, etc.)	page 51	X	X	X	X	X	X	X	X	X	X	
Avoid area shown on map	page 89	X	X	X								
Avoid area scales (when creating)	page 89	X	X	X								
Waypoint “flag” icons	page 64	X	X	X	X	X	X	X	X	X	X	X

NOTE:

- You can change between miles or kilometers in Setup (see Units on page 94).
- For information on the available voice commands, see Voice Command Index on page 140.

Driving to Your Destination

Map Orientation

The map can be orientated two ways:

- North-up: North pointing up as you would normally view a paper map.
- Heading-up: The map constantly rotates so the road you are driving on always points up (as you see the road through your front windshield).



“North Up”



“Heading Up”

NOTE:

The red arrow in both heading symbols always shows the direction north.

Touch the Map Orientation icon on the map screen to switch between the available orientation, or say “Display heading up” or “Display north up.”

In the larger map scales (above 1 mile or 1.6 kilometer), the map is always oriented with north facing upward. You cannot change the orientation.

NOTE:

For information on the available voice commands, see Voice Command Index on page 140.

Destination Icon

The destination icon only shows the approximate location of the destination. This occurs because a city block can have as many as 100 possible addresses (for example, the 1400 block is followed by the 1500 block). Most cities use only a portion of the 100 possible addresses (for example, in the 1400 block, the addresses may only go up to 1425 before the 1500 block starts). Therefore, the address 1425 will be shown a quarter of the way down the block by the system instead of near the end of the block where the destination is actually located.

Tip:

When en route, you can view a map showing your destination. Using voice control, say “Display destination map.”

The display automatically changes to the map screen when you reach your destination. Press the **MENU** button to return to the Enter destination by screen.

NOTE:

- For information on the available voice commands, see Voice Command Index on page 140.
- If you are en route and the joystick is moved, the “Time to Destination” and “Distance to Destination” indicators are replaced with an indicator showing distance from the current vehicle location.

Landmark Icons

Landmark icons are shown in the map screen on the 1/20 and 1/8 mile scales or 80 and 200 meter scales. The Freeway Exit information is displayed on the 1/4, 1/2, and 1 mile scales. The icons are:

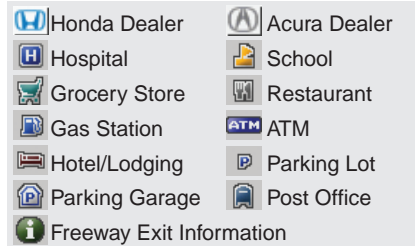

Some icons can be turned on or off; you can either display them or hide them from the **ICON** button on the lower left corner (see page 51) or using voice commands (see page 140).

You can select most landmark icons with the joystick to display the icon’s information. See the table on the following page for exceptions.

NOTE:

- The same list can be viewed on the screen by selecting **Map Legend** from the Information screen.
- When there are overlapping landmark icons, a list of the points of interest (POIs) is displayed.
- For information on the available voice commands, see Voice Command Index on page 140.

One-Way Traffic Icon

The one-way traffic icons (see *Map Screen Legend* on page 51) are only shown on the 1/20 mile scale and only when turned on in **Icon Options** (see page 59).

Driving to Your Destination

For some icons, you can choose either to show or hide them on the map, while others like Honda Dealer are always shown. The table below shows the features for each icon type. Some Points of Interest (POIs) like Police Stations are not shown as an icon, but you can still locate the nearest one with the voice command, “Find nearest Police Station.”

POI type	Icon can be manually displayed	Icon can be manually hidden	Icon selection by voice	Icon can be selected as a destination on the map screen with the joystick	POI can be found on the map screen using voice command “Find...”
Honda/Acura dealer	Yes, always	No	No	Yes	Yes
Hospital	Yes	Yes	Yes	Yes	Yes
School	Yes	Yes	Yes	Yes	Yes
ATM	Yes	Yes	Yes	Yes	Yes
Gas station*1	Yes	Yes	Yes	Yes	Yes
Restaurants*1 *2	Yes	Yes	Yes	Yes	Yes
Post office	Yes	Yes	Yes	Yes	Yes
Grocery store*1	Yes	Yes	Yes	Yes	Yes
Hotel*1/Lodging	Yes	Yes	Yes	Yes	Yes
Police station	No icon	No icon	No	No	Yes
Shopping, Tourist attraction, Bank	No icon	No icon	No	No	Yes
Parking garage/Parking lot	Yes	Yes	Yes	Yes	Yes
Freeway exit information	Yes	Yes	Yes	Yes (choose POI)	No
One-way traffic icon	Yes	Yes	Yes	No	No

*1 When these types are selected for view on the map, some icons are shown as “brand icons.”

*2 The **Icon Options** feature found on the **Icon Bar** screen allows you to customize your choice of the displayed icons. See *Showing Icons on the Map* on page 59. Also see the *Voice Command Index* on page 141 for the “Display,” “Hide,” and “Find” commands.

Showing Icons on the Map

Touching the **ICON** button on the map screen displays the following screen:

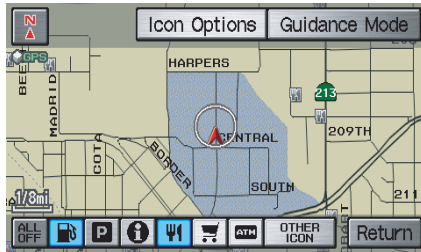

The screen consists of the following items:

Icon Bar (row of icon symbols)

The icon bar allows you to manually select the icons that are displayed on the map (see page 57 for a list of these icons). In the screen above, both gas stations and restaurants are selected. Touch the icons to select (goes blue) or remove them (goes gray). You can also display or hide the same icons by using the “Display” or “Hide” voice commands (see page 141).

Icon Options

This feature allows you to “fine tune” some of the icons on the **Icon bar** (see *Icon Options* for more information).

Guidance Mode

When en route, this item allows you to select between a single-screen (with occasional pop-up guidance windows), or a split-screen (containing one-half map and one-half guidance/directions list window). See page 54 for an explanation of this feature, and see page 92 for Setup.

Exit Screen

Select **Return** to return to the map screen.

Icon Options

Selecting **Icon Options** displays the following screen:

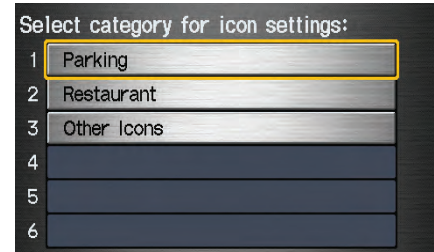

This feature allows you to “fine tune” some of the icons on the **Icon bar**. The three icon choices – “Parking” (lot or garage), “Restaurant” (specific type or types of food), and “Other icons” (hospitals, schools, etc.) – can each be tailored to your needs.

Driving to Your Destination

For instance, let's assume that hospital icons are not displayed on the map. You would do the following:

- First, you would ensure that the **OTHER ICON** button on the Icon bar is blue (see *Icon Bar* on page 59).
- Second, you select **Icon Options** and verify that hospital option is also on (blue). This procedure is explained below.

If you select **Other Icons** from the Select category for icon settings screen, the other icons options are displayed:

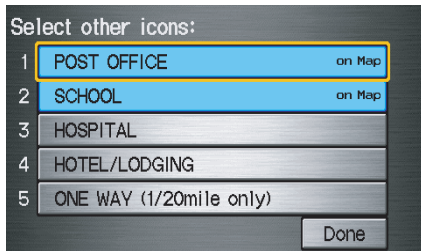

In the previous example, **POST OFFICE** and **SCHOOL** are selected and will show up on the map. To also see **HOSPITAL** on the map, this would need to be turned on to select it so it appears as below.

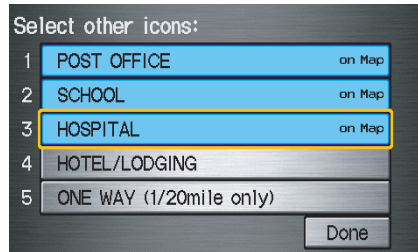

Exit, and save your settings by selecting **Done**.

NOTE:

- When viewing the map screen, you can turn some icons on using voice control.
- See Navigation Display Commands on page 141 for the available “Display” and “Hide” icon command.

Going Off the Route

If you leave the calculated route, “Recalculating...” is displayed at the top of the screen. The system will recalculate the route from your current location and direction to the desired destination, and then give you a new route instruction. This is done automatically if you have set **Rerouting to Automatic** on the Setup screen (second) (see page 84).

If the **Rerouting** option in Setup is set to **Manual**, “Off route” appears at the top of the screen when you leave the calculated route. Say “Recalculate” or select **Recalculation** whenever you wish the system to perform a recalculation.

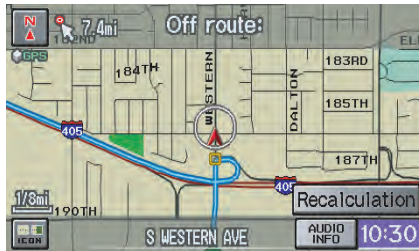

Off-road Tracking

If you drive more than half a mile from a mapped road, “Not on a digitized road” appears at the bottom of the screen.

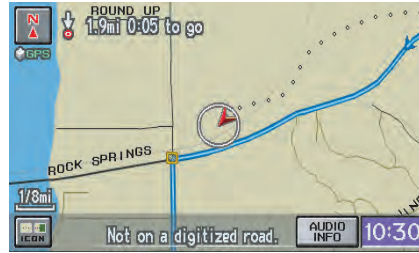

The map screen starts displaying a series of dots (breadcrumbs) to show the path you have taken if **Off-road Tracking** on the Setup screen (second) is set to **On** (see page 92).

By following the dots, you can backtrack to the mapped road you originally left. “Breadcrumbs” may occasionally be displayed in urban areas, such as large parking lots in shopping malls, or in new subdivisions where the roads are not yet in the database. In other cases, you may see dots if the system temporarily goes off route, like in a parking garage where the GPS signal is unavailable.

These dots appear only in the 1/20, 1/8, 1/4, and 1/2 mile (or the 80, 200, 400, and 800 meter) map scales. Use the **ZOOM** buttons to change scales if necessary.

Tracking continues for approximately 150 miles; dots at the beginning of the trail will start disappearing when you exceed that distance. When you reach a mapped road, the system stops displaying dots.

Driving to Your Destination

Viewing/Saving the Current Location

Whenever you are on a map screen, you can always obtain your current location either by touching the Vehicle Position icon  or by using the voice control system and saying “Display current location.” A screen pops up which shows the address of your current location, as well as the latitude, longitude, and elevation.

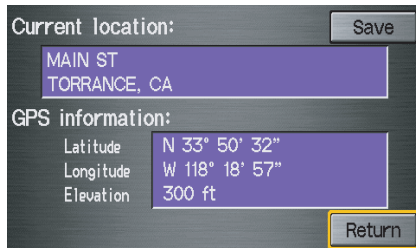

NOTE:

The elevation will not appear when the system is temporarily lacking proper GPS information. The system elevation may not agree with elevations shown on roadside elevation signs, and may fluctuate plus or minus 100 feet or more.

You can store the current location for later use. It does not change or cancel your current route.

For example, you are following the system’s directions to get to a destination. While sitting at a stoplight you notice a store on the corner, but do not have time to visit it right now. You can save the location to select as a destination at a later date.

To save the location, say “Save current location” or select **Save** on the screen. When you select “User 1” or “User 2,” the **Edit address book** screen with the current location data will appear. You can edit the name, phone number, or category name to be saved in your personal Address Book.

After the location is saved, select **Return** to return to the map screen. You can then use **Address Book** from the **Enter destination** by screen to select the saved location and return to the same spot.

Pop-Ups and Disclaimers

When you say "OK" in the Calculate Route to screen, or if you change your route, the system checks your route and provides you with pop-up messages for the following situations:

- Your route takes you into an area that you previously set as an "Avoid Area" (see *Edit Avoid Area* on page 89).

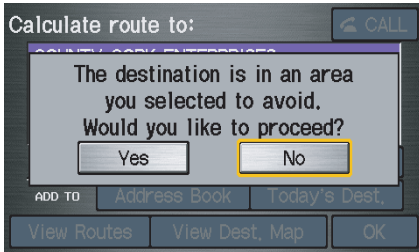

- Your route passes near an unverified area (see *Unverified Area Routing* on page 85).

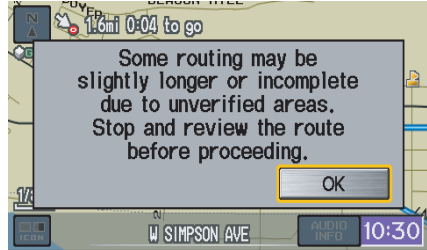

- Your route includes unverified areas (see *Unverified Area Routing* on page 85).

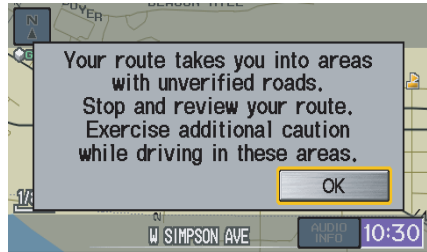

- You are about to enter an unverified area (see *Unverified Area Routing* on page 85).



- You actually entered an unverified area (see *Unverified Area Routing* on page 85).

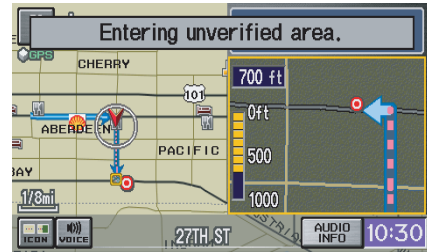

Driving to Your Destination

Changing the Route

While en route, you may wish to alter your route, add an interim “Waypoint” (pit stop), choose a different destination, or cancel your current destination.

To change your present route, you can do any of the following:

Say “Menu,” or press the **MENU** button to view the **Change route by screen**:

- Search waypoint (page 64)
- Delete waypoint (page 66)
- Avoid streets (page 66)
- Detour (page 66)
- Change routing method (page 66)
- Cancel the current route (page 67)
- Back to the current route (page 67)

Choose a different destination (other methods) by:

- Saying “Find nearest...” to find a POI (page 67).
- Saying “Go home” (page 67).
- Using the joystick to select a different POI or address on the map (page 67).
- Pressing the **MENU** button twice to get to the **Enter destination by screen** (page 69).

Change Route By Screen

Pressing the **MENU** button displays the **Change route by screen**:

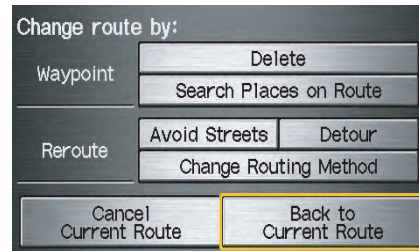

Waypoints

Waypoints allow you to add an interim “pit stop” while traveling to a destination. For instance, you may want to stop for gas or food, and then continue on to your destination. Although you can enter up to five waypoints at a time, typically you may never use more than one at a time. Waypoints are routed to in the order they were entered (number 1 first, etc.), with your final destination routed to last. If you wish to create a custom route of several destinations, and then control the order of routing, the function “Today’s Destinations” is probably a better choice (see *By Today’s Destinations* on page 42).

When you enter waypoints, they appear on the map screen as small red flags numbered 1-5.



Adding Waypoints

From the **Change route** by screen, if you say or select **Search Places on Route**, then the **Select a search method** screen is displayed. Select either **Places Along the Route** or **Places Around the Destination**.

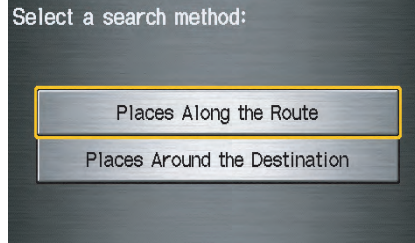

Next, select your “Waypoint Category,” then follow the menu prompts to select a destination. When the system performs a search from **Places Along the Route**, it displays matches that lie within a corridor on either side and in front of you along your route.

From **Places Around the Destination**, the system displays matches in a spiral pattern outward from the destination. The search “corridor” distance value can be changed in **Edit Waypoint Search Area** in Setup (see page 91).

To add another waypoint, press the **MENU** button and repeat the procedure. If **Search Places on Route** is grayed out, the maximum of five waypoints has been entered.

NOTE:

The system does not allow you to select the roads you want to use to get to a destination. However, after you enter a destination, you can select intersections or POI waypoints that the system will use to tailor your route.

Driving to Your Destination

Deleting Waypoints

From the Change route by screen, if you say “Delete” or select **Delete**, then the **Select a waypoint to delete** screen is displayed. Say the line number of the waypoint(s) you wish to delete, or select them by using the joystick. Say or select **Done** to return to the map screen.

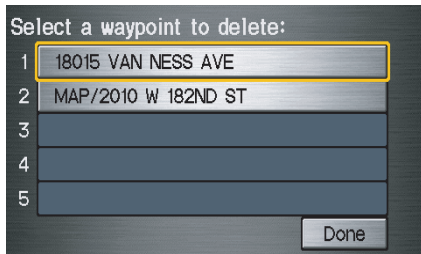

The route is recalculated to reflect the changes you made to the waypoint(s).

Reroute: Avoid Streets

From the Change route by screen, if you say or select **Avoid Streets**, the system displays a list of streets that will get you to your destination. This feature allows you to avoid a street or streets along your route. This is helpful if you know of road construction, closures, or excessive traffic along the route. Simply select the street or streets you wish to avoid. You cannot avoid your current street, or the streets of your waypoint(s) or destination (system beeps if selected).

NOTE:

Although you can choose streets to avoid, you cannot choose specific streets you want to use.

Reroute: Detour

Calculates a detour route for you if you encounter an unexpected obstacle such as a closed road or extremely heavy traffic congestion. If a detour is selected, the system will attempt to recalculate a new route, avoiding the next 2 miles (while on a freeway) or 1/2 mile (while on a surface street).

Reroute: Change Routing Method

From the Change route by screen, if you say or select **Change Routing Method**, then the **Select routing method** screen is displayed. See *Changing the Routing Method* on page 47 for details.

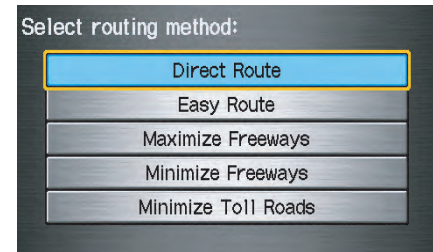

Cancel Current Route

Cancels the current route (and any waypoints) and returns you to the map screen.

Back to Current Route

Returns you to the original map screen.

Changing Your Destination

There are four methods by which you can change or add a waypoint to your route. These are:

Find Nearest (Voice command)

From the map screen, say one of the “Find Nearest...” voice commands to locate the nearest gas station, ATM, restaurant, or other point of interest. See the “Find Nearest” voice commands listing on page 142.

Go Home (Voice command)

From the map screen, say “Go home.” If you have entered a “Go home” address, then the system will display a confirmation screen.

Using Joystick to Change Destination

While following a calculated route, you can select a new destination with the map screen and the joystick.

With the map screen displayed, use the joystick to move the position icon. It will change to crosshairs. Use the joystick to position the crosshairs on your desired new destination, street, or icon, then push in on the joystick. The Select a place screen or the address of the location will be displayed.

NOTE:

The Select a place screen will be displayed when the crosshairs are positioned near multiple icons or locations. The address of the location will be displayed at the top of the screen when the crosshairs are positioned on a particular street, icon, or location.

If this is not your desired new destination, press the **CANCEL** button or the **NAVI BACK** button on the steering wheel to return to the map screen. Reposition the crosshairs with the joystick, then push in on the joystick again to see the new address.

Driving to Your Destination

When the **Select a place** screen is displayed, select an item from the list, and the **Calculate route to** screen is displayed. After you select **OK**, you can select either **Set as New Destination** or **Set as Waypoint** for your specified position.



When the address of the location is displayed at the top of the screen, push in on the joystick, and the **Calculate route to** screen will be displayed. After you select **OK**, you can select either **Set as New Destination** or **Set as Waypoint** for your specified position.

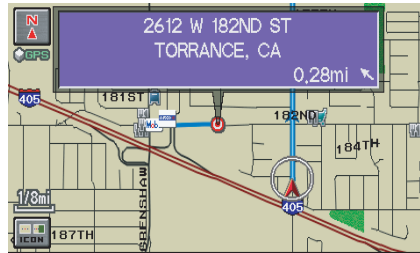

The system will return to the map screen and recalculate the route to your new destination or waypoint.

NOTE:

When you scroll through the map screen while en route to a destination, some voice controls will not function. These include:

- Display “Heading up”
- Display “North up”

Entering a Destination from the Menu Screen (while en route)

If you say “Menu” or press the **MENU** button twice, the system displays the Enter destination by screen. Follow the procedure described in *Entering a Destination*, which begins on page 22. After selecting **OK** to the Calculate route to screen, your new location can be used either as a waypoint or as a replacement destination.

Continue Trip Screen

If you restart the vehicle without having completed your prior trip, you will see the following screen:

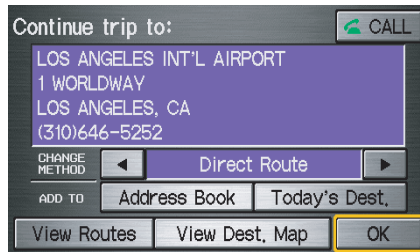

- To continue to your destination or other waypoints, say or select **OK**.
- To cancel your destination, press the **CANCEL** button or the **NAVI BACK** button on the steering wheel, or using the voice control system, say “Cancel” or “Back.”
- If you wish to change the route method, say or select **CHANGE METHOD**.
- For additional information on changing the routing method, see *Changing the Routing Method* on page 47.

Information Features

Information Screen

When you say “Information” or press the **INFO** button, the display changes to:

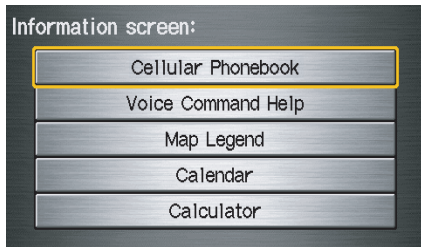

NOTE:

*If some items appear to be grayed out and cannot be selected, it is because you did not select **OK** on the initial Disclaimer screen (see System Start-up on page 16), or there is no phone paired to the system (see Bluetooth® HandsFreeLink® on page 18).*

Cellular Phonebook

The **Cellular Phonebook** option allows you to store up to 1,000 names and 10,000 phone numbers in the phonebook of *Bluetooth®* HandsFreeLink® from your cellular phonebook. With HFL, you can then automatically dial any name or number in the phonebook. Say or select **Cellular Phonebook** from the Information screen, and the display changes to:

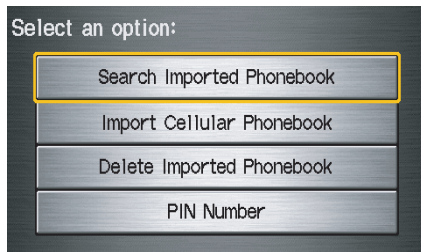

NOTE:

- For more information on this feature, see your *Owner's Manual*.
- For questions about the HFL Cellular Phonebook, call HandsFreeLink customer support at (888) 528-7876, or visit handsfreelink.honda.com. In Canada, call (888) 9-HONDA-9.

Voice Command Help

When you say or select **Voice Command Help**, you will see the following screen:

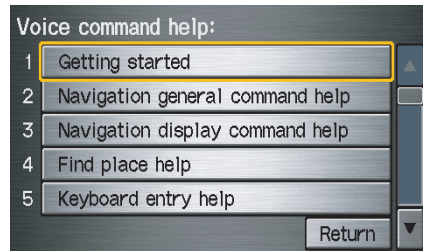

NOTE:

You can select an item by saying either the line number or the item name.

There is a tutorial available for the voice command help. Say or select **Getting started**, and the display changes to:

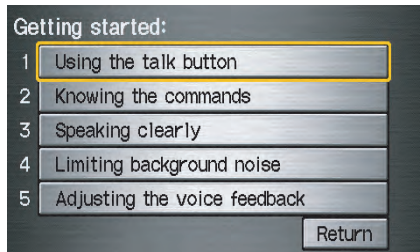

Select the line number of the desired tutorial you want to view, and the tutorial will automatically be read. Press **Stop** to stop the reading, or press the **CANCEL** button.

When you make a command help selection under any of the help screens, you will see the help commands that can be used with the voice control. You can say or select **Read List**, and the system will read the list to you.



For a listing of all voice commands, see *Voice Command Index* on page 140.

Map Legend

You can use the Map legend screens to learn the meaning of map features, icons, colors, etc. used in this system. When you say or select **Map Legend**, the display changes to:

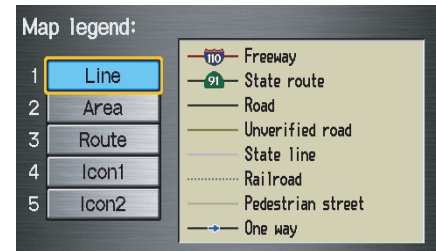

Say or select the desired item or item number to view each section of the map legend.

Information Features

Calendar

The **Calendar** option allows you to enter events and be reminded of them in the future. When you say or select **Calendar**, the system shows the calendar with the current calendar day highlighted.



Dates with an icon indicate there is a scheduled entry for that date.

You can scroll through the calendar day by day by moving the joystick, or select the day by voice. To change the month, say “Next” or “Previous,” use the **ZOOM** buttons, or touch the triangles at the top of the screen.

If you say or select **List**, your entries are listed. Press the **CANCEL** button to return to the **Calendar** screen.



Entering Your Schedule

Set your schedule by selecting the day on the calendar, and the display changes to:

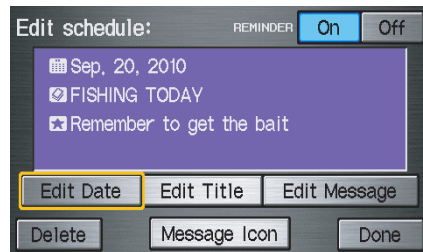

Reminder

The default for Reminder is **On**. This allows the system to remind you of the calendar item the next time you start the vehicle. See *System Start-up* on page 16.

Edit Date

This allows you to move your calendar entry to a different date. If you say or select **Edit Date**, the **Calendar** screen is displayed with existing entries grayed out. Select a new day and the display returns to the **Edit schedule** screen with a new date.

Edit Title

Say or select **Edit Title**, then enter the name of your title using the on-screen keyboard. Once you have entered the title, say or select **Done**.

Edit Message

Say or select **Edit Message**, and the system will show the Edit Message screen. You can enter a message on two lines. Use  to change the line. Once you have entered the message, say or select **Done**.

Message Icon

Say or select **Message Icon**, and the system displays a list of icons you can select to help identify the type of message you entered. The message icon you choose will be displayed alongside the specified date on the **Calendar** screen.

Delete

From the **Calendar** screen, select the date of the schedule you wish to remove. To remove the schedule, say or select **Delete**.

Done

Once you have finished entering the schedule, say or select **Done**. The **Calendar** screen is redisplayed and a message icon appears.

NOTE:

- *Only one entry can be stored for each calendar day.*
- *A maximum of 50 entries can be stored in the schedule. After you reach 50 entries, a warning message will appear telling you that the limit has been reached. You can clear any older entries as needed.*
- *To reactivate a previous message, turn the Reminder setting from **Off** to **On**. If it is not turned on, the reminder will not be displayed when you start the vehicle.*
- *The system displays active calendar entries only after you answer **OK** on the Disclaimer screen.*
- *For more information, refer to **System Start-up** on page 16.*

Calculator

When you say or select **Calculator**, the display changes to:

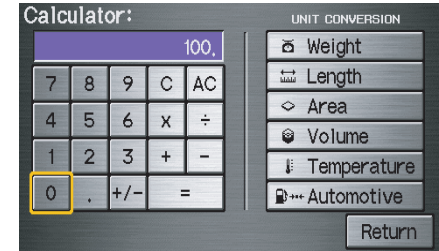

Use the touch screen to use the following features:

Calculator

The calculator function operates like a standard handheld calculator.

Unit Conversion

Values entered on the calculator can be converted from one unit to another (e.g., inches to millimeters).

Information Features

Unit Conversion

To perform a conversion:

1. Enter a numeric value to be converted (for example, 100).
2. Select the type of unit you want to convert (for example, weight). The screen for that conversion type appears (see illustration in step 3).
3. Select the base unit (e.g., pounds) that you wish to convert to some other unit. All other units will change automatically depending on the base unit value. In the example below, 100 lbs converts to 1600 ounces, 0.05 ton (U.S.), etc.



NOTE:

- If you do not enter a value to be converted, only "Temperature" units are selectable.
- Conversions using negative value may produce meaningless or physically impossible values.

Setup Mode

The Setup function consists of two different screens that allow you to change and update information in the system. To display the Setup screens, use the voice control system and say “Setup” or press the **SETUP** button. To change to another Setup screen, say or select **More** in the upper right corner of the screen.

On any of the Setup screens, you can use the voice control system to select any item on the screen.

NOTE:

- If some items appear to be grayed out and cannot be selected, it is because you did not select **OK** on the initial Disclaimer screen. See System Start-up on page 16.
- For information on the available voice commands, see Voice Command Index on page 140.

Setup Screen (first)

From any screen, say “Setup” or press the **SETUP** button, and the following screen appears:

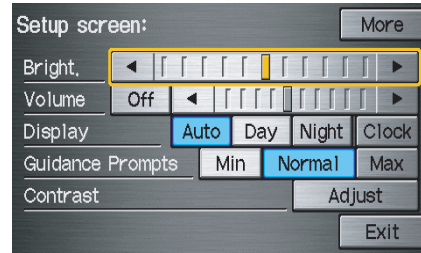

Brightness

The screen brightness has 11 settings. To change the brightness, use the voice control system and say “Brightness up” or “Brightness down.” You can also select the **Bright.** bar and move the cursor by moving the joystick left or right, or by touching the arrowheads in the bar.

Tip:

If you are having trouble viewing the screen in bright lighting conditions, try increasing the brightness.

NOTE:

You can have a separate daytime and nighttime setting for brightness. Adjust each setting when the display is in either daytime or nighttime mode.

Volume

The navigation voice volume has 10 settings, and also can be turned off. To adjust the volume, use the voice control system and say “Volume up” or “Volume down.” You can also select the **Volume** bar and move the cursor by moving the joystick left or right, or by touching the arrowheads in the bar. After adjusting the volume, you will hear beeps at the new volume level. You can also select volume off.

NOTE:

If you turn the volume off, you will not hear route guidance or voice command confirmations.

System Setup

Display

There are two screen display modes:



Day and **Night**. The recommended setting is **Auto**, which automatically switches the screen between **Day** and **Night** modes as you turn the headlights on or off.

You can select **Day** or **Night** mode to override the **Auto** mode. This is a useful feature for drivers that like to use headlights during the day and want to temporarily override **Night** mode. However, the screen in **Day** mode will be extremely bright at night.

Display Mode	How setting affects display mode:	To override setting while driving:	But remember:
Auto (factory default)	Automatically switches between Day and Night mode by sensing if the headlights are on.	Override night display: Adjust dash brightness (with headlights on) to full bright. Override day display: Turn on headlights and ensure the dash brightness is not at full bright.	Adjust the dash brightness (with headlights on) back to normal to allow auto switching by sensing headlights.
Day	Stays in Day mode.	Push and hold the joystick for 10 seconds (switches to Night mode).	There is no auto Night/Day mode change with the headlights on/off. You control the setting.
Night	Stays in Night mode.	Push and hold the joystick for 10 seconds (switches to Day mode).	There is no auto Night/Day mode change with the headlights on/off. You control the setting.
Clock	Displays the clock on the screen.	To return to the previous screen, press the NAVI BACK button.	Touch any button to return to your last screen.

When you select **Clock** in Setup or the Disclaimer screen times out, the clock screen is displayed (see page 17).

DISPLAY OFF

When you touch the **DISPLAY OFF** button, the screen is turned off. Voice guidance will continue to work in this mode. To turn on the screen, press any navigation or voice control button.

Clock Type

Allows you to choose the design of the clock screen from one of three **Clock Types** and one of two **Background** images.



Say or select **Return** to return to the previous screen.

Guidance Prompts

While you drive to your destination, the system displays and announces guidance prompts for your next maneuver. This setting allows you to adjust the number of guidance prompts before each maneuver. The settings **Min**, **Normal**, and **Max** are described below. The factory default is **Max**, so you can adequately prepare for the next maneuver. If you wish to change the number of guidance prompts, select your preferred setting, as shown in the following table.

Setting	Distance before maneuver		
	About 1/2 mile	About 1/4 mile	Just before maneuver
Min		Yes	
Normal		Yes	Yes
Max (factory default)	Yes*	Yes*	Yes

*Uses street name in guidance phrase.

NOTE:

To temporarily turn off voice guidance prompts, select **Off** for the "Volume" setting in Setup.

Contrast

You can adjust the contrast and black level. Adjusting these settings can make the display easier to read.

NOTE:

You can have separate daytime and nighttime settings for Brightness, Contrast, and Black Level. Adjust each setting when the display is in either daytime or nighttime mode.

System Setup

Setup Screen (second)

Say or select **More** to view additional Setup functions and the following screen appears:

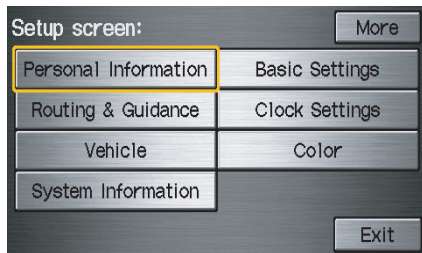

Personal Information

From the Setup screen (second), say or select **Personal Information** and the following screen appears:

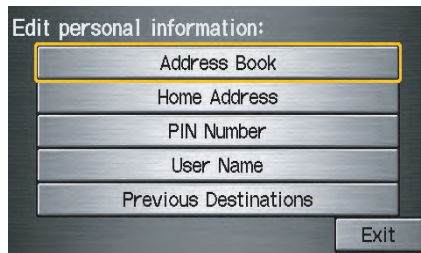

Address Book

The Address Book allows up to a total of 200 address entries. After 200 entries, the ADD TO **Address Book** button is grayed out. The 200 addresses are shared between User 1 and User 2. For example, if User 1 has 150 addresses, User 2 can only have 50.

You can add, modify, and delete information in the personal Address Book list.

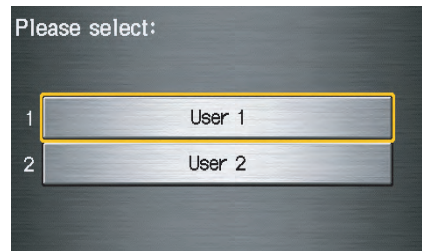

You may choose to use a Personal Identification Number (PIN) to protect your privacy. However, PINs are optional, and if you decide to use one, record it in case you forget the number (see page 82).

You can do the following functions in the address book:

- Enter an address (see page 79).
- Edit an existing address (see page 81).
- Delete an existing address (see page 81).

Accessing the Address Book List

After selecting **Address Book**, the system prompts you to select **User 1** or **User 2**.

If an Address Book PIN has been set, the system prompts you to enter your PIN. Verify that the correct user is displayed, then enter your PIN. After entering your PIN, say or select **Done**, and the system displays your Address Book.

If no Address Book PIN has been set, the system displays your Address Book after selecting **User 1** or **User 2**.

NOTE:

Personal information cannot be backed up or moved to another navigation system.

Entering an Address

After you select **User 1** or **User 2**, your Address Book list appears:

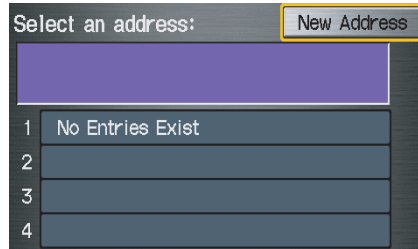

Select **New Address** in the upper right corner on the screen when beginning to build your Address Book list.

Edit Name

You may use the “Name” field to give the entry a name or title that you will recognize later, such as “Doctor Smith” or “Broadway Theatre.” If you do not give the address a name, the system will assign one (Address 001, etc.).

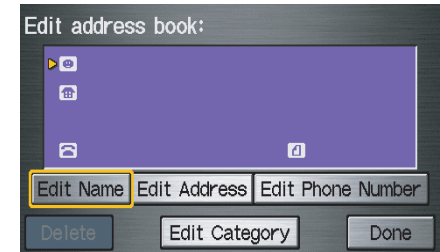

Say or select **Edit Name**. Then use the on-screen keyboard to enter the name. Touch **Done** when finished.

NOTE:

You can always re-enter, edit, or make changes to any entry. “Address” is the only required field.

System Setup

Edit Address

When you say or select **Edit Address**, the display changes to:



Current Position - Allows you to use your current position as the address.

Address - Requires you to enter the city and address you wish to store. The operation is the same as selecting **Address** from the Enter destination by screen (see page 23).

Places - Allows you to select one of the Point of Interest (POI) locations already stored in the system as one of your personal addresses. This operation is the same as selecting **Places** from the Enter destination by screen (see page 32).

Previous Destinations - Allows you to choose one of the locations in the Previous Destinations list for your Address Book list. This operation is the same as selecting **Previous Destinations** from the Enter destination by screen (see page 41).

After you have used one of these four options to enter the address, the initial screen for entering the personal address is redisplayed, with the address shown in the "Address" field. If you have entered the address using **Places**, the phone number corresponding to the address also appears in the "Phone Number" field.

Edit Phone Number

You can enter the telephone number of the address. If the address was chosen with **Places**, and it has a telephone number, that number is entered automatically.

Say or select **Edit Phone Number** to display the Enter phone number screen. Enter the telephone number, including the area code, by using the voice control system (say the entire phone number one digit at a time) or by using the on-screen keyboard. Say or select **Done** when finished.

Edit Category

If desired, you can specify the category of the address. Say or select **Edit Category** to display the **Select a category** screen.

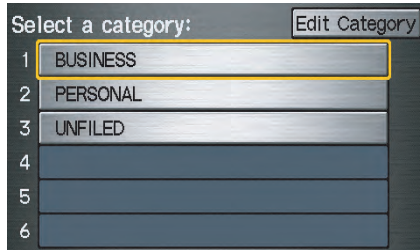

Scroll the screen and select a category by saying the number next to your choice, or by touching the item.

If you wish to set, add, or edit a new category, select **Edit Category** in the upper right corner on the screen. The system will show the **Select a category** to edit screen. Follow the on-screen prompts to add, change, or delete a category.

If you delete a category that was used to categorize addresses, the category for those addresses becomes “UNFILED.”

NOTE:

You may have up to 100 categories. These are shared between User 1 and User 2.

The system will then display everything that you have entered. If all the information is correct, say or select **Done**. This will return you to the Address Book list.

If you want to enter another address, select **New Address** in the upper right corner on the screen, then repeat the procedures above. If not, press the **CANCEL** button.

Edit/Delete an Address

This feature allows you to select an address to edit or delete. Once an address is selected, choose the appropriate function.

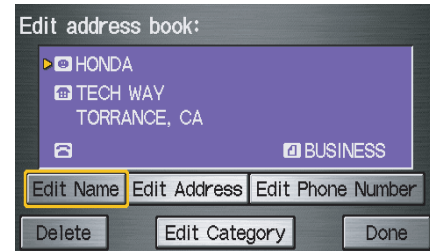

System Setup

Home Address

This feature lets you return “Home” from any location simply by saying “Go home” at the map screen. Alternatively, you can select **Go Home** on the Enter destination by screen (see *By Go Home* on page 44).

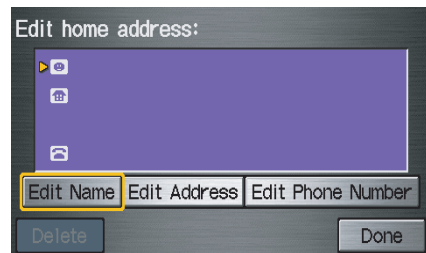

Enter the name, address, and phone number in the same way as entering a personal address, then say or select **Done**. To leave the screen, press the **CANCEL** button.

NOTE:

If your Home address cannot be found in the system, while located on the street close to your home, select “Current Position” when entering the “Edit Address” field.

PIN Number

You can set a four-digit PIN (Personal Identification Number) for accessing and changing personal addresses and your home address if desired. Once you set the PIN on this screen, the system asks you to enter the PIN when you access a personal address or your home address.

NOTE:

PINs are optional. If you choose to use a PIN, make sure you remember it. If you forget your PIN, the dealer will have to reset it for you.

When you select **PIN Number**, the display changes to:

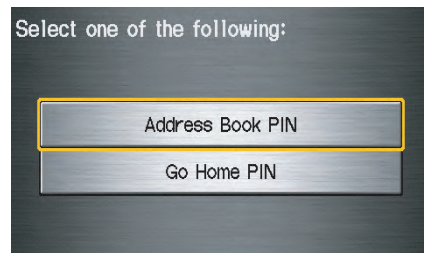

Address Book PIN

If you choose to enter a PIN for the personal Address Book, you will have to enter it any time you edit your Address Book (see page 78) or select **Address Book** on the Enter destination by screen (see page 43).

1. Select **Address Book PIN**.
2. Select either **User 1** or **User 2**. The display changes to:



3. Enter your four-digit PIN and select **Done**. If you do not wish to use a PIN, select **Do not use PIN**.

NOTE:

The factory default is no PIN.

4. If you have entered the PIN correctly, the display changes to the **Please re-enter new PIN** screen. Enter the same number, then touch **Done** to validate the number you have selected.
5. If you have entered the same number both times, the display returns to the **Edit personal information** screen. If not, “incorrect PIN” appears in the upper right corner of the screen. Enter your PIN again.

NOTE:

If you wish to remove your PIN, return to the same screen and, after entering your PIN, touch the **Do not use PIN** button.

Go Home PIN

1. Select **Go Home PIN**, and the system displays the **Enter your new PIN** screen.
2. Enter your PIN in the same way as entering the Address Book PIN.

NOTE:

The factory default is no PIN. If you choose to use a PIN, you will have to enter it whenever you say “Go Home” at the map screen or select **Go Home** on the **Enter destination by screen**.

User Name

You can change **User 1** and **User 2** to a desired name. Choose either User 1 or User 2 on the **Select the user name to edit** screen. Enter the name, and say or select **Done** to leave the screen.

Previous Destinations

Allows you to delete some or all of your previous destinations.

1. Select this option, and the display changes to:

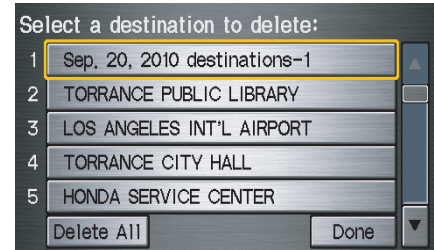

2. Scroll through the list and find the address you want to delete.
3. Select the address to delete by saying the line number, using the joystick, or touching it on the screen.

NOTE:

To cancel the deletion of **Previous Destinations**, press the **CANCEL** button before performing step 4.

System Setup

4. Say or select **Done** to perform the deletion, and the display returns to the previous screen.

Tip:

You can delete all addresses by selecting **Delete All**.

Routing & Guidance

From the **Setup** screen (second), say or select **Routing & Guidance** and the following screen appears:

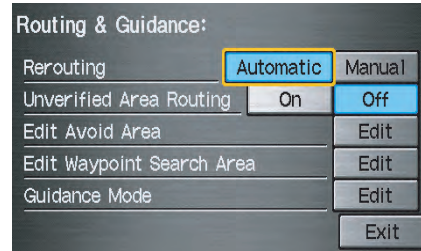

Rerouting

If **Rerouting** is set to **Automatic** and you deviate from the route, you will see “Recalculating ...” at the top of the screen for several seconds as the system calculates a new route. This is followed by new routing instructions.

If **Rerouting** is set to **Manual**, you will hear a tone when the “Off route” message is displayed. Say “Recalculate” or select **Recalculation** on the screen to make the system recalculate your new route.

NOTE:

- If you live in an area with poor mapping, you may wish to set **Rerouting to Manual** to avoid constant recalculation. However, you will have to manually select **Recalculation** on the screen to have the system plot a new route.
- It is strongly recommended that you leave the system set to the factory default (**Automatic**).

Unverified Area Routing

Allows you to receive turn-by-turn map and voice guidance in unverified areas when en route to a destination (see *Map Overview* on page 6). The chart below illustrates the routing differences with this setting On or Off.

	Unverified Area Routing: Off (factory default)	Unverified Area Routing: On
Decision: Why choose On or Off?	The driver wishes to navigate manually by using the navigation map and choosing the streets that lead to the destination. The driver understands that unverified roads may not be accurate, and can contain errors in location, naming, and address range.	The driver chooses to let the navigation system suggest possible routing. The driver understands that in some cases, guidance may not be appropriate. Unverified roads may not be accurate, and can contain errors in location, naming, and address range.
What you will see...	A blue dotted vector line is displayed on the map that continually points to your destination. The driver should stop and then use the map to select streets that lead to the destination.	A blue-pink dashed route line highlights suggested unverified streets on the map while traveling to your destination. This is in sharp contrast to the normal blue route line displayed in verified areas.
Cautionary messages	There are cautionary pop-up screens and voice announcements, before and during the route. These serve as reminders that you should obey all traffic restrictions.	There are cautionary pop-up screens and voice announcements, before and during the route. These serve as reminders that you should exercise additional caution, and obey all traffic restrictions.
Guidance (map/voice)	There is no turn-by-turn map or voice guidance.	Voice guidance commands end with the words “if possible.” This is to remind the driver to verify all traffic restrictions before making a maneuver.
Directions list	A direction list is typically not available. However, depending on your route, directions are provided to help you reach the first available verified road.	A direction list is provided showing street names and turn symbols in pink.

System Setup

Unverified Area Routing

When driving to your destination, you have the choice of using or not using “unverified” roads. You make this choice in Setup screen (second). The next few pages contain an example of a route to a destination in an unverified area explaining the routing differences found in unverified areas.

With **Unverified Area Routing Off**, the system tries to use verified roads whenever possible. In this example, since only verified streets are used, it created a longer route than necessary.

With **Unverified Area Routing On**, the route is shorter, but consists of unverified (light colored) streets that may not be accurate. Because the streets are unverified, there may be errors in street location, name, or address range. Additional caution is recommended in these areas. Always obey posted traffic restrictions.

Because both routes bypass or use unverified streets, an initial Disclaimer screen is provided. It is recommended that you stop and review the map.

Unverified Area Routing “Off”

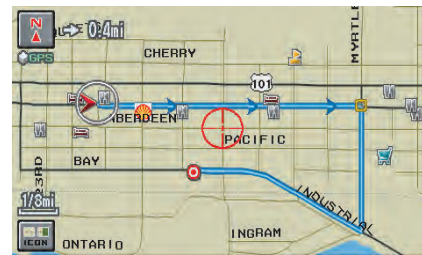
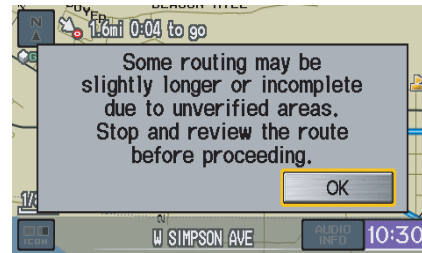

Unverified Area Routing “On”

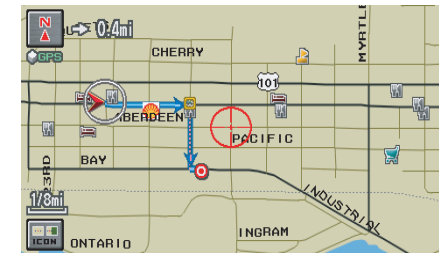
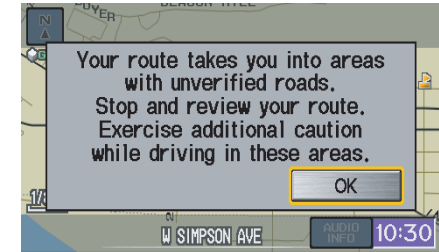

NOTE:

Unverified roads are shown only when viewing the map in the 1/20, 1/8, and 1/4 mile map scales, or the 80, 200, and 400 meter map scales.

With **Unverified Area Routing Off**, the moment you enter an unverified street, a caution box appears on the screen and is read by the voice. This lets you know that you are about to enter an unverified area and that you will be following a dotted “vector line” that points to your destination.

With **Unverified Area Routing On**, a caution box appears on the screen and is read by the voice. In this case, you will be presented with a dashed blue/pink line instead of the regular blue route line. This is your signal to pay attention to posted traffic restrictions. You cannot assume that all guidance is appropriate.

In both cases, when you actually enter the unverified street, a short caution will remind you. You will see and hear this short caution message whenever you enter unverified areas.

Unverified Area Routing “Off”

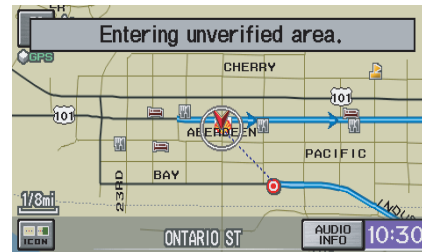
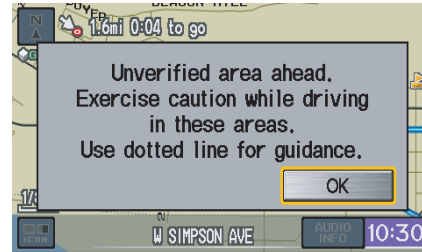

Unverified Area Routing “On”

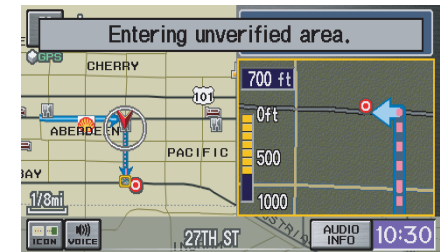
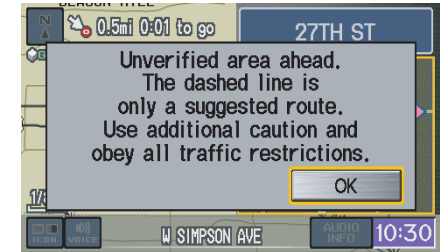

System Setup

With **Unverified Area Routing Off**, you are presented with a blue “vector line” that always points to the destination. You must manually choose streets from the map that will lead to your destination. No guidance is provided, and there are no directions to the destination.

With **Unverified Area Routing On**, a blue/pink route line is shown for unverified segments. Voice guidance commands in unverified areas always end with “if possible.” This is your signal that you should use additional caution, and obey all traffic restrictions. The maneuver window “arrow” shows any portions of unverified turns in blue/pink dashes.

These guidance maneuvers are only a suggestion. You should always confirm that the maneuver is possible. A direction list is also provided that shows any unverified roads in a blue color, with pink arrows pointing to the next maneuver.

Unverified Area Routing “Off”



NOTE:

*There is no **VOICE** button shown on the screen. With Unverified Area Routing “Off,” no Direction List is provided.*

Unverified Area Routing “On”



Edit Avoid Area

This function allows you to select areas you wish to avoid when calculating a route to your destination. You can select up to five areas to avoid. You may wish to set up an “avoid area” to route around long-term road construction, closures, or any area you wish to avoid. If you enter a route that takes you through or into an “avoid area,” a pop-up box will warn you that your route takes you into one of these areas. However, you can still choose destinations in an avoided area.

When you select **Edit** for the Setup item “Edit Avoid Area,” the following list screen is displayed:

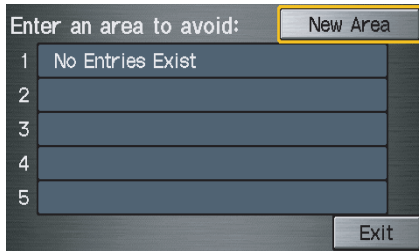

You can select **New Area** or select (by touch) one of your existing areas to modify. If you choose **New Area**, the following screen is displayed:



Say or select **Edit Name** and use the keyboard to enter the name on the Enter avoid area name screen (19 characters max). Say or select **Done** to return to the previous screen. Say or select **Edit Area** to create the area to be avoided. The following screen appears:

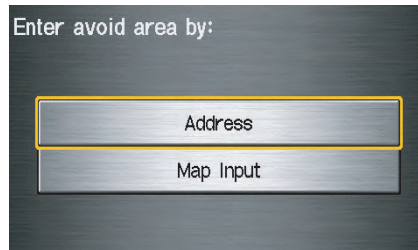

Either select **Address** or **Map Input** on the Enter avoid area by screen. Each choice provides a slightly different way to locate the approximate map display for drawing the area you wish to avoid. After selecting the choice, a map screen will be displayed.



Use the **ZOOM** buttons to select the map scale (available scales are 1/20, 1/8, and 1/4 mile scales). Use the joystick to move the crosshairs (red circle) to the desired start point and push in the joystick to “set” the start point. Then move the joystick in a straight or diagonal direction to encompass the area to be avoided.

System Setup



NOTE:

The maximum size of the “Avoid area” is 1/4 of the navigation display screen regardless of the map scale setting.

The selected area will be displayed as a shaded box with a yellow border. Push in on the joystick to set the end point of the avoided area. To “redraw” the area, touch **Cancel** and repeat the area selection process. If your selected area contains a freeway, the system will prompt you with a pop-up box saying “Do you want to avoid freeways?”

Answering “No” allows you to enter a route through an avoided area on a freeway and skip the “Avoid area caution box.” See *Pop-Ups and Disclaimers* on page 63.

Say or select **Done** to return to the **Edit area** screen. When you return, the “Vicinity” field is automatically filled in by the system. Re-edit the area “Name” if desired. Select **Done** on the **Edit avoid area** screen to finish editing. Your new avoided area will now appear on the “Avoid area” list screen and be viewable on the map screen.

NOTE:

- You can select areas to avoid, however you cannot select roads or areas that you want the system to use for routing.
- If you are drawing a box around a road as an area to avoid, then ensure the following: When you draw the box, make sure that the road or portion of a road that you encircled includes an intersection. For instance, in the example below, highway 213 will be avoided, but Van Ness will not be avoided because it lacks an intersection in the enclosed box.

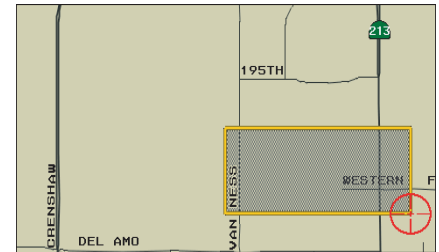

Edit Waypoint Search Area

When driving en route to your destination, you can select a temporary destination waypoint (marked with a small flag on the map) along your route for gas, a restaurant, or other POI. When you resume your trip from the waypoint, the system continues the trip to your original destination. To use this feature, see *Waypoints* on page 64.

This Setup item allows you to select the distance from your highlighted route line (on either side of your route) that the system will search for a waypoint. From the **Routing & Guidance** screen, select **Edit** for “Edit Waypoint Search Area,” and then choose the desired search distance for either “On Freeways” or “On Surface Street.”

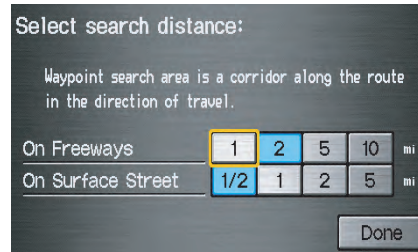

The diagram below shows how the system handles the search for “Places Along the Route” or “Places Around the Destination” (see *Waypoints* on page 64).



For “Places Along the Route,” the system looks in front of you within a corridor width specified by your values for “On Freeways” or “On Surface Street.”

The system checks the upcoming area, based on your input.

For “Places Around the Destination,” the system searches outwards in a spiral from the destination. In this case, specific search values are not needed; the matches are displayed in order of distance from destination.

NOTE:

These settings do not affect the search range used for the voice commands like “Find nearest gas station” that are also available when viewing the map screen.

System Setup

Guidance Mode

Allows you to select the guidance display mode: **Single Screen** or **Split Screen**.

To get to Guidance Mode from the Setup screen, select in sequence, “More,” “Routing & Guidance,” and “Guidance Mode.”

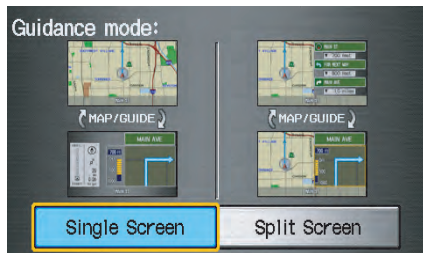

The factory default is **Single Screen**.

NOTE:

The Guidance Mode can also be selected on the Icon Selection screen. See Showing Icons on the Map on page 59.

Vehicle

From the Setup screen (second), say or select **Vehicle** and the following screen appears:

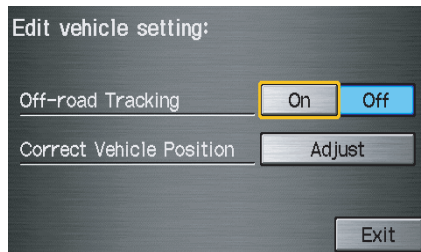

Off-road Tracking

With this **On**, the system will provide white off-road tracking dots (“breadcrumbs”) on the map screen whenever you drive into an area where the map does not show any roads. See *Map Screen Legend* on page 19.

After you have traveled approximately 1/2 mile away from a mapped road, the system will display a series of white dots on the map screen to show the path you have traveled. This is provided so you can follow the dots to backtrack to the mapped road you originally left. Tracking continues until you reach a mapped road. See *Off-road Tracking* on page 61.

Tracking is shown only in the 1/20, 1/8, 1/4, and 1/2 mile scales, or the 80, 200, 400, and 800 meter scales. Use the **ZOOM** buttons to change the scales if necessary.

NOTE:

To clear existing dots, turn this feature off and exit Setup. To re-enable this feature, return to Setup and turn it on again.

Correct Vehicle Position

The system relies on satellites for positioning information. Buildings, tunnels, and other objects can block or reflect these signals, requiring the system to use “dead reckoning” to determine your location and direction. This can sometimes lead to small errors in positioning, such as showing you on an adjacent street.

NOTE:

Using this function to adjust vehicle position is not recommended. When the system acquires a GPS signal, it will automatically place the vehicle in the correct location.

If you choose to do this, follow these steps:

1. Stop the vehicle.
2. Select **Adjust**, and the system will display a map adjustment screen.



3. Use the **ZOOM** buttons and the joystick to move the location arrowhead to the correct location. Touch the arrow buttons on the bottom of the screen to rotate the direction arrows so the vehicle position is pointing in the correct direction.

NOTE:

If you continually have to do this, there are either problems in the database or GPS reception problems. See Accessories Precautions on page 5.

4. When you have finished, press the joystick or select **Done** to return to the previous screen.
5. As you drive, the current road will be displayed at the bottom of the screen.

System Setup

System Information

From the Setup screen (second), say or select **System Information** and the following screen appears:

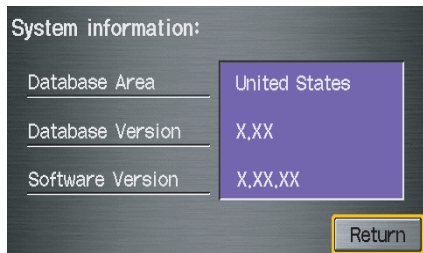

This information is for dealer use only. For ordering updates, use the version number stamped on the label (as Ver. X.XX) of the navigation DVD. See *Obtaining a Navigation Update DVD* on page 105.

When finished, say or select **Return** to return to the previous screen.

Basic Settings

From the Setup screen (second), say or select **Basic Settings** and the following screen appears:

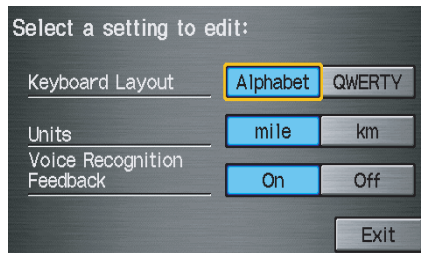

Keyboard Layout

Allows you to select the displayed keypad screen: **Alphabet** or **QWERTY**.

Units (mile or km)

Allows you to select the units for the entire system (**mile** or **km**).

Voice Recognition Feedback

Allows you to turn voice control system prompts **On** or **Off**. When **Off**, you will not hear the voice control system confirmations or prompts.

Clock Settings

From the Setup screen (second), say or select **Clock Settings** and the following screen appears:

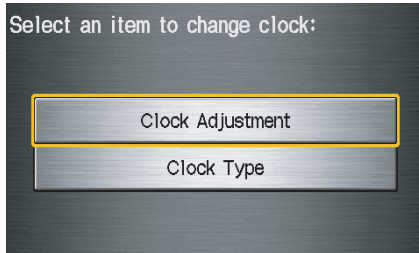

Clock Adjustment

When you select **Clock Adjustment**, the following screen appears:

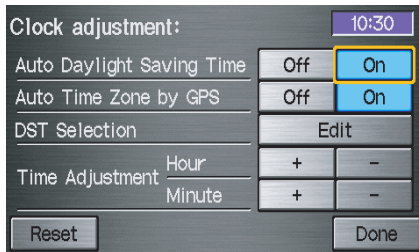

This screen allows you to set or adjust the following:

- Auto Daylight Saving Time (Default = On)
- Auto Time Zone by GPS (Default = On)
- DST (Daylight Saving Time) Selection (change DST schedule)
- Time Adjustment (adjust your clock)
- **Reset** button (resets this screen's settings to factory defaults)

Auto Daylight Saving Time

Sets automatic daylight saving time **On** or **Off**. If set to **On**, the clock will automatically “spring ahead” or “fall back” by one hour when a daylight saving time change occurs. If you reside in a state or area where daylight saving time is not used, then you may want to turn this feature off.

NOTE:

*If you set Auto Daylight Saving Time to **On**, the daylight saving time function is activated even in an area that does not use daylight saving time.*

The federal government mandated that starting in 2007, daylight saving time begins in March and ends in November instead of the old schedule from April to October. The schedule is subject to review and possible cancellation in 2010-2011.

The schedules for the time changes are stored in the software and can be selected in the DST schedule selection screen. Therefore, your clock will change based on the daylight saving time schedule.

NOTE:

The automatic clock setting feature relies on a satellite signal. It will not work in Hawaii and Alaska.

System Setup

Auto Time Zone by GPS

Sets automatic time zone selection by GPS to **On** or **Off**. If you are driving across the country and passing through time zones, then this feature will automatically set the time to the time zone you are traveling through. However, if you live and work in two different time zones, you may want to turn this feature off.

NOTE:

When driving near a time zone boundary, the displayed time zone may fluctuate between the two zone times.

Daylight Saving Time (DST) Selection (Change DST Schedule)

This option lets you select the schedule (**April-October** or **March-November**) when daylight saving time will automatically occur in your navigation system. The system default is the **March-November** schedule as mandated by the U.S. government.

During 2010-2011, it is possible that this new change will be canceled by the government and returned back to the previous “April-October” schedule. If so, simply change the schedule in this setting back to the “April-October” schedule.

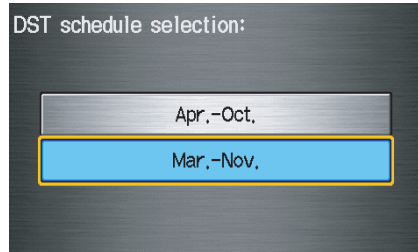

Time Adjustment

Adjusts the current time in hours and minutes. You can reset the adjustment by selecting **Reset**. Selecting **Done** returns you to the previous screen.

NOTE:

*Selecting **Reset** also clears any changes you made to “Auto Daylight Saving Time,” “Auto Time Zone by GPS,” or “DST Selection” settings. Depending on your location, you may need to adjust these settings.*

Clock Type

Allows you to choose the design of the clock screen. For more information, see *Clock Type* on page 77.

Color

From the Setup screen (second), say or select **Color** and the following screen appears:

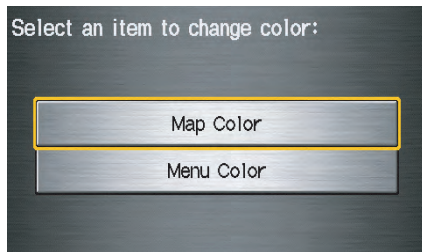

Map Color

Allows you to choose the map color from one of four colors for the **Day** and **Night** modes.

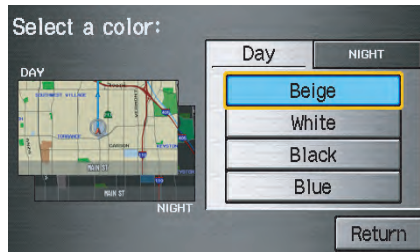

Say or select **Return** to return to the previous screen.

NOTE:

- Choose **White** (factory default is Beige) as the **Day** color to obtain the best daytime display contrast.
- Choose **Black** (factory default) as the **Night** color to obtain the best nighttime display contrast.

Menu Color

Allows you to choose the menu color from one of five colors for the **Base** and **Window**.

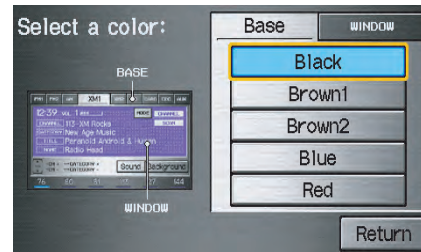

Say or select **Return** to return to the previous screen.

NOTE:

- Choose **Black** (factory default) as the **Base** color to obtain the best display contrast.
- Choose **White** (factory default) as the **Window** color to obtain the best display contrast.

System Initialization

System Initialization

If for any reason you lose power to the navigation system (e.g., the battery was disconnected), the navigation system will require initialization. Once completed, your system will be ready to use.

This initialization requires the following:

- Entry of the 4-digit anti-theft security code.
- GPS initialization (may not be needed depending on the length of time the system was without power).
- Map matching to align the GPS coordinates to a place on the map (displays current street at the bottom of the map).

Entering the Security Code

If the battery goes dead or is disconnected for any reason, you will have to enter a security code for both the audio system and the navigation system before you can use it again.

When you purchased the vehicle, you should have received two cards containing the audio and navigation system's security codes and serial numbers. Keep these cards in a safe place in case you need the codes. If you lose the cards, you must obtain the security codes from your dealer.

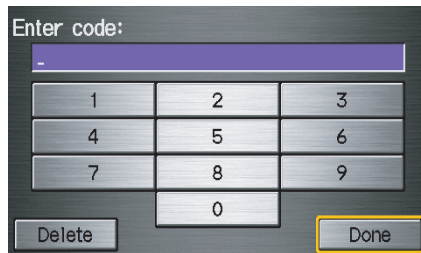

Enter the four-digit security code, then select **Done**. If you make a mistake, the system will display "incorrect PIN." Re-enter your 4-digit security code. If you have entered it correctly, the display changes to the Disclaimer screen. You have 10 chances to enter the correct code. If all 10 are incorrect, turn the ignition to OFF, then back to ON (II) to have 10 more chances to enter the correct code.

NOTE:

The anti-theft security code is unrelated to your optional navigation system PIN (for Personal Address Book or Home Address).

GPS Initialization

Depending on the length of time the battery was disconnected, your system may require GPS initialization. If it does, the following screen appears:

The navigation system lost power and is acquiring its location from the GPS satellites. This usually takes less than 10 minutes.

- * Start the engine.
- * Park the vehicle in an open area away from trees, power lines, and tall buildings.
- * Remove loose articles, cell phones, or electrical accessories located near the GPS antenna.
- * If this screen is displayed repeatedly when starting the vehicle, see your dealer.

If this procedure is not necessary, the system proceeds directly to the Disclaimer screen (see page 16). During initialization, the system searches for all available GPS satellites and obtains their orbital information. During this procedure, the vehicle should be out in the open with a clear view of the sky.

If the navigation system finds the satellites properly, this box clears and the Disclaimer screen is shown. If within 10 minutes the system fails to locate a sufficient number of satellites to locate your position, the following screen appears:

Something is interfering with the system's ability to acquire its location. Check the following:

- * The vehicle must be in an open area with a clear view of the sky.
- * Remove sources of GPS interference like metallic window tint above antenna, or electrical items near antenna (see owner's manual for details).
- * Check GPS antenna cable connection.
- * Restart the engine and repeat the GPS acquire procedure. If the problem persists, see your dealer.

If the system is still unable to acquire a signal, follow the instructions on the screen, or contact your local dealer for assistance.

NOTE:

The average acquiring time is less than 10 minutes, but it can take as long as 45 minutes.

Map Matching

This part of the initialization matches the GPS coordinates found above with a road on the map screen. To perform this part of the procedure, ensure that the navigation system is displaying a map, and drive the vehicle on a mapped road (a road shown on the map screen). Do not enter a destination at this time.

When the name of the current road you are driving on appears at the bottom of the screen, the entire procedure is complete. Your system is now ready to use.

System Limitations

Although your navigation system is one of the most highly sophisticated pieces of equipment you will find in a modern automobile, you may find during its use that it has certain limitations.

The system uses GPS signals to aid in determining its current location. The GPS is operated by the U.S. Department of Defense. For security reasons, there are certain inaccuracies built into the GPS that the navigation system must constantly compensate for. This can cause occasional positioning errors of up to several hundred feet.

For example, in urban areas where streets are close together, this could cause the system to show that you are traveling on a street that parallels the street you are actually on. The system will, under most circumstances, correct itself while you drive.

Depending on your current view of the sky and the position of the satellites, the elevation may be shown incorrectly. You may also notice some delay of the vehicle position icon at intersections; this is normal.

GPS Reception Issues

The signals received from the GPS satellites are extremely weak (less than a millionth of the strength of a local FM station) and require an unobstructed view of the sky. The signal can easily be interrupted or interfered with by the following:

- Aftermarket metallic window tint above or to the sides of the GPS antenna (located under the dashboard)
- Cell phones, PDAs, or other electronic devices docked in a cradle or lying loose on the dashboard
- Radar detectors mounted on the dashboard
- Remote starters, or “hidden” vehicle tracking systems mounted near the navigation unit

- Other aftermarket audio electronic devices mounted near the navigation unit
- Trees, tall buildings, freeway overpasses, tunnels, or overhead electrical power wires

Although the system will direct you to your desired destination, it may not always generate what you consider to be the most direct route. Try changing the method of routing. See *Changing the Routing Method* on page 47. You may also have Unverified Area Routing set to OFF. See *Unverified Area Routing* on page 85.

Additionally, the mapping database contains verified and unverified maps. See *Map Overview* on page 6. A **Disclaimer** screen will warn you if your route includes unverified streets. Unverified streets may be missing from the map, in the wrong location, or have an incorrect name or address range. Exercise additional caution when driving in these unverified areas.

The destination icon shows the approximate location of the destination. This occurs because a city block can have as many as 100 possible addresses (for example, the 1400 block is followed by the 1500 block). Since most cities use only a portion of the 100 possible addresses (for example, in the 1400 block, the addresses may only go up to 1425 before the 1500 block starts), the address 1425 will be shown a quarter of the way down the block by the system instead of at the end of the block where the destination is actually located.

You may find that the system occasionally reboots. This is indicated by the display returning to the globe screen. A reboot can be caused by a number of things, such as extreme temperatures or shock from bumpy roads. It does not necessarily indicate a problem that requires service. If this happens frequently, please see your dealer.

Database Limitations

You will find that some points of interest (POI) may be missing when you search the database. This can be caused if at the time the database was gathered, the name was misspelled, the place was improperly categorized, or the POI change is not yet in the database. This means you may not find places listed that you know exist. This is also true for police agencies and hospitals. In outlying areas, facilities listed may not be the closest. Always check with local information sources if you need law enforcement or hospital services.

Every effort has been made to verify that the system's database was accurate at the time it was created. However, businesses do close or relocate, and new businesses start in the old locations. For this reason, you may occasionally find inaccurate information when you select and drive to a point of interest (for example, a restaurant is now a jewelry store). The number of these inaccuracies increases the longer you go without an update.

The digitized map database reflects conditions as they existed at various points in time before production. Accordingly, your DVD may contain inaccurate or incomplete data or information due to the passage of time, road construction, changing conditions, or other causes.

Due to ongoing software and database improvements, navigation disc versions may change in the middle of a production year. The version shipped with your vehicle was the most recent available at the time of production and is considered standard equipment for that vehicle. There is no free program to retrofit early production vehicles with the latest disc. For DVD ordering information, see page 105.

In addition, this database does not include, analyze, process, consider, or reflect any of the following categories of information:

- Neighborhood quality or safety
- Population density
- Availability or proximity of law enforcement
- Emergency, rescue, medical, or other assistance
- Construction work, zones, or hazards
- Road and lane closures
- Legal restrictions (such as vehicular type, weight, load, height, and speed restrictions)
- Road slope or grade
- Bridge height, width, weight, or other limits
- Road traffic, safety, or conditions
- Weather conditions
- Special events
- Pavement characteristics or conditions

- Traffic congestion
- Travel time

We assume no liability for any incident that may result from an error in the program, or from changed conditions not noted above.

Copyrights

- infoUSA-Data: Certain business data provided by infoUSA, Inc., Omaha, Nebraska, Copyright © 2009, All Rights Reserved.
- EXIT-Data: © ZENRIN CO., LTD. 2009. All Rights Reserved.

Customer Assistance

Reporting Errors

Occasionally, you may encounter database errors.

- If the error pertains to freeways and main “verified” roads shown in black on the map, then report it either online at <http://update.navteq.com/>, or to Honda Customer Service.
- If the error involves a light brown “unverified” road, then do not report it. These areas have not been verified, and are provided for reference only (see *Map Overview* on page 6).
- For errors in points of interest (POI), like a business that has changed its name, do not report them. Keep in mind that depending on when the data was collected and when your DVD was purchased, the database can be out of date. The business may have not reported the change(s), or not be in the database at all. Update Navigation DVDs are available for purchase, usually in the fall of each year.

- If the error does not involve the database, such as vehicle position icon errors, screen error messages, or other GPS-related errors, see *Frequently Asked Questions* on page 125, *System Limitations* on page 100, or *Troubleshooting* on page 135.

Honda Automobile Customer Service

Telephone: (800) 999-1009
Fax: (310) 783-3273

Mail:

Honda Navi

America Honda Motor Co., Inc.
Honda Customer Service
MS 500-2N-7A
1919 Torrance Blvd.
Torrance, CA 90501-2746

Visiting Your Dealer

We strive to make this manual as complete as possible and to answer all questions regarding operation of the system. Occasionally, you may run into a specific issue that you cannot find in the book. You may save yourself a trip to the dealer by first consulting the following resources:

- The Troubleshooting section (see page 135).
- The Frequently Asked Questions (FAQs) section (see page 125).
- The FAQs found on the online DVD order site (see “Obtaining a DVD”).
- For detailed questions regarding audio or other systems that interact with the navigation system, see your Owner’s Manual or the Technology Reference Guide.

- Call Honda Customer Relations (see “Honda Automobile Customer Service” on page 104).
- For database or POI issues, follow the guidelines in the “Reporting Errors” section (see page 104).

If your question is still unanswered and you wish to visit the dealer, please be prepared to demonstrate the issue to the service advisor. This way, the service advisor can document the issue for the factory to allow more efficient troubleshooting.

Some issues may at first seem random, but you may notice a pattern. For example, they only occur when you enter a specific address, or when driving on a certain road, or just when it is cold. This information is very useful to the service advisor. Be patient, the service advisor may be unfamiliar with your specific issue.

Obtaining a Navigation Update DVD

Honda is continually expanding the scope of the navigation system. Upgraded software may be made available to navigation system owners periodically, usually in the fall of each year.

To purchase an updated DVD or a replacement DVD, call the Honda Navigation Disc Fulfillment Center at (888) 291-4675. You can also order online by going to www.hondanavi.com.

NOTE:

- *DVDs are not available at your dealer. However, the dealer may order a DVD for you as a courtesy. There is no program for free DVD updates.*
- *The DVD order line staff cannot answer technical questions regarding navigation operation, coverage, or POIs.*
- *Purchasing used discs from alternate sources or online auctions may cause operational problems since they are likely to be incompatible with your current software.*

Changing the DVD

NOTE:

The system's database is stored on a removable DVD. The system will not work without the DVD. Ensure the door remains closed at all times.

1. Remove the DVD while the ignition switch is in the ACCESSORY (I) position or in the ON (II) position.
2. Push the **OPEN** button to tilt the screen down.

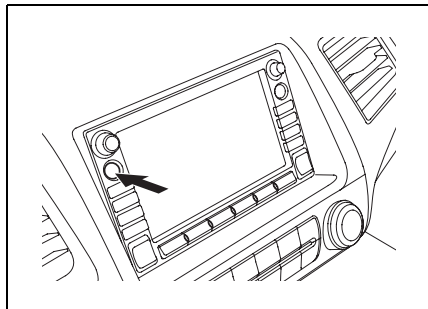

3. Press down on the DVD cover release tab ①, then lower the cover ②.

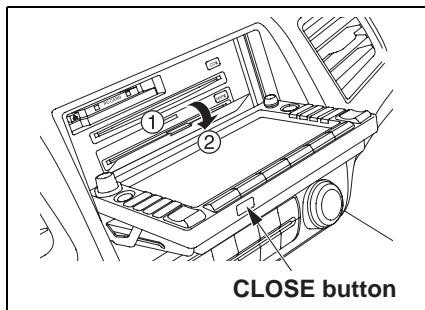

NOTE:

Be sure to close the DVD cover completely before closing the screen. The DVD cover may be damaged.

4. Press the MAP ▲ (Eject) button. The DVD will automatically come out and an error message will be displayed on the screen. This is normal.
5. Pull the DVD straight out. Hold the DVD by the edges. Fingerprints, scratches, or other contamination on the playing surface can make the DVD unreadable.

To install the DVD, make sure the turquoise (blue/green) label is facing up. Slide the DVD into the DVD slot. The DVD is automatically pulled into the navigation system. Make sure you close the navigation DVD cover, then close the screen using the **CLOSE** button on the bottom of the screen.

NOTE:

Do not attempt to play any other DVD (or CD) in the navigation system DVD player.

PC Card Operation

A PC card with WMA or MP3 audio files can be played through the audio system and controlled using the navigation voice control system. PC card (PCMCIA) adaptors and various media chips can be purchased at any computer store. Tested media chips include Compact Flash and SD media, up to 2GB. Other media types and storage capacities may work, but have not been tested. Hard disc drive type media are not recommended because they can fail in a hot vehicle. See the FAQs section for additional information.

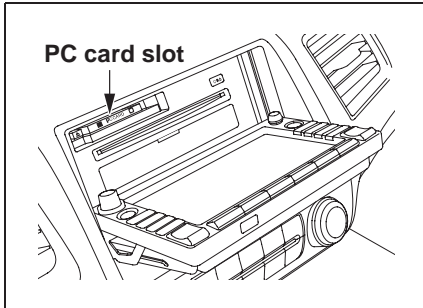

Inserting the PC Card

Ensure that the PCMCIA PC card adaptor contains the media chip, and that the card adaptor is fully inserted in the slot, otherwise the display door will not close. Once the card is inserted and the door closed, there is a delay while the system reads the tag information (the folders, song titles, etc.). Once the tag information is read, the "CARD" or "TRACK LIST" buttons will function. For more information on the search feature, see the audio section of your Owner's Manual.

Voice Control of PC Card Functions

The navigation voice control system can be used to select the first 30 tracks directly by using the command, "Card play track X" (X=1-30). Additional voice commands allow the card tracks, artists, and albums to be played in a random, repeat, or scan mode. See the complete list of "Card" voice commands starting on page 145.

CD/CD-R Operation

A CD or a burned CD-R with MP3 or WMA media files can be played by the audio system and controlled using navigation voice commands. The display door will not close with a partially inserted CD in the slot. Once the display closes, there may be a slight delay before the "CD" or "TRACK LIST" buttons function. This is because the system has to read the tag information (artist, album, and track names) to allow searches to function. For more information on the search feature, see the audio section of your Owner's Manual.

NOTE:

Ensure that burned CD-R discs do not have "stick-on" paper labels. The label adhesive can melt in a hot vehicle, and allow the label to curl up and jam the CD mechanism. Use a felt-tipped marker to label your CD-R discs.

Voice Control of CD Functions

The navigation voice control system can be used to select the first 30 tracks directly by using the command, “CD play track X” (X=1-30). Additional voice commands allow CD tracks, and folders be played in a random, repeat, or scan mode. See the complete list of “CD” voice commands starting on page 145.

Map Coverage

The system provides map coverage for the lower 48 U.S. states, Hawaii, and southern Canada. The U.S. map coverage consists of accurately mapped (verified) metropolitan areas (in the following list) and a less accurate (unverified) rural database. Canada coverage consists of major metropolitan areas and major roads connecting the metropolitan areas within about 100 miles north of the U.S. border. If you need additional northern Canada coverage, you may purchase the Canadian DVD (see *Obtaining a Navigation Update DVD* on page 105). See *Map Overview* on page 6 for a discussion of map coverage.

The cities and metropolitan areas in the following list are fully mapped. Only major streets, roads, and freeways have been verified outside these areas. If your route passes through these areas, routing may be limited, depending on your routing choices. See *Unverified Area Routing* on page 85.

If you desire additional map coverage information, contact Honda Customer Services or go to www.hondanavi.com.

U.S. Detailed Coverage Areas

Alabama

Auburn-Opelika
Birmingham/Tuscaloosa
Huntsville
Mobile
Montgomery

Arizona

Phoenix Metro
Prescott
Sedona
Tucson
Yuma

Arkansas

Fayetteville
Fort Smith
Hot Springs
Little Rock
Pine Bluff

California

Central Valley - including Fresno,
Merced, Modesto, and Stockton
Humboldt
Los Angeles/San Diego Metro

Mammoth Lakes
Sacramento Metro
San Francisco Bay (*approximately Monterey to Sonoma*) – including Monterey County and Hollister
Southern California Area - including Bakersfield and San Luis Obispo
Yuba

Colorado

Denver/Boulder/Colorado Springs/
Ski Resorts Metro area – including Ft. Collins
Grand Junction

Connecticut

Bridgeport
Danbury
Hartford Metro
New Haven Metro
Norwalk
Stamford

Delaware

Entire state – including Dover,
Wilmington Metro area, New Castle County

Coverage Areas

Florida

Cape Canaveral/Cocoa Beach/
Titusville
Dixie County
Florida Keys
Fort Myers Metro area – *including
Naples*
Fort Pierce
Gainesville
Jacksonville Metro – *including St.
Johns County*
Miami/Fort Lauderdale/West Palm
Beach Metro
Orlando/Daytona Beach/Melbourne
area – *including Osceola County*
Panama City
Pensacola
Tallahassee
Tampa Bay/St. Petersburg Metro –
*including Pasco and Manatee
Counties*
Vero Beach

Georgia

Athens
Atlanta Metro
Augusta/Aiken Metro
Columbus
Macon
Rome
Valdosta
Warner Robbins

Hawaii (all cities for the following islands)

Hawaii
Kauai
Lanai
Maui
Molokai
Oahu

Idaho

Boise
Idaho Falls
Pocatello
Sun Valley Ski Resorts

Illinois

Bloomington-Normal
Carbondale
Champaign
Charleston
Chicago Metro (to Wisconsin border)
– *including Lake County, IN, and
DeKalb County, IL*
East St. Louis Metro
Galesburg
Moline
Peoria
Quincy
Rock Island
Rockford
Springfield
Urbana-Danville

Indiana

Bloomington
Evansville
Fort Wayne
Gary/Hammond Metro
Indianapolis Metro
Kokomo Metro
Lafayette
Muncie
Northwest Indiana
South Bend/Elkhart/Goshen
Terre Haute

Iowa

Ames
Cedar Rapids
Davenport
Des Moines
Iowa City
Waterloo-Cedar Falls

Kansas

Kansas City/Leavenworth Metro
Topeka
Wichita

Kentucky

Lexington
Louisville

Louisiana

Baton Rouge
Lafayette
New Orleans Metro
Shreveport

Maine

Bangor
Bar Harbor/Acadia National Park
Portland/Lewiston/Auburn

Maryland

State of (partial) - Baltimore/
Washington D.C. Metro – including
Charles and Carroll Counties
Cumberland
Ocean City

Massachusetts

Boston/Cape Cod Metro
Cape Cod
Springfield Metro area
*Complete coverage of all cities in
Barnstable, Berkshire, Bristol,
Essex, Hampshire, Hampden,
Middlesex, Norfolk, Plymouth,
Suffolk, and Worcester Counties*

Michigan

Detroit Metro area – including *Ann
Arbor, Pontiac, Flint, Clinton,
Eaton, and Monroe Counties*
Kalamazoo
Northern Michigan Resort Area –
including *Traverse City, Elk
Rapids, Petoskey, Charlevoix,
Boyne City, and Harbor Springs*
Saginaw-Midland
Southeast Michigan – including
Detroit - Grand Rapids - Lansing
Southern Michigan

Minnesota

Duluth
Minneapolis/St. Paul Metro –
including *cities in Anoka Scott and
Carver Counties*
Moorhead
Rochester

Mississippi

Biloxi/Gulfport
Jackson
Memphis
Tupelo

Missouri

Branson
Columbia
Jefferson City
Joplin
Kansas City (KS-MO) Metro –
including *Platte County*
Lake of the Ozarks
Springfield
St. Louis Metro (IL-MO) – including
*additional cities in Jefferson
County*

Montana

Billings
Helena
Missoula

Nebraska

Lincoln (Lancaster County)
Omaha

Nevada

Las Vegas Metro
Reno/Lake Tahoe

New Hampshire

Lebanon
Manchester
Nashua

Coverage Areas

New Jersey

Camden Metro
Newark Metro
Southern New Jersey – *including Atlantic City/Cape May/Cumberland Metro*
Trenton Metro – *including Ocean and Hunterdon Counties*

New Mexico

Albuquerque
Las Cruces
Santa Fe
Taos Ski Resorts

New York

Binghamton
Buffalo – *including Erie and Niagara Counties*
Eastern New York – *including the Adirondack, Oneonta - Cooperstown, New York City Metro, Albany, Glen Falls, Schenectady, Troy*
Elmira
Ithaca
Lake Placid
Rochester – *including cities in Monroe County*
Syracuse
Utica
Watertown

North Carolina

Asheville
Charlotte Metro
Fayetteville
Hickory
Jacksonville
Morgantown
Outer Banks
Raleigh-Durham Metro
Wilmington
Winston-Salem/Greensboro Metro

North Dakota

Fargo Metro
Grand Forks

Ohio

Akron
Columbus/Marysville Metro
Cincinnati Metro – *including Butler County*
Cleveland Metro – *including Geauga County*
Dayton
Lima
Mansfield
Springfield
Toledo (*Lucas County*)
Youngstown

Oklahoma

Oklahoma City
Tulsa

Oregon

Bend
Corvallis
Eugene
Medford
Portland/Salem Metro
Seaside/Astoria/Cannon Beach

Pennsylvania

Allentown
Erie
Gettysburg
Harrisburg
Lancaster
Philadelphia Metro
Reading
Southeastern Pennsylvania
Southwest Pennsylvania - *including Pittsburgh and Washington County*
State College/University Park
Wilkes-Barre/Scranton
Williamsport
York

Rhode Island

Newport
Providence Metro

South Carolina

Beaufort
Charleston
Columbia
Greenville/Spartanburg – *including additional cities in Greenville and Spartanburg Counties*
Myrtle Beach Metro
Rock Hill Metro
Sumter/Florence

South Dakota

Rapid City
Sioux Falls

Tennessee

Chattanooga
Chester County
Franklin County
Johnson City/Kingsport/Bristol
Knoxville/Farragut Metro
Memphis Metro – *including Desoto and Tunica Counties*
Nashville

Texas

Abilene
Amarillo
Austin Metro
Beaumont
Big Bend
Brownsville

Bryan/College Station
Corpus Christi
Dallas/Fort Worth Metro – *including additional cities in Grayson County*
El Paso
Houston Metro – *including additional cities in Galveston County*
Laredo
Longview
Lubbock
McAllen
Midland/Odessa Metro
Nacogdoches-Lufkin
San Antonio Metro
South Padre Island
Texarkana
Wichita Falls

Utah

Moab
Ogden
Park City
Salt Lake City Metro
St. George

Vermont

Rutland
State of (partial) - *including Burlington, Montpelier*

Virginia

Washington D.C. detailed area – *including Alexandria, Arlington, Fairfax, Falls Church, Fauquier County, Fredericksburg City, Manassas, and additional cities in Loudon and Prince William Counties*
Bristol
Charlottesville
Danville
Emporia
Lynchburg
Richmond Metro
Roanoke
Shenandoah National Park
Staunton-Waynesboro-Harrisonburg
Williamsburg/Norfolk/Virginia Beach Metro – *including Charles City, Hopewell, Kent, and Prince George Counties*
Winchester

Washington

Bellingham
Seattle/Tacoma/Olympia Metro – *including Island County*
Spokane
Tri-Cities
Whatcom
Point Roberts (community)
Yakima

Coverage Areas

West Virginia

Charleston
Harper's Ferry Metro
Huntington
Morgantown
Parkersburg

Wisconsin

Appleton
Beloit
Eau Claire
Green Bay
Janesville
Kenosha County
La Crosse
Madison
Lake Geneva
Milwaukee Metro – *including
Milwaukee, Ozaukee, Washington,
and Waukesha Counties*
Neenah
Oshkosh
Racine
Sheboygan
Wausau

Wyoming

Cheyenne
Jackson Ski Resorts

Canada Detailed Coverage Areas

NOTE:

The blue city names are not included in the USA South DVD. To obtain coverage for cities listed in blue, you may purchase the Canada DVD (see page 105, Obtaining a Navigation DVD). DVDs are not available at your dealer.

ALBERTA

Airdrie
Banff
Beaumont
Calgary
Calmar
Canmore
Chestermere
Cochrane
Crossfield
Devon
Edmonton
Fort Saskatchewan
Leduc
Lethbridge
Medicine Hat
Spruce Grove
St. Albert
Stony Plain
Strathcona County

BRITISH COLUMBIA

Greater Vancouver

Anmore
Belcarra
Bowen Island
Burnaby
Coquitlam
Delta
Langley
Langley Twp
Lions Bay
Maple Ridge
New Westminster
North Vancouver
North Vancouver District
Pitt Meadows
Port Coquitlam
Port Moody
Richmond
Surrey
Squamish
Vancouver
West Vancouver
White Rock

Whatcom, WA

Point Roberts (Community) *also listed in USA Washington St Cities*

Fraser Valley

Abbotsford
Chilliwack
Mission

Squamish-Lillooet

Lillooet
Pemberton
Squamish
Whistler

Thompson-Nicola

[Kamloops](#)

Central Okanagan

[Kelowna](#)
[Peachland](#)

Okanagan-Similkamen

[Penticton](#)
[Summerland](#)

Victoria

Capital

Central Saanich
Colwood
Esquimalt
Highlands
Langford
Metchosin
North Saanich
Oak Bay

Saanich
Sidney
Sooke
Victoria
View Royal

MANITOBA

East St Paul
Headingley
West St Paul
Winnipeg

NOVA SCOTIA

Halifax (*partial*)

ONTARIO

Brant

Brant
Brantford

Chatham-Kent

Chatham-Kent

Dufferin

Amaranth
East Garafraxa
East Luther Grand Valley
Melancthon
Mono
Mulmur
Orangeville
Shelburne

Durham

Ajax
Brock
Clarington
Oshawa
Pickering
Scugog
Uxbridge
Whitby

Elgin

Aylmer
Bayham
Central Elgin
Dutton/Dunwich
Malahide
Southwold
St. Thomas
West Elgin

Frontenac

Central Frontenac
Frontenac Islands
Kingston
North Frontenac
South Frontenac

Gatineau

Gatineau

Coverage Areas

Grey

Blue Mountains
Chatsworth
Georgian Bluffs
Meaford
Grey Highlands
Hanover
Owen Sound
Southgate
West Grey

Haldimand

Haldimand

Halton

Burlington
Halton Mills
Milton
Oakville

Hamilton

Hamilton

Kawartha Lakes

Kawartha Lakes

Lambton

Brooke-Alvinston
Dawn-Euphemia
Enniskillen
Lambton Shores
Oil Springs

Petrolia
Plympton-Wyoming
Point Edward
Sarnia
St Clair
Warwick

Lanark

Beckwith
Carleton Place
Drummond/North Elmsley
Lanark Highlands
Mississippi Mills
Montague
Perth
Smiths Falls
[Tay Valley](#)

Leeds and Grenville

Athens
Augusta
Brockville
Edwardsburgh/Cardinal
Elizabethtown-Kitley
Front of Yonge
Gananoque
Leeds and the Thousand Islands
Merrickville-Wolford
North Grenville
Prescott
Rideau Lakes
Westport

Muskoka

Bracebridge
Georgian Bay
Gravenhurst
Huntsville
Lake of Bays
Muskoka Lakes

Middlesex

Adelaide Metcalfe
London
Lucan Biddulph
Middlesex Centre
Newbury
North Middlesex
Southwest Middlesex
Strathroy-Caradoc
Thames Centre

Niagara

Fort Erie
Grimsby
Lincoln
Niagara-on-the-Lake
Niagara Falls
Pelham
Port Colborne
St Catharines
Thorold
Wainfleet
Welland
West Lincoln

Norfolk

Norfolk

Northumberland

Alnwick/Haldimand
Brighton
Cobourg
Cramahe
Hamilton Twp
Port Hope
Trent Hills

Ottawa

Ottawa

Oxford

Blandford-Blenheim
East Zorra-Tavistock
Ingersoll
Norwich
South-West Oxford
Tillsonburg
Woodstock
Zorra

Peel

Brampton
Caledon
Mississauga

Perth

North Perth
Perth East
Perth South
St. Mary's
Stratford
West Perth

Prescott and Russell

Alfred and Plantagenet
Casselman
Champlain
Clarence-Rockland
East Hawkesbury
Hawkesbury
Russell
The Nation

Simcoe

Adjala-Tosorontio
Barrie
Bradford West Gwillimbury
Clearview
Collingwood
Essa
Innisfil
Midland
New Tecumseth
Orillia
Oro-Medonte
Penetanguishene

Ramara
Severn
Springwater
Tay
Tiny
Wasaga Beach

Stormont, Dundas, and Glengarry

Cornwall
North Dundas
North Glengarry
North Stormont
South Dundas
South Glengarry
South Stormont

Toronto

Toronto

Waterloo

Cambridge
Kitchener
North Dumfries
Waterloo
Wellesley
Wilmot
Woolwich

Coverage Areas

Wellington

Centre Wellington
Erin
Guelph
Guelph/Eramosa
Mapleton
Minto
Puslinch
Wellington North

York

Aurora
East Gwillimbury
Georgina
King
Markham
Newmarket
Richmond Hill
Vaughan
Whitchurch-Stouffville

Windsor

Essex

Amherstburg
Essex
Kingsville
Lakeshore
Lasalle
Leamington
Pelee
Tecumseh
Windsor

Inter-Town (partial) Coverage

Counties/Districts/Regional

Municipalities

Brant
Bruce
Chatham-Kent
Dufferin
Elgin
Essex
Frontenac
Gray
Haldimand-Norfolk
Haliburton
Hastings
Huron
Kawartha Lakes
Lambton
Lanark

Leeds and Granville
Lennox and Addington

Middlesex

Muskoka

Northumberland

Oxford

Perth

Peterborough

Prescott and Russell

Prince Edward

Simcoe

Stormont, Dundas, and Glengarry

Waterloo

Wellington

QUÉBEC

Montreal-Laurentians

Beauharnois-Salaberry

Beauharnois
 Salaberry-de-Valleyfield
 Ste-Martine
 St-Étienne-de-Beauharnois
 St-Louis-de-Gonzague
 St-Stanislas-de-Kostka
 St-Urbain-Premier

Deux-Montagnes

Deux-Montagnes
 Oka
 Pointe-Calumet
 St-Eustache
 St-Joseph-du-Lac
 Ste-Marthe-sur-le-Lac
 St-Placide

L'Assomption

Charlemagne
 L'Assomption
 L'Épiphanie
 L'Épiphanie Paroisse
 Repentigny
 St-Sulpice

La Rivière-du-Nord

Prévost
 St-Colomban
 St-Hippolyte
 St-Jérôme
 Ste-Sophie

La Vallée-du-Richelieu

Beloeil
 Caringnan
 Chambly
 McMasterville
 Mont-St-Hilaire
 Otterburn Park
 St-Antoine-sur-Richelieu
 St-Basile-le-Grand
 St-Charles-sur-Richelieu
 St-Denis-sur-Richelieu
 St-Jean-Baptiste
 St-Marc-sur-Richelieu
 St-Mathieu-de-Beloeil

LaJemmerais

Calixa-Lavallée
 Contrecoeur
 St-Amable
 Ste-Julie
 Varennes
 Verchères

Laval

Laval

Le-Haut-Richelieu

Henryville
 Lacolle
 Mont-St-Grégoire
 Noyan
 St-Alexandre
 St-Blaise-sur-Richelieu
 St-Georges-de-Clarenceville
 St-Jean-sur-Richelieu
 St-Paul-de-L'Île-aux-Noix
 St-Sébastien
 St-Valentin
 Ste-Anne-de-Sabrevois
 Ste-Brigide-D'Iberville
 Venise-en-Québec

Le Haut-St-Laurent

Dundee
 Elgin
 Franklin
 Godmanchester
 Havelock
 Hinchinbrooke
 Howick
 Huntingdon
 Ormstown
 St-Anicet
 St-Chrysostome
 Ste-Barbe
 Très-St-Sacrement

Coverage Areas

Les-Jardins-De-Napierville

Hemmingford
Hemmingford Village
Napierville
St-Bernard-de-Lacolle
St-Cyprien-de-Châteauguay
St-Édouard
St-Jacques-le-Mineur
St-Michel
St-Patrice-de-Sherrington
St-Rémi

Les Laurentides

Amherst
Arundel
Barkmere
Brèbeuf
Huberdeau
La Conception
La Minerve
Labelle
Lac-Supérieur
Lantier
Mont-Tremblant
Montcalm
St-Faustin-Lac-Carrè
Ste-Agathe-des-Monts
Ste-Lucie-des-Laurentides
Val-David
Val-des-Lacs
Val-Morin

Les Moulins

Mascouche
Terrebonne

Les Pays-D'en-Haut

Lac-des-Seize-Îles
Morin-Heights
Piedmont
Ste-Adolphe-d'Howard
St-Sauveur
Ste-Adèle
Ste-Anne-des-Lacs
Ste-Marguerite-Estèrel
Wentworth-Nord

Longueuil

Boucherville
Brossard
Longueuil
St-Bruno-de-Montarville
St-Lambert

Mirabel

Mirabel

Montcalm

St-Alexis
St-Alexis Paroisse
St-Calixte
Ste-Julienne
Ste-Marie-Salomé
St-Esprit

St-Jacques
St-Liguori
St-Lin -- Laurentides
St-Roch-de-l'Achigan
St-Roch-Ouest

Montreal

Baie-D'Urfé
Beaconsfield
Côte-St-Luc
Dollard-des-Ormeaux
Dorval
Hampstead
Kirkland
L'Île -Dorval
Montréal
Montréal-Est
Montréal-Ouest
Mont-Royal
Pointe-Claire
Senneville
Ste-Anne-de-Bellevue
Westmount

Roussillon

Candiac
Châteauguay
Delson
La Prairie
Lery
Mercier

Ste-Catherine
St-Constant
St-Isidore
St-Mathieu
St-Philippe

Sherbrooke

Sherbrooke

Therese-de-Blainville

Blainville
Boisbriand
Bois-des-Filion
Lorraine
Rosemere
Ste-Therese

Vaudreuil-Soulanges

Coteau-du-Lac
Hudson
Les Cèdres
Les Coteaux
L'Île-Cadieux
L'Île-Perrot
Notre-Dame-de-l'Île-Perrot
Pincourt
Pointe-des-Cascades
Pointe-Fortune
Rigaud
Riviere-Beaudette
St-Clet
Ste-Justine-de-Newton

St-Lazare
Ste-Marthe
St-Polycarpe
St-Telesphore
St-Zotique
Terrasse-Vaudreuil
Tres-St-Redempteur
Vaudreuil-Dorion
Vaudreuil-sur-le-Lac

Quebec

La Cote-de-Beaupré

Beaupré
Boischatel
Château-Richer
L'Ange-Gardien
St-Ferréol-les-Neiges
St-Joachim
St-Louis-de-Gonzague-du-Cap-
Tourmente
Ste-Anne-de-Beaupré

La Jacques-Cartier

Fossambault-sur-le-Lac
Lac-Beauport
Lac-Delage
Lac-St-Joseph
Ste-Brigitte-de-Laval
Ste-Catherine-de-la-Jacques-Cartier
Shannon

L'Île-d'Orléans

St-François- L'Île-d'Orléans
St-Jean
St-Laurent-de- L'Île-d'Orléans
St-Pierre-de- L'Île-d'Orléans
Ste-Famille
Ste-Pétronille

Lévis

Lévis

Québec

L' Ancienne-Lorette
Notre-Dame-des-Anges
Québec
St-Augustin-de-Desmaures

Coverage Areas

CANADA CONNECTOR ROADS

The Cross-Canada Connector Road allows for travel between the provinces of British Columbia and Quebec in DCA 11. Major metropolitan city POIs are also included.

Road Inclusion

Roads in the province of British Columbia

- Hwy-1/Trans Canada Hwy from Alberta/BC boundary to Vancouver detailed city
- Hwy-3/Crowsnest Hwy from Hwy-1/Trans Canada Hwy (Hope) to Hwy-5/Coquihalla Hwy (Hope)
- Hwy-5/Coquihalla Hwy (in Hope) to Hwy-1/Trans Canada Hwy (in Kamloops)
- Hwy-99 between Vancouver and Whistler

Roads in the province of Alberta

- Hwy-1/Trans Canada Hwy across whole province
- Hwy-1A from Cochrane to Canmore
- Hwy-1X from Hwy-1A to Hwy-1/Trans Canada Hwy
- Morley Road from Hwy-1/Trans Canada Hwy
- Hwy-3/Crowsnest Hwy (at Medicine Hat) to Lethbridge
- Hwy-4 (at Lethbridge) to 1-15 (U.S. border)
- Hwy-36 between Hwy-3 (in Taber) and Hwy-4 (in Warner)
- Hwy-3/Crowsnest Hwy (in Lethbridge) to Hwy-2 (in Fort Macleod)
- Hwy-2 (in Fort Macleod) to Hwy-1/Trans Canada Hwy (in Calgary)

Roads in the province of Saskatchewan

- Hwy-1/Trans Canada Hwy across whole province

Roads in the province of Manitoba

- Hwy-1/Trans Canada Hwy across whole province
- Hwy-100/Trans Canada Hwy in Winnipeg (partial beltway)
- Hwy-75 from Hwy-100/Trans Canada Hwy (Winnipeg) south to link with 1-29 (U.S. border)

Roads in the province of Ontario

- Hwy-69/Trans Canada Hwy from Muskoka district to Sudbury
- Hwy-17/Trans Canada Hwy from Ottawa Detailed Area Coverage to Manitoba border
- Hwy-17B at Sault Ste Marie to link with 1-75 (U.S. border)
- Hwy-61 from Hwy-17 at Thunder Bay to link with US-61 (U.S. border)
- Hwy-11 from Muskoka district to North Bay
- Hwy-60 and Hwy-127 in Nipissing County

Operation in Alaska and Hawaii

Certain functions that rely on a satellite signal will not work in Alaska and Hawaii. These functions include but are not limited to XM radio, automatic clock updates, and time zone adjustments.

Alaska

If the vehicle was purchased in the lower 48 states and driven to Alaska, the system cannot display maps. The message “Vehicle is out of the database...” will be displayed.

Hawaii

This section describes the differences in navigation system operation for vehicles delivered in Hawaii.

XM Radio

Navigation-equipped vehicles delivered to Hawaii are equipped with XM hardware, but XM broadcasting is not available; therefore sections of the manual that mention XM audio do not apply. Vehicles originally delivered to the U.S. mainland and shipped to Hawaii also have XM, but will not function because the XM satellites (aimed toward the U.S. mainland) are too far away to obtain reception.

Map Coverage

All roads displayed on the Hawaii map screens are detailed coverage roads. Text related to “unverified” roads or areas are not applicable. The following topics do not apply in Hawaii:

- Unverified road descriptions (see page 6 and 85).
- Cautions and pop-up windows related to unverified roads (see page 63).

- Setup entries that relate to turning on or off unverified routing (see page 86).
- When zooming in and out, there is no 350-mile scale for Hawaii.

Other Map Issues

- See the coverage section for a list of islands with coverage (see page 109).
- Freeway Exit information does not exist in Hawaii, so the “Freeway Exit Info” icon is not shown on the icon bar.

Coverage Areas

Address and POI Entry Screens

When in Hawaii, the following differences occur for map, address, and POI selection:

- It is not possible to enter U.S. mainland addresses or scroll the map east to the U.S. mainland.
- Selection of the “State” is confined to the state of Hawaii only.
- Entry of a destination address or POI on an island other than your current island may result in a screen caution message. This is normal because there are no “ferry” routes between islands available in the database.
- If the “Guidance Prompts” setting on the Setup screen is set to normal or maximum, street names will not be spoken in voice guidance commands.

Setup Screen Differences

The Setup screen differences are minor and are listed below. See the Setup section (page 75) for additional information.

Routing and Guidance (Unverified Area Routing On/Off)

This feature is unavailable. All roads displayed on the map are verified.

Clock Adjust Screen

There is no daylight saving time for Hawaii. **Auto Daylight Saving Time, Auto Time Zone by GPS, and DST Selection** will not be shown on the Clock adjustment screen. To test your adjustment, use the voice control system, and say “What time is it?” (see page 95).

Bluetooth® HandsFreeLink® Operation

When pairing a cell phone to use the Bluetooth® HandsFreeLink® feature, you may see a “Phone-Data Connection” screen. If so, do not complete this portion of the process.

Shipping a Vehicle To or From Hawaii

Although the DVD in the vehicle contains maps for both U.S. mainland and Hawaii, the dealer must perform the selection of “U.S. mainland” or “Hawaii” for you. When the dealer makes the switch from U.S. mainland to Hawaii or vice versa, the system clears all user data. Make sure to record any personal information that you do not want to lose.

NOTE:

Shipping a vehicle from Hawaii to the U.S. mainland

- *If you wish to receive XM audio, you must call XM and set up an account at (800) 852-9696.*

Shipping a vehicle from the U.S. mainland to Hawaii

- *If a U.S. mainland-delivered vehicle is shipped to Hawaii, there is no XM reception. See your Hawaii dealer to allow viewing of local Hawaii maps.*
- *The issues under “Operation in Hawaii” above apply.*

Map and Features, Voice Operation, Entering Addresses

Problem	Solution
Why does the Disclaimer screen need to be displayed every time I start the car? I am the only driver.	The Disclaimer screen reminds you and your guest drivers to always operate the navigation system in a safe manner.
The Setup or Information screen has “grayed out” items that I cannot select. Why?	You need to select OK on the Disclaimer screen to view these items. See <i>System Function Diagram</i> on page 21.
I tried entering an address, but the city or street could not be found. Is there any other way to route to the location?	Some cities are lumped in with a major metro area. Try entering the street first. In rural “unverified” areas or new subdivisions, streets may be missing or only partially numbered. Try selecting the destination directly from the map. See <i>By Map Input</i> on page 37.
When I enter an address, some letters become grayed out. Is this normal?	Yes. As you enter each letter in an address or a point of interest (POI), the system looks in the database to see what letters are possible and “grays out” letters that do not apply.
How do I delete Personal Addresses, Previous Destinations, or the Home Address?	This is done in the Setup screen (second) under “Personal Information.” See page 78.
I cannot hear the navigation system voice.	1) Ensure that Volume in the Setup screen (first) is not Off . See page 75. 2) Go to “Basic Settings” in the Setup screen (second), and set Voice Recognition Feedback to On . See page 94.
The voice control system is having difficulty recognizing my voice commands.	Ensure that the vents are not blowing on the microphone on the ceiling, the vehicle is as quiet as possible, and you are using the correct command when speaking (see <i>Improving Voice Recognition</i> on page 13). Say “Help” at any screen to see a list of the applicable voice commands. If the system cannot recognize your command because of background noise, speak louder.
When the system pronounces the street name in the guidance command or reads the destination address, it sounds strange. What causes this?	The basic guidance phrase uses a studio-recorded voice, but the street name is pronounced by the system using a machine-generated voice. Consequently, the name may be mispronounced or sound strange at times.

Frequently Asked Questions

Problem	Solution
When I drive at night, the screen is bright and will not switch to the night display mode. Why?	The system thinks it is in Day display mode. Verify the following: The display mode in Setup is set to Auto , the dash brightness is not set to maximum (must adjust with headlights on), and Map Color in Setup is set to Black for Night. See <i>Display</i> on page 76.
The daytime map screen is dark like the night display mode, and it is hard to see. Why?	Verify the following: The display mode in Setup is set to Auto , and Map Color in Setup is set to White for Day. See <i>Display</i> on page 76.
During the day, I turned on the lights because it started to rain, but the screen went dark. How can I make it still display day mode?	Adjust the dash brightness (+) button (with headlights on) to full brightness. Remember to set it back to a medium setting, or at night, the screen will be bright. See <i>Display</i> on page 76.
How can I input my destination using map coordinates?	The navigation system was not designed for this. However, you can view the coordinates of an address by touching the vehicle position icon on the map. See <i>Map Screen Legend</i> on page 51.
How do I change or remove my PIN?	Go to “Personal Information” in the Setup screen (second), and select PIN Number . Select User 1 or User 2 and enter your existing PIN, and then you have the choice to change or remove the PIN. See page 82.
I forgot the PIN for Home, or the PIN for personal addresses (User 1 or User 2). How do I reset it?	PINs are optional. See information regarding PINs on page 82. Your dealer can reset the PIN for you.

Guidance, Routing

Problem	Solution
The navigation does not route me the same way I would go, or the way some other mapping program displays. Why is this?	The navigation system attempts to generate the optimum route. See <i>Changing the Routing Method</i> on page 47.
Why is the street I'm on not shown on the map? It has been here for more than a year.	The mapping database is constantly undergoing revision. See page 105 for ways to obtain the latest detailed coverage information.
The vehicle position icon is not following the road, and the "GPS icon" text in the upper left hand corner of the screen is white or missing.	<ul style="list-style-type: none"> • The GPS antenna (located under the center of the dashboard) may be blocked by personal items. For best reception, remove items from the dashboard, such as radar detectors, cell phones, or loose articles. • Metallic tinting or other aftermarket devices can interfere with the GPS reception. Please see your dealer. Also see <i>System Limitations</i> on page 100.
I entered a destination, but the blue highlighted route and voice guidance stopped, or turned into a blue/pink dashed line before I got to my destination. Why is this?	Your route has entered an unverified area. See <i>Unverified Area Routing</i> on page 85.
The map rotates while I make turns. How can I stop this?	Select the North-up map orientation by voice, or by touching the map orientation icon on the map screen. See <i>Map Orientation</i> on page 56.
Sometimes, I cannot select between the North-up and Heading-up map orientations. Why is this?	The Heading-up map orientation can only be shown in the lower scales (1/20 - 1 mile scales). See <i>Map Scale</i> on page 55.
While driving to my destination, the "time to go" display sometimes increases, even though I am getting closer.	The "Time to go" is based on actual road speeds. However if your speed slows down when you encounter slower traffic, the system updates the "Time to go" based on your actual speed to give you a better estimate of arrival time.
The vehicle position icon on the map "lags" a short distance behind, especially when I arrive at an intersection. Is there anything wrong?	No. When at an intersection, the system is unaware of the width of the intersecting road. Large differences in vehicle position can indicate a temporary loss of the GPS signal. See <i>GPS Reception Issues</i> on page 100.

Frequently Asked Questions

Problem	Solution
While I drive, my screen shows white dots (“breadcrumbs”) on it. What do they mean?	These are called “breadcrumbs.” If you drive more than 1/2 mile from mapped roads, the off-road tracking feature begins to function. See <i>Off-road Tracking</i> on pages 61 and 92.
How can I get rid of the white dots (“breadcrumbs”) from my screen?	Go to “Vehicle” in the Setup screen (second), and set Off-road Tracking to Off , then return to the map. See page 92.
A road that I selected to avoid is being used when routing. What is wrong?	When you “draw” your area to avoid, make sure to select sections of roads that include at least one intersection. See page 89.
When I arrive at my destination, the bull’s-eye is shown at a different location on the street. Why?	The system calculates the bull’s-eye location based on the street address range allocated for that street. See <i>Destination Icon</i> on page 56 for an example.
My elevation (shown when I touch the vehicle position icon) seems to fluctuate even though my elevation has not changed.	This is normal and due to errors in satellite position. The elevation can vary +/- 100 feet. See <i>System Limitations</i> on page 100.
My elevation is missing on the “current position” screen. Why?	If the GPS antenna cannot receive at least four satellites, the elevation is not displayed. Try moving the vehicle into an open area. If the elevation is zero or below sea level, the elevation is also not displayed.

Ordering a Navigation DVD, Coverage, Map Errors, Limitations

Problem	Solution
I want to buy a new DVD. How do I purchase one?	You cannot obtain a new DVD from the dealer. See <i>Obtaining a Navigation Update DVD</i> on page 105.
I want to order a DVD. How can I determine the DVD version in my navigation system?	The version is on the label of your DVD. It starts with “Ver:.” See <i>Changing the DVD</i> on page 106.
I got a navigation DVD from a friend or an online source, but it does not work. Why?	Your vehicle was designed to use a turquoise (blue/green) DVD. DVDs with differently colored labels or from different manufacturers will not operate correctly. Always obtain DVDs from the DVD order desk. See page 105.
When is my city going to become part of a fully verified detailed coverage area?	The mapping database vendor is constantly revising map coverage. See page 105 for ways to obtain the latest detailed coverage information.
Will the navigation system work outside North America?	The navigation system contains maps only for the lower 48 U.S. states, Hawaii, and portions of southern Canada. The system will not work in Mexico, Alaska, or overseas. Canada coverage is limited. See <i>Map Coverage</i> on page 109.
I moved my vehicle from the U.S. mainland to Hawaii (or from Hawaii to the U.S. mainland). Why does my navigation system not show the correct map?	The coverage area (Hawaii or U.S. mainland) must be selected by your dealer.
Can I play video DVDs in my navigation system?	No. The navigation system is designed only to read the turquoise (blue/green) DVD provided with your vehicle. Map discs for other vehicle manufacturers or PC map programs will not work.
I found some errors in the database. How do I report them?	Minor errors are bound to occur in a large database. If you encounter major errors, you can report them following the instructions on page 104.

Frequently Asked Questions

Display, PC Card, Accessories

Problem	Solution
The display appears dim when starting the car in really cold weather. Is there a problem?	No. This is normal, and it will become brighter after a few minutes.
The screen does not close completely. Why is this?	<ul style="list-style-type: none">• Ensure that it is not during inserting/ejecting a CD. The screen cannot be closed if a CD is not completely inserted in the unit.• Ensure that it is not during inserting/ejecting the DVD. The screen cannot be closed if the DVD is not completely inserted in the unit.• Ensure that a PC card is inserted completely. The screen cannot be closed if a PC card is not completely inserted in the unit. Moreover, the recognition of a PC card takes about 1-2 seconds after it is inserted. The screen cannot be closed during this recognition.• Ensure that the media clip is inserted into the PC card adaptor. Eject the PC card adaptor when not in use.
Where can I get PC card adaptors or the media chips that go into them?	<ul style="list-style-type: none">• Any computer store sells PCMCIA PC card adaptors, and various types and capacities of media chips for them. Ask for Compact Flash or SD media and adaptors.• Hard Disk Drive type media are not recommended because they can fail in a hot car.
How do I put music files onto the PC Card ?	You can use your home PC to move MP3 or WMA music files to your PC card. Most laptops have a slot to plug in your PC card. For desktop PCs, USB adaptors are available that can accept your PC card or media chip. Move files to the card like to any other hard drive.

Frequently Asked Questions

Problem	Solution
<p>I insert a PC card with music files, but the CARD button or navigation “PC Card” voice commands do not work. What’s wrong?</p>	<ul style="list-style-type: none"> • After inserting the card, a delay of up to 30 seconds may be required to read the tag information (album, artist, and track names) - this is normal. • Ensure that the music files on the media chip are either WMA or MP3 music format. Other formats are not recognized. • Some downloaded WMA and MP3 files are copy protected, and require that the copyright authentication files accompany the MP3/WMA files on the Card. • Media types and capacities continue to grow. As a rule, stick to Compact Flash or SD media with capacities of 2GB or less. Other types of media or larger capacities may work, but have not been tested. • Single-type media PC Card adaptors are recommended over multimedia-type adaptors. • Ensure that there are files on the card. For SD and other media with a write-lock switch, ensure that the write protect is off when adding files to the card. • The system only recognizes FAT and FAT-32 file format for the media.
<p>Some of the files on the PC card will not play, or I have an eight GB card with 2500 songs, but only 999 play. Why is this?</p>	<ul style="list-style-type: none"> • The quantity of tracks is limited to 999 tracks and a file structure of up to eight folder levels deep. Tracks beyond 999 are simply not recognized. • Ensure that the music files on the media chip are either WMA or MP3 music format. Other formats are not recognized.
<p>When I eject the media chip but leave the empty adaptor in the PC card slot, the display door will not close. Why is this?</p>	<p>To prevent damage to the display mechanism or your PC card/media chip, the system checks for a partially inserted PC card and a partially inserted media chip. Always remove the PC card and media chip when not in use.</p>
<p>The media card will not fully insert into the PC card slot. What is wrong?</p>	<ul style="list-style-type: none"> • The PC card edge connector or the pins in the back of PC card slot may be damaged. • Never force the card into the slot - the adaptor card should glide smoothly into the slot. See your dealer if the problem persists.

Frequently Asked Questions

Problem	Solution
<p>I insert a CD-R with music files, but the CD button or “CD” voice commands do not work. What is wrong?</p>	<ul style="list-style-type: none">• After inserting a CD-R with WMA or MP3 files, a slight delay may occur before the CD button operates. The system needs to read the tag information (album, artist, and track names) to allow searches - this is normal.• Ensure that the music files on the CD-R are WMA or MP3 format. Other formats are not recognized.• Some WMA and MP3 files are copy protected, and require that the copyright authentication files accompany the MP3/WMA files on the CD. <p>Note: <i>Never use CD-R discs with stick-on labels. The labels can curl and jam the CD mechanism, requiring replacement of the navigation unit and subsequent loss of all personal information.</i></p>

Miscellaneous Other Questions

Problem	Solution
My clock frequently changes forward and backward by one hour. Why is this?	The clock is being automatically set based on your GPS location. If you live and work on the boundary between two time zones, you can turn off this feature. See page 96.
When driving near a time zone border, the time changes even though I am not near the time zone. Why is this?	The time zone borders are only approximated in the system. Depending on the geography of the time zone boundary, the switch to a different zone can be erratic. See page 96.
My state does not observe daylight saving time. How do I turn off this feature?	You can turn off this feature. See page 95.
Daylight saving time occurred, but the navigation system did not change time even though Setup shows Auto Daylight Saving Time is On .	Go to the Clock adjustment screen in Setup and select DST Selection . Ensure that the correct DST schedule is selected. For more information, see <i>Clock Settings</i> on page 95.
The navigation system automatic daylight time feature is not switching the navigation system clock on the correct dates. Why is this?	<ol style="list-style-type: none"> 1) Go to the Clock adjustment screen in Setup and ensure that Auto Daylight Saving Time is On. 2) The navigation system is designed to switch to daylight saving time according to the months selected in the DST schedule selection screen. Ensure that the appropriate schedule is selected. For more information, see <i>Clock Settings</i> on page 95.
The navigation system clock switched by one hour for no apparent reason. What can cause this?	<ol style="list-style-type: none"> 1) You may be driving near a time zone boundary (see <i>Auto Time Zone by GPS</i> on page 96). 2) The navigation system does not switch between standard and daylight saving time. Set Auto Daylight Saving Time to On on the Clock adjustment screen in Setup, and ensure that the correct month switching schedule is chosen on the DST schedule selection screen. See page 95 for more information.

Frequently Asked Questions

Problem	Solution
My battery was disconnected or went dead, and the navigation system is asking for a code. Where do I find this code?	There should be a card in the glove box with the anti-theft code for the navigation/audio system. This card contains the 4-digit security code and serial number. If you cannot find it, your dealer can help you out.
I speak a language other than English. When will other languages be available for the navigation system?	This is being considered as a future enhancement.

Screen Error Message	Solution
Navigation system is unable to acquire a proper GPS signal.	Make sure there is nothing on the dashboard blocking the GPS antenna (aftermarket metallic window tinting or aftermarket devices placed on the dashboard, like radar detectors, cell phones, or loose items). If the dashboard is clear of objects, move the vehicle to an open space away from tall buildings, trees, etc.
Navigation unit door is open or No DVD disc is inserted. Please check system.	Make sure that the navigation DVD disc is inserted with the label side up and the navigation unit door is fully snapped closed (see page 106).
No DVD disc. Please check system.	Check that the navigation DVD disc is inserted with the label side up (see page 106). If the problem persists, see your dealer.
DVD disc reading error (unformatted). Please consult your dealer.	Check the DVD disc surface for deep scratches or other damage. Make sure you are using a navigation DVD (turquoise-colored [blue/green] label). The system cannot read other mapping databases or video DVDs. If the problem persists, see your dealer.
Display temp is too high. System will shut down until display cools down.	This message will appear briefly when the display temperature is too high, and then the display will turn off until the temperature cools down. The system will turn back on when the display cools down.
Outside temperature is low. System will take a while to start up.	The temperature is below -22°F and the navigation system has difficulty reading the DVD. The system will start up when the temperature warms up.
Navigation system voice recognition cannot be activated when another unit is using the audio system.	<i>Bluetooth</i> ® HandsFreeLink® can override the navigation system. Make sure the HFL TALK button is not on when you press the NAVI TALK button, or the message will appear. Simply press the HFL BACK button to resume control of the navigation voice buttons.
Route has not been completed. Please try again from a different location.	This message will appear when you are routing to or from a place (new area) that is not in the database. Try planning a different route to or from a different location.*

Troubleshooting

Screen Error Message	Solution
No alternate route found. Original route will be followed.	No alternative route method was found. The original route method will be used.* Ensure that a road name is displayed at the bottom of the map.
This destination cannot be found in database.	The destination was not found in the database. Try another destination nearby, or select the destination with the joystick.*
Vehicle is out of the database coverage area.	The vehicle is located outside of the mapped area provided by your navigation DVD. See page 109 for map coverage.

* If the error persists or is shown for a wide area, see your dealer.

Glossary

The following is a glossary of terms pertaining to the voice recognition navigation system.

Avoid Area - Areas you wish to avoid can be entered into the system, and will be avoided while routing.

Breadcrumbs - Off-road tracking dots that can be followed on the map to retrace your route back to a mapped (digitized) road. This function can be turned on/off in **Setup** screen (second).

Compact Flash - A media chip that can be used with a PC card adaptor to play audio music files.

Database - This consists of the map data, and the POI (Points of Interest) data stored on the DVD.

DCA - Detailed Coverage Area. The main metropolitan areas in the lower 48 U.S. states, Hawaii, and southern Canada are mapped to this level. See page 109 for a list of these areas.

Digital Audio Card Reader - The PC card slot accepts a PCMCIA adaptor with a flash memory chip (see page 107).

Digitized Road - A road that appears on the navigation screen. The road name will appear at the bottom of the navigation screen. If the user drives "off road," the navigation system will display "breadcrumbs," depending on how far you drive from a mapped road.

Disclaimer Screen - Screen containing cautionary information. It is meant to be read carefully and acknowledged by the customer when using the navigation system.

DVD or DVD-ROM - Digital Versatile Disc. The navigation program and database resides on this disc. For information on how to order a replacement or update DVD, see page 105.

FAQ - Frequently Asked Questions. See page 125 for a list of customer FAQs and troubleshooting information.

GPS - Global Positioning System. A network of 24 satellites in orbit around the earth. The navigation system can simultaneously receive signals from up to 12 satellites to accurately position the vehicle on the map.

GPS Antenna - Located under the dashboard. Electronic items operating in this general location can interfere with the GPS signal.

HFL - *Bluetooth*® HandsFreeLink®. Your vehicle is equipped with this feature, which uses Bluetooth technology as a wireless link between the vehicle and your Bluetooth-compatible cell phone.

Icon - Symbol representing Points of Interest (POI) that can be displayed on the map.

Initialization - This refers to the period needed to reacquire the GPS satellite orbital information whenever the navigation system power has been disconnected. This can take 10 to 45 minutes with the vehicle out in an open area.

Glossary

LCD - Liquid Crystal Display. The navigation screen.

Map Matching - The received GPS information allows the navigation system to position the vehicle on the map. Map matching has occurred if the map screen is displaying the current street name in the bottom-shaded area.

Mic - Abbreviation for the microphone used for receiving voice commands. It is located near the map light in the ceiling.

MP3 - A music file format that can be played from a CD-R, USB thumb drive, or PC card.

MW - Maneuver Window. While en route to a destination, this window displays information about the next maneuver.

Navi - Abbreviation for the navigation system.

North Pointer - The map symbol showing the map orientation. See page 56.

Off Route - This occurs when the user leaves mapped roads. Off-road tracking dots (“breadcrumbs”) are displayed if the option is enabled in the **Setup** screen. The user can use them to return to a mapped road. The bottom of the navigation screen will say, “Not on a digitized road.”

Outlying Areas - These are rural areas that typically have only their main roads mapped. All other roads are shown in light brown for reference only, since they have not been verified.

PC Card - An adaptor card (sometimes called a PCMCIA card) that can contain a compact flash, or SD media clip with MP3 or WMA music files.

PIN - Personal Identification Number. A 4-digit number created by the customer to protect personal information.

POI - Point of Interest. These are the businesses, schools, etc. found under the **Places** option on the **Enter destination** by screen. See page 32.

Polygon - Colored areas on the map screen denoting parks, schools, etc. See *Map Screen Legend* “Map Features” for a list of the assigned colors. See page 51.

QWERTY - Keyboard layout resembling the typewriter keys. The keyboard layout can be changed to an alphabetical layout in the **Setup, Basic Settings** screen.

Reminder - Automatic “pop-up” Calendar message. See *Calendar* on page 72.

Secure Digital (SD) Media - These can be installed into a PCMCIA adaptor to play MP3 or WMA music files.

Security Code - Code needed to activate the navigation system or audio unit. See *Entering the Security Code* on page 98.

Touch Sensor - The touch sensor on the front of the LCD consists of a touch sensitive resistive membrane with an infinite number of possible touch locations. The sensing locations are confined to a grid of 20 vertical and 10 horizontal touch locations.

Unverified Streets - These streets have not been verified for turn restrictions, one-way, etc. They are shown in light brown on the map. Unverified streets may be missing from the map, shown in the wrong location, or have an incorrect name or address range.

USB - Universal Serial Bus. A computer hardware interface used to store and play audio files (MP3, WMA, AAC) from USB devices, such as thumb drives or iPods. See the Audio section in your Owner's Manual for more information.

Vehicle Speed Sensor - Provides speed signal to the navigation system for moving the VP icon on the map.

Verified Streets - These streets consist of the detailed metropolitan coverage areas and all other inter-town connection roads. These roads are shown in black on the map.

Voice Control - See VR.

VP - Vehicle Position. When in map mode, this circular icon shows the vehicle position on the map. Touch this icon to show the latitude, longitude, and elevation of your current position.

VR - Voice Recognition. This allows voice control of many of the navigation functions. The hardware consists of the microphone, voice control switch (**NAVI TALK/NAVI BACK** buttons), and the front speakers.

Waypoint - A temporary destination you may enter while en route (e.g., a gas station, ATM, etc.). See page 64.

WMA - A Windows media audio file that can be played from a CD-R, USB thumb drive, or PC card.

Yaw Rate Sensor - Senses when the vehicle makes a turn, which makes the VP change direction on the map as you turn.

Voice Command Index

Global Commands

The system accepts these commands on any screen.

Help (reads list of the commands for the displayed screen)

Setup (displays the **Setup** screen (first))

Display map (displays the map screen)

Display menu (displays the **Enter destination** by screen)

Display audio screen

Information (displays the **Information** screen)

Back (to previous screen, same as **CANCEL** or **NAVI BACK** button)

Cancel (cancels current activity)

What time is it?

The “Voice Command Help” option on the **Information** screen lists many of the following controls. To avoid distraction while you are driving, the system can read the commands for you.

The commands are accessible at any time while driving and can be read to you so that you do not need to memorize all of them.

Navigation General Commands

The system accepts these commands on a map/guidance screen.

Display menu (if en route, displays the **Change route** by screen)

Display navigation (if en route, displays the **Change route** by screen)

Display map

Display map guide (same function as the **MAP/GUIDE** button)

Display setup (or just *Setup*)

Display information (or just *Information*)

Display audio screen

Cancel

Backward (or just *Back*)

What time is it?

Repeat voice (repeats the screen prompt for most screens)

Help (displays the voice command allowed for the screen you are viewing)

Voice command help

How long to the destination? (when en route, tells the time to destination)*

How far to the destination? (when en route, tells the distance to destination)*

Display destination map (when en route, shows the map of the destination)

Display entire route (when en route, adjusts the map scale so that the entire route is displayed)

Register the current location (puts current location in the personal **Address Book**)

* These commands are not available if you scroll through the map while en route to a destination.

Navigation Display Commands

The system accepts these commands on a map/guidance screen.

Display current location (shows current latitude, longitude, and elevation)

Display north up

Display heading up

Display zoom in

Display zoom out

Display: (the selected scale)

1/20 mile (80 m) scale

1/8 mile (200 m) scale

1/4 mile (400 m) scale

1/2 mile (800 m) scale

1 mile (1600 m) scale

2 mile (3 km) scale

5 mile (8 km) scale

15 mile (24 km) scale

50 mile (80 km) scale

150 mile (240 km) scale

350 mile (560 km) scale

Display: (display the selected icon on the screen)

ATM

gas station

restaurant

*post office**

grocery store

*lodging (hotel, motel)**

*parking garage**

*parking lot**

*school**

*hospital**

*one way**

freeway exit information

* These icons will not be displayed unless the “Parking” or “Other icon” is selected on the Icon Bar (see page 59).

Hide: (hide the selected icon from the screen)

ATM

gas station

restaurant

post office

grocery store

lodging (hotel, motel)

parking garage

parking lot

school

hospital

one way

freeway exit information

Max zoom in

Max zoom out

Go home

Voice Command Index

Find Place Commands

The system accepts these commands on a map/guidance screen.

Find nearest: (find the nearest selection)

ACURA dealers

HONDA dealers

gas station

hydrogen station

ATM

bank

post office

hospital

police station

hotel

tourist attraction

restaurant (all restaurant types)

American restaurant

Chinese restaurant

fast food

Italian restaurant

Japanese restaurant

Mexican restaurant

seafood restaurant

shopping (all shopping types)

parking garage

parking lot

other car dealers

auto parts & electronics

auto repair & maintenance

car wash & detailing

motorcycle dealers

roadside assistance

check cashing

currency exchange

veterinarian

Korean restaurant

Coffee shop/café

Californian restaurant

continental restaurant

French restaurant

German restaurant

Greek restaurant

Indian restaurant

pizza

Thai restaurant

vegetarian restaurant

Vietnamese restaurant

other restaurant

business

civic center

convention center

library

school

city hall

court house

higher education

amusement park

golf course

historical monument

marina

movie theater

museum

park

performing arts

sports complex

bed & breakfast

accessory store

book store

clothing store

grocery store

home improvement store

mall

office supply store

pharmacy

pet food store

sewing store

shoe store

sporting goods store
toy store
airport
automobile club
bus station
camping
commuter rail station
ferry terminal
named place
park & ride
rental car agency
resort
rest area
ski area
tourist information
train station
travel agency
truck stop

Climate Control Commands

The system accepts these commands on most screens.

Climate control full automatic
(controls temperature to 72 degrees F)

Climate control automatic (controls temperature to your selection)

Climate control off

Air conditioner on

Air conditioner off

*Air conditioner**

Climate control defrost on

Climate control defrost off

*Climate control defrost**

Rear defrost on

Rear defrost off

*Rear defrost**

Climate control fresh air

Climate control recirculate

Climate control vent

Climate control bi-level (vent and floor)

Climate control floor

Climate control floor and defrost

Fan speed up

Fan speed down

Fan speed # (#: 1-7) (for best voice control, lower the fan speed)

- * Repeating these commands switches (toggles) the function between On and Off, so the action that occurs may not match the command you speak.

Voice Command Index

Temperature Voice Commands

The system accepts these commands on most screens.

Temperature # degrees (#: 57-87 degrees F)

Temperature up

Temperature down

Temperature max hot

Temperature max cold

Radio Voice Commands

The system accepts these commands on most screens.

*Audio on**

*Audio off**

*Radio on**

*Radio off**

Radio select FM1

Radio select FM2

Radio select AM

Radio tune to # FM (#: frequency.

Example Radio 95.5 FM)

Radio tune to # AM (#:frequency.

Example Radio 1020 AM)

Radio seek up

Radio seek down

Radio next station (same as Radio seek)

Radio preset # (#: 1-6)

Radio FM preset # (#: 1-6)

Radio FM1 preset # (#: 1-6)

Radio FM2 preset # (#: 1-6)

Radio AM preset # (#: 1-6)

*Radio auto select**

*Radio scan**

Radio select XM1

Radio select XM2

XM channel # (#: 1-255)

XM channel up

XM channel down

XM category up

XM category down

XM preset # (#: 1-6)

XM1 preset # (#: 1-6)

XM2 preset # (#: 1-6)

*XM scan**

*XM category scan**

*XM channel scan**

XM category mode

XM channel mode

- * Repeating these commands switches (toggles) the function between On and Off, so the action that occurs may not match the command you speak.

NOTE:

Radio volume levels cannot be controlled using voice control. Use the buttons on your steering wheel. See your Owner's Manual for more information.

CD Voice Commands

The system accepts these commands on most screens.

CD play
CD play track # (#: 1-30)
CD skip forward
CD skip back
*CD track random**
*CD track repeat**
*CD track scan**
*CD folder random**
*CD folder repeat**
*CD folder scan**
CD normal play
CD track list

* Repeating these commands switches (toggles) the function between On and Off, so the action that occurs may not match the command you speak.

PC Card Voice Commands

The system accepts these commands on most screens.

Card play
Card play track # (#: 1-30)
Card skip forward
Card skip back
*Card track random**
*Card track repeat**
*Card track scan**
*Card folder random**
*Card folder repeat**
*Card folder scan**
*Card artist random**
*Card artist repeat**
*Card artist scan**
*Card album random**
*Card album repeat**
*Card album scan**
Card normal play
Card track list

* Repeating these commands switches (toggles) the function between On and Off, so the action that occurs may not match the command you speak.

AUX Voice Commands

The system accepts these commands on most screens.

AUX play (or Auxiliary play)

NOTE:

For more information on USB features, see your Owner's Manual.

Voice Command Index

Information Screen Voice Commands

These are additional commands not found on the Voice Command Help screen available when viewing the Information screen. Follow the voice prompts.

Cellular phonebook

Voice command help (the system reads and lists all of the commands, starting with Navigation General Commands)

Map legend

Calendar

Calculator

Setup Screen (first) Commands

The system accepts these commands on the Setup screen (first). (For the Setup screen (second), simply say what is written on the screen, and follow the voice prompts.)

Brightness up

Brightness down

Brightness minimum/min.

Brightness maximum/max.

Volume up (tone indicates volume)

Volume down (tone indicates volume)

Volume minimum/min. (tone indicates volume)

Volume maximum/max. (tone indicates volume)

Volume Off

Display off (screen goes dark, route guidance stops)

Display Day

Display Night

Display Auto

Contrast adjust

Guidance Prompts normal

Guidance Prompts maximum/max.

Guidance Prompts minimum/min.

On-Screen Commands

The system accepts these commands on any screen. There are over 100 on-screen commands. Just say what is written on the screen (this excludes keyboard letters, and listed items)

Next (or “Down”)

Previous (or “Up”)

Return

OK (except at Disclaimer screen)

Delete

Done

On-Screen Commands Assist

Say or touch the desired letter. When speaking the letters or using “spell mode,” you can substitute the name that represents each letter or symbol. This improves recognition.

NOTE:

- *The system will only respond to the names shown in the graphic below.*
- *For instance, to select the letter “A,” you can touch the “A” on the screen, or say “A,” or say “Alpha” or “Apple.”*
To select the number “1,” touch the “1” on the screen, or say “one,” or say “Number One.”
To select the symbol “- (hyphen),” touch the “-” on the screen, or say “Hyphen,” or say “Symbol Hyphen.”
- *When selecting letters using the voice control system, a confirmation box may pop up to confirm the letter.*

Edit message:

JOE_ 1ST LINE

1	2	3	4	5	6	7	8	9	0	- Hyphen
A Alpha Apple	B Bravo Boy	C Charlie	D Delta Dog	E Echo Edward	F Foxtrot Frank	G Golf George	H Hotel Henry	I India Igloo	J Juliet John	' Apostrophe
K Kilo King	L Lima Larry	M Mike Mary	N November Nancy	O Oscar	P Papa Paul	Q Quebec Queen	R Romeo Robert	S Sierra Sam	T Tango Tom	& Ampersand
U Uniform Uncle	V Victor	W Whiskey William	X X-ray	Y Yankee Yellow	Z Zulu Zebra			/ Slash	↩	
Delete		Shift		Space Space		More		Done		

Voice Command Index

Symbol Assist Definitions

Enter name:

DON_

À a grave	Â a circumflex	Ä a umlaut	Ç c cedilla	È e grave	É e acute	Ê e circumflex	Ë e umlaut	ì i grave	î i circumflex	ï i umlaut
Ô o circumflex	Ù u grave	Û u circumflex	Ü u umlaut					+	{ Open brace	} Close brace
! Exclamation Point	” Double Quote	# Pound	\$ Dollar	% Percent	` Back Quote	(Open parenthesis) Close parenthesis	~ Tilde	^ Caret	, Comma
- Underscore	@ At sign	* Asterisk	? Question mark	; Semicolon	: Colon	< Less than	> Greater than	. Dot	←	
Delete	Shift	Space Space		More	Done					

NOTE:

The term “grave” used for these keys (À, È, ì, and Ù) is pronounced like “save.”

A

Accessing the Address Book List	79
ADD TO Today's Destinations	42, 46
Adding Destinations to the List	42
Address	22, 23, 80
Address Book	22, 43, 78
Address Book PIN	82
Advanced	34
Alaska (Operation)	123
Auto Daylight Saving Time	95
Auto Service	34
Auto Time Zone by GPS	96
AUX Voice Commands	145
Avoid Streets	66

B

Back to Current Route	67
Banking	34
Basic Settings	94
Bluetooth® HandsFreeLink®	18
Breadcrumbs	19, 61, 92
Brightness	75
By Address	23
By Address Book	43
By Go Home	44
By Intersection	27

By Map Input	37
By Places	32
By Previous Destinations	41
By Today's Destinations	42

C

Calculator	73
Calendar	17, 72
CALL	18
CANCEL button	11
Cancel Current Route	67
Category	32, 33, 44, 81
CD Voice Commands	145
Cellular Phonebook	70
Change Method	47
Change State	23, 28
Changing the DVD	106
Changing the Route	64
Changing the Routing Method	47
Changing Your Destination	67
City	23, 28, 39
City Vicinity	33, 36
Climate Control Commands	143
Clock Adjustment	95
Clock Screen	17, 77
Clock Settings	17, 77
Clock Type	17, 77
CLOSE button	10, 106

Color	97
Community	34
Continental USA	40
Contrast	77
Convert (Unit)	74
Correct Vehicle Position	93
Coverage Areas	109
Current Location	20, 62
Current Position	37, 80
Current Street	6
Customer Assistance	104

D

Database Limitations	102
Daylight Saving Time (DST) Selection	96
Delete Previous Destination	83
Destination	22, 46, 67
Destination Icon	56
Destination Map	49
Detailed Coverage Areas	109, 114
Detour	66
Direct Route	47
Direction List	53
Display	76
Driving to Your Destination	46

Index

E

Easy Route	47
Edit Avoid Area	89
Edit Waypoint Search Area.....	91
Edit/Delete Address	81
Editing Today's Destinations List	42
Emergency	34
Entering a Destination	22
Entering Address.....	79
Entering Security Code.....	98
Entering the Street Number.....	27
Entering Your Schedule.....	72
Error Message.....	135

F

Find Place Commands	142
Frequently Asked Questions	125

G

Getting Started.....	10
Global Commands	140
Glossary	137
Go Home.....	22, 44
Go Home PIN.....	83
Going Off the Route.....	61
GPS Initialization.....	99

Guidance Mode.....	54, 92
Guidance Prompts	77
Guidance Screen	52

H

Hawaii (Operation).....	123
Home Address	82
Honda Automobile Customer Service	104
Hotel/Motel (Lodging)	34

I

Icon Bar	59
INFO button	11, 70
Information.....	70
Information Screen Voice Commands.....	146
Intersection.....	22, 27

J

Joystick	11
----------------	----

K

Keyboard Layout	94
-----------------------	----

L

Landmark Icons	57
Leisure	34
Lodging (Hotel/Motel).....	34

M

Map Color	97
Map Coverage.....	109
Map Input.....	22, 37
Map Legend.....	19, 51, 71
Map Matching.....	99
Map Orientation.....	56
Map Scale.....	55
Map Screen.....	19, 51
MAP/GUIDE button.....	11, 52
Maximize Freeways	47
MENU button	11, 22
Menu Color	97
Message	73
Microphone	12
Minimize Freeways	47
Minimize Toll Roads	47

N

Name32, 36, 79
 NAVI BACK button.....12
 NAVI TALK button.....12
 Navigation Display Commands.....141
 Navigation General Commands.....140

O

Off-road Tracking61, 92
 One-Way Traffic Icon57
 On-Screen Commands.....147
 On-Screen Commands Assist.....147
 On-Screen Keyboard.....15

P

PC Card.....107
 PC Card Voice Commands145
 Personal Information78
 Phone Number32, 37, 80
 PIN Number82
 Place Name33, 36
 Place Name by Keyword33, 35
 Places.....22, 32, 80
 Previous Destinations22, 41, 80

R

Radio Voice Commands144
 Read List71
 Recalculation84
 Reporting Errors104
 Reroute.....64
 Rerouting84
 Restaurant34
 Routing & Guidance.....84

S

Save Current Location62
 Schedule.....72
 Screen11
 Security Code98
 Selecting the City.....23, 28
 Selecting the State or
 Province23, 28
 Selecting the Street.....25, 30
 Setup.....75
 Setup Screen (first)
 Commands.....146
 Shopping34
 Showing Icons on the Map.....57, 59
 Sort by Distance to Travel33, 36
 State.....39
 Street.....25, 30

System Controls.....10
 System Function Diagram.....21
 System Information94
 System Initialization.....98
 System Limitations.....100
 System Setup75
 System Start-up.....16

T

Temperature Voice Commands144
 Time Adjustment96
 Title73
 Today's Destinations22, 42
 Today's Destinations List42
 Travel.....34
 Troubleshooting135

U

Unit Conversion74
 Units (mile or km).....94
 Unverified Area Routing.....85, 86
 Unverified Streets7
 Update DVD.....105
 User Name.....83
 Using the Voice Control System.....13

Index

V

Vehicle.....	92
Verified Streets	7
View Routes	48
Voice Command Help	70
Voice Command Index	140
Voice Control Basics.....	12
Voice Recognition Feedback.....	94
Voice Recognition, Improving	13
Volume	75

Z

ZOOM buttons.....	11
-------------------	----

License notice

You have acquired a device (“DEVICE”) that includes software licensed by ALPINE ELECTRONICS, INC., from an affiliate of Microsoft Corporation (collectively “MS”). Those installed software products of MS origin, as well as associated media, printed materials, and “online” or electronic documentation (“SOFTWARE”) are protected by international intellectual property laws and treaties. The SOFTWARE is licensed, not sold. All rights reserved.

IF YOU DO NOT AGREE TO THIS END USER LICENSE AGREEMENT (“EULA”), DO NOT USE THE DEVICE OR COPY THE SOFTWARE. INSTEAD, PROMPTLY CONTACT ALPINE ELECTRONICS, INC., FOR INSTRUCTIONS ON RETURN OF THE UNUSED DEVICE(S) FOR A REFUND. ANY USE OF THE SOFTWARE, INCLUDING BUT NOT LIMITED TO USE ON THE DEVICE, WILL CONSTITUTE YOUR AGREEMENT TO THIS EULA (OR RATIFICATION OF ANY PREVIOUS CONSENT).

GRANT OF SOFTWARE LICENSE.

This EULA grants you the following license;

You may use the SOFTWARE only on the DEVICE.

NOT FAULT TOLERANT. THE SOFTWARE IS NOT FAULT TOLERANT. ALPINE ELECTRONICS, INC., HAS INDEPENDENTLY DETERMINED HOW TO USE THE SOFTWARE IN THE DEVICE, AND MS HAS RELIED UPON ALPINE ELECTRONICS, INC., TO CONDUCT SUFFICIENT TESTING TO DETERMINE THAT THE SOFTWARE IS SUITABLE FOR SUCH USE.

NO WARRANTIES FOR THE SOFTWARE. THE SOFTWARE is provided “AS IS” and with all faults. THE ENTIRE RISK AS TO SATISFACTORY QUALITY, PERFORMANCE, ACCURACY, AND EFFORT (INCLUDING LACK OF NEGLIGENCE) IS WITH YOU. ALSO, THERE IS NO WARRANTY AGAINST INTERFERENCE WITH YOUR ENJOYMENT OF THE SOFTWARE OR AGAINST INFRINGEMENT. IF YOU HAVE RECEIVED ANY WARRANTIES REGARDING THE DEVICE OR THE SOFTWARE, THOSE WARRANTIES DO

NOT ORIGINATE FROM, AND ARE NOT BINDING ON, MS.

No Liability for Certain Damages. EXCEPT AS PROHIBITED BY LAW, MS SHALL HAVE NO LIABILITY FOR ANY INDIRECT, SPECIAL, CONSEQUENTIAL OR INCIDENTAL DAMAGES ARISING FROM OR IN CONNECTION WITH THE USE OR PERFORMANCE OF THE SOFTWARE. THIS LIMITATION SHALL APPLY EVEN IF ANY REMEDY FAILS OF ITS ESSENTIAL PURPOSE. IN NO EVENT SHALL MS BE LIABLE FOR ANY AMOUNT IN EXCESS OF U.S.TWO HUNDRED FIFTY DOLLARS (U.S.\$250.00).

Limitations on Reverse Engineering, Decompilation, and Disassembly. You may not reverse engineer, decompile, or disassemble the SOFTWARE, except and only to the extent that such activity is expressly permitted by applicable law notwithstanding this limitation.

Additional Software/Services. The SOFTWARE may permit ALPINE ELECTRONICS, INC., MS, Microsoft Corporation or their affiliates to provide or make available to you SOFTWARE updates, supplements, add-on components, or Internet-based services components of

the SOFTWARE after the date you obtain your initial copy of the SOFTWARE (“Supplemental Components”).

- If ALPINE ELECTRONICS, INC., provides or makes available to you Supplemental Components and no other EULA terms are provided along with the Supplemental Components, then the terms of this EULA shall apply.
- If MS, Microsoft Corporation or their affiliates make available Supplemental Components, and no other EULA terms are provided, then the terms of this EULA shall apply, except that the MS, Microsoft Corporation or affiliate entity providing the Supplemental Component(s) shall be the licensor of the Supplemental Component(s).

ALPINE ELECTRONICS, INC., MS, Microsoft Corporation and their affiliates reserve the right to discontinue any Internet-based services provided to you or made available to you through the use of the SOFTWARE.

RECOVERY MEDIA. If SOFTWARE is provided by ALPINE ELECTRONICS, INC., on separate media and labeled “Recovery Media” you may use the Recovery Media solely to restore or reinstall the SOFTWARE originally installed on the DEVICE.

SOFTWARE TRANSFER ALLOWED BUT WITH RESTRICTIONS. You may permanently transfer rights under this EULA only as part of a permanent sale or transfer of the Device, and only if the recipient agrees to this EULA. If the SOFTWARE is an upgrade, any transfer must also include all prior versions of the SOFTWARE.

EXPORT RESTRICTIONS. You acknowledge that SOFTWARE is of US-origin. You agree to comply with all applicable international and national laws that apply to the SOFTWARE, including the U.S. Export Administration Regulations, as well as end-user, end-use and country destination restrictions issued by U.S. and other governments. For additional information on exporting the SOFTWARE, see <http://www.microsoft.com/exporting/>.

*As required by the FCC:
This device complies with Part 15 of the FCC rules. Operation is subject to the following two conditions: (1) This device may not cause harmful interference, and (2) this device must accept any interference received, including interference that may cause undesired operation.*

Changes or modifications not expressly approved by the party responsible for compliance could void the user’s authority to operate the equipment.

This device complies with Industry Canada Standard RSS-210.

Operation is subject to the following two conditions: (1) this device may not cause interference, and (2) this device must accept any interference that may cause undesired operation of the device.