

**2012  
Honda  
TRX420TM  
TRX420FM 4×4  
TRX420FPM 4×4 with Power Steering  
FOURTRAX RANCHER  
OWNER'S MANUAL**

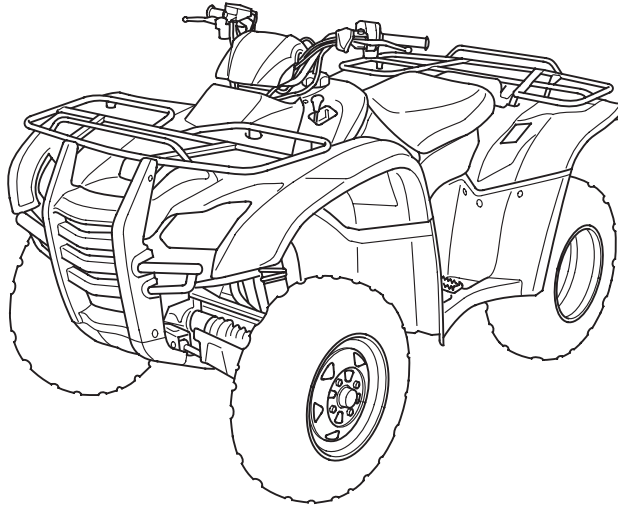

**FOR OFF-ROAD USE ONLY**

This vehicle is designed and manufactured for off-road use only.

It conforms to US EPA Noise Emission regulations, but does not conform to Federal Motor Vehicle Safety Standards or US EPA On Highway Exhaust Emission regulations, and operation on public streets, roads, or highways is illegal. The vehicle is equipped with a USDA qualified spark arrester. Obey local laws and regulations.

It conforms to US EPA and California emission regulations for ATVs.

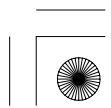
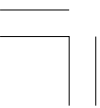



## Introduction

---

Congratulations on choosing your Honda ATV.

When you own a Honda, you're part of a worldwide family of satisfied customers — people who appreciate Honda's reputation for building quality into every product.

Your Honda was designed as a recreational ATV for off-road use by one rider only.

Before riding, take time to get acquainted with your ATV and how it works. To protect your investment, we urge you to take responsibility for keeping your ATV well maintained. Scheduled service is a must, of course. But it's just as important to observe the break-in guidelines, and perform all pre-ride and other periodic checks detailed in this manual.

We also recommend that you read this owner's manual before you ride. It's full of facts, instructions, safety information, and helpful tips. To make it easy to use, the manual contains a detailed list of topics at the beginning of each section and an index at the back of the book.

As you read this manual, you will find information that is preceded by a **NOTICE** symbol. This information is intended to help you avoid damage to your Honda, other property, or the environment.

Read the Warranties Booklet (page 225 ) thoroughly so you understand the coverages that protect your new Honda and are aware of your rights and responsibilities.

Whenever you ride, tread lightly. By staying on established trails and riding only in approved areas, you help protect the environment and keep off-road riding areas open for the future.

### Introduction



## Introduction

---

If you have any questions, or if you ever need special service or repairs, remember that your dealer knows your ATV best and is dedicated to your complete satisfaction.

Please report any change of address or ownership to your dealer so we will be able to contact you concerning important product information.

You may also want to visit our website at [www.powersports.honda.com](http://www.powersports.honda.com).

Happy riding!

### California Proposition 65 Warning

**WARNING:** This product contains or emits chemicals known to the State of California to cause cancer and birth defects or other reproductive harm.

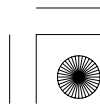
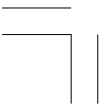



## A Few Words About Safety

---

Your safety, and the safety of others, is very important. And operating this ATV safely is an important responsibility.

To help you make informed decisions about safety, we have provided operating procedures and other information on labels and in this manual. This information alerts you to potential hazards that could hurt you or others.

Of course, it is not practical or possible to warn you about all hazards associated with operating or maintaining an ATV. You must use your own good judgment.

You will find important safety information in a variety of forms, including:

**Safety Labels** — on the ATV.

**Safety Messages** — preceded by a safety alert symbol  and one of three signal words: **DANGER**, **WARNING**, or **CAUTION**.

## A Few Words About Safety





## A Few Words About Safety

---

These signal words mean:

 **DANGER**

You **WILL** be **KILLED** or **SERIOUSLY HURT** if you don't follow instructions.

 **WARNING**

You **CAN** be **KILLED** or **SERIOUSLY HURT** if you don't follow instructions.

 **CAUTION**

You **CAN** be **HURT** if you don't follow instructions.

 **Safety Headings** — such as Important Safety Reminders or Important Safety Precautions.

**Safety Section** — such as ATV Safety.

**Instructions** — how to use this ATV correctly and safely.

This entire manual is filled with important safety information — please read it carefully.

A Few Words About Safety





# Contents

---

These pages give an overview of the contents of your owner’s manual. The first page of each section lists the topics covered in that section.

**ATV Safety ..... 1**  
Important safety information you should know, plus a look at the safety related labels on your ATV.

**Instruments & Controls..... 9**  
The location and function of indicators and controls on your ATV and operating instructions for various controls and features.

**Before Riding..... 37**  
The importance of wearing a helmet and other protective gear, how to make sure you and your ATV are ready to ride, and important information about loading.

**Basic Operation & Riding ..... 53**  
How to start and stop the engine, shift gears, and brake. Also, riding precautions.



## Contents

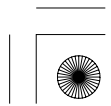



# Contents

**Servicing Your Honda** ..... 85  
 Why your ATV needs regular maintenance, what you need to know before servicing your Honda, an owner maintenance schedule, and instructions for specific maintenance and adjustment items.

**Tips** ..... 175  
 How to store and transport your ATV and how to be an environmentally responsible rider.

**Taking Care of the Unexpected** ..... 185  
 What to do if you have a flat tire, your engine won't start, etc.

**Technical Information** ..... 207  
 ID numbers, technical specifications, and other technical facts.

**Consumer Information** ..... 223  
 Information on warranties, emission controls, how to get Honda service manuals.

**Index** ..... 230

**Quick Reference**  
 Handy facts about fuel, engine oil, tire sizes, and air pressures.





11/05/09 13:02:08 31HP4650 0009

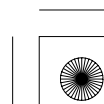
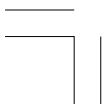



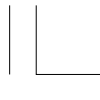

# ATV Safety

This section presents some of the most important information and recommendations to help you ride your ATV safely. Please take a few moments to read these pages. This section also includes information about the location of safety labels on your ATV.

Important Safety Information .....	2
Safety Labels.....	5

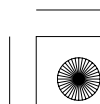
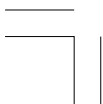



## Important Safety Information

---

Your ATV can provide many years of service and pleasure if you take responsibility for your own safety and understand the challenges you can meet while riding.

There is much that you can do to protect yourself when you ride. You'll find many helpful recommendations throughout this manual. The following are a few that we consider to be most important.

### **Follow the Age Recommendation**

The minimum recommended age for this ATV model is 16. Children under age 16 should never operate this vehicle. Refer to the age warnings provided in this manual and on the ATV.

### **Always Wear a Helmet**

It's a proven fact: helmets significantly reduce the number and severity of head injuries. So always wear an approved motorcycle helmet. We also recommend that you wear eye protection, sturdy boots, gloves, and other protective gear (page 38).

### **Never Carry a Passenger**

Your ATV is designed for one person only. There are no handholds, footrests, or seat for a second person, so never carry a passenger. A passenger could interfere with your ability to move around to maintain your balance and control of the ATV.

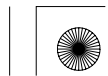



## Important Safety Information

---

### **Ride Off-road Only**

Your ATV is designed and manufactured for off-road use only. The tires are not made for pavement, and the ATV does not have turn signals and other features required for use on public roads. If you need to cross a paved or public road, get off and walk your ATV across.

### **Take Time to Learn & Practice**

Even if you have ridden other ATVs, take time to become familiar with how this ATV works and handles. Practice in a safe area until you build your skills and get accustomed to the ATV's size and weight.

Because many crashes involve inexperienced or untrained riders, we urge all riders to take a ATV operator course approved by the ATV Safety Institute (ASI). See page 40 .

Contact an authorized ATV dealer or call 1-800-887-2887 to find out about the training courses nearest you.

### **Be Alert for Off-road Hazards**

The terrain can present a variety of challenges when you ride off-road. Continually "read" the terrain for unexpected turns, drop-offs, rocks, ruts, and other hazards. Always keep your speed low enough to allow time to see and react to hazards.



## Important Safety Information

---

### **Ride within Your Limits**

Pushing limits is another major cause of ATV crashes. Never ride beyond your personal abilities or faster than conditions warrant. Remember that alcohol, drugs, fatigue, and inattention can significantly reduce your ability to make good judgments and ride safely.

### **Don't Drink and Ride**

Alcohol and riding don't mix. Even one drink can reduce your ability to respond to changing conditions, and your reaction time gets worse with every additional drink. So don't drink and ride, and don't let your friends drink and ride either.

### **Keep Your Honda in Safe Condition**

It's important to keep your ATV properly maintained and in safe riding condition. Having a breakdown can be difficult, especially if you are stranded off-road far from your base. To help avoid problems, inspect your ATV before every ride and perform all recommended maintenance.

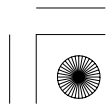



## Safety Labels

---

Your ATV comes with a hang tag and several labels containing important safety information. Anyone who rides the vehicle should read and understand this information before riding.

The labels should be considered permanent parts of the vehicle. If a label comes off or becomes hard to read, contact your dealer for replacements.

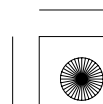
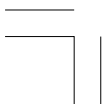



# Safety Labels

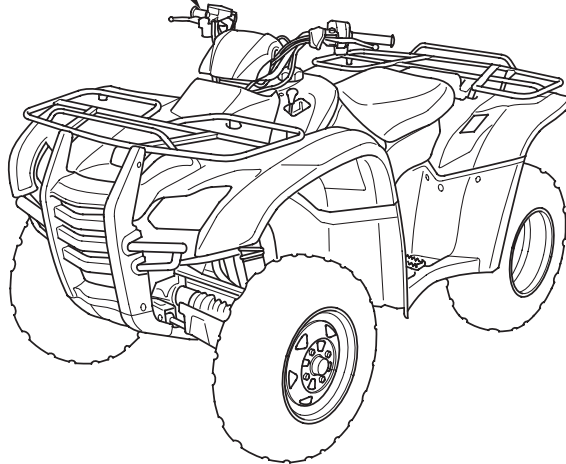
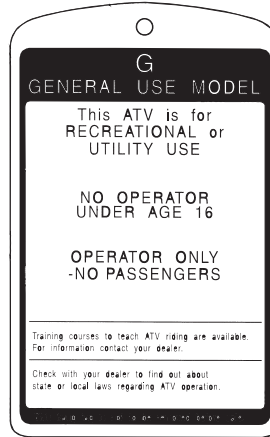

## 6 ATV Safety

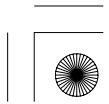



# Safety Labels

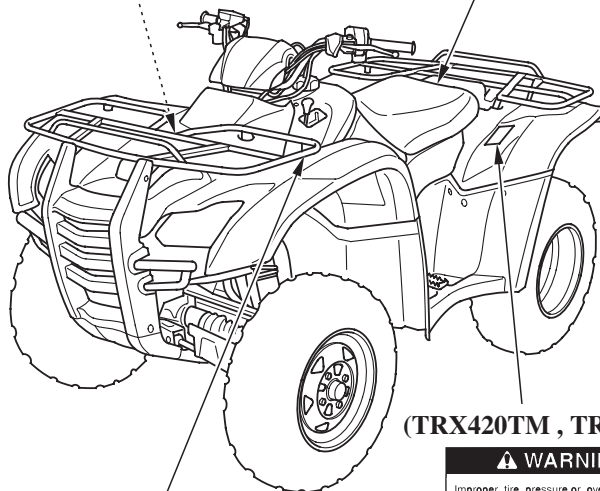

(TRX420TM, TRX420FM)

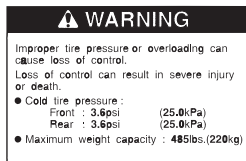
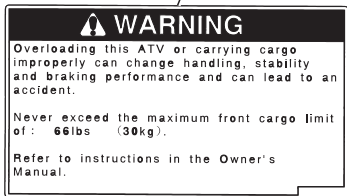

(TRX420FPM)

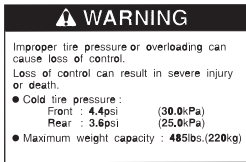



# Safety Labels

(Except TRX420TM)

**BRAKING INFORMATION**

With four-wheel drive, operating any brake control causes braking at both the front and rear wheels. For detailed braking information, refer to the Owner's Manual.

**WARNING**

**UNDER 16**

Operating this ATV if you are under the age of 16 increases your chance of severe injury or death. NEVER operate this ATV if you are under age 16.

**WARNING**

Overloading this ATV or carrying cargo improperly can change handling, stability and braking performance and can lead to an accident.

Never exceed the maximum rear cargo limit (combined weight on the rear rack and in the storage area) of: 133lbs (60kg).

Refer to instructions in the Owner's Manual.

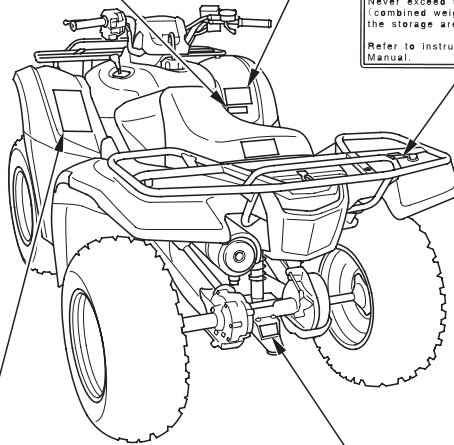

**WARNING**

Improper ATV use can result in SEVERE INJURY or DEATH.

ALWAYS USE APPROVED PUBLIC ROADS. NEVER RIDE ON SIDEWALKS, DRIVEWAYS, OR PAVED AREAS. NEVER RIDE ON HILLS OR SLOPES. NEVER RIDE ON ROUGH TERRAIN OR IN TURNS.

**NEVER operate:**

- without proper training or instruction
- at speeds too fast for your skills or the conditions
- on public roads - a collision can occur with another vehicle
- with a passenger - passengers affect balance and steering and increase risk of losing control

**ALWAYS:**

- use proper riding techniques to avoid vehicle overturns on hills and rough terrain and in turns
- avoid paved surfaces - pavement may seriously affect handling and control

LOCATE AND READ OWNER'S MANUAL. FOLLOW ALL INSTRUCTIONS AND WARNINGS.

**WARNING**

Towing an improperly loaded trailer can cause loss of control.

- Read towing instructions in owner's manual
- Tow weight limit : 850lbs. (385kg)
- Tongue weight : 30lbs. ( 14kg)







# Instruments & Controls

This section shows the location of all indicators and controls you would normally use before or while riding your ATV.

The items listed on this page are described in this section. Instructions for other components are presented in other sections of this manual where they will be most useful.

Operation Component Locations .....	10
Indicators & Displays.....	13
Multi-function Display (TRX420FPM only).....	18
Gear Position Indicator (TRX420FPM only) .....	19
Oil Change Indicator (TRX420FPM only).....	20
Odometer ( TRX420FPM only).....	21
Tripmeter ( TRX420FPM only).....	21
Hourmeter (TRX420FPM only) .....	22
Fuel Gauge .....	23
Controls & Features .....	24
Fuel Valve.....	24
Ignition Switch.....	25
2WD/4WD Select Lever (Except TRX420TM ).....	26
Start Button .....	27
Engine Stop Switch.....	27
Headlight Switch.....	28
Headlight Dimmer Switch.....	28
Throttle Lever .....	29
Reverse Selector Knob.....	30
Front Brake Lever .....	31
Rear Brake Lever/Parking Brake Lever .....	31
Rear Brake Pedal.....	31
Parking Brake.....	32
Flag Pole Bracket .....	33
Trailer Hitch.....	34
PS (Electric Power Steering) (TRX420FPM only).....	35



## Operation Component Locations

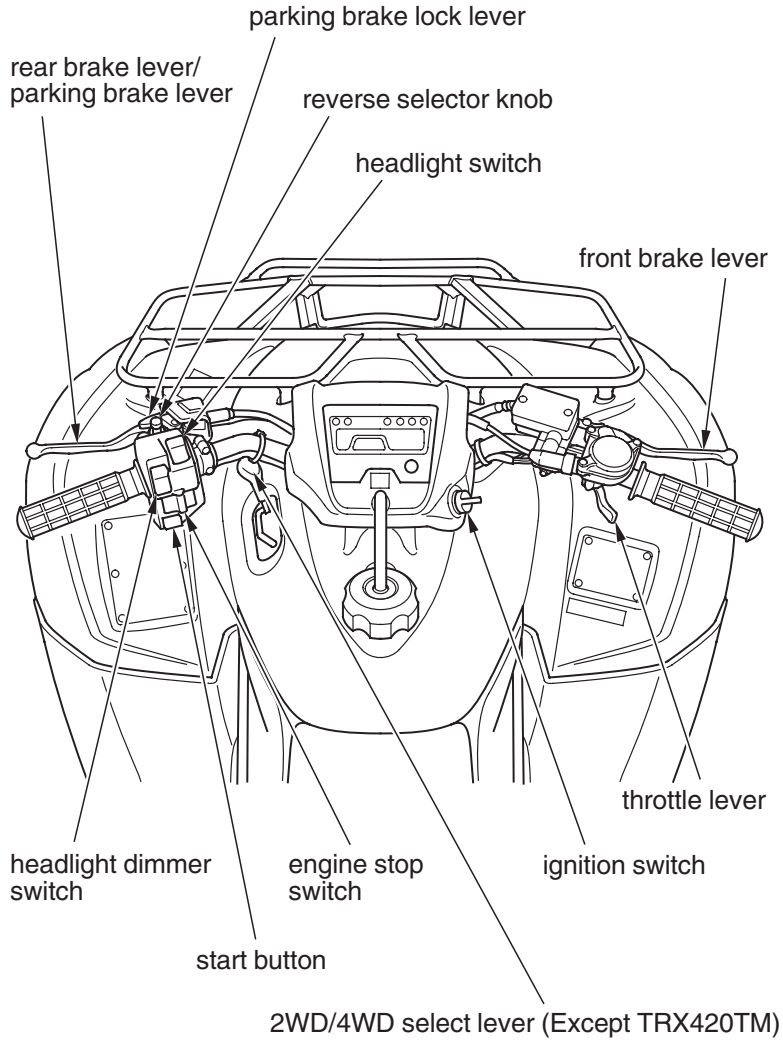

### 10 Instruments & Controls



## Operation Component Locations

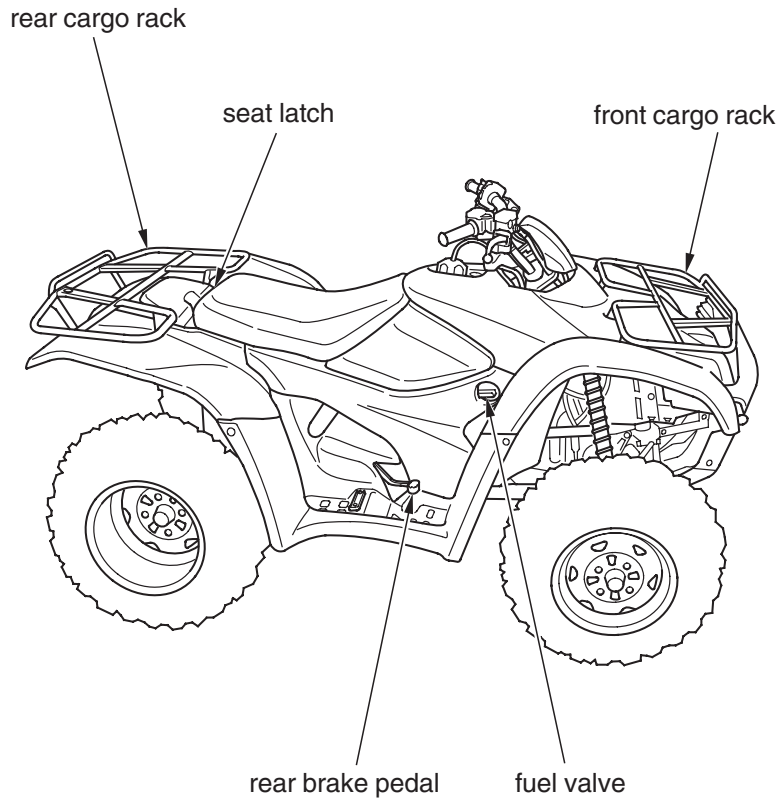



## Operation Component Locations

flag pole bracket

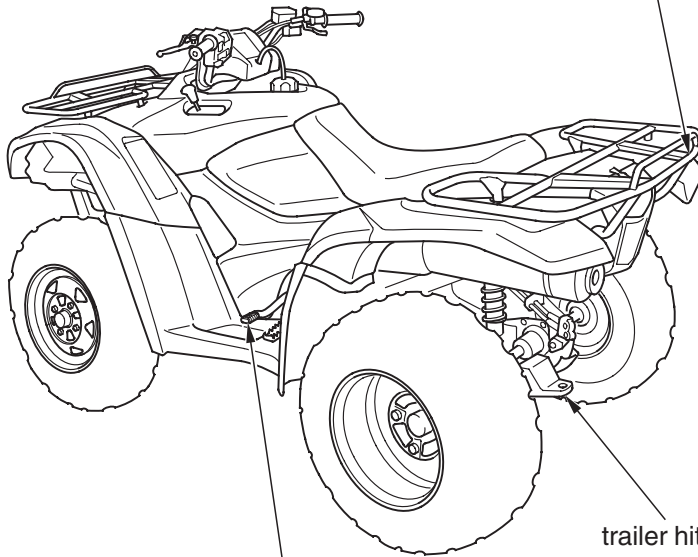

trailer hitch

shift lever

### 12 Instruments & Controls

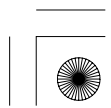
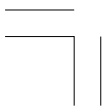



## Indicators & Displays

The indicators and displays on your ATV keep you informed, alert you to possible problems, and make your riding safer and more enjoyable. Refer to the indicators frequently. Their functions are described on the following pages.

(TRX420TM/FM)

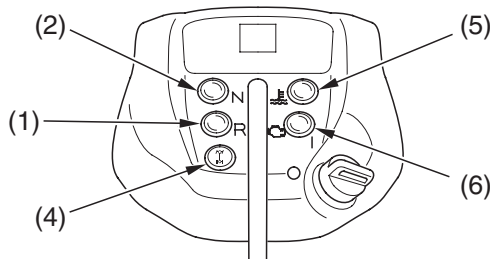

(TRX420FPM)

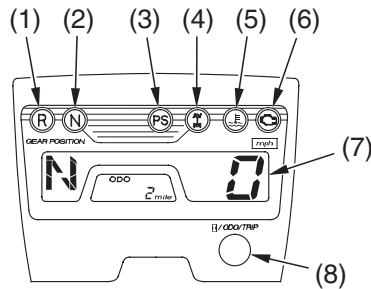

- |  |  |
|--|--|
| (1) reverse indicator  | (6) PGM-FI indicator   |
| (2) neutral indicator  | (7) multi-function display<br>(TRX420FPM only)                         |
| (3) PS (Electric Power Steering)<br>indicator (TRX420FPM only) | (8) hourmeter/odometer/<br>tripmeter select button<br>(TRX420FPM only) |
| (4) 4WD indicator (Except TRX420TM)                            |  |
| (5) high coolant temperature indicator                         |  |



## Indicators & Displays

---

### Lamp Check

The high coolant temperature indicator and PGM-FI indicator come on for a few seconds and then go off when you turn the ignition switch ON ( I ).

### TRX420FPM only:

The PS (Electric Power Steering) indicator comes on when you turn the ignition switch ON ( I ) so you can check that it is working. The indicator remains on until the engine is started.

The indicators are identified in the table on page 16 with the words: *Lamp Check*.

When applicable, the reverse or neutral indicators come on when you turn the ignition switch ON ( I ) and remain on until you shift out of reverse or neutral.



### Except TRX420TM:

When applicable, the 4WD indicator comes on when you turn the ignition switch ON ( I ) and remains on until you shift out of 4WD mode.

### Except TRX420FPM:

If one of these indicators does not come on when it should, have your dealer check for burned-out bulbs or other problems.

### TRX420FPM only:

If one of these indicators does not come on when it should, have your dealer check for problems.

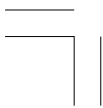



## Indicators & Displays

TRX420FPM only:

### Display Check

When the ignition switch is turned ON ( I ), the multi-function display (1) will temporarily show all the modes and digital segments so you can make sure the liquid crystal display is functioning properly.

The displays are identified in the table on page 17 with the words: *Display Check*.

If any part of these displays does not come on when it should, have your dealer check for problems.

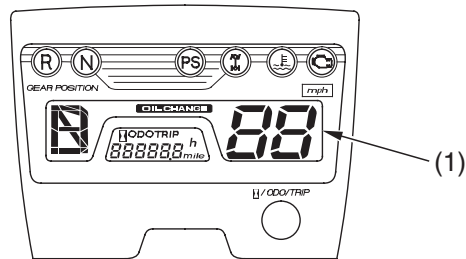

(1) multi-function display

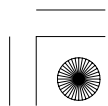
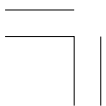



## Indicators & Displays

1	Reverse indicator	Lights when the transmission is in reverse. <i>Lamp Check.</i>
2	Neutral indicator	Lights when the transmission is in neutral. <i>Lamp Check.</i>
3	PS (Electric Power Steering) indicator (TRX420FPM only)	Lights when there is an abnormality in the PS (Electric Power Steering) system. See page 35 . <i>Lamp Check.</i>
4	4WD indicator (Except TRX420TM)	Lights when the 4WD drive mode engages. <i>Lamp Check.</i>
5	High coolant temperature indicator	Lights when coolant temperature is high enough to adversely affect the service life of the engine. If the high coolant temperature indicator comes on while you are riding, immediately bring the vehicle to a stop, turn the engine off and let it cool. See page 195. <i>Lamp Check.</i>
6	PGM-FI indicator	Lights when there is any abnormality in the PGM-FI (Programmed Fuel Injection) system. Should also light for a few seconds and then go off when the ignition switch is turned ON ( I ). If the indicator comes on at any other time, reduce speed and take your vehicle to your dealer as soon as possible. <i>Lamp Check.</i>







## Indicators & Displays

<b>(TRX420FPM only)</b>		
7	Multi-function display	The display includes the following functions. <i>Display Check</i> .
	Gear position indicator	Shows the gear position (page 19).
	Oil change indicator	Lights when specified maintenance interval for engine oil change is reached (page 20).
	Speedometer	Shows riding speed.
	Odometer	Shows accumulated mileage (page 21).
	Tripmeter	Shows mileage per trip (page 21).
	Hourmeter	Shows hours and tenths of hours of engine operation (page 22).
8	Hourmeter/odometer/tripmeter select button	Selects display of the odometer or tripmeter or hourmeter. Resets the tripmeter to zero (0) (page 21). This button also used to reset the oil change indicator (page 20).





## Indicators & Displays

### Multi-function Display (TRX420FPM only)

The multi-function display (1) includes the following functions:

- Gear position indicator
- Oil change indicator
- Speedometer
- Odometer
- Tripmeter
- Hourmeter

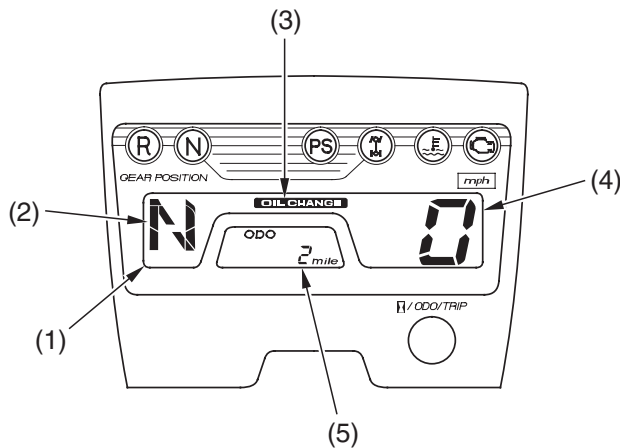

- (1) multi-function display
- (2) gear position indicator
- (3) oil change indicator
- (4) speedometer
- (5) odometer/tripmeter/hourmeter





# Indicators & Displays

## Gear Position Indicator (TRX420FPM only)

The gear position indicator (1) shows the gear position when the ignition switch is in the ON ( I ) position.

The indicator displays: N for neutral, R for reverse, and 1 – 5 for the five forward gears.

“—” will be displayed on the gear position indicator when the transmission is not shifted into gear properly. Before riding, check that the gear position is properly displayed on the gear position indicator.

If the gear position indicator shows “—” or blinks, turn the ignition switch to the OFF ( O ) position, and then turn it back to the ON ( I ) position again.

If the gear position indicator shows “—”, rock the vehicle back and forth and make sure the gear position indicator is displayed properly and then if the gear position indicator still shows “—” or blinks, see your dealer.

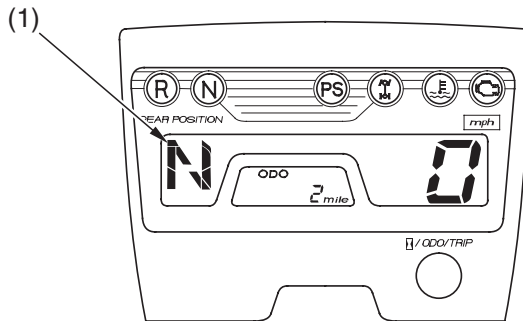

(1) gear position indicator



## Indicators & Displays

### Oil Change Indicator (TRX420FPM only)

The oil change indicator (1) appears in the display when the mileage or operating hours on your ATV approaches the oil change interval specified on the maintenance schedule.

Reset the indicator after each oil change.

To reset the indicator, press and hold the hourmeter/odometer/tripmeter select button (2) and turn the ignition switch (3) to ON (I) for more than 5 seconds. The indicator message will disappear.

If the oil is changed before the oil change indicator appears, be sure to reset the oil change indicator after changing the oil, except after the initial oil change.

Press and hold the hourmeter/odometer/tripmeter select button and turn the ignition switch to ON (I) for more than 5 seconds. When the indicator lights for 2 seconds and then turns off, the oil change indicator is reset.

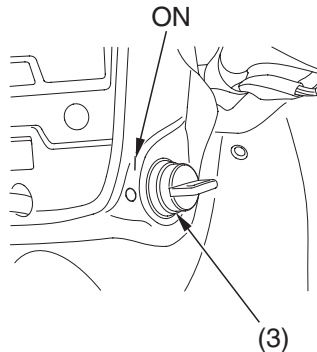
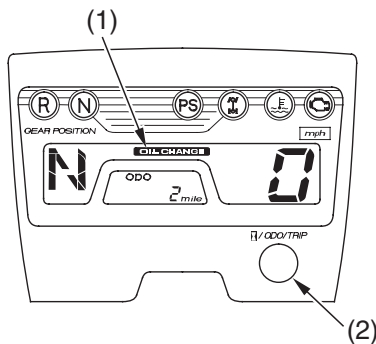

- (1) oil change indicator
- (2) hourmeter/odometer/  
tripmeter select button
- (3) ignition switch

I ON

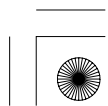



## Indicators & Displays

### Odometer (TRX420FPM only)

When selected, the odometer (1) registers total distance traveled in miles while the ignition is ON (1). To change the display from tripmeter or hourmeter to odometer, press and release the hourmeter/odometer/tripmeter select button (2).

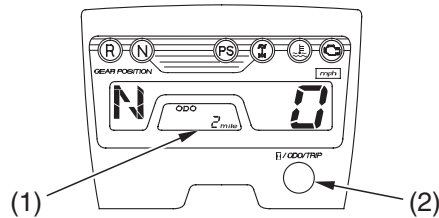

(1) odometer (2) hourmeter/odometer/tripmeter select button

### Tripmeter (TRX420FPM only)

When selected, the tripmeter (1) shows mileage per trip while the ignition is ON (1). To change the display from odometer or hourmeter to tripmeter, press and release the hourmeter/odometer/tripmeter select button (2). To reset the tripmeter to zero, press the hourmeter/odometer/tripmeter select button and hold it in for at least 2 seconds.

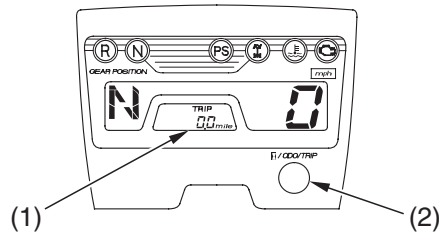

(1) tripmeter (2) hourmeter/odometer/tripmeter select button





## Indicators & Displays

### Hourmeter (TRX420FPM only)

When selected, the hourmeter (1) shows accumulated hours while the ignition is ON (1). The hourmeter provides accurate service period information for initial and regular maintenance. To change the display from odometer or tripmeter to hourmeter, press and release the hourmeter/odometer/tripmeter select button (2). The hourmeter mark (3) will appear.

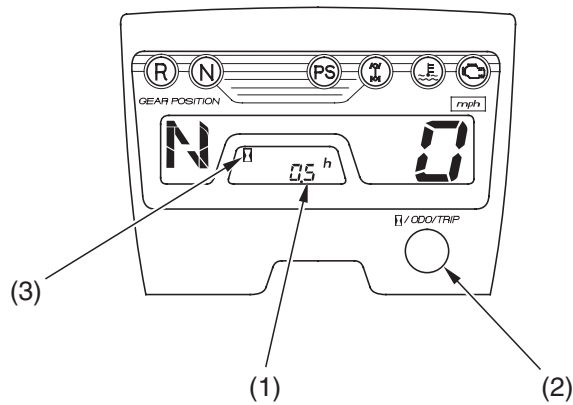

- (1) hourmeter
- (2) hourmeter/odometer/  
tripmeter select button
- (3) hourmeter mark

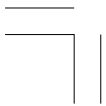



## Indicators & Displays

### Fuel Gauge

The fuel gauge (1) shows the approximate fuel supply available. At F (Full), the fuel tank capacity including reserve is:

**3.51 US gal (13.3 ℓ)**

When the gauge needle (2) enters the red band (3), fuel will be low and you should refill the tank as soon as possible. The amount of fuel left in the tank when the needle enters the red band is approximately:

**0.77 US gal (2.9 ℓ)**

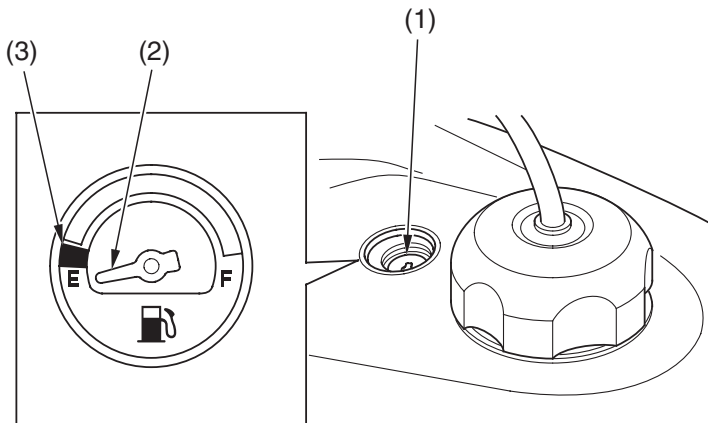

(1) fuel gauge  
(2) gauge needle

(3) red band

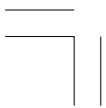



## Controls & Features

### Fuel Valve

#### RIGHT SIDE

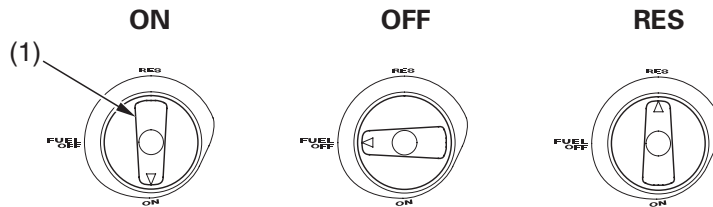

(1) fuel valve

The manual fuel valve (1) is located on the right side under the fuel tank.

The three-way fuel valve is used to control the flow of fuel from the fuel tank to the fuel pump unit.

ON—normal position for riding.

OFF—for parking, storing, or transportation.

RES—for extra fuel to get to a gas supply for refueling.

#### Reserve Fuel

Remember to check that the fuel valve is in the ON position each time you refuel. If the fuel valve is left in the RES position, you may run out of fuel with no reserve.

For complete information about fueling your ATV, see page 102.

## 24 Instruments & Controls

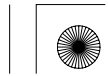





## Controls & Features

### Ignition Switch

The ignition switch (1) is used for starting and stopping the engine (page 60). Insert the key and turn it to the right for the ON ( I ) position.

TRX420FPM only:

The ignition switch is also used to reset the oil change indicator (page 20 ).

Key Position	Function
ON ( I )	Electrical circuits on.
OFF ( O )	No electrical circuits function.

CENTER OF HANDLEBAR

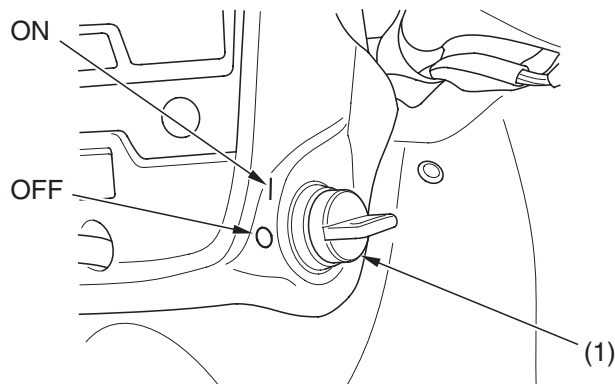

(1) ignition switch

I ON  
 O OFF



## Controls & Features

### 2WD/4WD Select Lever (Except TRX420TM )

Your ATV is equipped with a 2WD/4WD select lever (1), which permits a choice between the “2WD” and “4WD” drive modes. Select a drive mode that’s suitable for your riding.

Keep both hands on the handlebar while machine is in motion and come to a complete stop before using the 2WD/4WD select lever.

The 2WD/4WD select lever is located on the left side of the fuel tank. To select the drive mode, shift the 2WD/4WD select lever to the desired position.

After using the 2WD/4WD select lever, the mode may not mechanically engage until forward motion begins.

To check your present drive mode, look at the 4WD indicator (2).

2WD mode : the 4WD indicator goes off when the 2WD mode engages.

4WD mode : the 4WD indicator goes on when the 4WD mode engages.

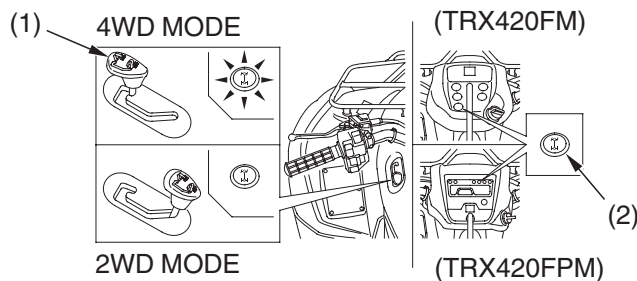

(1) 2WD/4WD select lever

(2) 4WD indicator

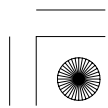



## Controls & Features

### Start Button



#### LEFT HANDLEBAR

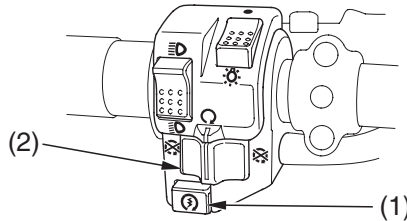

- (1) start button  
(2) engine stop switch



-  START  
 OFF  
 RUN



The start button (1) is used for starting the engine. Pushing the button in starts the engine. See *Starting Procedure*, page 61 .

When the start button is pushed, the starter motor will crank the engine. The starter motor will not operate if the engine stop switch is in the OFF (  ) position when the start button is pushed.

### Engine Stop Switch



The engine stop switch (2) is used to stop the engine in an emergency. To operate, slide the switch to the OFF (  ) position. The switch must be in the RUN (  ) position to start the engine, and it should normally remain in the RUN (  ) position even when the engine is OFF.

If your ATV is stopped with the ignition switch ON (  ) and the engine stop switch OFF (  ), the battery will discharge. Turn the ignition switch OFF (  ) to prevent battery discharge.



# Controls & Features



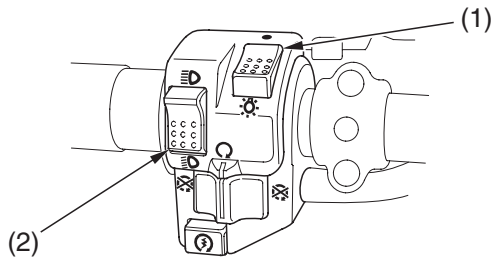

## Headlight Switch





LEFT HANDLEBAR





(1) headlight switch

(2) headlight dimmer switch

-  ON
-  OFF
-  HI
-  LO

The headlight switch (1) is used to turn the headlight ON (  ) or OFF (  ). To operate, turn the switch to ON (  ) or OFF (  ).

## Headlight Dimmer Switch

The headlight dimmer switch (2) is used to change between the high and low beams of the headlight. To operate, turn the switch to HI (  ) for high beam, LO (  ) for low beam.

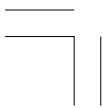



## Controls & Features

### Throttle Lever

#### RIGHT HANDLEBAR

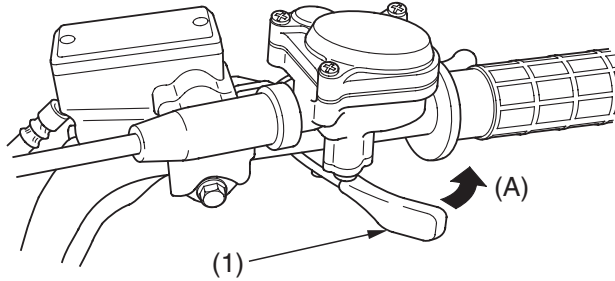

(1) throttle lever

(A) to open the throttle

The throttle controls engine rpm (speed). To increase engine rpm, press the throttle lever (1) with your thumb. To reduce engine rpm, release pressure on the throttle lever. The throttle will automatically return to the closed position (engine idle) when you remove your thumb.



## Controls & Features

---

### Reverse Selector Knob

The reverse selector knob (1), located on the rear brake lever/parking brake lever (2), is used to shift into reverse. To operate, with your ATV stopped and the transmission in neutral (TRX420TM , TRX420FM : make sure the neutral indicator lights, TRX420FPM: make sure the gear position indicator shows “N”), push in the knob, squeeze the rear brake lever/parking brake lever, then depress the shift lever. See *Riding in Reverse*, page 67.

### LEFT HANDLEBAR

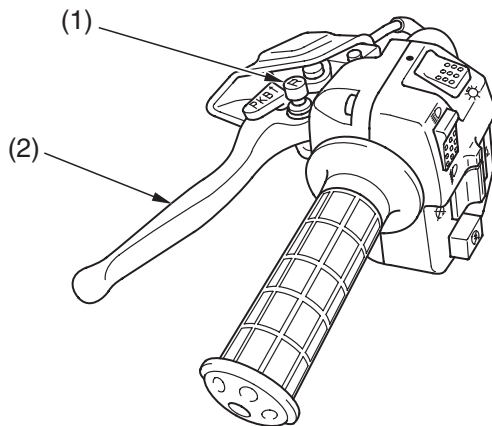

- (1) reverse selector knob
- (2) rear brake lever/parking brake lever

### 30 Instruments & Controls

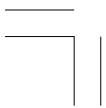



## Controls & Features

### Front Brake Lever

The front brake lever is used to slow or stop your ATV. To operate, pull the lever. For information on braking techniques, see page 69 .

### Rear Brake Lever/Parking Brake Lever

The rear brake lever/parking brake lever is used to slow or stop your ATV. To operate, pull the lever. For information on braking techniques, see page 69 .

### Rear Brake Pedal

The rear brake pedal is used to slow or stop your ATV. To operate, depress the pedal. For information on braking techniques, see page 69 .

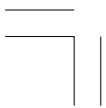



## Controls & Features

---

### Parking Brake

#### LEFT HANDLEBAR

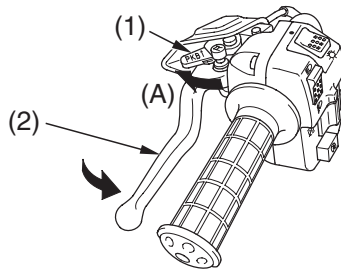

(1) lock lever

(A) to lock

(2) rear brake lever/parking brake lever

The lock lever (1) on the rear brake lever/parking brake lever (2) allows it to be used as a parking brake. To operate, first squeeze the rear brake lever/parking brake lever using your left hand and then lock it with the lock lever using your right hand. See *Parking* page 83 .

The brake lights are activated by applying the parking brake. When using the parking brake, be sure to turn the ignition switch OFF (  $\bigcirc$  ) to avoid discharging the battery.

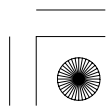
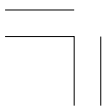





## Controls & Features

### Flag Pole Bracket

RIGHT REAR

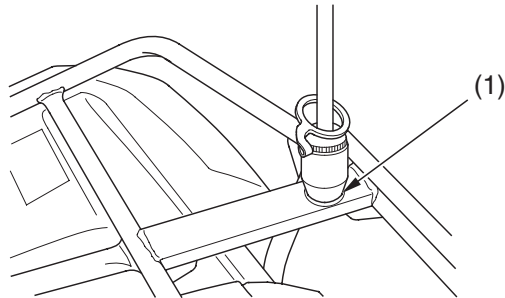

(1) flag pole bracket

Flag poles are optional equipment available from your dealer. To mount a pole in the bracket (1), follow the instructions that come with the flag pole kit.

Flag poles are required in some riding areas. Check local regulations before riding.



## Controls & Features

### Trailer Hitch

REAR

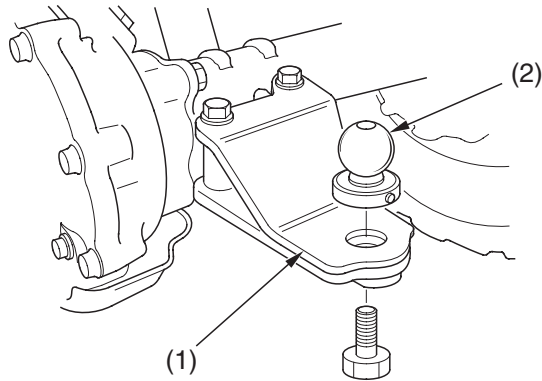

(1) trailer hitch

(2) ball

The trailer hitch (1) is located on the rear axle housing. To use the hitch, you'll need a proper size ball (2) as specified by the trailer manufacturer.

To attach the ball and properly hook up a trailer, follow the trailer manufacturer's instructions. For load limits and operational guidelines, see page 48 .

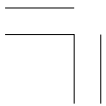



## Controls & Features

### PS (Electric Power Steering) (TRX420FPM only)

This ATV is equipped with an electronically controlled, electric-power-assisted steering system.

While the engine is running, the PS (Electric Power Steering) system provides power from the electric motor, which helps you to turn the ATV's handlebar more easily.

The PS system on this ATV utilizes an overheat protection feature to prevent damage to system components. In certain extended, repetitive high-load situations, the system will reduce or even disable power steering assist. The steering will perform as a normal non-PS system during this brief period. After cooling down, it will then return to normal PS operation.

The PS indicator should light when the ignition switch is turned ON ( I ) and remain on until the engine is started.

The PS indicator also lights when there is any abnormality in the PS system. If this occurs, the electric power assist for turning will not be available, but the manual steering system will perform as usual.

If the PS indicator lights at any time while riding, reduce speed and take your ATV to your dealer as soon as possible. Continuing to ride with a PS system problem can cause system damage.

Do not modify your Electric Power Steering system. In case of a malfunction, take your ATV to your dealer.



11/05/09 13:06:27 31HP4650 0045

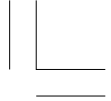

### 36 Instruments & Controls

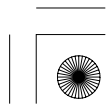



## Before Riding

Before each ride, you need to make sure you and your Honda are both ready to ride. To help get you prepared, this section discusses how to evaluate your riding readiness, what items you should check on your ATV, and adjustments to make for your comfort, convenience, or safety. This section also includes important information about loading.

Are You Ready to Ride? .....	38
Protective Apparel.....	38
Rider Training .....	40
Age Recommendation .....	41
No Passengers .....	41
No Alcohol or Drugs.....	42
Is Your ATV Ready to Ride?.....	43
Pre-ride Inspection .....	43
Load Limits & Guidelines.....	47
Loading .....	47
Load Limits .....	48
Loading Guidelines .....	49
Accessories & Modifications .....	50
Accessories.....	50
Modifications .....	51





## Are You Ready to Ride?

---

Before you ride your ATV for the first time, we urge you to:

- Read this owner's manual and the labels on your ATV carefully.
- Make sure you understand all the safety messages.
- Know how to operate all the controls.

Before each ride, be sure:

- You feel well and are in good physical and mental condition.
- You are wearing an approved motorcycle helmet (with chin strap tightened securely), eye protection, and other protective clothing.
- You don't have any alcohol or drugs in your system.

### Protective Apparel

For your safety, we strongly recommend that you always wear an approved motorcycle helmet, eye protection, boots, gloves, long pants, and a long-sleeved shirt or jacket whenever you ride.

Although complete protection is not possible, wearing proper gear can reduce the chance of injury when you ride.

Following are suggestions to help you choose the proper gear.

#### Helmet and Eye Protection

Your helmet is your most important piece of riding gear because it offers the best protection against head injuries. A helmet should fit your head comfortably and securely.

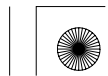



## Are You Ready to Ride?

An open-face helmet offers some protection, but a full-face helmet offers more. Regardless of the style, look for a DOT (Department of Transportation) sticker on any helmet you buy. Always wear a face shield or goggles to protect your eyes and help your vision.

### **WARNING**

Operating this ATV without wearing an approved motorcycle helmet, eye protection, and protective clothing could increase your chances of severe injury or death in the event of an accident.

Always wear an approved motorcycle helmet that fits properly and wear eye protection (goggles or face shield), gloves, boots, long-sleeved shirt or jacket and long pants.



### Additional Riding Gear

In addition to a helmet and eye protection, we also recommend:

- Sturdy off-road motorcycle boots to help protect your feet, ankles, and lower legs.
- Off-road motorcycle gloves to help protect your hands.
- Riding pants with knee and hip pads, a riding jersey with padded elbows, and a chest/shoulder protector.

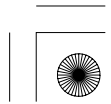



## Are You Ready to Ride?

---

### Rider Training

Developing your riding skills is an on-going process. Even if you have ridden other ATVs, take time to become familiar with how this ATV works and handles. Practice riding the ATV in a safe area to build your skills. Do not ride in rough terrain until you get accustomed to the ATV's controls, and feel comfortable with its size and weight.

We urge all riders to take a ATV operator course approved by the ATV Safety Institute (ASI). For information about the ASI training course nearest you, call the national toll-free number; (800) 887-2887.

Other riding tips can be found in the *Tips & Practice Guide for the ATV Rider* booklet that came with your ATV.

### **WARNING**

Operating this ATV without proper instruction could increase your risk of an accident which could lead to serious injury or death.

Beginning and inexperienced operators should complete the certified training course offered by Honda. They should then regularly practice the skills learned in the course and the operating techniques described in the owner's manual.





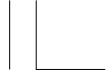

## Are You Ready to Ride?

### Age Recommendation

The minimum recommended age for this ATV model is 16. For safety, never let children under 16 years old operate this vehicle.

#### **WARNING**

A child using an ATV that is not recommended for their age could lose vehicle control while riding, resulting in severe injury or death.

A child under 16 should never operate an ATV with engine size greater than 90cc.



### No Passengers

This ATV is designed as an operator-only vehicle. The long seat is designed to allow the rider to change body position, not for carrying a passenger. Never let a passenger ride on the seat or on the front or rear cargo racks.



#### **WARNING**

Carrying a passenger on this ATV greatly reduces your ability to balance and control this ATV and could cause a crash and you or your passenger could be injured or killed.

Never carry a passenger on this ATV.

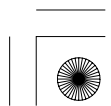
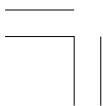



## Are You Ready to Ride?

---

### No Alcohol or Drugs

Alcohol, drugs and ATVs don't mix. Even a small amount of alcohol can impair your ability to operate an ATV safely. Likewise, drugs – even if prescribed by a physician – can be dangerous while operating an ATV. Consult your doctor to be sure it is safe to operate a vehicle after taking medication.

#### **WARNING**

Operating this ATV after consuming alcohol or drugs can seriously affect your judgement, cause you to react more slowly, affect your balance and perception, and result in serious injury or death.

Never consume alcohol or drugs before or while operating this ATV.





## Is Your ATV Ready to Ride?

Before each ride, it's important to inspect your ATV and make sure any problem you find is corrected. A pre-ride inspection is a must, not only for safety, but because having a breakdown, or even a flat tire, can be a major inconvenience.

If your ATV has overturned or been involved in a collision, do not ride the vehicle until it has been inspected by your dealer. There may be damage or other problems you cannot see.

### **WARNING**

Improperly maintaining this ATV or failing to correct a problem before riding can cause a crash in which you can be seriously hurt or killed.

Always perform a pre-ride inspection before every ride and correct any problems.

### Pre-ride Inspection

Check the following items before you get on the ATV:

*Engine Oil*

Check the level and add oil if needed (page 108 ).  
Check for leaks.

*Radiator  
Coolant*

Check the coolant level and add coolant if needed (page 120).  
Check for leaks.

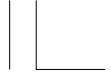

## Is Your ATV Ready to Ride?

---

<i>Fuel</i>	Check the level and add fuel (page 103) if needed. Also make sure the fuel fill cap is securely fastened. Check for leaks.
<i>Tires</i>	Use a gauge to check the air pressure. Adjust if needed. Also look for signs of damage or excessive wear (page 157 ).
<i>Drivetrain Boots</i>	Check for damage (pages 163 , 164 ).
<i>Guards</i>	Check for damage or looseness (pages 161 , 162 ).
<i>Nuts &amp; Bolts</i>	Check the wheels to see that the axle nuts are tightened. Use a wrench to make sure all accessible nuts, bolts, and fasteners are tight.
<i>Underbody &amp; Exhaust System</i>	Check for, and remove, any dirt, vegetation or other debris that could be a fire hazard or interfere with the proper operation of the vehicle.
<i>Air Cleaner Housing Drain Tube</i>	Check for deposits in the drain tube. If necessary, clean the tube (page 130 ) and check the air cleaner housing.
<i>Leaks, Loose Parts</i>	Walk around your ATV and look for anything that appears unusual, such as a leak or loose cable.

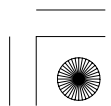
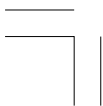



## Is Your ATV Ready to Ride?

---

*Cable* Check the cable housings for wear. Check the fittings for looseness. Replace or tighten as needed.

*Lights* Make sure the headlight, brake light and taillight are working properly.

If you are carrying cargo, also check the following:

*Loading Limits* Make sure you do not exceed the load limits (page 48 ).

*Cargo* Check that all cargo is secure.

Check these items after you get on the ATV:



*Throttle* Check the freeplay and adjust if needed. Press the throttle to make sure it moves smoothly without sticking, and snaps shut automatically when it is released, in all steering positions (page 131 ).



*Brakes* Squeeze the front and rear brake levers and step on the rear brake pedal to check that the controls operate normally. Check for proper freeplay (pages 147 , 149 ). Make sure there is no brake fluid leakage.

*Reverse Assist Lever* Check the freeplay and adjust if needed (page 134 ). Make sure the lever operates smoothly without sticking.





## Is Your ATV Ready to Ride?

---

*Headlight and  
Headlight Dimmer  
Switch*

Check for proper function (page 28 ).

*Engine Stop Switch*

Check for proper function (page 27 ).

*Steering*

Check that the wheels turn properly as you steer the handlebar. Move the handlebar right and left and check that there is no excessive backlash.

Remember, be sure to take care of any problem you find, or have your dealer correct it before you ride.





## Load Limits & Guidelines

Your Honda was designed as a rider-only ATV. It was not designed to carry a passenger. It can carry cargo on the cargo racks, however, carrying cargo anywhere else or carrying a passenger could interfere with your balance and control of the ATV.

In addition, exceeding the weight limits or carrying an unbalanced load can seriously affect your ATV's handling, braking and stability. Adding accessories or making modifications that change this ATV's design and performance can also make it unsafe. Also, the weight of any accessories will reduce the maximum load the ATV can carry.

More specific information on load limits, accessories, and modifications follows.

### Loading

How much weight you put on your ATV, and how you load it, are important to your safety. If you decide to carry cargo, you should be aware of the following information.

#### **⚠ WARNING**

Overloading, improper loading, or carrying a passenger can cause a crash and you can be seriously hurt or killed.

Follow all load limits and other loading guidelines in this manual.



## Load Limits & Guidelines

### Load Limits

Following are the load limits for your ATV:

There are limits to how much weight can be carried on your ATV and be pulled in a trailer.

The following load limits apply to standard equipment only. Modifying your ATV, using non-standard equipment, or riding on terrain that is not flat and smooth could further reduce these limits.

maximum weight capacity      485 lb (220 kg)  
(includes the weight of the rider,  
all cargo, and accessories.)

front cargo rack weight limit      = 66 lb (30 kg)  
rear cargo rack weight limit      = 133 lb (60 kg)  
tow weight limit                      = 850 lb (385 kg)

(Combined weight of the trailer  
and all cargo in the trailer)

tongue weight                          = 30 lb (14 kg)  
(Weight on the trailer tongue)      recommended  
tongue and rear cargo weight      = 133 lb (60 kg) maximum  
(Combined weight on the trailer  
tongue and on the rear cargo  
rack)

Tongue weight can be measured with an ordinary bathroom scale. Place the scale under the tongue, using either a tongue jack or other support to keep the trailer level.

The weight of added accessories will reduce the maximum cargo weight you can carry.

### 48 Before Riding

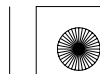





## Load Limits & Guidelines

### Loading Guidelines

Carrying cargo or pulling a trailer will affect how your ATV handles and greatly reduce its ability in accelerating, braking and making turns and other maneuvers.

Be sure to observe the weight limits and follow these guidelines:

- Check that the tires are properly inflated.
- Do not place cargo anywhere on the ATV other than on the front and rear racks. Otherwise, operating stability may be adversely affected.
- Never ride with a passenger on the front or rear cargo racks. The ATV is not designed to carry a passenger.
- Use the trailer hitch to tow another vehicle or trailer. Do not tow by tying a rope or cable to the rear rack.
- Load cargo on the rear rack as far forward as possible. Make sure cargo on the front rack does not interfere with handlebar movement.
- Do not allow cargo to extend beyond the edges of either the front or rear racks.
- Make sure all cargo is secured before riding.
- Balance cargo weight evenly on both sides.
- Never exceed the maximum weight limit.
- When towing a trailer, take care to maintain balance and stability. Distribute cargo between the front and rear of the trailer to obtain the recommended tongue weight.
- Allow extra room for starting, stopping and turning whenever you carry cargo or pull a trailer.
- Avoid riding on steep slopes when carrying cargo or pulling a trailer.
- Never cross a slope when towing a trailer.



## Accessories & Modifications

---

Modifying your ATV or using non-Honda accessories can make your ATV unsafe.

Before you consider making any modifications or adding an accessory, be sure to read the following information.

### **WARNING**

Improper accessories or modifications can cause a crash in which you can be seriously hurt or killed.

Follow all instructions in this owner's manual regarding accessories and modifications.



### Accessories



We strongly recommend that you use only Honda Genuine Accessories that have been specifically designed and tested for your ATV. Because Honda cannot test all other accessories, you must be personally responsible for proper selection, installation, and use of non-Honda accessories.

Check with your dealer for assistance and always follow these guidelines:

- Make sure the accessory does not obscure any lights, reduce ground clearance, limit suspension travel or steering travel, or interfere with operating any controls.
- Make sure the accessory does not interfere with your ability to shift body position on the seat or operate hand and foot controls.
- Do not add any electrical equipment that will exceed the vehicle's electrical system capacity (pages 213 , 214 ). A blown fuse can cause a loss of lights or engine power (page 197 ).

### **50** Before Riding

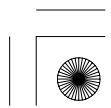
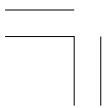



## Accessories & Modifications

### Modifications

We strongly advise you not to remove any original equipment or modify your ATV in any way that would change its design or operation. Such changes could seriously impair your ATV's handling, stability, and braking, making it unsafe to ride.

We also advise you not to make any modifications or remove any equipment (such as the USDA qualified spark arrester or emission control system components) that would make your ATV illegal in your area.

Removing or modifying your lights, exhaust system, emission control system, or other equipment can also make your ATV illegal.

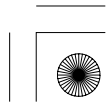



11/05/09 13:08:34 31HP4650 0061



**52 Before Riding**

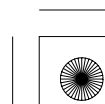
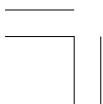



# Basic Operation & Riding

This section gives basic riding instructions, including how to start and stop your engine, and how to use the throttle and brakes. It also provides important information on riding with cargo.

To protect your new engine and enjoy optimum performance and service life, refer to Break-in Guidelines (page 215).

Safe Riding Precautions .....	55
Off-road Use Only .....	55
Keep Hands and Feet on Controls.....	56
Control Speed.....	57
Use Care on Unfamiliar or Rough Terrain.....	58
Do Not Perform Stunts.....	59
Starting & Stopping the Engine .....	60
Preparation .....	60
Starting Procedure.....	61
Flooded Engine .....	62
Bank Angle Sensor Ignition Cut-off System .....	62
Stalled Engine .....	63
How to Stop the Engine .....	64
Shifting Gears .....	65
Riding in Reverse.....	67

(cont'd)



# Basic Operation & Riding

---

Braking.....	69
Riding Your ATV .....	71
Making Turns.....	71
Skidding or Sliding .....	73
Riding Up Hills .....	74
Riding Down Hills .....	78
Crossing or Turning on Hills or Slopes.....	79
Riding Over Obstacles .....	81
Riding Through Water .....	82
Parking .....	83





## Safe Riding Precautions

Before riding your ATV for the first time, please review the *ATV Safety* section beginning on page 1, and the *Before Riding* section beginning on page 37.

Even if you have ridden other ATVs, take time to become familiar with how this ATV works and handles. Practice in a safe area until you build your skills and get accustomed to the ATV's size and weight.

### Off-road Use Only

Your ATV and its tires are designed and manufactured for off-road use only, not for pavement. Riding on pavement can affect handling and control. You should not ride your ATV on pavement.

#### **WARNING**

Operating this ATV on paved surfaces may seriously affect handling and control of the ATV, and may cause the vehicle to go out of control.

Never operate the ATV on any paved surfaces, including sidewalks, driveways, parking lots and streets.

When riding off-road, also remember to always obey local off-road riding laws and regulations. Obtain permission to ride on private property. Avoid posted areas and obey "no trespassing" signs.



## Safe Riding Precautions

---

You should never ride your ATV on public streets, roads or highways, even if they are not paved. Drivers of street vehicles may have difficulty seeing and avoiding you, which could lead to a collision. In many states it is illegal to operate ATVs on public streets, roads and highways.

### **WARNING**

Operating this ATV on public streets, roads or highways could cause you to collide with another vehicle.

Never operate this ATV on any public street, road or highway, even a dirt or gravel one.



### **Keep Hands and Feet on Controls**



Always keep both hands on the handlebars and both feet on the footpegs when riding your ATV. This is important to maintain your balance and to control the vehicle. Removing even one hand from the handlebars or one foot from the footpegs can reduce your ability to control the ATV or could cause you to lose your balance and fall off the ATV.

### **WARNING**

Removing hands from handlebars or feet from footpegs during operation can reduce your ability to control the ATV or could cause you to lose your balance and fall off of the ATV.

Always keep both hands on the handlebars and both feet on the footpegs of your ATV during operation.

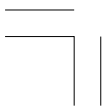



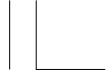

## Safe Riding Precautions

### Control Speed

Riding at excessive speed increases the chance of a crash. In choosing a proper speed, you need to consider the capability of your vehicle, the terrain, visibility and other operating conditions, plus your own skills and experience.

#### **WARNING**

Operating this ATV at excessive speeds increases your chances of losing control of the ATV, which can result in an accident.

Always go at a speed that is proper for your vehicle, the terrain, visibility and other operating conditions, and your experience.

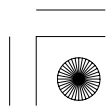



## Safe Riding Precautions

---

### Use Care on Unfamiliar or Rough Terrain

Before riding in a new area, always check the terrain thoroughly. Don't ride fast on unfamiliar terrain or when visibility is limited. (It's sometimes difficult to see obstructions like hidden rocks, bumps, or holes in time to react.)

#### **WARNING**

Failure to use extra care when operating this ATV on unfamiliar terrain could result in the ATV overturning or going out of control.

Go slowly and be extra careful when operating on unfamiliar terrain. Always be alert to changing terrain conditions when operating the ATV.





## Safe Riding Precautions

Never ride past the limit of visibility. Maintain a safe distance between your ATV and other off-road vehicles. Always exercise caution, and use extra care on rough, slippery and loose terrain.

### **WARNING**

Failure to use extra care when operating on excessively rough, slippery or loose terrain could cause loss of traction or vehicle control, which could result in an accident, including an overturn.

Do not operate on excessively rough, slippery or loose terrain until you have learned and practiced the skills necessary to control the ATV on such terrain. Always be especially cautious on these kinds of terrain.



### **Do Not Perform Stunts**

You should always operate your ATV in a safe and reasonable manner. When riding, always keep all four wheels on the ground.

### **WARNING**

Attempting wheelies, jumps, and other stunts increases the chance of an accident, including an overturn.

Never attempt stunts, such as wheelies or jumps. Don't try to show off.

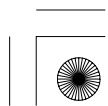
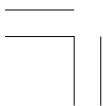



## Starting & Stopping the Engine

Always follow the proper starting procedure described below.

For your safety, avoid starting or operating the engine in an enclosed area such as a garage. Your ATV's exhaust contains poisonous carbon monoxide gas which can collect rapidly in an enclosed area and cause illness or death.

### Preparation

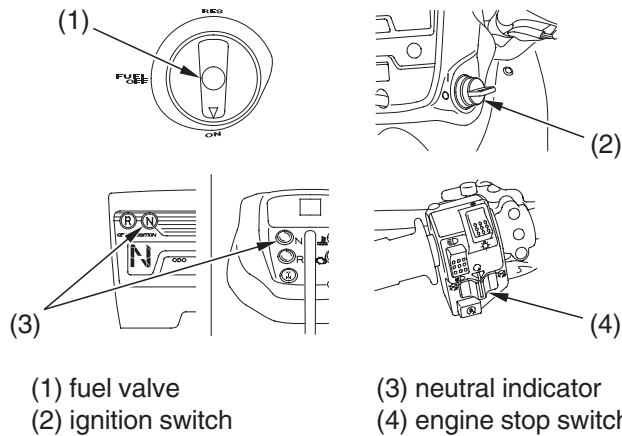

1. Before starting, select a level surface and lock the parking brake (page 32).
2. Turn the fuel valve (1) and ignition switch (2) to ON ( | ).

Confirm the following:

- The transmission is in neutral, and the neutral indicator (3) is ON.
- The engine stop switch (4) is set to RUN ( ○ ).

## 60 Basic Operation & Riding

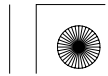



# Starting & Stopping the Engine

## Starting Procedure

This vehicle has a fuel-injected engine with an automatic choke. Follow the procedure indicated below.

### Any Air Temperature

- Press the start button with the throttle completely closed.

The engine will not start if the throttle is fully open (because the electronic control module cuts off the fuel supply).

Snapping the throttle or fast idling for more than 5 minutes may cause exhaust pipe and muffler discolorations.

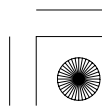
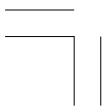



## Starting & Stopping the Engine

### Flooded Engine



If the engine fails to start after repeated attempts, it may be flooded with excess fuel. To clear a flooded engine:

1. Leave the engine stop switch set to RUN (  ).
2. Open the throttle fully.
3. Press the start button for 5 seconds.
4. Follow the normal starting procedure.
5. If the engine starts, then open the throttle slightly if idling is unstable.  
If the engine does not start, wait 10 seconds, then follow steps 1 – 4 again.

If the engine still won't start, refer to *If Your Engine Quits or Won't Start*, page 188.

### Bank Angle Sensor Ignition Cut-off System

Your vehicle's banking (lean angle) sensor system is designed to automatically stop the engine if the vehicle is overturned.

Before restarting the engine, you must turn the ignition switch to the OFF (  ) position and then back to ON (  ). The engine will not restart until you perform this procedure.



## Starting & Stopping the Engine

### Stalled Engine

You can restart the engine while the vehicle is stopped by squeezing the front brake lever and pressing the start button.

Do not press the throttle lever while starting in gear. Your ATV is equipped with a start inhibitor system that will cut off the ignition if the throttle is open while attempting to start in gear.

Once you have started the engine, release the front brake lever, then apply throttle gradually.

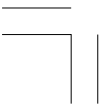





## Starting & Stopping the Engine



---

### How to Stop the Engine

#### Normal Engine Stop

To stop the engine, make sure the transmission is in neutral by checking that the neutral indicator light is on, then turn the ignition switch OFF (  ).

The engine stop switch should normally remain in the RUN (  ) position even when the engine is OFF.

If your ATV is stopped with the engine stop switch OFF (  ) and the ignition switch ON (  ), the battery will discharge.

#### Emergency Engine Stop

To stop the engine in an emergency, use the engine stop switch. To operate, slide the switch to either OFF (  ) position.

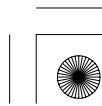





## Shifting Gears

### UPSHIFTING SEQUENCE

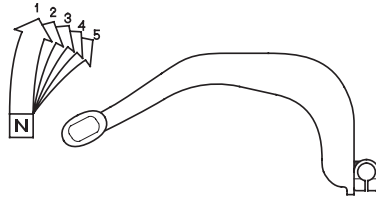

### DOWNSHIFTING SEQUENCE

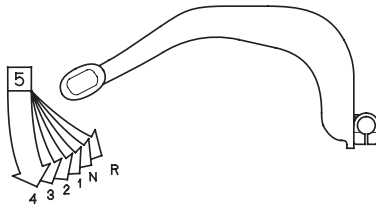

Your ATV has five forward gears: 1, 2, 3, 4, and 5.

The shift lever is located near the left footpeg. One full stroke of the shift lever shifts the transmission to the next higher or lower gear in the shifting sequence. The shift lever automatically returns to the horizontal position when released.

To upshift to a higher gear, put the toe of your boot under the shift lever and raise it one full stroke. To downshift, step on the shift lever and depress it one full stroke.

To select reverse, use the reverse selector knob (page 67).

After starting the engine and letting it warm up, follow these procedures:

1. With the transmission in neutral, release the parking brake, but continue squeezing the rear brake lever.

(cont'd)





## Shifting Gears

---

2. With the throttle closed, raise the shift lever one full stroke to shift into 1st (first) gear.
3. Release the rear brake lever and increase engine speed by gradually opening the throttle.
4. When speed increases, release the throttle and shift to 2nd gear by raising the shift lever one full stroke.
5. Repeat this sequence to progressively upshift to 3rd, 4th and 5th (top) gear.
6. To downshift, reverse this sequence. Remember to close the throttle each time you shift to the next lower gear.

Learning when to shift gears comes with experience. Keep the following tips in mind:

- As a general rule, shift while moving in a straight line.
- Close the throttle completely before shifting. Improper shifting may damage the engine, transmission, and drivetrain.
- Upshift to a higher gear or reduce throttle before engine rpm (speed) gets too high. Learn the relationship between engine sound and the normal shifting points.
- Downshift to a lower gear before you feel the engine laboring (lugging) at low rpm.
- Avoid downshifting to help slow your ATV when engine rpm is high. Downshifting when engine speed is near its allowable maximum may over-rev the engine and possibly cause damage.
- To prevent transmission damage, do not coast or tow the ATV for long distances with the engine off.

### Recommended Shift Points

Ride in the highest gear that lets the engine run and accelerate smoothly. This will give you good fuel economy and effective emissions control.

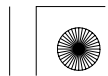



## Riding in Reverse

If you need to ride in reverse, make sure the area behind you is clear and only operate the ATV at low speed.

### **⚠ WARNING**

Improperly operating in reverse could cause you to hit an obstacle or person behind you, resulting in serious injury.

Make sure there are no obstacles or people behind you before selecting reverse gear. When it is safe to proceed, go slowly.

1. Bring the vehicle to a complete stop, then make sure the transmission is in neutral.
2. Be sure there are no obstacles or people in the way.
3. While pushing the reverse selector knob (1) in, squeeze the rear brake lever/parking brake lever (2), then depress the shift lever.

### LEFT HANDLEBAR

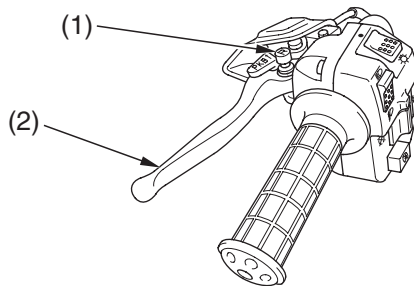

- (1) reverse selector knob
- (2) rear brake lever/parking brake lever

(cont'd)



## Riding in Reverse

---

### NOTICE

*Your ATV may be equipped with a reverse speed limiter, which helps the vehicle to maintain a safe speed while riding in reverse gear.*

4. Release the rear brake lever/parking brake lever.
5. Open the throttle gradually and ride slowly. Do not open the throttle suddenly or make abrupt turns.
6. To stop, close the throttle and gradually apply both the front and rear brakes. Do not abruptly apply the rear brake by itself.
7. To shift out of reverse and into neutral, raise the shift lever one stroke.

### **WARNING**

Applying only the rear brake abruptly when operating in reverse gear could cause the front wheels to lift off the ground and the ATV could overturn backwards.

Carefully apply both the front and rear brakes when stopping in reverse gear.



## Braking

Your ATV is equipped with disc brakes on both front wheels which are hydraulically activated by operating the right brake lever. A single drum brake on the rear axle housing is mechanically activated by depressing the brake pedal or operating the left brake lever.

Except TRX420TM:

Although the front and rear brakes have separate controls, all four wheels are interconnected when your ATV is in the 4WD mode. So operating any brake control in the 4WD mode will cause braking at both the front and rear wheels.

As a general rule, the front braking system provides about 70 percent of total stopping power.

For full braking effectiveness, use both the pedal and lever simultaneously. Using both braking systems will stop your ATV faster with greater stability.

To slow or stop, apply the brake lever and brake pedal smoothly, while downshifting to match your speed.

Gradually increase braking as you feel the brakes slowing your speed. The increase in engine compression from downshifting will help slow your ATV.

Applying the brakes too hard may cause the wheels to lock and slide, reducing control of your ATV. If this happens, release the brake controls, steer straight ahead until you regain control, then reapply the brakes more gently.

When possible, reduce your speed or complete braking before entering a turn. Avoid braking or closing the throttle quickly while turning. Either action may cause one or more wheels to slip and reduce your control of your ATV.



## Braking

---

Your ability to brake in a turn and to brake hard in an emergency situation are important riding skills.

When descending a long, steep grade, use engine compression braking by downshifting, with intermittent use of both brakes. Continuous brake application can overheat the brakes and reduce their effectiveness.

Riding with your foot resting on the brake pedal or your hands on the brake levers may overheat the brakes, reducing effectiveness.

For information on how to apply the brakes in various riding situations, see the following section, *Riding Your ATV*.

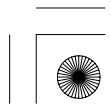



## Riding Your ATV

### Making Turns

Learn how to turn your ATV properly. Practice the techniques outlined in this section on level ground and at low speeds until you are confident in making turns.

#### **WARNING**

Turning improperly can make the ATV go out of control, causing a collision or overturn.

- Always follow proper procedures for turning as described in this owner's manual.
- Practice turning at low speeds before attempting to turn at faster speeds.
- Do not turn at excessive speeds.

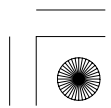



## Riding Your ATV

---

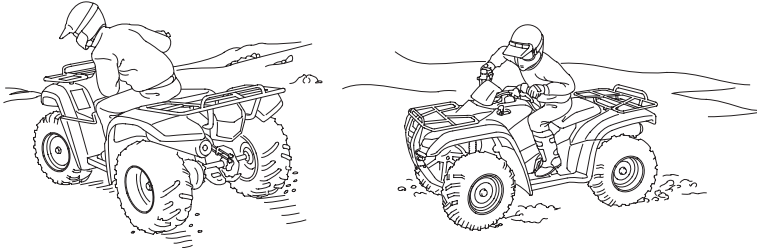

Lean your body to the inside of a turn and forward.

To make a turn on level ground: Steer the handlebar and lean your body toward the inside of the turn. Leaning helps balance the vehicle, and it feels more comfortable. Leaning into a turn is an important technique to master in riding an ATV.

To make a sharp turn at low speed: It helps to shift your body slightly forward on the seat, and lean inside, as you steer the handlebar. Shifting weight forward allows the rear wheels to turn easier, and it also improves front-wheel steering.

To make a turn from a full stop: Apply the throttle gradually when you turn and start up at the same time. Remember to shift your body forward to make sharp low-speed turns and whenever you turn while accelerating from a full stop.





## Riding Your ATV

### Skidding or Sliding

The terrain surface can be a major factor affecting turns. Skidding during a turn is more likely to occur on slippery surfaces, such as snow, ice, mud and loose gravel. If you skid on ice, you may lose all directional control. To avoid skidding on slippery terrain, keep your speed low and ride with caution.

#### **WARNING**

Skidding or sliding improperly may cause you to lose control of this ATV. You may also regain traction unexpectedly, which may cause the ATV to overturn.

Learn to safely control skidding by practicing at low speeds and on level, smooth terrain.

If your ATV skids sideways during a turn, steer in the direction of the skid. Avoid hard braking or accelerating until you have regained directional control.



## Riding Your ATV

---

### Riding Up Hills

The ATV's ability to safely climb hills largely depends on the rider's skill and judgment. Begin by practicing on smooth, gentle slopes. As you gain experience, you'll learn the hazards and your own limitations. You may then proceed to ride on more difficult terrain. However, you must be able to decide which hills or hazards might cause the ATV to overturn. Avoid excessively steep hills.

#### **WARNING**

Operating on excessively steep hills can cause the vehicle to overturn more easily than operating on level surfaces or small hills.

Never operate the ATV on hills too steep for the ATV or for your abilities.

When climbing hills, you must shift weight toward the front wheels to help keep them on the ground. To do this, shift your body slightly forward on the seat and lean forward. For greater weight shift, move your body farther forward and lean forward.

#### **WARNING**

Climbing hills improperly could cause loss of control or cause the ATV to overturn.

Always follow proper procedures for climbing hills as described in this owner's manual.



## Riding Your ATV

---

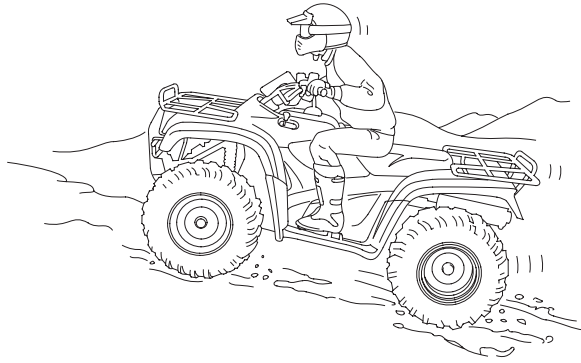

Shift weight forward when climbing hills.

- Always check the terrain carefully before you start up any hill.
- Never climb hills with excessively slippery or loose surfaces.
- To climb a hill, take a running start in an appropriate gear and speed for the conditions. Maintain a steady speed as you ascend the hill.
- Never open the throttle suddenly or make sudden gear changes. The ATV could flip over backward.
- Never go over the top of any hill at high speed. An obstacle, a sharp drop, or another vehicle or person could be on the other side of the hill.

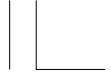

## Riding Your ATV

---

### **Stalling the ATV and/or Rolling Backwards:**

If you incorrectly estimate climbing capability or terrain conditions, the ATV may not have enough power or traction to continue uphill. If this happens, the ATV can stall and/or roll backwards.

### **⚠ WARNING**

Stalling, rolling backwards or improperly dismounting while climbing a hill could result in the ATV overturning.

Always follow proper procedures for climbing a hill as described in this owner's manual.



### What to do if the ATV stalls or rolls backwards when climbing a hill:

If you are about to lose all forward speed:

1. Using the front and rear brakes together, bring the ATV to a stop with the vehicle pointed straight uphill.
2. Get off the ATV while you continue holding the brakes.
3. Shift into neutral, set the parking brake and turn the engine off.
4. Then assess the situation.

If the ATV starts rolling backwards before you begin braking:

1. Keep your weight uphill.
2. Carefully apply the front brakes first, then carefully apply the rear brake. Do not apply either brake abruptly if you are rolling backwards, or the vehicle may overturn.

If the ATV continues sliding backwards:

After you've applied the brakes, get off and away from the vehicle.

Except TRX420TM:

Remember that operating any brake control in the 4WD mode will cause braking at both the front and rear wheels.

## **76 Basic Operation & Riding**

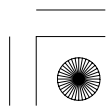
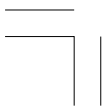



## Riding Your ATV

---

What to do after the ATV has stalled or rolled backwards:

If the hill is too steep or too slippery, or if you have any doubt whether you can safely walk the ATV back down the hill, leave the vehicle where it is and get help. If possible, block the wheels so the vehicle doesn't roll backwards.

If the hill is not too steep and you have good footing, you may be able to walk the ATV back down the hill. Make sure your intended path is clear in case you lose control of the ATV.



Be sure your legs are clear of the wheels.

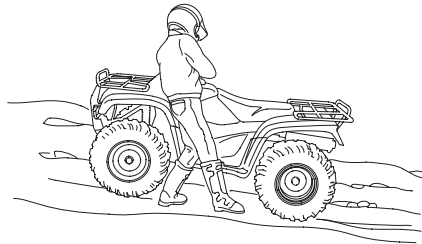

Body position for backing down a hill.

1. Stand with your body facing downhill, beside the vehicle so you can reach the rear brake lever with your right hand.
2. Be sure your legs are clear of the wheels.  
Check your footing.
3. Slowly and carefully back the ATV down the hill using the rear brake lever to control speed.
4. If you lose control of the ATV, for your safety, get away from the vehicle.

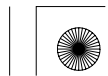



## Riding Your ATV

### Riding Down Hills

It's usually advisable to descend hills with the ATV pointed straight downhill. Avoid angles that would cause the vehicle to lean sharply to one side.

#### **⚠ WARNING**

Going down a hill improperly could cause loss of control or cause the ATV to overturn.

Always follow proper procedures for going down hills as described in this owner's manual.

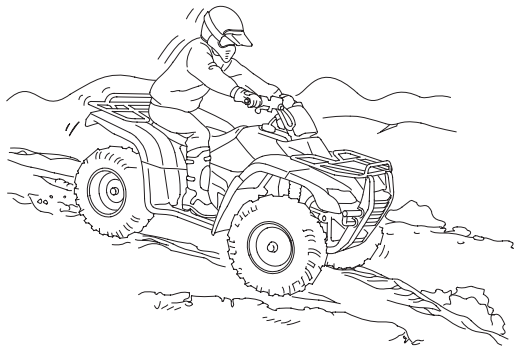

On downhills, shift your weight back.

As you approach a downhill, stop and survey the terrain below. Never ride past the limit of your visibility. Never go down a hill at high speed.



## Riding Your ATV

When you've selected a safe downhill path, shift into a lower gear, shift your weight back with your arms extended and braced against the handlebar, then go down slowly with the throttle closed.

Use mainly the rear brake to control speed. Avoid using either the front brake or rear brake hard or abruptly when riding down hills.

Except TRX420TM:

Remember that operating any brake control in the 4WD mode will cause braking at both the front and rear wheels.

Remember, braking effectiveness is reduced on any hill with a loose surface.

### Crossing or Turning on Hills or Slopes

Riding on hills or slopes is different from riding on level terrain. Be careful when riding on any hill. Make sure that you practice on gentle, smooth slopes before attempting to ride on steeper or more difficult terrain.

#### **⚠ WARNING**

Improperly crossing hills or turning on hills could cause loss of control or cause the ATV to overturn.

Always follow proper procedures for crossing or turning on slopes as described in this owner's manual. Avoid crossing steep hills if possible.

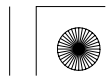



## Riding Your ATV

---

### Crossing Hills or Slopes

- To maintain balance and stability when riding across a slope, you need to shift weight toward the uphill side of the vehicle. To do this, move your body off the center of the seat and lean toward the uphill side.
- On a slippery or loose surface, you may also need to steer slightly uphill to maintain a straight course across the slope.
- Avoid crossing hills that are excessively steep, slippery or rough.



Shift weight uphill when crossing slopes.

### Making Turns on Slopes

- Compared to riding on level ground, you may need to shift more weight and lean more when making turns on slopes.
- Do not make turns on any slopes until you have first mastered the techniques for making turns on level terrain.





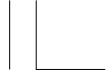

## Riding Your ATV

### Riding Over Obstacles

Before operating in a new area, check for obstacles. Watch out for bumps, rain ruts, potholes and other obstacles in the terrain. When you approach any obstacle, reduce your speed and be prepared to stop. Never try to ride over large obstacles, such as large rocks or fallen logs.

#### **WARNING**

Improperly operating over obstacles could cause loss of control or a collision and could cause the ATV to overturn.

When you go over obstacles, always follow proper procedures as described in this owner's manual.

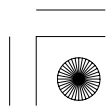
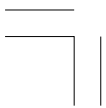



## Riding Your ATV

---

### Riding Through Water

Your ATV is designed to travel through water up to approximately 10 inches (254 mm) deep. Before crossing a stream, make sure the water is not too deep or flowing too fast.

#### **WARNING**

The ATV tires have some ability to float. Operating this ATV through deep or fast-flowing water may cause a loss of traction and loss of control, which could lead to an accident.

Never operate this ATV in fast-flowing water or in water deeper than that specified in this owner's manual.

1. Choose a path where both banks have gradual slopes.
2. Proceed through the water at a slow, steady speed.
3. Watch out for submerged obstacles and slippery rocks.
4. Avoid getting the spark plug or air cleaner wet, as this would cause the engine to stop.
5. After leaving the water, always test both the front and rear brakes.
  - Riding through water can make the brakes less effective than normal, and may reduce stopping ability.
  - If necessary, apply the brakes repeatedly until they dry out and operate normally.
  - If the brakes don't regain effectiveness, stop your ATV and follow the procedures on page 153 .





## Parking

1. Look for level parking area. Make sure the ground surface is firm.
2. After bringing your ATV to a stop, hold the brakes while you shift into neutral.
3. Set the parking brake.
4. Turn the ignition switch OFF (  $\bigcirc$  ).
5. If you're finished riding for the day, turn the fuel valve OFF.

If it is necessary to start the engine when your ATV is in gear and is stopped on a grade, rock the vehicle back and forth to allow shifting the transmission into neutral.

The brake lights are activated by applying the parking brake. When using the parking brake, be sure to turn the ignition switch OFF (  $\bigcirc$  ) to avoid discharging the battery.

### Parking on a Steep Incline or a Loose or Slippery Surface

If you must park your ATV on a steep incline or loose or slippery surface, use the following procedure:

1. While holding the brakes, set the parking brake.
2. Turn the ignition switch OFF (  $\bigcirc$  ) and release the brakes.
3. If the ATV begins to move, either while sitting on it or after you dismount, find a better parking location.
4. If rocks or other objects are available, you can block the wheels as shown for additional security.

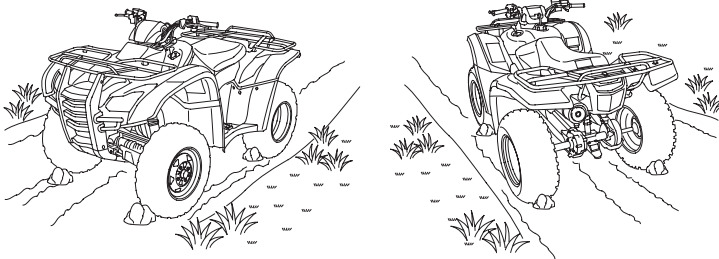



11/05/09 13:12:12 31HP4650 0093



## 84 Basic Operation & Riding

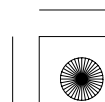
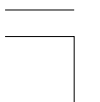



# Servicing Your Honda

To help keep your ATV in good shape, this section includes a Maintenance Schedule for required service and step-by-step instructions for specific maintenance tasks. You'll also find important safety precautions, information on fuels and oils, and tips for keeping your Honda looking good.

For information about replacing fuses, see page 197 .

For information about the exhaust emission and noise requirements of the U.S. Environmental Protection Agency (EPA) and the California Air Resources Board (CARB), see page 216 .

**Maintenance, replacement or repair of the emission control devices and systems may be performed by any ATV repair establishment or individual using parts that are "certified" to EPA standards.**



### *Before You Service Your Honda*

The Importance of Maintenance .....	87
Maintenance Safety .....	88
Important Safety Precautions .....	89
Maintenance Schedule .....	90
Maintenance Record.....	94

### *Service Preparations*

Maintenance Component Locations .....	95
Tool Kit .....	98
Owner's Manual Storage.....	99
Seat Removal .....	100
Clip Removal .....	101

(cont'd)

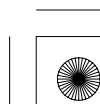
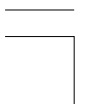



# Servicing Your Honda

---

## *Service Procedures*

### Fluids & Filters

Fuel .....	102
Engine Oil & Filter.....	105
Gear Case Oil .....	114
Differential Oil (Except TRX420TM ).....	117
Coolant.....	119
Air Cleaner.....	125

### Engine

Throttle.....	131
Clutch System .....	133
Reverse Lock System.....	134
Spark Plug .....	135
Valves.....	138
Spark Arrester .....	139

### Chassis

Suspension .....	140
Brakes.....	143
Tires .....	154
Guards .....	161
Drivetrain Boots .....	163

### Electrical

Battery.....	165
--------------	-----

Appearance Care .....	170
-----------------------	-----

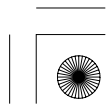
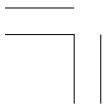



## The Importance of Maintenance

A well-maintained ATV is essential for safe, economical, and trouble-free riding. It will also help reduce air pollution. Careful pre-ride inspections and good maintenance are especially important because your ATV is designed to be ridden over rough off-road terrain.

To help you properly care for your ATV, this section of the manual provides a Maintenance Schedule. The service intervals in this schedule are based on average riding conditions.

### **WARNING**

Improperly maintaining this ATV or failing to correct a problem before you ride can cause a crash in which you can be seriously hurt or killed.

Always follow the inspection and maintenance recommendations and schedules in this owner's manual.

Frequent servicing of the air cleaner is especially important to help you avoid a possible costly engine repair.

If your ATV overturns or is involved in a crash, be sure your dealer inspects all major parts, even if you are able to make some repairs.



## Maintenance Safety

---

This section includes instructions on how to perform some important maintenance tasks. If you have basic mechanical skills, you can perform many of these tasks with the tools provided with your ATV.

Other tasks that are more difficult and require special tools are best performed by professionals. Removing the wheels should normally be handled only by a Honda technician or other qualified mechanic. Instructions are included in this manual only to assist in emergency service.

Some of the most important safety precautions follow. However, we cannot warn you of every conceivable hazard that can arise in performing maintenance. Only you can decide whether or not you should perform a given task.



### **WARNING**

Failure to properly follow maintenance instructions and precautions can cause you to be seriously hurt or killed.

Always follow the procedures and precautions in this owner's manual.

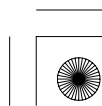
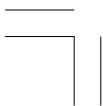





## Maintenance Safety

### Important Safety Precautions

- Make sure the engine is off before you begin any maintenance or repairs. This will help eliminate several potential hazards:
  - Carbon monoxide poisoning from engine exhaust.** Be sure there is adequate ventilation whenever you operate the engine.
  - Burns from hot ATV parts.** Let the engine and exhaust system cool before touching.
  - Injury from moving parts.** Do not run the engine unless instructed to do so.
- Read the instructions before you begin, and make sure you have the tools and skills required.
- To reduce the possibility of a fire or explosion, be careful when working around gasoline. Use only non-flammable solvent, not gasoline, to clean parts. Keep cigarettes, sparks, and flames away from all fuel-related parts.

Remember that your Honda dealer knows your ATV best and is fully equipped to maintain and repair it. To ensure the best quality and reliability, use only new Honda Genuine Parts or other equivalents for repair and replacement. If you have the tools and skills required for additional maintenance jobs, you can purchase an official Honda Service Manual (page 224 ).



## Maintenance Schedule

---

The required Maintenance Schedule that follows specifies how often you should have your ATV serviced, and what things need attention. It is essential to have your ATV serviced as scheduled to maintain safe, dependable performance and proper emission control.

The service intervals in this Maintenance Schedule are based on average riding conditions. Some items will need more frequent service if you ride in unusually wet or dusty areas or at full throttle. Consult your dealer for recommendations applicable to your individual needs and use.

Some items in the Maintenance Schedule can be performed with basic mechanical skills and hand tools. Procedures for these items are provided in this manual. Other items involve more extensive procedures and may require special training, tools, and equipment. We recommend that you have your dealer perform these tasks unless you have advanced mechanical skills and the required tools and equipment. Procedures for such items in this schedule are provided in an official Honda Service Manual available for purchase (page 224).

If you do not feel capable of performing a given task or need assistance, remember that your Honda dealer knows your ATV best and is fully equipped to maintain and repair it. If you decide to do your own maintenance, use only Honda Genuine Parts or their equivalents for repair or replacement to ensure the best quality and reliability.





## Maintenance Schedule

---

Perform the pre-ride inspection (page 43 ) and owner maintenance on this section at each scheduled maintenance period.

Each item on the maintenance schedule requires some mechanical knowledge. Certain items (particularly those marked \* and \*\*) may require more technical information and tools. Consult your dealer.

- \* Should be serviced by your dealer, unless the owner has proper tools and service data and is mechanically qualified. Refer to the official Honda Service Manual (page 224).
- \*\* In the interest of safety, we recommend these items be serviced only by your dealer.

*Summary of Maintenance Schedule Notes & Procedures:*

### NOTES:

1. Service more frequently when riding in dusty areas, sand or snow.
2. Service more frequently after riding in very wet or muddy conditions.
3. Replace every 2 years. Replacement requires mechanical skill.



# Maintenance Schedule

Maintenance Procedures:

I: inspect and clean, adjust, lubricate, or replace, if necessary

C: clean

A: adjust

L: lubricate

R: replace

ITEMS	FREQUENCY	WHICHEVER COMES FIRST ⇒	INITIAL MAINT. INTERVAL			Refer to page	
			mi	100	600		1200
			km	150	1000		2000
			MONTH	1	6		12
NOTE	HOURS	20	100	200			
* FUEL LINE					I	—	
* THROTTLE OPERATION					I	131	
AIR CLEANER	NOTE 1			C	C	125	
AIR CLEANER HOUSING DRAIN TUBE	NOTE 2			I	I	130	
SPARK PLUG				I	I	135	
* VALVE CLEARANCE				I	I	138	
ENGINE OIL			INITIAL= 100 mi (150 km), 20 operating hours or 1 month: R			105	
ENGINE OIL FILTER			REGULAR= Every 600 mi (1,000 km), 100 operating hours or 12 months: R			110	
* ENGINE IDLE SPEED				I	I	—	
RADIATOR COOLANT	NOTE 3			I	I	119	
* COOLING SYSTEM	NOTE 2			I	I	—	

\* Should be serviced by your dealer, unless the owner has proper tools and service data and is mechanically qualified. Refer to the official Honda Service Manual (page 224).





## Maintenance Schedule

ITEMS	FREQUENCY	WHICHEVER COMES FIRST		INITIAL MAINT.	REGULAR MAINT. INTERVAL		Refer to page
		⇒	mi	100	600	1200	
			km	150	1000	2000	
		MONTH	1	6	12		
		NOTE	HOURS	20	100	200	
	DRIVETRAIN BOOTS						163
	REAR FINAL GEAR CASE OIL AND DIFFERENTIAL OIL (Except TRX420TM)				(R: EVERY 2 YEARS)		114, 117
	REAR FINAL GEAR CASE OIL (TRX420TM only)				(R: EVERY 2 YEARS)		114
*	2WD/4WD SELECT SYSTEM (Except TRX420TM)						—
*	BRAKE FLUID	NOTE 3					143
*	BRAKE SHOES WEAR	NOTE 1,2					151
*	BRAKE PADS WEAR	NOTE 1,2					146
*	BRAKE LIGHT SWITCH						152
	BRAKE SYSTEM						143
*	REVERSE LOCK SYSTEM GUARDS						134
	CLUTCH SYSTEM						161
*	SUSPENSION						133
*	SPARK ARRESTER				C	C	140
*	NUTS, BOLTS, FASTENERS						139
**	WHEELS/TIRES						—
**	TIE-ROD AND JOINT BOOTS						154
**	STEERING SHAFT HOLDER BEARINGS						—
**	STEERING SYSTEM						—

\* Should be serviced by your dealer, unless the owner has proper tools and service data and is mechanically qualified. Refer to the official Honda Service Manual (page 224).

\*\* In the interest of safety, we recommend these items be serviced only by your dealer.





## Maintenance Record

Keeping an accurate maintenance record will help ensure that your ATV is properly maintained. Retain detailed receipts to verify the maintenance was performed. If the ATV is sold, these receipts should be transferred with the ATV to the new owner. Make sure whoever performs the maintenance completes this record. All scheduled maintenance, including the 100 mile (150 km) or 1 month or 20 hours initial maintenance, is considered a normal owner operating cost and will be charged for by your dealer. Use the space under Notes to record anything you want to remind yourself about or mention to your dealer.

Miles (km) or months or hours	ODO or HOUR	Date	Performed By:	Notes
100 (150) or 1 or 20				
600 (1,000) or 6 or 100				
1,200 (2,000) or 12 or 200				
1,800 (3,000) or 18 or 300				
2,400 (4,000) or 24 or 400				
3,000 (5,000) or 30 or 500				
3,600 (6,000) or 36 or 600				
4,200 (7,000) or 42 or 700				
4,800 (8,000) or 48 or 800				





## Maintenance Component Locations

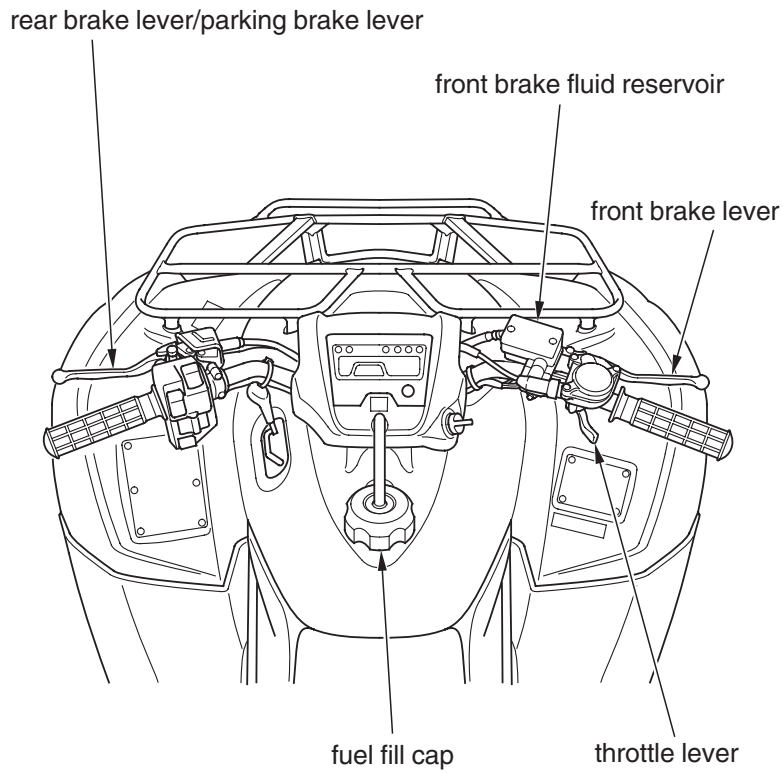



## Maintenance Component Locations

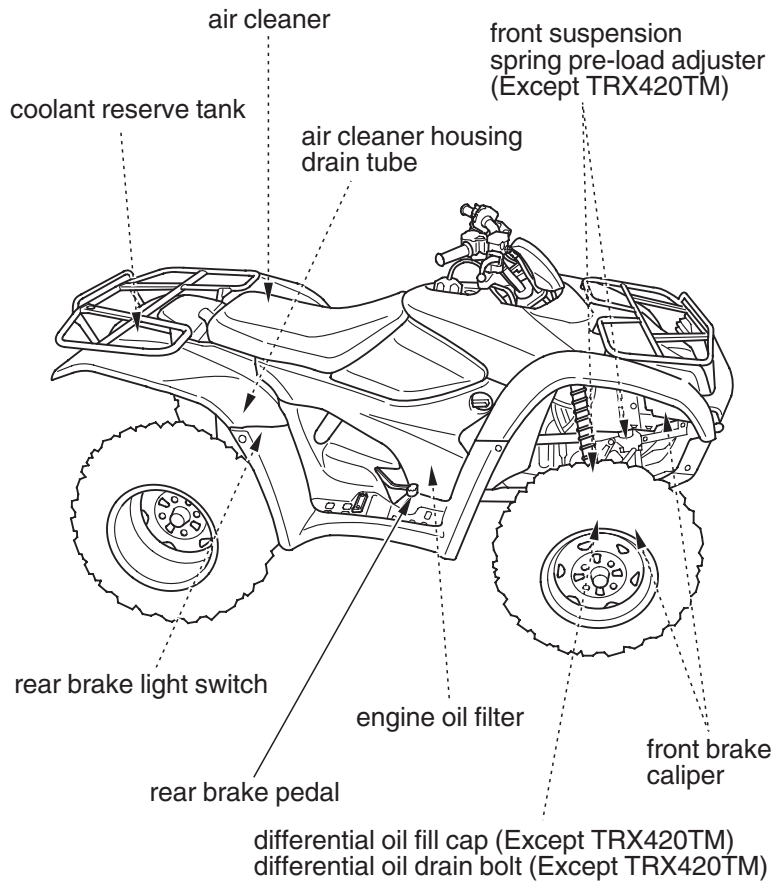





## Maintenance Component Locations

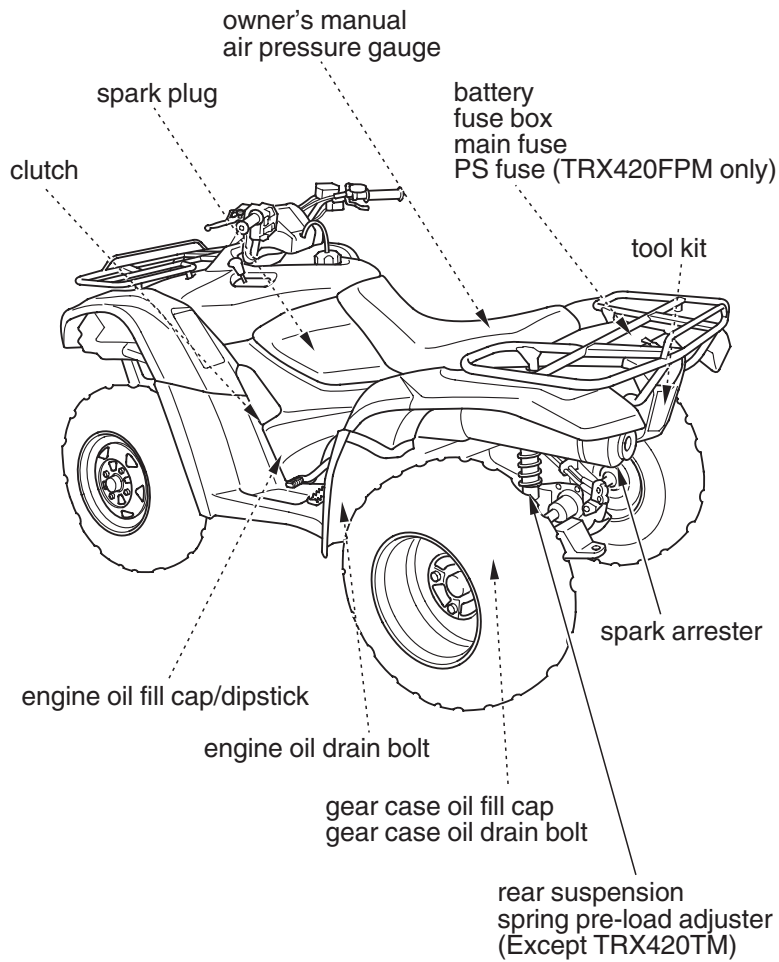



## Tool Kit

---

The tool kit (1) is stored in the storage compartment (2) below the rear cargo rack.

To open the compartment, unhook the rubber strap (3).

An optional, larger tool kit may be available. Check with your dealer's parts department.

### REAR

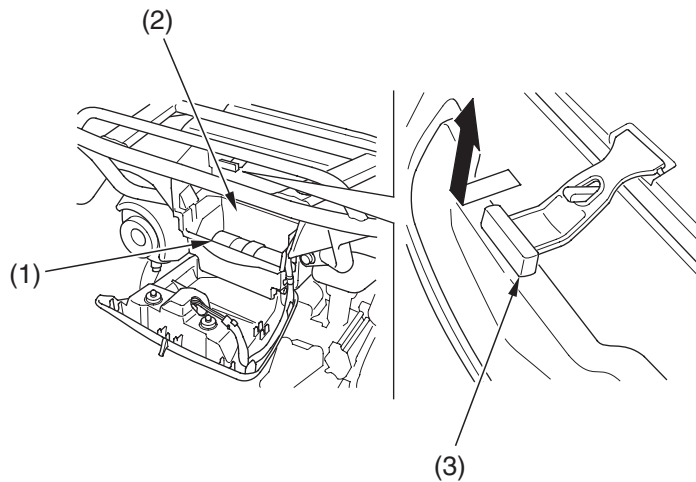

(1) tool kit  
(2) storage compartment

(3) rubber strap

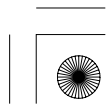



## Owner's Manual Storage

Your ATV provides storage for the owner's manual so you'll have it with you for easy reference. Store your owner's manual (1) in the plastic document bag underside of the seat (2).

The owner's manual and air pressure gauge (3) should be stored in the plastic document bag (4).

To remove the seat, see page 100 .

Be careful not to flood this area when washing your ATV.

### SEAT UNDERSIDE

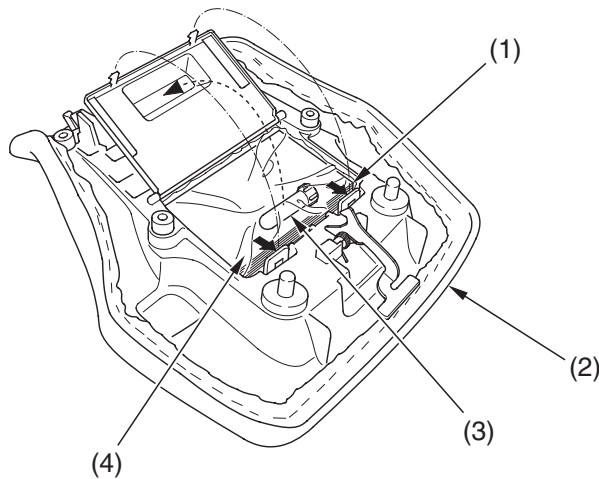

(1) owner's manual  
(2) seat

(3) air pressure gauge  
(4) plastic document bag

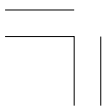



## Seat Removal

---

Refer to *Safety Precautions* on page 89 .

The seat must be removed for the air cleaner, engine oil, engine oil filter, clutch, spark plug, battery and fuse maintenance and to remove the side covers, rear fender cover and left tank side cover, to access the owner's manual, air pressure gauge, coolant reserve tank cap and color label.

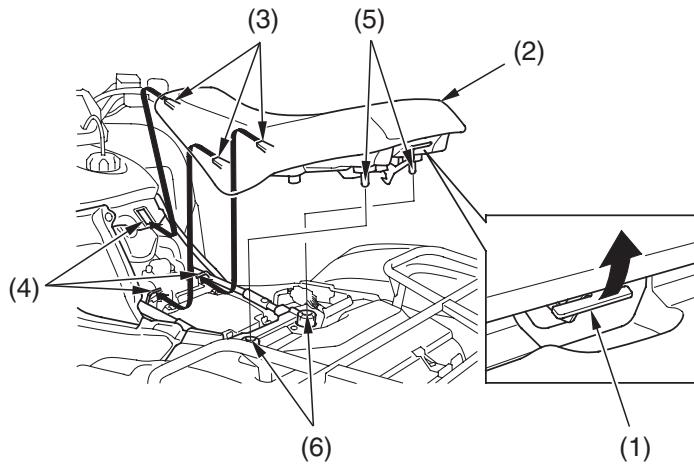

- |                  |              |
|------------------|--------------|
| (1) seat latch   | (4) hooks    |
| (2) seat         | (5) studs    |
| (3) front prongs | (6) grommets |

### Removal

1. Pull the seat latch (1) at the rear of the seat.
2. Slide the seat (2) back and lift it.

### Installation

1. Insert the front prongs (3) into the hooks (4) on the frame and press the studs (5) into the grommets (6).
2. Press down on the seat until locks.

## 100 Servicing Your Honda





## Clip Removal

### Removal

1. Pull up the center pin to release the lock.
2. Pull out the clip of the hole.

1.



2.

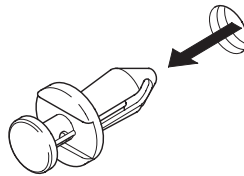

### Installation

1. Insert the clip into the hole.
2. Press down the center pin securely to lock the clip.

1.

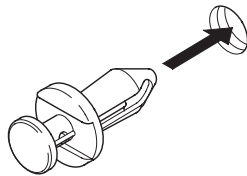

2.





## Fuel

---

Refer to *Safety Precautions* on page 89 .

### Fuel Recommendation

type	unleaded
pump octane number	86 (or higher)

Use only unleaded fuel in your Honda. If you ride your Honda in a country where leaded fuel might be available, take precautions to use only unleaded fuel.

Your engine is designed to use any unleaded gasoline that has a pump octane number of 86 or higher. Gasoline pumps at service stations normally display the pump octane number. For information on the use of oxygenated fuels, see page 220 .

Use of lower octane gasoline can cause persistent “pinging” or “spark knock” (a loud rapping noise) which, if severe, can lead to engine damage. Light pinging experienced while operating under a heavy load, such as climbing a hill, is no cause for concern.

If pinging or spark knock occurs at a steady engine speed under normal load, change brands of gasoline. If pinging or spark knock persists, consult your dealer.

Never use stale or contaminated gasoline or an oil/gasoline mixture. Avoid getting dirt, dust, or water in the fuel tank.

## 102 Servicing Your Honda



# Fuel

## Fuel Capacity

Fuel tank capacity, including reserve:

3.51 US gal (13.3 l)

Reserve capacity:

0.69 US gal (2.6 l)

The tank should be refilled as soon as possible after switching to reserve, and the fuel valve should be returned to the ON position after refueling to avoid running out of fuel with no reserve.

## Refueling Procedure

Refer to *Safety Precautions* on page 89.

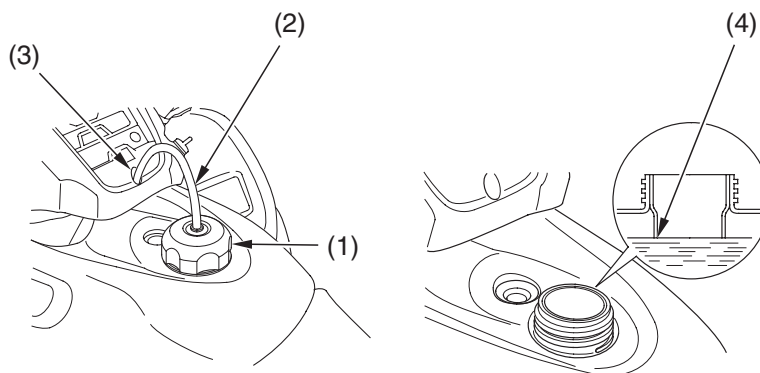

- (1) fuel fill cap
- (2) breather tube

- (3) handlebar cover hole
- (4) filler neck





## Fuel

---

1. To open the fuel fill cap (1), turn it counterclockwise.
2. Pull the breather tube (2) out of the handlebar cover hole (3).
3. Add fuel until the level reaches the bottom of the filler neck (4).  
Avoid over filling the tank. There should be no fuel in the filler neck.

### **WARNING**

Gasoline is highly flammable and explosive. You can be burned or seriously injured when handling fuel.

- Stop the engine and keep heat, sparks and flame away.
- Handle fuel only outdoors.
- Wipe up spills immediately.

4. After refueling, turn the fuel fill cap clockwise until it clicks.
5. Insert the breather tube into the handlebar cover hole.
6. If the fuel valve was set to RES, turn the fuel valve ON.

If you replace the fuel fill cap, use only a Honda Genuine replacement part.





## Engine Oil & Filter

---

Engine oil quality is a major factor that affects both the performance and the service life of the engine.

Using the proper oil (page 106 ) and filter, and regularly checking, adding, and changing oil will help extend your engine's life. Even the best oil wears out. Changing oil helps get rid of dirt and deposits in the engine. Operating the engine with old or dirty oil can damage your engine. Running the engine with insufficient oil can cause serious damage to the engine and transmission.

Change the engine oil as specified in the maintenance schedule on page 92 . When running in very dusty conditions, oil changes should be performed more frequently than specified in the maintenance schedule.





## Engine Oil & Filter

### Oil Recommendation

API classification	SG or higher except oils labeled as energy conserving on the circular API service label
viscosity (weight)	SAE 10W-30
JASO T 903 standard	MA
suggested oil*	Pro Honda GN4 4-stroke oil or an equivalent motorcycle oil.

\* Suggested oils are equal in performance to SJ oils that are not labeled as energy conserving on the circular API service label.

- Your ATV does not need oil additives. Use the recommended oil.
- Do not use oils with graphite or molybdenum additives. They may adversely affect clutch operation.
- Do not use API SH or higher oils displaying a circular API “energy conserving” service label on the container. They may affect lubrication and clutch performance.



NOT RECOMMENDED



OK

- Do not use non-detergent, vegetable, or castor based racing oils.

### 106 Servicing Your Honda





# Engine Oil & Filter

Other viscosities shown in the following chart may be used when the average temperature in your riding area is within the indicated range.

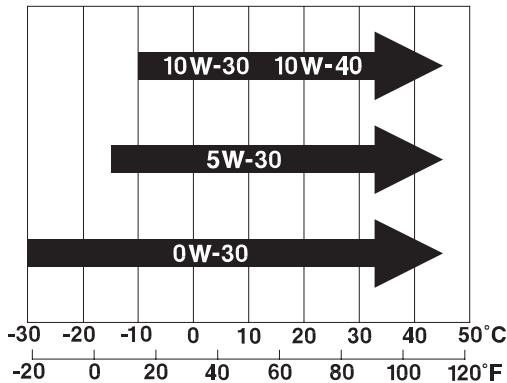

### JASO T 903 standard

The JASO T 903 standard is an index for engine oils for 4-stroke motorcycle engines.

There are two classes: MA and MB.

Oil conforming to the standard is labeled on the oil container. For example, the following label shows the MA classification.

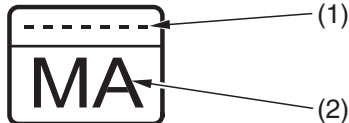

- (1) oil code
- (2) oil classification



# Engine Oil & Filter

## Checking & Adding Oil

Refer to *Safety Precautions* on page 89.

Check the engine oil level each day before operating your ATV and add if needed.

The oil fill cap/dipstick is located at the front left crankcase.

*Before riding your ATV, check the engine oil level.*

1. Park your ATV on a firm, level surface.
2. Start the engine in a well-ventilated area and let it idle for 3–5 minutes. If the air temperature is below 10°C (50°F), let the engine idle for an additional 5 minutes (a total of 10 minutes).
3. Stop the engine and wait 2–3 minutes.
4. Remove the seat (page 100).
5. Unsnap and remove the left side cover (1).

LEFT SIDE

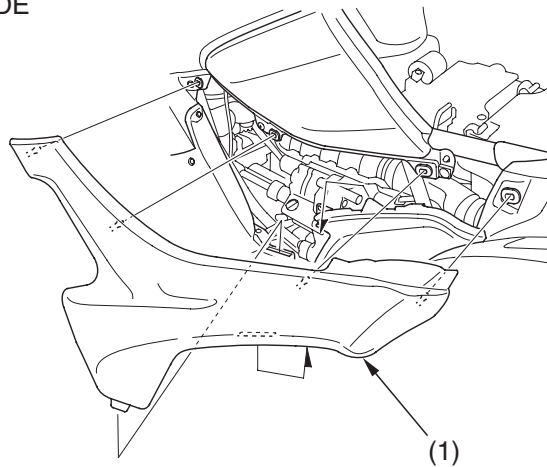

(1) left side cover



## Engine Oil & Filter

6. Remove the oil fill cap/dipstick (2) from the front crankcase and wipe it clean.
7. Insert the oil fill cap/dipstick without screwing it in, then remove the oil fill cap/dipstick and check the oil level. The oil level should be between the upper level mark (3) and the lower level mark (4) on the oil fill cap/dipstick.
8. If the oil level is near or below the lower level mark, then add the specified oil into the fill cap hole, up to the upper level mark on the oil fill cap/dipstick. Do not overfill.
9. Reinstall the oil fill cap/dipstick.
10. Install the left side cover.
11. Install the seat.

### NOTICE

*Running the engine with an improper oil level can cause serious engine damage.*

### LEFT SIDE

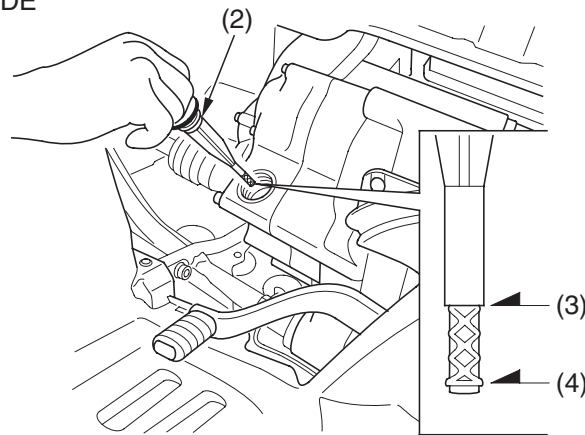

(2) oil fill cap/dipstick

(3) upper level mark

(4) lower level mark



## Engine Oil & Filter

---

### Changing Engine Oil & Filter

Refer to *Safety Precautions* on page 89 .

Your ATV's oil filter has very specific performance requirements. Use a new Honda Genuine oil filter specified for your model or a filter of equal quality.

#### NOTICE

*Using the wrong oil filter may result in leaks or engine damage.*

This procedure requires mechanical skill and professional tools such as a torque wrench as well as a means for disposing of the drained fluid (page 184). If you do not have the skills or the tools, see your dealer.

Change the oil with the engine warm to assure complete and rapid draining.

#### *Drain the Engine Oil:*

1. With the ATV on the level ground, remove the seat (page 100 ), left side cover (page 108 ) and the oil fill cap/dipstick from the front crankcase.





## Engine Oil & Filter

2. Place an oil drain pan under the crankcase and remove the engine oil drain bolt (1) and sealing washer (2).

### UNDER ENGINE

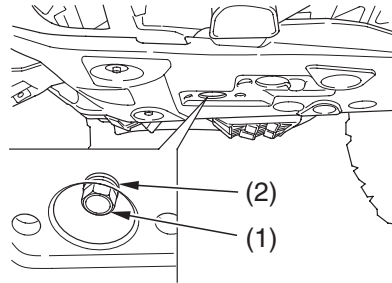

(1) engine oil drain bolt (2) sealing washer

### *Install a New Engine Oil Filter:*

Place shop towels under the oil filter cover because oil will flow out.

1. Remove the seat (page 100).
2. Unsnap and remove the right side cover (1).

### RIGHT SIDE

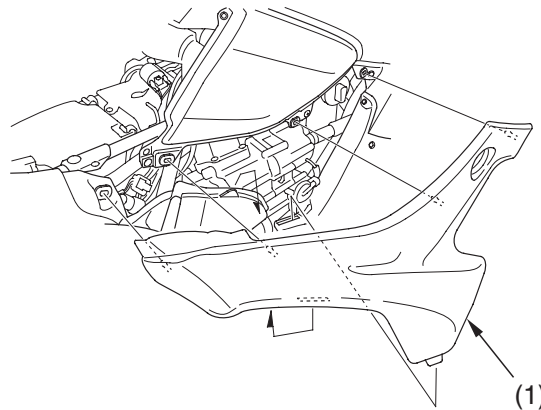

(1) right side cover

(cont'd)



## Engine Oil & Filter

3. Remove the oil filter cover (2) by removing the bolts (3). Let the remaining oil drain out. Discard the oil filter (4) in an approved manner (page 184).
4. Apply engine oil to a new O-rings (5) and install them to the oil filter cover. Then install a new oil filter. Use only the Honda Genuine oil filter or a filter of equivalent quality specified for your model. Using the wrong Honda filter or a non-Honda filter which is not of equivalent quality may cause engine damage.
5. Reposition the spring (6) to the engine crankcase and install a new oil filter with the rubber seal (7) facing out, away from the engine. You will see the “OUTSIDE (TOWARDS FILTER COVER)” mark (8) on the filter body, near the seal.

### NOTICE

*Improper installation of the oil filter can cause serious engine damage.*

RIGHT SIDE

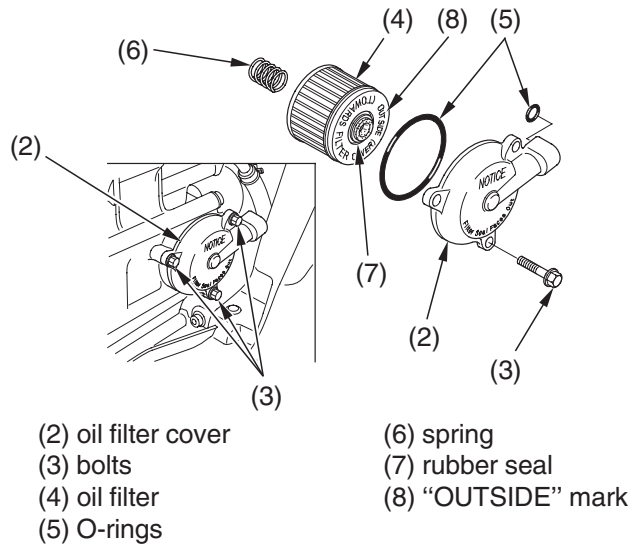





## Engine Oil & Filter

6. Reinstall the oil filter cover, making sure the bolts are tightened to the specified torque:  
7 lbf-ft (10 N·m , 1.0 kgf·m)
7. Pour the drained oil into a suitable container and dispose of it in an approved manner (page 184).

### NOTICE

*Improper disposal of drained fluids is harmful to the environment.*

8. Install the right side cover.

#### *Add Engine Oil:*

1. Reinstall the oil drain bolt with the new sealing washer and tighten it to the specified torque:  
18 lbf-ft (25 N·m , 2.5 kgf·m)
2. Fill the crankcase with the recommended grade oil approximately:  
3.0 US qt (2.8 ℓ)
3. Reinstall the oil fill cap/dipstick.
4. Start the engine and let it idle for 3–5 minutes.
5. Stop the engine, wait 2–3 minutes and check the oil level. Make sure the oil is between the upper and lower level marks on the oil fill cap/dipstick. If necessary, add more oil but do not overfill.
6. Check that there are no oil leaks.
7. Install the left side cover.
8. Install the seat.

If a torque wrench is not used for installation, see your dealer as soon as possible to verify proper assembly.



## Gear Case Oil

---

### Oil Recommendation

type	hypoid gear oil
viscosity (weight)	SAE 80
suggested oil	Honda shaft drive oil or equivalent

### Changing Oil

Refer to *Safety Precautions* on page 89 .

Change the oil with the gear case at normal operating temperature to assure complete and rapid draining.

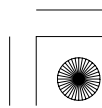
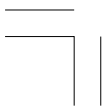



## Gear Case Oil

1. Park your ATV on a firm, level surface.
2. Remove the skid plate bolts (1) and the skid plate (2).

### REAR UNDERSIDE

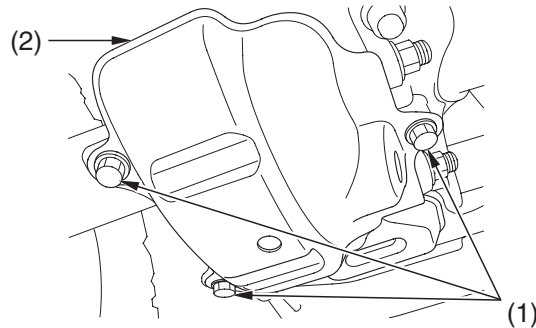

(1) skid plate bolts      (2) skid plate

3. Place an oil drain pan under the oil drain bolt (3).
4. Remove the oil fill cap (4) and the drain bolt.
5. After the oil has completely drained, reinstall the drain bolt with the new sealing washer and tighten it to the specified torque:  
**9 lbf·ft (12 N·m , 1.2 kgf·m)**
6. Remove the oil level check bolt (5).
7. Pour the drained oil into a suitable container and dispose of it in an approved manner (page 184).

### NOTICE

*Improper disposal of drained fluids is harmful to the environment.*

(cont'd)



## Gear Case Oil

8. Slowly fill the gear case with the recommended oil until oil start to flow out of the oil level check hole (6). Allow oil to settle for 2–3 minutes before moving to next step to prevent overfilling.  
2.5 US oz (75 cm<sup>3</sup>)
9. Install the oil fill cap and tighten it to the specified torque:  
9 lbf·ft (12 N·m , 1.2 kgf·m)
10. Install the oil level check bolt with the new sealing washer and tighten it to the specified torque:  
9 lbf·ft (12 N·m , 1.2 kgf·m)
11. Install the skid plate and new skid plate bolts. Tighten them to the specified torque:  
24 lbf·ft (32 N·m , 3.3 kgf·m)

REAR

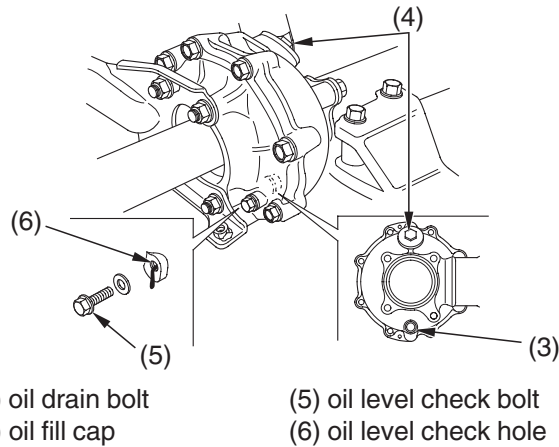



## Differential Oil (Except TRX420TM)

### Oil Recommendation

type	hypoid gear oil
viscosity (weight)	SAE 80
suggested oil	Honda shaft drive oil or equivalent

### Changing Oil

Refer to *Safety Precautions* on page 89.

Change the oil with the differential at normal operating temperature to assure complete and rapid draining.

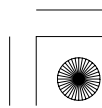
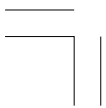



## Differential Oil (Except TRX420TM)

---

1. Park your ATV on a firm, level surface.
2. Place an oil drain pan under the oil drain bolt (1).
3. Remove the oil fill cap (2) and the drain bolt.
4. After the oil has completely drained, reinstall the drain bolt with the new sealing washer and tighten it to the specified torque:  
**9 lbf·ft (12 N·m , 1.2 kgf·m)**
5. Pour the drained oil into a suitable container and dispose of it in an approved manner (page 184).

### NOTICE

*Improper disposal of drained fluids is harmful to the environment.*

6. Fill the differential with the recommended oil.  
**7.8 US oz (230 cm<sup>3</sup>)**  
Make sure the oil level is at the lower edge of the oil fill inspection hole (3).
7. Install the oil fill cap and tighten it to the specified torque:  
**9 lbf·ft (12 N·m , 1.2 kgf·m)**

### FRONT

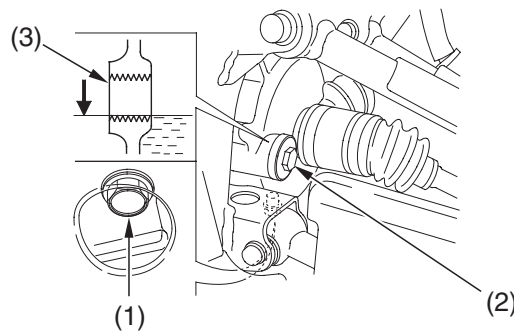

(1) oil drain bolt  
(2) oil fill cap

(3) oil fill inspection hole





## Coolant

Your ATV's liquid cooling system dissipates engine heat through the coolant jacket that surrounds the cylinder and cylinder head.

Maintaining the coolant will allow the cooling system to work properly and prevent freezing, overheating, and corrosion.

### Coolant Recommendation

Use Pro Honda HP coolant or an equivalent high quality ethylene glycol antifreeze containing corrosion protection inhibitors specifically recommended for use in aluminum engines. Check the antifreeze container label.

Use only distilled water as a part of the coolant solution. Water that is high in mineral content or salt may be harmful to the aluminum engine.

#### NOTICE

*Using coolant with silicate inhibitors may cause premature wear of water pump seals or blockage of radiator passages. Using tap water may cause engine damage.*

The factory provides a 50/50 solution of antifreeze and water in this ATV. This coolant solution is recommended for most operating temperatures and provides good corrosion protection.

Decreasing the concentration of antifreeze to less than 40% will not provide proper corrosion protection.



## Coolant

Increasing the concentration of antifreeze is not recommended because it decreases cooling system performance. Higher concentrations of antifreeze (up to 60%) should only be used to provide additional protection against freezing. Check the cooling system frequently during freezing weather.

### Checking & Adding Coolant

Refer to *Safety Precautions* on page 89 .

Check the engine coolant level each day before operating your ATV and add if needed.

#### RIGHT REAR

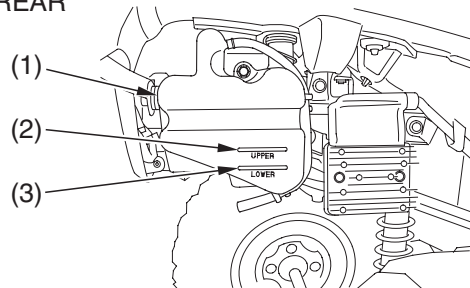

- (1) reserve tank                      (3) LOWER level mark  
(2) UPPER level mark

1. Make sure the vehicle is on level ground.
2. With the engine at normal operating temperature, check the coolant level in the reserve tank ( 1 ). It should be between the UPPER ( 2 ) and LOWER ( 3 ) level marks.  
If the reserve tank is empty, or if coolant loss is excessive, check for leaks and see your dealer for repair.

## 120 Servicing Your Honda







## Coolant

3. Remove the seat (page 100).
  4. Unhook the rubber strap (4).
  5. Disengage the pins (5) from the grommets (6).
  6. Slide the rear fender cover (7) forward to disengage the tabs (8).
  7. Remove the rear fender cover and reserve tank cap (9).
- Always add coolant to the reserve tank. Do not attempt to add coolant by removing the radiator cap.
8. Add coolant to the reserve tank as required to bring the coolant level to the UPPER level mark.

### REAR

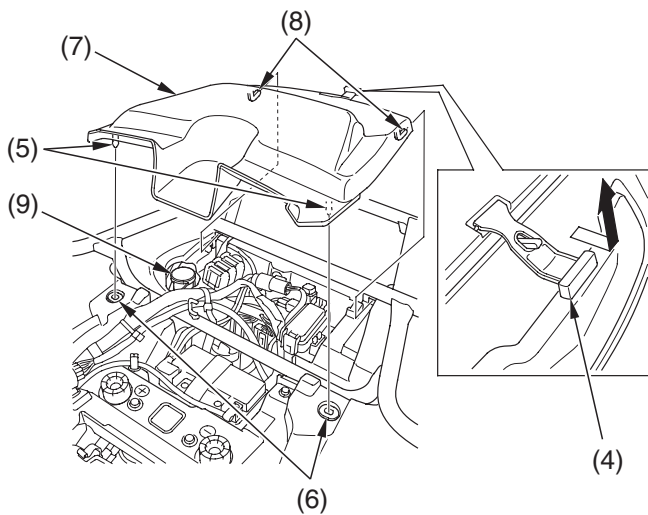

- (4) rubber strap
- (5) pins
- (6) grommets

- (7) rear fender cover
- (8) tabs
- (9) reserve tank cap

9. After adding coolant, install the parts in the reverse order of removal.



# Coolant

---

## Coolant Replacement

Refer to *Safety Precautions* on page 89 .

Coolant should be replaced by your dealer, unless you have the proper tools and service data, and are mechanically qualified. Refer to the official Honda Service Manual (page 224 ).

### **WARNING**

Removing the radiator cap while the engine is hot can cause the coolant to spray out, seriously scalding you.

Always let the engine and radiator cool down before removing the radiator cap.



To properly dispose of drained coolant, refer to *You & the Environment*, page 184 .

### **NOTICE**

*Improper disposal of drained fluids is harmful to the environment.*

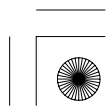
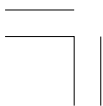



# Coolant

## Radiator Core

Refer to *Safety Precautions* on page 89 .

Check the air passages for clogging or damage. Remove insects, mud, or any obstruction with low water pressure. Have the radiator checked by your dealer if the air flow is restricted over more than 20% of the radiator surface.

Clean the radiator core after riding the ATV in mud.

*To clean the radiator core and radiator grill plate:*

1. Unhook the tabs A ( 1 ) and remove the radiator grill under cover ( 2 ).
2. Remove the clips ( 3 ) (page 101 ) and radiator grill covers ( 4 ).
3. Unhook the tabs B ( 5 ) and remove the couplers ( 6 ).

### NOTICE

*Do not apply pressured water directly to the radiator core. The pressured water can damage the radiator core.*

FRONT

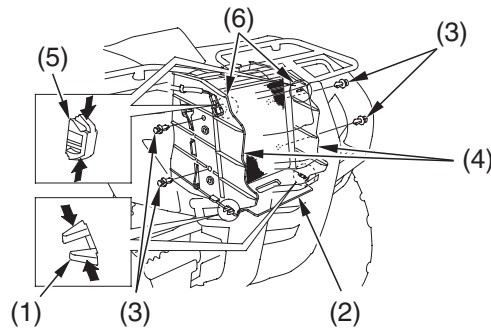

- |                                |                           |
|--------------------------------|---------------------------|
| (1) tabs A                     | (4) radiator grill covers |
| (2) radiator grill under cover | (5) tabs B                |
| (3) clips                      | (6) couplers (cont'd)     |



## Coolant

---

4. Remove the radiator grill plate (7).
5. Wash the radiator core (8) and radiator grill plate.
6. Install the removed parts in reverse order of removal.

FRONT

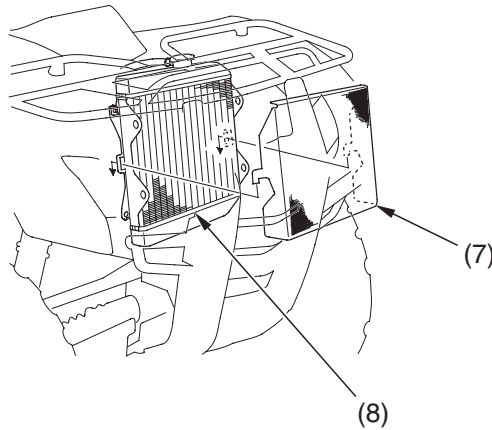

(7) radiator grill plate

(8) radiator core





## Air Cleaner

---

Refer to *Safety Precautions* on page 89 .

Proper air cleaner maintenance is very important for off-road vehicles. A dirty, water-soaked, worn-out, or defective air cleaner will allow dirt, dust, mud, and other impurities to pass into the engine.

Service the air cleaner more frequently if you ride in unusually wet or dusty areas. Your dealer can help you determine the correct service interval for your riding conditions.

Your ATV's air cleaner has very specific performance requirements. Use a new Honda Genuine air cleaner specified for your model or an air cleaner of equal quality.

### NOTICE

*Using the wrong air cleaner may result in premature engine wear.*

Proper air cleaner maintenance can prevent premature engine wear or damage, expensive repairs, low engine power, poor gas mileage, and spark plug fouling.

### NOTICE

*Improper or lack of proper air cleaner maintenance can cause poor performance and premature engine wear.*



# Air Cleaner

---

## Cleaning

1. Remove the seat (page 100).

### UNDER SEAT

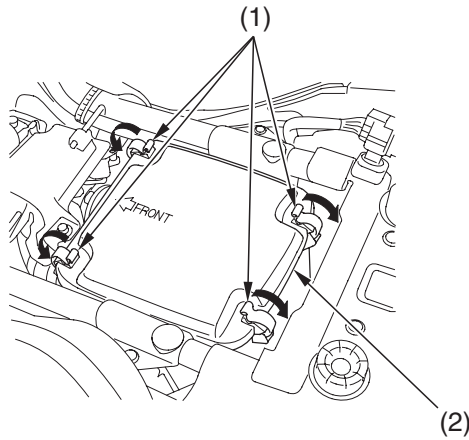

(1) retainer clips

(2) air cleaner housing cover

2. Unlatch the retainer clips (1).
3. Remove the air cleaner housing cover (2).





## Air Cleaner

4. Loosen the screw (3) and remove the air cleaner assembly (4) from the air cleaner housing.
5. Unscrew the clamp (5).
6. Remove the air cleaner (6) from the air cleaner body (7).
7. Gently wash the air cleaner in clean, non-flammable (high flash point) solvent such as kerosene — not gasoline. After cleaning, gently squeeze out the remaining solvent. Avoid twisting or wringing the air cleaner. This can tear the foam.
8. Inspect for tears or cracks in the foam or seams of the air cleaner. Replace the air cleaner if it is damaged.
9. Allow the air cleaner to dry thoroughly before applying oil. A wet air cleaner will not fully absorb the oil.
10. Pour clean Pro Honda Foam Filter Oil or an equivalent over the entire surface of the air cleaner. Use both hands to evenly spread the oil into the air cleaner. Gently squeeze out any excess oil. (To keep your hands dry, place the air cleaner in a clean plastic bag before spreading the oil into the air cleaner.)



### UNDER SEAT

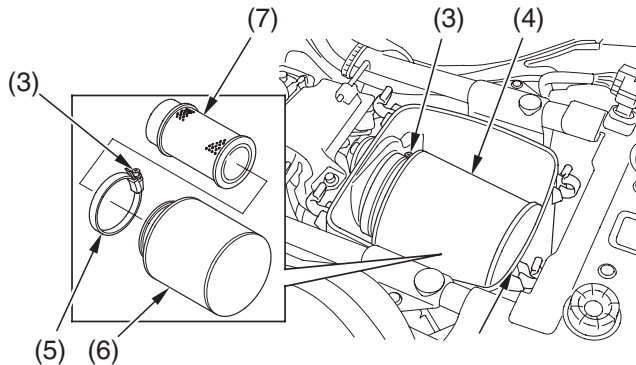

- |                          |                      |
|--------------------------|----------------------|
| (3) screw                | (6) air cleaner      |
| (4) air cleaner assembly | (7) air cleaner body |
| (5) clamp                |                      |

(cont'd)





## Air Cleaner

---

11. Install the air cleaner on the air cleaner body.
12. Apply a thin coat of grease to the sealing surface of the air cleaner assembly.
13. Install the clamp.
14. Insert the air cleaner assembly into the air cleaner housing.
15. Fasten the screw.
16. Reassemble by reversing the disassembly sequence.
  - Install the air cleaner housing cover with the **FRONT** mark ( 8 ) facing forward and fit the cut out of the tab ( 9 ) at the end of the air cleaner.

### UNDER SEAT

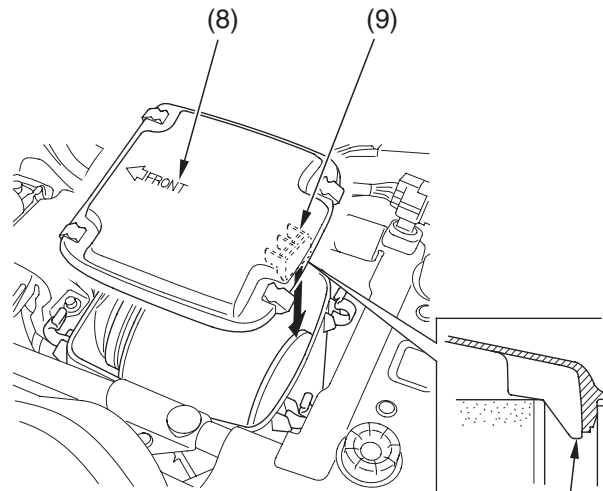

(8) FRONT mark  
(9) tab

(9)







## Air Cleaner

### Dust Cover

UNDER SEAT

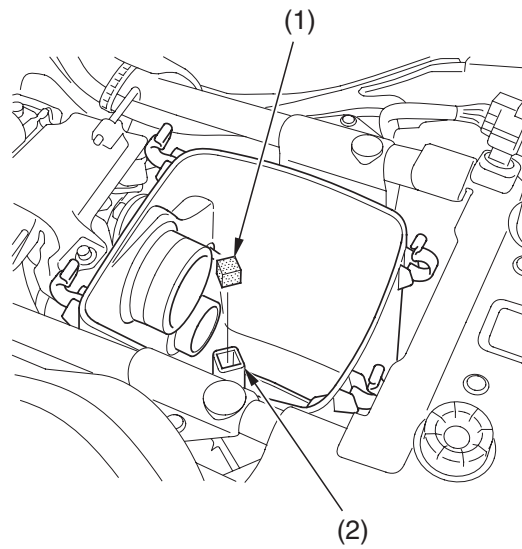

(1) dust cover

(2) breather joint

Do not push the dust cover (1) too far into the breather joint (2).  
If the dust cover is dirty, clean it.

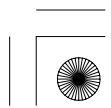
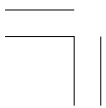



## Air Cleaner

### Air Cleaner Housing Drain Tube

The air cleaner housing drain tube should be serviced in accordance with the Maintenance Schedule. (Riding through water may require more frequent inspection.) If deposits can be seen in the drain tube, the tube must be cleaned before starting the vehicle.

REAR

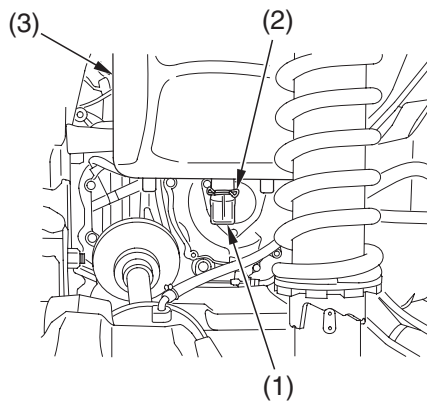

(1) drain tube  
(2) clip

(3) air cleaner housing

1. Remove the drain tube (1) by removing the clip (2) under the air cleaner housing (3).
2. Drain the deposits.
3. Reinstall the drain tube, securing it with the clip.



# Throttle

## Throttle Freeplay

Refer to *Safety Precautions* on page 89.

### RIGHT HANDLEBAR

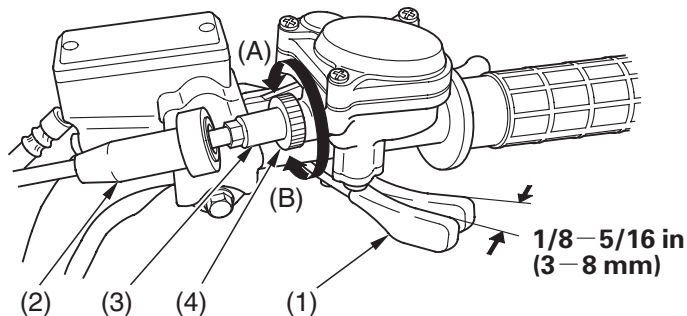

(2) (3) (4) (1)

- |                             |                       |
|-----------------------------|-----------------------|
| (1) throttle lever          | (4) lock nut          |
| (2) rubber sleeve           | (A) decrease freeplay |
| (3) throttle cable adjuster | (B) increase freeplay |

1/8 - 5/16 in  
(3 - 8 mm)

### Inspection

Check freeplay at the throttle lever (1).

Freeplay:

1/8 - 5/16 in (3 - 8 mm)

### Adjustment

1. Slide the rubber sleeve (2) back to expose the throttle cable adjuster (3).
2. Loosen the lock nut (4).
3. Turn the adjuster to obtain the correct freeplay.
4. Tighten the lock nut and reinstall the sleeve.
5. After adjustment, check for smooth operation of the throttle lever from fully closed to fully open in all steering positions.



# Throttle

---

## Throttle Inspection

Refer to *Safety Precautions* on page 89.

1. Check that the throttle assembly is positioned properly and the securing bolts are tight.
2. Check for smooth operation of the throttle lever from fully open to fully closed in all steering positions. If there is a problem, see your dealer.
3. Inspect the condition of the throttle cable from the throttle lever down to the throttle body. If the cable is kinked or chafed, have it replaced.
4. Check the throttle cable for tension or stress in all steering positions.
5. Lubricate the throttle cable with a commercially available cable lubricant to prevent premature wear and corrosion.





## Clutch System

Your ATV's shift-activated, wet, multiplate clutch is part of the primary drive system. Proper adjustment allows a smooth, gradual engagement when shifting gears.

### Clutch Adjustment

Refer to *Safety Precautions* on page 89.

LEFT FRONT

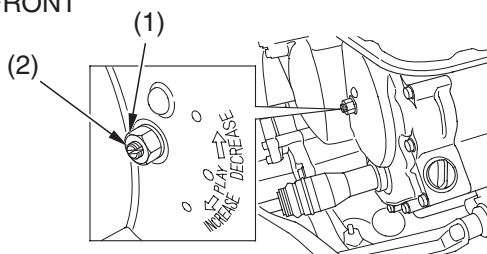

(1) lock nut

(2) clutch adjuster

1. Make sure the engine is cool.
2. Make sure the ignition switch is OFF (  $\circ$  ).
3. Remove the seat (page 100) and left side cover (page 108).
4. Loosen the lock nut (1).
5. Turn the clutch adjuster (2) counterclockwise until you feel slight resistance.
6. Turn the adjuster 1/4 turn clockwise, then tighten the lock nut to hold the adjuster in this position.
7. After adjustment, start the engine and test ride your ATV to be sure the clutch is operating properly.
8. Install the removed parts in reverse order of removal.

If you cannot get proper adjustment, or the clutch does not work properly, the clutch friction discs may be worn. See your dealer or refer to official Honda Service Manual (page 224).



## Reverse Lock System

### Reverse Lock System Adjustment

Refer to *Safety Precautions* on page 89.

#### LEFT HANDLEBAR

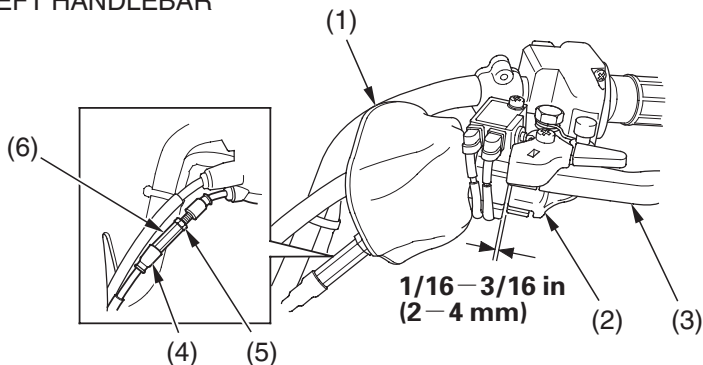

- |                          |                   |
|--------------------------|-------------------|
| (1) dust cover           | (4) rubber sleeve |
| (2) reverse assist lever | (5) lock nut      |
| (3) rear brake lever     | (6) adjusting nut |

1. Turn over the dust cover (1).
2. Check the reverse assist lever (2) freeplay, measured at the rear brake lever (3) end near the cable:  
 $1/16 - 3/16$  in (2 - 4 mm)
3. To adjust, slide the rubber sleeve (4), loosen the lock nut (5) and turn the adjusting nut (6).  
After adjustment, tighten the lock nut securely.
4. Return the dust cover and rubber sleeve.

#### Other Checks

Check the reverse assist lever and cable for loose connections or other damage. If the cable is worn or kinked, have it replaced by your dealer.

### 134 Servicing Your Honda



# Spark Plug

## Spark Plug Recommendation

standard spark plug	BKR5E-11 (NGK) or K16PR-U11 (DENSO)
---------------------	--

Use only the recommended type of spark plug in the recommended heat range.

### NOTICE

*Using spark plugs with an improper heat range can cause engine damage.*

## Spark Plug Inspection & Replacement

Refer to *Safety Precautions* on page 89.

1. Remove the seat (page 100) and left side cover (page 108).
2. Remove the left tank side cover (1) by removing the bolts (2).

LEFT SIDE

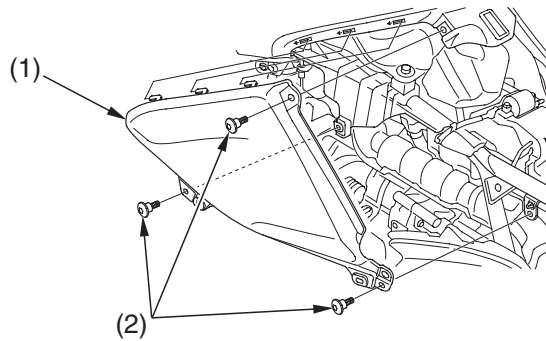

(1) left tank side cover

(2) bolts

(cont'd)



## Spark Plug

3. Clean any dirt from around the spark plug base.
4. Disconnect the spark plug cap (3). Take care to avoid damaging the spark plug wire when disconnecting the cap.
5. Using a spark plug wrench provided in the tool kit, remove the spark plug.
6. Inspect the electrodes and center porcelain for deposits, corrosion, or carbon fouling. If the corrosion or deposits are heavy, replace the plug. Clean a carbon or wet-fouled plug with a plug cleaner, if available, or a wire brush. Inspect the spark plug electrodes for wear. The center electrode (4) should have a flat tip and sharp edges, and the side electrode (5) should not be eroded. If the electrodes and insulator tip appear unusually fouled or burned, we suggest that you contact your dealer.
7. Discard the spark plug if there is apparent wear or if the insulator is cracked or chipped.
8. Using a wire-type feeler gauge, check the spark plug gap (6). If adjustment is necessary, bend the side electrode carefully.  
The gap should be:  
**0.039–0.043 in (1.00–1.10 mm)**

### LEFT SIDE

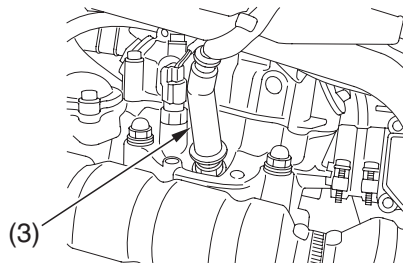

- (3) spark plug cap  
(4) center electrode

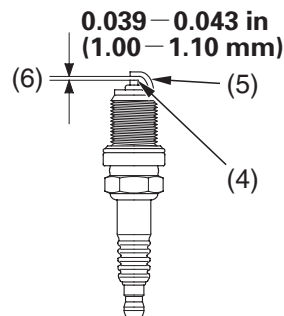

- (5) side electrode  
(6) spark plug gap





## Spark Plug

9. With the plug washer attached, thread the spark plug in by hand to prevent cross-threading.
10. Tighten the spark plug:
  - If the old plug is good:
    - 1/8 turn after it seats.
  - If installing a new plug, tighten it twice to prevent loosening:
    - a) First, tighten the plug:
      - NGK: 3/4 turn after it seats.
      - DENSO: 1/2 turn after it seats.
    - b) Then loosen the plug.
    - c) Next, tighten the plug again:
      - 1/8 turn after it seats.

### NOTICE

*An improperly tightened spark plug can damage the engine. If a plug is too loose, a piston may be damaged. If a plug is too tight, the threads may be damaged.*

11. Connect the spark plug cap. Take care to avoid pinching any cables or wires.
12. Install the remaining parts in the reverse order of removal.



## Valves

---

### Valve Inspection

Refer to *Safety Precautions* on page 89.

Valve clearance should be:

intake: 0.006 in (0.15 mm)

exhaust: 0.009 in (0.23 mm)

Excessive clearance will cause noise. Insufficient clearance will cause loss of power and possibly damage the valves.

For those who are mechanically proficient and have the proper tools, instructions on adjusting valve clearances are given in the official Honda Service Manual. Otherwise, the valves should be adjusted by your dealer.

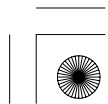
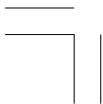



## Spark Arrester

Refer to *Safety Precautions* on page 89 .

The spark arrester must be serviced every 100 operating hours to maintain its efficiency.

Regular servicing prevents carbon build up (which can diminish engine performance) and also complies with USDA regulations for regular maintenance to assure proper function. The spark arrester prevents random sparks from the combustion process in your engine from reaching the environment.

The use of safety glasses is recommended for this procedure.

Because of the possible fire hazard, check that there are no combustible materials in the area before purging the spark arrester.

REAR

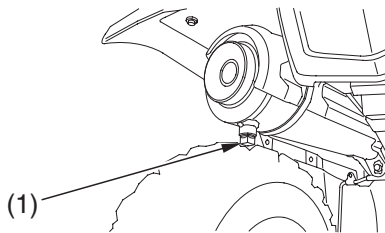

(1) bolt

1. Select a well-ventilated area free of combustible materials and make sure the exhaust pipe is cool.
2. Remove the bolt ( 1 ).
3. Start the engine and rev it up approximately twenty times while momentarily creating exhaust system back pressure by blocking the end of the muffler with a shop towel.
4. Stop the engine and allow the exhaust pipe to cool.
5. Reinstall the bolt securely.



## Suspension

---

Your front and rear suspension systems use springs and hydraulic damping devices that suspend your weight and most of the weight of your ATV.

The oil damper systems hydraulically control the natural compression and rebound of the suspension springs so that traction and comfort are maintained as the wheels ride over rough terrain.

(Except TRX420TM)

The spring pre-loads for your front and rear suspension systems adjust the amount of force required to begin compression of the spring.

Consider adjusting your suspensions pre-load whenever you change your normal load, by adding or subtracting cargo, accessories, or when riding conditions change.

The way you ride your ATV and the type of ride you want to experience can also influence your suspension needs.

Lower spring pre-load provides a softer ride and is usually preferred for light loads and smooth terrain. Higher spring pre-load provides a firmer ride and is recommended for heavy loads and rough terrain.

### Suspension Adjustment (Except TRX420TM)

Using a pin spanner, which is available from your dealer, the suspension can be adjusted for rider weight and riding conditions by changing the spring pre-load.

Do not attempt to disassemble, service, or dispose of the damper; see your dealer. The instructions found in this owner's manual are limited to adjustments of the shock assembly only.

## 140 Servicing Your Honda





# Suspension

## Suspension Spring Pre-Load (Except TRX420TM)

Refer to *Safety Precautions* on page 89 .

FRONT

REAR

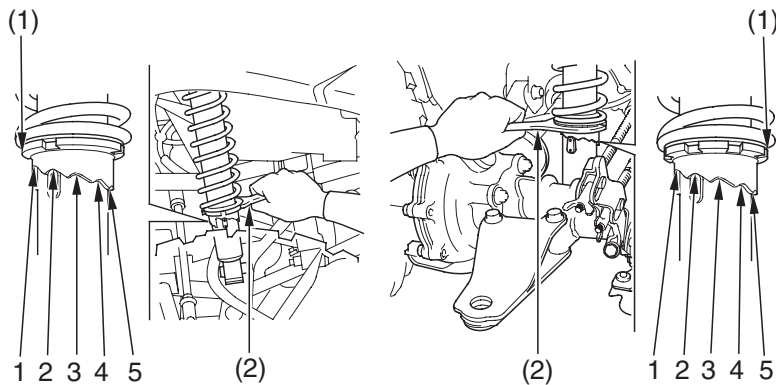

- (1) spring pre-load adjuster
- (2) pin spanner

The spring pre-load adjuster (1) has 5 positions for different load or riding conditions.

Use the pin spanner (2) to adjust the shock spring pre-load.





## Suspension

---

Position 1: for a light load and smooth terrain.

Position 2: standard position.

Positions 3 to 5: for when the ATV is more heavily loaded. (Also increase spring pre-load for stiffer suspension.)

Make sure that both front shock absorbers are adjusted to the same position.

Always adjust the shock absorber position in sequence (1-2-3-4-5 or 5-4-3-2-1). Attempting to adjust directly from 1 to 5 or 5 to 1 may damage the shock absorber.

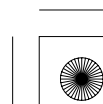
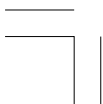



## Brakes

The hydraulic disc brakes (front) and single mechanical drum brake (rear) on your ATV dissipate heat generated by the friction of the brake pads on the disc (front) and the brake shoes on the drums (rear) as the wheels are slowed.

### Hydraulic Disc Front Brake

As the front brake pads wear, brake fluid level will drop. A leak in the system will also cause the level to drop.

There are no adjustments to perform, but fluid level and pad wear must be inspected periodically. The system must be inspected frequently to ensure there are no fluid leaks.

If the right brake lever freeplay does not feel within the normal range while riding, check the brake pads for wear (page 146).

Worn pads should be replaced. If the pads are not worn beyond the recommended limit, there is probably air in the brake system. See your dealer to have the air bled from the system.

### Mechanical Drum Rear Brake

If the rear brake lever/parking brake lever or brake pedal freeplay does not feel within the normal range while riding, check the brake shoes for wear (page 151).

### **Brake Fluid Recommendation**

brake fluid	Honda DOT 4 Brake Fluid
-------------	-------------------------

The recommended brake fluid is Honda DOT 4 Brake Fluid, or any brake fluid of equal quality and performance. Use fresh brake fluid from a sealed container. Be sure to read the label before opening the sealed container. An opened container may be contaminated or may have absorbed moisture from the air.



# Brakes

## Fluid Level Inspection

Refer to *Safety Precautions* on page 89 .

If your inspection indicates a low fluid level, have your dealer add the recommended fluid.

Do not add or replace brake fluid, except in an emergency. If you do add fluid, have your dealer check the system as soon as possible.

### NOTICE

*Brake fluid can damage plastic and painted surfaces. Handle with care.*

Wipe up spills immediately. Avoid brake fluid contact with skin or eyes. If it comes in contact with your eyes, wash them out with clean water and immediately call a doctor. If it comes in contact with your skin, wash with clean water and, if necessary, call a doctor.

### RIGHT HANDLEBAR

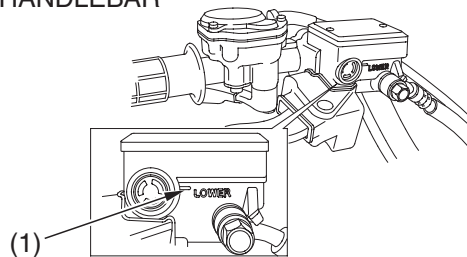

(1) LOWER level mark

With the ATV in an upright position, check the fluid level. It should be above the LOWER level mark ( 1 ). If the level is at or below the LOWER level mark, check the brake pads for wear (page 146).

## 144 Servicing Your Honda





## Brakes

Worn brake pads should be replaced. If the pads are not worn, have your brake system inspected for leaks.

### Other Inspections

- Make sure there are no fluid leaks.
- Check for deterioration or cracks in the hoses and fittings. If the hoses are worn or cracked, have them replaced by your dealer.

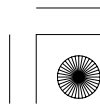



# Brakes

## Brake Pad Wear

Refer to *Safety Precautions* on page 89 .

Brake pad wear will depend upon the severity of usage and riding conditions. The pads will wear faster in wet or muddy conditions. Inspect the pads visually during all regular service intervals to determine the pad wear.

RIGHT FRONT (Left side similar)

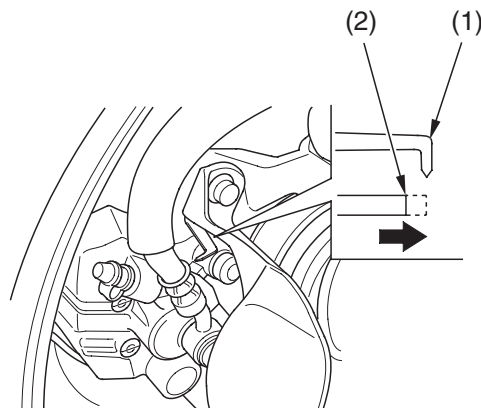

(1) wear indicator

(2) edge of reference mark

Check the wear indicator ( 1 ). If the wear indicator aligns with the edge of the reference mark ( 2 ), both pads must be replaced, see your dealer for this replacement.

Always inspect both pads in both the right and left front brake calipers.

## 146 Servicing Your Honda



## Brakes

### Rear Brake Pedal Freeplay

RIGHT SIDE

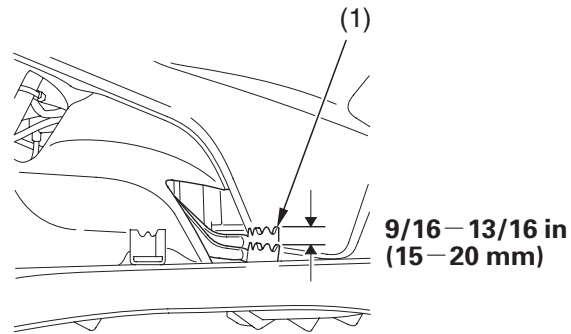

(1) rear brake pedal

#### Inspection

Measure the distance the rear brake pedal (1) moves before the brake starts to take hold. Freeplay, measurement at the tip of the end of the pedal, should be:

9/16 – 13/16 in (15 – 20 mm)

If necessary, adjust to the specified range.



# Brakes

## Adjustment

### RIGHT REAR

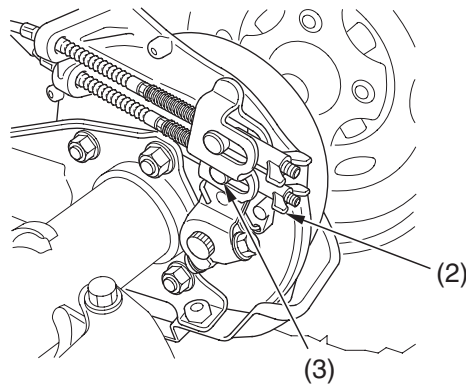

- (2) brake pedal adjusting nut
- (3) brake arm pin

1. Turn the brake pedal adjusting nut (2), located on the brake operating rod at the rear of the frame. Make sure the cutout on the adjusting nut is properly seated on the brake arm pin (3).
2. Adjust the freeplay of the rear brake pedal. Push the brake arm (4), then check the clearance between the brake arm and the brake arm pin.

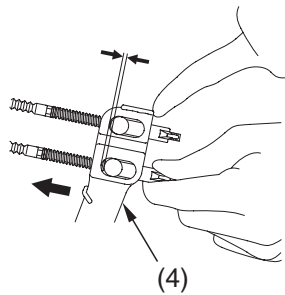

- (4) brake arm



## Brakes

### Rear Brake Lever Freeplay

#### LEFT HANDLEBAR

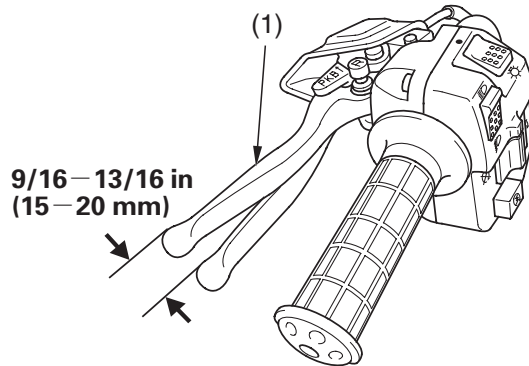

(1) rear brake lever/parking brake lever

#### Inspection

Measure the distance the rear brake lever/parking brake lever (1) moves before the brake starts to take hold. Freeplay (measurement at the tip of the end of the brake lever) should be:

9/16 – 13/16 in (15 – 20 mm)

If necessary, adjust to the specified range.



# Brakes

## Adjustment

### RIGHT REAR

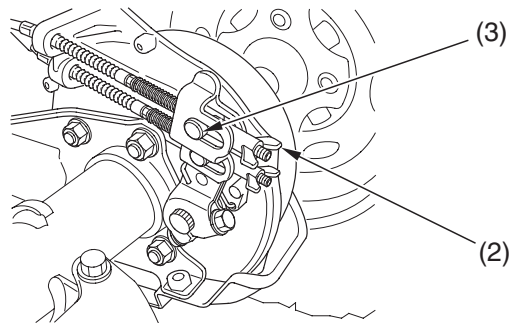

- (2) brake lever adjusting nut
- (3) brake arm pin

Adjust the freeplay of the rear brake lever/parking brake lever with the front wheels pointed straight ahead.

1. Turn the brake lever adjusting nut (2), located on the brake operating rod at the rear of the frame. Make sure the cutout on the adjusting nut is properly seated on the brake arm pin (3).
2. Adjust the freeplay of the rear brake lever/parking brake lever. Push the brake arm (4) then check the clearance between the brake arm and the brake arm pin.

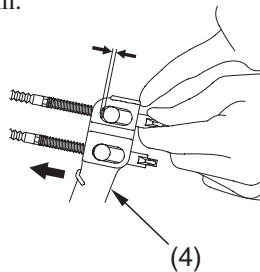

- (4) brake arm



## Brakes

### Other Inspections

- Check that the brake lever and brake pedal assemblies are positioned properly and the securing bolts are tight.
- Make sure that the brake cables, brake arm, spring, parking, and fasteners are in good condition.

### Brake Shoe Wear

Refer to *Safety Precautions* on page 89 .

The rear brake is equipped with an external brake wear indicator that lets you check brake wear without disassembly. Application of the brake control causes the arrow on the brake arm to move toward a reference mark on the brake panel.

#### RIGHT REAR

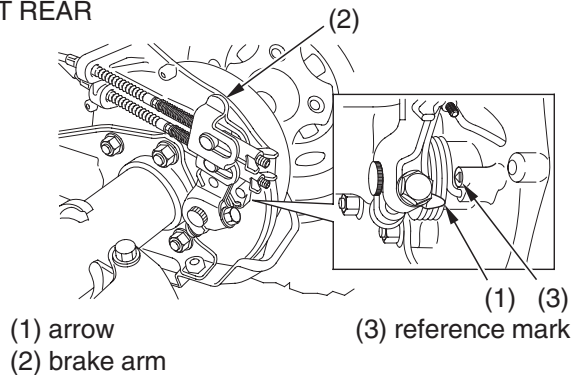

1. Apply the brake control and check the movement of the arrow (1) on the brake arm (2).
2. Replace the brake shoe if the arrow aligns with the reference mark (3) on the brake panel upon full application of the brake. If replacement is necessary, see your dealer.



# Brakes

## Brake Light Switch Adjustment

Refer to *Safety Precautions* on page 89 .

### Rear Brake Only:

Check the operation of the rear brake light switch (1) at the right side behind the engine from time to time. Adjustment is done by turning the adjusting nut (2). Turn the nut in direction (A) if the switch operates too late and in direction (B) if the switch operates too soon.

### RIGHT SIDE

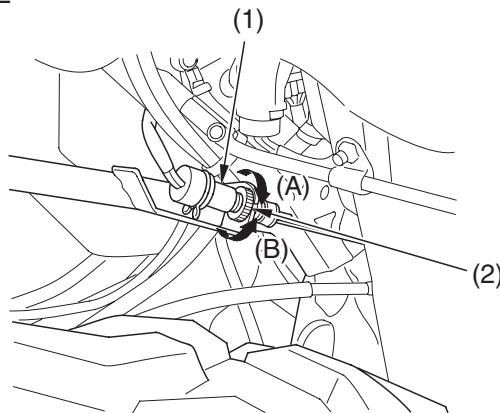

- (1) rear brake light switch
- (2) adjusting nut







## Brakes

### Draining Water from Brakes

Refer to *Safety Precautions* on page 89 .

#### RIGHT REAR

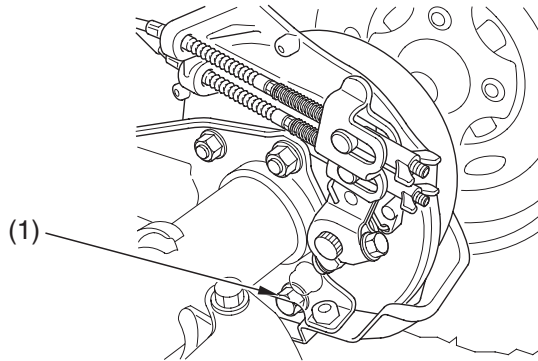

(1) rear brake drain bolt

1. Make sure the engine is OFF and the parking brake is set.
2. Remove the rear brake drain bolt ( 1 ) from the bottom of the rear brake panel.  
If any water drains, the brake seals must be replaced by your dealer as soon as possible.
3. Install the rear brake drain bolt and tighten it to the specified torque:  
**9 lbf·ft (12 N·m , 1.2 kgf·m)**



## Tires

---

To safely operate your ATV, your tires must be the proper type and size, in good condition with adequate tread, and correctly inflated.

### **WARNING**

Using tires that are excessively worn or improperly inflated can cause a crash in which you can be seriously hurt or killed.

Follow all instructions in this owner's manual regarding tire inflation and maintenance.

This ATV is equipped with low pressure tubeless tires. Although the tires are designed specifically for off-road use, they are not immune to punctures. Always select your riding area with care.

The following pages give detailed information on how and when to check your air pressure, how to inspect your tires for wear and damage, and our recommendations for tire repair and replacement.





## Tires

### Air Pressure

Refer to *Safety Precautions* on page 89 .

Properly inflated tires provide the best combination of handling, tread life, and riding comfort. Generally, underinflated tires wear unevenly, adversely affect handling, and are more likely to fail from being overheated. Overinflated tires make your ATV ride harshly, are more prone to damage from surface hazards, and wear unevenly.

Make sure the air valve caps are secure. If necessary, install new caps.

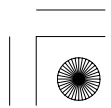
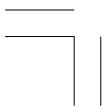



## Tires

Always check air pressure when your tires are “cold.” If you check air pressure when your tires are “warm” — even if your ATV has only been ridden for a few miles — the readings will be higher. If you let air out of warm tires to match the recommended cold tire pressures, the tires will be underinflated. Be sure to check tire pressure at the riding site, since changes in altitude can affect air pressure.

The recommended “cold” tire pressures are:

### (TRX420TM/FM)

	FRONT	REAR
RECOMMENDED PRESSURE	3.6 psi (25.0 kPa)	3.6 psi (25.0 kPa)

### (TRX420FPM)

	FRONT	REAR
RECOMMENDED PRESSURE	4.4 psi (30.0 kPa)	3.6 psi (25.0 kPa)





## Tires

A manually operated tire pump should be used rather than the high pressure system found in service stations. This will minimize the possibility of tire damage from overinflation. If you use a high pressure system at a service station, add air in small amounts and check the pressure increase frequently to prevent possible tire damage from overinflation.

### **WARNING**

Operating this ATV with improper tires, or with uneven tire pressure may cause loss of control, and you could be seriously injured or killed.

- Always use the size and type tires specified in this owner's manual for this vehicle.
- Always maintain proper tire pressure as described in this owner's manual.

### Inspection

Refer to *Safety Precautions* on page 89 .

Whenever you check the tire pressures, you should also look for:

- Bumps or bulges in the side of the tire or the tread. Replace any tire that has a bump or bulge.
- Cuts, slits, or cracks in the tires. Replace the tire if you can see fabric or cord.
- Nails or other foreign objects embedded in the side of the tire or tread.
- Excessive tread wear.



# Tires

Also, if you hit a pothole or other hard object while riding, stop as soon as you safely can and carefully inspect the tires for damage.

## Tread Wear

FRONT

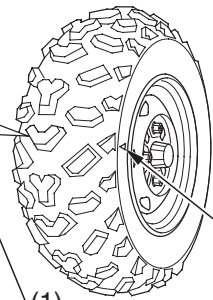
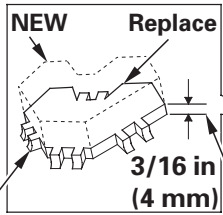

(2)

REAR

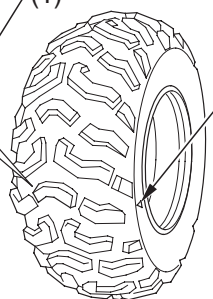
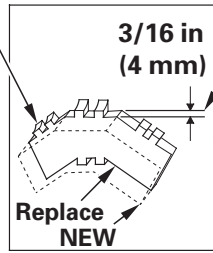

(1)

(3)

(1) groove depth  
(2) wear indicator

(3) wear indicator location mark

To check the condition of a tire tread, measure the groove depth (1) in the center of the tire, or check the wear indicator (2).

For best performance, you should replace a tire before the tread depth at the center reaches the following limits:

front	3/16 in (4 mm)
rear	3/16 in (4 mm)

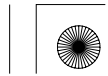



## Tires

### Tire Repair

Refer to *Safety Precautions* on page 89 .

A tire that is repaired, either temporarily or permanently, will have lower speed and performance limits than a new or undamaged tire.

A temporary repair can sometimes be made in an emergency situation. However, since a temporary repair may not hold, you must ride very slowly, preferably without any cargo, and have the tire replaced or permanently repaired as soon as possible. (For more information on temporary repairs, see *If You Have a Flat Tire*, page 191 .)

A permanent repair, such as an internal plug patch, can be made if a tire has only a small puncture in the tread area. However you may not be able to safely carry as much weight. If you choose to have a tire repaired, be sure the repair work is performed by a professional.

If you have a tire professionally repaired at a non-Honda facility, we recommend that you have the work checked by your dealer.



# Tires

## Tire Replacement

Refer to *Safety Precautions* on page 89 .

The tires that came on your ATV were designed to match the performance capabilities of your ATV and provide the best combination of handling, braking, and comfort.

It is best to replace all four tires, however if that is not possible, you must replace the tires in pairs (front or rear) with tires of the same size and type as the originals. Never replace just one tire.

### **WARNING**

Installing improper tires on your ATV can affect handling and stability. This can cause a crash in which you can be seriously hurt or killed.

Always use the size and type of tires recommended in this owner's manual.



The recommended tires for your ATV are:

front	AT24 × 8-12 ★★	MAXXIS M977
rear	AT24 × 10-11 ★★	MAXXIS M978

When you replace a tire, remember:

Have the tire replaced by your dealer if possible.

If you have a tire professionally replaced at a non-Honda facility, we recommended that you have the work checked by your dealer.

## 160 Servicing Your Honda

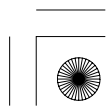
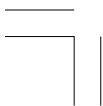





## Guards

### Skid Plate & Engine Guard

Refer to *Safety Precautions* on page 89 .

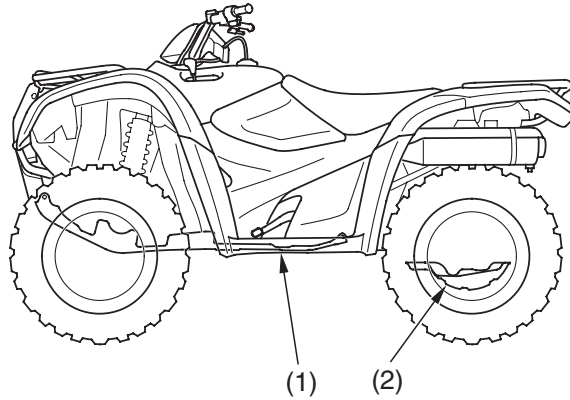

(1) engine guard

(2) skid plate

The engine guard (1) protects the frame and engine crankcase. The skid plate (2) protects the rear final gear case. Check the guard and plate for cracks, damage or looseness at intervals shown in the Maintenance Schedule.

Have the engine guard and skid plate replaced if they are cracked or damaged. If the guard and plate bolts are loose, tighten them securely.



## Guards

### Front Boot Guards & Front Driveshaft Guards (Except TRX420TM)

Refer to *Safety Precautions* on page 89.

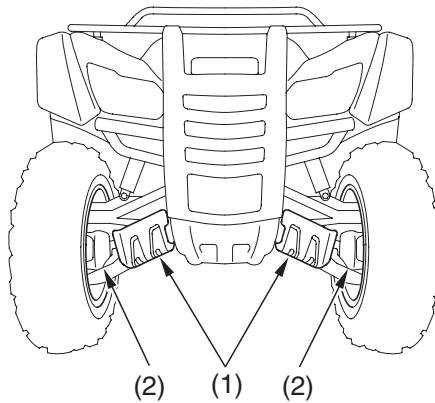

(1) front boot guards

(2) front driveshaft guards

Check the front boot guards (1) and front driveshaft guards (2) for cracks, damage or looseness.

Tighten any loose fasteners. Replace the front boot guards and front driveshaft guards as required.



## Drivetrain Boots

### Propeller Shaft Boots & Yoke Joint Boot

Refer to *Safety Precautions* on page 89 .

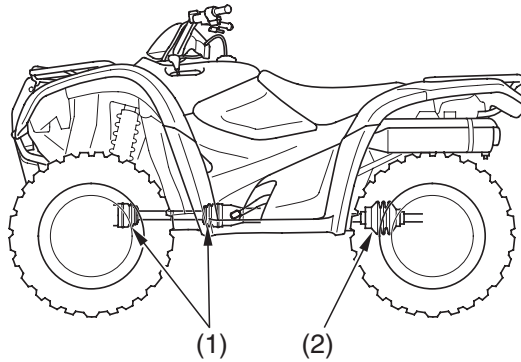

- (1) rubber propeller shaft boots (Except TRX420TM)
- (2) rubber yoke joint boot

Check the rubber propeller shaft boots (1) and rubber yoke joint boot (2) for damage or leaking grease. If necessary, have your dealer replace them.



## Drivetrain Boots

---

### Front Driveshaft Boots (Except TRX420TM)

Refer to *Safety Precautions* on page 89 .

FRONT

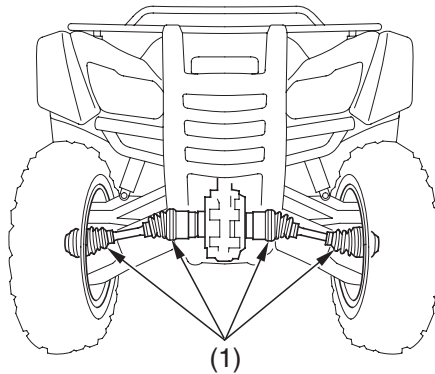

(1) rubber driveshaft boots

Check the rubber driveshaft boots (1) for cuts, damage or leaking grease. If necessary, have your dealer replace them.



## Battery

Your ATV has a maintenance-free type battery. You do not have to check the battery electrolyte level or add distilled water as you would with a conventional-type battery.

### NOTICE

*Your battery is a maintenance-free type and can be permanently damaged if the cap strip is removed.*

Electrical accessories use current from the battery, even when the ignition is OFF. Limited operation also allows the battery to discharge. If you have electrical accessories on your ATV or do not ride frequently, we recommend that you charge the battery frequently (see *Battery Charging*, page 169).

If you do not expect to ride your ATV for at least two weeks, we recommend you remove the battery, or at least disconnect the battery cables (negative cable first).

If you plan to store your ATV, see *Battery Storage*, page 166.

If your battery seems weak and/or is leaking electrolyte (causing slow starting or other electrical problems), see your dealer.

**WARNING:** Battery posts, terminals and related accessories contain lead and lead compounds. **Wash your hands after handling.**



# Battery

---

## Battery Storage

Refer to *Safety Precautions* on page 89 .

If you plan to store your ATV, we recommend you remove the battery and store it where it can be charged at least every 30 days to maintain its service life.

If you do not remove the battery, we recommend disconnecting the battery cables (negative cable first).

You will get the best storage results from removing the battery and slow charging it every 30 days (see *Battery Charging*, page 169 ).

Before you remove the battery, be sure to read all the information that follows, as well as the information on the battery label.



### **WARNING**

The battery gives off explosive hydrogen gas during normal operation.

A spark or flame can cause the battery to explode with enough force to kill or seriously hurt you.

Wear protective clothing and a face shield, or have a skilled mechanic do the battery maintenance.

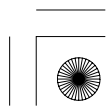
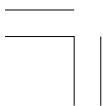



## Battery

The battery is located in a compartment under the rear fender cover.

### UNDER REAR FENDER COVER

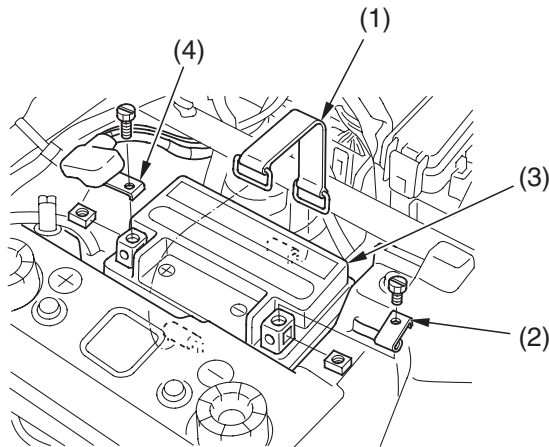

- |                                |                                |
|--------------------------------|--------------------------------|
| (1) rubber band                | (3) battery                    |
| (2) negative (-) terminal lead | (4) positive (+) terminal lead |

### Removal

1. Make sure the ignition switch is OFF (  $\circ$  ).
2. Remove the seat (page 100).
3. Remove the rear fender cover (page 121).
4. Release the rings and remove the rubber band (1).
5. Disconnect the negative (-) terminal lead (2) from the battery (3) first, then disconnect the positive (+) terminal lead (4).

(cont'd)



## Battery

---

6. Remove the battery.
7. Charge the battery (see following section).
8. Store your battery in an easy-to-reach location off the floor, in an area protected from freezing temperature and direct sunlight.
9. Clean the compartment after removing the battery for storage. Dry the compartment and, if paint is missing, re-paint the area.
10. Slow charge the battery (see following section) once every 30 days.

### Installation

1. Check that the battery band (5) for damage. If necessary, replace the battery band.
2. Make sure the battery band is properly position.
3. Reinstall in the reverse order of removal.  
Be sure to connect the positive (+) terminal first, then the negative (-) terminal.
4. Make sure all bolts and other fasteners are secure.

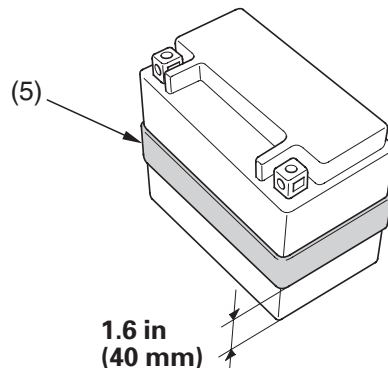

(5) battery band





## Battery

### Battery Charging

Refer to *Safety Precautions* on page 89 .

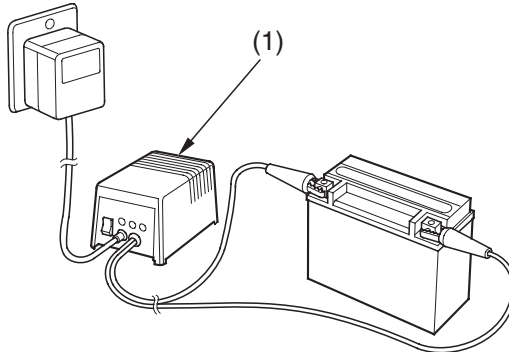

(1) charger

Be sure to read the information that came with your battery charger and follow the instructions on the battery. Improper charging may damage the battery.

We recommend using a charger (1) designed specifically for your Honda, which can be purchased from your dealer. These units can be left connected for long periods without risking damage to the battery. However, do not intentionally leave the charger connected longer than the time period recommended in the charger's instructions. Avoid using an automotive-type battery charger. An automotive charger can overheat an ATV battery and cause premature damage.



## Appearance Care

---

Frequent cleaning and polishing will keep your Honda looking newer longer.

Frequent cleaning also identifies you as an owner who values his ATV. A clean ATV is also easier to inspect and service.

### General Recommendations

Refer to *Safety Precautions* on page 89 .

- To clean your ATV, you may use:
  - water
  - a mild, neutral detergent and water
  - a mild spray and wipe cleaner/polisher
  - a mild spray and rinse cleaner/degreaser and water
- Avoid products that contain harsh detergents or chemical solvents that could damage the metal, paint, and plastic on your ATV.
- If your ATV is still warm from recent operation, give the engine and exhaust system time to cool off.
- Park in a shady area. Washing your ATV in bright sunlight may cause the finish to fade because water droplets intensify the sun's brightness.
- Spotting is also more likely because surface water can dry before you have time to wipe it off.
- Clean your ATV regularly to protect surface finishes.
- We recommend the use of a garden hose to wash your ATV. High pressure washers (like those at coin-operated car washers) can damage certain parts of your ATV.

### NOTICE

*High pressure water (or air) can damage certain parts of your ATV.*

- After cleaning, inspect for damage, wear, and leaks (fuel, oil, coolant and brake fluid).

## 170 Servicing Your Honda

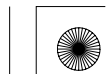



## Appearance Care

### Washing Your ATV with a Mild Detergent

Refer to *Safety Precautions* on page 89.

1. Rinse your ATV thoroughly with cool water to remove loose dirt.
2. Fill a bucket with cool water. Mix in a mild, neutral detergent, such as dish washing liquid or a product made especially for washing motorcycles or automobiles.
3. Wash your ATV with a sponge or soft towel. As you wash, check for heavy grime. If necessary, use a mild cleaner/degreaser to remove the grime.
4. After washing, rinse your ATV thoroughly with plenty of clean water to remove any residue. Detergent residue can corrode alloy parts.
5. Dry your ATV with a chamois or a soft towel. Leaving water on the surface to air dry can cause dulling and water spots. As you dry, inspect for chips and scratches.
6. Start the engine and let it idle for several minutes. The engine heat will help dry moist areas.
7. As a precaution, ride your ATV at a slow speed and apply the brakes several times. This will help dry the brakes and restore normal braking performance.





## Appearance Care

### Spray Cleaning Your ATV

Refer to *Safety Precautions* on page 89 .

Avoid using spray cleaner products on the tires or suspension components.

Suggestions for using spray cleaner(s) follow:

ATV condition	Recommended Cleaning
Dust and fingerprint smudges.	Apply a spray cleaner/polish and wipe paint, chrome, glass, and clear plastic.
Light road grimes.	Spray any difficult-to-reach or very dirty areas with a spray cleaner/degreaser. Rinse and dry. Apply a spray cleaner/polish and wipe with a non-abrasive cloth.
Heavy grime. Oil leaks. Brake dust.	Use a spray cleaner/degreaser. If necessary, rub with a sponge. Rinse and dry. Apply a spray cleaner/polish and wipe with a non-abrasive cloth.
Dull, corroded chrome or aluminum.	Apply a high quality chrome/aluminum polish and wipe with a non-abrasive cloth.





## Appearance Care

### Finishing Touches

Refer to *Safety Precautions* on page 89 .

After washing your ATV, consider using a commercially available spray cleaner/polish or quality liquid or paste wax to finish the job. Use only a non-abrasive polish or wax made specifically for motorcycles or automobiles. Apply the polish or wax according to the instructions on the container.

If a surface on your ATV is chipped or scratched, your dealer has touch-up paint to match your ATV's color. Be sure to use your ATV's color code (page 209 ) when you buy touch-up paint.



If the frame has a chip that exposes the metal, first apply primer (to prevent corrosion) and then apply the touch-up paint. Several thin layers of touch-up paint are better than one thick coat.



### Exhaust Pipe and Muffler Maintenance

The exhaust pipe and muffler are stainless steel but may become stained by mud or dust.

To remove mud or dust, use a wet sponge and a liquid kitchen abrasive, then rinse well with clean water. Dry with chamois or a soft towel.

If necessary, remove heat stains by using a commercially available fine texture compound. Then rinse by the same manner as removing mud or dust.

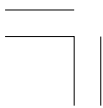



11/05/09 13:23:50 31HP4650 0183



**174 Servicing Your Honda**

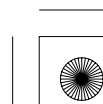
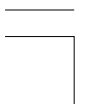



## Tips

Here's helpful advice on how to prepare for an off-road adventure, how to transport and store your Honda, and how to be an environmentally responsible ATV owner.

Preparing for a Ride .....	176
What to Take to the Riding Area .....	176
What to Take on the Trail .....	177
Transporting Your Honda .....	178
Storing Your Honda .....	180
Preparation for Storage .....	181
Removal from Storage .....	183
You & the Environment .....	184

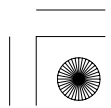
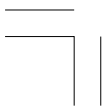



## Preparing for a Ride

---

A safe and enjoyable ride begins with good planning and preparation. Always ride with at least one other person in case you have trouble, and let someone know where you're going and when you expect to return.

Before riding in an unfamiliar area, find out in advance if you need special permits, get maps so you can study the terrain, and talk to other riders who know the area. The Forest Service and the Bureau of Land Management, riding clubs, and off-road magazines are good sources of information.

### What to Take to the Riding Area

Along with your ATV and riding gear, you should take along some tools and supplies in case you have a problem. For some of the difficulties you might encounter, see *Taking Care of the Unexpected*, which begins on page 185.

We recommend that you always take water, food, a first aid kit, and your owner's manual. Other items you should consider loading on your truck or trailer include:

- a tool kit
- tire repair supplies and tools, and tires
- extra parts, control levers, cables, and spark plugs
- wire, duct tape, and rope
- extra gasoline

For safety, all refueling should be done at a gas station on the way to the riding area or at your base camp.

### 176 Tips







## Preparing for a Ride

---

### What to Take on the Trail

What you take with you during a ride depends on the kind of terrain, how long you expect to ride, how far you might go from your base camp or help, and how experienced you or your companions are in making repairs.

If you decide to take some tools, spare parts, or other supplies on the trail, be sure you can carry them safely and know how to use them. Also, be sure to follow the loading guidelines and weight limit (page 48).

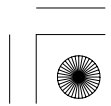



## Transporting Your Honda

---

Do not tow your ATV behind a car or other vehicle.

When you transport your ATV, we recommend that you carry the vehicle in its normal operating position (on all four wheels). Do not incline the vehicle upright on its rear end. This can damage the vehicle, and leaking gasoline could be a hazard.

Follow these procedures:

1. Set the parking brake and place the transmission in gear.
2. Turn the fuel valve OFF.

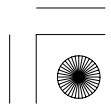



## Transporting Your Honda

- Secure the vehicle with tie-down straps in the areas shown.
  - Suitable tie-down straps are available from your dealer.
  - Ordinary rope is not recommended because it can stretch under load.
  - Using tie-down straps in any other areas can damage your ATV.
- Rock the vehicle back and forth to make sure the tie-down straps are tight and the vehicle is secure.

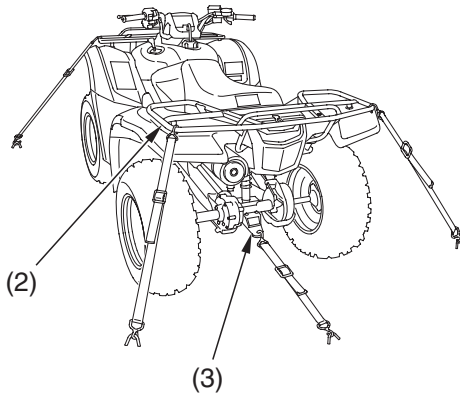
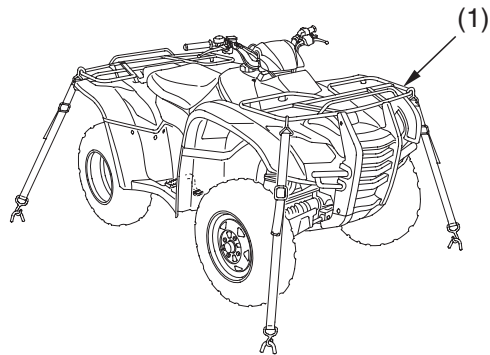

(1) front cargo rack  
(2) rear cargo rack

(3) trailer hitch

**Tips 179**



## Storing Your Honda

---

If you won't be riding for an extended period, such as during the winter, thoroughly inspect your ATV and correct any problem before storing it. That way, needed repairs won't be forgotten and it will be easier to get your ATV running again.

For more information about storage, refer to the *Honda Winter Storage Guide*, available from your dealer.

We suggest you perform the following procedures to keep your ATV in top condition. These storage procedures will reduce the deterioration that can occur during storage.

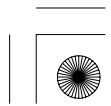



## Storing Your Honda

### Preparation for Storage

Refer to *Safety Precautions* on page 89.

1. Change the engine oil and filter (page 110).
2. Make sure the cooling system is filled with a 50/50% antifreeze solution (page 119).
3. Fill the fuel tank. Make sure the fuel fill cap is properly installed.
4. Check that the fuel valve is OFF.
5. To prevent rusting in the cylinder, perform the following:
  - Remove the spark plug cap from the spark plug.
  - Remove the spark plug.  
Do not connect the spark plug to the spark plug cap.
  - Pour a tablespoon (15–20 cc) of clean engine oil into the cylinder and cover the spark plug hole with a piece of cloth.
  - With the engine stop switch in the RUN (  ) position, press the start button several times to crank the engine and distribute the oil.
  - Reinstall the spark plug and spark plug cap.

(cont'd)

**Tips 181**



## Storing Your Honda

---

6. Remove the battery and charge it fully. Store it in an area protected from freezing temperatures and direct sunlight. Slow charge the battery (page 169) once a month.

### **WARNING**

The battery gives off explosive hydrogen gas during normal operation.

A spark or flame can cause the battery to explode with enough force to kill or seriously hurt you.

Wear protective clothing and a face shield, or have a skilled mechanic do the battery maintenance.



7. Wash and dry your ATV. Wax all painted surfaces.
8. Inflate the tires to their recommended pressures (page 156).
9. Store your ATV in an unheated area, free of dampness, away from sunlight, with a minimum of daily temperature variation.
10. Place your ATV on blocks to lift all tires off the floor.
11. Cover your ATV with a porous material. Avoid using plastic or similar non-breathing, coated materials that restrict air flow and allow heat and moisture to accumulate.





## Storing Your Honda

### Removal from Storage

Refer to *Safety Precautions* on page 89 .

1. Uncover and clean your ATV.
2. If your ATV has been stored for more than four months — change the engine oil (page 110 ).
3. If your ATV has been stored for more than two months — ask your dealer to drain and replace the fuel.
4. Charge the battery (page 169 ) as required. Install the battery.
5. Perform a pre-ride inspection (page 43 ), then test-ride your ATV at low speeds.



## You & the Environment

---

Owning and riding an ATV can be enjoyable, but you must do your part to protect nature. When you show respect for the land, wildlife, and other people, you also help preserve the sport of off-road riding.

Following are tips on how you can be an environmentally responsible ATV owner.

- **Tread Lightly.** Stay on existing roads and trails, avoid surfaces that are easily damaged, and ride only in areas approved for off-road vehicles.
- **Keep the Noise Down.** Loud vehicles can be offensive. Ride as quietly as possible, don't remove your spark arrester, and don't modify the muffler or any other part of your air intake and exhaust systems. Such modifications not only increase noise, they also reduce engine performance and may be illegal.
- **Choose Sensible Cleaners.** Use a biodegradable detergent when you wash your ATV. Avoid aerosol spray cleaners that contain chlorofluorocarbons (CFCs) which damage the atmosphere's protective ozone layer. Don't throw cleaning solvents away; see the following guidelines for proper disposal.
- **Recycle Wastes.** It's illegal and thoughtless to put used engine oil in the trash, down a drain, or on the ground. Used oil, gasoline, and cleaning solvents contain poisons that can hurt refuse workers and contaminate our drinking water, lakes, rivers, and oceans. Before changing your oil, make sure you have the proper containers. Put oil and other toxic wastes in separate sealed containers and take them to a recycling center. Call your local or state office of public works or environmental services to find a recycling center in your area, and to get instructions on how to dispose of non-recyclable wastes.







## Taking Care of the Unexpected

With all the challenges you can encounter off-road, there's a chance that sometime something may go wrong. This section gives practical advice to help you deal with a wide range of problems. Take time to read this section before you ride. Also review the tips in *Preparing for a Ride* (page 176).

General Guidelines.....	186
If Your Engine Quits or Won't Start.....	188
If You Have a Flat Tire.....	191
If the High Coolant Temperature Indicator Lights.....	195
If a Fuse Blows.....	197
If You Crash.....	202
If You Lose Your Key.....	203
If the Battery Is Low (or Dead).....	204
If a Component Fails.....	205





# Taking Care of the Unexpected

---

## General Guidelines

Keeping your ATV well-maintained is the best way to reduce the possibility of having a problem while riding. However, problems can arise even with well-maintained machines.

Remember to take along your owner's manual, the tool kit that came with your ATV, and any other items (such as tire repair supplies and additional tools) that might help you solve a problem on your own.

If something goes wrong during a ride, the first thing to do is stop as soon as you safely can. Do not continue riding if you have a flat tire, or you hear an unusual noise, or your ATV just doesn't feel right. If you continue riding, you could cause more damage and endanger your own safety.

After stopping, take time to assess the situation. Carefully inspect your ATV to identify the problem, then consider your options before you decide what to do.

If a problem is relatively minor and you have the tools, supplies, and skills to make a permanent repair, you may be able to fix it on the trail and continue riding. Or, you may be able to make a temporary repair that allows you to slowly ride back to your base where you can make a permanent repair or get help.

When a problem is more serious — or you don't have the tools, supplies, experience, or time to deal with it — you need to choose the safest way to get yourself and your ATV back to base. For example, if you are close enough, you (or you and another person) might be able to push it back.





## Taking Care of the Unexpected

---

Should you ever have a problem while riding, please follow these guidelines:

- Always put personal safety first.
- Take time to assess the situation and your options before deciding what to do.
- If the problem is relatively minor and you have the tools, supplies, and skills to make a temporary repair, be sure to have permanent repairs made as soon as possible.
- Do not continue riding if you are hurt or your ATV is not in safe riding condition.

Additional recommendations for specific problems follow.



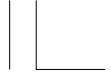

## If Your Engine Quits or Won't Start

---

Proper operation and maintenance can prevent starting and engine performance problems. In many cases, the cause of the problem may be a simple operational oversight.

If you have a problem starting the engine—or experience poor engine performance—the following information may help you. If you can't correct the problem, see your dealer.

If your ATV won't start, listen as you press the start button. If you don't hear the starter motor turning, refer to the *Starter motor doesn't operate* symptom. If you can hear the starter motor working normally, refer to the *Starter motor works, but the engine won't start* symptom.

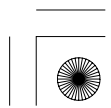
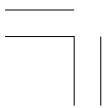



## If Your Engine Quits or Won't Start

SYMPTOM: <b>Starter motor doesn't operate.</b>	
POSSIBLE CAUSE	WHAT TO DO
ignition switch OFF	Turn the ignition switch ON.
engine stop switch OFF	Slide the engine stop switch to RUN.
transmission not in neutral	Shift into neutral.
blown fuse	Replace with a new fuse of the same rating (page 197).
battery lead loose	Tighten the battery lead.
low (or dead) battery	Charge the battery (page 169). If charging doesn't help, see your dealer.
faulty starter motor	If all possible causes are negative, the starter motor may be faulty. See your dealer.

SYMPTOM: <b>Starter motor works, but the engine won't start.</b>	
POSSIBLE CAUSE	WHAT TO DO
out of fuel	Fill the fuel tank.
flooded engine	See <i>Flooded Engine</i> (page 62).
loose or unconnected spark plug cap	Install the spark plug cap securely. If the engine still won't start, see your dealer.
loose battery cables	Tighten the battery terminal bolts.
weak battery	Charge the battery (page 169). If charging doesn't help, see your dealer.





## If Your Engine Quits or Won't Start

SYMPTOM: <b>Engine starts, but runs poorly.</b>	
POSSIBLE CAUSE	WHAT TO DO
high coolant temperature	Check the high coolant temperature indicator. Refer to <i>If the High Coolant Temperature Indicator Lights</i> , page 195.
runs erratically, misfires	See your dealer.
blubbers (rich fuel mixture)	See your dealer.
sooty exhaust (rich fuel mixture)	See your dealer.
detonates or pings under load	If applicable, switch to the recommended octane gasoline (page 102) or change your brand of gasoline. If the problem persists, see your dealer.
afterfires (backfires)	See your dealer.
pre-ignition (runs on after ignition switched OFF)	See your dealer.

SYMPTOM: <b>Engine starts, but runs poorly or dies when hot.</b>	
POSSIBLE CAUSE	WHAT TO DO
poor or inadequate fuel flow due to clogged fuel filter	See your dealer. (ensure clean fuel supply)





## If You Have a Flat Tire

---

How you handle a flat tire on the trail depends on how serious the tire damage is, and what tools and supplies you have with you.

If you have a slow leak or a minor puncture, use the plug method to make a temporary repair. (The plug method is applied from the outside of the tire and is the same as that for conventional tubeless tires.)

A plug-type repair kit, available at most auto parts stores or service stations, provides a plug, an installation tool, tire cement, and an instruction sheet. Follow the instructions provided with the repair kit to make a temporary repair.

As soon as possible, have the tire permanently repaired by your dealer. Any tire that cannot be repaired should be replaced.



Whenever the ATV is to be operated far from service facilities or available transportation, we recommend that you carry a tire pump and a repair kit with the vehicle.



If the leak is more serious, or a temporary repair doesn't hold, the tire must be replaced. The tire will also need to be replaced if it is damaged (page 160). Replacing a tire involves removing and re-installing the wheel (page 193).

If you are unable to repair a flat tire on the trail, you will need to send for help. We strongly recommend that you do not try to ride with a flat tire. The ATV will be hard to handle, and if the tire comes off the rim, it may lock up the wheel and cause you to crash.

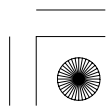
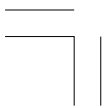



## If You Have a Flat Tire

---

### **WARNING**

Riding your ATV with a temporary tire repair can be risky.

If the temporary repair fails, you can crash and be seriously injured or killed. If you must ride with a temporary tire repair, ride slowly and carefully until the tire is permanently repaired or replaced.







## If You Have a Flat Tire

### Emergency Wheel Removal/Installation

Refer to *Safety Precautions* on page 89 .

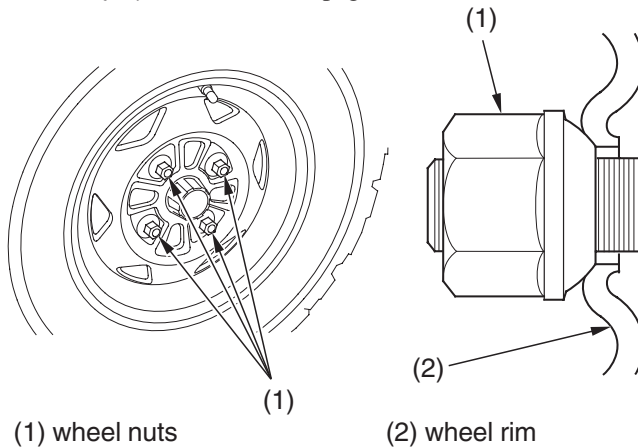

#### Removal

1. Park your ATV on a firm, level surface.
2. Loosen — but do not remove — the wheel nuts (1).
3. Raise the front (or rear) wheels off the ground and place a support block under the vehicle.
4. Remove the wheel nuts.
5. Remove the wheel.
  - Avoid getting grease, oil, or dirt on the front brake disc or pad surfaces when removing and installing each wheel. Any contamination can cause poor brake performance or rapid pad wear after reassembly.





## If You Have a Flat Tire

---

### Installation

1. Position the wheel.
2. Position the wheel nuts so that the tapered sides face the wheel rim (2).
3. Hand-tighten the wheel nuts on the wheel, then lower the ATV to the ground before tightening the nuts in a crisscross (rather than circular) pattern to the specified torque:  
47 lbf·ft (64 N·m , 6.5 kgf·m)

If a torque wrench was not used for installation, see your dealer as soon as possible to verify proper assembly. Improper assembly may lead to loss of braking capability.

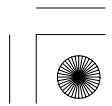



## If the High Coolant Temperature Indicator Lights

Normally, the high coolant temperature indicator will only light momentarily when you turn the ignition ON ( I ). Occasionally, it may flicker at or near idling speed.

High coolant temperature may be caused by restriction of air flow to the radiator (such as mud caked on the radiator), extended idling, an oil leak, a coolant leak, a low oil level, a low coolant level, or extended operation under adverse conditions.

If the indicator comes on while you're riding, don't ignore it. Pull safely to a stop. Stop the engine as soon as it's safe to do so, and let it cool.

### NOTICE

*Continuing to ride with high coolant temperature or an overheated engine can cause serious engine damage.*

- A steaming engine indicates a coolant leak. Shut the engine off and wait until the steaming stops. Look for a leak, but don't touch the engine or radiator system. Let everything cool off first.
- Check for any restriction of air flow to the radiator.
- If there's no obvious problem, leave the engine on so the fan and coolant circulating system can continue working. Monitor the high coolant temperature indicator. The indicator may turn off after a brief stop with no load on the engine.
- Check the radiator fan.

If the fan is not working, turn the engine off. Open the fuse box (page 198 ) and check the radiator fan fuse. If the fuse is blown, replace it with the proper (same rating) spare fuse. Start the engine. If the high coolant temperature indicator comes on and stays on, turn the engine off.

If the radiator fan is working, visually check the coolant level in the reserve tank, located under the rear fender. It isn't necessary to touch the radiator system.



## If the High Coolant Temperature Indicator Lights

---

- If the reserve tank is low or empty, don't ride without adding coolant (page 120). After adding coolant, turn the engine on and check the high coolant temperature indicator.  
If the indicator doesn't turn off, do not ride. The engine needs repair. Transport your ATV to your dealer (page 178 ).  
If the temperature drops to normal, check the coolant level. If it has gone down, add more coolant.
- Check for an oil leak.
- Check the oil level. If necessary, add the recommended oil (page 108) to the upper level mark. If you must leave your ATV to get oil, secure it as much as possible.
- Start the engine, and check that the high coolant temperature indicator goes off.

If you are able to resume riding, continue to monitor the high coolant temperature indicator frequently.

If there is an oil leak — do not ride the ATV until the leak is repaired by your dealer (page 178 ).

If there's a mild coolant leak, you can ride for awhile, carefully watching the indicator. Be prepared to stop and add more coolant or water. If the leak is bad, transport your ATV to your dealer (page 178 ).





## If a Fuse Blows

All of the electrical circuits on your ATV have fuses to protect them from damage caused by excess current flow (short circuit or overload).

If something electrical on your ATV stops working, the first thing you should check for is a blown fuse (1).

Check all the fuses before looking elsewhere for another possible cause of the problem. Replace any blown fuses and check component operation.

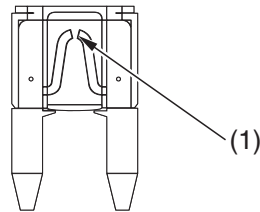

(1) blown fuse

The main fuse and the circuit fuses are located under the rear fender cover.

TRX420FPM only:

The PS (Electric Power Steering) fuse is located under the rear fender cover.

### Recommended Fuses

main fuse	30 A
other fuses	15 A , 10 A × 3
PS (Electric Power Steering) fuse (TRX420FPM only)	40 A





## If a Fuse Blows

### Main Fuse Access

1. To prevent an accidental short circuit, turn the ignition switch OFF (  $\bigcirc$  ) before checking or replacing the fuses.
2. Remove the seat (page 100 ).
3. Remove the rear fender cover (page 121 ).
4. To access the main fuse ( 2 ), remove the fuse box cover ( 3 ).

### UNDER REAR FENDER COVER

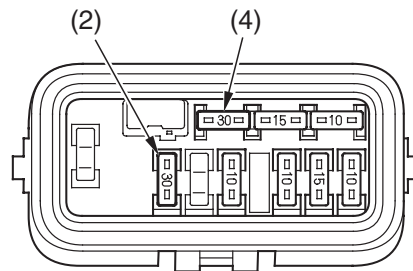
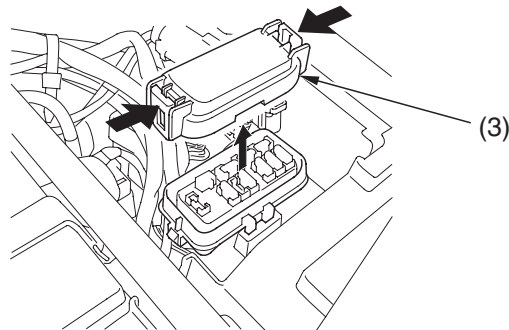

- (2) main fuse                      (4) spare main fuse  
(3) fuse box cover

5. Pull the main fuse out.  
If it is blown, install the spare main fuse ( 4 ).

### 198 Taking Care of the Unexpected

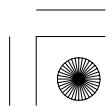



## If a Fuse Blows

### Circuit Fuse Access

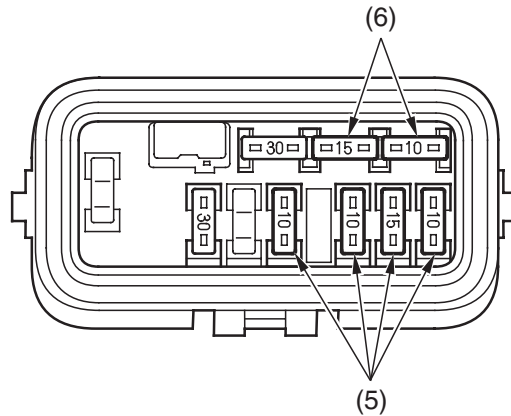

(5) circuit fuses

(6) spare fuses

6. To check or replace a circuit fuse (5), pull the old fuse out of its retaining clips.  
If the fuse is blown, replace it with a spare fuse (6) of the same rating.

If you do not have a replacement fuse with the proper rating for the circuit, install one with a lower rating.

#### NOTICE

*Replacing a fuse with one that has a higher rating greatly increases the chance of damage to the electrical system.*

7. Install the fuse box cover.
8. Install the rear fender cover.
9. Install the seat.



## If a Fuse Blows

---

*PS (Electric Power Steering) Fuse Access (TRX420FPM only)*

1. Turn the ignition switch OFF (  $\bigcirc$  ) before checking the fuse.
2. Remove the seat (page 100 ).
3. Remove the rear fender cover (page 121 ).
4. To access the PS fuse ( 1 ), remove the PS fuse box cover ( 2 ).

If the PS fuse is blown, see your dealer for this service.

5. Install the PS fuse box cover.
6. Install the rear fender cover.
7. Install the seat.

### UNDER REAR FENDER COVER

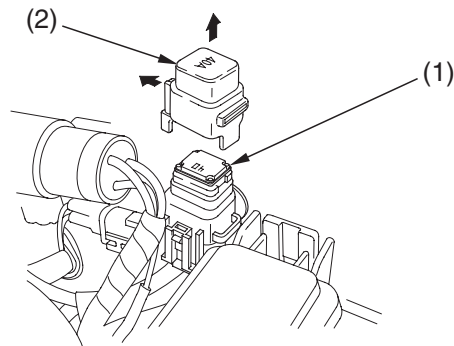

(1) PS fuse

(2) PS fuse box cover

## 200 Taking Care of the Unexpected





## If a Fuse Blows

---

If you do not have a spare fuse and you cannot ride the ATV without fixing the problem, take a fuse of the same rating or a lower rating from one of the other circuits that you can do without temporarily.

If you replace a blown fuse with a spare fuse that has a lower rating, replace the fuse with the correct rating as soon as you can. Also remember to replace any spare fuses that were installed.

If the replacement fuse of the same rating burns out in a short time, there is probably a serious electrical problem on your ATV. Leave the blown fuse in that circuit and have your ATV checked by your dealer.





## If You Crash

---

Personal safety is your first priority after a crash. If you or anyone else has been injured, take time to assess the severity of the injuries and whether it is safe to continue riding. If you cannot ride safely, send someone for help. Do not ride if you will risk further injury.

If you decide you are capable of riding safely, carefully inspect your ATV for damage and determine if it is safe to ride. Check the tightness of critical nuts and bolts securing such parts as the handlebar, control levers, brakes, and wheels.

If there is minor damage, or you are unsure about possible damage but decide to try riding the ATV back to your base, ride slowly and cautiously.

Sometimes, crash damage is hidden or not immediately apparent. When you get home, thoroughly check your ATV and correct any problems you find. Also, be sure to have your dealer check the frame and suspension after any serious crash.

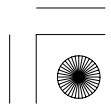



## If You Lose Your Key

Be sure to record your key number (1) in the Quick Reference section at the rear of the manual. You'll need this number to have a duplicate key made.

If you lose your key and aren't carrying a duplicate, either get your spare or have one made. If you don't know your key number, call the dealer where you purchased your Honda ATV. They may have it listed in their records. If they don't, transport your ATV to them or the nearest dealer. The dealer will probably have to remove the ignition switch assembly to find the key number so they can make a key for you.

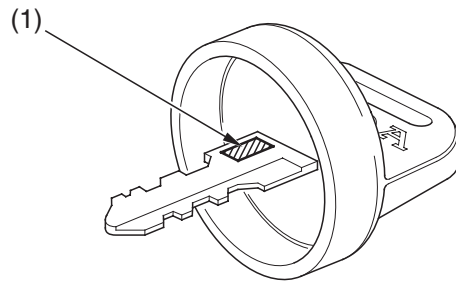

(1) key number





## **If the Battery Is Low (or Dead)**

---

Jump starting is not recommended, especially if you use an automobile battery. The greater amperage of an automobile battery when the car engine is running can damage your ATV's electrical system.

Bump starting is also not recommended.

If you can't charge the battery or it appears unable to hold a charge, contact your dealer.

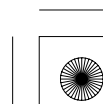
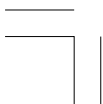



## If a Component Fails

---

The brake levers or pedal, control cables, and other components can be damaged as you ride in dense brush or over rocky terrain. Making a trailside repair depends on how serious the damage is and what tools and supplies you have with you.

- If any component of the brake system is damaged, you may be able to ride carefully back to your base using the other brake components for slowing or stopping.
- If you damage a throttle cable or other critical component, your ATV may be unsafe to ride. Carefully assess the damage and make any repairs that you can. But if there is any doubt, it's best to be conservative and safe.

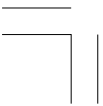



11/05/09 13:27:39 31HP4650 0215



## 206 Taking Care of the Unexpected

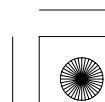
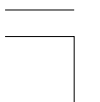



# Technical Information

This section contains dimensions, capacities, and other technical data, plus information on government requirements and how to break-in your ATV.

Vehicle Identification.....	208
Specifications.....	210
Break-in Guidelines .....	215
Emission Control Systems.....	216
Oxygenated Fuels.....	220





# Vehicle Identification

## Serial Numbers

The VIN, engine serial number, and key number may be required when ordering replacement parts. You may record these numbers in the Quick Reference section at the rear of this manual.

The VIN (1) is stamped on the front of the frame.

FRONT

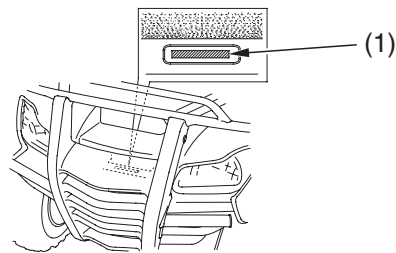

(1) VIN

The engine number (2) is stamped on the upper side of the rear crankcase.

LEFT SIDE

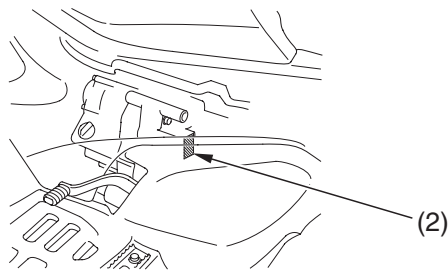

(2) engine number

**208** Technical Information





## Vehicle Identification

### Color Label & Code

The color label (1) is attached to the frame under the seat. Remove the seat (page 100 ) to check the label.

The color code is helpful when ordering replacement parts. You may record the color and code in the Quick Reference section at the rear of this manual.

#### UNDER SEAT

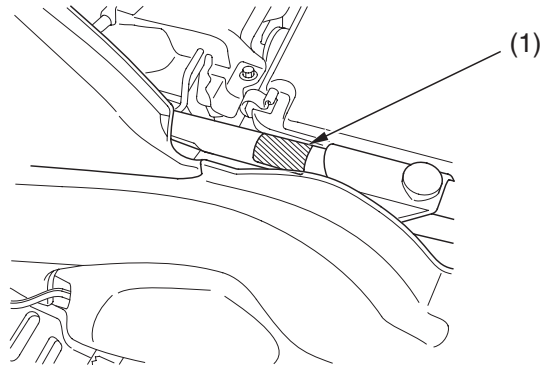

(1) color label



## Specifications

<b>Dimensions</b>	
overall length	80.9 in (2,055 mm)
overall width	46.1 in (1,172 mm)
overall height	45.2 in (1,148 mm) .....TRX420TM 45.1 in (1,146 mm) .....TRX420FM TRX420FPM
wheelbase	49.4 in (1,256 mm) .....TRX420TM 49.2 in (1,249 mm) .....TRX420FM TRX420FPM
ground clearance	6.5 in (165 mm)

<b>Fuel &amp; Lubricants</b>	
fuel recommendation	unleaded gasoline, pump octane number of 86 or higher
fuel tank capacity	3.51 US gal (13.3 ℓ) including reserve
fuel tank reserve	0.69 US gal (2.6 ℓ)
engine oil capacity	after disassembly: 3.3 US qt (3.1 ℓ) after draining: 2.9 US qt (2.7 ℓ) after draining & oil filter change: 3.0 US qt (2.8 ℓ)
engine oil	API Service Classification SG or higher except oils labeled as energy conserving on the circular API service label, SAE 10W-30, JASO T 903 standard MA, Pro Honda GN4 4-stroke oil or an equivalent motorcycle oil



## Specifications

<b>Fuel &amp; Lubricants (cont'd)</b>	
cooling system recommendation	Pro Honda HP Coolant or an equivalent high quality ethylene glycol antifreeze containing corrosion protection inhibitors specifically recommended for use in aluminum engines
cooling system capacity	1.6 US qt (1.5 ℓ)

<b>Capacities</b>	
passenger capacity	operator only
maximum weight capacity	485 lb (220 kg) rider, all cargo and accessories

<b>Engine Specifications</b>	
displacement	25.6 cu-in (420 cm <sup>3</sup> )
bore & stroke	3.41 × 2.81 in (86.5 × 71.5 mm)
compression ratio	9.9 : 1
spark plug (standard)	BKR5E-11 (NGK) or K16PR-U11 (DENSO)
spark plug gap	0.039 – 0.043 in (1.00 – 1.10 mm)
valve clearance (cold)	intake: 0.006 in (0.15 mm) exhaust: 0.009 in (0.23 mm)
idle speed	1,400 ± 100 rpm (NO ADJUSTMENT)



## Specifications

<b>Power Transmission</b>		
primary reduction		2.103
secondary reduction		1.818
final reduction	front (Except TRX420TM)	3.231
	rear	3.154
transmission ratio	1st	3.857
	2nd	2.235
	3rd	1.571
	4th	1.178
	5th	0.848
	reverse	4.831
final drive		shaft

<b>Chassis &amp; Suspension</b>	
caster	6.34° ...TRX420TM
	3.0° ...TRX420FM TRX420FPM
trail	0.99 in (25.1 mm) ...TRX420TM
	0.35 in (9.0 mm) ...TRX420FM TRX420FPM
tire size, front	AT24 × 8-12 ★★ MAXXIS M977
tire size, rear	AT24 × 10-11 ★★ MAXXIS M978
tire pressure, front & rear (cold)	front:
	3.6 psi (25.0 kPa) ...TRX420TM TRX420FM
	4.4 psi (30.0 kPa) ...TRX420FPM
	rear:
	3.6 psi (25.0 kPa)



## Specifications

<b>Electrical</b>	
battery	YTX14-BS 12 V-12 Ah (10HR)
generator	0.359 kW/5,000 rpm

<b>Lights</b>	
headlight	12 V 30/30 W × 2
brake/tail light	LED
neutral indicator	12 V 1.7 W ..... TRX420TM TRX420FM LED ..... TRX420FPM
reverse indicator	12 V 1.7 W ..... TRX420TM TRX420FM LED ..... TRX420FPM
high coolant temperature indicator	12 V 1.7 W ..... TRX420TM TRX420FM LED ..... TRX420FPM
PGM-FI indicator	12 V 1.7 W ..... TRX420TM TRX420FM LED ..... TRX420FPM
4WD indicator (Except TRX420TM)	12 V 1.7 W ..... TRX420FM LED ..... TRX420FPM
PS (Electric Power Steering) indicator (TRX420FPM only)	LED



## Specifications

<b>Fuses</b>	
main	30 A
other	15 A , 10 A × 3
PS (Electric Power Steering) (TRX420FPM only)	40 A

<b>Torque Specification</b>	
engine oil drain bolt	18 lbf·ft (25 N·m , 2.5 kgf·m)
engine oil filter cover bolts	7 lbf·ft (10 N·m , 1.0 kgf·m)
rear final gear case oil drain bolt	9 lbf·ft (12 N·m , 1.2 kgf·m)
rear final gear case oil fill cap	9 lbf·ft (12 N·m , 1.2 kgf·m)
rear final gear case oil level check bolt	9 lbf·ft (12 N·m , 1.2 kgf·m)
skid plate bolts	24 lbf·ft (32 N·m , 3.3 kgf·m)
differential oil drain bolt (Except TRX420TM)	9 lbf·ft (12 N·m , 1.2 kgf·m)
differential oil fill cap (Except TRX420TM)	9 lbf·ft (12 N·m , 1.2 kgf·m)
rear brake drain bolt	9 lbf·ft (12 N·m , 1.2 kgf·m)
wheel nuts	47 lbf·ft (64 N·m , 6.5 kgf·m)



## Break-in Guidelines

---

Help assure your ATV's future reliability and performance by paying extra attention to how you ride during the first operating day or 15 miles (25 km).

During this period, avoid full-throttle starts, rapid acceleration, and constant rpm operation.

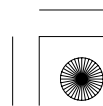
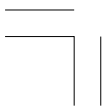



# Emission Control Systems

---

## Exhaust Emission Requirements

The U.S. Environmental Protection Agency (EPA) and the California Air Resources Board (CARB) require that your ATV comply with applicable exhaust emissions standards during its useful life, when operated and maintained according to the instructions provided.

The Vehicle Emission Control Information Label (1) is attached on the left side of the frame.

LEFT FRONT

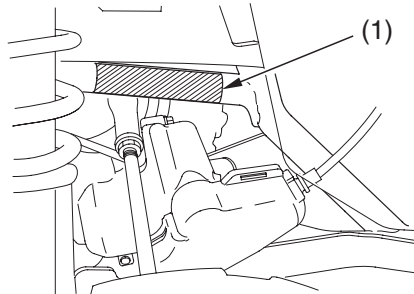

(1) vehicle emission control information label

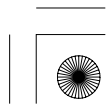
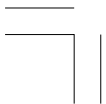





## Emission Control Systems

---

### Source of Exhaust Emissions

The combustion process produces carbon monoxide (CO), oxides of nitrogen (NO<sub>x</sub>) and hydrocarbons (HC). Control of hydrocarbons and oxides of nitrogen is very important because, under certain conditions, they react to form photochemical smog when subjected to sunlight. Carbon monoxide does not react in the same way, but it is toxic.

Honda Motor Co., Ltd. utilizes various systems to reduce carbon monoxide, oxides of nitrogen and hydrocarbons.

### Exhaust Emission Control System

The exhaust emission control system includes a PGM-FI system. No adjustment to this system should be made although periodic inspection of the components is recommended.

The exhaust emission control system is separate from the crankcase emission control system.

### Crankcase Emission Control System

The engine is equipped with a closed crankcase system to prevent discharging crankcase emissions into the atmosphere. Blow-by gas is returned to the combustion chamber through the air cleaner.

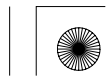



## Emission Control Systems

---

### Problems That May Affect ATV Exhaust Emissions

If you are aware of any of the following symptoms, have the vehicle inspected and repaired by your ATV dealer.

Symptoms:

1. Hard starting or stalling after starting
2. Rough idle
3. Misfiring or backfiring during acceleration
4. After-burning (backfiring)
5. Poor performance (driveability) and poor fuel economy

Federal regulations prohibit removing or disabling a device or element of design that may affect your engine's emission performance unless your ATV will be used exclusively in competition. If you modify your engine for use in sanctioned competition events, you must deface or destroy the emission control information label.





## Emission Control Systems

---

### Noise Emission Control System

TAMPERING WITH THE NOISE CONTROL SYSTEM IS PROHIBITED:

State laws prohibit, the following acts or the causing thereof: (1) The removal or rendering inoperative by any person, other than for purposes of maintenance, repair or replacement, of any device or element of design incorporated into any new vehicle for the purpose of noise control prior to its sale or delivery to the ultimate purchaser or while it is in use; or (2) the use of the vehicle after such device or element of design has been removed or rendered inoperative by any person.

AMONG THOSE ACTS PRESUMED TO CONSTITUTE TAMPERING ARE THE FOLLOWING ACTS:

1. Removal of, or puncturing the muffler, baffles, header pipes or any other component which conducts exhaust gases.
2. Removal of, or puncturing of any part of the intake system.
3. Lack of proper maintenance.
4. Replacing any moving parts of the vehicle, or parts of the exhaust or intake system, with parts other than those specified by the manufacturer.

### Fuel Permeation Emission Control System

This vehicle complies with the Fuel Permeation Emission Control regulations of the U.S. Environmental Protection Agency (EPA) and the California Air Resources Board (CARB).

The fuel tank, fuel hoses, and fuel vapor charge hoses used on this vehicle incorporate fuel permeation control technologies.

Tampering with the fuel tank, fuel hoses, or fuel vapor charge hoses to reduce or defeat the effectiveness of the fuel permeation technologies is prohibited by federal regulations.





## Oxygenated Fuels

---

Some conventional gasolines are being blended with alcohol or an ether compound. These gasolines are collectively referred to as oxygenated fuels. To meet clean air standards, some areas of the United States use oxygenated fuels to help reduce emissions.

If you use an oxygenated fuel, be sure it is unleaded and meets the minimum octane rating requirement.

Before using an oxygenated fuel, try to confirm the fuel's contents.

Some states/provinces require this information to be posted on the pump.

The following are the EPA-approved percentages of oxygenates:

ETHANOL (ethyl or grain alcohol) 10% by volume

You may use gasoline containing up to 10% ethanol by volume.

Gasoline containing ethanol may be marketed under the name "Gasohol".



MTBE (Methyl Tertiary Butyl Ether) 15% by Volume

You may use gasoline containing up to 15% MTBE by volume.



METHANOL (methyl or wood alcohol) 5% by Volume

You may use gasoline containing methanol containing up to 5% methanol by volume as long as it also contains cosolvents and corrosion inhibitors to protect the fuel system. Gasoline containing more than 5% methanol by volume may cause starting and/or performance problems. It may also damage metal, rubber, and plastic parts of your fuel system.

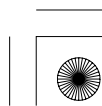
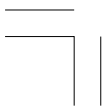



## Oxygenated Fuels

---

If you notice any undesirable operating symptoms, try another service station or switch to another brand of gasoline.

Fuel system damage or performance problems resulting from the use of an oxygenated fuel containing more than the percentages of oxygenates mentioned above are not covered under warranty.

Oxygenated fuels can damage paint and plastic. Be careful not to spill fuel when filling the fuel tank. Wipe up any spills immediately.

### NOTICE

*Oxygenated fuels can damage paint and plastic. Damage caused by spilled fuel is not covered by warranty.*

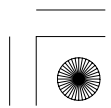



11/05/09 13:30:02 31HP4650 0231



**222 Technical Information**

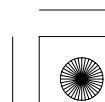
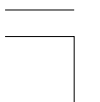



# Consumer Information

This section contains information on your warranty and how to get an official Honda service manual.

Authorized Manuals .....	224
Warranty Coverage .....	225
Warranty Service.....	226
Contacting Honda .....	227
Your Honda Dealer .....	228
The Honda Rider's Club .....	229

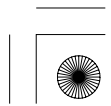



## Authorized Manuals

---

The Service Manual used by your authorized dealer is available from your Honda dealer or Helm, Inc.

Also available but not necessary to service your model is the Honda Common Service Manual which explains theory of operation and basic service information for various systems on Honda motorcycles, scooters, ATVs, MUVs and PWCs.

These Honda manuals are written for the professional technician, but most mechanically capable owners should find them easy to use if they have the proper tools and observe proper safety standards. Special Honda tools are necessary for some procedures.

Publication Item No.	Description
61HP404	2012 TRX420TE/TM/FE/FM/FPE/FPM Service Manual
61CM002	Common Service Manual
31HP4650	2012 TRX420TM/FM/FPM Owner's Manual

**Order On-Line: [www.helminc.com](http://www.helminc.com)**

**Order Toll Free: 1-888-CYCLE93 (1-888-292-5393)**

*(NOTE: For Credit Card Orders Only)*

Monday — Friday 8:00 AM — 6:00 PM EST







## Warranty Coverage

---

Your new Honda is covered by these warranties:

- TRX Limited Warranty
- Emission Control System Warranty

There are responsibilities, restrictions, and exclusions which apply to these warranties. Please read the Warranties Booklet given to you by your Honda dealer at the time of purchase. Be sure to keep your Honda owner's card with your Warranties Booklet.

It is important to realize that your warranty applies to defects in material or workmanship of your Honda. Your warranty coverage does not apply to normal wear or deterioration associated with using the ATV.

Your warranty coverage will not be voided if you choose to perform your own maintenance. However, you should have the proper tools and service information, and be mechanically qualified. Failures that occur due directly to improper maintenance are not covered.

Almost all of your warranty coverage can be extended through the Honda Protection Plan. For more information, see your dealer.



## Warranty Service

---

Please remember that recommended maintenance interval servicing is not included in your warranty coverage. Additionally, your warranty does not apply to the normal wear of items (such as brakes, tires, etc.).

If you believe you have a problem with your ATV, call the service department of your dealer. Make an appointment for an inspection and diagnosis. Remember, as the owner of the ATV, you will be asked to authorize that inspection. Your dealer will give you the results of the inspection. If the problem is covered under warranty, your dealer will perform the warranty repairs for you.

If you have questions about warranty coverage or the nature of the repair, it is best to talk to the Service Manager of your dealer.

Sometimes, in spite of the best intentions of all concerned, a misunderstanding may occur. If you aren't satisfied with your dealer's handling of the situation, we suggest you discuss your problem with the appropriate member of the dealership's management team. If the problem has already been reviewed with the Service Manager, Parts Manager, Sales Manager, etc., contact the Owner of the dealership or their designated representative.





## Contacting Honda

---

Your owner's manual was written to cover most of the questions you might ask about your Honda. Any questions not answered in the owner's manual can be answered by your dealer. If your dealer doesn't have the answer right away, they will get it for you.

If you have a difference of opinion with your dealer, please remember that each dealership is independently owned and operated. That's why it's important to work to resolve any differences at the dealership level.

If you wish to comment on your experiences with your Honda or with your dealer, please send your comments to the following address:  
Motorcycle Division, American Honda Motor Co., Inc., P.O. Box 2200,  
Torrance, CA 90509-2200, mailstop: 100-4C-7B, telephone: (866) 784-1870.

Please include the following information in your letter:

- name, address, and telephone number
- product model, year, and VIN
- date of purchase
- dealer name and address

We will likely ask your dealer to respond, or possibly acknowledge your comments directly.



## Your Honda Dealer

---

Once you purchase your new Honda, get familiar with the organization of your Honda dealer so you can utilize the full range of services available.

The service department is there to perform regular maintenance and unexpected repairs. It has the latest available service information from Honda. The service department will also handle warranty inspections and repairs.

The parts department offers Honda Genuine Parts, Pro Honda products, and Honda Genuine Accessories. The same quality that went into your Honda can be found in Honda Genuine replacement parts. You'll also find comparable quality in the accessories and products available from the parts department.



The sales department offers the Honda Protection Plan to extend almost all of your warranty coverage.



Your Honda dealer can inform you about competition and other riding events in your area. You'll also find that your dealer is a source of information about the Honda Rider's Club of America.

We're sure you'll be as pleased with the service your Honda dealer continues to provide after the sale as you are with the quality and dependability of your Honda.





## The Honda Rider's Club

---

The Honda Rider's Club of America (HRCA) sponsors local riding chapters at Authorized Honda Dealerships across the country. You can log on to the HRCA Clubhouse website for more information at [www.hrca.honda.com](http://www.hrca.honda.com).

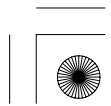
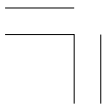



# Index

## A

accessories.....	50
age recommendation .....	41
air cleaner,	
dust cover .....	129
filter.....	125
housing drain tube.....	130
air pressure,	
gauge .....	99
tire .....	155
American Honda, contacting.....	227
apparel, protective .....	38
appearance care .....	170
authorized manuals.....	224





# Index

## B

bank angle sensor ignition cut-off system..... 62

battery..... 165

brake light switch adjustment..... 152

brakes,

- cables..... 151
- draining water from..... 153
- fluid..... 143
- front brake lever..... 31
- pad wear ..... 146
- parking ..... 32
- rear brake lever..... 31
- rear brake lever freeplay ..... 149
- rear brake pedal ..... 31
- rear brake pedal freeplay..... 147
- shoe wear..... 151

braking ..... 69

break-in guidelines ..... 215

button, hourmeter/odometer/tripmeter select ..... 13, 17, 20, 21, 22

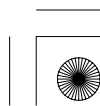



# Index

## C

capacity, fuel..... 103

care, appearance ..... 170

cargo,

    loading and operational guidelines..... 49

    weight limit ..... 48

cleaning, appearance care..... 170

climbing hills..... 74

clip..... 101

clutch system..... 133

color label..... 209

compartment,

    owner's manual ..... 99

    tool kit ..... 98

component fails..... 205

consumer information ..... 223

controls & features ..... 24

crash, if you..... 202

crossing or turning on hills or slopes..... 79

customer service..... 227

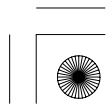
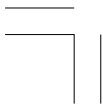





# Index

## D

differential oil (Except TRX420TM)..... 117  
 dimmer switch, headlight..... 28  
 dipstick..... 109  
 display check..... 15  
 display, multi-function..... 18  
 drivetrain boots..... 163

## E

electric power steering (PS) ..... 35  
 emission control systems..... 216  
 engine,  
   flooded ..... 62  
   guard ..... 161  
   number ..... 208  
   oil ..... 105  
   pinging ..... 102  
   starting..... 60  
   stop switch..... 27  
   stopping..... 64  
   won't start ..... 188  
 environment ..... 184  
 exhaust system,  
   cleaning ..... 44  
   purging ..... 139





# Index

## F

final gear case oil .....	114
flag pole bracket.....	33
flat tire.....	191
flooded engine.....	62
front boot guards (Except TRX420TM) .....	162
front driveshaft boots (Except TRX420TM) .....	164
front driveshaft guards (Except TRX420TM) .....	162
fuel,	
fill cap .....	103
gauge .....	23
oxygenated .....	220
recommendation.....	102
refueling.....	103
reserve fuel supply .....	103
tank capacity .....	103
valve.....	24
fuses .....	197

## G

gap, spark plug .....	136, 211
gasohol .....	220
gasoline .....	102
gear case oil.....	114
gear shifting .....	65
guards.....	161





# Index

## H

headlight dimmer switch ..... 28

headlight switch ..... 28

hills,

    crossing or turning on slopes..... 79

    riding down hills ..... 78

    riding up hills ..... 74

    stopping on hills ..... 76

Honda,

    contacting ..... 227

    dealer ..... 228

    Rider’s Club ..... 229

hourmeter ..... 17, 18, 22

hourmeter/odometer/tripmeter select button ..... 13, 17, 20, 21, 22

Honda service manual ..... 224

## I

identification, vehicle..... 208

ignition switch..... 25

indicators,

    gear position indicator ..... 17, 18, 19

    high coolant temperature indicator..... 13, 16, 195

    neutral indicator ..... 13, 16

    oil change indicator ..... 17, 18, 20

    PGM-FI indicator ..... 13, 16

    PS indicator (TRX420FPM only) ..... 16, 35

    reverse indicator ..... 13, 16

    4WD indicator (Except TRX420TM) ..... 13, 16, 26

inspection, pre-ride..... 43



# Index

## K

key,  
 lost..... 203  
 number ..... 203  
 kit, tool ..... 98

## L

labels, safety ..... 5  
 lamp check ..... 14  
 lever, 2WD/4WD select (Except TRX420TM)..... 26  
 limit, weight ..... 48  
 load limits..... 48  
 loading guidelines ..... 49  
 lubrication,  
 differential oil (Except TRX420TM)..... 117  
 engine oil..... 105  
 gear case oil..... 114

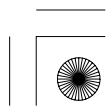
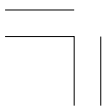



# Index

## M

maintenance,

- component locations..... 95
- importance..... 87
- precautions ..... 89
- record ..... 94
- safety ..... 88
- schedule..... 90

manual, service..... 224

maximum weight limit ..... 48

modifications..... 51

multi-function display ..... 18

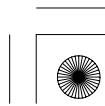
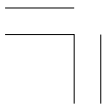



# Index

## N

neutral indicator ..... 13, 16  
 noise emission control system..... 219  
 numbers, serial .....208

## O

obstacles, riding over ..... 81  
 odometer..... 17, 18, 21  
 oil,  
   differential (Except TRX420TM)..... 117  
   engine..... 105  
   gear case..... 114  
 operation component locations..... 10  
 owner's manual storage..... 99  
 oxygenated fuels ..... 220





# Index

## P

parking ..... 83

passenger no carrying..... 41

pavement, no riding on..... 55

pinging, engine..... 102

plug, spark..... 135

pre-ride inspection..... 43

problems, unexpected..... 185

propeller shaft boots & yoke joint boot..... 163

protective apparel..... 38

PS (Electric Power Steering) (TRX420FPM only) ..... 35

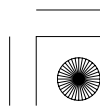



# Index

## R

rear final gear case oil ..... 114

removal, seat ..... 100

reverse,

- assist cable ..... 134
- assist lever ..... 134
- gear, shifting into ..... 67
- indicator ..... 13, 16
- riding in ..... 67
- selector knob ..... 30

rider training ..... 40

Rider's Club, Honda ..... 229

riding,

- basic operations ..... 53
- clothing ..... 38
- precautions ..... 55
- preparing for ..... 176
- over obstacles ..... 81
- safety ..... 2
- safety precautions ..... 55
- through water ..... 82







# Index

## S

safety,

- important precautions ..... 89
- labels ..... 5
- riding precautions ..... 55

schedule, maintenance ..... 90

seat removal ..... 100

select lever , 2WD/4WD (Except TRX420TM)..... 26

serial numbers ..... 208

service,

- customer ..... 227
- manuals ..... 224
- warranty ..... 226

shifting gears ..... 65

skid plate ..... 161

skidding or sliding ..... 73

spark arrester ..... 139

spark knock ..... 102

spark plug ..... 135

specifications ..... 210

(cont'd)



# Index

---

speedometer ..... 17, 18

stalling on a hill ..... 76

start button ..... 27

starting,

    engine ..... 60

    troubleshooting ..... 188

stop switch, engine ..... 27

stopping engine ..... 64

storage,

    ATV ..... 180

    owner's manual ..... 99

suspension,

    adjustment (Except TRX420TM) ..... 140

    spring pre-load (Except TRX420TM) ..... 141

switch,

    engine stop ..... 27

    headlight ..... 28

    headlight dimmer ..... 28

    ignition ..... 25





# Index

## T

throttle,  
 cable ..... 131, 132  
 lever..... 29, 131, 132

tires,  
 air pressure ..... 155  
 flat ..... 191  
 replacing..... 160  
 repairing ..... 159  
 tread conditions ..... 157, 158

tool kit ..... 98

trailer hitch ..... 34

trailer towing,  
 operational guidelines ..... 49  
 weight limits..... 48

training, rider..... 40

transporting your ATV ..... 178

tripmeter ..... 17, 18, 21

trouble, unexpected ..... 185

troubleshooting, starting ..... 188

turning,  
 on hills or slopes..... 79  
 on level ground.....71

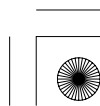



# Index

## V

valve, fuel.....	24
valve clearance.....	138
vehicle identification no. (VIN).....	208

## W

warning labels .....	5
warranty,	
coverage .....	225
extended .....	225
service .....	226
washing your ATV .....	171
water,	
draining from brakes .....	153
riding through.....	82
weight limit .....	48
wheel removal.....	193





11/05/09 13:31:46 31HP4650 0254



**Memo 245**

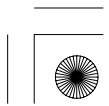



11/05/09 13:31:48 31HP4650 0255



**246 Memo**

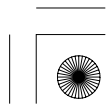
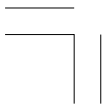



11/05/09 13:31:51 31HP4650 0256

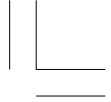

**Memo 247**

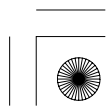
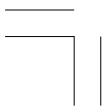



11/05/09 13:31:53 31HP4650 0257



248 Memo

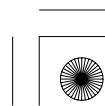
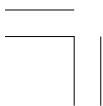





11/05/09 13:31:55 31HP4650 0258



**Memo 249**

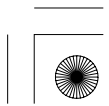



11/05/09 13:31:58 31HP4650 0259



**250 Memo**

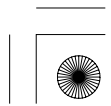



11/05/09 13:32:00 31HP4650 0260



**Memo 251**

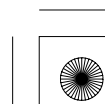
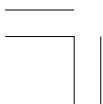



## Quick Reference

---

The following is a brief, but important collection of information you need to know about your Honda. You'll also find space to record important notes.

### How To Avoid Costly Repairs

The engine of your Honda can be the most expensive component to repair. Proper maintenance, especially the use of the recommended fluids and filters, prevents premature wear and damage.

Frequent causes of costly repairs are:

- Engine oil — insufficient quantity, improper oil.
- Air cleaner — dirty, leaking because of improper installation (poor seal).

Record important information on the following page:



### Quick Reference





11/05/09 13:32:10 31HP4650 0262



## Quick Reference

Engine No.	
VIN	
Ignition Key No.	
Color Label	
Owner's Name	
Address	
City/State	
Phone	
Dealer's Name	
Address	
City/State	
Phone	
Service Mgr.	



Quick Reference

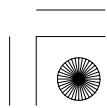



## Quick Reference

Scheduled Maintenance	Initial: 100 miles (150 km) Regular: every 600 miles (1,000 km)
Pre-ride Inspection	Check the following items each time before you ride (page 43 ): engine oil, radiator coolant, fuel, tires, drivetrain boots, guards, nuts & bolts, underbody & exhaust system, air cleaner housing drain tube, leaks, loose parts, cables, lights, throttle, brakes, reverse assist lever, switches, steering.
Fuel/Capacity	unleaded gasoline, pump octane number 86 or higher <b>3.51 US gal (13.3 l)</b> reserve: <b>0.69 US gal (2.6 l)</b>
Engine Oil	API Service Classification SG or higher except oils labeled as energy conserving on the circular API service label, SAE 10W-30, JASO T 903 standard MA, Pro Honda GN4 4-stroke oil or equivalent
Maximum Weight Capacity	<b>485 lb (220 kg)</b> rider, all cargo and accessories

## Quick Reference





## Quick Reference

Tires	<p>Front: AT24 × 8-12 ★★ MAXXIS M977</p> <p>Rear: AT24 × 10-11 ★★ MAXXIS M978</p>
Tire Pressure (cold)	<p>Front: 3.6 psi (25.0 kPa) ...TRX420TM TRX420FM</p> <p>4.4 psi (30.0 kPa) ...TRX420FPM</p> <p>Rear: 3.6 psi (25.0 kPa)</p>
Spark Plugs	<p>standard: BKR5E-11 (NGK) or K16PR-U11 (DENSO)</p>
Coolant	<p>ethylene glycol antifreeze (silicate-free) for aluminum engines in 50/50 solution with Pro Honda HP Coolant or an equivalent distilled water</p>
Fuses	<p>main: 30 A other: 15 A , 10 A × 3 PS (Electric Power Steering) (TRX420FPM only): 40 A</p>

## Quick Reference





## Quick Reference

These symbols are used in Controls & Features section:

SYMBOL	COMPONENT	SEE PAGE
I	ON – ignition switch	25
○	OFF – ignition switch	25
	2WD/4WD select lever	26
	4WD indicator – lights when the 4WD drive mode engages	26
	START button	27
	RUN – engine stop switch	27
	OFF – engine stop switch	27
	ON – headlight switch	28
•	OFF – headlight switch	28
	HI – headlight dimmer switch	28
	LO – headlight dimmer switch	28
<b>R</b>	reverse selector knob	30
<b>PKB</b> ↑	lock lever – parking brake	32

## Quick Reference