

# **2013 Crosstour**

## **Owner's Manual**

### **(Unlinked)**

This document may not contain hyperlinks and may be formatted for printing instead of web use. This is due to changes in content and specifications of the vehicle that happen throughout the model year. This manual will be replaced with a hyperlinked version at the end of the model year.

This owner's manual should be considered a permanent part of the vehicle and should remain with the vehicle when it is sold.

This owner's manual covers all models of your vehicle. You may find descriptions of equipment and features that are not on your particular model.

Images throughout this owner's manual (including the front cover) represent features and equipment that are available on some, but not all, models. Your particular model may not have some of these features.

This owner's manual is for vehicles sold in the United States and Canada.

The information and specifications included in this publication were in effect at the time of approval for printing. Honda Motor Co., Ltd. reserves the right, however, to discontinue or change specifications or design at any time without notice and without incurring any obligation.

## ➤ Safe Driving P. 27

For Safe Driving P. 28      Seat Belts P. 32      Airbags P. 39

## ➤ Instrument Panel P. 69

Indicators P. 70      Gauges and Displays P. 83

## ➤ Controls P. 87

Setting the Clock P. 88      Locking and Unlocking the Doors P. 91  
Opening and Closing the Moonroof P. 113  
Adjusting the Seats P. 133  
Climate Control System\* P. 157

## ➤ Features P. 163

Audio System P. 164      Audio System Basic Operation P. 169, 182, 215  
Customized Features\* P. 281      HomeLink® Universal Transceiver\* P. 318

## ➤ Driving P. 409

Before Driving P. 410      Towing a Trailer P. 415  
Parking Your Vehicle P. 453      Rearview Camera P. 454      Multi-View Rear Camera P. 455

## ➤ Maintenance P. 461

Before Performing Maintenance P. 462      Maintenance Minder™ P. 465  
Checking and Maintaining Wiper Blades P. 493  
Heating and Cooling System\*/Climate Control System\* Maintenance P. 509

## ➤ Handling the Unexpected P. 515

Tools P. 516      If a Tire Goes Flat P. 517  
Overheating P. 532      Indicator, Coming On/Blinking P. 534  
When You Cannot Unlock the Fuel Fill Door P. 543

## ➤ Information P. 545

Specifications P. 546      Identification Numbers P. 550  
Emissions Testing P. 553      Warranty Coverages P. 555

# Contents

Child Safety P. 54

Exhaust Gas Hazard P. 66

Safety Labels P. 67

Opening and Closing the Tailgate P. 105  
Operating the Switches Around the Steering Wheel P. 114  
Interior Lights/Interior Convenience Items P. 142

Security System P. 107

Opening and Closing the Windows P. 110  
Adjusting the Mirrors P. 130  
Heating and Cooling System\* P. 154

Audio Error Messages P. 268

General Information on the Audio System P. 276

*Bluetooth*® HandsFreeLink® P. 320, 332, 367

Compass\* P. 405, 407

When Driving P. 420  
Refueling P. 456

Braking P. 449  
Fuel Economy P. 459

Accessories and Modifications P. 460

Maintenance Under the Hood P. 469  
Checking and Maintaining Tires P. 497  
Cleaning P. 510

Replacing Light Bulbs P. 484  
Battery P. 506

Remote Transmitter Care P. 507

Engine Does Not Start P. 525  
Fuses P. 538  
When You Cannot Open the Tailgate P. 544

Jump Starting P. 528  
Emergency Towing P. 542

Shift Lever Does Not Move P. 531

Devices that Emit Radio Waves P. 551  
Authorized Manuals P. 557

Reporting Safety Defects P. 552  
Customer Service Information P. 558

Quick Reference Guide P. 2

Safe Driving P. 27

Instrument Panel P. 69

Controls P. 87

Features P. 163

Driving P. 409

Maintenance P. 461

Handling the Unexpected P. 515

Information P. 545

Index P. 562

# Visual Index

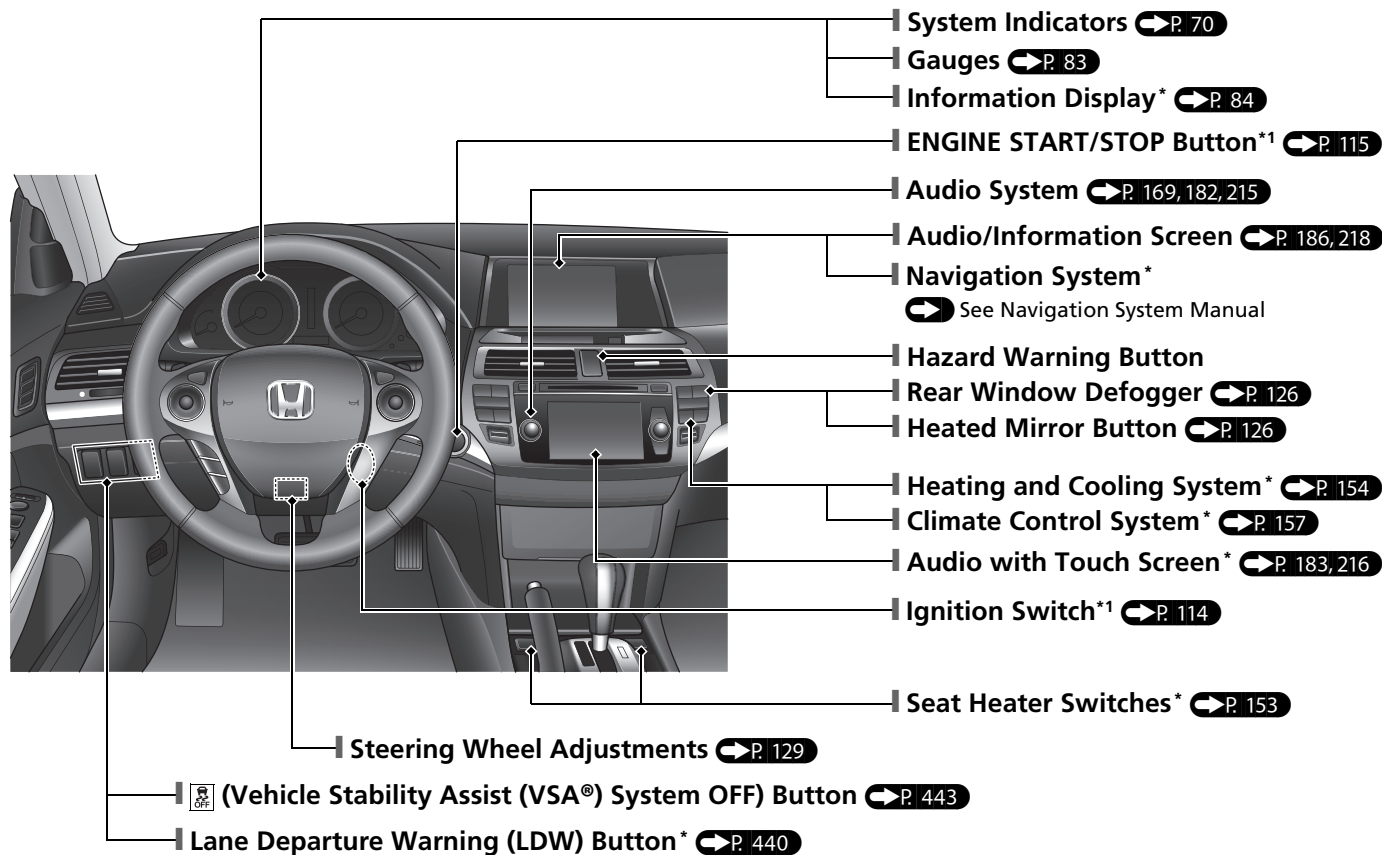

\*1: Models with the smart entry system have an **ENGINE START/STOP** button instead of an ignition switch.

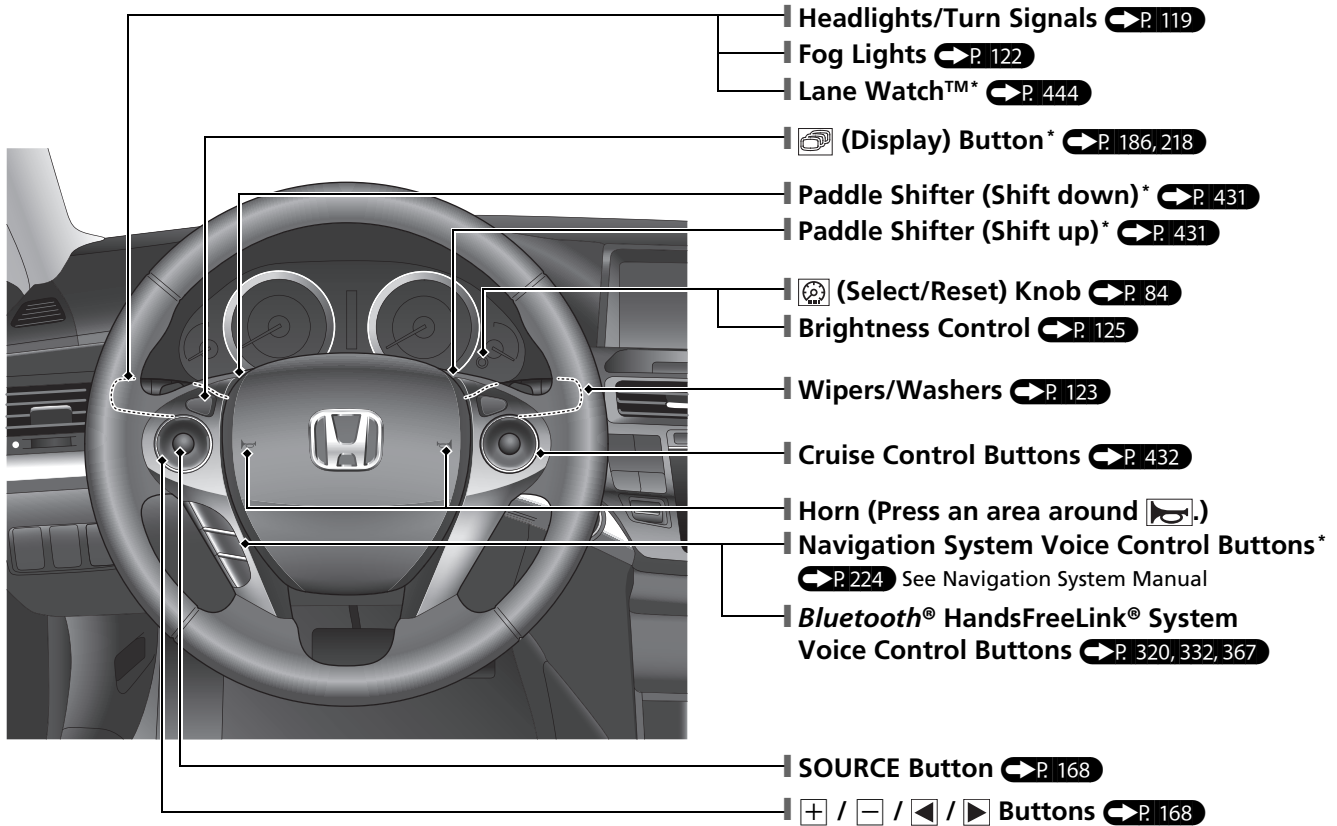

# Visual Index

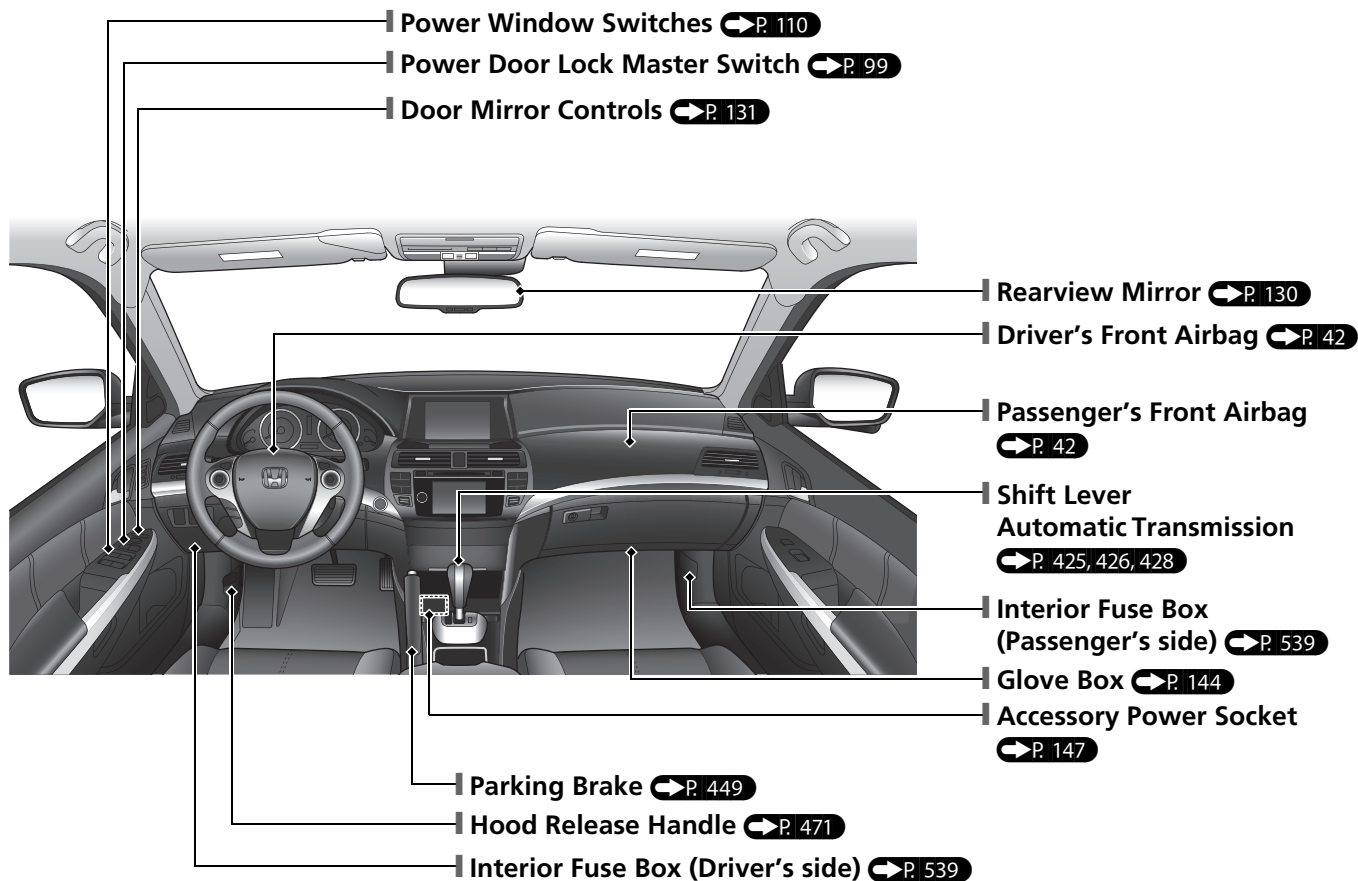

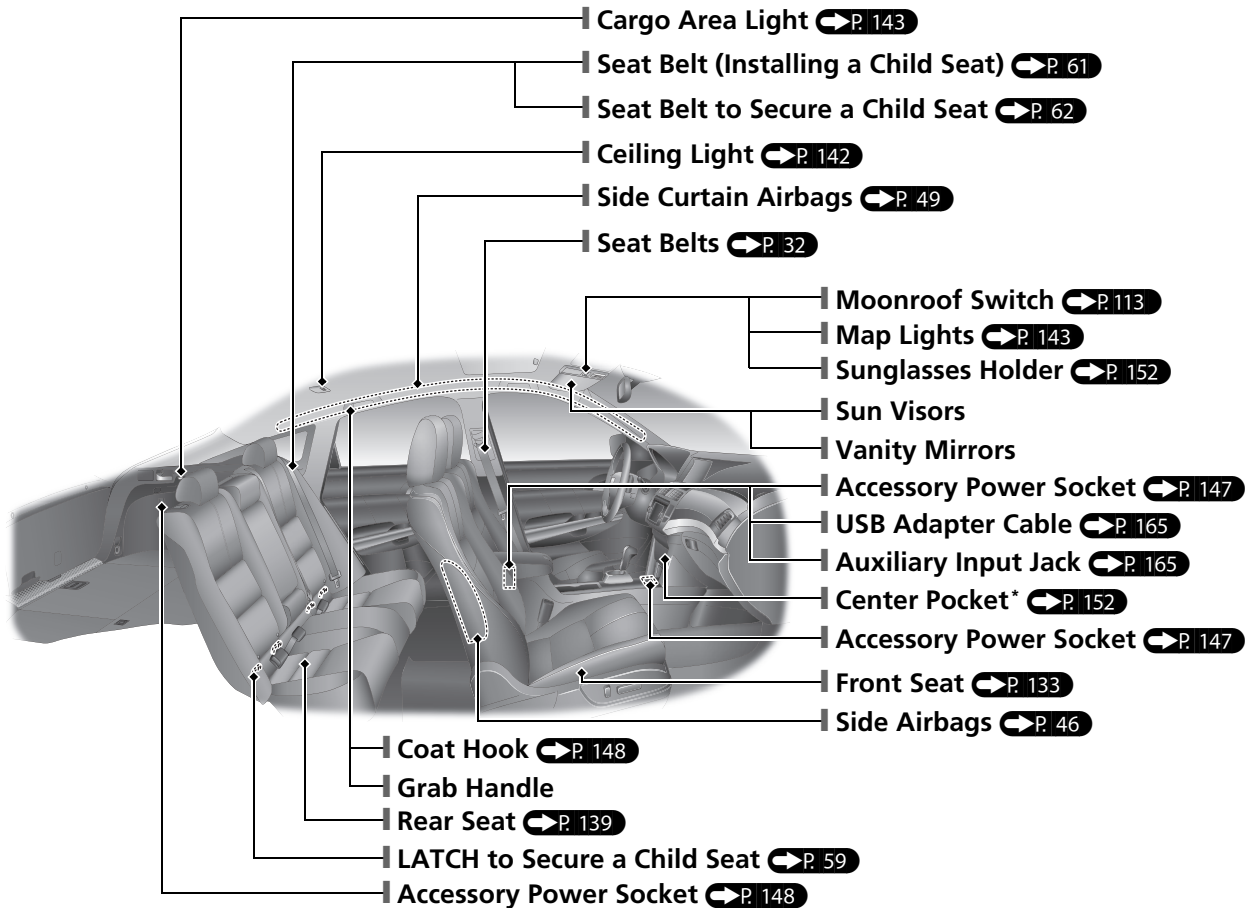

\* Not available on all models

# Visual Index

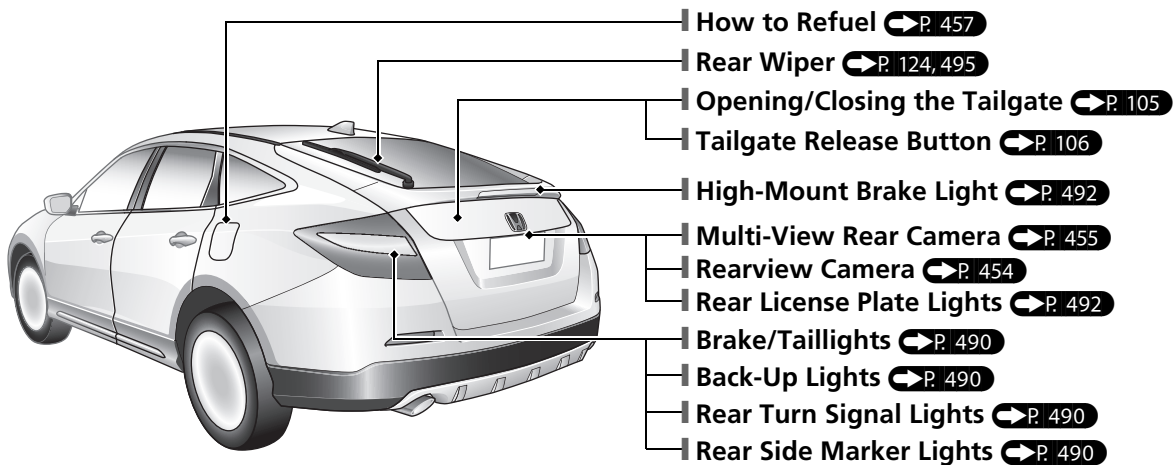
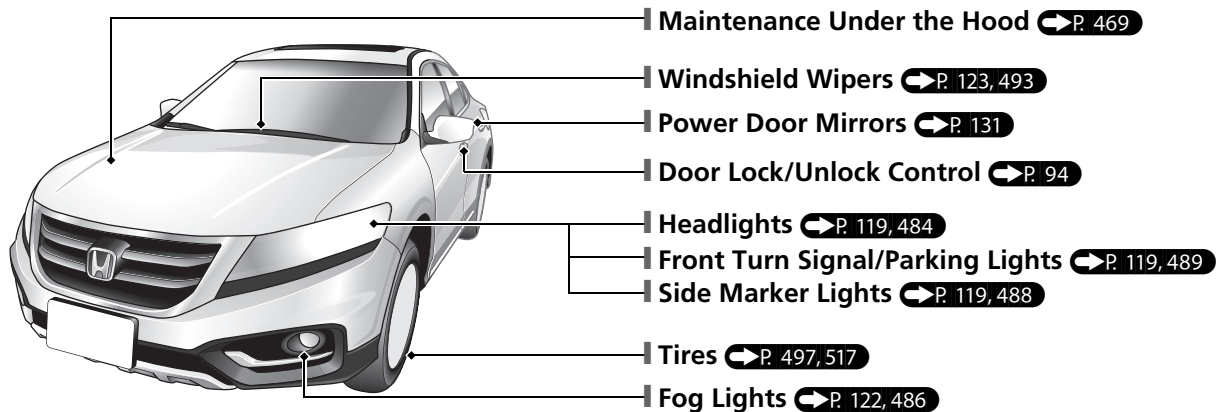



# Safe Driving P. 27

## Airbags P. 39

- Your vehicle is fitted with airbags to help protect you and your passengers during a moderate-to-severe collision.

## Child Safety P. 54

- All children 12 and younger should be seated in the rear seat.
- Smaller children should be properly restrained in a forward-facing child seat.
- Infants must be properly restrained in a rear-facing child seat.

## Exhaust Gas Hazard P. 66

- Your vehicle emits dangerous exhaust gases that contain carbon monoxide. Do not run the engine in confined spaces where carbon monoxide gas can accumulate.

## Seat Belts P. 32

- Fasten your seat belt and sit upright well back in the seat.
- Check that your passengers are wearing their seat belts correctly.

## Before Driving Checklist P. 31

- Before driving, check that the front seats, head restraints, steering wheel, and mirrors have been properly adjusted.

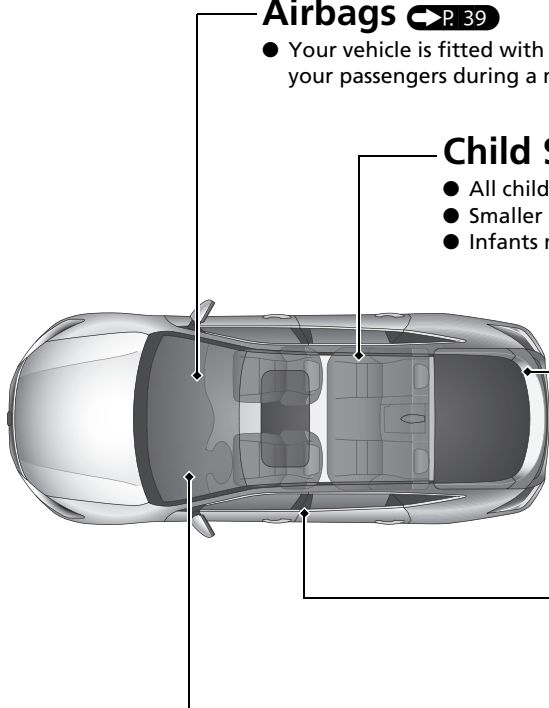











Fasten your lap belt as low as possible.

# Instrument Panel P. 69

Gauges  P. 83 / Information Display  P. 84 / System Indicators  P. 70

Quick Reference Guide

## System Indicators

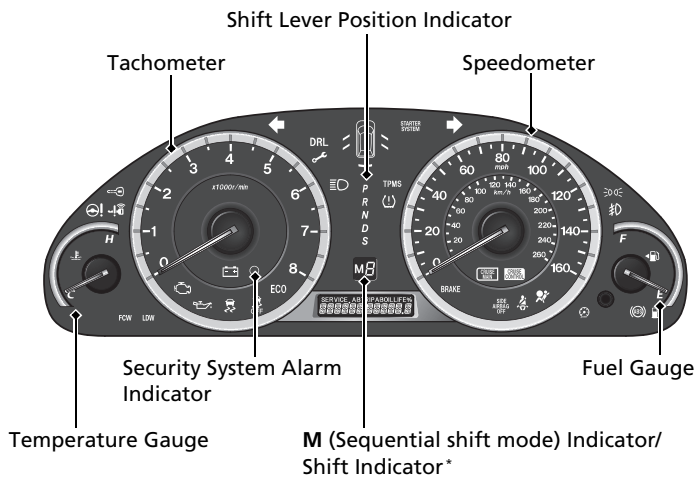

-  Malfunction Indicator Lamp
-  Low Oil Pressure Indicator
-  Charging System Indicator
-  Anti-lock Brake System (ABS) Indicator
-  Vehicle Stability Assist (VSA) System Indicator
-  VSA OFF Indicator
- ECO** Economy Fuel Indicator\*
-  Immobilizer System Indicator
- BRAKE**  
U.S.  Parking Brake and Brake System Indicator (Red)  
Canada  Smart Entry System Indicator\*
- STARTER SYSTEM**  
U.S.  Starter System Indicator\*  
Canada 











## System Indicators

- DRL** Daytime Running Lights Indicator
- TPMS** TPMS Indicator  
 Low Tire Pressure Indicator
- FCW** Forward Collision Warning (FCW) Indicator\*
- LDW** Lane Departure Warning (LDW) Indicator\*

## Lights Reminders

-  Lights On Indicator
-  High Beam Indicator
-  Fog Light Indicator

## System Indicators

-  Door and Tailgate Open Indicator
-  Turn Signal and Hazard Warning Indicators
-  Electric Power Steering (EPS) System Indicator\*
-  Low Fuel Indicator
-  Seat Belt Reminder Indicator
-  Supplemental Restraint System Indicator
- SIDE AIRBAG OFF U.S.**  
Canada  Side Airbag Off Indicator
- CRUISE MAIN** Indicator
- CRUISE CONTROL** Indicator
-  Maintenance Minder Indicator
-  Washer Level Indicator\*





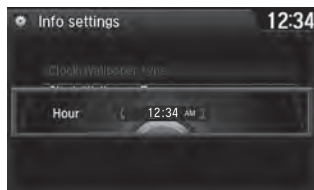

# Controls P. 87

## Clock P. 88

Models without navigation system

Audio system with touch screen



- 1 Press the **DISP** button, then select **Info Settings**.
- 2 Select **Clock Adjustment**.  
  P. 88
- 3 Rotate  to change hour, then press .
- 4 Rotate  to change minute, then press .

Audio system without touch screen



- 1 Press the **CLOCK** button until you hear a beep. The displayed time begins flashing.
- 2 Press the **4** (Hour) or **5** (Minute) button to set the time. Press the **6** (Reset) button to set the time to the nearest hour.
- 3 Press the **CLOCK** button again to set the time.

Models with navigation system

The navigation system receives signals from GPS satellites, updating the clock automatically.

These indicators are used to show how to operate the selector knob or the **MENU/SEL** (Menu/Selector) knob.

Rotate  to select.  
Press  to enter.

# ENGINE START/STOP Button\*

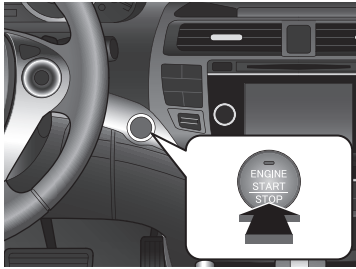

# Turn Signals

Turn Signal Control Lever



# Lights

Light Control Switches

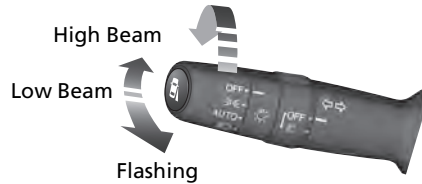

# Wipers and Washers

Wiper/Washer Control Lever

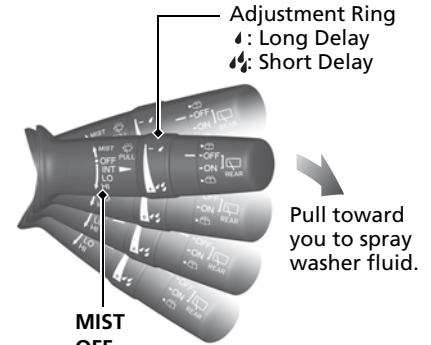

**MIST**  
**OFF**

**INT:** Low speed with intermittent  
**LO:** Low speed wipe  
**HI:** High speed wipe

## Steering Wheel P.129

- To adjust, push the adjustment lever down, adjust to the desired position, then lock the lever back in place.

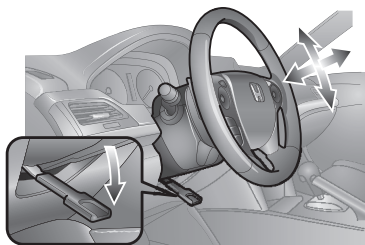

## Tailgate P.105

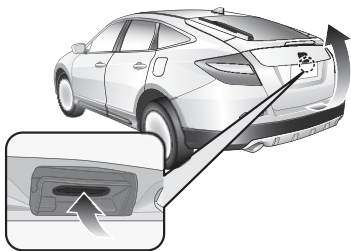

- With all the doors unlocked, push the tailgate release button on the tailgate to open it.

### Models with smart entry system

- Touch the tailgate release button to unlock and open the tailgate.

## Power Door Mirrors

### P.131

- With the ignition switch in ON <sup>\*1</sup>, move the selector switch to L or R.
- Push the appropriate edge of the adjustment switch to adjust the mirror.

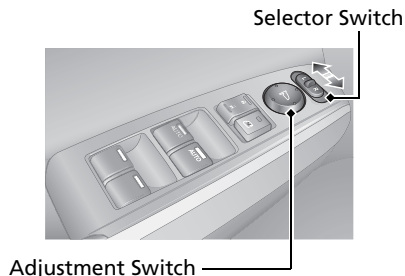





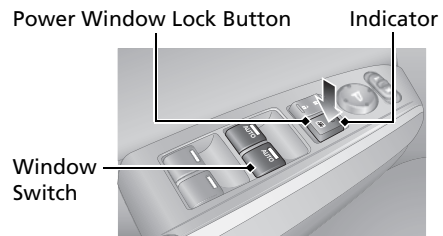

## Power Windows P.110

- With the ignition switch in ON <sup>\*1</sup>, open and close the power windows.
- If the power window lock button is in the off position, each passenger's window can be opened and closed with its own switch.
- If the power window lock button is in the on position (indicator is on), each passenger's window switch is disabled.





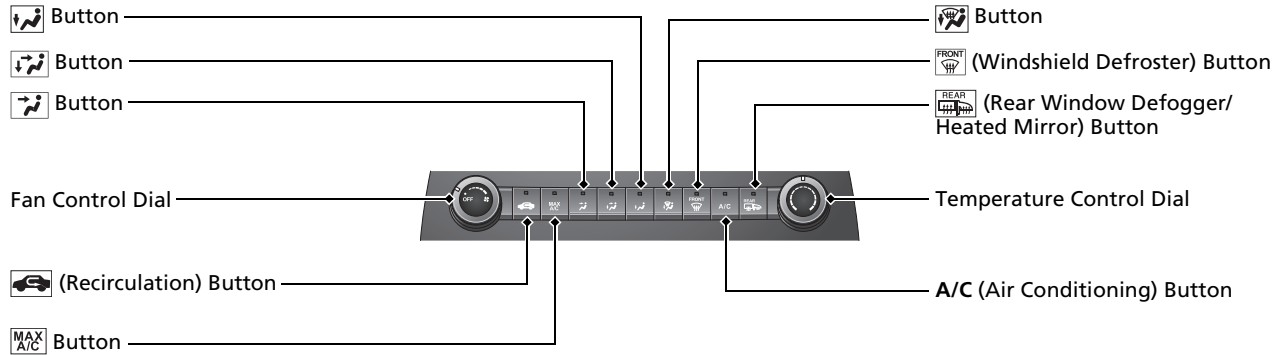

\*1: Models with the smart entry system have an **ENGINE START/STOP** button instead of an ignition switch.

## Heating and Cooling System\*

- Rotate the fan control dial to adjust the fan speed and airflow.
- Press the Mode buttons ( /  /  / ) to select the vents air flows from.
- Rotate the temperature control dial to adjust the temperature.
- Use the  button for maximum cool setting.
- Rotate the fan control dial to **OFF** to turn the system off.
- Press the  button to defrost the windshield.





### Mode Buttons





-  Air flows from dashboard vents, and back of the center console.
-  Air flows from floor and dashboard vents, and back of the center console.
-  Air flows from floor vents.
-  Air flows from floor and windshield defroster vents.

# Climate Control System\* P. 157

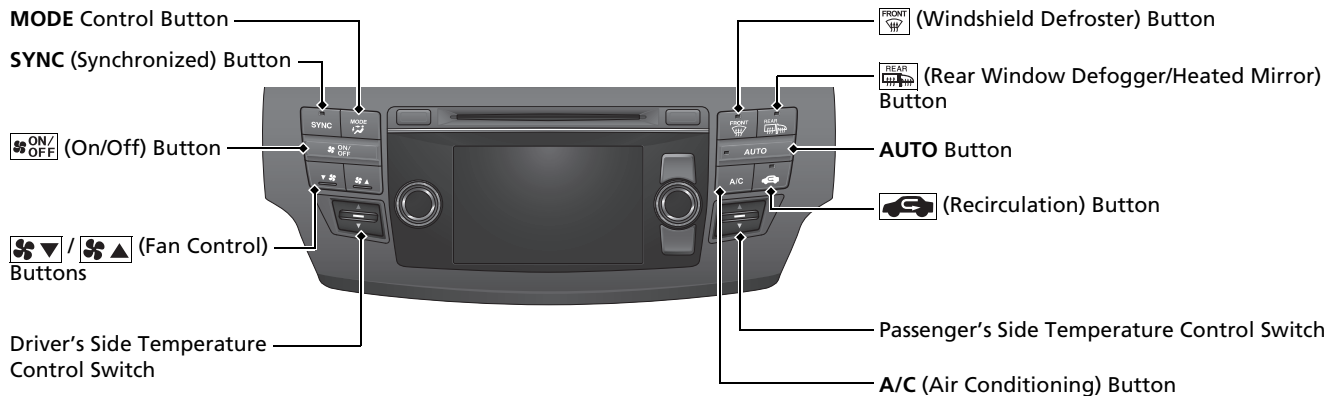
## Models with audio touch screen

- Press the **AUTO** button to activate the climate control system.
- Press the  button to turn the system on or off.
- Press the  button to defrost the windshield.





-  Air flows from dashboard vents and back of the center console.
-  Air flows from floor and dashboard vents, and back of the center console.
-  Air flows from floor vents.
-  Air flows from floor and windshield defroster vents.





## Models with navigation system

The climate control system is voice operable.  P. 226

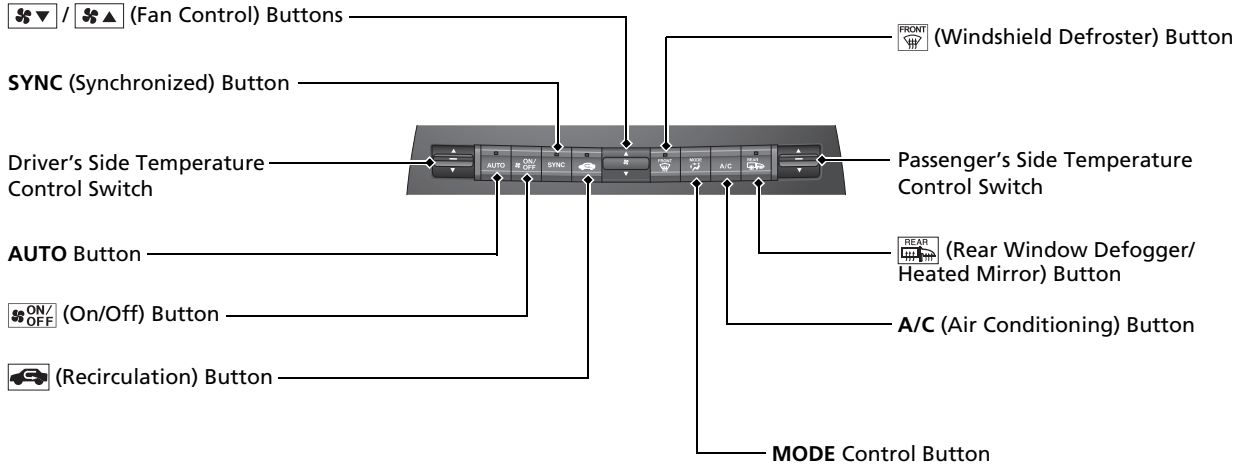
**Models without audio touch screen**

- Press the **AUTO** button to activate the climate control system.
- Press the  button to turn the system on or off.
- Press the  button to defrost the windshield.



-  Air flows from dashboard vents, and back of the center console.
-  Air flows from floor and dashboard vents, and back of the center console.
-  Air flows from floor vents.
-  Air flows from floor and windshield defroster vents.



# Features ➔ P. 163

## Audio Remote Controls

➔ P. 168

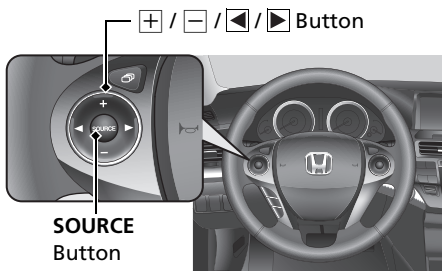

- **+ / - Button**  
Press and release to adjust the volume up/down.
- **SOURCE Button**  
Press and release to change the audio mode: FM/AM/CD/XM®\*/HDD\*/USB/iPod®/Bluetooth/Pandora®\*/Aha™\*/AUX.
- **◀ / ▶ Button**  
Radio: Press and release to change the preset station.  
Press and hold to select the next or previous strong station.  
CD/HDD\*/USB device:  
Press and release to skip to the beginning of the next song or return to the beginning of the current song.  
Press and hold to change a folder.

## Audio System ➔ P. 169, 182, 215

Audio system without touch screen ➔ P. 169

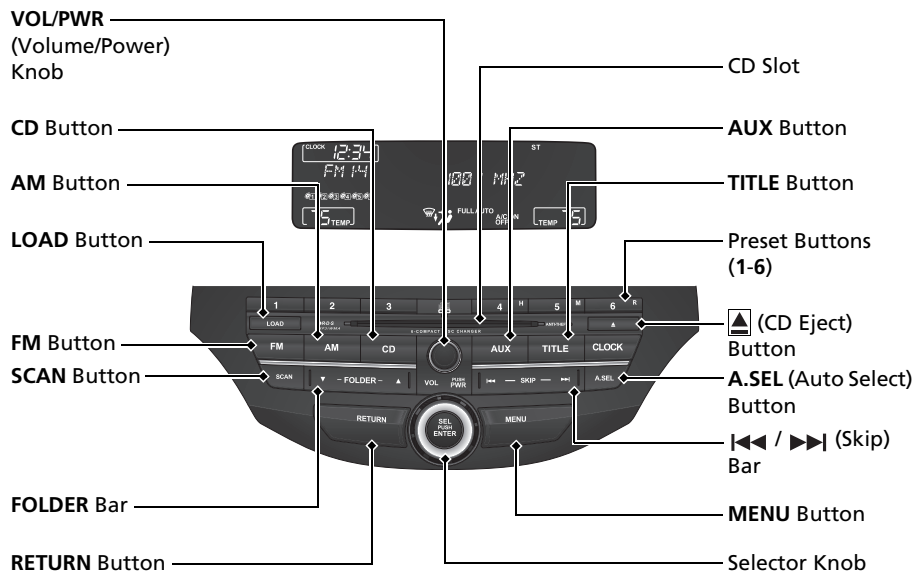

Models without navigation system

Audio system with touch screen → P. 182



\*1: Icons that appear on the screen vary by the source selected.

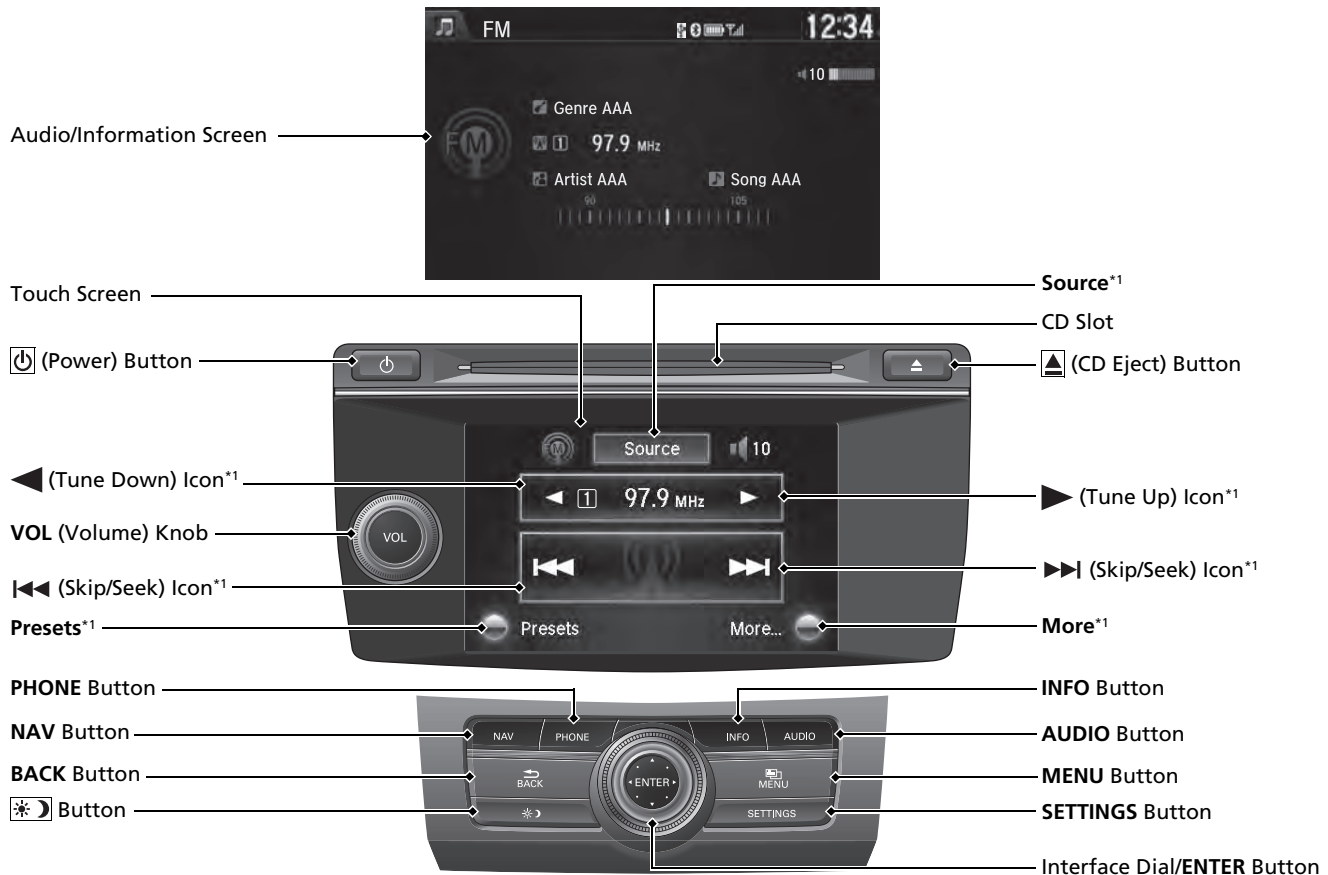

\*1: Icons that appear on the screen vary by the source selected.

# Driving ↔ P. 409

## Automatic Transmission ↔ P. 426, 428

- Shift to **P** and depress the brake pedal when starting the engine.

### Shifting

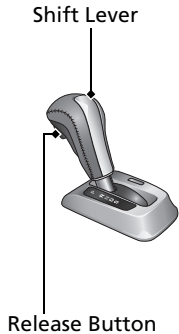
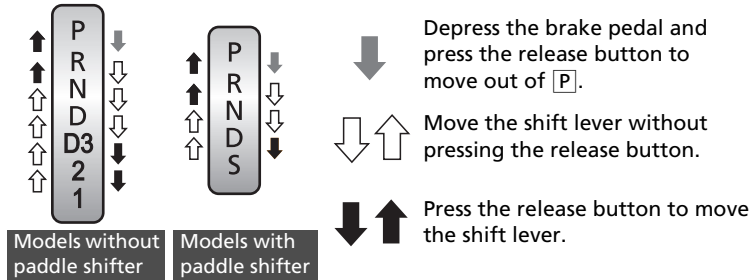

- P** **Park**  
Turn off or start the engine. Transmission is locked.
  - R** **Reverse**  
Used when reversing.
  - N** **Neutral**  
Transmission is not locked.
  - D** **Drive**  
Normal driving.  
On models with paddle shifter, D-paddle shift mode can be used.
- Models with paddle shifter**
- S** **S Position**  
Sequential shift mode can be used.

### Paddle Shifters ↔ P. 431

- Paddle shifters allow you to shift gears much like a manual transmission (1st through 6th). This is useful for engine braking.
- D-paddle shift mode: The transmission will shift back to automatic mode once the system detects that the vehicle is cruising.
- Sequential shift mode: Holds the selected gear, and the **M** indicator comes on.
- The selected gear position is shown in the instrument panel.

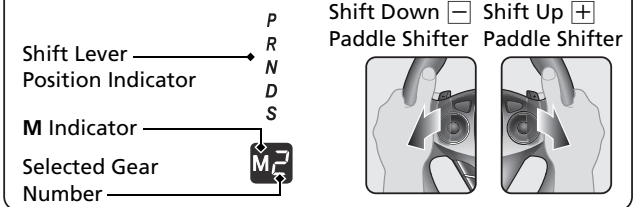

### Models without paddle shifter

- D3** **Drive (D3)**  
Used when:
  - Going up or down hills
  - Towing a trailer in hilly terrain
- 2** **Second**  
Used to increase engine braking (the transmission is locked in 2nd gear)
- 1** **First**  
Used to further increase engine braking (the transmission is locked in 1st gear)

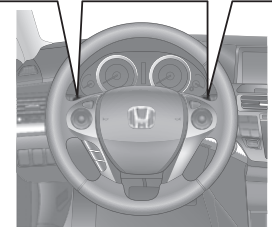

## VSA® OFF Button P. 443

- The vehicle stability assist (VSA®) system helps stabilize the vehicle during cornering, and helps maintain traction while accelerating on loose or slippery road surfaces.
- VSA® comes on automatically every time you start the engine.
- To turn VSA® on or off, press and hold the button until you hear a beep.

## Cruise Control P. 432

- Cruise control allows you to maintain a set speed without keeping your foot on the accelerator pedal.
- To use cruise control, press the **CRUISE** button, then press **-/SET** once you have received the desired speed (above 25 mph or 40 km/h).

## Tire Pressure Monitoring System (TPMS) P. 446

- TPMS monitors tire pressure.
- TPMS is turned on automatically every time you start the engine.

## Refueling P. 456

**Fuel recommendation:** Unleaded gasoline with a pump octane number 87 or higher required

**Fuel tank capacity:** 18.5 US gal (70 L)

- 1** Unlock the driver's door.
- 2** Press on the edge of the fuel fill door to make it pop up slightly.
- 3** Turn the fuel fill cap slowly to remove the cap.
- 4** Place the cap in the holder on the fuel fill door.
- 5** After refueling, screw the cap back on until it clicks at least once.

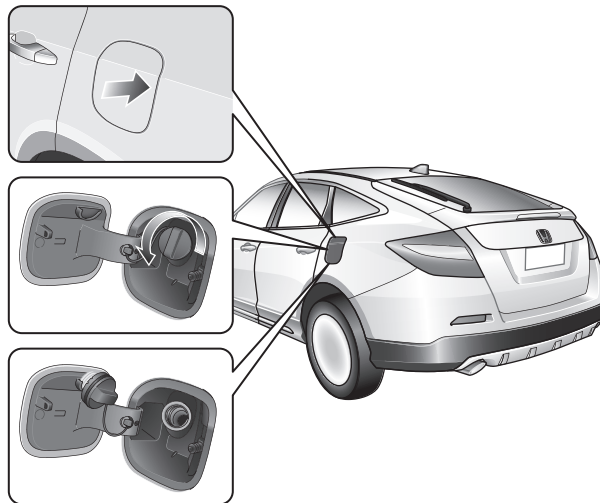

# Maintenance P. 461

## Under the Hood P. 469

- Check engine oil, engine coolant, and windshield washer fluid. Add when necessary.
- Check brake fluid.
- Check the battery regularly.

- 1 Pull the hood release handle under the corner of the dashboard.

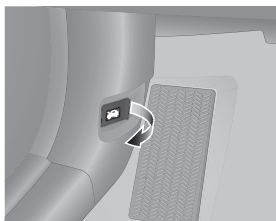

- 2 Locate the hood latch lever, pull the lever up, and lift up the hood.

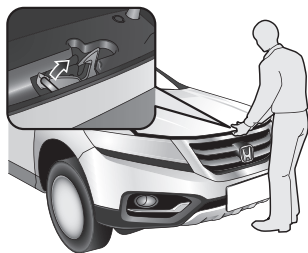

- 3 When finished, close the hood and make sure it is firmly locked in place.

## Wiper Blades P. 493

- Replace blades if they leave streaks across the windshield.

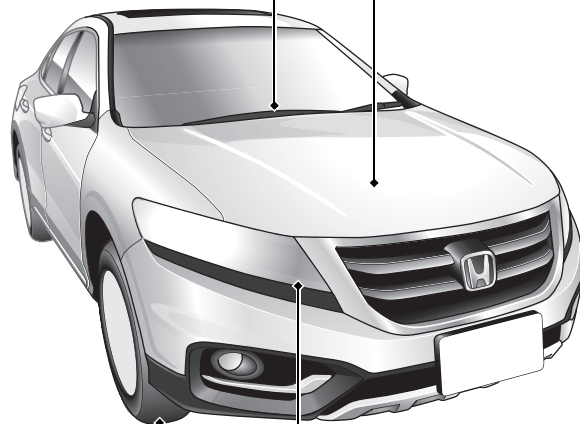

## Tires P. 497

- Inspect tires and wheels regularly.
- Check tire pressures regularly.
- Install snow tires for winter driving.

## Lights P. 484

- Inspect all lights regularly.

# Handling the Unexpected P. 515

## Flat Tire P. 517

- Park in a safe location and replace the flat tire with the compact spare tire in the cargo area.



## Indicators Come On

 P. 534

- Identify the indicator and consult the owner's manual.

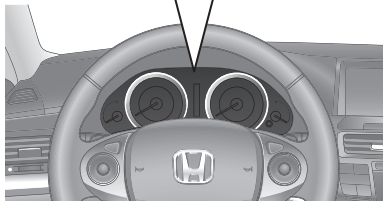

## Engine Won't Start

 P. 525

- If the battery is dead, jump start using a booster battery.

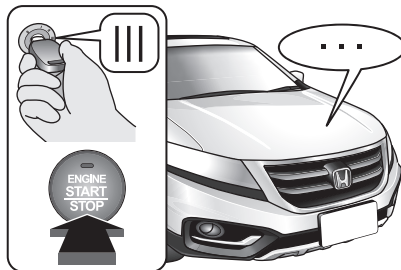

## Blown Fuse P. 538

- Check for a blown fuse if an electrical device does not operate.

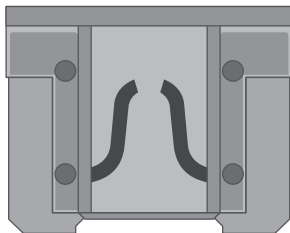

## Overheating P. 532

- Park in a safe location. If you do not see steam under the hood, open the hood, and let the engine cool down.



## Emergency Towing

 P. 542

- Call a professional towing service if you need to tow your vehicle.



# What to Do If

**Q** The ignition switch does not turn from **0** to **I**\*1. Why?

- A**
- The steering wheel may be locked.
  - Try to turn the steering wheel left and right while turning the ignition key\*.
  - Move the steering wheel left and right while pressing the **ENGINE START/STOP** button\* at the same time.



**Q** The ignition switch does not turn from **I** to **0**\*1 and I cannot remove the key. Why?

- A** The shift lever should be moved to **P**.



**Q** Why does the brake pedal pulsate slightly when applying the brakes?

- A** This can occur when the ABS activates, and does not indicate a problem. Apply firm, steady pressure on the brake pedal. Never pump the brake pedal.

**Q** The rear door cannot be opened from inside the vehicle. Why?

- A** Check if the childproof lock is in the lock position. If so, open the rear door with the outside door handle. To cancel this function, push the lever to the unlock position.



\*1: Models with the smart entry system have an **ENGINE START/STOP** button instead of an ignition switch.



---

**Q** Why do the doors lock after I unlocked the doors using a remote transmitter?

**A** If you do not open the doors within 30 seconds, the doors are relocked automatically for security.

---

**Q** Why does the beeper sound when I open the driver's door?

**A** The beeper sounds when:

- The key is left in the ignition switch\*.
- The power mode\* is in ACCESSORY.
- The exterior lights are left on.

---

**Q** Why does the beeper sound when I start driving?

**A** The beeper sounds when:

- Driver and/or front passenger are not wearing their seat belts.
- The parking brake lever is not fully released.

---

**Q** Why do I hear a screeching sound when I apply the brake pedal?

**A** The brake pads may need to be replaced. Have your vehicle inspected by a dealer.

---

## California Proposition 65 Warning

**WARNING:** This product contains or emits chemicals known to the state of California to cause cancer and birth defects or other reproductive harm.

### Event Data Recorders

**This vehicle is equipped with an event data recorder (EDR).**

The main purpose of an EDR is to record, in certain crash or near crash-like situations, such as an air bag deployment or hitting a road obstacle, data that will assist in understanding how a vehicle's systems performed. **The EDR is designed to record data related to vehicle dynamics and safety systems for a short period of time, typically 30 seconds or less. The EDR in this vehicle is designed to record such data as:**

- **How various systems in your vehicle were operating;**
- **Whether or not the driver and passenger safety belts were buckled/fastened;**
- **How far (if at all) the driver was depressing the accelerator and/or brake pedal; and,**
- **How fast the vehicle was traveling.**

These data can help provide a better understanding of the circumstances in which crashes and injuries occur. NOTE: EDR data are recorded by your vehicle only if a non-trivial crash situation occurs; no data are recorded by the EDR under normal driving conditions and no personal data (e.g., name, gender, age, and crash location) are recorded. However, other parties, such as law enforcement, could combine the EDR data with the type of personally identifying data routinely acquired during a crash investigation.

To read data recorded by an EDR, special equipment is required, and access to the vehicle or the EDR is needed. In addition to the vehicle manufacturer, other parties, such as law enforcement, that have the special equipment, can read the information if they have access to the vehicle or the EDR.

The data belongs to the vehicle owner and may not be accessed by anyone else except as legally required or with the permission of the vehicle owner.

### Service Diagnostic Recorders

This vehicle is equipped with service-related devices that record information about powertrain performance. The data can be used to verify emissions law requirements and/or help technicians diagnose and solve service problems. It may also be combined with data from other sources for research purposes, but it remains confidential.

### California Perchlorate Contamination Prevention Act

The airbags, seat belt tensioners, and CR type batteries in this vehicle may contain perchlorate materials - special handling may apply. See [www.dtsca.gov/hazardouswaste/perchlorate/](http://www.dtsca.gov/hazardouswaste/perchlorate/)

As you read this manual, you will find information that is preceded by a **NOTICE** symbol. This information is intended to help you avoid damage to your vehicle, other property, or the environment.

## A Few Words About Safety

---

Your safety, and the safety of others, is very important. And operating this vehicle safely is an important responsibility.

To help you make informed decisions about safety, we have provided operating procedures and other information on labels and in this manual. This information alerts you to potential hazards that could hurt you or others.

Of course, it is not practical or possible to warn you about all the hazards associated with operating or maintaining your vehicle. You must use your own good judgement.

You will find this important safety information in a variety of forms, including:

- **Safety Labels** - on the vehicle.
- **Safety Messages** - preceded by a safety alert symbol  and one of three signal words: **DANGER**, **WARNING**, or **CAUTION**. These signal words mean:

### **DANGER**

You **WILL** be **KILLED** or **SERIOUSLY HURT** if you don't follow instructions.

### **WARNING**

You **CAN** be **KILLED** or **SERIOUSLY HURT** if you don't follow instructions.

### **CAUTION**

You **CAN** be **HURT** if you don't follow instructions.

- **Safety Headings** - such as Important Safety Precautions.
- **Safety Section** - such as Safe Driving.
- **Instructions** - how to use this vehicle correctly and safely.

This entire book is filled with important safety information - please read it carefully.



# Safe Driving

You can find many safety recommendations throughout this chapter, and throughout this manual.

## **For Safe Driving**

Important Safety Precautions .....	28
Your Vehicle's Safety Features.....	30

## **Seat Belts**

About Your Seat Belts.....	32
Fastening a Seat Belt.....	35
Seat Belt Inspection.....	38

## **Airbags**

Airbag System Components.....	39
Types of Airbags .....	42
Front Airbags (SRS) .....	42
Side Airbags.....	46

Side Curtain Airbags .....	49
Airbag System Indicators.....	50
Airbag Care .....	53

## **Child Safety**

Protecting Child Passengers .....	54
Safety of Infants and Small Children .....	56
Safety of Larger Children .....	64

## **Exhaust Gas Hazard**

Carbon Monoxide Gas.....	66
--------------------------	----

## **Safety Labels**

Label Locations .....	67
-----------------------	----

The following pages explain your vehicle's safety features and how to use them properly. The safety precautions below are ones that we consider to be among the most important.

## Important Safety Precautions

### ■ Always wear your seat belt

A seat belt is your best protection in all types of collisions. Airbags are designed to supplement seat belts, not replace them. So even though your vehicle is equipped with airbags, make sure you and your passengers always wear your seat belts, and wear them properly.

### ■ Restrain all children

Children age 12 and under should ride properly restrained in a back seat, not the front seat. Infants and small children should be restrained in a child seat. Larger children should use a booster seat and a lap/shoulder seat belt until they can use the belt properly without a booster seat.

### ■ Be aware of airbag hazards

While airbags can save lives, they can cause serious or fatal injuries to occupants who sit too close to them, or are not properly restrained. Infants, young children, and short adults are at the greatest risk. Be sure to follow all instructions and warnings in this manual.

### ■ Don't drink and drive

Alcohol and driving don't mix. Even one drink can reduce your ability to respond to changing conditions, and your reaction time gets worse with every additional drink. So don't drink and drive, and don't let your friends drink and drive, either.

### ⓘ Important Safety Precautions

Some states, provinces and territories prohibit the use of cell phones other than hands-free devices by the driver while driving.

■ **Pay appropriate attention to the task of driving safely**

Engaging in cell phone conversation or other activities that keep you from paying close attention to the road, other vehicles, and pedestrians could lead to a crash. Remember, situations can change quickly, and only you can decide when it is safe to divert some attention away from driving.

■ **Control your speed**

Excessive speed is a major factor in crash injuries and deaths. Generally, the higher the speed, the greater the risk, but serious injuries can also occur at lower speeds. Never drive faster than is safe for current conditions, regardless of the maximum speed posted.

■ **Keep your vehicle in safe condition**

Having a tire blowout or a mechanical failure can be extremely hazardous. To reduce the possibility of such problems, check your tire pressures and condition frequently, and perform all regularly scheduled maintenance.

## Your Vehicle's Safety Features

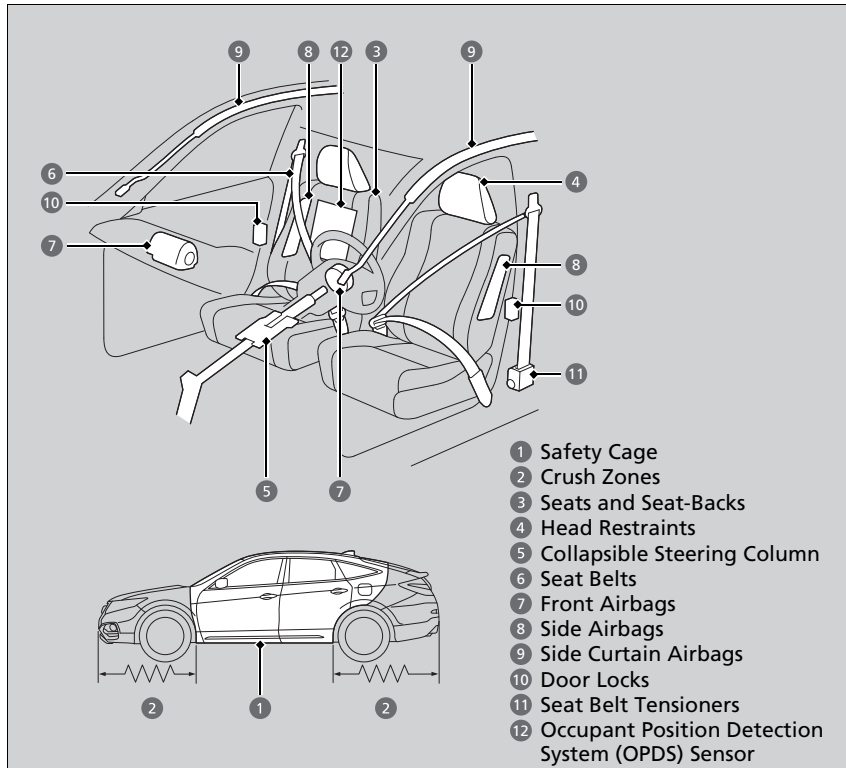

The following checklist will help you take an active role in protecting yourself and your passengers.

### ►► Your Vehicle's Safety Features

Your vehicle is equipped with many features that work together to help protect you and your passengers during a crash.

Some features do not require any action on your part. These include a strong steel framework that forms a safety cage around the passenger compartment, front and rear crush zones, a collapsible steering column, and tensioners that tighten the front seat belts in a sufficient crash.

However, you and your passengers cannot take full advantage of these features unless you remain seated in the correct position and always wear your seat belts. In fact, some safety features can contribute to injuries if they are not used properly.



## Safety Checklist

For the safety of you and your passengers, make a habit of checking these items each time before you drive.

- After everyone has entered the vehicle, be sure all doors and the tailgate are closed and locked. Locking the doors and the tailgate helps prevent an occupant from being ejected and an outsider from unexpectedly opening a door or the tailgate.

### ➤ Locking/Unlocking the Doors from the Inside P. 99

- Adjust your seat to a position suitable for driving. Be sure the front seats are adjusted as far to the rear as possible while allowing the driver to control the vehicle. Sitting too close to a front airbag can result in serious or fatal injury in a crash.

### ➤ Adjusting the Seats P. 133

- Adjust head restraints to the proper position. Head restraints are most effective when the center of the head restraint aligns with the center of your head. Taller persons should adjust their head restraint to the highest position.

### ➤ Adjusting the Head Restraints P. 136

- Always wear your seat belt, and make sure you wear it properly. Confirm that any passengers are properly belted as well.

### ➤ Fastening a Seat Belt P. 35

- Protect children by using seat belts or child seats according to a child's age, height and weight.

### ➤ Child Safety P. 54

## ➤ Safety Checklist

If the door and tailgate open indicator is on, a door and/or the tailgate is not completely closed. Close all doors and the tailgate tightly until the indicator goes off.

### ➤ Door and Tailgate Open Indicator P. 74

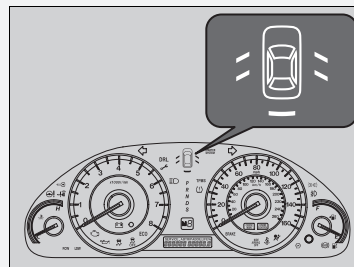

## About Your Seat Belts

Seat belts are the single most effective safety device because they keep you connected to the vehicle so that you can take advantage of many built-in safety features. They also help keep you from being thrown against the inside of the vehicle, against other passengers, or out of the vehicle. When worn properly, seat belts also keep your body properly positioned in a crash so that you can take full advantage of the additional protection provided by the airbags.

In addition, seat belts help protect you in almost every type of crash, including:

- frontal impacts
- side impacts
- rear impacts
- rollovers

### ■ Lap/shoulder seat belts

All five seating positions are equipped with lap/shoulder seat belts with emergency locking retractors. In normal driving the retractor lets you move freely while keeping some tension on the belt. During a collision or sudden stop the retractor locks to restrain your body. The rear seat belts also have a lockable retractor for use with child seats.

➤ **Installing a Child Seat with a Lap/Shoulder Seat Belt** P. 61

### ➤ About Your Seat Belts

## **WARNING**

**Not wearing a seat belt properly increases the chance of serious injury or death in a crash, even though your vehicle has airbags.**

**Be sure you and your passengers always wear seat belts and wear them properly.**

Seat belts cannot completely protect you in every crash. But in most cases, seat belts can reduce your risk of serious injury.

Most states and all Canadian provinces and territories require you to wear seat belts.

## ■ Proper use of seat belts

Follow these guidelines for proper use:

- All occupants should sit upright, well back in the seat, and remain in that position for the duration of the trip. Slouching and leaning reduces the effectiveness of the belt and can increase the chance of serious injury in a crash.
- Never place the shoulder part of a lap/shoulder seat belt under your arm or behind your back. This could cause very serious injuries in a crash.
- Two people should never use the same seat belt. If they do, they could be very seriously injured in a crash.
- Do not put any accessories on the seat belts. Devices intended to improve comfort or reposition the shoulder part of a seat belt can reduce the protective capability and increase the chance of serious injury in a crash.

## ■ Seat Belt Reminder

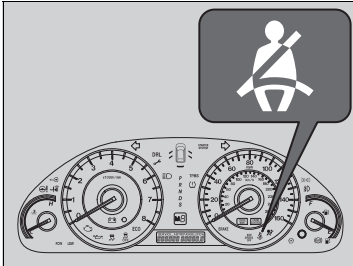

Your vehicle monitors front seat belt use. If the ignition switch is turned to ON **II**\*<sup>1</sup> before the driver's seat belt is fastened, a beeper will sound and the indicator will blink. If the driver does not fasten the belt before the beeper stops, the indicator will remain on.

The beeper will also periodically sound and the indicator will blink while driving until the driver's and front passenger's seat belts are fastened.

\*1: Models with the smart entry system have an **ENGINE START/STOP** button instead of an ignition switch.

### ⌘ About Your Seat Belts

If a rear seat passenger moves around and extends the seat belt, the lockable retractor may activate. If this happens, release the retractor by unfastening the seat belt and allow the belt to retract completely. Then refasten the belt.

### ⌘ Seat Belt Reminder

The indicator will also come on if a front passenger does not fasten their seat belt within 6 seconds after the ignition switch is turned to ON **II**\*<sup>1</sup>. When no one is sitting in the front passenger's seat, or a child or small adult is riding there, the indicator will not come on. This is because the weight sensors in the seat cannot detect their presence.

## Automatic Seat Belt Tensioners

The front seats are equipped with automatic seat belt tensioners to enhance safety.

The tensioners automatically tighten the front seat belts during a moderate-to-severe frontal collision, sometimes even if the collision is not severe enough to inflate the front airbags.

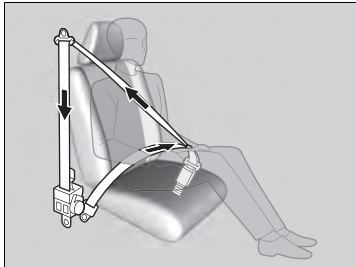

### Automatic Seat Belt Tensioners

The seat belt tensioners can only operate once. If a tensioner is activated, the SRS indicator will come on. Have a dealer replace the tensioner and thoroughly inspect the seat belt system as it may not offer protection in a subsequent crash.

## Fastening a Seat Belt

After adjusting a front seat to the proper position, and while sitting upright and well back in the seat:

🔧 **Adjusting the Seats** P. 133

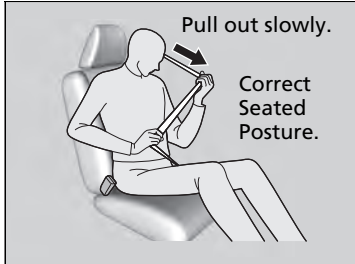

1. Pull the seat belt out slowly.

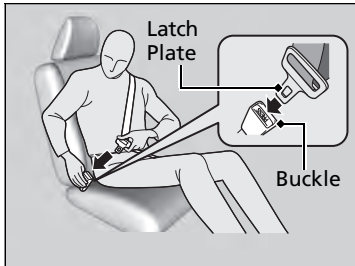

2. Insert the latch plate into the buckle, then tug on the belt to make sure the buckle is secure.

▶ Make sure that the belt is not twisted or caught on anything.

### 🔧 Fastening a Seat Belt

No one should sit in a seat with an inoperative seat belt or one that does not appear to be working correctly. Using a seat belt that is not working properly may not protect the occupant in a crash. Have a dealer check the belt as soon as possible.

Never insert any foreign objects into the buckle or retractor mechanism.



3. Position the lap part of the belt as low as possible across your hips, then pull up on the shoulder part of the belt so the lap part fits snugly. This lets your strong pelvic bones take the force of a crash and reduces the chance of internal injuries.
4. If necessary, pull up on the belt again to remove any slack, then check that the belt rests across the center of your chest and over your shoulder. This spreads the forces of a crash over the strongest bones in your upper body.

### Adjusting the Shoulder Anchor

The front seats have adjustable shoulder anchors to accommodate taller and shorter occupants.

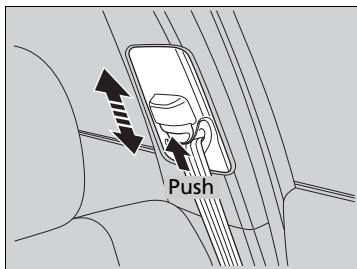

1. Move the anchor up and down while holding the release button.
2. Position the anchor so that the belt rests across the center of your chest and over your shoulder.

### Fastening a Seat Belt

#### **⚠ WARNING**

Improperly positioning the seat belts can cause serious injury or death in a crash.

**Make sure all seat belts are properly positioned before driving.**

To release the belt, push the red **PRESS** button then guide the belt by hand until it has retracted completely.

When exiting the vehicle, be sure the belt is out of the way and will not get caught by closing the door.

### Adjusting the Shoulder Anchor

The shoulder anchor height can be adjusted to four levels. If the belt contacts your neck, lower the height one level at a time.

After an adjustment, make sure that the shoulder anchor position is secure.

## Advice for Pregnant Women

If you are pregnant, the best way to protect yourself and your unborn child when driving or riding in a vehicle is to always wear a seat belt and keep the lap part of the belt as low as possible across the hips.

Wear the shoulder belt across the chest avoiding the abdomen.



Wear the lap part of the belt as low as possible across the hips.

## Advice for Pregnant Women

Each time you have a checkup, ask your doctor if it is okay for you to drive.

To reduce the risk of injuries to both you and your unborn child that can be caused by an inflating front airbag:

- When driving, sit upright and adjust the seat as far back as possible while allowing full control of the vehicle.
- When sitting in the front passenger's seat, adjust the seat as far back as possible.

## Seat Belt Inspection

Regularly check the condition of your seat belts as follows:

- Pull each belt out fully, and look for frays, cuts, burns, and wear.
- Check that the latches work smoothly and the belts retract easily.
  - ▶ If a belt does not retract easily, cleaning the belt may correct the problem. Only use a mild soap and warm water. Do not use bleach or cleaning solvents. Make sure the belt is completely dry before allowing it to retract.

Any belt that is not in good condition or working properly will not provide proper protection and should be replaced as soon as possible.

A belt that has been worn during a crash may not provide the same level of protection in a subsequent crash. Have your seat belts inspected by a dealer after any collision.

### ▶▶ Seat Belt Inspection

#### **WARNING**

**Not checking or maintaining seat belts can result in serious injury or death if the seat belts do not work properly when needed.**

**Check your seat belts regularly and have any problem corrected as soon as possible.**



## Airbag System Components

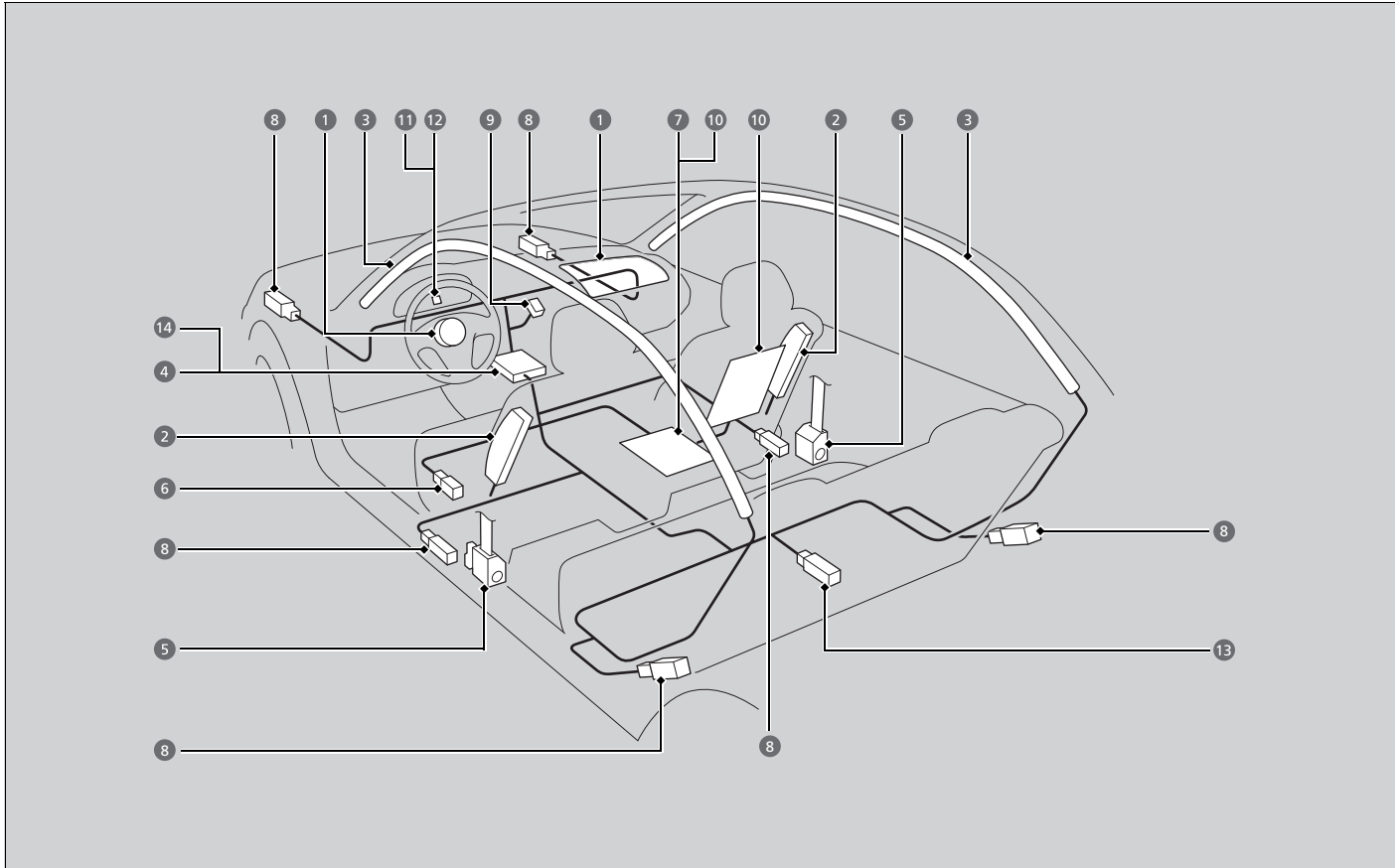

The front, front side, and side curtain airbags are deployed according to the direction and severity of impact. Both side curtain airbags are deployed in a rollover. The airbag system includes:

- ① Two SRS (Supplemental Restraint System) front airbags. The driver's airbag is stored in the center of the steering wheel; the front passenger's airbag is stored in the dashboard. Both are marked **SRS AIRBAG**.
- ② Two side airbags, one for the driver and one for a front passenger. The airbags are stored in the outer edges of the seat-backs. Both are marked **SIDE AIRBAG**.
- ③ Two side curtain airbags, one for each side of the vehicle. The airbags are stored in the ceiling, above the side windows. The front and rear pillars are marked **SIDE CURTAIN AIRBAG**.
- ④ An electronic control unit that continually monitors and records information about the sensors, the airbag activators, the seat belt tensioners, and driver and front passenger seat belt use when the ignition switch is in ON \*1.
- ⑤ Automatic front seat belt tensioners. The driver's and front passenger's seat belts incorporate sensors that detect whether or not they are fastened.
- ⑥ A driver's seat position sensor. If the seat is too far forward, the airbag will inflate with less force.
- ⑦ Weight sensors in the front passenger's seat. The front passenger's airbag will be turned off if the weight on the seat is 65 lbs (29 kg) or less (the weight of an infant or small child).
- ⑧ Impact sensors that can detect a moderate-to-severe front or side collision.
- ⑨ An indicator on the dashboard that alerts you that the front passenger's front airbag has been turned off.
- ⑩ Sensors that can detect if a child or small statured adult is in the deployment path of the front passenger's side airbag.
- ⑪ An indicator on the instrument panel that alerts you to a possible problem with your airbag system or seat belt tensioners.
- ⑫ An indicator on the instrument panel that alerts you that the front passenger's side airbag has been turned off.
- ⑬ Safing Sensor
- ⑭ A rollover sensor that detects whether the vehicle is about to roll over.

\*1: Models with the smart entry system have an **ENGINE START/STOP** button instead of an ignition switch.

## Important Facts About Your Airbags

Airbags can pose serious hazards. To do their job, airbags must inflate with tremendous force. So, while airbags help save lives, they can cause burns, bruises, and other minor injuries, sometimes even fatal ones if occupants are not wearing their seat belts properly and sitting correctly.

**What you should do:** Always wear your seat belt properly, and sit upright and as far back from the steering wheel as possible while allowing full control of the vehicle. A front passenger should move their seat as far back from the dashboard as possible.

Remember, however, that no safety system can prevent all injuries or deaths that can occur in a severe crash, even when seat belts are properly worn and the airbags deploy.

**Do not place hard or sharp objects between yourself and a front airbag.**

Carrying hard or sharp objects on your lap, or driving with a pipe or other sharp object in your mouth, can result in injuries if your front airbag inflates.

**Do not attach or place objects on the front airbag covers.** Objects on the covers marked **SRS AIRBAG** could interfere with the proper operation of the airbags or be propelled inside the vehicle and hurt someone if the airbags inflate.

## Important Facts About Your Airbags

Do not attempt to deactivate your airbags. Together, airbags and seat belts provide the best protection.

When driving, keep hands and arms out of the deployment path of the front airbag by holding each side of the steering wheel. Do not cross an arm over the airbag cover.

## Types of Airbags

Your vehicle is equipped with three types of airbags:

- **Front airbags:** Airbags in front of the driver's and front passenger's seats.
- **Side airbags:** Airbags in the driver's and front passenger's seat-backs.
- **Side curtain airbags:** Airbags above the side windows.

Each is discussed in the following pages.

### Front Airbags (SRS)

The front SRS airbags inflate in a moderate-to-severe frontal collision to help protect the head and chest of the driver and/or front passenger.

**SRS** (Supplemental Restraint System) indicates that the airbags are designed to supplement seat belts, not replace them. Seat belts are the occupant's primary restraint system.

#### Housing Locations

The front airbags are housed in the center of the steering wheel for the driver, and in the dashboard for the front passenger. Both airbags are marked **SRS AIRBAG**.

\*1: Models with the smart entry system have an **ENGINE START/STOP** button instead of an ignition switch.

#### Types of Airbags

The airbags can inflate whenever the ignition switch is in ON \*1.

After an airbag inflates in a crash, you may see a small amount of smoke. This is from the combustion process of the inflator material and is not harmful. People with respiratory problems may experience some temporary discomfort. If this occurs, get out of the vehicle as soon as it is safe to do so.

#### Front Airbags (SRS)

##### Dual-Stage, Multiple-Threshold Front Airbags (SRS)

Your vehicle is equipped with dual-stage, multiple-threshold front airbags (SRS).

During a frontal crash severe enough to cause one or both front airbags to deploy, the airbags can inflate at different rates, depending on the severity of the crash, whether or not the seat belts are latched, and/or other factors. Frontal airbags are designed to supplement the seat belts to help reduce the likelihood of head and chest injuries in frontal crashes.

## ■ Operation

Front airbags are designed to inflate during moderate-to-severe frontal collisions. When the vehicle decelerates suddenly, the sensors send information to the control unit which signals one or both front airbags to inflate.

A frontal collision can be either head-on or angled between two vehicles, or when a vehicle crashes into a stationary object, such as a concrete wall.

## ■ How the Front Airbags Work

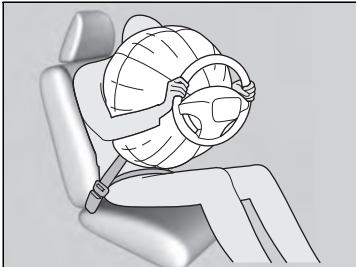

While your seat belt restrains your torso, the front airbag provides supplemental protection for your head and chest.

The front airbags deflate immediately so that they won't interfere with the driver's visibility or the ability to steer or operate other controls.

The total time for inflation and deflation is so fast that most occupants are not aware that the airbags deployed until they see them lying in front of them.

## ▣ How the Front Airbags Work

Although the driver's and front passenger's airbags normally inflate within a split second of each other, it is possible for only one airbag to deploy. This can happen if the severity of a collision is at the margin, or threshold, that determines whether or not the airbags will deploy. In such cases, the seat belt will provide sufficient protection, and the supplemental protection offered by the airbag would be minimal.

### ■ When front airbags should not deploy

**Minor frontal crashes:** Front airbags were designed to supplement seat belts and help save lives, not to prevent minor scrapes, or even broken bones that might occur during a less than moderate-to-severe frontal crash.

**Side impacts:** Front airbags can provide protection when a sudden deceleration causes a driver or front passenger to move towards the front of the vehicle. Side airbags and side curtain airbags have been specifically designed to help reduce the severity of injuries that can occur during a moderate-to-severe side impact which can cause the driver or passenger to move towards the side of the vehicle.

**Rear impacts:** Head restraints and seat belts are your best protection during a rear impact. Front airbags cannot provide any significant protection and are not designed to deploy in such collisions.

**Rollovers:** Seat belts and, in vehicles equipped with a rollover sensor, side airbags and side curtain airbags offer the best protection in a rollover. Because front airbags could provide little if any protection, they are not designed to deploy during a rollover.

### ■ When front airbags deploy with little or no visible damage

Because the airbag system senses sudden deceleration, a strong impact to the vehicle framework or suspension might cause one or more of the airbags to deploy. Examples include running into a curb, the edge of a hole, or other low fixed object that causes a sudden deceleration in the vehicle chassis. Since the impact is underneath the vehicle, damage may not be readily apparent.

### ■ When front airbags may not deploy, even though exterior damage appears severe

Since crushable body parts absorb crash energy during an impact, the amount of visible damage does not always indicate proper airbag operation. In fact, some collisions can result in severe damage but no airbag deployment because the airbags would not have been needed or would not have provided protection even if they had deployed.

## Advanced Airbags

Your front airbags have advanced features to help reduce the likelihood of airbag related injuries to smaller occupants.

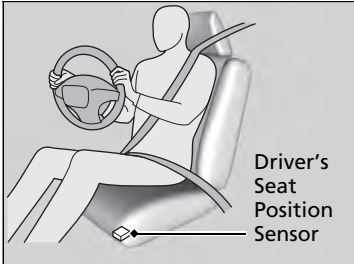

The driver's advanced front airbag system includes a seat position sensor.

If the seat is too far forward, the airbag inflates with less force, regardless of the severity of the impact.

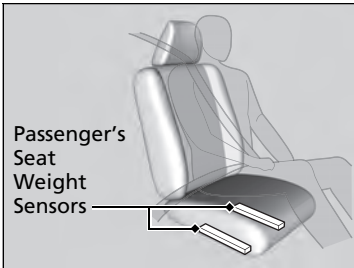

The passenger's advanced front airbag system has weight sensors.

Although we recommend against carrying an infant or small child in front, if the sensors detect the weight of a child (up to about 65 lbs or 29 kg), the system will automatically turn off the passenger's front airbag.

### Advanced Airbags

If there is a problem with the driver's seat position sensor, the SRS indicator will come on and the airbag will inflate with full (normal) force, regardless of the driver's seating position.

For both advanced front airbags to work properly:

- Do not spill any liquid on or under the seats.
- Do not put any object under the passenger's seat.
- Make sure any objects are positioned properly on the floor. Improperly positioned objects can interfere with the advanced airbag sensors.
- All occupants should sit upright and wear their seat belts properly.
- Do not place any cover over the passenger side dashboard.

## Side Airbags

The side airbags help protect the upper torso of the driver or a front passenger during a moderate to severe side impact.

### Housing Locations

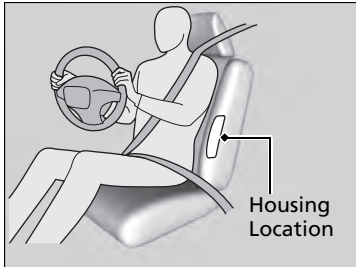

The side airbags are housed in the outside edge of the driver's and passenger's seat-backs.

Both are marked **SIDE AIRBAG**.

### Operation

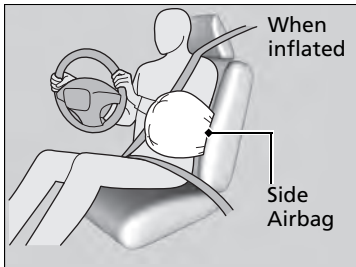

When the sensors detect a moderate-to-severe side impact, the control unit signals the side airbag on the impact side to immediately inflate.

### Side Airbags

Do not attach accessories on or near the side airbags. They can interfere with the proper operation of the airbags, or hurt someone if an airbag inflates.

If the impact is on the passenger's side, the airbag may not deploy when there is no passenger in the front passenger seat.

Do not cover or replace the front seat-back covers without consulting a dealer.

Improperly replacing or covering front seat-back covers can prevent your side airbags from properly deploying during a side impact.



**■ When a side airbag deploys with little or no visible damage**

Because the airbag systems senses sudden acceleration, a strong impact to the side of the vehicle's framework can cause a side airbag to deploy. In such cases, there may be little or no damage, but the side impact sensors detected a severe enough impact to deploy the airbag.

**■ When a side airbag may not deploy, even though visible damage appears severe**

It is possible for a side airbag to not deploy during an impact that results in apparently severe damage. This can occur when the point of impact was towards the far front or rear of the vehicle, or when the vehicle's crushable body parts absorbed most of the crash energy. In either case, the side airbag would not have been needed nor provided protection even if it had deployed.

## ■ Side Airbag Cutoff System

To reduce the likelihood that a front passenger may be injured by an inflating side airbag, the passenger side airbag is automatically turned off when:

- The height sensors detect a child or short-statured adult is seated in the front passenger seat.
- The position sensor detects that the front passenger is leaning into the deployment path of the side airbag.

When the side airbag cutoff system is activated, the side airbag off indicator comes on.

➤ **Side Airbag Off Indicator** P. 52

## ■ Side Airbag Off Indicator

If the side airbag off indicator comes on, have the passenger sit upright. A few seconds after the passenger is sitting properly, the side airbag will automatically be turned on, and the indicator will go off.

If the front passenger is a child, stop when it is safe to do so, and have the child sit properly restrained in a rear seat.

## ▶▶ Side Airbag Cutoff System

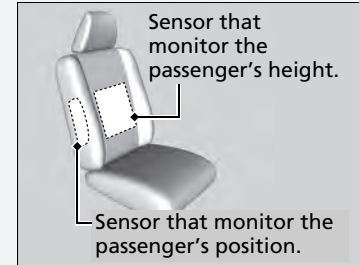

The sensors that monitor the front passenger's height and body position may not work if:

- The seat-back is wet
- The passenger is touching a metal or other electrical conductive object
- A seat cushion is on the seat
- The passenger is wearing excessively thick clothing

## Side Curtain Airbags

Side curtain airbags help protect the heads of the driver and passengers in outer seating positions during a moderate-to-severe side impact. The side curtain airbags equipped in this vehicle are also designed to help reduce the likelihood of partial and complete ejection of vehicle occupants through side windows in crashes, particularly rollover crashes.

### Housing Locations

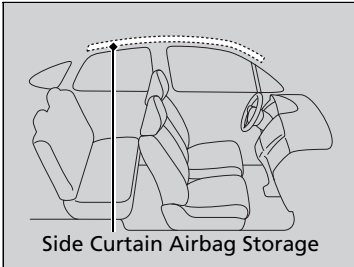

The side curtain airbags are located in the ceiling above the side windows on both sides of the vehicle.

### Operation

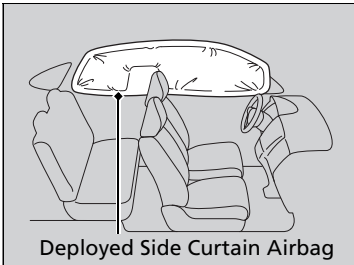

The side curtain airbag is designed to deploy in a rollover or a moderate-to-severe side impact.

### Side Curtain Airbags

If the SRS control unit senses that your vehicle is about to rollover, it immediately deploys both side curtain airbags and activates both front seat belt tensioners.

The airbag on the passenger's side will deploy, and the seat belt tensioner will activate, even if there are no passengers on that side of the vehicle.

To get the best protection from the side curtain airbags, occupants should wear their seat belts properly and sit upright and well back in their seats.

Do not attach any objects to the side windows or roof pillars as they can interfere with the proper operation of the side curtain airbags.

### ■ When side curtain airbags deploy in a frontal collision

One or both side curtain airbags may inflate in a moderate-to-severe angled frontal collision.

In this case, the side curtain airbags will deploy slightly after the front airbags.

## Airbag System Indicators

If a problem occurs in the airbag system, the SRS indicator will come on.

### ■ SRS (Supplemental Restraint System) Indicator

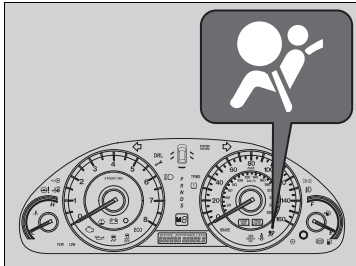

#### ■ When the ignition switch is turned to ON \*1

The indicator comes on for a few seconds, then goes off. This tells you the system is working properly.

If the indicator comes on at any other time, or does not come on at all, have the system checked by a dealer as soon as possible. If you don't, your airbags and seat belt tensioners may not work properly when they are needed.

\*1: Models with the smart entry system have an **ENGINE START/STOP** button instead of an ignition switch.

 SRS (Supplemental Restraint System) Indicator

### **WARNING**

Ignoring the SRS indicator can result in serious injury or death if the airbag systems or tensioners do not work properly.

Have your vehicle checked by a dealer as soon as possible if the SRS indicator alerts you to a possible problem.

## Passenger Airbag Off Indicator

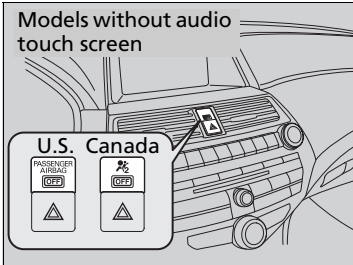
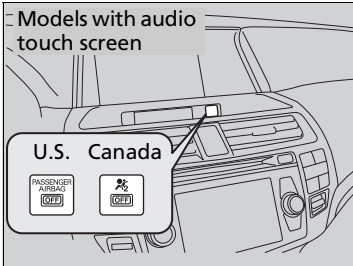

### When the passenger airbag off indicator comes on

The indicator comes on to alert you that the passenger's front airbag has been turned off. This occurs when the front passenger's weight sensors detect 65 lbs (29 kg) or less, the weight of an infant or small child, on the seat.

Infants and small children should always ride properly restrained in a back seat.

**Child Safety** P. 54

Objects placed on the seat can also cause the indicator to come on.

If the front passenger seat is empty, the passenger's front airbag will not deploy and the indicator will not come on.

### Passenger Airbag Off Indicator

If the indicator comes on with no front passenger and no objects on the passenger's seat, or with an adult riding there, something may be interfering with the weight sensors. Such as:

- An object hanging on the seat or in the seat-back pocket.
- A child seat or other object pressing against the rear of the seat-back.
- A rear passenger pushing or pulling on the back of the front passenger's seat.
- The front seat or seat-back is forced back against an object on the seat or floor behind it.
- An object placed under the front passenger's seat.

If none of these conditions exist, have your vehicle checked by a dealer as soon as possible.

The passenger airbag off indicator may come on and goes off repeatedly if the total weight on the seat is near the airbag cutoff threshold.

Continued

## ■ Side Airbag Off Indicator

### ■ When the side airbag off indicator comes on

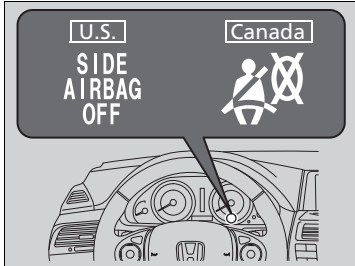

This indicator comes on if the passenger's side airbag has been turned off because the passenger is too small to be sitting in the front seat, is slouching or not sitting upright, or has leaned into the airbag's deployment path.

Unless the passenger is a smaller statured adult or a child, the indicator should go off when the passenger returns to a proper upright sitting position.

### ▶▶ Side Airbag Off Indicator

When you turn the ignition switch to ON **II**\*<sup>1</sup>, the indicator should come on for a few seconds and then go out. If it doesn't come on, stays on, or comes on while driving without a passenger in the front seat, have the system checked by a dealer as soon as possible.

\*1: Models with the smart entry system have an **ENGINE START/STOP** button instead of an ignition switch.

## Airbag Care

---

You do not need to, and should not, perform any maintenance on or replace any airbag system components yourself. However, you should have your vehicle inspected by a dealer in the following situations:

### ■ When the airbags have deployed

If an airbag has inflated, the control unit and other related parts must be replaced. Similarly, once an automatic seat belt tensioner has been activated, it must be replaced.

### ■ When the vehicle has been in a moderate-to-severe collision

Even if the airbags did not inflate, have your dealer inspect the following: the driver's seat position sensor, weight sensors in the passenger's seat, front seat belt tensioners, and each seat belt that was worn during the crash.

### ■ Do not remove or modify a front seat without consulting a dealer

This would likely disable the driver's seat position sensor or the weight sensors in the passenger's seat. If it is necessary to remove or modify a front seat to accommodate a person with disabilities, contact a Honda dealer, or for U.S. vehicles, American Honda Automobile Customer Service at 800-999-1009 and for Canadian vehicles, Honda Canada Customer Relations at 888-9-HONDA-9.

#### ⌘ Airbag Care

We recommend against the use of salvaged airbag system components, including the airbag, tensioners, sensors, and control unit.

## Protecting Child Passengers

Each year, many children are injured or killed in vehicle crashes because they are either unrestrained or not properly restrained. In fact, vehicle accidents are the number one cause of death of children age 12 and under.

To reduce the number of child deaths and injuries, every state, Canadian province and territory requires that infants and children be properly restrained when they ride in a vehicle.

**Children should sit properly restrained in a rear seat.** This is because:

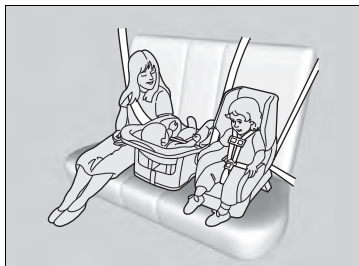

- An inflating front or side airbag can injure or kill a child sitting in the front seat.
- A child in the front seat is more likely to interfere with the driver's ability to safely control the vehicle.
- Statistics show that children of all sizes and ages are safer when they are properly restrained in a rear seat.

### Protecting Child Passengers

## **WARNING**

**Children who are unrestrained or improperly restrained can be seriously injured or killed in a crash.**

**Any child too small for a seat belt should be properly restrained in a child seat. A larger child should be properly restrained with a seat belt, using a booster seat if necessary.**

The National Highway Traffic Safety Administration and Transport Canada recommend that all children age 12 and under be properly restrained in a rear seat. Some states or provinces/territories have laws restricting where children may ride.



- Any child who is too small to wear a seat belt correctly must be restrained in an approved child seat that is properly secured to the vehicle using either the lap belt portion of the lap/shoulder belt or the lower anchors of the LATCH system.
- Never hold a child on your lap because it is impossible to protect them in the event of a collision.
- Never put a seat belt over yourself and a child. During a crash, the belt would likely press deep into the child and cause serious or fatal injuries.
- Never let two children use the same seat belt. Both children could be very seriously injured in a crash.
- Do not allow children to operate the doors, windows or seat adjustments.
- Do not leave children in the vehicle unattended, especially in hot weather when the inside of the vehicle can get hot enough to kill them. They could also activate vehicle controls causing it to move unexpectedly.

## ▶▶ Protecting Child Passengers

**⚠ WARNING**

Allowing a child to play with a seat belt or wrap one around their neck can result in serious injury or death.

**Instruct children not to play with any seat belt and make sure any unused seat belt a child can reach is buckled, fully retracted, and locked.**

To deactivate a lockable retractor, release the buckle and allow the seat belt to wind up all the way.

To remind you of the passenger's front airbag hazards and child safety, your vehicle has warning labels on the dashboard (U.S. models) and on the front visors. Please read and follow the instructions on these labels.

▶▶ **Safety Labels** P. 67

## Safety of Infants and Small Children

### ■ Protecting Infants

An infant must be properly restrained in a rear-facing, reclining child seat until the infant reaches the seat maker's weight or height limit for the seat, and the infant is at least one year old.

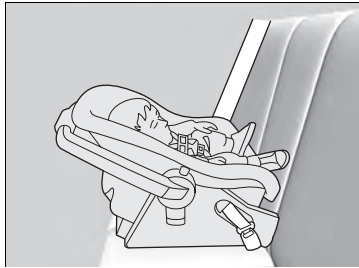

#### ■ Positioning a rear-facing child seat

Child seats must be placed and secured in a rear seating position.

When properly installed, a rear-facing child seat may prevent the driver or a front passenger from moving their seat all the way back, or from locking their seat-back in the desired position.

It can also interfere with proper operation of the passenger's advanced front airbag system.

➤ **Airbags** P. 39

If this occurs, we recommend that you install the child seat directly behind the front passenger's seat, move the seat as far forward as needed, and leave it unoccupied. Or, you may wish to get a smaller rear-facing child seat.

### ▶▶ Protecting Infants

#### **⚠ WARNING**

Placing a rear-facing child seat in the front seat can result in serious injury or death during a crash.

Always place a rear-facing child seat in the rear seat, not the front.

Rear-facing child seats should never be installed in a forward facing position.

Always refer to the child seat manufacturer's instructions before installation.

## Protecting Smaller Children

If a child is at least one year old and within the weight range indicated by the child seat manufacturer, the child should be properly restrained in a firmly secured forward-facing child seat.

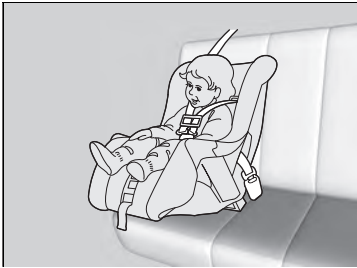

### Forward-facing child seat placement

We strongly recommend placing a forward-facing child seat in a rear seating position.

Placing a forward-facing child seat in the front seat can be hazardous, even with advanced front airbags that automatically turn the passenger's front airbag off. A rear seat is the safest place for a child.

## Protecting Smaller Children

### WARNING

Placing a forward-facing child seat in the front seat can result in serious injury or death if the front airbag inflates.

If you must place a forward-facing child seat in front, move the vehicle seat as far back as possible, and properly restrain the child.

Educate yourself about the laws and regulations regarding child seat use where you are driving, and follow the child seat manufacturer's instructions.

Many experts recommend use of a rear-facing seat up to age two, if the child's height and weight are appropriate for a rear-facing seat.

## ■ Selecting a Child Seat

Most child seats are LATCH-compatible (Lower Anchors and Tethers for Children). Some have a rigid-type connector, while others have a flexible-type connector. Both are equally easy to use. Some existing and previously owned child seats can only be installed using the seat belt. Whichever type you choose, follow the child seat manufacturer's use and care instructions as well as the instructions in this manual. Proper installation is key to maximizing your child's safety.

In seating positions and vehicles not equipped with LATCH, a LATCH compatible child seat can be installed using the seat belt and a top tether for added security. This is because all child seats are required to be designed so that they can be secured with a lap belt or the lap part of a lap/shoulder belt. In addition, the child seat manufacturer may advise that a seat belt be used to attach a LATCH-compatible seat once a child reaches a specified weight. Please read the child seat owner's manual for proper installation instructions.

### ■ Important consideration when selecting a child seat

Make sure the child seat meets the following three requirements:

- The child seat is the correct type and size for the child.
- The child seat is the correct type for the seating position.
- The child seat is compliant with Federal Motor Vehicle Safety Standard 213 or Canadian Motor Vehicle Safety Standard 213.

## ► Selecting a Child Seat

Installation of a LATCH-compatible child seat is simple.

LATCH-compatible child seats have been developed to simplify the installation process and reduce the likelihood of injuries caused by incorrect installation.

## ■ Installing a LATCH-Compatible Child Seat

A LATCH-compatible child seat can be installed in either of the two outer rear seats. A child seat is attached to the lower anchors with either the rigid or flexible type of connectors.

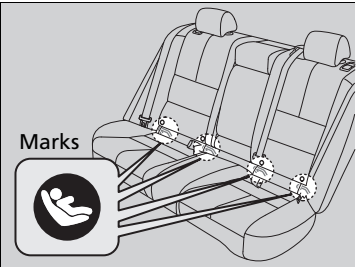

1. Locate the lower anchors under the marks.

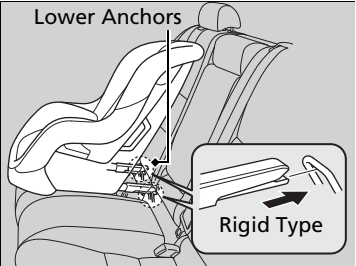

2. Place the child seat on the vehicle seat then attach the child seat to the lower anchors according to the instructions that came with the child seat.  
▶ When installing the child seat, make sure that the lower anchors are not obstructed by the seat belt or any other object.

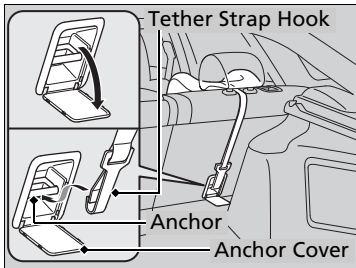
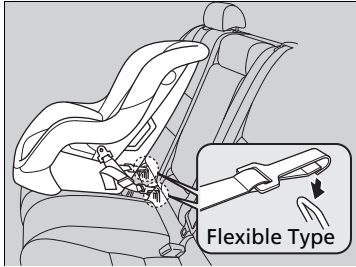

3. Open the tether anchor cover behind the seat-back.
4. Raise the head restraint to its highest position, then route the tether strap between the head restraint legs, and secure the tether strap hook onto the anchor. Make sure the strap is not twisted.
5. Tighten the tether strap as instructed by the child seat maker.
6. Make sure the child seat is firmly secured by rocking it forward and back and side to side; little movement should be felt.
7. Make sure any unused seat belt that a child can reach is buckled, the lockable retractor is activated, and the belt is fully retracted and locked.

#### ▶▶ Installing a LATCH-Compatible Child Seat

For your child's safety, when using a child seat installed using the LATCH system, make sure that the seat is properly secured to the vehicle. A child seat that is not properly secured will not adequately protect a child in a crash and may cause injury to the child or other vehicle occupants.

## ■ Installing a Child Seat with a Lap/Shoulder Seat Belt



1. Place the child seat on the vehicle seat.
2. Route the seat belt through the child seat according to the seat maker's instructions, and insert the latch plate into the buckle.
  - ▶ Insert the latch plate fully until it clicks.

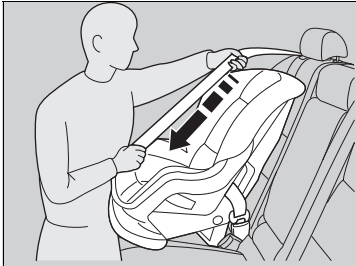

3. Slowly pull the shoulder part of the belt all the way out until it stops. This activates the lockable retractor.
4. Let the seat belt completely wind up into the retractor, then try to pull it out to make sure the retractor is locked.
  - ▶ If you are able to pull the shoulder belt out, the lockable retractor is not activated. Pull the seat belt all the way out, and repeat steps 3 – 4.



5. Grab the shoulder part of the seat belt near the buckle, and pull up to remove any slack from the lap part of the belt.
  - ▶ When doing this, place your weight on the child seat and push it into the vehicle seat.

### ⊠ Installing a Child Seat with a Lap/Shoulder Seat Belt

A child seat that is not properly secured will not adequately protect a child in a crash and may cause injury to the child or other vehicle occupants.

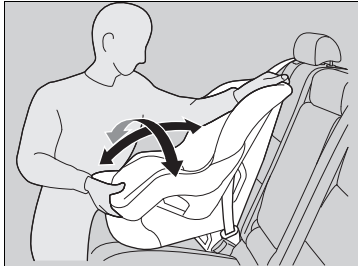

6. Make sure the child seat is firmly secured by rocking it forward and back and side to side; little movement should be felt.
7. Make sure any unused seat belt that a child can reach is buckled, the lockable retractor is activated, and the belt is fully retracted and locked.

#### ►► Installing a Child Seat with a Lap/Shoulder Seat Belt

To deactivate a lockable retractor, release the buckle and allow the seat belt to wind up all the way.

#### ►► Adding Security with a Tether

Since a tether can provide additional security to the lap/shoulder seat belt installation, we recommend using a tether whenever one is available.

### ■ Adding Security with a Tether

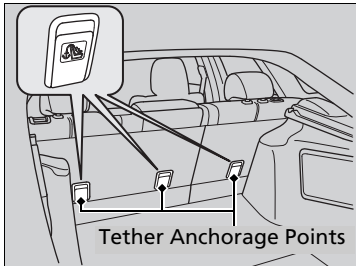

A tether anchorage point is provided behind each rear seating position. A child seat that is installed with a seat belt and comes with a tether can use the tether for additional security.



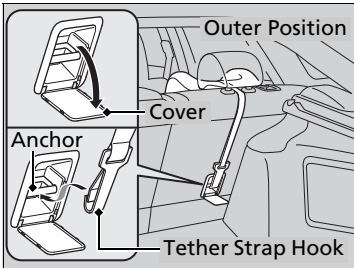

■ **Using an outer anchor**

1. Raise the head restraint to its highest position, then route the tether strap through the head restraint legs. Make sure the strap is not twisted.
2. Open the anchor cover.
3. Secure the tether strap hook onto the anchor.
4. Tighten the tether strap as instructed by the child seat manufacturer.

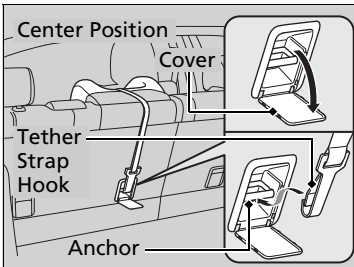

■ **Using the center anchor**

1. Lower the head restraint to its lowest position.
2. Open the anchor cover.
3. Route the tether strap over the head restraint. Make sure the strap is not twisted.
4. Secure the tether strap hook onto the anchor.
5. Tighten the tether strap as instructed by the child seat manufacturer.

## Safety of Larger Children

### ■ Protecting Larger Children

The following pages give instructions on how to check proper seat belt fit, what kind of booster seat to use if one is needed, and important precautions for a child who must sit in front.

### ■ Checking Seat Belt Fit

When a child is too big for a child seat, secure the child in a rear seat using the lap/shoulder seat belt. Have the child sit upright and all the way back, then answer the following questions.



#### ■ Checklist

- Do the child's knees bend comfortably over the edge of the seat?
- Does the shoulder belt cross between the child's neck and arm?
- Is the lap part of the seat belt as low as possible, touching the child's thighs?
- Will the child be able to stay seated like this for the whole trip?

If you answer yes to all these questions, the child is ready to wear the lap/shoulder seat belt correctly. If you answer no to any question, the child needs to ride on a booster seat until the seat belt fits properly without a booster seat.

### ▶ Safety of Larger Children

## ⚠ WARNING

Allowing a child age 12 or under to sit in front can result in injury or death if the passenger's front airbag inflates.

If a larger child must ride in front, move the vehicle seat as far to the rear as possible, have the child sit up properly and wear the seat belt properly, using a booster seat if needed.

## Booster Seats



If a lap/shoulder seat belt cannot be used properly, position the child in a booster seat in a rear seating position. For the child's safety, check that the child meets the booster seat manufacturer's recommendations.

## Protecting Larger Children-Final Checks

Your vehicle has a rear seat where children can be properly restrained. If you ever have to carry a group of children, and a child must ride in front:

- Make sure you read and fully understand the instructions and safety information in this manual.
- Move the front passenger seat as far back as possible.
- Have the child sit upright and well back in the seat.
- Check that the seat belt is properly positioned so that the child is secure in the seat.

## Monitoring child passengers

We strongly recommend that you keep an eye on child passengers. Even older, more mature children sometimes need to be reminded to fasten their seat belts and sit up properly.

### Booster Seats

When installing a booster seat, make sure to read the instructions that came with it, and install the seat accordingly.

There are high- and low-type booster seats. Choose a booster seat that allows the child to wear the seat belt correctly.

Some U.S. states and Canadian provinces and territories require children to use a booster seat until they reach a given age or weight (e.g. 6 years or 60 lbs). Be sure to check current laws in the state or province, or territory where you intend to drive.

## Carbon Monoxide Gas

The engine exhaust from this vehicle contains carbon monoxide, a colorless, odorless, and highly toxic gas. As long as you properly maintain your vehicle, carbon monoxide gas will not get into the interior.

### ■ Have the exhaust system inspected for leaks whenever

- The exhaust system is making an unusual noise.
- The exhaust system may have been damaged.
- The vehicle is raised for an oil change.

When you operate a vehicle with the tailgate open, airflow can pull exhaust gas into the interior and create a hazardous condition. If you must drive with the tailgate open, open all the windows and set the heating and cooling system\*/climate control system\* as shown below.

1. Select the fresh air mode.
2. Select the  mode.
3. Set the fan speed to high.
4. Set the temperature control to a comfortable setting.

Adjust the heating and cooling system\*/climate control system\* in the same manner if you sit in your parked vehicle with the engine running.

### Carbon Monoxide Gas

## WARNING

Carbon monoxide gas is toxic. Breathing it can cause unconsciousness and even kill you.

Avoid any enclosed areas or activities that expose you to carbon monoxide.

An enclosed area such as a garage can quickly fill up with carbon monoxide gas. Do not run the engine with the garage door closed. Even when the garage door is open, drive out of the garage immediately after starting the engine.

## Label Locations

These labels are in the locations shown. They warn you of potential hazards that can cause serious injury or death. Read these labels carefully.

If a label comes off or becomes hard to read (except for the U.S. dashboard label which may be removed by the owner), contact a dealer for a replacement.

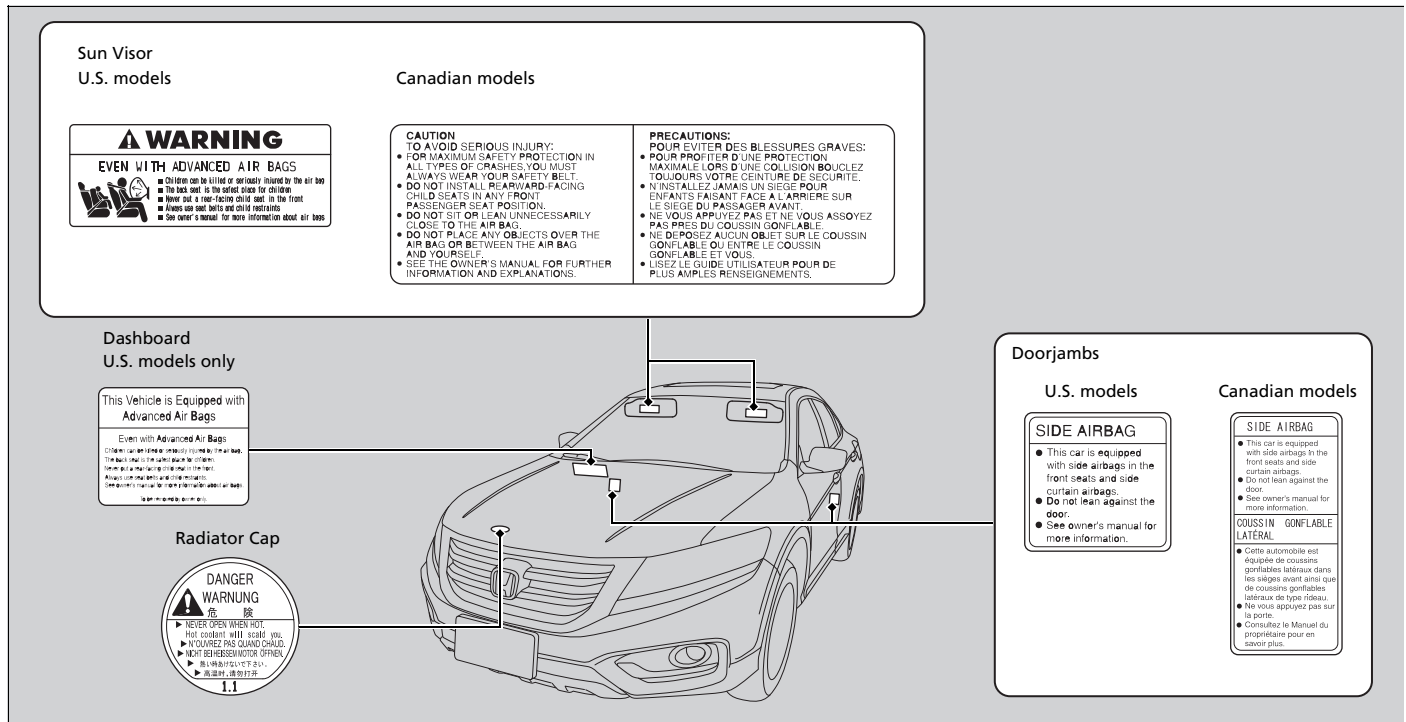







# Instrument Panel

This chapter describes the buttons, indicators, and gauges that are used while driving.





<b>Indicators</b> .....	70
Information Display Warning and Information Messages.....	82
<b>Gauges and Displays</b>	
Gauges.....	83
Information Display.....	84

Indicator	Name	On/Blinking	Explanation
	Parking Brake and Brake System Indicator (Red)	<ul style="list-style-type: none"> <li>• Comes on for a few seconds when you turn the ignition switch to ON <sup>*1</sup>, then goes off.</li> <li>• Comes on when the parking brake is applied, and goes off when it is released.</li> <li>• Comes on when the brake fluid level is low.</li> <li>• Comes on if there is a problem with the brake system.</li> <li>• The beeper sounds and the indicator comes on if you drive with the parking brake not fully released.</li> </ul>	<ul style="list-style-type: none"> <li>• <b>Comes on while driving</b> - Make sure the parking brake is released. Check the brake fluid level.                             <ul style="list-style-type: none"> <li>➤ <b>What to do when the indicator comes on while driving</b> P. 536</li> </ul> </li> <li>• <b>Comes on along with the ABS indicator</b> - Have the vehicle checked by a dealer.                             <ul style="list-style-type: none"> <li>➤ <b>If the Brake System Indicator (Red) Comes On</b> P. 536</li> </ul> </li> </ul>
	Low Oil Pressure Indicator	<ul style="list-style-type: none"> <li>• Comes on when you turn the ignition switch to ON <sup>*1</sup>, and goes off when the engine starts.</li> <li>• Comes on when the engine oil pressure is low.</li> </ul>	<ul style="list-style-type: none"> <li>• <b>Comes on while driving</b> - Immediately stop in a safe place.                             <ul style="list-style-type: none"> <li>➤ <b>If the Low Oil Pressure Indicator Comes On</b> P. 534</li> </ul> </li> </ul>





\*1: Models with the smart entry system have an **ENGINE START/STOP** button instead of an ignition switch.











Indicator	Name	On/Blinking	Explanation
	Malfunction Indicator Lamp	<ul style="list-style-type: none"> <li>• Comes on when you turn the ignition switch to ON <b>II</b>*1, and goes off either when the engine starts or after several seconds if the engine is not started. If "readiness codes" have not been set, it blinks five times before it goes off.</li> <li>• Comes on if there is a problem with the emissions control system.</li> <li>• Blinks when a misfire in the engine's cylinders is detected.</li> </ul>	<ul style="list-style-type: none"> <li>• Readiness codes are part of the on board diagnostics for the emissions control systems. <ul style="list-style-type: none"> <li>► <b>Testing of Readiness Codes</b> P. 553</li> </ul> </li> <li>• <b>Comes on while driving</b> - Have the vehicle checked by a dealer.</li> <li>• <b>Blinks while driving</b> - Stop in a safe place where there are no flammable objects. Stop the engine for 10 minutes or more, and wait for it to cool down. Then, take the vehicle to a dealer. <ul style="list-style-type: none"> <li>► <b>If the Malfunction Indicator Lamp Comes On or Blinks</b> P. 535</li> </ul> </li> </ul>
	Charging System Indicator	<ul style="list-style-type: none"> <li>• Comes on when you turn the ignition switch to ON <b>II</b>*1, and goes off when the engine starts.</li> <li>• Comes on when the battery is not charging.</li> </ul>	<ul style="list-style-type: none"> <li>• <b>Comes on while driving</b> - Turn off the heating and cooling system*/climate control system* and rear defogger in order to reduce electricity consumption. <ul style="list-style-type: none"> <li>► <b>If the Charging System Indicator Comes On</b> P. 534</li> </ul> </li> </ul>
	Seat Belt Reminder Indicator	<ul style="list-style-type: none"> <li>• Comes on and the beeper sounds if you are not wearing a seat belt when you turn the ignition switch to ON <b>II</b>*1.</li> <li>• If the front passenger is not wearing a seat belt, the indicator comes on about six seconds later.</li> <li>• Blinks while driving if either you or the front passenger has not fastened a seat belt. The beeper sounds and the indicator blinks at regular intervals.</li> </ul>	<ul style="list-style-type: none"> <li>• The beeper stops and the indicator goes off when you and the front passenger fasten their seat belts.</li> <li>• <b>Stays on after you or the front passenger has fastened the seat belt</b> - A detection error may have occurred in the sensor. Have the vehicle checked by a dealer. <ul style="list-style-type: none"> <li>► <b>Seat Belt Reminder</b> P. 33</li> </ul> </li> </ul>

\*1:Models with the smart entry system have an **ENGINE START/STOP** button instead of an ignition switch.





\* Not available on all models

Indicator	Name	On/Blinking	Explanation
	Shift Lever Position Indicator	<ul style="list-style-type: none"> <li>Indicates in which position your shift lever is.</li> </ul>	<p>➤ <b>Shifting</b> P. 426, 428</p>
	M (sequential shift mode) Indicator/Gear Position Indicator*	<ul style="list-style-type: none"> <li>Comes on when the sequential shift mode is applied.</li> </ul>	<p>➤ <b>Sequential Shift Mode</b> P. 430</p>
	Transmission Indicator	<ul style="list-style-type: none"> <li>Comes on for a few seconds when you turn the ignition switch to ON *1, then goes off.</li> <li>Blinks if the transmission system has a problem.</li> </ul>	<ul style="list-style-type: none"> <li><b>Blinks while driving</b> - Avoid sudden starts and acceleration and have the vehicle checked by a dealer immediately.</li> </ul>
	Low Fuel Indicator	<ul style="list-style-type: none"> <li>Comes on when the fuel reserve is running low (approximately 2.5 U.S. gal./9.6 Liter left on 2WD models, and 2.8 U.S. gal./10.5 Liter left on 4WD models).</li> <li>Blinks if there is a problem with the fuel gauge.</li> </ul>	<ul style="list-style-type: none"> <li><b>Comes on</b> - Refuel your vehicle as soon as possible.</li> <li><b>Blinks</b> - Have the vehicle checked by a dealer.</li> </ul>



\*1: Models with the smart entry system have an **ENGINE START/STOP** button instead of an ignition switch.

Indicator	Name	On/Blinking	Explanation
	<b>ABS</b> (Anti-lock Brake System) Indicator	<ul style="list-style-type: none"> <li>• Comes on for a few seconds when you turn the ignition switch to ON <sup>*1</sup>, then goes off.</li> <li>• If it comes on at any other time, there is a problem with the ABS.</li> </ul>	<ul style="list-style-type: none"> <li>• <b>Stays on constantly</b> - Have the vehicle checked by a dealer. With this indicator on, your vehicle still has normal braking ability but no anti-lock function.               <ul style="list-style-type: none"> <li>▣ <b>ABS (Anti-lock Brake System)</b> P. 451</li> </ul> </li> </ul>
	Supplemental Restraint System Indicator	<ul style="list-style-type: none"> <li>• Comes on for a few seconds when you turn the ignition switch to ON <sup>*1</sup>, then goes off.</li> <li>• Comes on if a problem with any of the following is detected:               <ul style="list-style-type: none"> <li>- Supplemental restraint system</li> <li>- Side airbag system</li> <li>- Side curtain airbag system</li> <li>- Seat belt tensioner</li> </ul> </li> </ul>	<ul style="list-style-type: none"> <li>• <b>Stays on constantly or does not come on at all</b> - Have the vehicle checked by a dealer.</li> </ul>
	VSA® (Vehicle Stability Assist) System Indicator	<ul style="list-style-type: none"> <li>• Comes on for a few seconds when you turn the ignition switch to ON <sup>*1</sup>, then goes off.</li> <li>• Blinks when VSA® is active.</li> <li>• Comes on if there is a problem with the VSA® system.</li> </ul>	<ul style="list-style-type: none"> <li>• <b>Stays on constantly</b> - Have the vehicle checked by a dealer.               <ul style="list-style-type: none"> <li>▣ <b>VSA® (Vehicle Stability Assist), aka ESC (Electronic Stability Control), System</b> P. 442</li> </ul> </li> </ul>
	VSA® (Vehicle Stability Assist) OFF Indicator	<ul style="list-style-type: none"> <li>• Comes on for a few seconds when you turn the ignition switch to ON <sup>*1</sup>, then goes off.</li> <li>• Comes on when you deactivate VSA®.</li> </ul>	<ul style="list-style-type: none"> <li>▣ <b>VSA® On and Off</b> P. 443</li> </ul>













\*1: Models with the smart entry system have an **ENGINE START/STOP** button instead of an ignition switch.

Indicator	Name	On/Blinking	Explanation
	Door and Tailgate Open Indicator	<ul style="list-style-type: none"> <li>• Comes on for a few seconds if you turn the ignition switch to ON *1, then goes off.</li> <li>• Comes on if any door or the tailgate is not completely closed.</li> <li>• The beeper sounds and the indicator comes on if any door or the tailgate is opened while driving.</li> </ul>	<ul style="list-style-type: none"> <li>• Goes off when all doors and the tailgate are closed.</li> </ul>
	EPS (Electric Power Steering) System Indicator*	<ul style="list-style-type: none"> <li>• Comes on when you turn the ignition switch to ON *1, and goes off when the engine starts.</li> <li>• Comes on if there is a problem with the EPS (Electric Power Steering) System.</li> </ul>	<ul style="list-style-type: none"> <li>• <b>Stays on constantly or does not come on at all</b> - Have the vehicle checked by a dealer.   <b>If the EPS System Indicator Comes On</b> P. 536</li> </ul>

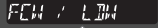

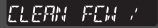

\*1:Models with the smart entry system have an **ENGINE START/STOP** button instead of an ignition switch.

Indicator	Name	On/Blinking	Explanation
TPMS	TPMS Indicator	<ul style="list-style-type: none"> <li>Comes on for a few seconds when you turn the ignition switch to ON *1, then goes off.</li> <li>Comes on if there is a problem with the TPMS, or when a compact spare tire is temporarily installed.</li> </ul>	<ul style="list-style-type: none"> <li><b>Stays on constantly or does not come on at all</b> - Have the vehicle checked by a dealer. If the vehicle is fitted with a compact spare, get your regular tire repaired or replaced and put back on your vehicle as soon as you can.</li> </ul>
	Low Tire Pressure Indicator	<ul style="list-style-type: none"> <li>Comes on for a few seconds when you turn the ignition switch to ON *1, then goes off.</li> <li>Comes on if the tire pressure of any of the tires becomes significantly low.</li> <li>Comes on for a while and then goes off when a compact spare tire is temporarily installed.</li> </ul>	<ul style="list-style-type: none"> <li><b>Comes on while driving</b> - Stop in a safe place, check tire pressures, and inflate the tire(s) if necessary.</li> </ul>
ECO	Fuel Economy Indicator*	<ul style="list-style-type: none"> <li>Comes on while the engine is operating in its most economical range.</li> </ul>	—

\*1: Models with the smart entry system have an **ENGINE START/STOP** button instead of an ignition switch.

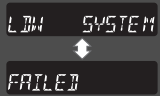
Indicator	Name	On/Blinking	Explanation	Message
<b>FCW</b>	Forward Collision Warning (FCW) Indicator*	<ul style="list-style-type: none"> <li>Comes on for a few seconds when you turn the ignition switch to ON *1, then goes off.</li> <li>Comes on when you have customized FCW to turn off.</li> <li>Comes on if there is a problem with the FCW system.</li> </ul>	<ul style="list-style-type: none"> <li><b>Stays on constantly without FCW off</b> - Have the vehicle checked by a dealer.</li> </ul>	   
		<ul style="list-style-type: none"> <li>Blinks when the system detects a likely collision with a vehicle in front of you. The beeper sounds.</li> </ul>	<ul style="list-style-type: none"> <li><b>Blinks while driving</b> - Take appropriate action to prevent a collision (apply the brakes, change lanes, etc.).</li> </ul>	
		<ul style="list-style-type: none"> <li>Comes on when the FCW system shuts itself off.</li> </ul>	<ul style="list-style-type: none"> <li><b>Stays on</b> - The temperature inside the FCW system is too high. The system activates when the temperature inside the system cools down.                             <ul style="list-style-type: none"> <li>➤ <b>Automatic shutoff</b> P. 437</li> </ul> </li> </ul>	  
			<ul style="list-style-type: none"> <li><b>Stays on</b> - The radar sensor or the area around the camera is blocked by dirt, mud, etc. Stop your vehicle in a safe place, and wipe it off with a soft cloth.</li> <li>Have your vehicle checked by a dealer if: The indicator and message come back on after you cleaned the area around the camera.                             <ul style="list-style-type: none"> <li>➤ <b>Automatic shutoff</b> P. 437</li> </ul> </li> </ul>	  
		<ul style="list-style-type: none"> <li>➤ <b>Automatic shutoff</b> P. 437</li> </ul>		



\*1: Models with the smart entry system have an **ENGINE START/STOP** button instead of an ignition switch.

Indicator	Name	On/Blinking	Explanation	Message
LDW	Lane Departure Warning (LDW) Indicator*	<ul style="list-style-type: none"> <li>Comes on for a few seconds when you turn the ignition switch to ON *1, then goes off.</li> <li>Comes on if there is a problem with the LDW system.</li> </ul>	<ul style="list-style-type: none"> <li><b>Stays on constantly</b> - Have the vehicle checked by a dealer.</li> </ul>	
		<ul style="list-style-type: none"> <li>Blinks when your vehicle is too close to the lane lines. The beeper sounds.</li> </ul>	<ul style="list-style-type: none"> <li><b>Blinks while driving</b> - Take appropriate action to keep your vehicle within the lane lines.</li> </ul>	—
		<ul style="list-style-type: none"> <li>Comes on when the LDW system shuts itself off.</li> </ul>	<ul style="list-style-type: none"> <li><b>Stays on</b> - The temperature inside the LDW camera is too high. The system activates when the temperature inside the camera cools down.   LDW Camera P. 440</li> </ul>	
		<ul style="list-style-type: none"> <li><b>Stays on</b> - The area around the camera is blocked by dirt, mud, etc. Stop your vehicle in a safe place, and wipe it off with a soft cloth.</li> <li>Have your vehicle checked by a dealer if the indicator and message come back on after you cleaned the area around the camera.   LDW Camera P. 440</li> </ul>		









Instrument Panel

\*1: Models with the smart entry system have an **ENGINE START/STOP** button instead of an ignition switch.



\* Not available on all models

Indicator	Name	On/Blinking	Explanation
	Smart Entry System Indicator*	<ul style="list-style-type: none"> <li>• Comes on for a few seconds when you change the power mode to ON.</li> <li>• Comes on as soon as a problem is detected in the smart entry system or push button starting system.</li> </ul>	<ul style="list-style-type: none"> <li>• Have your vehicle checked by a dealer.</li> </ul>
	Starter System Indicator*	<ul style="list-style-type: none"> <li>• Comes on for a few seconds when you set the power mode to ON, then goes off.</li> <li>• Comes on if the starting system has a problem.</li> </ul>	<ul style="list-style-type: none"> <li>• As a temporary measure, press and hold the <b>ENGINE START/STOP</b> button for 15 seconds while pressing the brake pedal and manually start the engine. Have the vehicle checked by a dealer.</li> </ul>
	Turn Signal and Hazard Warning Indicators	<ul style="list-style-type: none"> <li>• The turn signal indicators blink when you operate the turn signal lever.</li> <li>• If you press the hazard warning button, both indicators and all turn signals blink at the same time.</li> </ul>	<ul style="list-style-type: none"> <li>• <b>Does not blink or blinks rapidly</b> - A turn signal light bulb has blown. Change the bulb immediately. <ul style="list-style-type: none"> <li>➤ <b>Replacing Light Bulbs</b> P. 489, 490</li> </ul> </li> </ul>







Indicator	Name	On/Blinking	Explanation
	High Beam Indicator	<ul style="list-style-type: none"> <li>Comes on when the high beam headlights are on.</li> </ul>	—
	Lights On Indicator	<ul style="list-style-type: none"> <li>Comes on whenever the light switch is on, or in <b>AUTO</b> when the exterior lights are on.</li> </ul>	<ul style="list-style-type: none"> <li>If you remove the key from the ignition switch or set the power mode to <b>ACCESSORY</b> or <b>VEHICLE OFF (LOCK)</b> while the exterior lights are on, a chime sounds when the driver's door is opened.</li> </ul>
	Fog Light Indicator	<ul style="list-style-type: none"> <li>Comes on when the fog lights are on.</li> </ul>	—
	Daytime Running Lights Indicator	<ul style="list-style-type: none"> <li>Comes on for a few seconds when you turn the ignition switch to ON <sup>*1</sup>, then goes off.</li> <li>Comes on if there is a problem with the DRL system.</li> </ul>	<ul style="list-style-type: none"> <li>Have your vehicle checked by a dealer.                             <ul style="list-style-type: none"> <li> <b>Daytime Running Lights</b> P. 122</li> </ul> </li> </ul>
	Side Airbag Off Indicator	<ul style="list-style-type: none"> <li>Comes on for a few seconds when you turn the ignition switch to ON <sup>*1</sup>, then goes off.</li> <li>Comes on when the passenger side airbag system is automatically shut off.</li> </ul>	<ul style="list-style-type: none"> <li>It does not mean there is a problem with your side airbags.</li> <li><b>Comes on when nobody is sitting in the passenger seat</b> - Have the vehicle checked by a dealer.</li> <li><b>Comes on when someone is sitting in the seat</b> - Have the passenger sit properly.</li> </ul>

\*1: Models with the smart entry system have an **ENGINE START/STOP** button instead of an ignition switch.

Indicator	Name	On/Blinking	Explanation
	Immobilizer System Indicator	<ul style="list-style-type: none"> <li>• Comes on briefly when you turn the ignition switch to ON <b>[II]</b>*1, then goes off.</li> <li>• Comes on if the immobilizer system cannot recognize the key information.</li> </ul>	<ul style="list-style-type: none"> <li>• <b>Blinks</b> - You cannot start the engine. Turn the ignition switch to LOCK <b>[0]</b>*1, pull the key out, and then insert the key and turn it to ON <b>[II]</b>*1 again.</li> <li>• <b>Repeatedly blinks</b> - The system may be malfunctioning. Have the vehicle checked by a dealer.</li> <li>• Do not attempt to alter this system or add other devices to it. Electrical problems can occur.</li> </ul>
	Security System Alarm Indicator	<ul style="list-style-type: none"> <li>• Blinks when the security system alarm has been set.</li> </ul>	<p> <b>Security System Alarm</b> P. 107</p>







\*1: Models with the smart entry system have an **ENGINE START/STOP** button instead of an ignition switch.

Indicator	Name	On/Blinking	Explanation
	<b>CRUISE MAIN</b> Indicator	<ul style="list-style-type: none"> <li>Comes on when you press the <b>CRUISE</b> button.</li> </ul>	<ul style="list-style-type: none"> <li>➤ <b>Cruise Control</b> P. 432</li> </ul>
	<b>CRUISE CONTROL</b> Indicator	<ul style="list-style-type: none"> <li>Comes on if you have set a speed for cruise control.</li> </ul>	<ul style="list-style-type: none"> <li>➤ <b>Cruise Control</b> P. 432</li> </ul>
	Washer Level Indicator*	<ul style="list-style-type: none"> <li>Comes on when washer fluid gets low.</li> </ul>	<ul style="list-style-type: none"> <li>• Refill washer fluid.</li> <li>➤ <b>Refilling Window Washer Fluid</b> P. 483</li> </ul>
	Maintenance Minder Indicator	<ul style="list-style-type: none"> <li>Comes on when you turn the ignition switch to ON <sup>*1</sup>, then goes off.</li> <li>Comes on when the scheduled maintenance is due soon.</li> </ul>	<ul style="list-style-type: none"> <li>➤ <b>Maintenance Minder™</b> P. 465</li> </ul>

\*1: Models with the smart entry system have an **ENGINE START/STOP** button instead of an ignition switch.

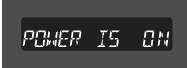
## Information Display Warning and Information Messages

The following messages appear only on the information display.

Message	Condition	Explanation
 <p>CHECK ↑ FUEL CAP</p>	<ul style="list-style-type: none"> <li>Appears when the fuel fill cap is loose or is not installed.</li> </ul>	<ul style="list-style-type: none"> <li>➤ <b>Check Fuel Cap Message</b> P. 535</li> </ul>
<p><b>Models with smart entry system</b></p>		
Message	Condition	Explanation
 <p>POWER IS ON ↑ SHIFT TO P</p>	<ul style="list-style-type: none"> <li>Appears if you push the <b>ENGINE START/STOP</b> button to turn the engine off without the shift lever in <b>P</b>.</li> </ul>	<ul style="list-style-type: none"> <li>Push the <b>ENGINE START/STOP</b> button twice after moving the shift lever to <b>P</b>.</li> </ul>
 <p>POWER IS ON</p>	<ul style="list-style-type: none"> <li>Appears when the power mode is in ACCESSORY.</li> </ul>	—
 <p>1-PUSH START ↑ 2-TURN WHEEL</p>	<ul style="list-style-type: none"> <li>Appears when the steering wheel is locked.</li> </ul>	<ul style="list-style-type: none"> <li>Move the steering wheel left and right while pressing the <b>ENGINE START/STOP</b> button at the same time.</li> </ul>
 <p>NO KEY</p>	<ul style="list-style-type: none"> <li>Appears when you close the door with the power mode in ON without the smart entry remote inside the vehicle.</li> </ul>	<ul style="list-style-type: none"> <li>Disappears when you bring the smart entry remote back inside the vehicle and close the door.</li> </ul>
 <p>CHANGE ↑ KEY BATT</p>	<ul style="list-style-type: none"> <li>Appears when the smart entry remote's battery becomes weak.</li> </ul>	<ul style="list-style-type: none"> <li>Replace the battery as soon as possible.                             <ul style="list-style-type: none"> <li>➤ <b>Replacing the Button Battery</b> P. 507</li> </ul> </li> </ul>

## Gauges

Gauges include the speedometer, tachometer, fuel gauge, and related indicators. They are displayed when the ignition switch is in ON \*1.

### Speedometer

Displays your driving speed in mph (U.S.) or km/h (Canada).

### Tachometer

Shows the number of engine revolutions per minute.

### Fuel Gauge

Displays the amount of fuel left in the fuel tank.

### Temperature Gauge

Displays the temperature of the engine coolant.

\*1: Models with the smart entry system have an **ENGINE START/STOP** button instead of an ignition switch.

#### Fuel Gauge

##### NOTICE

You should refuel when the reading approaches . Running out of fuel can cause the engine to misfire, damaging the catalytic converter.

The actual amount of remaining fuel may differ from the fuel gauge reading.

#### Temperature Gauge

##### NOTICE

Driving with the temperature gauge pointer in the upper zone can cause serious engine damage. Pull safely to the side of the road and allow engine temperature to return to normal.

 **Overheating** P. 532

## Information Display

The information display shows the odometer, trip meter, engine oil life and maintenance service item codes, and other gauges.

### Switching the Display

Press the  (Select/Reset) knob to change the display.

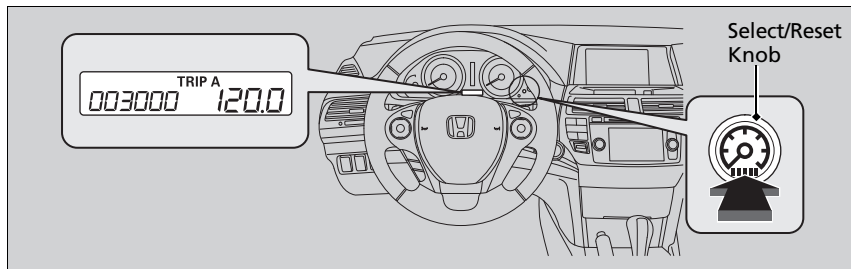

### Odometer

Shows the total number of miles or kilometers that your vehicle has accumulated.

### Switching the Display

Each time you press the  knob, the information display changes as follows:

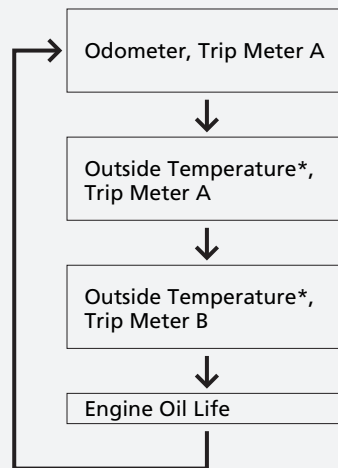

Some of the items on the information display also appear on the audio/information screen\*. They also change along with the information display changes while the fuel consumption is shown.

## ■ Trip Meter

Shows the total number of miles (U.S.) or kilometers (Canada) driven since the last reset. Meters A and B can be used to measure two separate trips.

### ■ Resetting a trip meter

To reset a trip meter, display it, then press and hold the  knob. The trip meter is reset to **0.0**.

## ■ Engine Oil Life

Shows the remaining oil life and Maintenance Minder™.

➤ **Maintenance Minder™** P. 465

## ■ Check Fuel Cap

Appears when the fuel fill cap is loose or is not installed.

➤ **Check Fuel Cap Message** P. 535

## ▶ Trip Meter



Switch between trip meter A and trip meter B by pressing the  knob.

## ■ Outside Temperature\*

Shows the outside temperature in Fahrenheit (U.S.) or Celsius (Canada).

### ■ Adjusting the outside temperature display

Adjust the temperature reading up to  $\pm 5^{\circ}\text{F}$  or  $\pm 3^{\circ}\text{C}$  if the temperature reading seems incorrect.

1. Turn the ignition switch to ON \*1.
2. Press and hold the  (Select/Reset) knob for 10 seconds or more while the outside temperature is shown on the information display.
  - The information display goes into temperature adjustment mode. The display starts showing from  $-5^{\circ}\text{F}$  to  $+5^{\circ}\text{F}$  (U.S.) or  $-3^{\circ}\text{C}$  to  $+3^{\circ}\text{C}$  (Canada).
3. Release the  knob when the right adjustment amount is shown.
  - The adjustment is complete.

\*1: Models with the smart entry system have an **ENGINE START/STOP** button instead of an ignition switch.

## ►► Outside Temperature

The temperature sensor is in the front bumper. Road heat and exhaust from another vehicle can affect the temperature reading when your vehicle speed is less than 19 mph (30 km/h).

It may take several minutes for the display to be updated after the temperature reading has stabilized.

### Models with audio touch screen

Use the audio/information screen's customized features to correct the temperature.

► **Customized Features**\* P. 281



# Controls

This chapter explains how to operate the various controls necessary for driving.



<b>Setting the Clock</b> .....	88
<b>Locking and Unlocking the Doors</b>	
Key Types and Functions .....	91
Low Smart Entry Remote Signal Strength* ..	93
Locking/Unlocking the Doors from the Outside .....	94
Locking/Unlocking the Doors from the Inside .....	99
Childproof Door Locks .....	100
Auto Door Locking/Unlocking .....	101
<b>Opening and Closing the Tailgate</b> ...	105
<b>Security System</b> .....	107
Immobilizer System .....	107
Security System Alarm.....	107
<b>Opening and Closing the Windows</b> .....	110

<b>Opening and Closing the Moonroof</b> ..	113
<b>Operating the Switches Around the Steering Wheel</b>	
Ignition Switch* .....	114
ENGINE START/STOP Button* .....	115
Ignition Switch and Power Mode Comparison .....	118
Turn Signals .....	119
Light Switches.....	119
Fog Lights .....	122
Daytime Running Lights .....	122
Wipers and Washers .....	123
Brightness Control .....	125
Rear Defogger/Heated Door Mirror Button..	126
Driving Position Memory System* .....	127

Adjusting the Steering Wheel .....	129
<b>Adjusting the Mirrors</b> .....	130
Interior Rearview Mirror .....	130
Power Door Mirrors .....	131
<b>Adjusting the Seats</b> .....	133
Adjusting the Seat Positions.....	133
<b>Interior Lights/Interior Convenience Items</b> .....	142
Interior Lights .....	142
Interior Convenience Items .....	144
<b>Heating and Cooling System*</b> .....	154
Using Vents, Heating and A/C.....	154
<b>Climate Control System*</b> .....	157
Using Automatic Climate Control ....	157
Automatic Climate Control Sensors... 162	

\* Not available on all models

# Setting the Clock

## Clock

### Models without navigation system





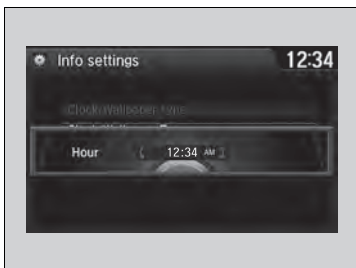

You can adjust the time in the clock display with the ignition switch is in ON \*1.

### Adjusting the Time

#### Models with audio touch screen



#### ■ Using the Settings menu on the audio/information screen



1. Press and hold the **DISP** button.
2. Rotate  to select **Info Settings**, then press .  
▶ Repeat the procedure to select **Clock Adjustment**.
3. Rotate  to change hour, then press .
4. Rotate  to change minute, then press .

#### ■ Using the audio touch screen



1. Select **Clock/Screen**.
2. Select **Clock**.
3. Adjust the hours and minutes by selecting /.
4. Select **12H** or **24H**.
5. Press **Set** to set the time.

\*1: Models with the smart entry system have an **ENGINE START/STOP** button instead of an ignition switch.



\* Not available on all models

### » Clock

#### Models with navigation system

The clock is automatically updated through the navigation system, so the time does not need to be adjusted.

#### Models without navigation system

These indications are used to show how to operate the selector knob or the **MENU/SEL** (Selector) knob. Rotate  to select. Press  to enter.

#### Models with audio touch screen

You can customize the clock display to show the 12 hour clock or 24 hour clock.

➤ **Customized Features\*** P. 281







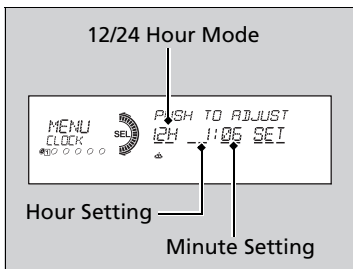
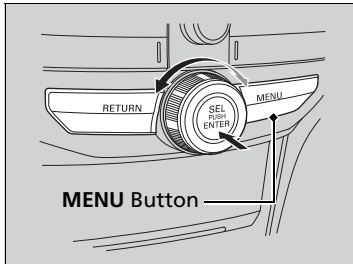

You can turn the clock display on and off.

➤ **Customized Features\*** P. 281

## Models without audio touch screen

## ■ Using the MENU button



1. Press the **MENU** button.
2. Rotate  to select **CLOCK ADJUST** in the display.
3. Press . **CLOCK ADJUST** appears.
4. Rotate  to select the item you want to adjust (12/24 hour mode, hour, minute). Then press .
5. Rotate  to make the adjustment.
6. Press  to enter your selection. The display returns to **CLOCK ADJUST**. Repeat steps 4 to 6 to adjust other items.
7. To enter the selection, Rotate  and select **SET**, then press .
8. Press the **MENU** button to go back to the normal display.

## ⌘ Clock

You can switch the clock display between 24 hours and 12 hours when in the menu mode.

Selector Knob Icon details

Rotate  to select.

Press  to enter.

To set the time to the nearest hour:

Press and hold the **CLOCK** button until the clock display begins to blink, then press the  (Reset) button.

Depending on the displayed time, the clock sets forward or backward.

Example:

1:06 will reset to 1:00

1:53 will reset to 2:00

### ■ Using the CLOCK button

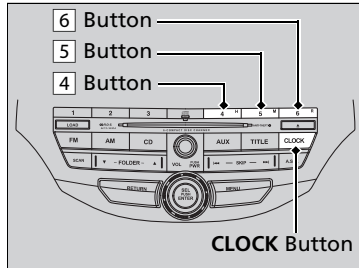

1. Press and hold the **CLOCK** button until the clock display begins to blink.
2. Press the **4** (Hour) button to change the hours.
3. Press the **5** (Minute) button to change the minutes.
4. Press the **CLOCK** button to go back to the normal display.

## Key Types and Functions

This vehicle comes with the following keys:

### Master Keys

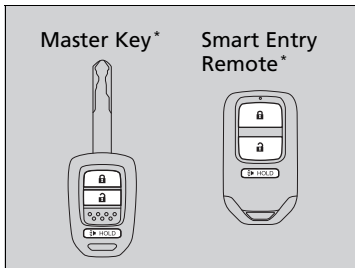

Use the key to start and stop the engine, and to lock and unlock the doors, tailgate, and fuel fill door.

You can also use the remote transmitter or smart entry system\* to lock and unlock the doors, tailgate, and fuel fill door.

The seat automatically moves to the preset position when you unlock the door using the remote transmitter or smart entry system.

➤ **Driving Position Memory System**\* P. 127

### Smart entry remote

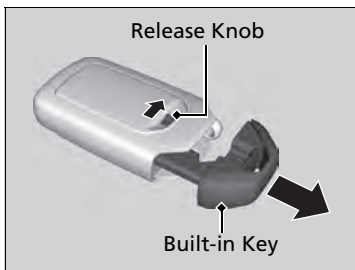

The built-in key can be used to lock/unlock the doors and tailgate when the smart entry remote battery becomes weak and the power door lock/unlock operation is disabled.

To remove the built-in key, pull it out while sliding the release knob. To reinstall the built-in key, push the built-in key into the smart entry remote until it clicks.

### Key Types and Functions

All the keys have an immobilizer system. The immobilizer system helps to protect against vehicle theft.

➤ **Immobilizer System** P. 107

The keys contain precision electronics. Adhere to the following advice to prevent damage to the electronics:

- Do not leave the keys in direct sunlight, or in locations with high temperature or high humidity.
- Do not drop the keys or set heavy objects on them.
- Keep the keys away from liquids.
- Do not take the keys apart except for replacing the battery.

If the circuits in the keys are damaged, the engine may not start, and the remote transmitter may not work.

If the keys do not work properly, have them inspected by a dealer.

\* Not available on all models

### ■ Valet Key\*

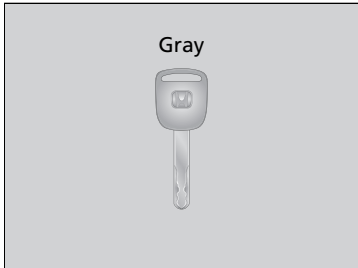

Can be used to start and stop the engine, and lock and unlock driver's door.

### ■ Key Number Tag

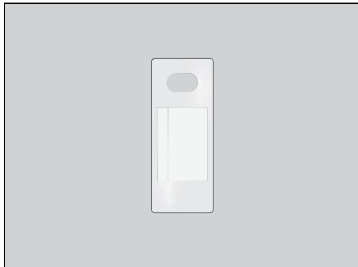

Contains a number that you will need if you purchase a replacement key.

### ☒ Valet Key\*

When you need to leave a key with a third party, leave the valet key.

### ☒ Key Number Tag

Keep the key number tag separate from the key in a safe place outside of your vehicle. If you wish to purchase an additional key, contact a dealer.

If you lose your key and you cannot start the engine, contact a dealer.

## Low Smart Entry Remote Signal Strength\*

The vehicle transmits radio waves to locate the smart entry remote when locking/unlocking the doors and tailgate, or to start the engine.

In the following cases, locking/unlocking the doors and tailgate, or starting the engine may be inhibited or operation may be unstable:

- Strong radio waves are being transmitted by nearby equipment.
- You are carrying the smart entry remote together with telecommunications equipment, laptop computers, cell phones, or wireless devices.
- A metallic object is touching or covering the smart entry remote.

### ⓘ Low Smart Entry Remote Signal Strength\*

Communication between the smart entry remote and the vehicle consumes the smart entry remote's battery.

Battery life is about two years, but this varies depending on regularity of use.

The battery is consumed whenever the smart entry remote is receiving strong radio waves. Avoid placing it near electrical appliances such as televisions and personal computers.

\* Not available on all models

## Locking/Unlocking the Doors from the Outside

### ■ Using the Remote Transmitter

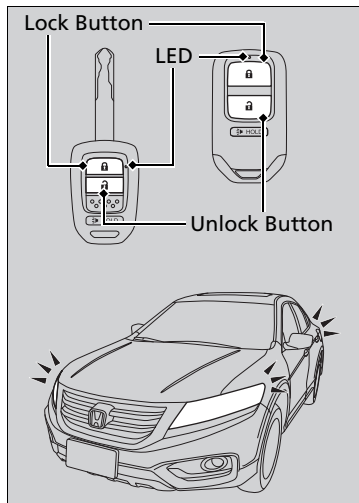

#### ■ Locking the doors

Press the lock button.

#### Once:

- ▶ Some exterior lights will flash, all the doors, tailgate, and fuel fill door will lock, and the security system sets.

#### Twice (within five seconds after the first push):

- ▶ A beeper sounds and verifies the security system is set.

#### ▶▶ Using the Remote Transmitter

If you do not open a door within 30 seconds of unlocking the vehicle with the remote transmitter, the doors will automatically relock.

#### Models with audio touch screen

You can change the relock timer setting.

▶▶ **Customized Features\*** P. 281

If the interior light switch is in the door activated position, the interior lights come on when you press the unlock button.

No doors opened: The lights fade out after 30 seconds.

Doors relocked with the remote: The lights go off immediately.

▶▶ **Interior Lights** P. 142

The remote transmitter uses low-power signals, so the operating range may vary depending on the surroundings.

#### Models without smart entry system

The remote transmitter will not work when the key is in the ignition switch.

#### Models with smart entry system

You can lock or unlock doors using the remote transmitter or smart entry system only when the power mode in VEHICLE OFF.

#### All models

The remote will not lock the vehicle when a door or the tailgate is open.



## ■ Unlocking the doors

Press the unlock button.

### Once:

- ▶ Some exterior lights flash twice, and the driver's door and fuel fill door unlock.

### Twice:

- ▶ The remaining doors and tailgate unlock.

### ▶▶ Using the Remote Transmitter

If the distance at which it works varies, the battery is probably low.

If the LED does not come on when you press a button, the battery is dead.

▶ **Replacing the Button Battery** P. 507

### ▶▶ Models with audio touch screen

You can customize the door unlock mode setting.

▶ **Customized Features\*** P. 281

\* Not available on all models

*Continued*

## ■ Using the Smart Entry with Push Button Start System \*

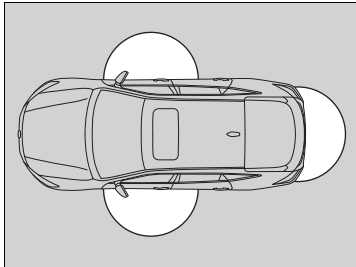

When you carry the smart entry remote, you can lock/unlock the doors, the tailgate, and the fuel fill door.

You can lock/unlock the doors within a radius of about 32 inches (80 cm) of the outside door handle. You can open the tailgate within about 32 inches (80 cm) radius from the tailgate release button.

### ■ Locking the vehicle

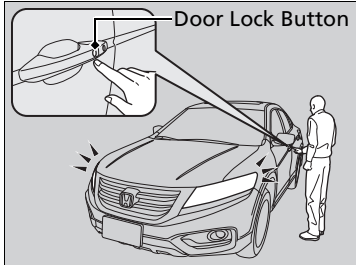

Press the door lock button on the front door or the tailgate.

- ▶ Some exterior lights flash; the beeper sounds; all the doors, tailgate and fuel fill door lock; and the security system sets.

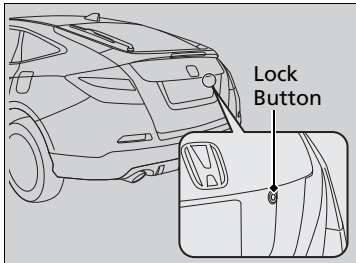

## ▶▶ Using the Smart Entry with Push Button Start System \*

- The driver must carry the smart entry remote and not leave it in the vehicle when you get out.
- A person who is not carrying the smart entry remote can lock/unlock the doors and the tailgate if a person who is carrying it is within range.
- The door may be unlocked if the door handle is covered with water in heavy rain or in a car wash if the smart entry remote is within range.
- If you grip a front door handle wearing gloves, the door sensor may be slow to respond or may not respond by unlocking the doors.
- You cannot unlock the door by gripping the handle after two seconds of locking it.
- The door might not open if you pull it immediately after gripping the door handle. Grip the handle again and confirm that the door is unlocked before pulling the handle.

If the distance at which it works varies, the battery is probably low.

If the LED does not come on when you press a button, the battery is dead.

▶▶ **Replacing the Button Battery** P. 507

You can customize the door lock mode and keyless lock acknowledgement setting.

▶▶ **Customized Features** \* P. 281

## ■ Unlocking the vehicle

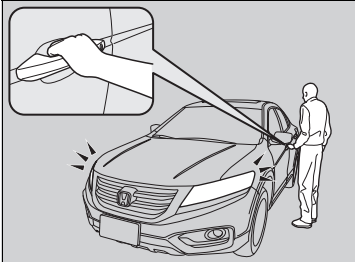

Grab the driver's door handle:

- ▶ The driver's door unlocks.
- ▶ Some exterior lights flash twice and the beeper sounds twice.

Grab the front passenger's door handle:

- ▶ All the doors and the tailgate unlock.
- ▶ Some exterior lights flash twice and the beeper sounds twice.

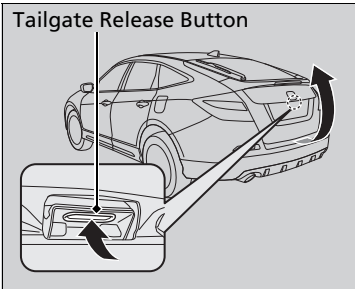

Press the tailgate release button:

- ▶ The trunk unlocks.

▶ **Using the Tailgate Release Button** P. 106

## ▶▶ Using the Smart Entry with Push Button Start System \*

- Even within the 32 inches (80 cm) radius, you may not be able to lock/unlock the doors with the smart entry remote if it is above or below the outside handle.
- The smart entry remote may not operate if it is too close to the door and door glass.

If you do not open a door within 30 seconds of unlocking the vehicle, the doors will automatically relock.

The light flash, beep and unlock settings can be customized.

▶ **Customized Features\*** P. 281

\* Not available on all models

### ■ Locking/Unlocking the Doors Using a Key

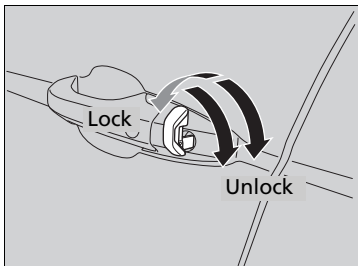

Fully insert the key and turn it.

### ■ Locking a Door Without Using a Key

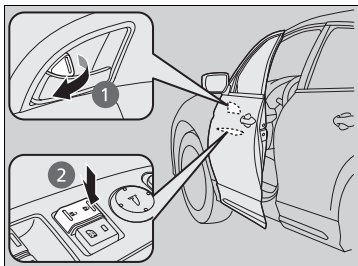

#### ■ Locking the driver's door

Pull the lock tab rearward ① or push the master door lock switch in the lock direction ②, and close the door.

#### ■ Locking the passenger's doors

Pull the lock tab rearward and close the door.

### ■ Lockout prevention system

The doors and the tailgate cannot be locked when the key is in the ignition switch\*<sup>1</sup>, or the smart entry remote is inside the vehicle.

\*1: Models with the smart entry system have an **ENGINE START/STOP** button instead of an ignition switch.

\* Not available on all models

### ▶ Locking/Unlocking the Doors Using a Key

When you lock the driver's door with a key, all the other doors, tailgate, and fuel fill door lock at the same time. When unlocking, the driver's door and fuel fill door unlock first. Turn the key a second time within a few seconds to unlock the remaining doors and the tailgate.

#### Models with audio touch screen

You can customize the door unlock mode setting.

▶ **Customized Features\*** P. 281

### ▶ Locking a Door Without Using a Key

When you lock the driver's door, all the other doors, tailgate, and fuel fill door lock at the same time. Make sure you have the key in your hand before locking the door to prevent it from being locked in the vehicle.

## Locking/Unlocking the Doors from the Inside

### ■ Using the Lock Tab

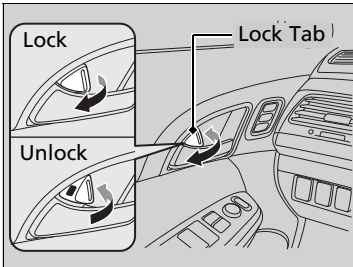

#### ■ Locking a door

Pull the lock tab rearward.

#### ■ Unlocking a door

Push the lock tab forward.

### ■ Using the Master Door Lock Switch

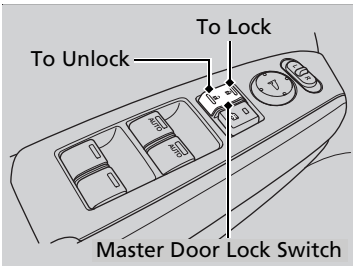

Press the master door lock switch in as shown to lock or unlock all doors and the tailgate.

### ☒ Using the Lock Tab

When you lock the door using the lock tab on the driver's door, all the other doors, tailgate, and fuel fill door lock at the same time.

When you unlock the door using the lock tab on the driver's door, only the driver's door and fuel fill door will unlock.

### ☒ Using the Master Door Lock Switch

When you lock/unlock either front door using the master door lock switch, all the other doors, tailgate, and fuel fill door lock/unlock at the same time.

## Childproof Door Locks

The childproof door locks prevent the rear doors from being opened from the inside regardless of the position of the lock tab.

### ■ Setting the Childproof Door Locks

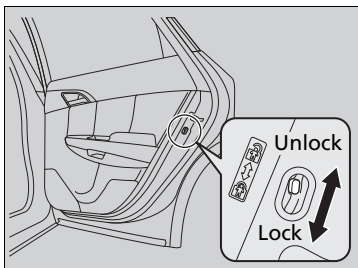

Slide the lever in the rear door to the lock position, and close the door.

### ■ When opening the door

Open the door using the outside door handle.

### ☒ Childproof Door Locks

To open the door from the inside when the childproof door lock is on, put the lock tab in the unlock position, lower the rear window, put your hand out of the window, and pull the outside door handle.

## Auto Door Locking/Unlocking

Your vehicle locks all doors and unlocks the driver's door automatically when a certain condition is met.

### ■ Auto Door Locking

#### ■ Drive lock mode

All doors and tailgate lock when the vehicle's speed reaches about 10 mph (15 km/h).

### ■ Auto Door Unlocking

#### ■ Park unlock mode

The driver's door unlocks when the shift lever is moved into **P** with the brake pedal depressed.

### » Auto Door Locking/Unlocking

#### Models with audio/information screen

You can turn off or change to another auto door locking/unlocking setting using the audio/information screen.

➤ **Customized Features\*** P. 281

#### Models without audio/information screen

You can turn off or change to another auto door locking/unlocking setting using the master door lock switch.

➤ **Customizing the Auto Door Locking/Unlocking Setting\*** P. 102

\* Not available on all models

## Customizing the Auto Door Locking/Unlocking Setting \*

You can customize the auto door locking/unlocking setting to your liking using the master door lock switch.

### List of the Auto Door Locking/Unlocking Customizable Options

#### Auto door locking

Mode	Description
<b>Drive Lock Mode</b>	All doors lock when the vehicle's speed reach about 10 mph (15 km/h).* <sup>1</sup>
<b>Park Lock Mode</b>	All doors lock when the shift lever is moved out of <b>P</b> with the brake pedal depressed.
<b>Off</b>	The auto door locking is deactivated all the time.

#### Auto door unlocking

Mode	Description
<b>Park UnLock Mode</b>	Driver's door unlocks* <sup>1</sup> /All doors unlock When the shift lever is moved into <b>P</b> with the brake pedal depressed.
<b>Ignition Switch Unlock Mode</b>	Driver's door unlocks/All doors unlock When the ignition switch is moved out of ON <b>II</b> .
<b>Off</b>	The auto door unlocking is deactivated all the time.

\*1:Default setting

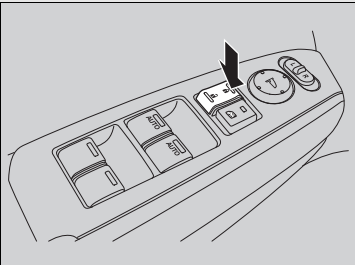

## ■ Customizing Flow for Auto Door Locking Options

Steps	Drive Lock Mode	Park Lock Mode	Off
1	Apply the parking brake. Make sure the shift lever is in <b>P</b> .		
2	Turn the ignition switch to ON <b>II</b> .		
3	The driver's door must be closed at this stage.		Open the driver's door.
4	Move the shift lever out of <b>P</b> with the brake pedal depressed.	—	Pull the lock tab rearward.
5	<p>Press and hold the front of the master door lock switch on the driver's door for more than five seconds. Release the switch after you hear a click twice.</p> 		Press and hold the front of the master door lock switch on the driver's door for more than five seconds. Release the switch after you hear one click.
6	Move the shift lever to <b>P</b> .	—	
7	Turn the ignition switch to LOCK <b>0</b> within five seconds. ► Customization is completed.		

Controls

## ■ Customizing Flow for Auto Door Unlocking Options

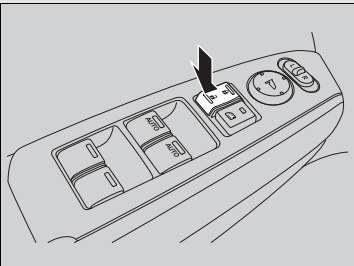
Steps	Ignition Switch Unlock Mode		Park Unlock Mode		Off
	To unlock driver's door	To unlock all doors	To unlock driver's door	To unlock all doors	
1	Apply the parking brake. Make sure the shift lever is in <b>P</b> .				
2	Turn the ignition switch to ON <b>II</b> .				
3	The driver's door must be closed at this stage.				Open the driver's door.
4	Move the shift lever out of <b>P</b> with the brake pedal depressed.		—		
5	Press and hold the rear of the master door lock switch on the driver's door for more than five seconds. You will hear a click twice.				
6	Release the switch.	Keep pressing the switch for another five seconds to hear one more click.	Release the switch.	Keep pressing the switch for another five seconds to hear one more click.	Release the switch.
7	Move the shift lever to <b>P</b> .		—		
8	Turn the ignition switch to LOCK <b>0</b> within five seconds. ▶ Customization is completed.				

## Precautions for Opening/Closing the Tailgate

Always make sure individuals and objects are clear of the tailgate before opening or closing it.

### ■ Opening the tailgate

- Open the tailgate all the way.
  - ▶ If it is not fully opened, the tailgate may begin to close under its own weight.
- Be careful when it is windy. The wind may cause the tailgate to close.

### ■ Closing the tailgate

Keep the tailgate closed while driving to:

- ▶ Avoid possible damage.
- ▶ Prevent exhaust gas from leaking into the vehicle.
- ▶ **Carbon Monoxide Gas** P. 66

### ⊠ Precautions for Opening/Closing the Tailgate

Be careful not to put your hands between the tailgate and the cargo area when closing the gate.

When you are storing or picking up luggage from the cargo area while the engine is idling, do not stand in front of the exhaust pipe. You may get burned.

Do not allow any passenger in the cargo space. They may get hurt during hard braking, a sudden acceleration, or a crash.

## Using the Tailgate Release Button

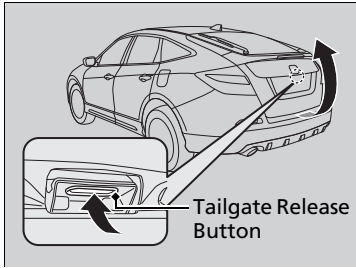

When all the doors are unlocked, the tailgate is unlocked. Press the tailgate release button and lift open the tailgate.

### Models with smart entry system

Even if the tailgate is locked, you can open the tailgate if you carry the smart entry remote.

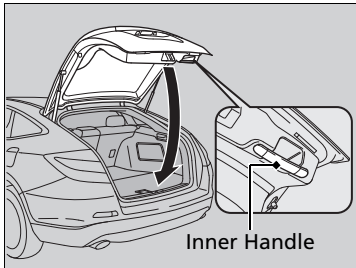

To close the tailgate, grab the inner handle, pull the tailgate down, and push it closed from outside.

### ►► Using the Tailgate Release Button

#### Models with smart entry system

- Do not leave the smart entry remote in the vehicle when you get out. Carry it with you.
- A person who is not carrying the smart entry remote can unlock the tailgate if a person who is carrying it is within range.
- Do not leave the smart entry remote inside the cargo area and close the tailgate. The beeper sounds and the tailgate cannot be closed.

## Immobilizer System

The immobilizer system prevents a key that has not been pre-registered from starting the engine. Each key contains electronic transmitters that use electronic signals to verify the key.

Pay attention to the following when inserting the key into the ignition switch or pressing the **ENGINE START STOP** button:

- Do not allow objects that emit strong radio waves near the ignition switch or the **ENGINE START STOP** button.
- Make sure the key is not covered by or touching a metal object.
- Do not bring a key from another vehicle's immobilizer system near the ignition switch.

## Security System Alarm

The security system alarm activates when the doors, tailgate, or hood are opened without the key, remote transmitter, or smart entry system.

### ■ When the security system alarm activates

The horn sounds intermittently and all of the exterior lights flash.

### ■ To deactivate the security system alarm

Unlock the vehicle using the key, remote transmitter or smart entry remote, or turn the ignition switch to ON **II**\*1. The system, along with the horn and flashing lights, is deactivated.

\*1: Models with the smart entry system have an **ENGINE START/STOP** button instead of an ignition switch.

### ☒ Immobilizer System

#### NOTICE

Leaving the ignition key in the vehicle can result in theft or accidental movement of the vehicle. Always take the ignition key with you whenever you leave the vehicle unattended.

Do not alter the system or add other devices to it. Doing so may damage the system and make your vehicle inoperable.

### ☒ Security System Alarm

The security alarm continues for a maximum of two minutes until the security system deactivates.

### ■ Setting the security system alarm

The security system alarm automatically sets when the following conditions have been met:

- The ignition switch is in LOCK **0**\*1, and the key has been removed from the ignition switch.
- The hood and tailgate are closed.
- All doors are locked with the key, remote transmitter, or smart entry system.

### ■ When the security system alarm sets

The security system alarm indicator in the instrument panel blinks. When the blinking interval changes after about 15 seconds, the security system alarm is set.

### ■ To cancel the security system alarm

The security system alarm is canceled when the vehicle is unlocked using the key, remote transmitter, or smart entry system, or the ignition switch is turned to ON **II**\*1. The security system alarm indicator goes off at the same time.

\*1: Models with the smart entry system have an **ENGINE START/STOP** button instead of an ignition switch.

### ⌘ Security System Alarm

Do not set the security system alarm when someone is in the vehicle or a window is open. The system can accidentally activate when:

- Unlocking the door with the lock tab or the master door lock switch.

If the battery goes dead after you have set the security system alarm, the security alarm may go off once the battery is recharged or replaced.

If this occurs, deactivate the security system alarm by unlocking a door using the key or remote transmitter.

Do not attempt to alter this system or add another device to it.

## ■ Panic Mode

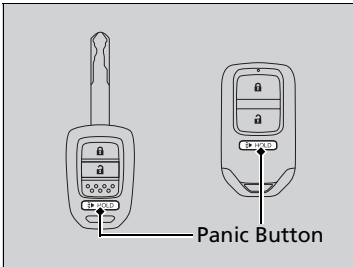

### ■ The panic button on the remote transmitter

If you press the panic button for approximately one second, the following will occur for about 30 seconds:

- The horn sounds.
- Some exterior lights flash.

### ■ Canceling panic mode

Press any button on the remote transmitter, or turn the ignition switch to ON \*1.

\*1: Models with the smart entry system have an **ENGINE START/STOP** button instead of an ignition switch.

## Opening/Closing the Power Windows

The power windows can be opened and closed when the ignition switch is in ON **II**\*1, using the switches on the doors. The driver side switches can be used to open and close all of the windows.

The power window lock button on the driver side must be switched off (not pushed in, indicator off) to open and close the windows from anywhere other than the driver's seat.

When the power window lock button is pushed in, the indicator comes on and you can only operate the driver's window. Turn the power window lock button on when children are in the vehicle.

### Opening/Closing Windows with Auto-Open/Close Function

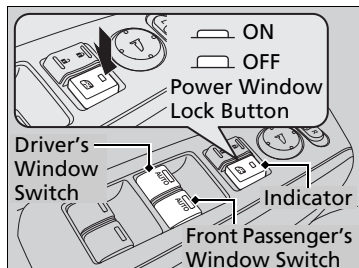

#### Automatic operation

**To open:** Push the switch down firmly.

**To close:** Pull the switch up firmly.

The window opens or closes completely. To stop the window at any time, push or pull the switch briefly.

#### Manual operation

**To open:** Push the switch down lightly.

**To close:** Pull the switch up lightly.

Release the switch when the window reaches the desired position.

\*1: Models with the smart entry system have an **ENGINE START/STOP** button instead of an ignition switch.

### Opening/Closing the Power Windows

## WARNING

Closing a power window on someone's hands or fingers can cause serious injury.

Make sure your passengers are away from the windows before closing them.

The power windows can be operated for up to 10 minutes after you turn the ignition switch off. Opening either front door cancels this function.

#### Auto Reverse

If a power window senses resistance when closing automatically, it will stop closing and reverse direction.

The driver's window auto reverse function is disabled when you continuously pull up the switch.

The auto reverse function stops sensing when the window is almost closed to ensure that it fully closes.



### ■ Opening/Closing Windows without Auto-Open/Close Function

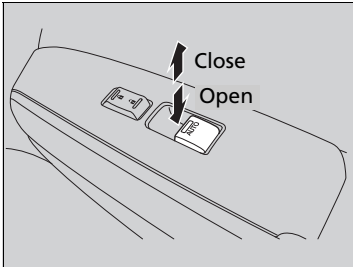

**To open:** Push the switch down.

**To close:** Pull the switch up.

Release the switch when the window reaches the desired position.

### ■ Opening Windows and Moonroof with the Remote

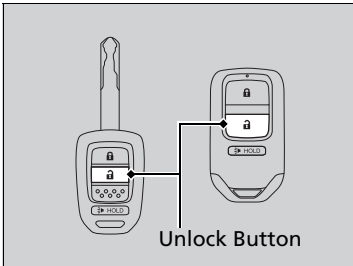

**To open:** Press the unlock button twice within 10 seconds and hold it down for the second time. If the windows stop midway, repeat the procedure.

## ■ Opening/Closing the Windows and Moonroof with the Key

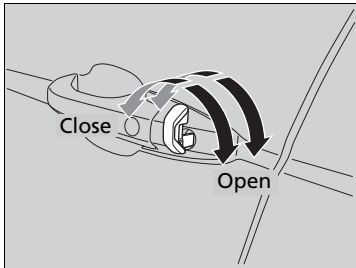

**To open:** Unlock the driver's door with the key. Within 10 seconds of returning the key to the central position, turn the key in the unlock direction and hold it there.

**To close:** Lock the driver's door with the key. Within 10 seconds of returning the key to the central position, turn the key in the lock direction and hold it there.

Release the key to stop the windows/moonroof at the desired position. If you want further adjustment, repeat the same operation.

## Opening/Closing the Moonroof

You can only operate the moonroof when the ignition switch is in ON **II**\*1. Use the switch in the front of the ceiling to open and close the moonroof.

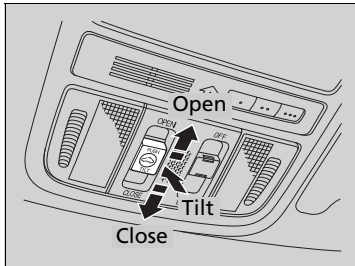

### Automatic operation

**To open:** Pull the switch back firmly, then release.

**To close:** Push the switch forward firmly, then release.

The moonroof will automatically open or close all the way. To stop the moonroof midway, touch the switch briefly.

### Manual operation

**To open:** Pull the switch back, and hold it until the desired position is reached.

**To close:** Push the switch forward, and hold it until the desired position is reached.

### Tilting the moonroof up

**To tilt:** Push on the center of the moonroof switch.

**To close:** Push the switch forward firmly, then release.

\*1: Models with the smart entry system have an **ENGINE START/STOP** button instead of an ignition switch.

## Opening/Closing the Moonroof

### WARNING

Opening or closing the moonroof on someone's hands or fingers can cause serious injury.

Make sure all hands and fingers are clear of the moonroof before opening or closing it.

### NOTICE

Opening the moonroof in below freezing temperature or when it is covered with snow or ice can damage the moonroof panel or motor.

The power moonroof can be operated for up to 10 minutes after you turn the ignition switch off. Opening either front door cancels this function.

When resistance is detected, the auto reverse function causes the moonroof to change directions, then stop. Auto reverse stops sensing when the moonroof is almost closed to ensure that it fully closes. Make sure that all objects, including fingers, are clear of the moonroof.

## Ignition Switch \*

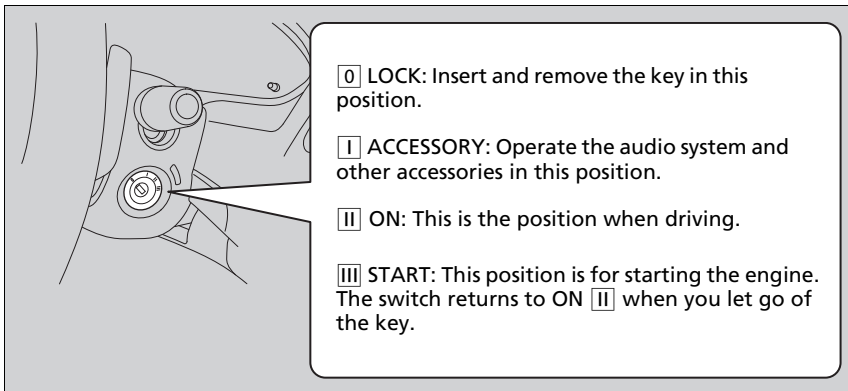

### Ignition Switch \*

You cannot take the key out unless the shift lever is in **P**.

If you open the driver's door when the key is in LOCK **0** or ACCESSORY **I**, a warning buzzer will sound to remind you to take the key out.

If the key won't turn from LOCK **0** to ACCESSORY **I**, turn the key while moving the steering wheel left and right. The steering wheel will unlock, allowing the key to turn.

## ENGINE START/STOP Button\*

### ■ Changing the Power Mode

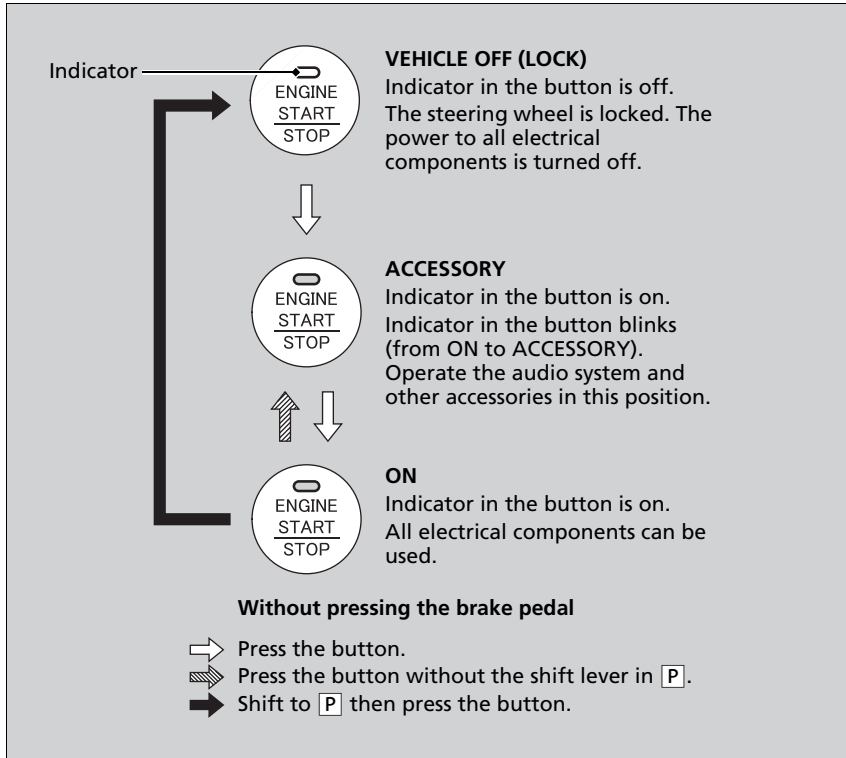

### ⊞ ENGINE START/STOP Button\*

#### ENGINE START/STOP Button Operating Range

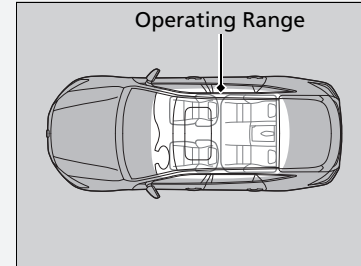

You can start the engine when the smart entry remote is inside the vehicle.  
The engine may also run if the smart entry remote is close to the door or window, even if it is outside the vehicle.

**ON mode:**  
Indicator in the button is off, if the engine is running.

If the smart entry remote battery is weak, beeper sounds and the **TO START, HOLD REMOTE NEAR START BUTTON** message appears on the information display.

⊞ **If the Smart Entry Remote Battery is Weak**  
P. 526

Do not leave the power mode in ACCESSORY or ON when you get out.

## ■ Automatic Power Off

If you leave the vehicle for 30 to 60 minutes with the shift lever in **P** and the power mode in ACCESSORY, the vehicle automatically goes into the mode similar to VEHICLE OFF (LOCK) to avoid the battery drain.

When in this mode:

The steering wheel does not lock.

You cannot lock or unlock doors with the remote transmitter or the smart entry system.

Press the **ENGINE START/STOP** button to switch the mode to VEHICLE OFF (LOCK).

## ▶ENGINE START/STOP Button\*

If the power mode does not change from VEHICLE OFF to ACCESSORY, press the **ENGINE START/STOP** button while moving the steering wheel left and right. The steering wheel will unlock, allowing the mode to change.

## ■ Power Mode Reminder

If you open the driver's door when the power mode is set to ACCESSORY, a warning beep sounds.

## ■ Smart Entry Remote Reminder



NO KEY

Warning buzzers may sound from inside or/ and outside the vehicle to remind you that the smart entry remote is out of the vehicle. If the buzzer continues even after the remote is put back inside, place it to be within its operational range.

### ■ When the power mode is in ON

If the smart entry remote is taken out of the vehicle, and the driver's door is closed, warning buzzers sound from both inside and outside the vehicle. A warning message on the information display notifies the driver inside that the remote is out.

### ■ When the power mode is in ACCESSORY

If the smart entry remote is taken out of the vehicle, and all the doors are closed, a warning buzzer sounds from outside the vehicle.

## ▶▶ Smart Entry Remote Reminder









When the smart entry remote is within the system's operational range, and the driver's door is closed, the warning function cancels.

If the smart entry remote is taken out of the vehicle after the engine has been started, you can no longer change the **ENGINE START/STOP** button mode or restart the engine. Always make sure if the remote is in your vehicle when you operate the **ENGINE START/STOP** button.

Removing the smart entry remote from the vehicle through a window does not activate the warning buzzer.

Do not put the smart entry remote on the dashboard or in the glove box. It may cause the warning buzzer to go off. Under some other conditions that can prevent the vehicle from locating the remote, the warning buzzer may also go off even if the remote is within the system's operational range.

## Ignition Switch and Power Mode Comparison

Ignition Switch Position	LOCK (0) (with/without the key) 	ACCESSORY (I) 	ON (II) 	START (III) 
Without Smart Entry System	<ul style="list-style-type: none"> <li>• Engine is turned off and power is shut down.</li> <li>• The steering wheel is locked.</li> <li>• No electrical components can be used.</li> </ul>	<ul style="list-style-type: none"> <li>• Engine is turned off.</li> <li>• Some electrical components such as the audio system and the accessory power socket can be operated.</li> </ul>	<ul style="list-style-type: none"> <li>• Normal key position while driving.</li> <li>• All electrical components can be used.</li> </ul>	<ul style="list-style-type: none"> <li>• Use this position to start the engine.</li> <li>• The ignition switch returns to the ON (II) position when you release the key.</li> </ul>
Power Mode	VEHICLE OFF (LOCK) 	ACCESSORY 	ON   Indicator is: On Off	START 
With Smart Entry System and <b>ENGINE START/STOP</b> Button	Indicator-Off <ul style="list-style-type: none"> <li>• Engine is turned off and power is shut down.</li> <li>• The steering wheel is locked.</li> <li>• No electrical components can be used.</li> </ul>	Indicator-On or blinking <ul style="list-style-type: none"> <li>• Engine is turned off.</li> <li>• Some electrical components such as the audio system and the accessory power socket can be operated.</li> </ul>	Indicator-On (engine is turned off) Off (engine is running) <ul style="list-style-type: none"> <li>• All electrical components can be used.</li> </ul>	Indicator-Off <ul style="list-style-type: none"> <li>• The mode automatically returns to ON after the engine starts.</li> </ul>



## Turn Signals

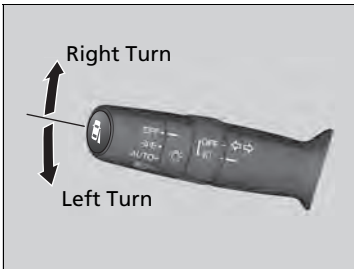

The turn signals can be used when the ignition switch is in ON \*1.

### ■ One-touch turn signal

When you lightly push up or down and release the turn signal lever, the exterior turn signals and turn signal indicator blink three times.

This feature can be used when signaling for a lane change.

## Light Switches

### ■ Manual Operation

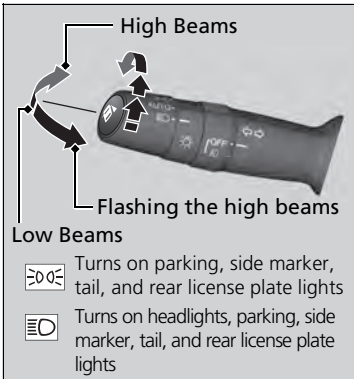

Rotating the light switch turns the lights on and off, regardless of the position of the ignition switch\*1.

### ■ High beams

Push the lever forward until you hear a click.

### ■ Low beams

When in high beams, pull the lever back to return to low beams.

### ■ Flashing the high beams

Pull the lever back, and release it.

\*1: Models with the smart entry system have an **ENGINE START/STOP** button instead of an ignition switch.

### ⊗ Light Switches

If you remove the key from the ignition switch or leave the power mode in VEHICLE OFF (LOCK) while the lights are on, a chime sounds when the driver's door is opened.

When the lights are on, the lights on indicator in the instrument panel will be on.

### ➤ Lights On Indicator P. 79

Do not leave the lights on when the engine is off because it will cause the battery to discharge.

If you sense that the level of the headlights is abnormal, have the vehicle inspected by a dealer.

## ■ Automatic Lighting Control

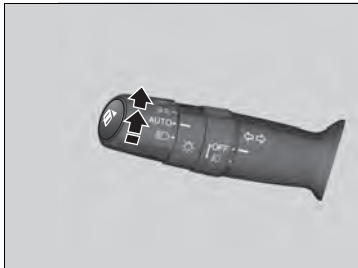

Automatic lighting control can be used when the ignition switch is in ON \*1.

When you turn the light switch to **AUTO**, the headlights and other exterior lights will switch on and off automatically depending on the ambient brightness.

### Models with audio/information screen

▶ You can change the auto light sensitivity setting.

➤ **Customized Features\*** P. 281

## ☒ Automatic Lighting Control

We recommend that you turn on the lights manually when driving at night, in a dense fog, or in dark areas such as long tunnels or parking facilities.

The light sensor is in the location shown below. Do not cover this light sensor with anything; otherwise, the automatic lighting system may not work properly.

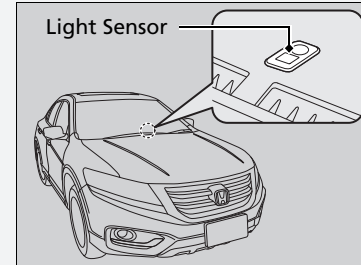

### Models with audio/information screen

Adjust the auto light sensitivity as follows:

Setting	The exterior lights come on when the ambient light is at
<b>MAX</b>	 <p>Bright</p>
<b>HIGH</b>	
<b>MID</b>	
<b>LOW</b>	
<b>MIN</b>	

\*1: Models with the smart entry system have an **ENGINE START/STOP** button instead of an ignition switch.

\* Not available on all models

## Automatic Lighting Off Feature

### Models without smart entry system

The headlights, all other exterior lights, and the instrument panel lights turn off within 15 seconds after you remove the key and close the driver's door.

### Models with smart entry system

The headlights, all other exterior lights, and the instrument panel lights turn off within 15 seconds after you set the power mode to VEHICLE OFF (LOCK), take the remote with you, and close the driver's door.

▶ You can change the headlight auto off timer setting.

➤ **Customized Features\*** P. 281

### All models

If you turn the ignition switch to LOCK <sup>\*1</sup> with the headlight switch on, but do not open the door, the lights turn off after 10 minutes (three minutes, if the switch is in the **AUTO** position).

The lights turn on again when you unlock or open the driver's door. If you unlock the door, but do not open it within 15 seconds, the lights go off. If you open the driver's door, you will hear a lights on reminder chime.

\*1: Models with the smart entry system have an **ENGINE START/STOP** button instead of an ignition switch.

\* Not available on all models

## Fog Lights



When the low beam headlights are on, turn the fog light switch on to use the fog lights.



### ☒ Fog Lights

When the fog lights are on, the indicator in the instrument panel will be on. They go off when the headlights turn off, or when the daytime running lights are on.

☒ **Fog Light Indicator** P. 79

## Daytime Running Lights

The high beam headlights come on slightly dimmer than normal when the following conditions have been met:

- The ignition switch is in ON <sup>\*1</sup>.
- The headlight switch is off, or in .
- The parking brake is released.

The lights remain on even if you set the parking brake. Turning off the ignition switch or setting the power mode to VEHICLE OFF will turn off the daytime running lights.

The high beam headlights return to the original brightness once the headlight switch is turned on.

\*1: Models with the smart entry system have an **ENGINE START/STOP** button instead of an ignition switch.

# Wipers and Washers

## ■ Front Wiper/Washer

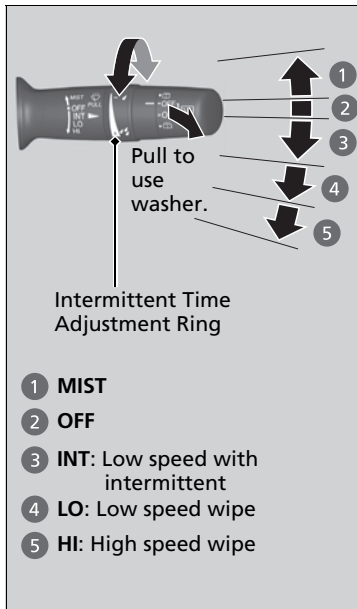

The windshield wipers and washers can be used when the ignition switch is in ON \*1.

### ■ MIST

The wipers run at high speed until you release the lever.

### ■ Wiper switch (OFF, INT, LO, HI)

Change the wiper switch setting according to the amount of rain.

### ■ Adjusting the delay

Turn the adjustment ring to adjust the wiper delay.

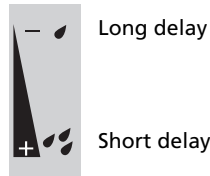

### ■ Washer

Sprays while you pull the lever toward you. When you release the lever, the wipers make two or three more sweeps before stopping.

\*1: Models with the smart entry system have an **ENGINE START/STOP** button instead of an ignition switch.

## ▣ Wipers and Washers

### NOTICE

Do not use the wipers when the windshield is dry. The windshield will get scratched, or the rubber blades will get damaged.

### NOTICE

In cold weather, the blades may freeze to the windshield, becoming stuck. Operating the wipers in this condition may damage the wipers. Use the defroster to warm the windshield, then turn the wipers on.

Turn the washers off if no washer fluid comes out. The pump may get damaged.

If the vehicle speeds up while the wipers are operating intermittently, the length of the wipe interval shortens. When the vehicle starts moving, the wipers make a single sweep. When the vehicle speeds up, the wiper operation's shortest delay setting and the **LO** setting become the same.

## ■ Rear Wiper/Washer

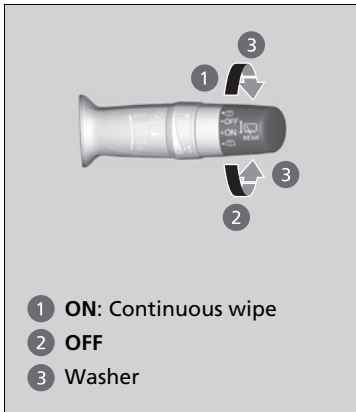

The rear wiper and washer can be used when the ignition switch is in ON \*1.

### ■ Wiper switch (OFF, ON)

The wiper operates intermittently after completing a few sweeps.

### ■ Washer ( )

Sprays while you rotate the switch to this position.

Hold it to activate the wiper and to spray the washer. Once released, it stops operating after a few more sweeps.

### ■ Operating in reverse

When you shift the transmission to R with the front wiper activated, the rear wiper operates automatically as follows even if its switch is off.

Front Wiper Position	Rear Wiper Operation
<b>INT</b> (Intermittent)	Intermittent
<b>LO</b> (Low speed wipe) <b>HI</b> (High speed wipe)	Continuous

\*1: Models with the smart entry system have an **ENGINE START/STOP** button instead of an ignition switch.

## ▶▶ Rear Wiper/Washer

If the wiper stops operating due to any obstacle such as the build-up of snow, park the vehicle in a safe place.

Rotate the wiper switch to **OFF**, and turn the ignition switch to ACCESSORY 1 or LOCK 0\*1, then remove the obstacle.

The wiper motor is equipped with a breaker that may stop motor operation temporarily to prevent an overload. Wiper operation will return to normal within a few minutes, once the circuit has returned to normal.

## Brightness Control

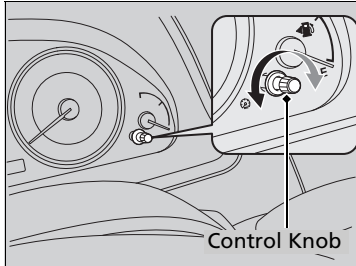

When the parking lights are turned on and the ignition switch is in ON <sup>\*1</sup>, you can use the brightness control knob to adjust instrument panel brightness.

**Brighten:** Turn the knob to the right.

**Dim:** Turn the knob to the left.

You will hear a beep when the brightness reaches minimum or maximum. The information display will return to its original state several seconds after you adjust the brightness.

### ■ Brightness level indicator

The brightness level is shown on the information display while you are adjusting it.

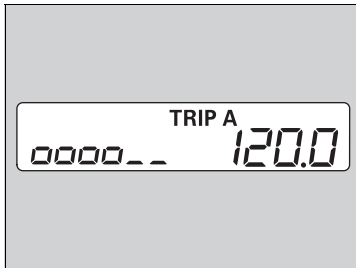

\*1: Models with the smart entry system have an **ENGINE START/STOP** button instead of an ignition switch.

### ☒ Brightness Control

Instrument panel brightness varies, depending on whether the exterior lights are on or off. The instrument panel dims to reduce glare when they are on.

Pressing the  (Select/Reset) knob switches the display.

If you turn the knob to the right until the brightness display is up to max, the beeper sounds. This cancels the reduced instrument panel brightness when the exterior lights are on.

## Rear Defogger/Heated Door Mirror Button

Press the rear defogger and heated door mirror button to defog the rear window and mirrors when the ignition switch is in ON \*1.

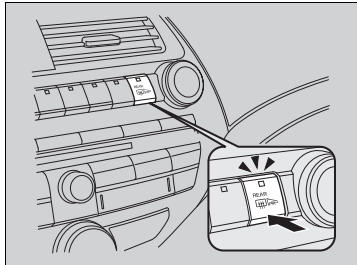

### Models with heating and cooling system

The rear defogger and heated door mirrors automatically switch off after 20 minutes. However, if the outside temperature is 18°F (-8°C) or below, they do not automatically switch off.

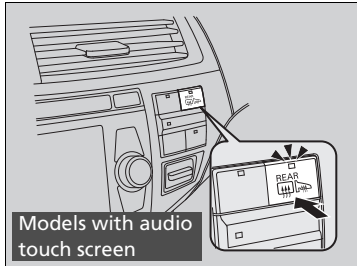

Models with audio touch screen

### Models with climate control system

The rear defogger and heated door mirrors automatically switch off after 10-30 minutes depending on the outside temperature. However, if the outside temperature is 32°F (0°C) or below, they do not automatically switch off.

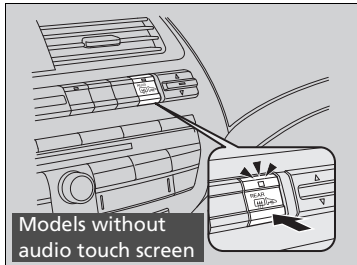

Models without audio touch screen

\*1: Models with the smart entry system have an **ENGINE START/STOP** button instead of an ignition switch.

### ▶▶ Rear Defogger/Heated Door Mirror Button

#### NOTICE

When cleaning the inside of the rear window, be careful not to damage the heating wires. It is critical to wipe the window from side to side along the defogger heating wires.

This system consumes a lot of power, so turn it off when the window has been defogged. Also, do not use the system for a long period when the engine is idling. This may weaken the battery, making it difficult to start the engine.



## Driving Position Memory System\*

You can store two driver's seat and door mirror positions with the driving position memory system.

When you unlock and open the driver's door with a remote, the seat and door mirrors adjust automatically to one of the two preset positions.

Select either remote you use to unlock the vehicle when you enter.

- **DRIVER 1** transmitter is linked to memory button 1.
- **DRIVER 2** transmitter is linked to memory button 2.



Models with smart entry system

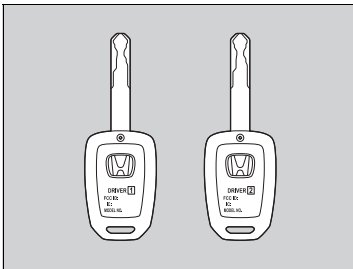

Models without smart entry system

### ▶▶ Driving Position Memory System\*

#### Models with audio/information screen

Using the audio/information screen, you can disable the automatic seat adjustment function.

▶ **Customized Features\*** P. 281

\* Not available on all models

## ■ Storing a Position in Memory

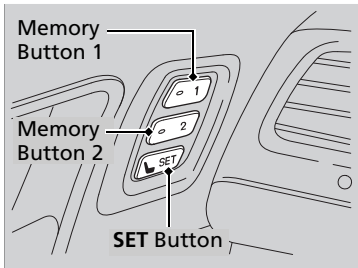

1. Turn the ignition switch to ON \*1. Adjust the driver's seat and the door mirrors to the desired position.
2. Press the **SET** button.
  - ▶ You will hear a beep, and the memory button indicator light will blink.
3. Press and hold memory button or within five seconds of pressing the **SET** button.
  - ▶ Once the seat and the door mirrors position has been memorized, the indicator light on the button you pressed stays on.

## ■ Recalling the Stored Position

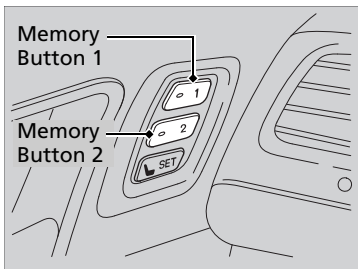

1. Move the shift lever to .
2. Apply the parking brake.
3. Press a memory button ( or ).
  - ▶ You will hear a beep, and the indicator light will blink.

\*1: Models with the smart entry system have an **ENGINE START/STOP** button instead of an ignition switch.

## ▣ Storing a Position in Memory

After you press the **SET** button, the storing operation will be canceled when:

- You do not press the memory button within five seconds.
- You readjust the seat position before the double-beep.
- You readjust the door mirrors.
- You turn the ignition switch to any position except ON \*1.

## ▣ Recalling the Stored Position

The seat and the door mirrors automatically move to the memorized position. When they finish moving, the beeper sounds, and the indicator light stays on.

The seat and the door mirrors stop moving if you:

- Press the **SET** button, or a memory button ( or .
- Adjust the seat position.
- Adjust the door mirrors.
- Shift into any position except .

## Adjusting the Steering Wheel

The steering wheel height and distance from your body can be adjusted so that you can comfortably grip the steering wheel in an appropriate driving posture.

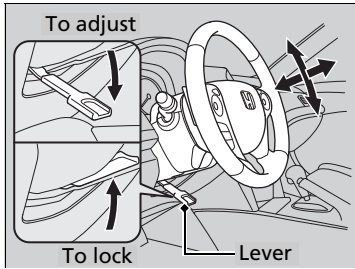

1. Push the steering wheel adjustment lever down.
  - ▶ The steering wheel adjustment lever is under the steering column.
2. Move the steering wheel up or down, and in or out.
  - ▶ Make sure you can see the instrument panel gauges and indicators.
3. Pull the steering wheel adjustment lever up to lock the steering wheel in position.
  - ▶ After adjusting the position, make sure you have securely locked the steering wheel in place by trying to move it up, down, in, and out.

### Adjusting the Steering Wheel

## ⚠ WARNING

Adjusting the steering wheel position while driving may cause you to lose control of the vehicle and be seriously injured in a crash.

Adjust the steering wheel only when the vehicle is stopped.

Make any steering wheel adjustments before you start driving.

## Interior Rearview Mirror

Adjust the angle of the rearview mirror when you are sitting in the correct driving position.

### Automatic Dimming Rearview Mirror

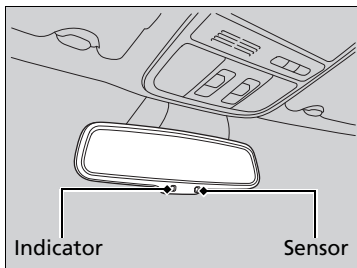

When driving after dark, the automatic dimming rearview mirror reduces the glare from headlights behind you.

#### Adjusting the Mirrors

Keep the inside and outside mirrors clean and adjusted for best visibility.

Adjust the mirrors before you start driving.

➤ **Adjusting the Seat Positions** P. 133

#### Automatic Dimming Rearview Mirror

The auto dimming function cancels when the shift position is in **R**.

## Power Door Mirrors

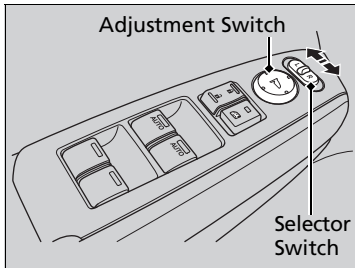

You can adjust the door mirrors when the ignition switch is in ON **II**\*1.

### ■ Mirror position adjustment

**L/R selector switch:** Select the left or right mirror. After adjusting the mirror, return the switch to the center position.

**Mirror position adjustment switch:** Press the switch left, right, up, or down to move the mirror.

### ■ Reverse Tilt Door Mirror\*

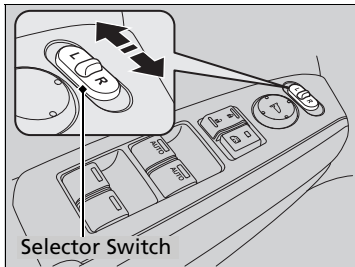

If activated, either side door mirror automatically tilts downward when you put the shift lever in **R**; this improves close-in visibility on the selected side of the vehicle when reversing. The mirror automatically returns to its original position when you shift out of **R**.

To activate this feature, turn the ignition switch to ON **II**\*1, and slide the selector switch to the left or right side.

\*1: Models with the smart entry system have an **ENGINE START/STOP** button instead of an ignition switch.

\* Not available on all models

## ■ Expanded View Driver's Mirror

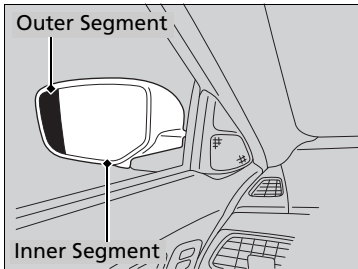

The driver side door mirror has outer and inner segments.

The outer segment is slightly curved to provide a wider angle view than a standard flat mirror. This wider view may help you check areas that are not visible using a standard door mirror.

## ▣ Expanded View Driver's Mirror

Objects visible in the outer segment of the driver side door mirror appears smaller than objects in the rest of the mirror. But in fact, they are closer than they appear.

Do not rely on your mirrors. Always look to the side and behind your vehicle before changing lanes.

## Adjusting the Seat Positions

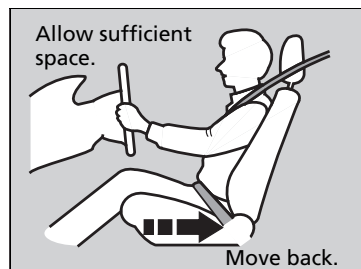

Adjust the driver's seat as far back as possible while allowing you to maintain full control of the vehicle. You should be able to sit upright, well back in the seat and be able to adequately press the pedals without leaning forward, and grip the steering wheel comfortably. The passenger's seat should be adjusted in a similar manner, so that it is as far back from the front airbag in the dashboard as possible.

### ■ Adjusting the front power seat(s)\*

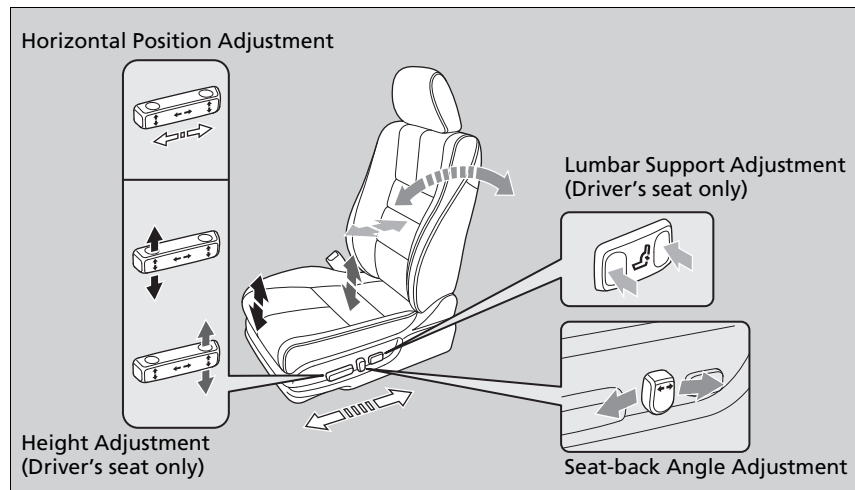

\* Not available on all models

Continued

### Adjusting the Seats

## ⚠ WARNING

Sitting too close to a front airbag can result in serious injury or death if the front airbags inflate.

Always sit as far back from the front airbags as possible while maintaining control of the vehicle.

The National Highway Traffic Safety Administration and Transport Canada recommend that drivers allow at least 10 inches (25 cm) between the center of the steering wheel and the chest.

Always make seat adjustments before driving.

### ■ Adjusting the front manual seat\*

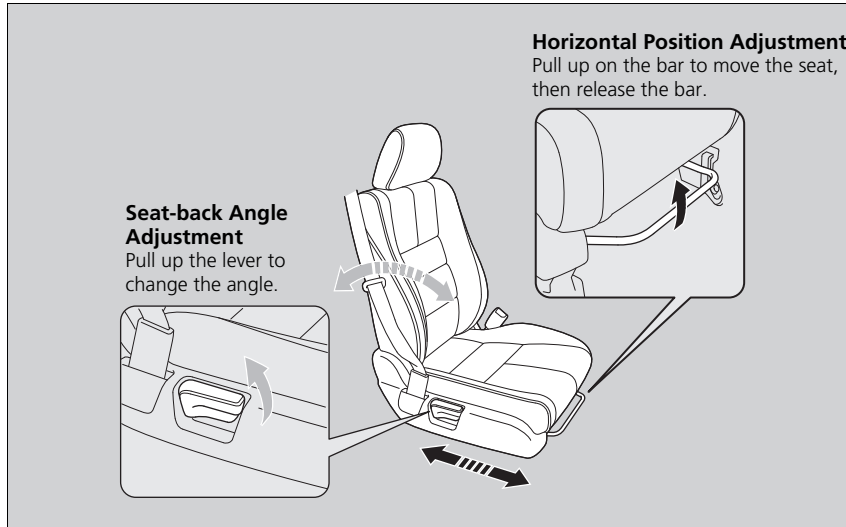

### ▶▶ Adjusting the front manual seat\*

Once a seat is adjusted correctly, rock it back and forth to make sure it is locked in position.



## ■ Adjusting the Seat-Backs

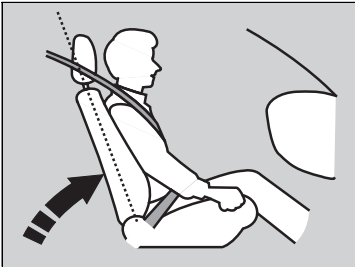

Adjust the driver's seat-back to a comfortable, upright position, leaving ample space between your chest and the airbag cover in the center of the steering wheel.

The front seat passenger should also adjust their seat-back to a comfortable, upright position.

Reclining a seat-back so that the shoulder part of the belt no longer rests against the occupant's chest reduces the protective capability of the belt. It also increases the chance of sliding under the belt in a crash and being seriously injured. The farther a seat-back is reclined, the greater the risk of injury.

## ▣ Adjusting the Seat-Backs

### ⚠ WARNING

Reclining the seat-back too far can result in serious injury or death in a crash.

Adjust the seat-back to an upright position, and sit well back in the seat.

Do not put a cushion, or other object, between the seat-back and your back.

Doing so may interfere with proper seat belt or airbag operation.

If you cannot get far enough away from the steering wheel and still reach the controls, we recommend that you investigate whether some type of adaptive equipment may help.

## ■ Adjusting the Head Restraints

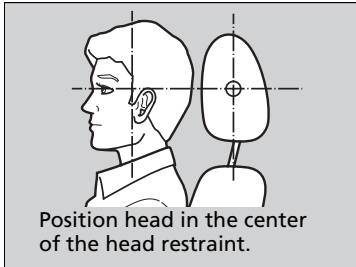

Your vehicle is equipped with head restraints in all seating positions.

Head restraints are most effective for protection against whiplash and other rear-impact crash injuries when the center of the back of the occupant's head rests against the center of the restraint. The tops of the occupant's ears should be level with the center height of the restraint.

## ■ Adjusting the front head restraint positions

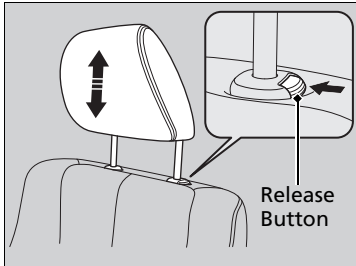

**To raise the head restraint:** Pull it upward.

**To lower the head restraint:** Push it down while pressing the release button.

## ► Adjusting the Head Restraints

### **⚠ WARNING**

Improperly positioning head restraints reduces their effectiveness and increases the likelihood of serious injury in a crash.

**Make sure head restraints are in place and positioned properly before driving.**

The driver's and front passenger's seats have active head restraints.

► **Active Head Restraints** P. 138

## ■ Changing the Rear Seat Head Restraint Positions

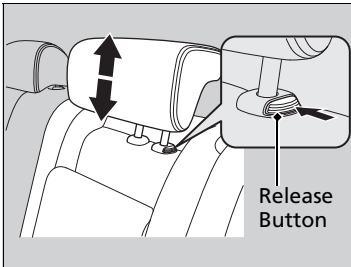

A passenger sitting in a back seating position should adjust the height of their head restraint to an appropriate position before the vehicle begins moving.

**To raise the head restraint:**

Pull it upward.

**To lower the head restraint:**

Push it down while pressing the release button.

## ■ Removing and Reinstalling the Head Restraints

Head restraints can be removed for cleaning or repair.

**To remove the head restraint:**

Pull the restraint up as far as it will go. Then push the release button, and pull the restraint up and out.

**To reinstall the head restraint:**

Insert the legs back in place, then adjust the head restraint to an appropriate height while pressing the release button. Pull up on the restraint to make sure it is locked in position.

### ▣ Removing and Reinstalling the Head Restraints

## ⚠ WARNING

Failure to reinstall, or correctly reinstall, the head restraints can result in severe injury during a crash.

Always replace the head restraints before driving.

## ■ Maintain a Proper Sitting Position

After all occupants have adjusted their seats and head restraints, and put on their seat belts, it is very important that they continue to sit upright, well back in their seats, with their feet on the floor, until the vehicle is safely parked and the engine is off.

Sitting improperly can increase the chance of injury during a crash. For example, if an occupant slouches, lies down, turns sideways, sits forward, leans forward or sideways, or puts one or both feet up, the chance of injury during a crash is greatly increased.

In addition, an occupant who is out of position in the front seat can be seriously or fatally injured in a crash by striking interior parts of the vehicle or being struck by an inflating front airbag.

## ■ Active Head Restraints

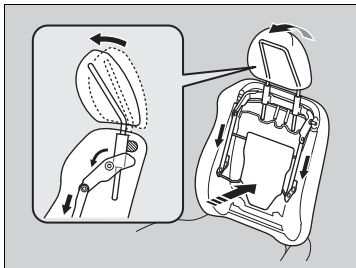

The driver's and front passenger's seats have active head restraints. In a rear impact, an occupant properly secured by a seat belt will be pushed against the seat-back and the head restraint will move forward. This reduces the distance between the restraint and the occupant's head, which helps reduce the likelihood of whiplash and injuries to the neck and upper spine.

## ⌘ Maintain a Proper Sitting Position

### ⚠ WARNING

**Sitting improperly or out of position can result in serious injury or death in a crash.**

**Always sit upright, well back in the seat, with your feet on the floor.**

## ⌘ Active Head Restraints

In order for the active head restraints to operate properly:

- Do not hang any items on the head restraints, or from the restraint legs.
- Do not place any objects between an occupant and the seat-back.
- Install each restraint in its proper location.

After a collision, the activated restraint should return to its normal position. If the restraint does not return to its normal position, or in the event of a severe collision, have the vehicle inspected by a dealer.

## Rear Seats

### Folding Down the Rear Seats

Separately fold down the left and right halves of the rear seat to make room for cargo.

#### To fold down the seat

1. Lower the rear head restraint to its lowest position. Put the armrest back into the seat-back.

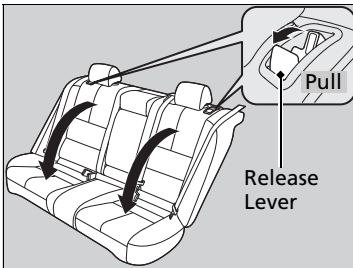

**From the rear door side**

2. Pull the release lever.

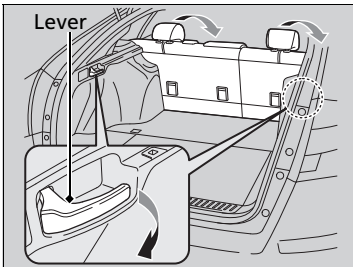

**From the cargo area side**

2. Pull the release lever.

If the rear head restraints get caught on the front seat-backs, remove the head restraints.

- ▶ **Removing and Reinstalling the Head Restraints** P. 137

### Folding Down the Rear Seats

Remove any items from the rear seat cushion before you fold down the rear seat.

When you fold down one side of the rear seats and use the non-recessed part of the cargo area, make sure to secure the cargo. Loose items can fly forward and cause injury if you have to brake hard.

**Make sure all items in the cargo area or items extending to the rear seats are properly secured. Loose items can fly forward if you have to brake hard.**

Make sure that the folded seat-back does not press against the front passenger seat, as this can cause the weight sensors in the front passenger seat to work improperly.

- ▶ **Passenger Airbag Off Indicator** P. 51

The front seat(s) must be far enough forward so they do not interfere with the rear seats as they fold down.

■ **To return the seat to the original position**

Pull up the seat-back in the upright position.

☒ **To return the seat to the original position**

Make sure the seat is latched before driving.

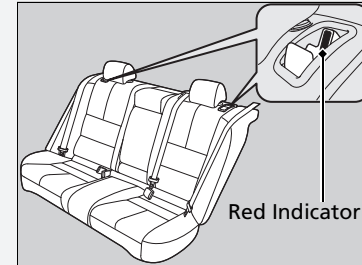

You see the red indicator behind the release lever when the seat-back is latched fully.

To lock the seat-back upright, push it backwards until it locks.

When returning a seat-back to its original position, push it firmly back. Also, make sure all rear shoulder belts are positioned in front of the seat-back, and the center shoulder belt is positioned in the guide.

## Armrest

### ■ Using the Front Seat Armrest

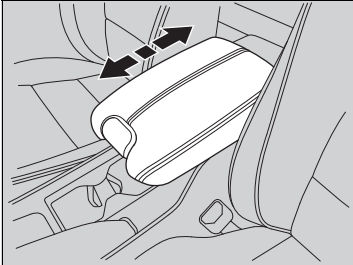

The console lid can be used as an armrest.  
Slide the armrest to one of its three positions.

### ■ Using the Rear Seat Armrest

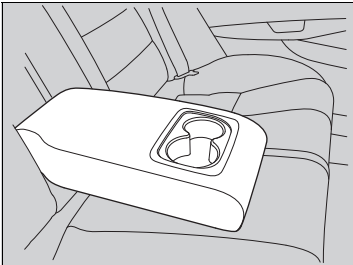

Pull down the armrest in the center seat-back.

## Interior Lights

### Interior Light Switches

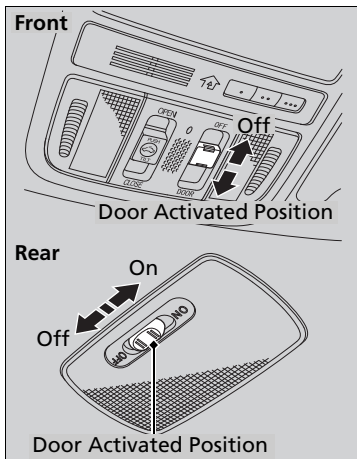

#### ■ ON

The interior lights come on regardless of whether the doors are open or closed.

#### ■ Door activated

The interior lights come on in the following situations:

- When any of the doors are opened.
- You unlock the driver's door.

#### Models without smart entry system

- You remove the key from the ignition switch.

#### Models with smart entry system

- When the power mode is set to VEHICLE OFF (LOCK).

Only the cargo area light comes on when the tailgate is opened.

#### ■ OFF

The interior lights remain off regardless of whether the doors are open or closed.

### Interior Light Switches

In the door activated position, the interior lights fade out and go off about 30 seconds after the doors are closed.

The lights go off after 30 seconds in the following situations:

- When you unlock the driver's door but do not open it.

#### Models without smart entry system

- When you remove the key from the ignition switch but do not open a door.

#### Models with smart entry system

- When you set the power mode to VEHICLE OFF (LOCK) but do not open a door.

You can change the interior lights dimming time.

#### Customized Features\* P. 281

The interior lights go off immediately in the following situations:

- When you lock the driver's door.
- When you turn the ignition switch to ON **II**\*1.

#### Models without smart entry system

- When you close the driver's door with the key in the ignition switch.

#### Models with smart entry system

- When you close the driver's door in ACCESSORY mode.

If you leave any of the doors open in VEHICLE OFF (LOCK) mode, or without the key in the ignition switch, the interior lights go off after about 15 minutes.

\*1: Models with the smart entry system have an **ENGINE START/STOP** button instead of an ignition switch.



## Map Lights

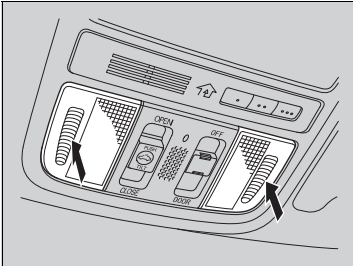

The map lights can be turned on and off by pressing the lenses.

## Cargo Area Lights

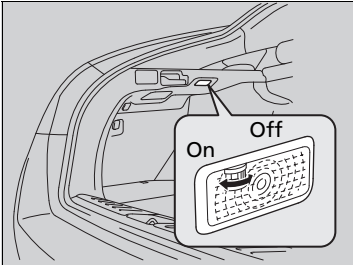

### ON

The light comes on when you open the tailgate, and goes off when closed.

### OFF

The light stays off with or without opening the tailgate.

### Map Lights

When the interior light switch is in the door activated position and any door is open, the map light will not go off when you press the lens.

## Interior Convenience Items

### ■ Glove Box

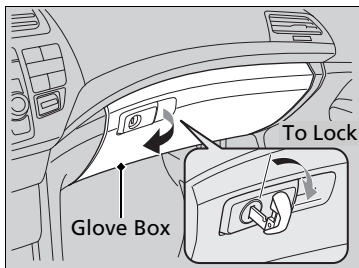

Pull the handle to open the glove box. You can lock the glove box with the master key or the built-in key.

### ☒ Glove Box

#### **⚠ WARNING**

An open glove box can cause serious injury to your passenger in a crash, even if the passenger is wearing the seat belt.

Always keep the glove box closed while driving.

## ■ Console Compartment

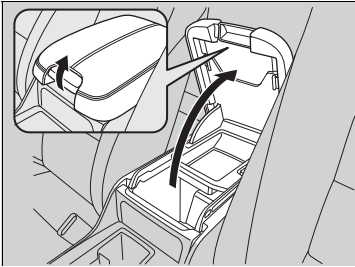

Pull the handle to open the console compartment.

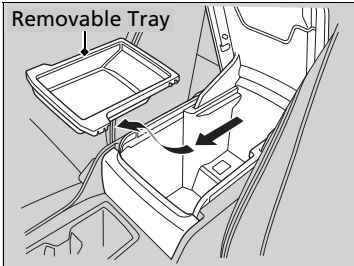

### ■ Removable tray

The tray in the console compartment is detachable.

To remove this tray, slide it forward, then pull it up.

## ■ Beverage Holders

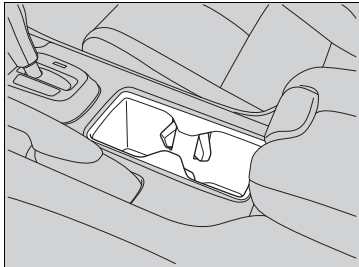

### ■ Front seat beverage holders

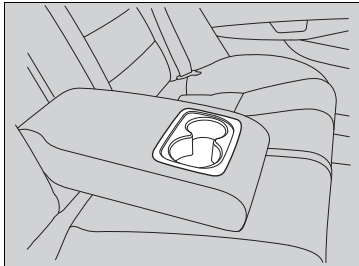

### ■ Rear seat beverage holders

Fold the armrest down to use the rear seat beverage holders.

## ☒ Beverage Holders

### NOTICE

Spilled liquids can damage the upholstery, carpeting, and electrical components in the interior.

Be careful when you are using the beverage holders. Hot liquid can scald you.

## ■ Accessory Power Sockets

The accessory power sockets can be used when the ignition switch is in ACCESSORY **I** or ON **II**\*1.

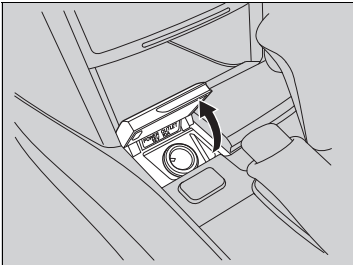

### ■ Accessory power socket (console panel)

Open the cover to use it.

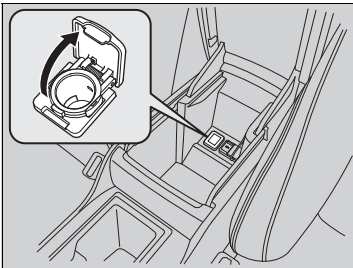

### ■ Accessory power socket (console compartment)

Open the console lid and the cover to use it.

\*1: Models with the smart entry system have an **ENGINE START/STOP** button instead of an ignition switch.

## ▣ Accessory Power Sockets

### NOTICE

Do not insert an automotive type cigarette lighter element.

This can overheat the power socket.

The accessory power socket is designed to supply power for 12 volt DC accessories that are rated 120 watts or less (10 amps).

To prevent battery drain, only use the power socket with the engine running.

When each socket is being used simultaneously, the combined power rating of the accessories should not exceed 120 watts (10 amps).

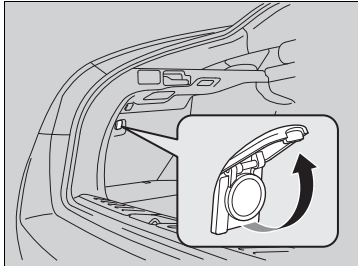

■ **Accessory power socket (cargo area)**

Open the cover to use it.

■ **Coat Hook**

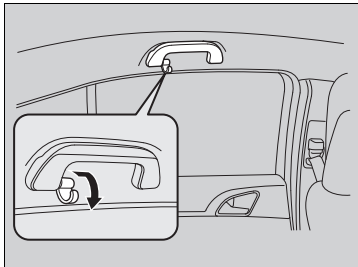

There is a coat hook on the rear left grab handle. Pull it down to use it.

☒ **Coat Hook**

The coat hook is not designed for large or heavy items.

## ■ Cargo Hooks

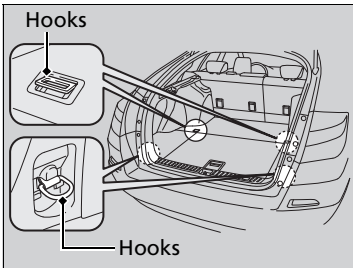

Use floor cargo hooks to secure luggage in the cargo area.

There are also hooks on both sides of the cargo area.

### ☒ Cargo Hooks

Each hook is designed to hold up to 56.2 lbs (25.5 kg) of weight.

## ■ Under-floor Storage Area

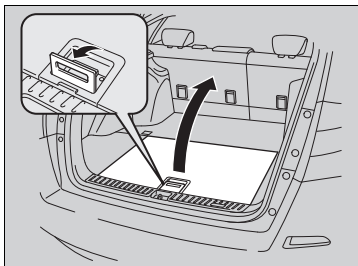

Pull the handle to open the cargo floor lid. The reverse side of the cargo floor lid is water-proofed. Flip the lid to use the water-proofed side.

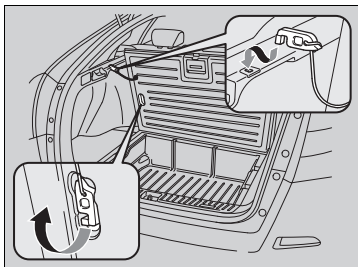

### ■ To keep the lid open:

1. Remove the hook from the back of the cargo floor lid.
2. Pull the hook to the hole on the side panel.

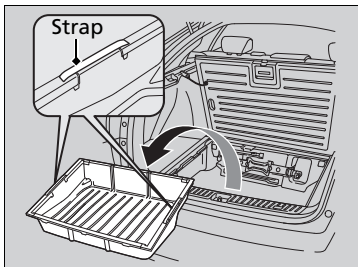

### ■ Removable box

The removable box is under the cargo floor.

To remove the box, lift it up with the straps on both sides.

## » Under-floor Storage Area

### NOTICE

Do not put objects that weigh more than 22.1 lbs (10 kg) in the removable box. Exceeding the maximum load may damage the box.

Do not leave water, soil, sand, or perishable foods in the removable box. Rotting food and dirt on the floor may cause the breakdown of electrical equipment.



## ■ Side Storage Compartments

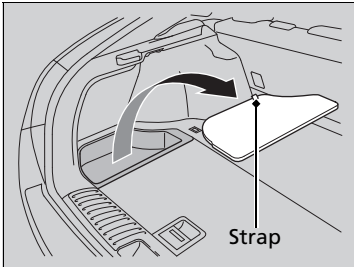

Pull the strap to raise the lid.

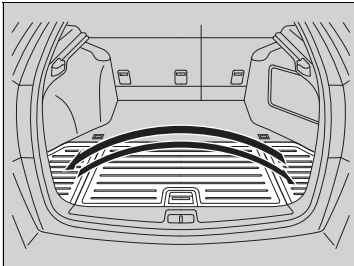

The reverse side of each lid is water-proofed.  
Flip the lids, then replace each other side.

### ■ Sunglasses Holder

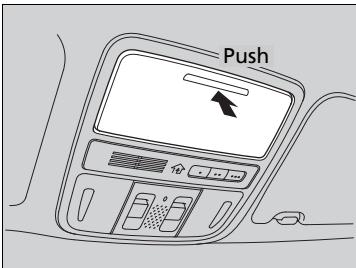

To open the sunglasses holder, push and release the indent. To close, push it again until it latches.

You can store eyeglasses and other small items in this holder.

### ■ Center Pocket(s) \*

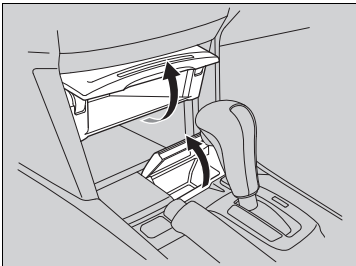

Pull the lid to open the pocket.

### ►► Sunglasses Holder

Keep the holder closed while driving except when accessing stored items.

## Seat Heaters\*



The ignition switch must be in ON **II**\*1 to use the seat heaters. The **HI** setting heats the seats faster than the **LO** setting.

There is no heater in the passenger's seat-back due to the side airbag cutoff system.

While in **HI**, the heater cycles on and off.

- The appropriate indicator will be on while the seat heater is on. Briefly press the switch on the opposite side to turn the heater off. The indicator will be off. When a comfortable temperature is reached, select **LO** to keep the seat warm.



\*1: Models with the smart entry system have an **ENGINE START/STOP** button instead of an ignition switch.

\* Not available on all models

## Seat Heaters\*

### ⚠ WARNING

Heat induced burns are possible when using seat heaters.

Persons with a diminished ability to sense temperature (e.g., persons with diabetes, lower-limb nerve damage, or paralysis) or with sensitive skin should not use seat heaters.

Do not use the seat heaters even in **LO** when the engine is off. Under such conditions, the battery may be weakened, making the engine difficult to start.

In the **LO** setting, the heater runs continuously and does not automatically turn off.

## Using Vents, Heating and A/C

### Mode Buttons

Change airflow.

Floor and defroster vents

Floor vents

Dashboard, floor and back of the center console vents

Dashboard and back of the center console vents

### MAX A/C Button

Turns on the A/C, selects airflow from the dashboard and back of the center console vents, and switches the mode to recirculation.

### Fan Control Dial

Adjusts the fan speed. Rotate the dial all the way to **OFF** to turn everything off.

### (Recirculation) Button

Press the  button and switch the mode depending on environmental conditions.

Recirculation Mode (indicator on):

Recirculates air from the vehicle's interior through the system.

Fresh Air Mode (indicator off):

Maintains outside ventilation. Keep the system in fresh air mode in normal situations.

### Windshield Defroster Button

Turns on the A/C, selects airflow from the defroster vents at the base of the windshield, and switches the mode to fresh air.

### Temperature Control Dial

Adjusts the interior temperature.

### A/C Button

Press to cool the interior or dehumidify while heating.

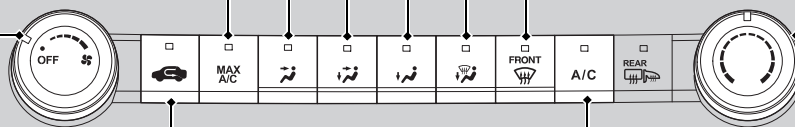

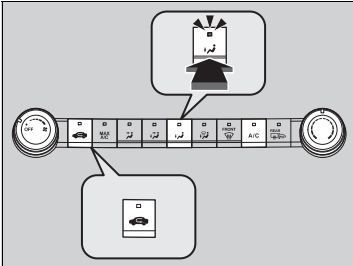

## ■ Heating



The heater uses heat from the engine coolant to warm the air.

1. Adjust the fan speed using the fan control dial.
2. Select .
3. Adjust the temperature using the temperature control dial.

### ■ To rapidly warm up the interior

1. Set the fan to the maximum speed.
2. Select .
3. Set the temperature to maximum warm.
4. Press the  button (the indicator on).

### ■ To dehumidify the interior

When used in combination with the heater, the air conditioning system makes the interior warm and dry and can prevent the windows from fogging up.

1. Adjust the fan speed using the fan control dial.
2. Press the **A/C** button to turn on the air conditioning.
3. Select .
4. Adjust the temperature using the temperature control dial.

## ►► Heating

When you select , the mode automatically switches to fresh air.

## ►► To rapidly warm up the interior

Change to fresh air mode as soon as the interior gets warm enough. The windows may fog up if kept in recirculation mode.

## ■ Cooling

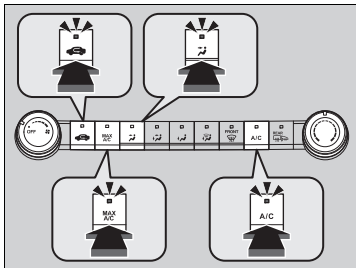



1. Adjust the fan speed using the fan control dial.
2. Select .
3. Adjust the temperature using the temperature control dial.
4. Press the **A/C** button (the indicator on).

### ■ To rapidly cool down the interior

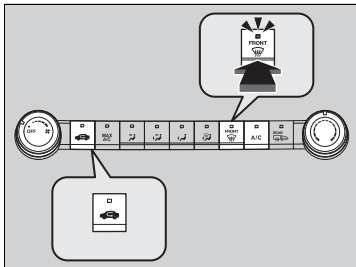

1. Set the fan to the maximum speed.
2. Set the temperature to maximum cool.
3. Press the  button (the indicator on).

## ■ Defrosting the Windshield and Windows



Pressing the  button turns the air conditioning system on and automatically switches the system to fresh air mode.

### ■ To rapidly defrost the windows

1. Set the fan to the maximum speed.
2. Press the  button.
3. Press the  button (the indicator on).
4. Set the temperature to maximum heat.

### ▶▶ To rapidly cool down the interior

If the interior is very warm, you can cool it down more rapidly by partially opening the windows.

### ▶▶ Defrosting the Windshield and Windows

**For your safety, make sure you have a clear view through all the windows before driving.**

Do not set the temperature near the upper or lower limit.

When cold air hits the windshield, the outside of the windshield may fog up.

If the side windows fog up, adjust the vents so that the air hits the side windows.

### ▶▶ To rapidly defrost the windows

After defrosting the windows, switch over to fresh air mode.

If you keep the system in recirculation mode, the windows may fog up from humidity. This impedes visibility.

## Using Automatic Climate Control

The automatic climate control system maintains the interior temperature you select. The system also selects the proper mix of heated or cooled air that will as quickly as possible, raise or lower the interior temperature to your preference.

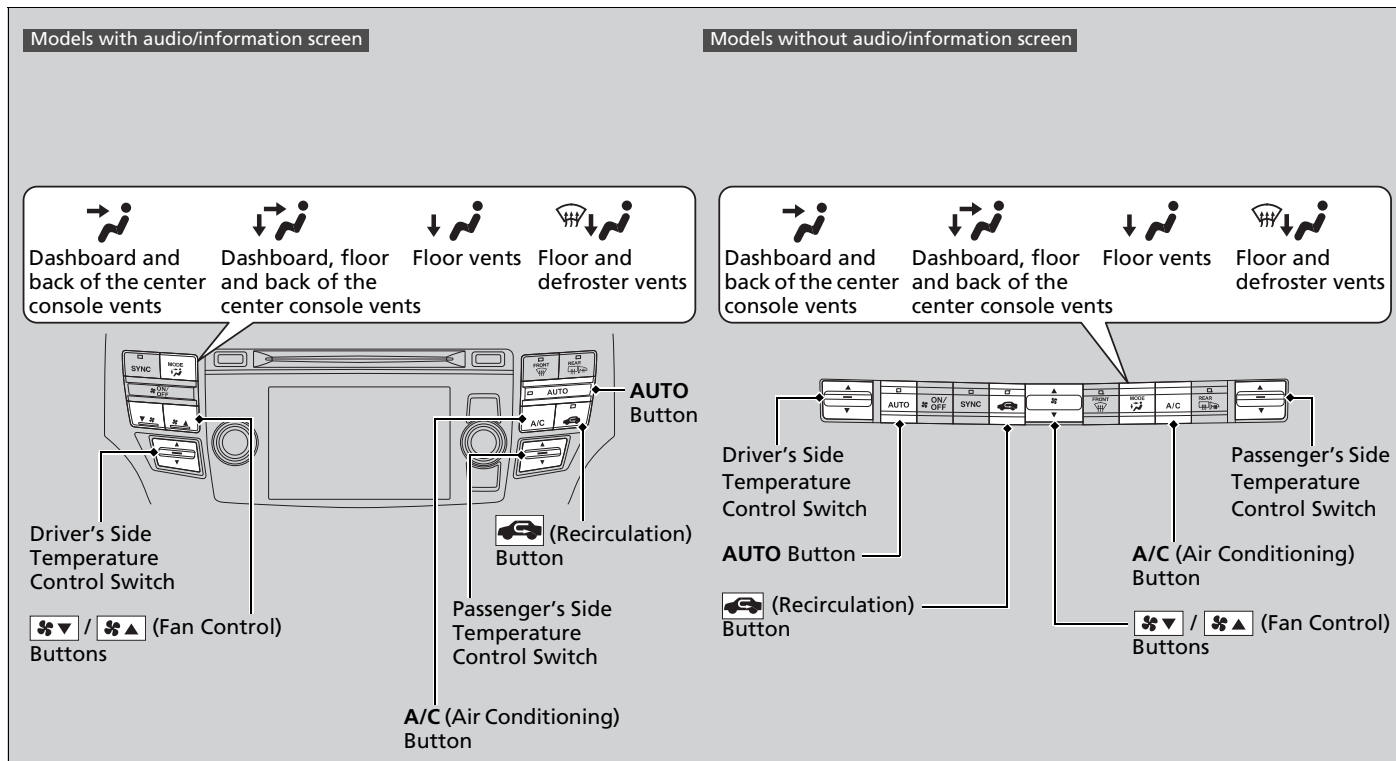

\* Not available on all models

Use the system when the engine is running.

1. Press the **AUTO** button.
2. Adjust the interior temperature using the driver's side or passenger's side control switch.
3. Press the  (On/Off) button to cancel.

### ■ Switching between the recirculation and fresh air modes

Press the  (recirculation) button and switch the mode depending on environmental conditions.

Recirculation Mode (indicator on): Recirculates air from the vehicle's interior through the system.

Fresh Air Mode (indicator off): Maintains outside ventilation. Keep the system in fresh air mode in normal situations.

### ▶▶ Using Automatic Climate Control

If any buttons are pressed while using the climate control system in auto, the function of the button that was pressed will take priority.

The **AUTO** indicator will go off, but functions unrelated to the button that was pressed will be controlled automatically.

To prevent cold air from blowing in from outside, the fan may not start immediately when the **AUTO** button is pressed.

If the interior is very warm, you can cool it down more rapidly by partially opening the windows, turning the system on auto, and setting the temperature to low. Change the fresh mode to recirculation mode until the temperature cools down.

When you set the temperature to the lower or upper limit, **Lo** or **Hi** is displayed.

Pressing the  button switches the climate control system between on and off. When turned on, the system returns to your last selection.



## Defrosting the Windshield and Windows

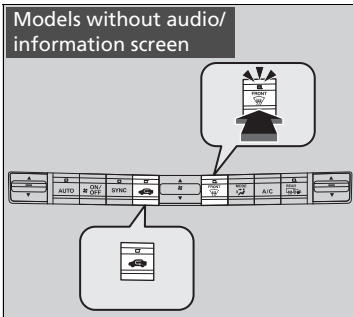

Pressing the  button turns the air conditioning system on and automatically switches the system to fresh air mode.

Pressing the  button again to turn off, the system returns to the previous settings.

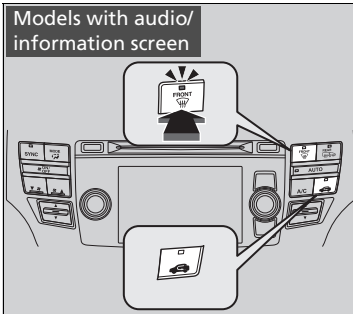

## Defrosting the Windshield and Windows

**For your safety, make sure you have a clear view through all the windows before driving.**

Do not set the temperature near the upper or lower limit.

When cold air hits the windshield, the outside of the windshield may fog up.

If the side windows fog up, adjust the vents so that the air hits the side windows.

■ To rapidly defrost the windows

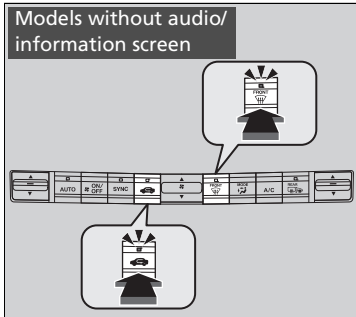

1. Press the  button.
2. Press the  button.

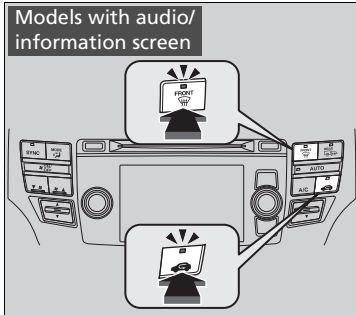

►► To rapidly defrost the windows

After defrosting the windows, switch over to fresh air mode. If you keep the system in recirculation mode, the windows may fog up from humidity. This impedes visibility.

## Synchronized Mode

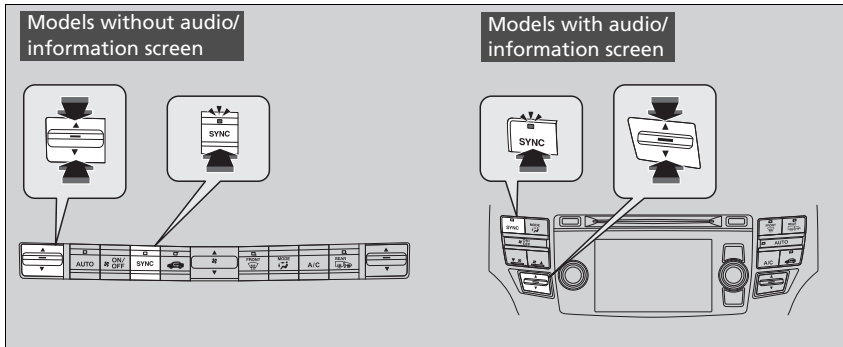

You can set the temperature synchronously for the driver side and the passenger side in synchronized mode.

1. Press the **SYNC** button.  
▶ The system will switch to synchronized mode.
2. Adjust the temperature using driver's side temperature control switch.

Press the **SYNC** button to return to dual mode.

### ▶ Synchronized Mode

When you press the  button, the system changes to synchronized mode.

When the system is in dual mode, the driver side temperature and the passenger side temperature can be set separately.

### ▶ Models with navigation system

The system adjusts each temperature based on the information of the sunlight sensor and the sun position updated by the navigation system's GPS.

## Automatic Climate Control Sensors

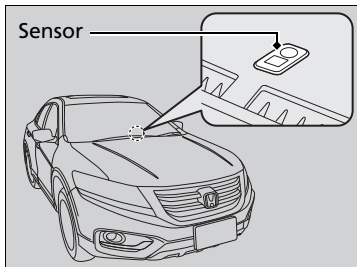

The automatic climate control system is equipped with sensors. Do not cover or spill any liquid on them.

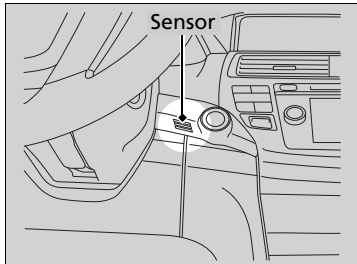

# Features

This chapter describes how to operate technology features.

<b>Audio System</b>	
About Your Audio System.....	164
USB Adapter Cable .....	165
Auxiliary Input Jack .....	165
Audio System Theft Protection .....	166
Region Setting* .....	167
Audio Remote Controls.....	168
<b>Models without navigation system</b>	
<b>Audio system without touch screen</b>	
<b>Audio System Basic Operation</b> .....	169
<b>Audio system with touch screen</b>	
<b>Audio System Basic Operation</b> .....	182
<b>Models with navigation system</b>	
<b>Audio System Basic Operation</b> .....	215
<b>Audio Error Messages</b> .....	268
<b>General Information on the Audio System</b> .....	276
<b>Customized Features*</b> .....	281
<b>HomeLink® Universal Transceiver*</b> ..	318
<b>Bluetooth® HandsFreeLink®</b> ....	320, 332, 367
<b>Compass*</b> .....	405, 407

\* Not available on all models

## About Your Audio System

### Audio system without touch screen

The audio system features AM/FM radio. It can also play audio CDs, WMA/MP3/AAC files, iPod®, and USB flash drives.

You can operate the audio system from the buttons and switches on the panel, or the remote controls on the steering wheel.

### Audio system with touch screen

The audio system features AM/FM radio and the XM® Radio service\*. It can also play audio CDs, WMA/MP3/AAC files, Hard Disc Drive (HDD) audio\*, USB flash drives, and iPod®, iPhone® and *Bluetooth*® devices.

You can operate the audio system from the buttons and switches on the panel, the icons on the touchscreen interface, or the remote controls on the steering wheel.

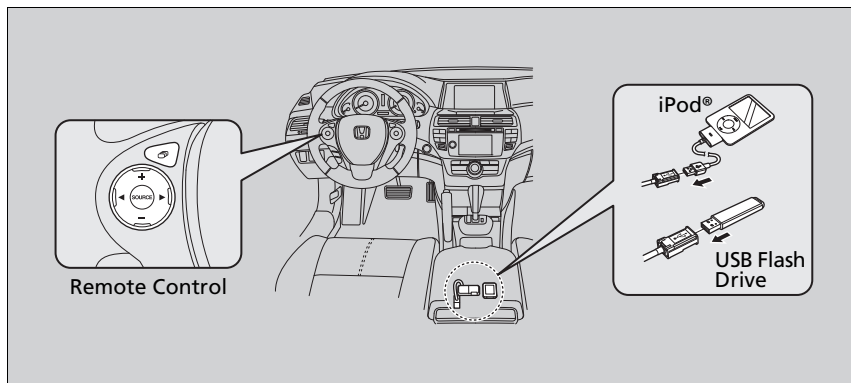

### Models with navigation system

See the Navigation System Manual for information on the navigation system.

### About Your Audio System

XM® Radio is available on a subscription basis only. For more information on XM® Radio, contact a dealer.

#### General Information on the Audio System P. 276

XM® Radio is available in the United States and Canada, except Hawaii, Alaska, and Puerto Rico.

XM® is a registered trademark of Sirius XM Radio, Inc.

Video CDs, DVDs, and 3-inch (8-cm) mini CDs are not supported.

iPod® and iPhone® are registered trademarks owned by Apple Inc.

State or local laws may prohibit the operation of handheld electronic devices while operating a vehicle.

## USB Adapter Cable

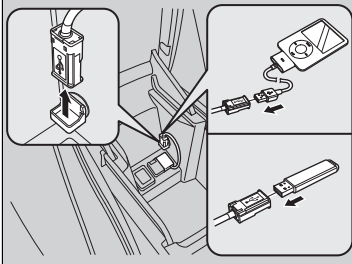

1. Unclip the USB connector and loosen the adapter cable.
2. Install the iPod® dock connector or the USB flash drive to the USB connector.

## Auxiliary Input Jack

Use the jack to connect standard audio devices.

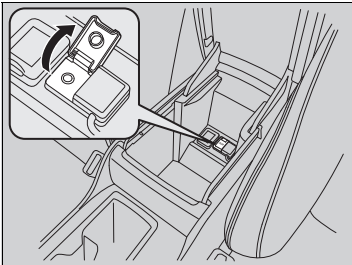

1. Open the AUX cover.
2. Connect a standard audio device to the input jack using a 1/8 inch (3.5 mm) stereo miniplug.
  - ▶ The audio system automatically switches to the AUX mode.

### USB Adapter Cable

- Do not leave the iPod® or USB flash drive in the vehicle. Direct sunlight and high temperatures may damage it.
- Do not use an extension cable with the USB adapter cable.
- Do not connect the iPod® or USB flash drive using a hub.
- Do not use a device such as a card reader or hard disk drive, as the device or your files may be damaged.
- We recommend backing up your data before using the device in your vehicle.
- Displayed messages may vary depending on the device model and software version.

If the audio system does not recognize the iPod®, try reconnecting it a few times or reboot the device. To reboot, follow the manufacturer's instructions provided with the iPod® or visit [www.apple.com/ipod](http://www.apple.com/ipod).

### Auxiliary Input Jack

#### Audio system without touch screen

To switch the mode, press any of the audio mode buttons. You can return to the AUX mode by pressing the **AUX** button.

#### Audio system with touch screen

You can return to the AUX mode by selecting **Change Source** on the **Audio menu** screen or **Source** on the touch screen.

You cannot use the auxiliary input jack if you replace the audio system.

## Audio System Theft Protection

The audio system is disabled when it is disconnected from the power source, such as when the battery is disconnected or goes dead.

### ■ Reactivating the audio system

#### Audio system without touch screen

1. Turn the ignition switch to ON **II**, and turn on the audio system.
  - ▶ If you turn the ignition switch to ACCESSORY **I**, you will be requested to enter the audio security code.
2. Enter the audio security code using the preset buttons.

#### Audio system with touch screen

1. Turn the ignition switch to ON **II**\*1, and turn on the audio system.
  - ▶ If you turn the ignition switch to ACCESSORY **I**\*1, you will be requested to enter the audio security code. See step 3.
2. Press and hold the **VOL**/ (power/volume) button again for more than two seconds.
  - ▶ The audio system is reactivated when the system's control unit recognizes that the system is in your vehicle.  
If the control unit fails to recognize, **Enter code/Enter PIN Code** appears on the audio/information screen.
3. Enter the audio security code using the touch screen.

#### All models

If you enter an incorrect digit, continue to the last digit, then try again. If you do not enter the code correctly after 10 tries, leave the system for one hour before trying again, or visit a dealer to have the system reset.

\*1: Models with the smart entry system have an **ENGINE START/STOP** button instead of an ignition switch.

#### ▶▶ Audio System Theft Protection

Find the audio system's security code and serial number label in your owner's manual kit.

We recommend that you write down the serial number in this owner's manual.

Do not store the label in your vehicle. If you lose the label, you must first retrieve the serial number, and then obtain the code.

You can find out about your serial number and security code from a dealer.

#### U.S. models





You can register the security code at Honda Owners ([owners.honda.com](http://owners.honda.com)), and find information on how to retrieve the serial number and obtain the code at [radio-navicode.honda.com](http://radio-navicode.honda.com).



## Region Setting\*

The audio system's region setting will be lost when the battery is disconnected or goes dead.

If the **Region Select** screen appears, you need to set the region for the audio system. Follow the steps below:

1. Press  to select **OK**.
2. Rotate  to select the region you live in, then press .
3. You will receive a confirmation message on the screen. Rotate  to select **Yes**, then press .

### Region Setting\*

The region setting is required only when the battery power is temporarily disconnected. It is set to your vehicle's region type by the factory.

You cannot change the setting once you have completed the setting procedure. Contact a dealer if you selected an incorrect region.

These indications are used to show how to operate the **MENU/SEL** (Selector) knob or the interface dial. Rotate  to select.

Press  to enter.

## Audio Remote Controls

Allows you to operate the audio system while driving.

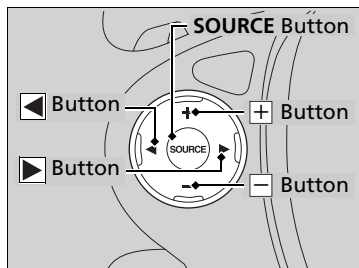

### SOURCE Button











Cycles through the audio modes as follows:  
 FM → AM → XM\* → CD → HDD\* → USB →  
 iPod® → Bluetooth® Audio\* → Pandora®\* →  
 Aha™ → AUX

### + - (Volume) Buttons

**Press** : Increases the volume.

**Press** : Decreases the volume.

### ◀ ▶ Buttons

- When listening to the radio
  - Press** : Selects the next preset radio station.
  - Press** : Selects the previous preset radio station.
  - Press and hold** : Selects the next strong station.
  - Press and hold** : Selects the previous strong station.
- When listening to a CD, HDD\*, iPod®, USB flash drive, or Bluetooth® Audio\*
  - Press** : Skips to the next song.
  - Press** : Goes back to the beginning of the current or previous song.
- When listening to a CD, HDD\* or USB flash drive
  - Press and hold** : Skips to the next folder.
  - Press and hold** : Goes back to the previous folder.
- When listening to Pandora®\*
  - Press** : Skips to the next song.
  - Press and hold** : Selects the next station.
  - Press and hold** : Selects the previous station.

### ▶▶ Audio Remote Controls

The CD mode appears only when a CD is loaded.

#### Audio system without touch screen

When in the AUX mode, the following is operable from the remote controls:

- iPod®/USB flash drive connected to the USB adapter cable

# Audio System Basic Operation

## Audio system without touch screen

To use the audio system function, the ignition switch must be in ACCESSORY **I** or ON **II**.

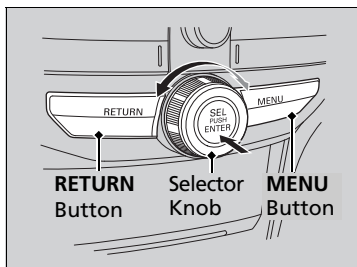

Use the selector knob or **MENU** button to access some audio functions.

Press to switch between the normal and extended display for some functions. The extended display has three segments to display detailed information.

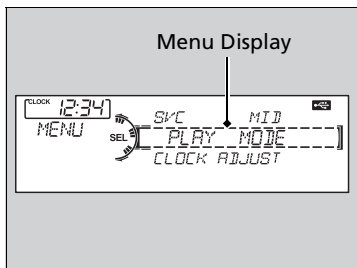

**Selector knob:** Rotate left or right to scroll through the available choices. Press to set your selection.

**MENU button:** Press to select any setting such as the clock, sound control, or the compass\*. Press this button again to cancel the menu display mode.

**RETURN button:** Press to go back to the previous display.

## Audio System Basic Operation

These indications are used to show how to operate the selector knob.

Rotate to select.

Press to enter.

Press the **SOURCE**, , , or button on the steering wheel to change any audio setting.

**Audio Remote Controls** P. 168

\* Not available on all models

# Adjusting the Sound

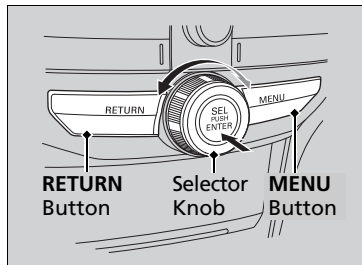

Press the **MENU** button, and rotate to adjust the setting, then press . Rotate to scroll through the following choices:

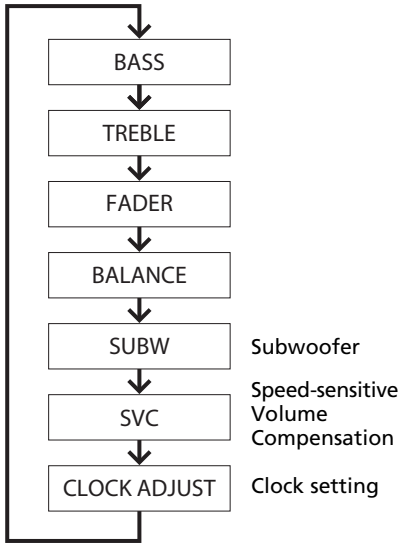

## Adjusting the Sound

When the adjustment level reaches the center, you will see **C** in the display.

The SVC has four modes: **OFF**, **LOW**, **MID**, and **HIGH**.

SVC adjusts the volume level based on the vehicle speed. As you go faster, audio volume increases. As you slow down, audio volume decreases.

Features

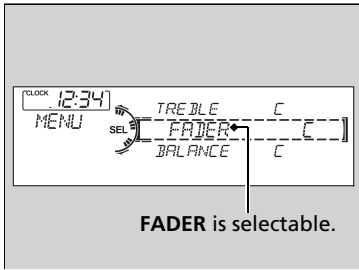

## Playing the AM/FM Radio

### VOL/ (Volume/Power) Knob

Press to turn the audio system on and off.

Turn to adjust the volume.

### AM Button

### FM Button

Press to select a band.

### SCAN Button

Press to sample each of the strongest stations on the selected band for 10 seconds.

To turn off scan, press the button again.

### FOLDER Bar

Press either side to display and select an RDS category.

### Selector Knob

Turn to tune the radio frequency.

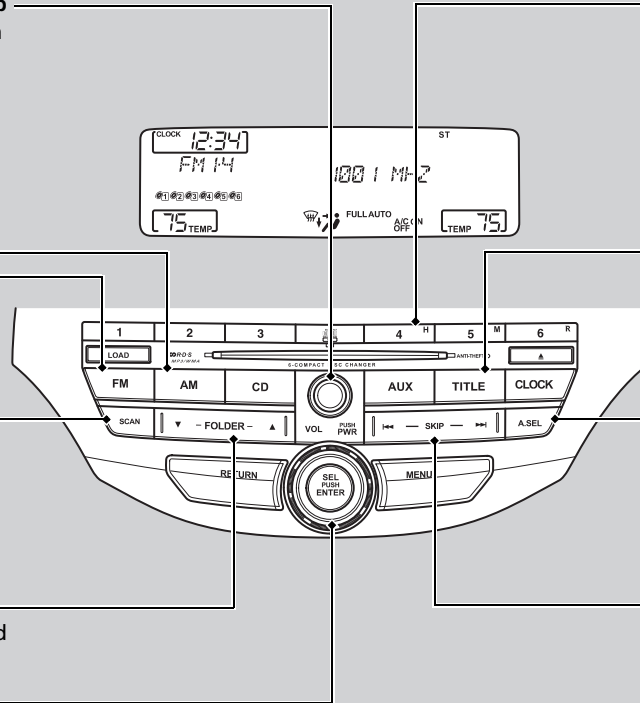

### Preset Buttons (1-6)

To store a station:

1. Tune to the selected station.
2. Pick a preset button and hold it until you hear a beep.

To listen to a stored station, select a band, then press the preset button.

### TITLE Button

Press to switch the RDS name on and off.

### A.SEL (Auto Select) Button

Press to scan both bands and store the strongest station in each preset.

To turn off auto select, press the button again. This restores the presets you originally set.

### SKIP Bar

Press and hold to search up and down the selected band for a station with a strong signal.

## ■ Radio Data System (RDS)

Provides text data information related to your selected RDS capable FM station.

### ■ RDS INFO ON

Press the **TITLE** button while listening to an RDS capable station. **RDS INFO ON** appears, and the station name is displayed.

### ■ To find an RDS station from your selected program category

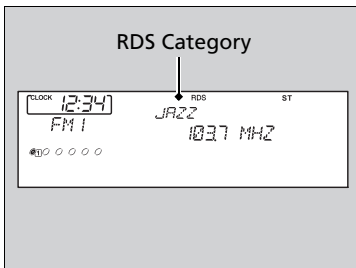

1. Press the **FOLDER** bar to display and select an RDS category.
2. Use **SKIP** or **SCAN** to select an RDS station.

## ▶▶ Playing the AM/FM Radio

The **ST** indicator appears on the display indicating stereo FM broadcasts. Stereo reproduction in AM is not available.

### Switching the Audio Mode

Press the **SOURCE** button on the steering wheel.

▶ **Audio Remote Controls** P. 168

You can store six AM stations and twelve FM stations into the preset button memory. FM1 and FM2 let you store six stations each.

Auto Select function scans and stores up to six AM stations and twelve FM stations with a strong signal into the preset button memory.

If you do not like the stations auto select has stored, you can manually store your preferred frequencies.

## Playing a CD

Your audio system supports audio CDs, CD-Rs and CD-RWs in either MP3 or WMA format. With the CD loaded, press the **CD** button.

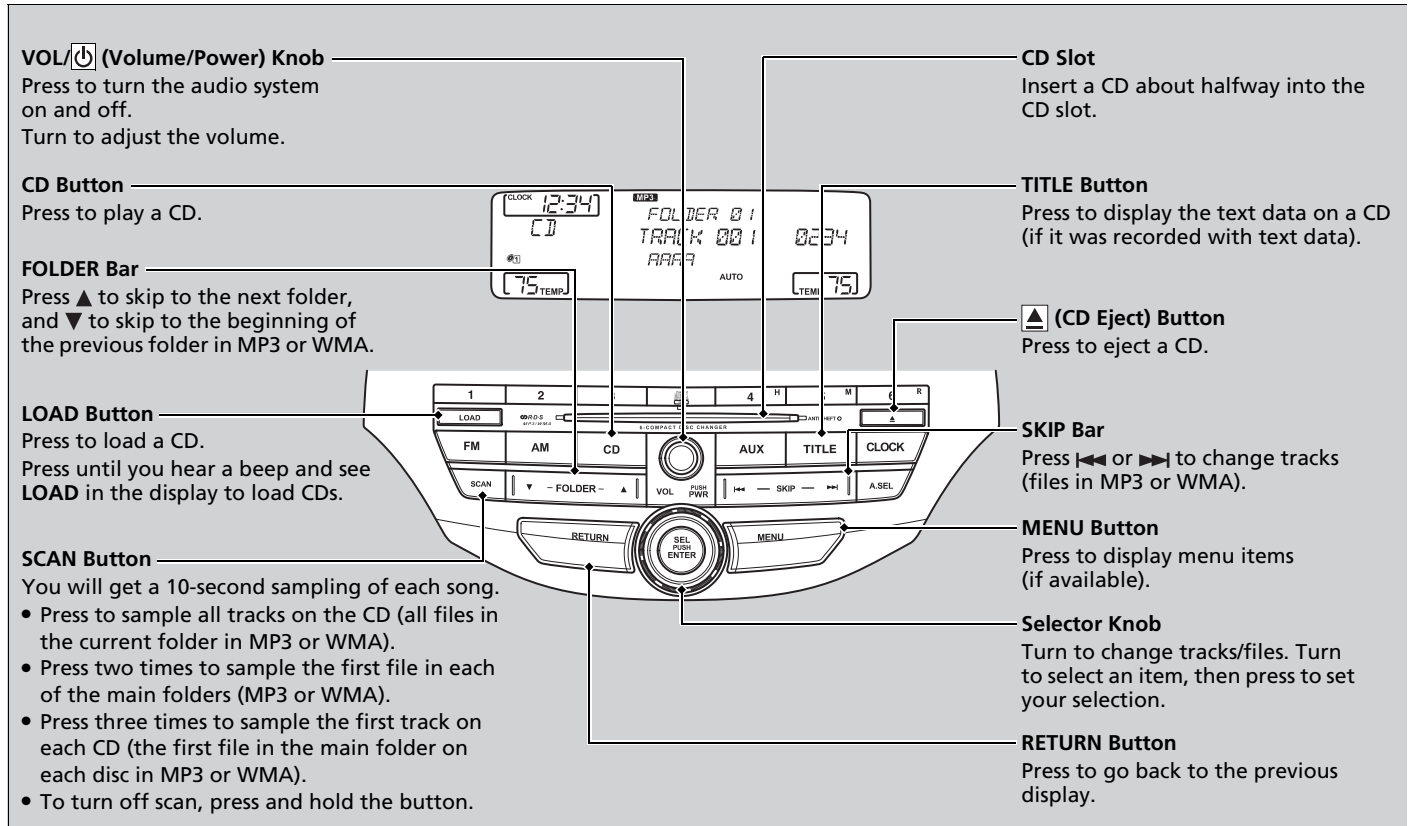

## How to Select a File from a Folder with the Selector Knob (MP3/WMA)

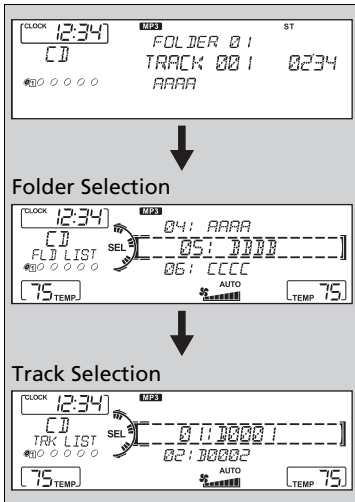

1. Press to switch the display to a folder list.
2. Rotate to select a folder.
3. Press to change the display to a list of files in that folder.
4. Rotate to select a file, then press .

## ▶▶ Playing a CD

### NOTICE

Do not use CDs with adhesive labels. The label can cause the CD to jam in the unit.

WMA files protected by digital rights management (DRM) cannot be played. The audio system displays **UNSUPPORTED**, then skips to the next file.

Text data appears on the display under the following circumstances:

- When you select a new folder, file, or track.
- When you change the audio mode to CD.
- When you insert a CD.

The display shows up to 31 characters of text data. Press and hold the **TITLE** button to see additional characters. ▷ indicates that the text data continues. The display goes back to the previous screen if you press and hold the button again.

If you eject the CD but do not remove it from the slot, the system reloads the CD automatically after several seconds.



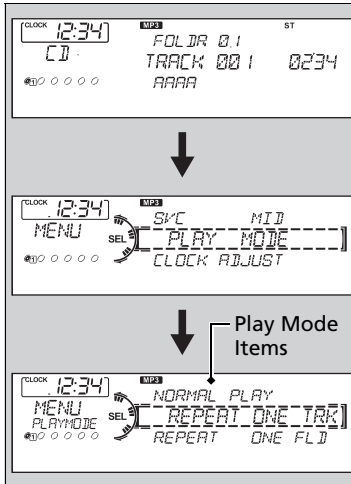

## How to Select a Play Mode

You can select repeat, random, and scan modes when playing a track or files.



1. Press the **MENU** button.

2. Rotate  to select **PLAY MODE**, then press .

3. Rotate  to select a mode, then press .

## To turn off a play mode

1. Press the **MENU** button.

2. Rotate  to select **PLAY MODE**, then press .

3. Rotate  to select **NORMAL PLAY**, then press .

## How to Select a Play Mode

Press the **RETURN** button to go back to the previous display, and press the **MENU** button to cancel this setting mode.

Play Mode Menu Items

### **NORMAL PLAY**

**REPEAT ONE TRACK:** Repeats the current track/file.

**REPEAT ONE FLD (MP3/WMA):** Repeats all files in the current folder.

**REPEAT DISC:** Repeats the current CD.

**RANDOM IN FLD (MP3/WMA):** Plays all files in the current folder in random order.

**RANDOM IN DISC:** Plays all tracks/files in the current CD in random order.

**SCAN TRK (MP3/WMA):** Samples all tracks on the CD. Samples all files in the current folder.

**SCAN FLD (MP3/WMA):** Samples the first file in each folder on the CD.

**SCAN DISC:** Samples the first track/file on each CD.

## Playing an iPod®

Connect the iPod® using your dock connector to the USB adapter cable, then press the **AUX** button.

➔ **USB Adapter Cable** P. 165

### **VOL/⏻ (Volume/Power) Knob**

Press to turn the audio system on and off.

Turn to adjust the volume.

### **AUX Button**

Press to select iPod® (if connected).

### **TITLE Button**

Press to display the text data.

### **RETURN Button**

Press to go back to the previous display.

### **SKIP Bar**

Press ◀ or ▶ to change songs.

### **MENU Button**

Press to display menu items.

### **Selector Knob**

Turn to select a song, file, menu item, or play mode. Press to set your selection.

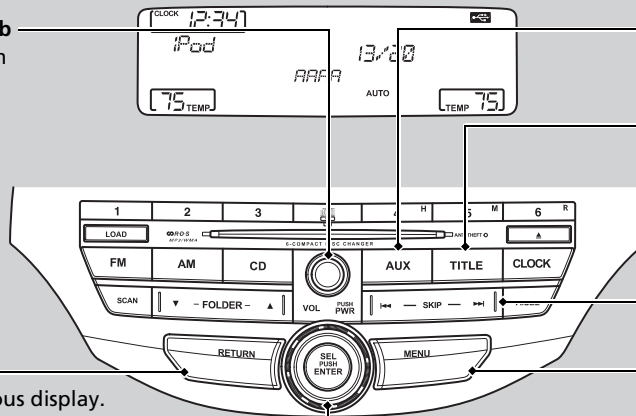

## How to Select a File from the iPod® Menu

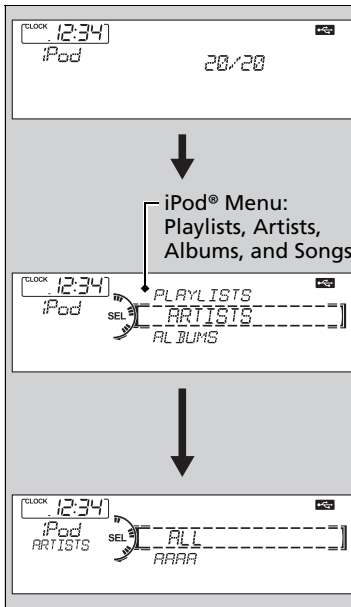

1. Press to display the iPod® menu.

2. Rotate to select a menu.

3. Press to display the items on that menu.

4. Rotate to select an item, then press .

### ▶▶ Playing an iPod®

Available operating functions vary on models or versions. Some functions may not be available on the vehicle's audio system.

If there is a problem, you may see an error message on the audio display.

iPod®/USB Flash Drive P. 271

## ■ How to Select a Play Mode

You can select repeat and shuffle modes when playing a file.

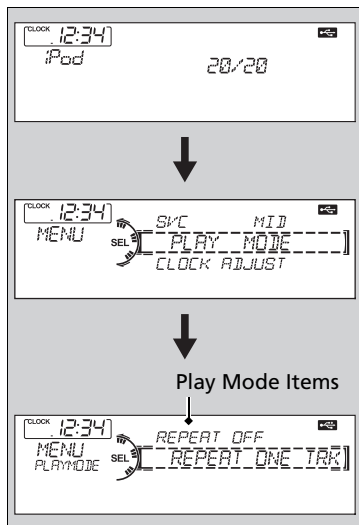

1. Press the **MENU** button.

2. Rotate to select **PLAY MODE**, then press .

3. Rotate to select a mode, then press .

### ■ To turn off a play mode

1. Press the **MENU** button.

2. Rotate to select **PLAY MODE**, then press .

3. Rotate to select **NORMAL PLAY**, then press .

## ▶▶ How to Select a Play Mode

Play Mode Menu Items

### **NORMAL PLAY**

**SHUFFLE OFF:** Turns off the shuffle mode.

**SHUFFLE ALL:** Plays all available files in a selected list (playlists, artists, albums or songs) in random order.

**SHUFFLE ALBUM:** Plays all available albums in a selected list (playlists, artists, albums, or songs) in random order.

**REPEAT OFF:** Turns off the repeat mode.

**REPEAT ONE TRACK:** Repeats the current track.

## Playing a USB Flash Drive

Your audio system reads and plays sound files on a USB flash drive in either MP3, WMA or AAC\*1 format.

Connect your USB flash drive to the USB adapter cable, then press the **AUX** button.

📌 **USB Adapter Cable** P. 165

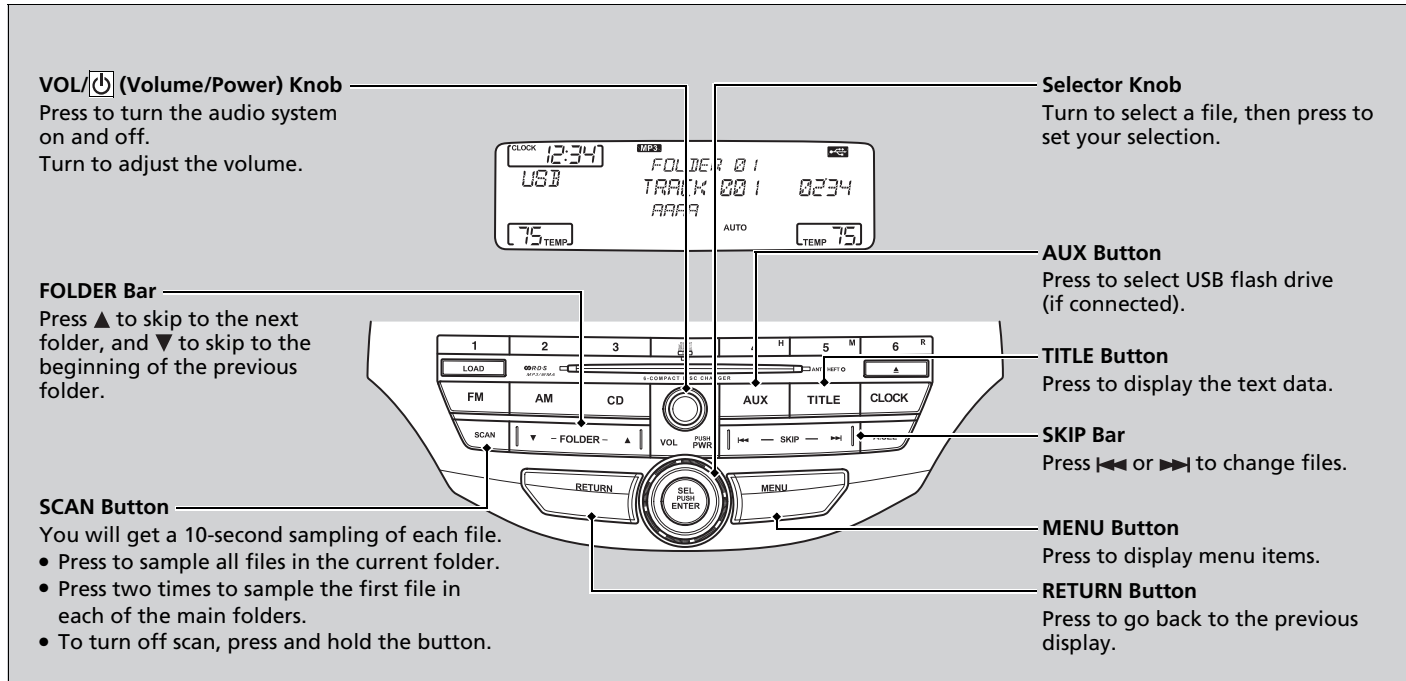

\*1: Only AAC format files recorded with iTunes® are playable on this audio unit.

## ■ How to Select a File from a Folder with the Selector Knob

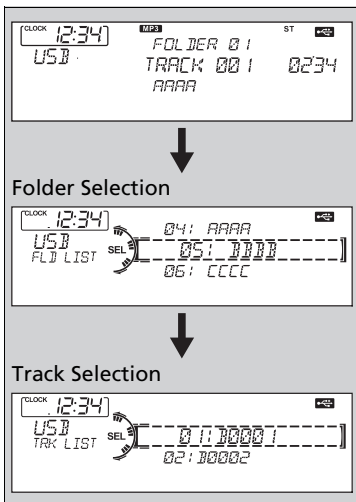

1. Press to switch the display to a folder list.
2. Rotate to select a folder.
3. Press to change the display to a list of files in that folder.
4. Rotate to select a file, then press .

## ▶▶ Playing a USB Flash Drive

Use the recommended USB flash drives.

**USB Flash Drives** P. 280

Files in WMA format protected by digital rights management (DRM) are not played.

The audio system displays **UNPLAYABLE FILE**, and then skips to the next file.

If there is a problem, you may see an error message on the audio display.

**iPod®/USB Flash Drive** P. 271

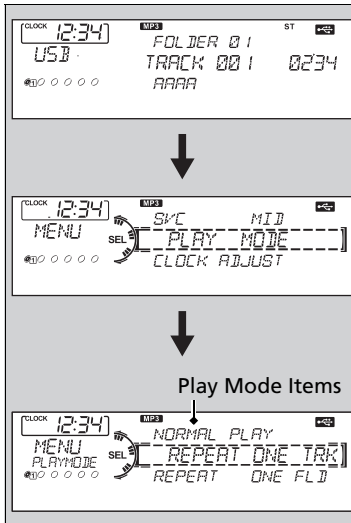

## How to Select a Play Mode

You can select repeat, random, and scan modes when playing a file.



1. Press the **MENU** button.

2. Rotate  to select **PLAY MODE**, then press .

3. Rotate  to select a mode, then press .

## To turn off a play mode

1. Press the **MENU** button.

2. Rotate  to select **PLAY MODE**, then press .

3. Rotate  to select **NORMAL PLAY**, then press .

## How to Select a Play Mode

Play Mode Menu Items

### **NORMAL PLAY**

**REPEAT ONE TRACK:** Repeats the current file.

**REPEAT ONE FLD:** Repeats all files in the current folder.



**RANDOM IN FLD:** Plays all files in the current folder in random order.

**RANDOM ALL:** Plays all files in random order.

**SCAN TRK:** Samples all files in the current folder.

**SCAN FLD:** Samples the first file in each folder.

## Models with two displays

To use the audio system function, the ignition switch must be in ACCESSORY  or ON \*1.

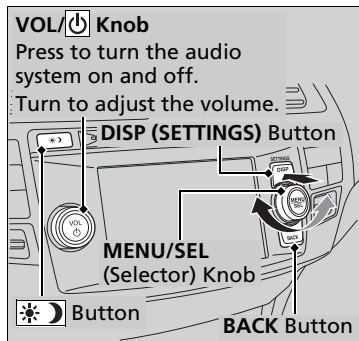

Use the selector knob, **DISP** and **BACK** buttons to access some audio functions.

Press  to switch between the normal and extended display for some functions.

**MENU/SEL (Selector) knob:** Rotate left or right to scroll through the available choices. Press to set your selection.

Also press to select any mode. The available mode includes **Change Source**, **Station List**, **Save Preset**, **Radio Text**, **Music Search**, and play modes. Play modes can be also selected from **Scan**, **Random/Repeat**, and so on.

**BACK button:** Press to go back to the previous display.

 **button:** Press to change the audio/information screen brightness.

Press  once and make an adjustment.

- ▶ Each time you press , the mode switches between the daytime mode, nighttime mode and **OFF** mode.

\*1: Models with the smart entry system have an **ENGINE START/STOP** button instead of an ignition switch.

## ▶▶ Audio System Basic Operation

These indications are used to show how to operate the **MENU/SEL** (Selector) knob.

Rotate  to select.

Press  to enter.

### Audio Menu Items

- ▶ **Station List** P. 195
- ▶ **Save Preset** P. 194, 199
- ▶ **Radio text** P. 196
- ▶ **Music Search** P. 201, 205, 211
- ▶ **Scan** P. 202, 212
- ▶ **Random/Repeat** P. 202, 206, 212



## Audio with Touch Screen

Use the touch screen to operate the audio system.

### Selecting an Audio Source

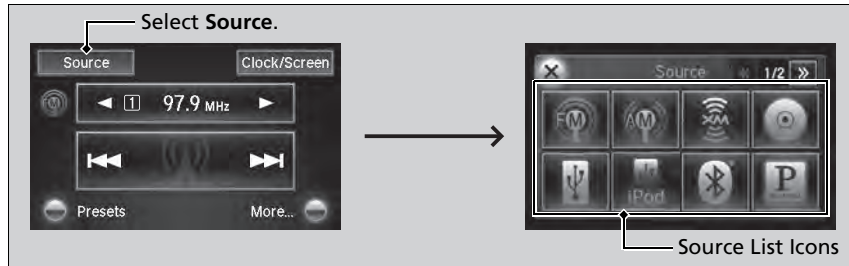

Select **Source**, then select an icon on the source list to switch the audio source.

### Displaying the Menu Items

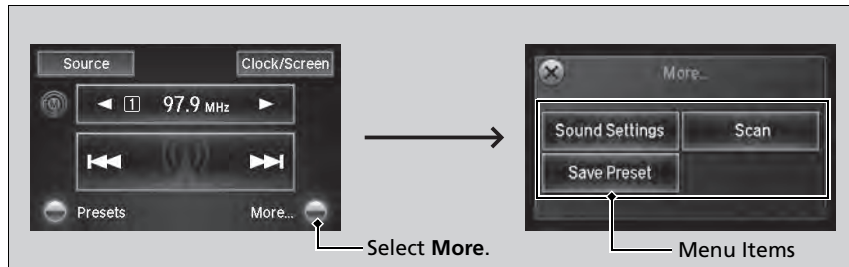

Select **More** to display the menu items.

### Audio with Touch Screen

Icons that appear on the screen vary by the source selected.

Select  to go back to the previous screen.

Use the     icons to turn the page.

## ■ Changing the Clock/Screen Settings

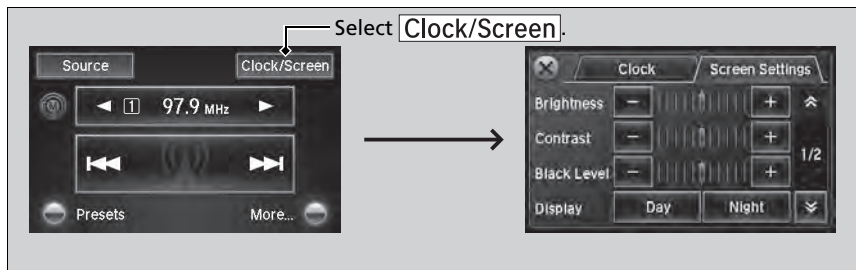

Select **Clock/Screen** to adjust the clock and screen settings.

### ■ Changing the Clock settings

➤ **Setting the Clock** P. 88

### ■ Changing the Screen settings

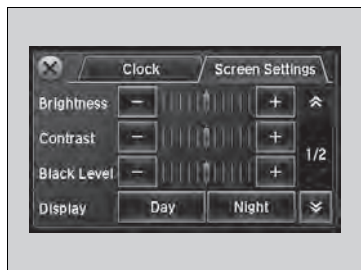

1. Select **Screen Settings**.
2. Use **+**, **-** or others to adjust the setting.

## ▶▶ Changing the Clock/Screen Settings

The followings are adjustable screen settings:

- **Brightness**
- **Contrast**
- **Black Level**
- **Display**  
Changes between the daytime or nighttime modes.
- **Beep**  
Mutes a beep that sounds every time you touch the screen.
- **Fade Timer**  
Sets the screen black out timing.

## Adjusting the Sound

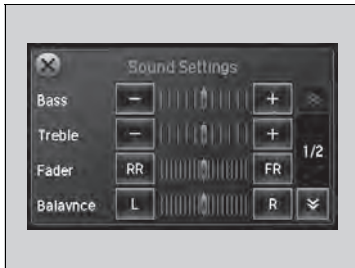

1. Select **More**, then **Sound Settings**.
2. Use  $\boxed{+}$ ,  $\boxed{-}$  or others to adjust the setting.

### ▶▶ Adjusting the Sound

Select **Off**, **Low**, **Mid** or **High** for the SVC setting.

▶▶ **Adjusting the Sound** P. 191

## Audio/Information Screen

Displays the audio status and wallpaper. From this screen, you can go to various setup options.

### Switching the Display

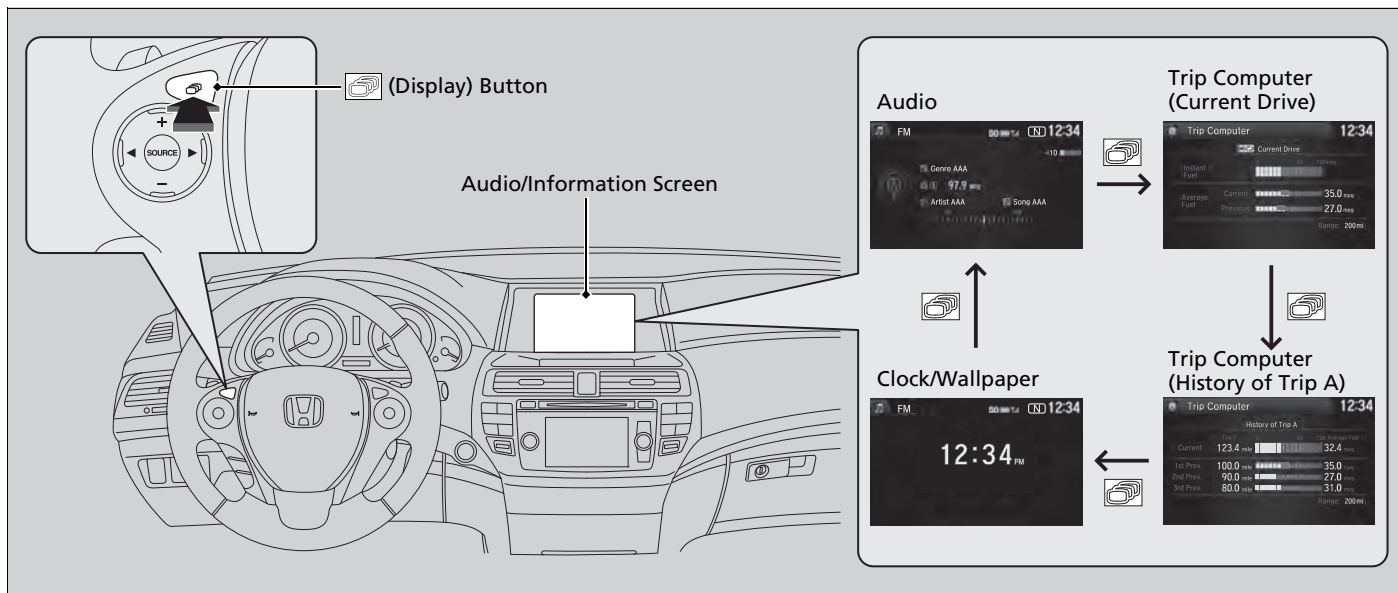

Using the  button

Press the  (display) button to change the display.

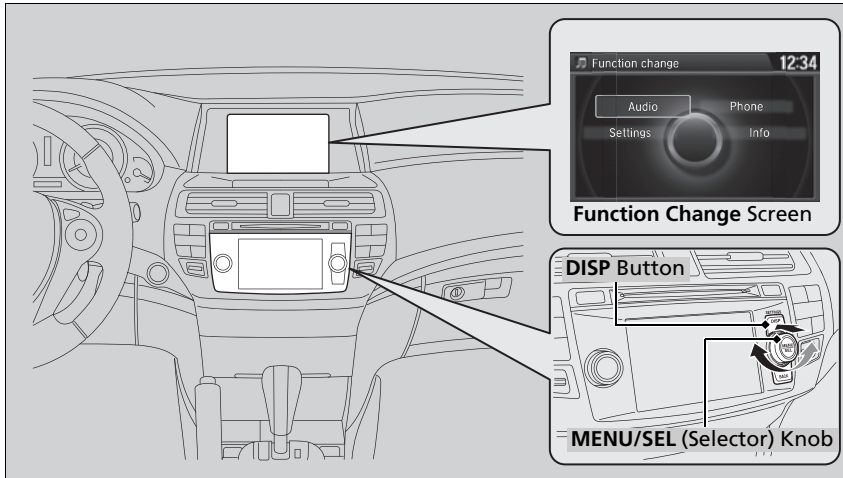

## Using the DISP button



Press the **DISP** button to go to the **Function Change** screen.  
 Rotate  to select **Audio**, **Phone**, **Info** or **Settings** and press .

### ■ Audio

Shows the current audio information.

### ■ Phone

Shows the HFL information.  **Bluetooth® HandsFreeLink®** P. 332

### ■ Settings

Enters the customizing menu screen.  **Customized Features\*** P. 281

\* Not available on all models

## ■ Info

Shows the Trip Computer or Clock/Wallpaper information.

Press , rotate  to select an item, then press .

### Info menu items

#### Current Drive (Trip computer)





Shows the range, and instant and average fuel economy of the current trip, as well as the average fuel economy from your last trip.

#### History of Trip A (Trip computer)

Shows the range, average fuel economy and distance traveled for the current trip, as well as the average fuel economy and distances traveled during the last three driving cycles.

Each time you reset the trip meter A, the information on the display updates. The history of the previous three driving cycles is kept.

#### Delete History

1. Rotate  to select **Delete History**, then press .
2. You will receive a confirmation message on the screen. Rotate  to select **Yes**, then press .

#### Clock/Wallpaper

Shows the current clock type and wallpaper

#### Clock/Wallpaper Change

Enters the clock and wallpaper setting menu screen.

## Wallpaper Setup

You can change, store, and delete the wallpaper on the audio/information screen.

### Import wallpaper

You can import up to three images, one at a time, for wallpaper from a USB flash drive.









1. Connect the USB flash drive to the USB adapter cable.  
 ▶ **USB Adapter Cable** P. 165
2. Press the **DISP** button to go to the **Function change** screen.
3. Rotate to select **Info**, then press .  
 ▶ Repeat the procedure to select **Clock/Wallpaper Change, Clock/Wallpaper Type**, then **Wallpaper**.
4. Rotate to select **Add New**, then press .  
 ▶ The picture name is displayed on the list.
5. Rotate to select a desired picture.  
 ▶ The preview is displayed on the left side on the screen.
6. Press to save the data.  
 ▶ The confirmation message will appear. Then the display will return to the wallpaper list.

### Wallpaper Setup









- When importing wallpaper files, the image must be in the USB flash drive's root directory. Images in a folder cannot be imported.
- The file name must be fewer than 64 characters.
- The file format of the image that can be imported is BMP (bmp) or JPEG (jpg).
- The individual file size limit is 2 MB.
- The maximum image size is 1,680 x 936 pixels. If the image size is less than 420 x 234 pixels, the image is displayed in the middle of the screen with the extra area appearing in black.
- Up to 255 files can be selected.
- If the USB flash drive does not have any pictures, the **No files detected** message appears.

You can also enter the wallpaper setup menu screen to select **Settings, Info Settings**, then **Clock/Wallpaper Type**.



### ■ Select wallpaper

1. Press the **DISP** button to go to the **Function change** screen.
2. Rotate  to select **Info**, then press .
  - ▶ Repeat the procedure to select **Clock/Wallpaper change, Clock/Wallpaper Type**, then **Wallpaper**.
  - ▶ The screen changes to the wallpaper list.
3. Rotate  to select a desired wallpaper.
  - ▶ The preview is displayed on the left side on the screen.
4. Press .
  - ▶ The pop-up menu appears on the screen.
5. Rotate  to select **Set**, then press .
  - ▶ The display will return to the wallpaper list.

### ■ Delete wallpaper

1. Press the **DISP** button to go to the **Function change** screen.
2. Rotate  to select **Info**, then press .
  - ▶ Repeat the procedure to select **Clock/Wallpaper change, Clock/Wallpaper Type**, then **Wallpaper**.
  - ▶ The screen changes to the wallpaper list.
3. Rotate  to select a wallpaper that you want to delete.
  - ▶ The preview is displayed on the left side on the screen.
4. Press .
  - ▶ The pop-up menu appears on the screen.
5. Rotate  to select **Delete**, then press .
  - ▶ The confirmation message will appear.
6. Rotate  to select **OK**, then press  to delete completely.
  - ▶ The display will return to the wallpaper list.

### ▶▶ Wallpaper Setup

From the pop-up menu, rotate  to select **Preview** and press  to see a preview at full-size screen.

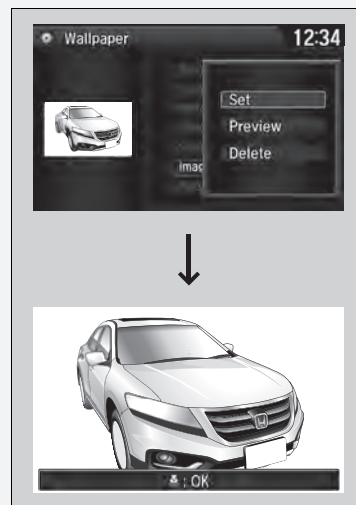

To go back to the previous screen, press  to select **OK**, or press the **BACK** button.

When the file size is large, it takes a while to be previewed.



## Adjusting the Sound

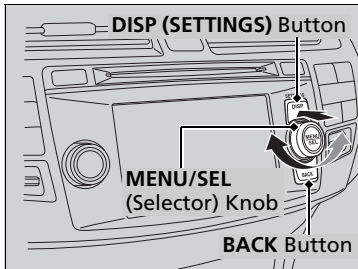

1. Press the **DISP** button.
2. Rotate to select **Settings**, then press .
3. Rotate to select **Audio Settings**, then press .
4. Rotate to select **Sound**, then press .



Rotate to scroll through the following choices:

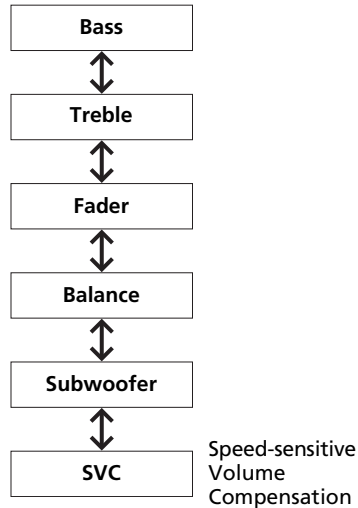

### Adjusting the Sound

The SVC has four modes: **Off**, **Low**, **Mid**, and **High**. SVC adjusts the volume level based on the vehicle speed. As you go faster, audio volume increases. As you slow down, audio volume decreases.

## Display Setup

You can change the brightness or color theme of the audio/information screen.

### ■ Changing the Screen Brightness



1. Press the **DISP** button to go to the **Settings** screen.
2. Rotate to select **System Settings**, then press .
  - ▶ Repeat the procedure to select **Display**.
3. Rotate to select **Brightness**, then press .
4. Rotate to adjust the setting.

### ■ Changing the Screen's Color Theme



1. Press the **DISP** button to go to the **Settings** screen.
2. Rotate to select **System Settings**, then press .
  - ▶ Repeat the procedure to select **Others**.
3. Rotate to select **Background Color**, then press .
4. Rotate to select the setting you want, then press .

### ☒ Changing the Screen Brightness

You can change the **Contrast** and **Black Level** settings in the same manner.

# Playing AM/FM Radio

Audio/Information Screen

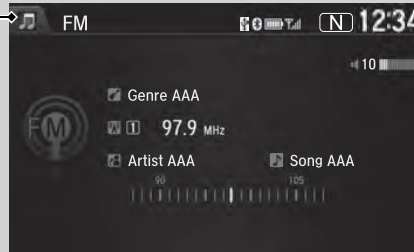

Audio with Touch Screen

**VOL/⏻ (Volume/Power) Knob**  
 Press to turn the audio system on and off.  
 Turn to adjust the volume.

Source

Select to change a band or change an audio source.

Tune Up/Down Icons

Select ◀ or ▶ to tune the radio frequency.

MENU/SEL (Selector) Knob

Press and turn to select an item, then press to set your selection.

Skip/Seek Icons

Select ◀◀ or ▶▶ to search up and down the selected band for a station with a strong signal.

BACK Button

Press to go back to the previous display.

## Presets

Select to store a station.



To listen to a stored channel, select 1-6 (AM) or 1-12 (FM).

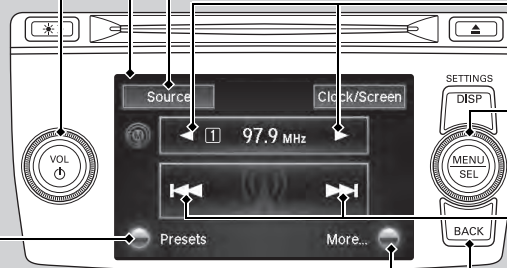

More





Select to display the menu items.

## ■ Preset Memory

To store a station:

1. Tune to the selected station.

### MENU/SEL (Selector) Knob

2. Press  to switch to the **Audio menu** screen.
3. Rotate  to select **Save Preset**, then press .
4. Rotate  to select the preset number you want to store that station, then press .

### Audio with Touch Screen

2. Select **More**.
3. Select **Save Preset**.
4. Select the preset number you want to store that station.

## ▶▶ Playing AM/FM Radio

The **ST** indicator appears on the display indicating stereo FM broadcasts. Stereo reproduction in AM is not available.

### Switching the Audio Mode

Press the **SOURCE** button on the steering wheel.

### **Audio Remote Controls** P. 168





You can also switch the mode by pressing  and selecting **Change Source** on the **Audio menu** screen.

You can store 6 AM stations and 12 FM stations into the preset memory.

## Radio Data System (RDS)





Provides text data information related to your selected RDS-capable FM station.

### ■ To find an RDS station from Station List

1. Press  to switch to the **Audio menu** screen while listening to an FM station.
2. Rotate  to select **Station List**, then press .
3. Rotate  to select the station, then press .

### ■ Manual update

Updates your available station list at any time.

1. Press  to switch to the **Audio menu** screen while listening to an FM station.
2. Rotate  to select **Station List**, then press .
3. Rotate  to select **UPDATE LIST**, then press .

## ⌘ Radio Data System (RDS)

When you select an RDS-capable FM station, the RDS automatically turns on, and the frequency display changes to the station name. However, when the signals of that station become weak, the display changes from the station name to the frequency.

*Continued*

### ■ Radio text





Displays the radio text information of the selected RDS station.

1. Press  to switch to the **Audio menu** screen.
2. Rotate  to select **Radio Text**, then press .

### ■ Scan

Samples each of the strongest stations on the selected band for 10 seconds.

#### MENU/SEL (Selector) Knob

1. Press  to switch to the **Audio menu** screen.
  2. Rotate  to select **Scan**, then press .
- To turn off scan, press  to select **Cancel Scan**, or press the **BACK** button.

#### Audio with Touch Screen

1. Select **More**.
  2. Select **Scan**.
- To turn off scan, select **Cancel Scan**.

#### ▶▶ Radio text

The text indicator comes on when you received a text message. The indicator stays on until you read the message.

## Playing XM® Radio \*

**Audio/Information Screen** — Points to the top screen showing XM logo, signal strength, and station information: Genre AAA, CH 001 Channel AAA, Artist AAA, Title AAA. Includes a progress bar for CH 10.

**Audio with Touch Screen** — Points to the touch-sensitive area of the stereo's display.

**VOL/⏻ (Volume/Power) Knob**  
 Press to turn the audio system on and off.  
 Turn to adjust the volume.

**Source**  
 Select to change an audio source.

**Category Up/Down Icons**  
 Select ◀ or ▶ to display and select an XM® Radio category.

**MENU/SEL (Selector) Knob**  
 Press and turn to select an item, then press to set your selection.

**Skip/Seek Icons**  
 Select ◀◀ or ▶▶ to the previous or next channel.  
 In channel mode, select and hold to change the channel rapidly.

**BACK Button**  
 Press to go back to the previous display.

**More**  
 Select to display the menu items.

**Presets**  
 Select to store a station.

Source	Clock/Screen	
CH001	CH002	CH003
CH004	CH005	CH006
Tune	More...	









To listen to a stored channel, select 1-12.

\* Not available on all models



## ■ To Play the XM® Radio

1. Select the XM® mode.
  - ▶ **Audio Remote Controls** P. 168
  - ▶ **Audio with Touch Screen** P. 183

### MENU/SEL (Selector) Knob

2. Press  to switch to the **Audio menu** screen.
3. Rotate  to select **XM Tune Mode**, then press .
4. Rotate  to select **Channel Mode** or **Category Mode**, then press .
5. Rotate  to select **Channel List**, then press .
6. Rotate  to select a channel from a list, then press .

### Audio with Touch Screen

2. Select **More**.
3. Select **Tune Mode**.
4. Select **CH Channel Mode** or **CAT Category Mode**.
5. Select a channel using the , , ,  icons on the tune mode screen or the preset numbers (**1-12**) on the preset mode screen.

## ▶▶ Playing XM® Radio\*

In the channel mode, all available channels are selectable. In the category mode, you can select a channel within a category (Jazz, Rock, Classical, etc.).

There may be instances when XM® Radio does not broadcast all the data fields (artist name, title). This does not indicate a problem with your audio system.







## Preset Memory

To store a station:

1. Tune to the selected station.

### MENU/SEL (Selector) Knob

2. Press  to switch to the **Audio menu** screen.
3. Rotate  to select **Save Preset**, then press .
4. Rotate  to select the preset number you want to store that station, then press .

### Audio with Touch Screen

2. Select **More**.
3. Select **Save Preset**.
4. Select the preset number you want to store that station.

### ▶▶▶ Playing XM® Radio\*

You can store 12 XM® stations into the preset memory.

\* Not available on all models

## Playing a CD

Your audio system supports audio CDs, CD-Rs and CD-RWs in either MP3, WMA, or AAC\*1 format. With the CD loaded, select the CD mode.

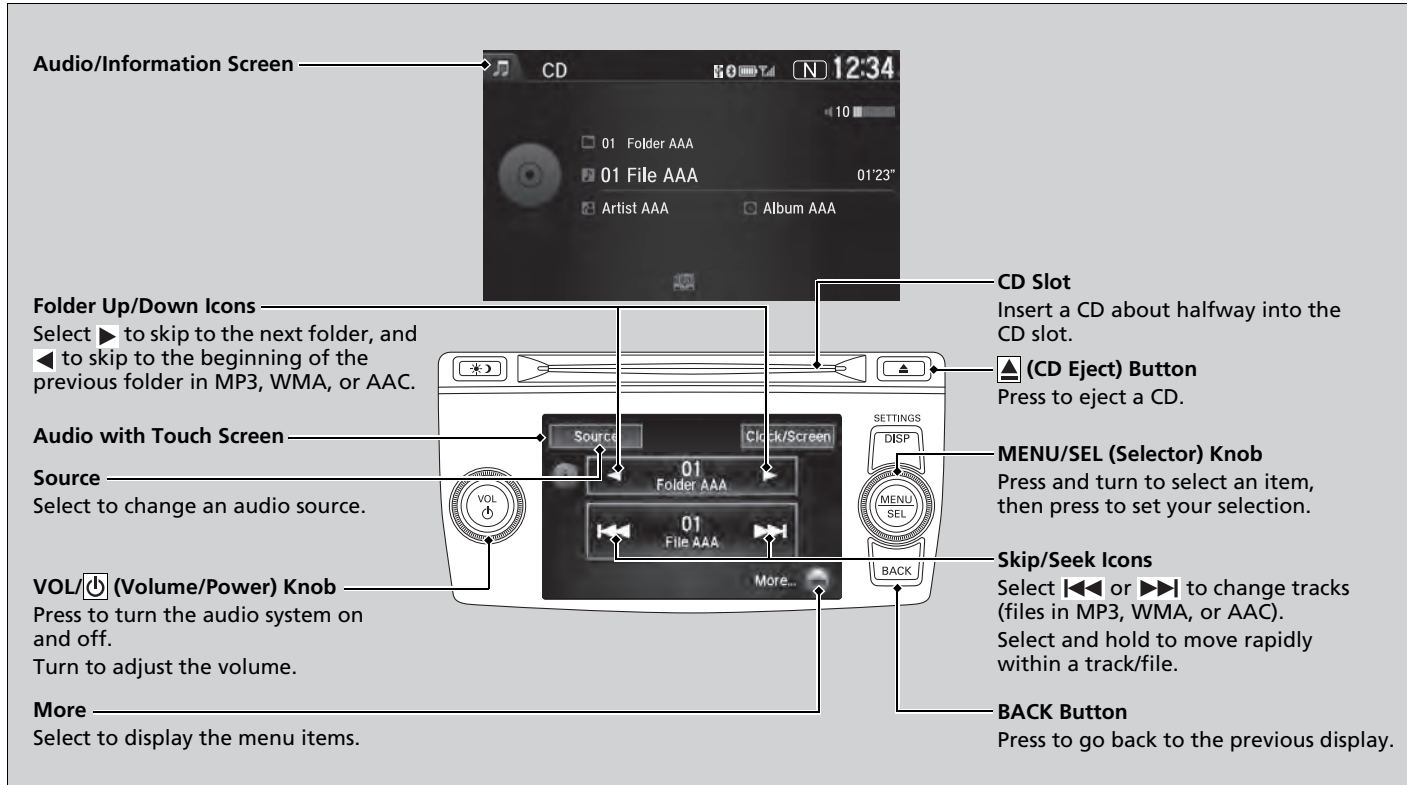

\*1: Only AAC format files recorded with iTunes® are playable on this unit.

## How to Select a File from the Music Search List (MP3/WMA/AAC)

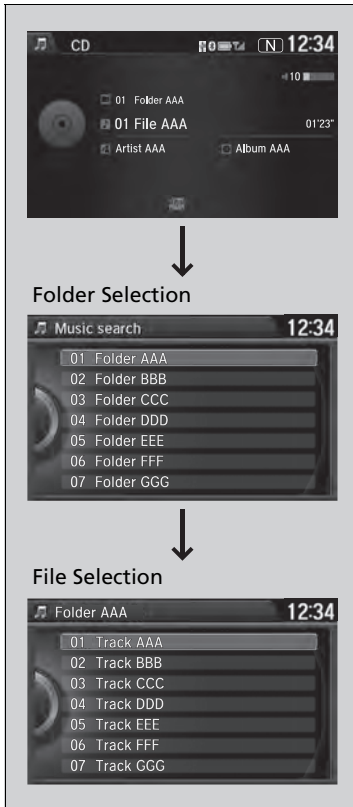

1. Press . Rotate to select **Music Search**, then press .
2. Rotate to select a folder.
3. Press to change the display to a list of files in that folder.
4. Rotate to select a file, then press .

## ▶▶ Playing a CD

### NOTICE

Do not use CDs with adhesive labels. The label can cause the CD to jam in the unit.

WMA files protected by digital rights management (DRM) cannot be played.

The audio system displays **Unplayable File**, then skips to the next file.

Text data appears on the display under the following circumstances:

- When you select a new folder, file, or track.
- When you change the audio mode to CD.
- When you insert a CD.

If you eject the CD but do not remove it from the slot, the system reloads the CD automatically after several seconds.

Continued

## How to Select a Play Mode

You can select scan, repeat, and random modes when playing a track or file.

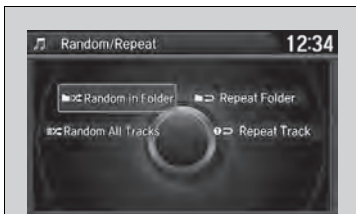

Random/Repeat is selected.

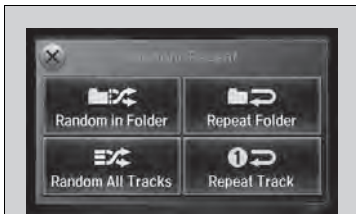

Random/Repeat is selected.

### MENU/SEL (Selector) Knob

1. Press to switch to the **Audio menu** screen.
2. Rotate to select **Scan** or **Random/Repeat**, then press .
3. Rotate to select a mode, then press .

### Audio with Touch Screen

1. Select **More**.
2. Select **Scan** or **Random/Repeat**.
3. Select a mode.

## How to Select a Play Mode

Play Mode Menu Items

### Scan

**Scan Folders** (MP3/WMA/AAC): Provides 10-second sampling of the first file in each of the main folders.

**Scan Tracks**: Provides 10-second sampling of all tracks on the CD (all files in the current folder in MP3, WMA, or AAC).

### Random/Repeat

**Repeat Folder** (MP3/WMA/AAC): Repeats all files in the current folder.

**Repeat Track**: Repeats the current track/file.

**Random in Folder** (MP3/WMA/AAC): Plays all files in the current folder in random order.

**Random All Tracks**: Plays all tracks/files in random order.

## To turn off a play mode

### MENU/SEL (Selector) Knob

1. Press to switch to the **Audio menu** screen.
2. Rotate to select the mode you want to turn off, then press .

### Audio with Touch Screen

1. Select **More**.
2. Select the mode you want to turn off.

## Playing an iPod®

Connect the iPod® using your dock connector to the USB adapter cable, then select the iPod mode.

 **USB Adapter Cable** P. 165

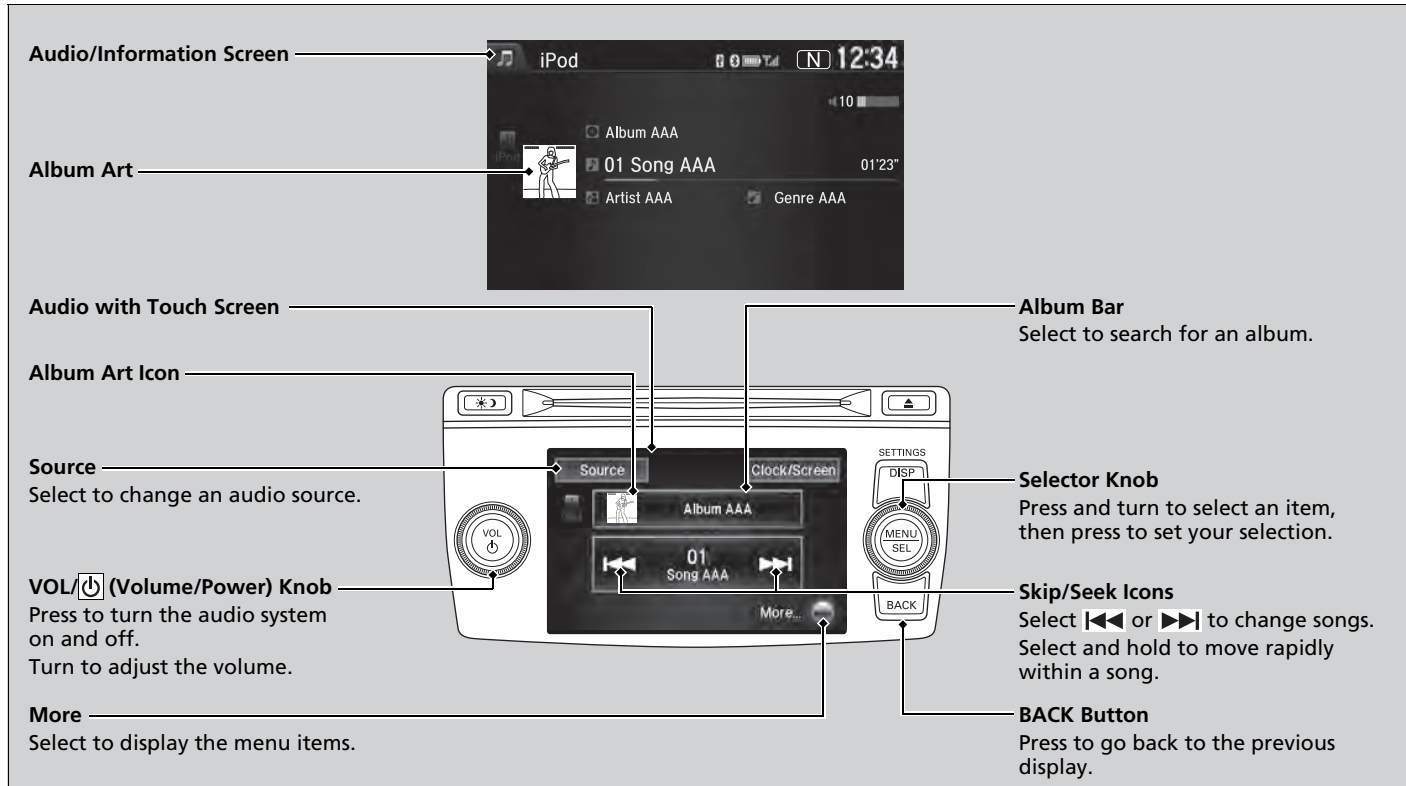

## How to Select an Album

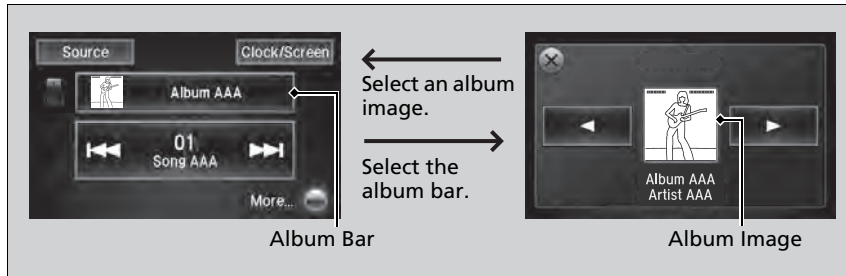

1. Select the album bar.
  - ▶ The image of the current album is displayed.
2. Select ◀ or ▶ icon to search for an album.
  - ▶ When the album image you are looking for appears, select it to play.

## How to Select an Album

You cannot select an album while the vehicle is moving.

Select  to go back to the previous screen.

## How to Select a Song from the Music Search List

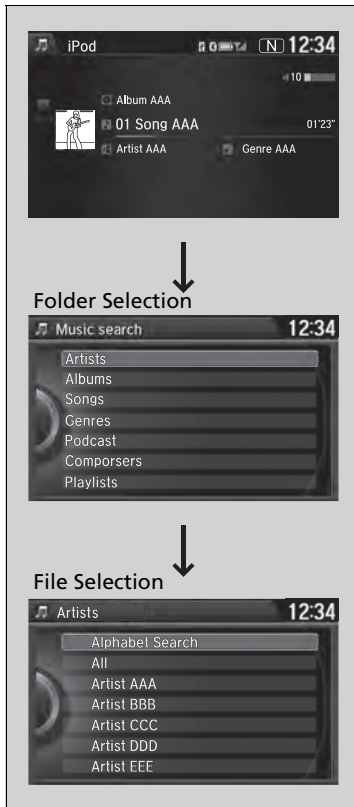

1. Press . Rotate to select **Music Search**, then press .
2. Rotate to select a menu.
3. Press to display the items on that menu.
4. Rotate to select an item, then press .

### How to Select a Song from the Music Search List

Available operating functions vary on models or versions. Some functions may not be available on the vehicle's audio system.

If there is a problem, you may see an error message on the audio/information screen.



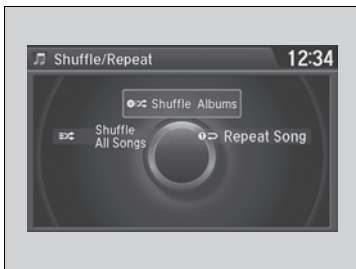

**iPod®/USB Flash Drive** P. 271

## How to Select a Play Mode

You can select repeat and shuffle modes when playing a file.



### MENU/SEL (Selector) Knob

1. Press  to switch to the **Audio menu** screen.
2. Rotate  to select **Shuffle/Repeat**, then press .
3. Rotate  to select a mode, then press .



### Audio with Touch Screen

1. Select **More**.
2. Select **Shuffle/Repeat**.
3. Select a mode.



## To turn off a play mode

### MENU/SEL (Selector) Knob

1. Press  to switch to the **Audio menu** screen.
2. Rotate  to select the mode you want to turn off, then press .

### Audio with Touch Screen

1. Select **More**.
2. Select the mode you want to turn off.

## How to Select a Play Mode

### Play Mode Menu Items

**Repeat Song:** Repeats the current track.

**Shuffle Albums:** Plays all available albums in a selected list (playlists, artists, albums, songs, genres, or composers) in random order.

**Shuffle All Songs:** Plays all available files in a selected list (playlists, artists, albums, songs, genres, or composers) in random order.



U.S. models

Compatible phones only

## Playing Internet Radio

Connect a compatible phone through *Bluetooth*®.

iPhone

You can also connect the phone using your dock connector to the USB adapter cable.

Select **Source** to select Pandora or Aha mode.

### ▶▶ Playing Internet Radio

Pandora®, the Pandora logo, and the Pandora trade dress are trademarks or registered trademarks of Pandora Media, Inc., used with permission. Pandora is currently available exclusively in the United States.

The diagram illustrates the car's audio system interface for playing internet radio. It features a central display screen and a set of physical controls below it. The screen shows the Pandora interface with fields for Station AAA, Song AAA (01:23), Artist AAA, and Album AAA. A USB indicator is shown at the top right of the screen. The physical controls include a Volume/Power knob, Play/Pause, Like/Dislike, and More buttons, and a MENU/SEL knob with Skip and BACK buttons. Arrows point from text labels to these specific elements.

**Audio/Information Screen** — Points to the top section of the display showing Pandora logo, station name, and time.

**Album Art** — Points to the album art icon on the screen.

**Audio with Touch Screen** — Points to the touch-sensitive area of the screen.

**Source** — Select Pandora® or Aha™.

**VOL/⏻ (Volume/Power) Knob** — Press to turn the audio system on and off. Turn to adjust the volume.

**Play/Pause Icon** — Select to resume or play a song.

**Like/Dislike Icons** — Select to evaluate a song.

**More** — Select to display the menu items.

**USB Indicator** — Appears when a phone is connected.

**Rating Icon** —

**Station Up/Down Icons** — Select to change a station.

**MENU/SEL (Selector) Knob** — Press and turn to select an item, then press to set your selection.

**Skip Icon** — Select to skip a song.

**BACK Button** — Press to go back to the previous display.

Features

\* Not available on all models

Continued



## ■ Pandora® Menu

You can operate some of the Pandora® menu items from your vehicle's audio system. The available items are:

- Like
- Dislike
- Station List
- Change Source
- Bookmark Track
- Bookmark Artist
- Play/Pause

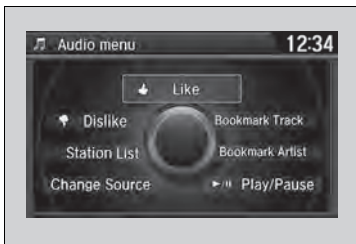
### ■ Operating a menu item



1. Press  to switch to the **Audio menu** screen.
2. Rotate  to select an item and press .

## ▶▶ Playing Internet Radio

To find out if your phone is compatible with this feature, visit [www.handsfreelink.honda.com](http://www.handsfreelink.honda.com), or call (888) 528-7876.

Pandora® is a personalized Internet radio service that selects music based on an artist, song, or genre a user enters, and streams what is likely to be of interest.

To use this service in your vehicle, the Pandora® app must first be installed on your phone. Visit [www.pandora.com](http://www.pandora.com) for more information.

If you cannot operate Pandora® through the audio system, it may be streaming through *Bluetooth®* Audio. Make sure Pandora® mode on your audio system is selected.

## ▶▶ Pandora® Menu

Available operating functions vary on software versions. Some functions may not be available on the vehicle's audio system.

If there is a problem, you may see an error message on the audio/information screen.

 **Pandora®**\* P. 273

There are restrictions on the number of songs you can skip or dislike in a given hour.



## Aha™ Menu

You can operate some of the Aha™ menu items from your vehicle's audio system. The available items are:

- Like
- Play/Pause
- Stations
- Change Source
- Dislike
- 15sec Back
- 30sec Skip
- View text
- View list

### Operating a menu item



1. Press  to switch to the **Audio menu** screen.
2. Rotate  to select an item and press .

## Aha™ Menu

Aha™ by Harman is a cloud-based service that organizes your favorite web content into live radio stations. You can access podcasts, internet radio, location-based services, and audio updates from social media sites.

Available operating functions vary on software versions. Some functions may not be available on the vehicle's audio system.

If there is a problem, you may see an error message on the audio/information screen.

 **Aha™\* P. 275**

The menu items vary depending on the station you selected.

To use this service in your vehicle, the HondaLink app must be installed on your phone. Visit [owners.honda.com/apps](http://owners.honda.com/apps) for more information.

You must have a previously set up Aha account prior to using the service in your vehicle. Visit [www.aharadio.com](http://www.aharadio.com) for more information.

\* Not available on all models

## Playing a USB Flash Drive

Your audio system reads and plays sound files on a USB flash drive in either MP3, WMA or AAC\*1 format.

Connect your USB flash drive to the USB adapter cable, then select the USB mode.

➤ **USB Adapter Cable** P. 165

**Audio/Information Screen** — Points to the top screen showing USB mode, folder/file list, and time.

**USB Indicator** — Appears when a USB flash drive is connected.

**Audio with Touch Screen** — Points to the bottom screen with touch-sensitive icons.

**Source** — Select to change an audio source.

**VOL/⏻ (Volume/Power) Knob** — Press to turn the audio system on and off. Turn to adjust the volume.

**Folder Up/Down Icons** — Select ▶ to skip to the next folder, and ◀ to skip to the beginning of the previous folder.

**MENU/SEL (Selector) Knob** — Press and turn to select an item, then press to set your selection.

**Skip/Seek Icons** — Select ◀◀ or ▶▶ to change files. Select and hold to move rapidly within a file.

**More...** — Select to display the menu items.

**BACK Button** — Press to go back to the previous display.

\*1: Only AAC format files recorded with iTunes® are playable on this unit.

## How to Select a File from the Music Search List

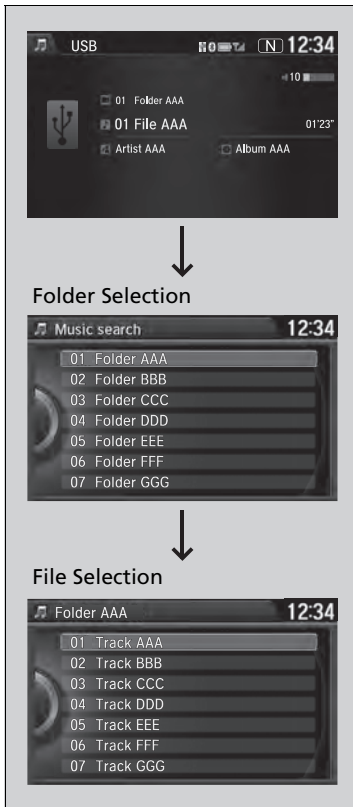

1. Press . Rotate to select **Music Search**, then press .
2. Rotate to select a folder.
3. Press to change the display to a list of files in that folder.
4. Rotate to select a file, then press .

## ▶▶ Playing a USB Flash Drive

Use the recommended USB flash drives.

▶ **USB Flash Drives** P. 280

Files in WMA format protected by digital rights management (DRM) are not played.

The audio system displays **Unplayable File**, and then skips to the next file.

If there is a problem, you may see an error message on the audio/information screen.

▶ **iPod®/USB Flash Drive** P. 271

## ■ How to Select a Play Mode

You can select scan, repeat, and random modes when playing a file.



### MENU/SEL (Selector) Knob

1. Press to switch to the **Audio menu** screen.
2. Rotate to select **Scan** or **Random/Repeat**, then press .
3. Rotate to select a mode, then press .



### Audio with Touch Screen

1. Select **More**.
2. Select **Scan** or **Random/Repeat**.
3. Select a mode.

## ■ To turn off a play mode

### MENU/SEL (Selector) Knob

1. Press to switch to the **Audio menu** screen.
2. Rotate to select the mode you want to turn off, then press .

### Audio with Touch Screen

1. Select **More**.
2. Select the mode you want to turn off.

## ▶▶ How to Select a Play Mode

### Play Mode Menu Items

#### Scan

**Scan Folders:** Provides 10-second sampling of the first file in each of the main folders.

**Scan Tracks:** Provides 10-second sampling of all files in the current folder.

#### Random/Repeat

**Repeat Folder:** Repeats all files in the current folder.

**Repeat Track:** Repeats the current file.

**Random in Folder:** Plays all files in the current folder in random order.

**Random All Tracks:** Plays all files in random order.

## Playing *Bluetooth*® Audio

Your audio system allows you to listen to music from your *Bluetooth*®-compatible phone.

This function is available when the phone is paired and connected to the vehicle's *Bluetooth*® HandsFreeLink® (HFL) system.

📄 **Phone Setup** P. 339

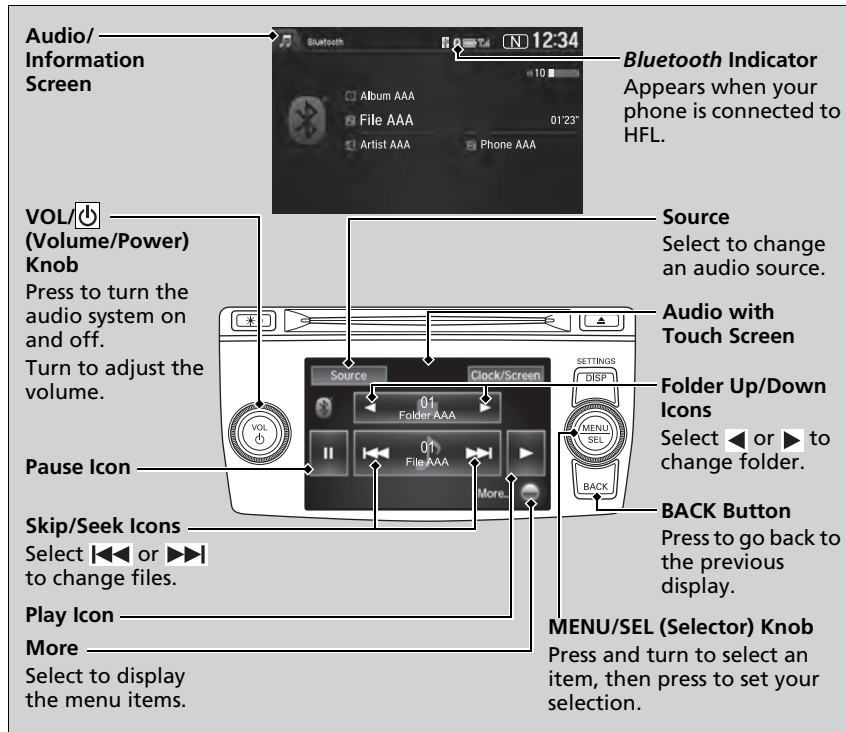

### ▶▶ Playing *Bluetooth*® Audio

Not all *Bluetooth*-enabled phones with streaming audio capabilities are compatible with the system.

For a list of compatible phones:

- U.S.: Visit [www.handsfreelink.honda.com](http://www.handsfreelink.honda.com), or call 1-888-528-7876.
- Canada: Visit [www.handsfreelink.ca](http://www.handsfreelink.ca), or call 1-888-528-7876.

In some states, it may be illegal to perform some data device functions while driving.

If more than one phone is paired to the HFL system, there will be a delay before the system begins to play.

Continued

## ■ To Play *Bluetooth*® Audio Files





1. Make sure that your phone is paired and connected to HFL.
2. Select the *Bluetooth*® Audio mode.

If the phone is not recognized, another HFL-compatible phone, which is not compatible for *Bluetooth*® Audio, may already be connected.

## ■ To pause or resume a file

### MENU/SEL (Selector) knob

1. Press  to switch to the **Audio menu** screen.
2. Rotate  to select **Play** or **Pause**, then press .

### Audio with Touch Screen

Select the play icon or pause icon.

## ■ Switching to HFL

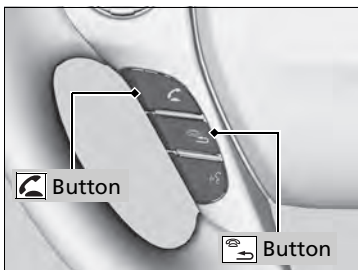

Press the  (pick-up) button on the steering wheel to receive a call when *Bluetooth*® Audio is playing.

▶ *Bluetooth*® HandsFreeLink® P. 332

Press the  (hang-up/back) button to end the call and return to *Bluetooth*® Audio.

## ▶▶ To Play *Bluetooth*® Audio Files

To play the audio files, you may need to operate your phone. If so, follow the phone maker's operating instructions.

The pause function may not be available on some phones.

Switching to another mode pauses the music playing from your phone.

## ▶▶ Switching to HFL

If you receive a call while *Bluetooth*® Audio is in the pause mode, it will resume play after ending the call.



## Models with navigation system

To use the audio system function, the ignition switch must be in ACCESSORY **I** or ON **II**\*1.

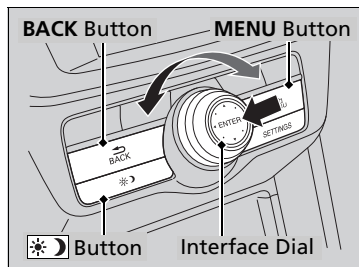

Use the interface dial or **MENU** button to access some audio functions.

Press to switch between the normal and extended display for some functions.

**Interface dial:** Rotate left or right to scroll through the available choices. Press to set your selection. Move right, left, up or down to select secondary menu.

**MENU button:** Press to select any mode. The available mode includes **Change Source, Station List, Save Preset, Radio Text, Music Search,** and play modes. Play modes can be also selected from **Scan, Random/Repeat,** and so on.

**BACK button:** Press to go back to the previous display.

**button:** Press to change the audio/information screen brightness.

Press once and make an adjustment.

- ▶ Each time you press , the mode switches between the daytime mode, nighttime mode and off mode.

\*1: Models with the smart entry system have an **ENGINE START/STOP** button instead of an ignition switch.

## Audio System Basic Operation

### Voice Control System

The audio system is voice operable. See the navigation system manual for details.

These indications are used to show how to operate the interface dial.

Rotate to select.

Press to enter.

Move , , or to select secondary menu.

### Audio Menu Items

- ▶ **Station List** P. 234
- ▶ **Save Preset** P. 233, 238
- ▶ **Radio text** P. 235
- ▶ **Music Search** P. 240, 244, 254, 264
- ▶ **Scan** P. 241, 245, 265
- ▶ **Random/Repeat** P. 241, 245, 255, 265

## Audio with Touch Screen

Use the touch screen to operate the audio system.

### Selecting an Audio Source

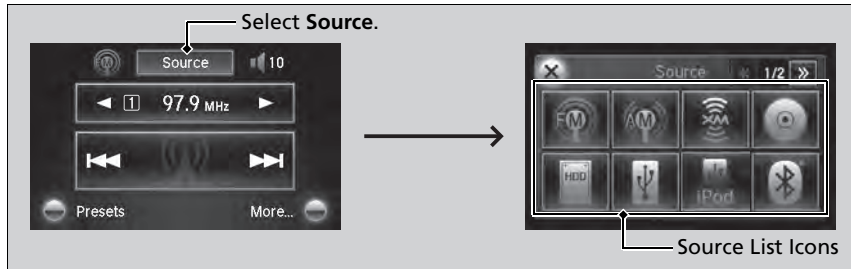

Select **Source**, then select an icon on the source list to switch the audio source.

### Displaying the Menu Items

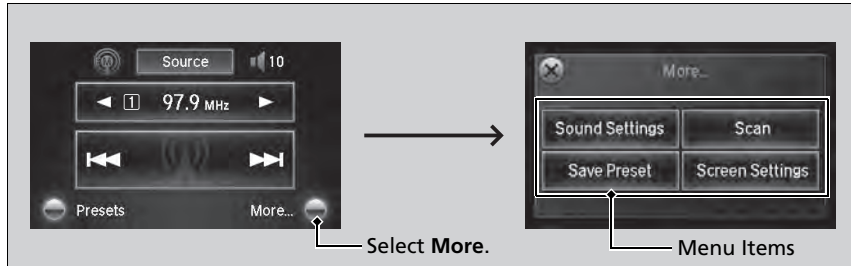

Select **More** to display the menu items.

### Audio with Touch Screen

Icons that appear on the screen vary by the source selected.

Select  to go back to the previous screen.

Use the     icons to turn the page.

## Adjusting the Sound

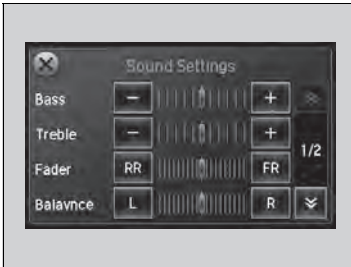

1. Select **More**, then **Sound Settings**.
2. Use  $\boxed{+}$ ,  $\boxed{-}$  or others to adjust the setting.

## Changing the Screen Settings



1. Select **More**, then **Screen Settings**.
2. Use  $\boxed{+}$ ,  $\boxed{-}$  or others to adjust the setting.

### Adjusting the Sound

Select **Off**, **Low**, **Mid** or **High** for the SVC setting.

▶ **Adjusting the Sound** P. 222

### Changing the Screen Settings

The followings are adjustable screen settings:

- **Brightness**
- **Contrast**
- **Black Level**
- **Display**  
Changes between the daytime or nighttime modes.
- **Beep**  
Mutes a beep that sounds every time you touch the screen.
- **Fade Timer**  
Sets the screen black out timing.

## Audio/Information Screen

Displays the audio status and wallpaper. From this screen, you can go to various setup options.

### ■ Switching the Display

Press the  (display) button to change the display.

### ▶▶ Switching the Display

You can also use the **AUDIO**, **NAV**, **PHONE** and **INFO** buttons to go to the corresponding display.

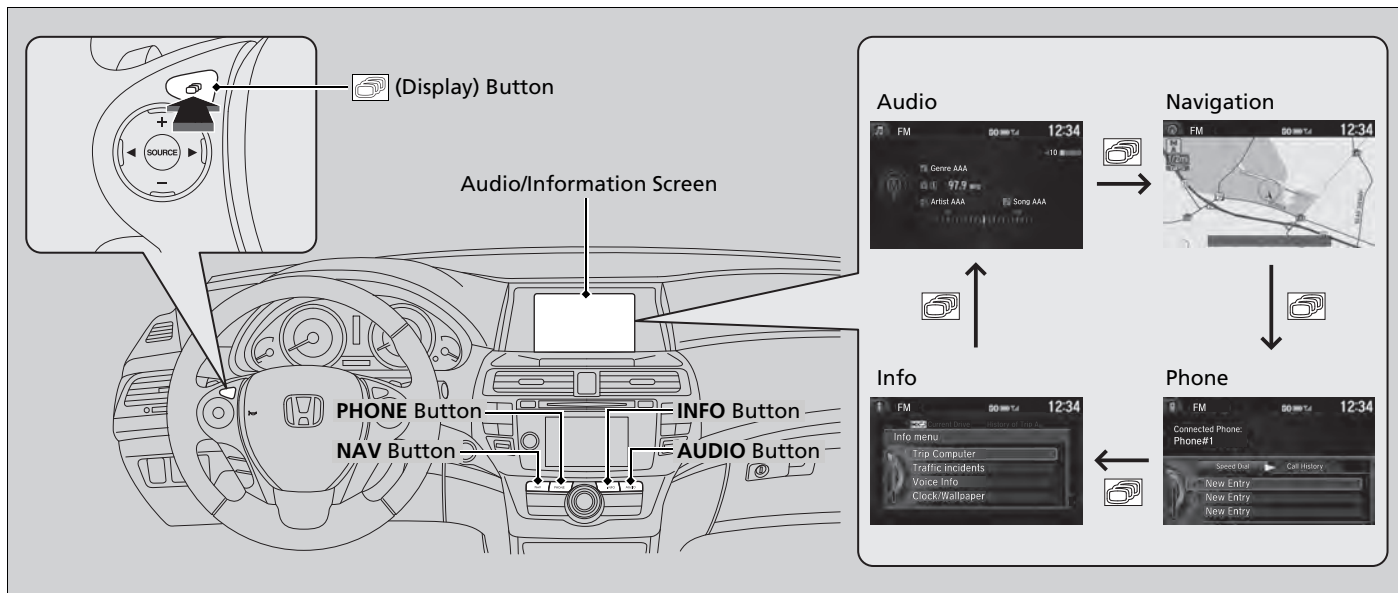

## ■ Audio

Shows the current audio information.

## ■ Navigation

Shows the navigation screen.  **Refer to the Navigation System Manual**

## ■ Phone

Shows the HFL information.  **Bluetooth® HandsFreeLink®** P. 367

## ■ Info

Shows the **Trip Computer** or **Clock/Wallpaper** and other information. Rotate  to select an item, then press .





## ■ Trip computer (Current Drive)

Shows the range, and instant and average fuel economy of the current trip, as well as the average fuel economy from your last trip.

## ■ Trip computer (History of Trip A)

Shows the range, average fuel economy and distances traveled for the current trip, as well as the average fuel economy and distances traveled during the last three driving cycles. Each time you reset the trip meter A, the information on the display updates. The history of the previous three driving cycles is kept.

## ■ Deleting the history manually

1. Move  on the **History of Trip A** screen to select **Delete History**, then press .
2. You will receive a confirmation message on the screen. Rotate  to select **Yes**, then press .

## ■ Clock/Wallpaper

Shows a clock screen or an image you import.

## Wallpaper Setup

You can change, store, and delete the wallpaper on the audio/information screen.

### Import wallpaper

You can import up to three images, one at a time, for wallpaper from a USB flash drive.

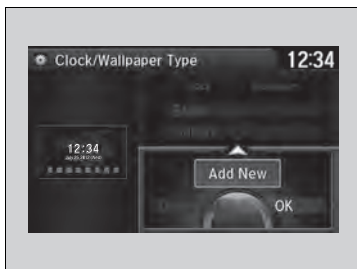







1. Connect the USB flash drive to the USB adapter cable.
  - ▶ **USB Adapter Cable** P. 165
2. Press the **SETTINGS** button.
3. Rotate to select **System Settings**, then press .
  - ▶ Repeat the procedure to select **Clock, Clock/Wallpaper Type**.
4. Move to select **Wallpaper**.
  - ▶ The screen will change to the wallpaper list.
5. Move to select **Add New**, then press .
6. Rotate to select a desired picture.
  - ▶ The preview is displayed on the left side on the screen.
7. Press , then move to select **Start Import**.
  - ▶ The confirmation message will appear. Then the display will return to the wallpaper list.













### Wallpaper Setup

- When importing wallpaper files, the image must be in the USB flash drive's root directory. Images in a folder cannot be imported.
- The file name must be fewer than 64 characters.
- The file format of the image that can be imported is BMP (bmp) or JPEG (jpg).
- The individual file size limit is 6 MB.
- The maximum image size is 1,680 x 936 pixels. If the image size is less than 420 x 234 pixels, the image is displayed in the middle of the screen with the extra area appearing in black.
- Up to 255 files can be selected.
- If the USB flash drive does not have any pictures, the **No files detected** message appears.



### ■ Select wallpaper

1. Press the **SETTINGS** button.
2. Rotate  to select **System Settings**, then press .
  - ▶ Repeat the procedure to select **Clock/Wallpaper Type**.
3. Move  to select **Wallpaper**.
  - ▶ The screen changes to the wallpaper list.
4. Rotate  to select a desired wallpaper.
  - ▶ The preview is displayed on the left side on the screen.
5. Press .
  - ▶ The pop-up menu appears on the screen.
6. Rotate  to select **Set**, then press .
  - ▶ The display will return to the wallpaper list.

### ■ Delete wallpaper

1. Press the **SETTINGS** button.
2. Rotate  to select **System Settings**, then press .
  - ▶ Repeat the procedure to select **Clock/Wallpaper Type**.
3. Move  to select **Wallpaper**.
  - ▶ The screen changes to the wallpaper list.
4. Rotate  to select a wallpaper that you want to delete, then press .
  - ▶ The preview is displayed on the left side on the screen.
5. Press .
  - ▶ The pop-up menu appears on the screen.
6. Rotate  to select **Delete**, then press .
  - ▶ The confirmation message will appear.
7. Rotate  to select **Yes**, then press  to delete completely.
  - ▶ The display will return to the wallpaper list.

### Wallpaper Setup

From the pop-up menu, rotate  to select **Preview** and press  to see a preview at full-size screen.

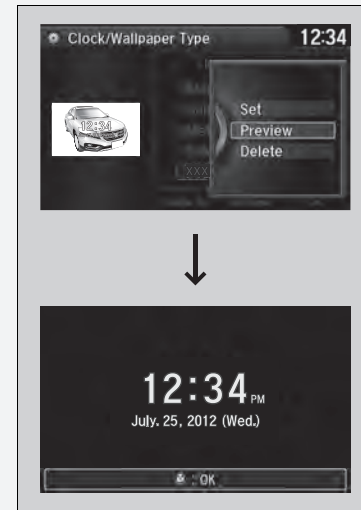

To go back to the previous screen, press  to select **OK**, or press the **BACK** button.

When the file size is large, it takes a while to be previewed.

## Adjusting the Sound

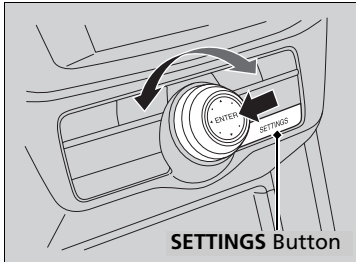

1. Press the **SETTINGS** button.
2. Rotate to select **Audio Settings**, then press .
3. Rotate to select **Sound**, then press .



Rotate to scroll through the following choices:

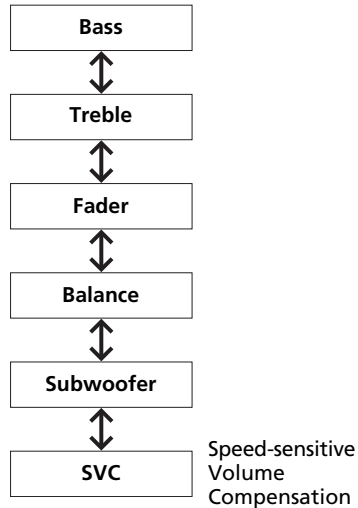

### ▶▶ Adjusting the Sound

The SVC has four modes: **Off**, **Low**, **Mid**, and **High**. SVC adjusts the volume level based on the vehicle speed. As you go faster, audio volume increases. As you slow down, audio volume decreases.







## Display Setup

You can change the brightness or color theme of the audio/information screen.







### Changing the Screen Brightness

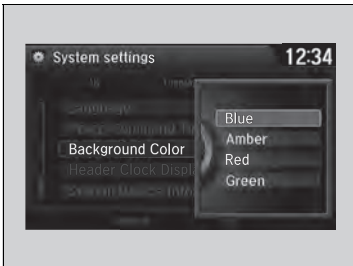

1. Press the **SETTINGS** button.
2. Rotate  to select **System Settings**, then press .
3. Rotate  to select **Brightness**, then press .
4. Rotate  to adjust the setting.

### Changing the Screen's Color Theme





1. Press the **SETTINGS** button.
2. Rotate  to select **System Settings**, then press .
3. Rotate  to select **Background Color**, then press .
4. Rotate  to select the setting you want, then press .

### Changing the Screen Brightness

You can change the **Contrast** and **Black Level** settings in the same manner.

## Voice Control Operation

Your vehicle has a voice control system that allows hands-free operation of most of the navigation system functions.

The voice control system uses the  (Talk) and  (hang-up/back) buttons on the steering wheel and a microphone near the map lights on the ceiling.



### Voice Recognition

To achieve optimum voice recognition when using the navigation voice control system:

- Make sure the correct screen is displayed for the voice command that you are using.
- Close the windows and moonroof.
- Adjust the dashboard and side vents so air does not blow onto the microphone on the ceiling.
- Speak clearly in a clear, natural speaking voice without pausing between words.
- Reduce any background noise if possible. The system may misinterpret your command if more than one person is speaking at the same time.
- Refer to the Voice Help feature.

 **Refer to the navigation System Manual**

### Voice Control Operation

When you press the  button, a helpful prompt asks what you would like to do. Press and release the  button again to bypass this prompt and give a command.

### Voice Recognition

The voice control system can only be used from the driver's seat because the microphone unit removes noises from the front passenger's side.

## Voice Portal Commands

The system accepts these commands on the **Voice Portal** screen.

- *Call Your contact name*
- *Call Phone Number*
- *Find nearest POI category name*
- *Go home*
- *Route menu*
- *Cancel route*

## Phone Commands

The system accepts these commands on any screen.

- *Call by number*
- *Call by name*

Contacts that are imported from your phone to the vehicle are all made available by voice. Voice Tags can also be recorded for each of your Speed Dial entries.

## Navigation Commands

Refer to the **Navigation System Manual**

## Info Commands

The system accepts these commands on any screen.

- *Trip computer*
- *Traffic information*
- *Display clock*
- *Display wallpaper*

## On Screen Commands



When the  (Talk) button is pressed, available voice commands appear on the screen.

For a complete list of commands, say "Voice Help" after the beep.

## ■ Climate Control Commands

The system accepts these commands on most screens.

- *Climate control automatic*\*<sup>1</sup>
- *Climate control off*\*<sup>1</sup>
- *Air conditioner on*\*<sup>1</sup>
- *Air conditioner off*\*<sup>1</sup>
- *Climate control defrost on*\*<sup>1</sup>
- *Climate control defrost off*\*<sup>1</sup>
- *Rear defrost on*\*<sup>1</sup>
- *Rear defrost off*\*<sup>1</sup>
- *Climate control fresh air*
- *Climate control recirculate*
- *Climate control vent*
- *Climate control bi-level*
- *Climate control floor*
- *Climate control floor and defrost*
- *Fan speed up*
- *Fan speed down*
- *Fan speed # (#: 1 to 7)*
- *Temperature # degrees (#: 57 to 87°F, 15 to 29°C)*
- *Driver temperature # degrees (#: 57 to 87°F, 15 to 29°C)*
- *Passenger temperature # degrees (#: 57 to 87°F, 15 to 29°C)*
- *Temperature up*
- *Temperature down*

- *Driver temperature up*
- *Driver temperature down*
- *Passenger temperature up*
- *Passenger temperature down*
- *Temperature max heat*
- *Temperature max cool*
- *Driver temperature max heat*
- *Driver temperature max cool*
- *Passenger temperature max heat*
- *Passenger temperature max cool*
- *Climate control sync on*\*<sup>1</sup>
- *Climate control sync off*\*<sup>1</sup>

\*1: These commands toggle the function on and off, so the command may not match your intended action.

## ■ Audio Commands

The system accepts these commands on most screens.

### ■ Using Song By Voice™

Song By Voice™ is a feature that allows you to select music from your Hard Disc Drive or iPod® device using your voice.

To activate this mode, you must press the  (Talk) button on the **Voice Portal** screen and say: "Music search."

## ■ Song By Voice™ commands

- *Music search*
- *List album* (specify album)
- *List artist* (specify artist)
- *List composer* (specify composer)
- *List genre* (specify genre)
- *List playlist* (specify playlist)
- *Play album* (specify album)
- *Play artist* (specify artist)
- *Play composer* (specify composer)
- *Play genre* (specify genre)
- *Play playlist* (specify playlist)
- *Play song* (specify song)
- *What am I listening to?*
- *Who am I listening to?*
- *Who is this?*
- *What's playing?*
- *Who's playing?*
- *What album is this?*

**■ HDD commands**

- *Hard Disc Drive play*
- *Hard Disc Drive play track #* (#: 1 to 30)
- *Hard Disc Drive skip forward*
- *Hard Disc Drive skip back*
- *Hard Disc Drive album up*<sup>\*2</sup>
- *Hard Disc Drive album down*<sup>\*2</sup>
- *Hard Disc Drive track up*
- *Hard Disc Drive track down*
- *Hard Disc Drive playlist up*<sup>\*2</sup>
- *Hard Disc Drive playlist down*<sup>\*2</sup>
- *Hard Disc Drive track random*<sup>\*1</sup>
- *Hard Disc Drive track repeat*<sup>\*1</sup>
- *Hard Disc Drive track scan*<sup>\*1</sup>
- *Hard Disc Drive normal play*
- *What am I listening to?*
- *Who am I listening to?*
- *Who is this?*
- *What's playing?*
- *Who's playing?*
- *What album is this?*

\*1: These commands toggle the function on and off, so the command may not match your intended action.

\*2: These commands are available only in the corresponding playback mode. For example, "Artist" commands are available only in "Artist" mode.

**■ Radio commands**

- *Audio on*<sup>\*1</sup>
- *Audio off*<sup>\*1</sup>
- *Radio on*<sup>\*1</sup>
- *Radio off*<sup>\*1</sup>
- *Radio select FM*
- *Radio select AM*
- *Radio tune to # FM*  
(#: frequency from 87.7 to 107.9)
- *Radio tune to # AM*  
(#: frequency from 530 [five thirty] to 1710 [seventeen ten])
- *Radio seek up*
- *Radio seek down*
- *Radio next station*
- *Radio preset #* (#: 1 to 12)
- *Radio FM preset #* (#: 1 to 12)
- *Radio AM preset #* (#: 1 to 6)
- *Radio scan*<sup>\*1</sup>
- *Radio select XM*
- *XM channel #*  
(#: 0 to 255 [two fifty five])
- *XM channel down*
- *XM category up*
- *XM category down*
- *XM preset #* (#: 1 to 12)
- *XM scan*<sup>\*1</sup>
- *XM category mode*
- *XM channel mode*

\*1: These commands toggle the function on and off, so the command may not match your intended action.

**NOTE:**

Radio volume levels cannot be controlled using voice control.

**■ Disc commands**

- *Disc play*
- *Disc play track #* (#: 1 to 30)
- *Disc skip forward*
- *Disc skip back*
- *Disc track random*<sup>\*1</sup>
- *Disc track repeat*<sup>\*1</sup>
- *Disc track scan*<sup>\*1</sup>
- *Disc folder up*
- *Disc folder down*
- *Disc folder random*<sup>\*1</sup>
- *Disc folder repeat*<sup>\*1</sup>
- *Disc folder scan*<sup>\*1</sup>
- *Disc normal play*

\*1: These commands toggle the function on and off, so the command may not match your intended action.

■ **iPod® commands**

- *iPod play*
- *iPod play track # (#: 1 to 30)*
- *iPod skip forward*
- *iPod skip back*
- *iPod track shuffle*<sup>\*1</sup>
- *iPod album shuffle*<sup>\*1</sup>
- *iPod track repeat*<sup>\*1</sup>
- *iPod normal play*
- *What am I listening to?*
- *Who am I listening to?*
- *Who is this?*
- *What's playing?*
- *Who's playing?*
- *What album is this?*

\*1: These commands toggle the function on and off, so the command may not match your intended action.

■ **USB commands**

- *USB play*
- *USB play track # (#: 1 to 30)*
- *USB skip forward*
- *USB skip back*
- *USB track random*<sup>\*1</sup>
- *USB track repeat*<sup>\*1</sup>
- *USB track scan*<sup>\*1</sup>
- *USB folder up*
- *USB folder down*
- *USB folder random*<sup>\*1</sup>
- *USB folder repeat*<sup>\*1</sup>
- *USB folder scan*<sup>\*1</sup>
- *USB normal play*

\*1: These commands toggle the function on and off, so the command may not match your intended action.

■ **Bluetooth® Audio commands**

- *Bluetooth Audio play*
- *Bluetooth Audio skip forward*
- *Bluetooth Audio skip back*
- *Bluetooth Audio group up*
- *Bluetooth Audio group down*
- *Bluetooth Audio pause*
- *Bluetooth Audio resume*
- *Bluetooth Audio track random*
- *Bluetooth Audio track repeat*

**NOTE:**

*Bluetooth®* Audio commands may not work on some phones or *Bluetooth®* Audio devices.

■ **AUX commands**

- *Auxiliary play*

**■ Pandora® commands\***

The system accepts these commands while the Pandora® is playing.

- *Pandora play*
- *Pandora skip forward*
- *Pandora station up*
- *Pandora station down*
- *Pandora pause*
- *Pandora resume*
- *Pandora thumbs up*
- *Pandora thumbs down*

**■ Aha™ commands\***

The system accepts these commands while the Aha™ is playing.

- *Aha Radio play*
- *Aha Radio skip forward*
- *Aha Radio skip back*
- *Aha Radio station up*
- *Aha Radio station down*
- *Aha Radio resume*
- *Aha Radio pause*
- *Aha Radio like*
- *Aha Radio dislike*

**■ Internet service commands\***

- *Internet service play*
- *Internet service skip forward*\*<sup>1</sup>
- *Internet service skip back*\*<sup>1</sup>
- *Internet service station up*\*<sup>1</sup>
- *Internet service station down*\*<sup>1</sup>
- *Internet service resume*\*<sup>1</sup>
- *Internet service pause*\*<sup>1</sup>
- *Internet service like*\*<sup>1</sup>
- *Internet service dislike*\*<sup>1</sup>

\* 1: The system accepts these commands while the Internet service is playing.

\* Not available on all models

## ■ Keyboard Entry Commands

In keyboard screen, letters can be selected by saying each individual letter or by saying a keyword phrase. These keyword phrases are:

### ■ Letters

Say . . .	Or say . . .
A	Apple/Alpha
B	Boy/Bravo
C	Charlie
D	Dog/Delta
E	Edward/Echo
F	Frank/Foxtrot
G	George/Golf
H	Henry/Hotel
I	Igloo/India
J	John/Juliet
K	King/Kilo
L	Larry/Lima
M	Mary/Mike
N	Nancy/November
O	Oscar
P	Paul/Papa
Q	Queen/Quebec
R	Robert/Romeo
S	Sam/Sierra
T	Tom/Tango
U	Uncle/Uniform
V	Victor
W	William/Whiskey
X	X-ray
Y	Yellow/Yankee
Z	Zebra/Zulu

### ■ Numbers

Number . . .	Or say . . .
0	Zero
1	One
2	Two
3	Three
4	Four
5	Five
6	Six
7	Seven
8	Eight
9	Nine



**■ Symbols**

Symbol . . .	Or say . . .
-	<i>Hyphen</i>
!	<i>Exclamation point</i>
"	<i>Double Quote</i>
#	<i>Pound</i>
\$	<i>Dollar</i>
%	<i>Percent</i>
&	<i>Ampersand</i>
'	<i>Apostrophe</i>
(	<i>Open Parenthesis</i>
)	<i>Close Parenthesis</i>
~	<i>Tilde</i>
/	<i>Slash</i>
<	<i>Less than</i>
>	<i>Greater than</i>
{	<i>Open Brace</i>
}	<i>Close Brace</i>

**■ Accented letters**

Symbol . . .	Or say . . .
À	<i>A grave</i>
Â	<i>A circumflex</i>
Ä	<i>A umlaut</i>
Ç	<i>C cedilla</i>
È	<i>E grave</i>
É	<i>E acute</i>
Ê	<i>E circumflex</i>
Ë	<i>E umlaut</i>
Ì	<i>I grave</i>
Î	<i>I circumflex</i>
Ï	<i>I umlaut</i>
Ô	<i>O circumflex</i>
Ù	<i>U grave</i>
Û	<i>U circumflex</i>
Ü	<i>U umlaut</i>

**■ Punctuation marks**

Symbol . . .	Or say . . .
@	<i>At Sign</i>
^	<i>Caret</i>
*	<i>Asterisk</i>
_	<i>Underscore</i>
`	<i>Back Quote</i>
,	<i>Comma</i>
.	<i>Dot</i>
?	<i>Question mark</i>
:	<i>Colon</i>
;	<i>Semicolon</i>
+	<i>Plus</i>

## Playing AM/FM Radio

Features

**Audio/Information Screen** — Points to the top display area showing 'FM', 'Genre AAA', '97.9 MHz', 'Artist AAA', and 'Song AAA'.

**Audio with Touch Screen** — Points to the central touch-sensitive area of the screen.

**(Power) Button** — Points to the power button on the left side of the touch screen. Press to turn the audio system on and off.

**VOL (Volume) Knob** — Points to the physical volume knob on the left side of the unit. Turn to adjust the volume.

**Source** — Points to the 'Source' button on the touch screen. Select to change a band or change an audio source.

**Tune Up/Down Icons** — Points to the left and right arrow buttons on the touch screen. Select ◀ or ▶ to tune the radio frequency.

**More** — Points to the 'More...' button on the touch screen. Select to display the menu items.

**Skip/Seek Icons** — Points to the double left and double right arrow buttons on the touch screen. Select ◀◀ or ▶▶ to search up and down the selected band for a station with a strong signal.

**MENU Button** — Points to the 'MENU' button on the physical interface dial. Press to display the menu items.

**Interface Dial/ENTER Button** — Points to the central dial on the physical interface. Press and turn to tune the radio frequency. Move up, down, right and left to select secondary menu.

**BACK Button** — Points to the 'BACK' button on the physical interface. Press to go back to the previous display.

**Presets**  
Select to store a station.

Source	10	
97.9MHz	99.5MHz	99.1MHz
99.1MHz	106.1MHz	107.9MHz
Tune	More...	





To listen to a stored channel, select 1-6 (AM) or 1-12 (FM).

## Preset Memory

To store a station:

1. Tune to the selected station.

### Interface Dial

2. Press the **MENU** button.
3. Rotate  to select **Save Preset**, then press .
4. Rotate  to select the preset number you want to store that station, then press and hold .

### Audio with Touch Screen

2. Select **More**.
3. Select **Save Preset**.
4. Select the preset number you want to store that station.

## ▶▶ Playing AM/FM Radio

You can control the AM/FM radio using voice commands.

▶ **Voice Control Operation** P. 224

The **ST** indicator appears on the display indicating stereo FM broadcasts.  
Stereo reproduction in AM is not available.

Switching the Audio Mode

Press the **SOURCE** button on the steering wheel.

▶ **Audio Remote Controls** P. 168





You can also switch the mode by pressing the **MENU** button and selecting **Change Source** on the **Audio menu** screen.

You can store 6 AM stations and 12 FM stations into the preset memory.

## ■ Radio Data System (RDS)





Provides text data information related to your selected RDS-capable FM station.

### ■ To find an RDS station from Station List

1. Press the **MENU** button while listening to an FM station.
2. Rotate  to select **Station List**, then press .
3. Rotate  to select the station, then press .

### ■ Manual update

Updates your available station list at any time.

1. Press the **MENU** button while listening to an FM station.
2. Rotate  to select **Station List**, then press .
3. Rotate  to select **Refresh**, then press .

## ☒ Radio Data System (RDS)

When you select an RDS-capable FM station, the RDS automatically turns on, and the frequency display changes to the station name. However, when the signals of that station become weak, the display changes from the station name to the frequency.

## ■ Radio text

Display the radio text information of the selected RDS station.

1. Press the **MENU** button.
2. Rotate  to select **Radio Text**, then press .

## ■ Scan

Samples each of the strongest stations on the selected band for 10 seconds.

### Interface Dial

1. Press the **MENU** button.
  2. Rotate  to select **Scan**, then press .
- To turn off scan, press  to select **Cancel Scan**, or press the **BACK** button.

### Audio with Touch Screen

1. Select **More**.
  2. Select **Scan**.
- To turn off scan, select **Cancel Scan**.

### ▶▶ Radio text

The text indicator comes on when you received a text message. The indicator stays on until you read the message.

## Playing XM® Radio

**Audio/Information Screen** — Points to the top screen showing XM radio information: Genre AAA, CH 001 Channel AAA, Artist AAA, Title AAA, and a signal strength indicator.

**Audio with Touch Screen** — Points to the central touch screen area.

**(Power) Button** — Press to turn the audio system on and off.

**VOL (Volume) Knob** — Turn to adjust the volume.

**Source** — Select to change an audio source.

**Category Up/Down Icons** — Select ◀ or ▶ to display and select an XM® Radio category.

**More** — Select to display the menu items.

**Skip/Seek Icons** — Select |◀◀ or ▶▶| to the previous or next channel.

**MENU Button** — Press to display the menu items.

**Interface Dial/ENTER Button** — Press and turn to tune the radio frequency. Move up, down, right and left to select secondary menu.

**Presets**  
Select to store a station.

To listen to a stored channel, select 1-12.

**BACK Button** — Press to go back to the previous display.









## To Play the XM® Radio

1. Select the XM® mode.

➤ **Audio Remote Controls** P. 168

➤ **Audio with Touch Screen** P. 216

### Interface Dial

2. Press the **MENU** button.
3. Rotate  to select **XM Tune Mode**, then press .
4. Rotate  to select **Channel Mode** or **Category Mode**, then press .
5. Rotate  to select **Channel List**, then press .
6. Rotate  to select a channel from a list, then press .

### Audio with Touch Screen

2. Select **More**.
3. Select **Tune Mode**.
4. Select **CH Channel Mode** or **CAT Category Mode**.
5. Select a channel using the , , ,  icons on the tune mode screen or the preset numbers (**1-12**) on the preset mode screen.

### ▶▶ Playing XM® Radio

You can control the XM® radio using voice commands.

➤ **Voice Control Operation** P. 224

In the channel mode, all available channels are selectable. In the category mode, you can select a channel within a category (Jazz, Rock, Classical, etc.).





There may be instances when XM® Radio does not broadcast all the data fields (artist name, title). This does not indicate a problem with your audio system.

## ■ Preset Memory

To store a station:

1. Tune to the selected station.

### Interface Dial

2. Press the **MENU** button.
3. Rotate  to select **Save Preset**, then press .
4. Rotate  to select the preset number you want to store that station, then press and hold .

### Audio with Touch Screen

2. Select **More**.
3. Select **Save Preset**.
4. Select the preset number you want to store that station.

## ▶▶ Playing XM® Radio

You can store 12 XM® stations into the preset memory.



## Playing a CD

Your audio system supports audio CDs, CD-Rs and CD-RWs in either MP3, WMA, or AAC\*1 format. With the CD loaded, select the CD mode.

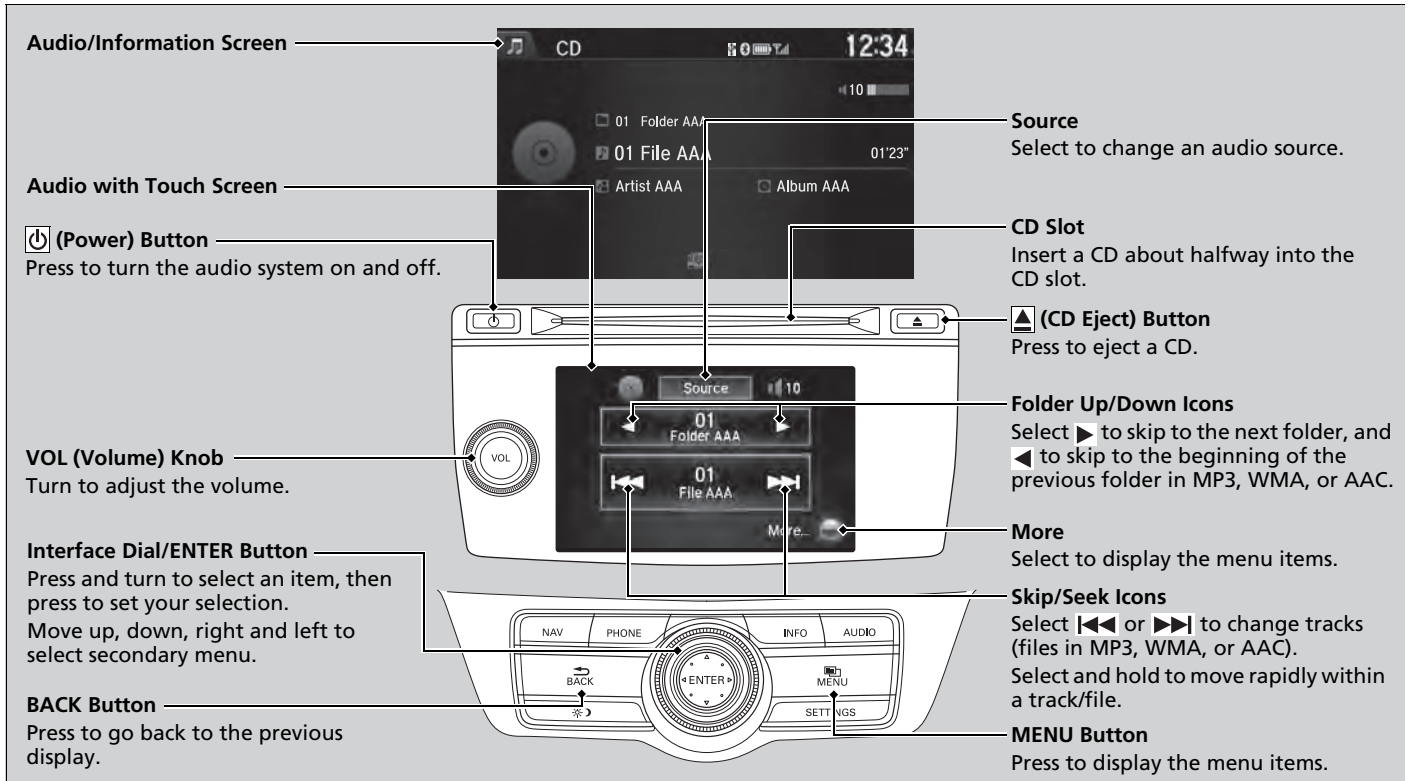

\*1: Only AAC format files recorded with iTunes® are playable on this unit.

## How to Select a File from the Music Search List (MP3/WMA/AAC)

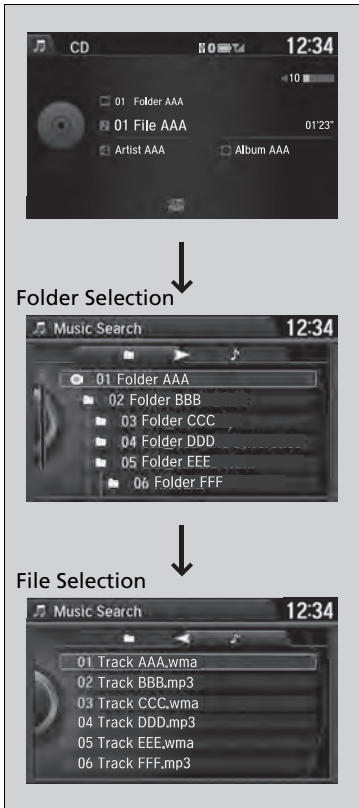

1. Press the **MENU** button.
2. Rotate to select **Music Search**, then press .
3. Rotate , move or , then press to select a file from the **Music Search** list.

## ▶▶ Playing a CD

### NOTICE

Do not use CDs with adhesive labels. The label can cause the CD to jam in the unit.

WMA files protected by digital rights management (DRM) cannot be played. The audio system displays **Unplayable File**, then skips to the next file.

Text data appears on the display under the following circumstances:

- When you select a new folder, file, or track.
- When you change the audio mode to CD.
- When you insert a CD.

If you eject the CD but do not remove it from the slot, the system reloads the CD automatically after several seconds.

You can control a CD audio using voice commands.  
**Voice Control Operation** P. 224





## How to Select a Play Mode

You can select scan, repeat, and random modes when playing a track or file.



Random/Repeat is selected.

### Interface Dial

1. Press the **MENU** button.
2. Rotate  to select **Scan** or **Random/Repeat**, then press .
3. Rotate  to select a mode, then press .

### Audio with Touch Screen

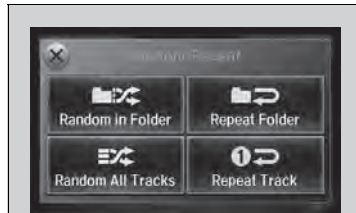

1. Select **More**.
2. Select **Scan** or **Random/Repeat**.
3. Select a mode.



Random/Repeat is selected.

## To turn off a play mode

### Interface Dial

1. Press the **MENU** button.
2. Rotate  to select the mode you want to turn off, then press .

### Audio with Touch Screen

1. Select **More**.
2. Select the mode you want to turn off.

## How to Select a Play Mode

### Play Mode Menu Items

#### Scan

**Scan Folders (MP3/WMA/AAC):** Provides 10-second sampling of the first file in each of the main folders.

**Scan Tracks:** Provides 10-second sampling of all tracks on the CD (all files in the current folder in MP3, WMA, or AAC).

#### Random/Repeat

**Repeat Folder (MP3/WMA/AAC):** Repeats all files in the current folder.

**Repeat Track:** Repeats the current track/file.

**Random in Folder (MP3/WMA/AAC):** Plays all files in the current folder in random order.

**Random All Tracks:** Plays all tracks/files in random order.

## Playing Hard Disc Drive (HDD) Audio

The Hard Disc Drive (HDD) Audio function plays tracks from music CDs that have been recorded onto the built-in HDD. You can arrange the tracks in playlists or play the tracks using various search methods.

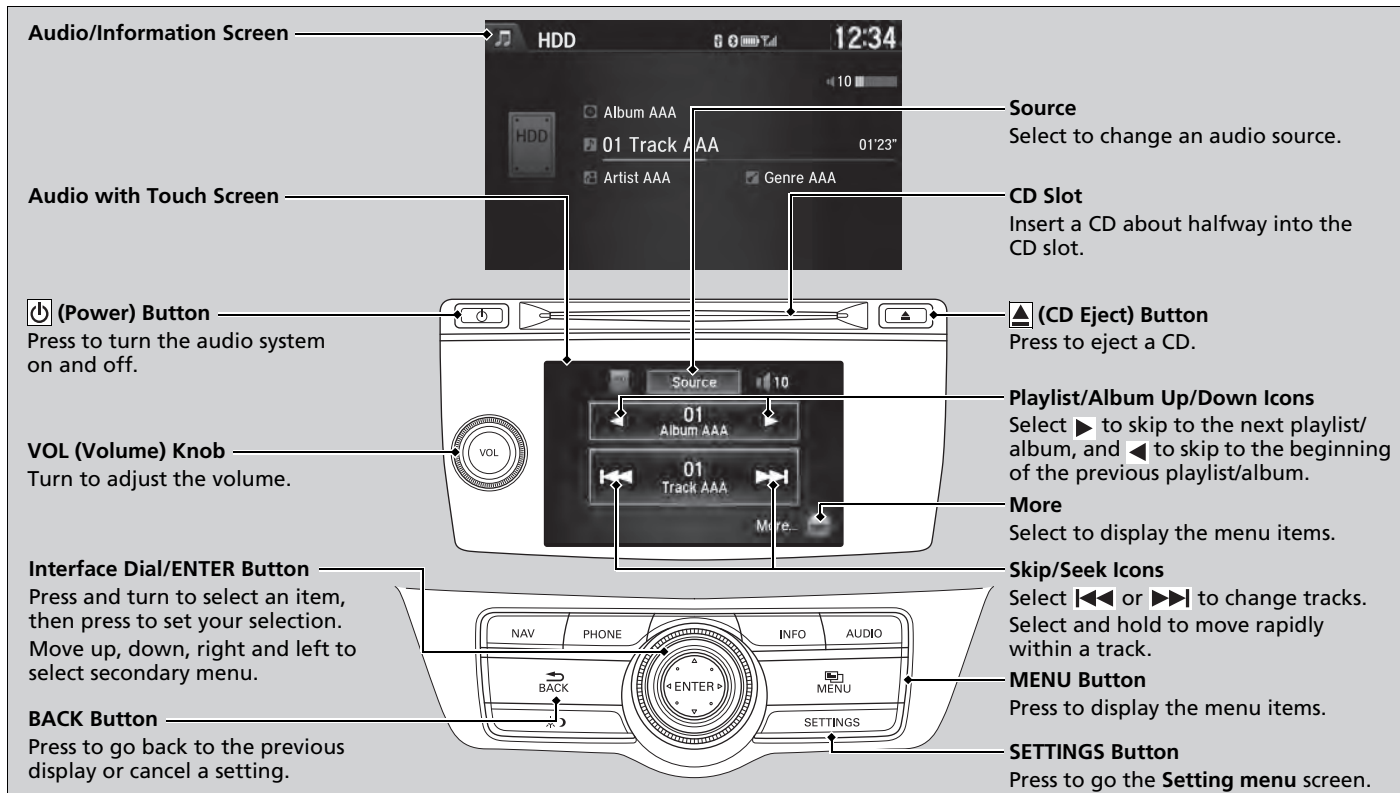

## Recording a Music CD to HDD

The songs on music CDs are automatically recorded by factory default to the HDD the first time you play each disc. You can then play the songs directly from the HDD.

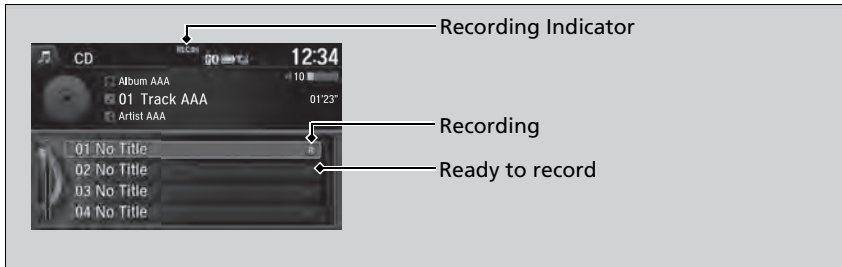

## Stop Recording

1. Press the **MENU** button.
2. Rotate to select **Cancel Record to HDD**, then press .

## Recording a CD Manually

1. Press the **MENU** button.
2. Rotate to select **Rec to HDD**, then press .

### Recording a Music CD to HDD

You can add tracks to user playlists, where you can mix and match tracks from other CDs recorded on the HDD.

- ▶ **Editing an Album or Playlist** P. 246
- ▶ **Editing Track Information** P. 249

If you stop the engine or the power system is turned off while recording a CD, there may be pauses between songs when you play back from the HDD.

Repeat, random, and scan functions are not available during recording.

You can play music from other sources (e.g., XM, HDD, etc.) while recording.

Please note that there is no compensation offered in the case of unsuccessful recording of audio data or the loss of audio data due to any cause whatsoever.

### Clearing the HDD

Any music tracks stored on the HDD can be deleted.

- ▶ **Deleting all HDD Data** P. 317

### Recording a CD Manually

Use this feature to set up the music search abilities when using Song By Voice™ (SBV) commands.

## ■ How to Select a Track from the Music Search List

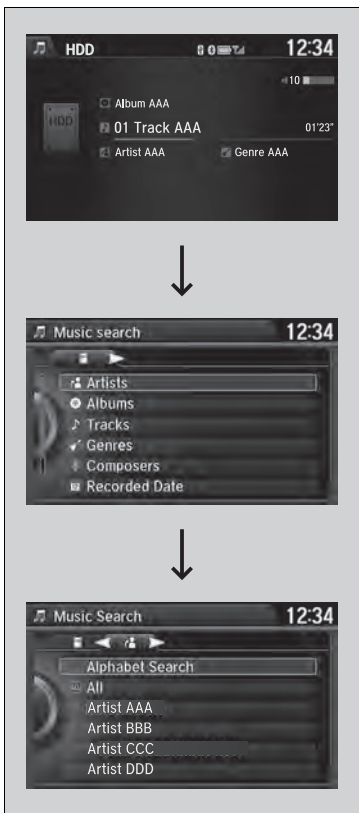

1. Press the **MENU** button.
2. Rotate to select **Music Search**, then press .
3. Rotate , move or , then press to select a track from the **Music Search** list.
  - ▶ Title information is displayed if found in the Gracenote® Album Info (Gracenote® Media Database) stored on the HDD.
  - ▶ The HDD has two types of playlists: original playlists and user playlists. An original playlist is automatically created for each album when a music CD is recorded. You can customize up to six user playlists provided on the HDD by adding tracks from your original playlists.

## ▶▶ How to Select a Track from the Music Search List

You can control the HDD audio using voice commands.

- ▶ **Voice Control Operation** P. 224
- ▶ **Song By Voice™ (SBV)** P. 256

Music tracks recorded on HDD cannot be recorded onto CDs or other devices.

Tracks are recorded at four times the playback speed using ultra-efficient compression technology; therefore, sound quality may vary slightly from the original.

If the HDD is ever replaced, all music data is lost and cannot be recovered.

If there is a problem, you may see an error message on the display.



- ▶ **Hard Disc Drive (HDD) Audio** P. 270

## How to Select a Play Mode

You can select scan, repeat, and random modes when playing a track.



### Interface Dial

1. Press the **MENU** button.
2. Rotate  to select **Scan** or **Random/Repeat**, then press .
3. Rotate  to select a mode, then press .



### Audio with Touch Screen

1. Select **More**.
2. Select **Scan** or **Random/Repeat**.
3. Select a mode.



## To turn off a play mode

### Interface Dial

1. Press the **MENU** button.
2. Rotate  to select the mode you want to turn off, then press .

### Audio with Touch Screen

1. Select **More**.
2. Select the mode you want to turn off.

## How to Select a Play Mode

### Play Mode Menu Items

#### Scan

**Scan Albums:** Provides 10-second sampling of the first track in each album.

**Scan Tracks:** Provides 10-second sampling of all tracks on HDD.

#### Random/Repeat

**Repeat Album:** Repeats all tracks in the current album.

**Repeat Track:** Repeats the current track.

**Random in Album:** Plays all tracks in the current album in random order.

**Random All Tracks:** Plays all tracks in random order.

## ■ Editing an Album or Playlist

Change the playlist name, album name, genre, and track order of the current playlist. You can also delete tracks, playlists, and albums.

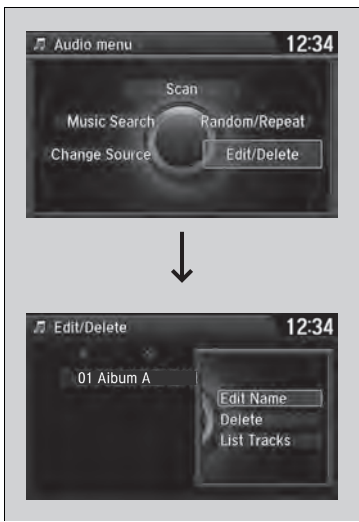

### ■ Editing an album

1. Press the **MENU** button.
2. Rotate to select **Edit/Delete**, then press .
3. Rotate to select **Albums**, then press .
  - ▶ The pop-up menu appears on the screen.
4. To edit an album name:
  - Rotate to select **Edit name**, then press .
  - ▶ Enter the name using the interface dial or the audio with touch screen.

To delete an album:

Rotate to select **Delete**, then press .

To edit track information or delete a track:

Rotate to select **List Tracks**, then press .

➤ **Editing Track Information** P. 249

### ➤ Editing an Album or Playlist

The maximum number of songs in each of the six user playlists is 999. Adding new songs overwrites the oldest songs.

The maximum number of original playlists is 999 with a maximum of 99 songs in each playlist.

Each album CD counts as an original playlist. Adding a track from a user playlist into the same user playlist will cause the track to appear twice in the playlist.







Deleting an album (original playlist) also deletes the album tracks you have stored in any user playlists.

Deleting a user playlist or deleting all tracks from a user playlist does not remove the playlist folder. The folder retains the playlist name and artist information.





## ■ Editing a playlist

1. Press the **MENU** button.
2. Rotate  to select **Edit/Delete**, then press .
3. Rotate  to select **Playlists**, then press .
  - ▶ The pop-up menu appears on the screen.
4. To edit a playlist name:
  - Rotate  to select **Edit name**, then press .
  - ▶ Enter the name using the interface dial or the audio with touch screen.

To delete a playlist:

Rotate  to select **Delete**, then press .





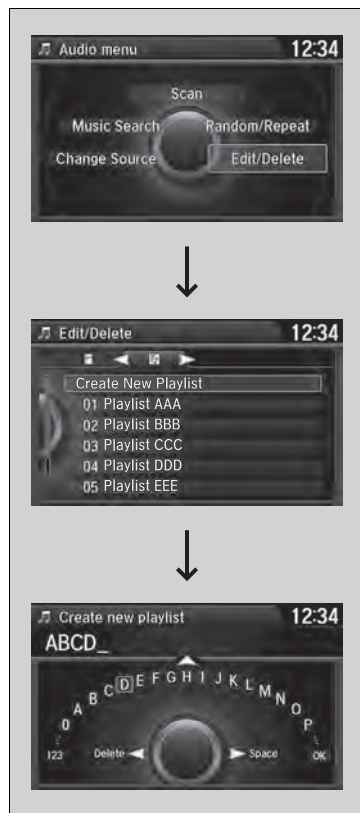

To edit track information or delete a track:

Rotate  to select **List Tracks**, then press .

➤ **Editing Track Information** P. 249



### ■ Creating a new playlist

1. Press the **MENU** button.
2. Rotate  to select **Edit/Delete**, then press .
3. Rotate  to select **Playlists**, then press .
4. Rotate  to select **Create New Playlist**, then press .
  - ▶ Enter the name using the interface dial or the audio with touch screen, then select tracks from the **Music Search** list.

## Editing Track Information

Change the track title, artist name, genre and composer. You can also delete tracks.

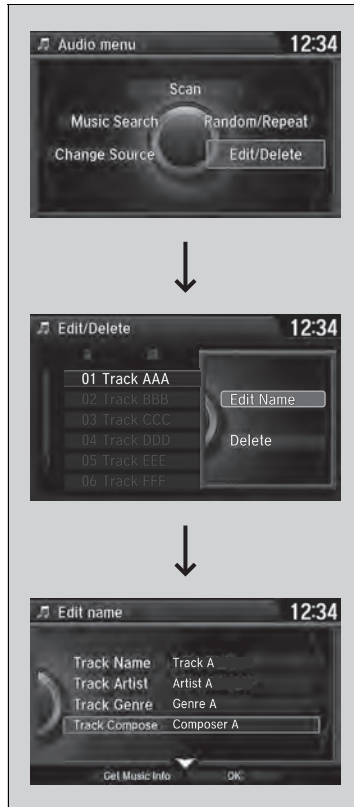

1. Press the **MENU** button.
2. Rotate to select **Edit/Delete**, then press .
3. Rotate to select **Tracks**, then press .
4. Rotate to select a track you want to edit or delete, then press .
  - ▶ The pop-up menu appears on the screen.
5. To edit track information:
  - Rotate to select **Edit name**, then press .
  - ▶ Enter the track name, track artist, etc. using the interface dial or the audio with touch screen. Move , rotate to select **OK**, then press .









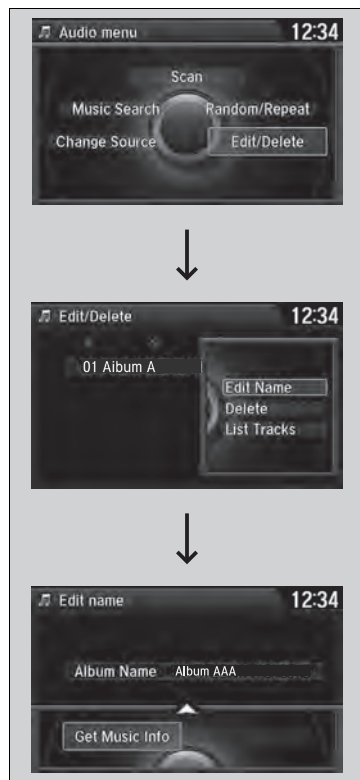

To delete a track:

Rotate to select **Delete**, then press .

## ■ Displaying Music Information

Music information (album name, artist name, genre) can be acquired by accessing the Gracenote® Album Info.



1. Press the **MENU** button.
2. Rotate  to select **Edit/Delete**, then press .
3. Rotate  to select **Albums**, then press .
4. Rotate  to select an album you want to edit, then press .
  - ▶ The pop-up menu appears on the screen.
5. Rotate  to select **Edit name**, then press .
6. Move  to select **Get Music Info**, then press .
  - ▶ The system starts to access the Gracenote® Album Info.

## Updating Gracenote® Album Info

Update the Gracenote® Album Info (Gracenote® Media Database) that is included with the navigation system.

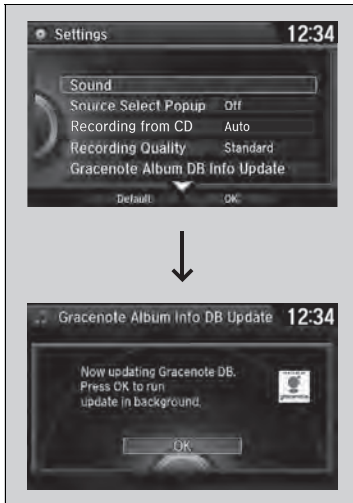

1. Insert the update disc into the disc slot or connect the USB flash drive that includes the update.
2. Press the **SETTINGS** button in the HDD mode.
3. Rotate to select **Audio Settings**, then press .
  - ▶ Repeat the procedure to select **Gracenote Album DB Info Update**.
4. Rotate to select **Update from CD** or **Update from USB**, then press .
  - ▶ The system starts updating and the confirmation message appears on the screen. Press to finish.

### Updating Gracenote® Album Info

To acquire updated files:

- Consult a dealer.
- U.S.: Visit [automobiles.honda.com](http://automobiles.honda.com).
- Canada: Visit [www.hondanavi.ca](http://www.hondanavi.ca).

Once you perform an update, any information you edited before will be overwritten or erased.

## Playing an iPod®

Connect the iPod® using your dock connector to the USB adapter cable, then select the iPod mode.

➔ **USB Adapter Cable** P. 165

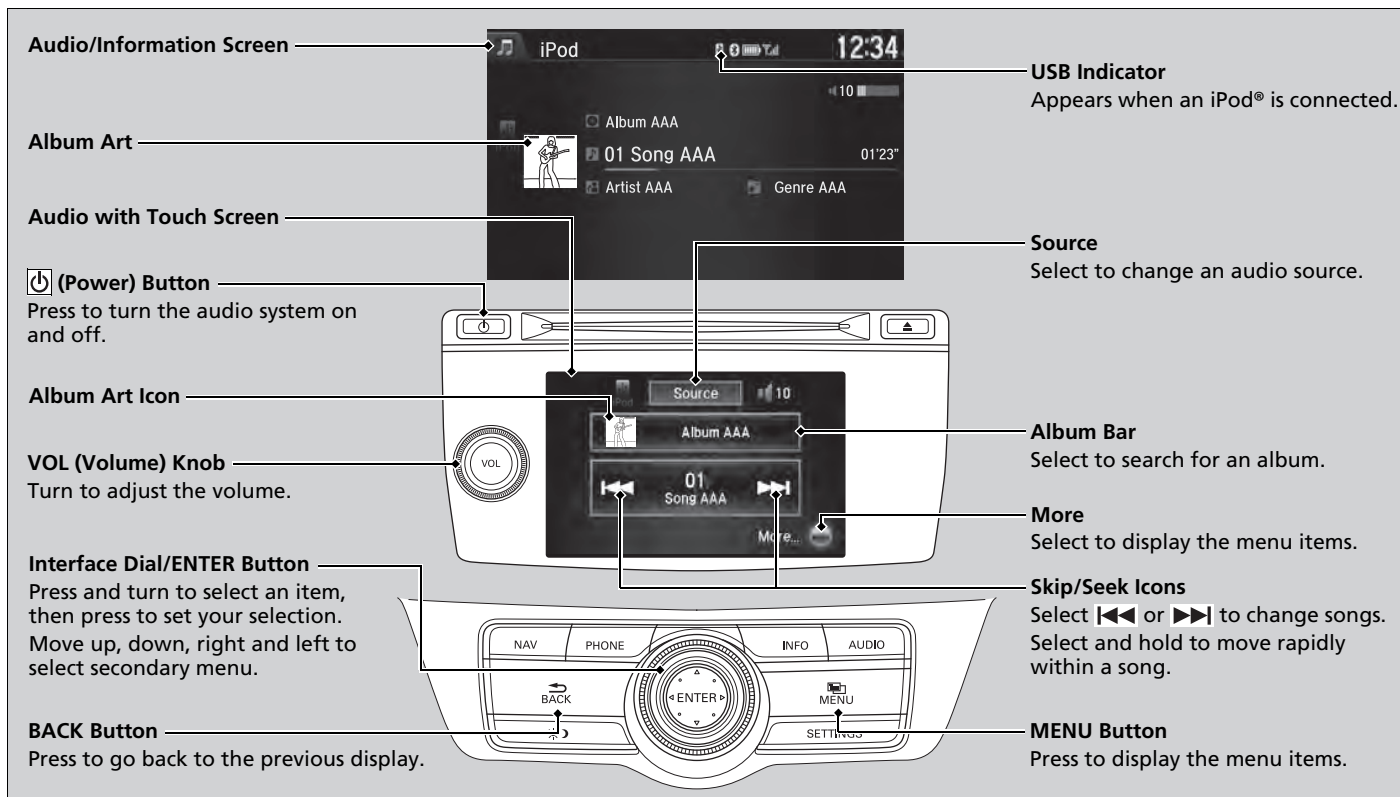

## How to Select an Album

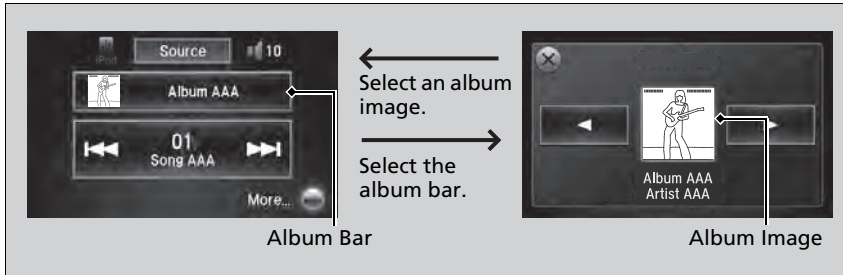

1. Select the album bar.
  - ▶ The image of the current album is displayed.
2. Select ◀ or ▶ icon to search for an album.
  - ▶ When the album image you are looking for appears, select it to play.

### How to Select an Album

You cannot select an album while the vehicle is moving.

Select  to go back to the previous screen.

## How to Select a Song from the Music Search List



1. Press the **MENU** button.
2. Rotate to select **Music Search**, then press .
3. Rotate , move or , then press to select a song from the **Music Search** list.

## How to Select a Song from the Music Search List

You can control an iPod® using voice commands.

▶ **Voice Control Operation** P. 224

▶ **Song By Voice™ (SBV)** P. 256

Available operating functions vary on models or versions. Some functions may not be available on the vehicle's audio system.

If there is a problem, you may see an error message on the audio/information screen.

▶ **iPod®/USB Flash Drive** P. 271







## How to Select a Play Mode

You can select repeat and shuffle modes when playing a file.



### Interface Dial

1. Press the **MENU** button.
2. Rotate  to select **Shuffle/Repeat**, then press .
3. Rotate  to select a mode, then press .



### Audio with Touch Screen

1. Select **More**.
2. Select **Shuffle/Repeat**.
3. Select a mode.



## To turn off a play mode

### Interface Dial

1. Press the **MENU** button.
2. Rotate  to select the mode you want to turn off, then press .

### Audio with Touch Screen

1. Select **More**.
2. Select the mode you want to turn off.

## How to Select a Play Mode

### Play Mode Menu Items

**Repeat Song:** Repeats the current track.

**Shuffle Albums:** Plays all available albums in a selected list (playlists, artists, albums, songs, genres, or composers) in random order.





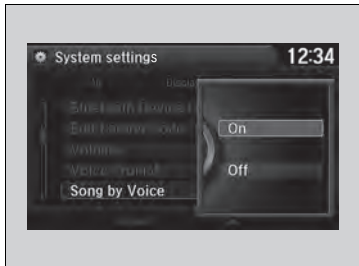

**Shuffle All Songs:** Plays all available files in a selected list (playlists, artists, albums, songs, genres, or composers) in random order.

## Song By Voice™ (SBV)

Use SBV to search for and play music from your HDD or iPod® using voice commands.

### ■ To enable SBV



1. Press the **SETTINGS** button.
2. Rotate  to select **System Settings**, then press .
3. Rotate  to select **Song by Voice**, then press .
4. Rotate  to select **On** or **Off**, then press .



### ☒ Song By Voice™ (SBV)

Setting options:

- **On** (factory default): Song By Voice commands are available.
- **Off**: Disable the feature.

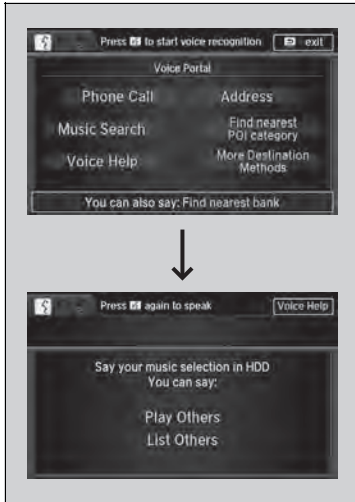
## ■ Searching for music using SBV



1. Set the **Song by Voice setting** to **On**.
2. Press the  (Talk) button and say "Music Search" to activate the SBV feature for the HDD and iPod®.
3. Press the  button and say a command.
  - ▶ Example 1: Say "(List) 'Artist A'" to view a list of songs by that artist. Select the desired song to start playing.
  - ▶ Example 2: Say "Play 'Artist A'" to start playing songs by that artist.
4. To cancel SBV, press the  (hang-up/back) button on the steering wheel. The selected song continues playing.

Once you have canceled this mode, you need to press the  button and say "Music Search" again to re-activate this mode.

### ▶▶ Searching for music using SBV

Song By Voice™ Commands List

▶ **Song By Voice™ commands** P. 226

NOTE:

Song By Voice™ commands are available for tracks stored on the HDD or iPod®.

You can add phonetic modifications of difficult words so that it is easier for SBV to recognize artists, songs, albums, and composers in voice commands.

▶ **Phonetic Modification** P. 258

Continued

## ■ Phonetic Modification

Add phonetic modifications of difficult or foreign words so that it is easier for SBV to recognize artists, songs, albums, and composers in voice commands when searching for music on the HDD or iPod®.











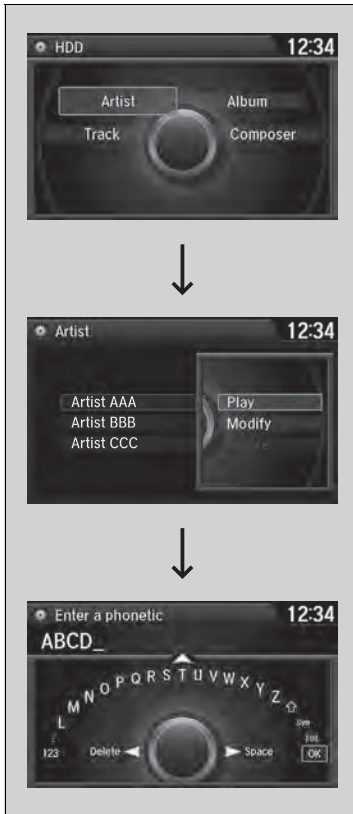



1. Press the **SETTINGS** button.
2. Rotate to select **System Settings**, then press .
3. Rotate to select **Song by Voice Phonetic Modification**, then press .
4. Move and rotate to select **New Modification**, then press .
5. Rotate to select **HDD** or **iPod**, then press .

### ▶▶ Phonetic Modification

Phonetic Modification is grayed out when Song By Voice is set to **Off**.

You can store up to 2,000 phonetic modification items.



6. Rotate  to select the item to modify (e.g., **Artist**), then press .
  - ▶ The list of the selected item appears on the screen.
7. Rotate  to select an entry (e.g., **No Name**), then press .
  - ▶ The pop-up menu appears on the screen.
  - ▶ The listen to the current phonetic modification, rotate  to select **Play**, then press .
  - ▶ To delete the current phonetic modification, rotate  to select **Delete**, then press .
8. Rotate  to select **Modify**, then press .
9. Enter the phonetic spelling you wish to use (e.g., "Artist A") when prompted.
10. Move  to select **OK** to exit.
  - ▶ The artist "No Name" is phonetically modified to "Artist A." When in the SBV mode, you can press the  (Talk) button and use the voice command "Play 'Artist A'" to play songs by the artist "No Name."

**U.S. models**

**Compatible phones only**

## Playing Internet Radio

Connect a compatible phone through *Bluetooth*®.

**iPhone**

You can also connect the phone using your dock connector to the USB adapter cable.

Select **Source** to select Pandora or Aha mode.

▶▶ Playing Internet Radio

Pandora®, the Pandora logo, and the Pandora trade dress are trademarks or registered trademarks of Pandora Media, Inc., used with permission. Pandora is currently available exclusively in the United States.

Features

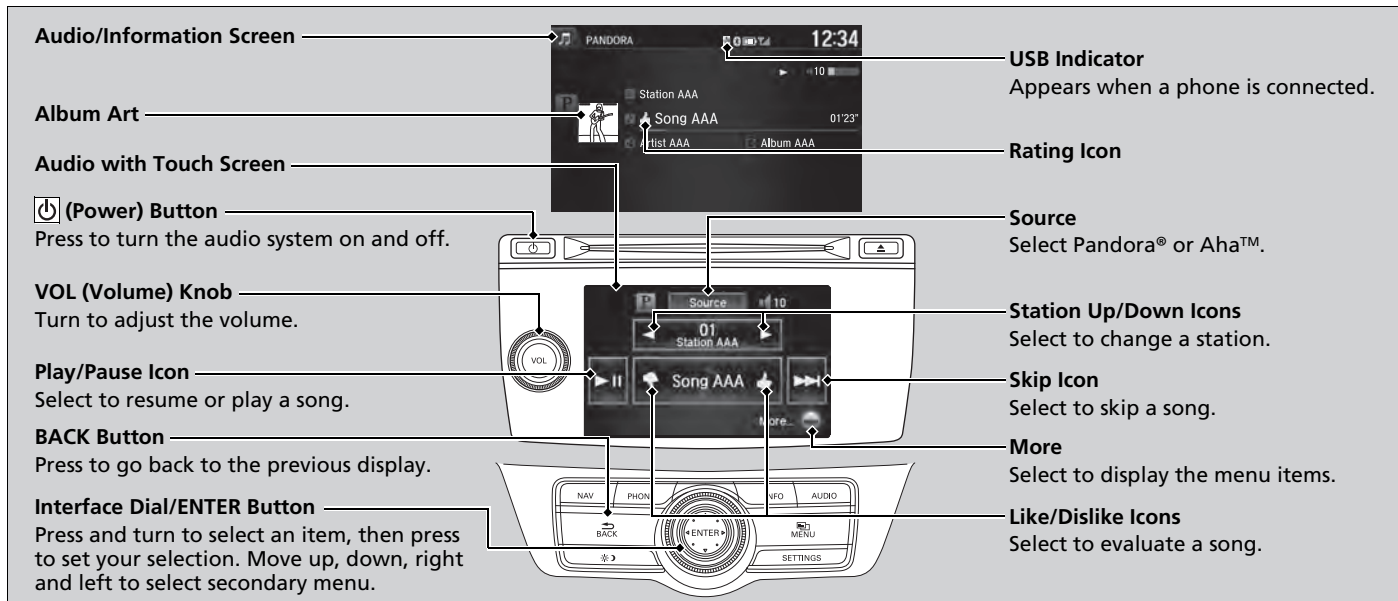

## Pandora® Menu

You can operate some of the Pandora® menu items from your vehicle's audio system. The available items are:

- Skip Forward
- Play/Pause
- Station List
- Like
- Dislike
- Bookmark This Song
- Bookmark This Artist
- Change Source

### ■ Operating a menu item

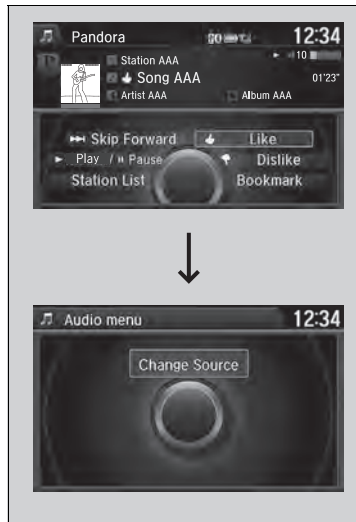

The menu items are shown in the lower half of the audio/information screen.

Rotate to select an item and press .

To select **Change Source**, press the **MENU** button, then press .

### ▶▶ Playing Internet Radio

To find out if your phone is compatible with this feature, visit [www.handsfreelink.honda.com](http://www.handsfreelink.honda.com), or call (888) 528-7876.

Pandora® is a personalized Internet radio service that selects music based on an artist, song, or genre a user enters, and streams what is likely to be of interest.

To use this service in your vehicle, the Pandora® app must first be installed on your phone. Visit [www.pandora.com](http://www.pandora.com) for more information.

If you cannot operate Pandora® through the audio system, it may be streaming through *Bluetooth®* Audio. Make sure Pandora® mode on your audio system is selected.

### ▶▶ Pandora® Menu

You can control Pandora® using voice commands.

#### ▶▶ Voice Control Operation P. 224

Available operating functions vary on software versions. Some functions may not be available on the vehicle's audio system.

If there is a problem, you may see an error message on the audio/information screen.

#### ▶▶ Pandora®\* P. 273

There are restrictions on the number of songs you can skip or dislike in a given hour.

## Aha™ Menu

You can operate some of the Aha™ menu items from your vehicle's audio system. The available items are:

- Like
- Dislike
- Play/Pause
- 15sec Back
- 30sec Skip
- View text
- View list
- Reply
- Change Source
- Stations

### Operating a menu item



The menu items are shown in the lower half of the audio/information screen.

Rotate to select an item and press .

To select **Change Source** or **Stations**, press the **MENU** button, then press .

## Aha™ Menu

Aha™ by Harman is a cloud-based service that organizes your favorite web content into live radio stations. You can access podcasts, internet radio, location-based services, and audio updates from social media sites.

You can control Aha™ Radio using voice commands.

**Voice Control Operation** P. 224

Available operating functions vary on software versions. Some functions may not be available on the vehicle's audio system.

If there is a problem, you may see an error message on the audio/information screen.

**Aha™\*** P. 275

The menu items vary depending on the station you selected.

To use this service in your vehicle, the HondaLink app must be installed on your phone. Visit [owners.honda.com/apps](http://owners.honda.com/apps) for more information.

You must have a previously set up Aha account prior to using the service in your vehicle. Visit [www.aharadio.com](http://www.aharadio.com) for more information.



## Playing a USB Flash Drive

Your audio system reads and plays sound files on a USB flash drive in either MP3, WMA, or AAC\*1 format.

Connect your USB flash drive to the USB adapter cable, then select the USB mode.

🔌 **USB Adapter Cable** P. 165

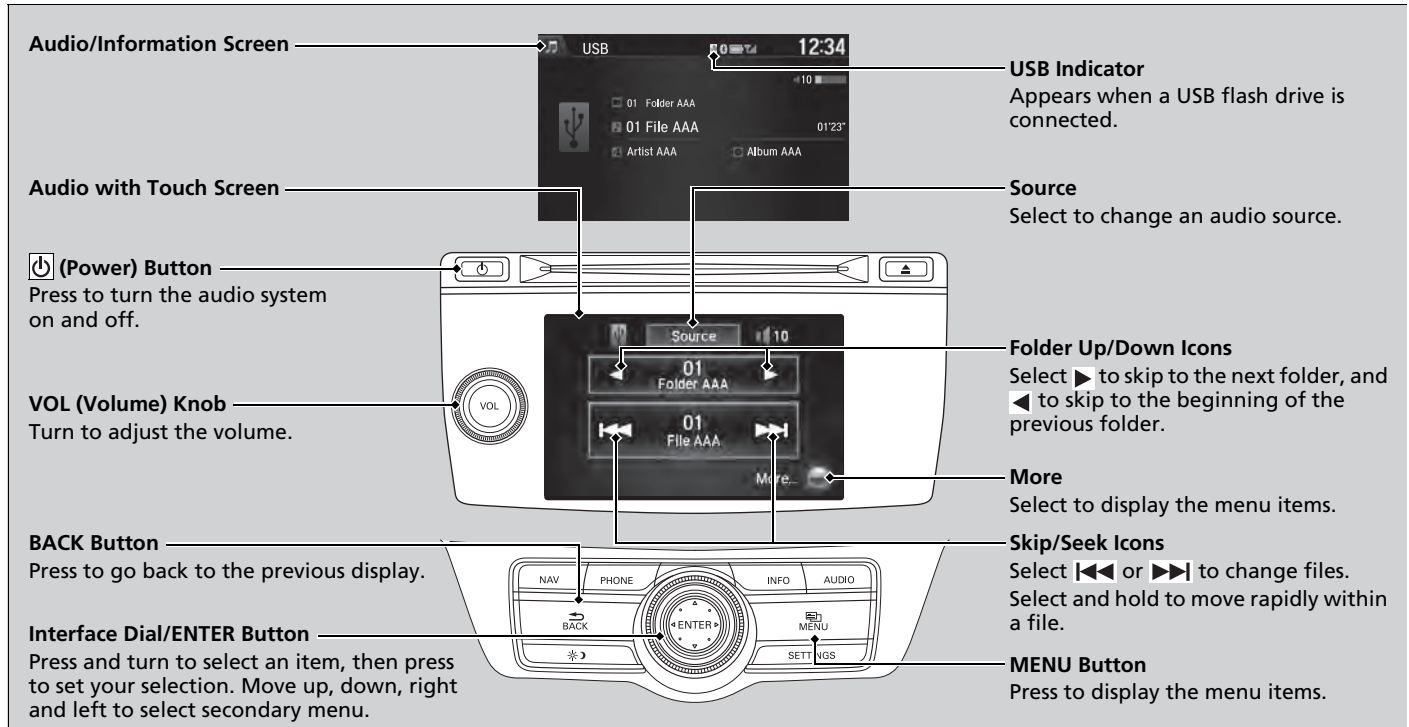

\*1: Only AAC format files recorded with iTunes® are playable on this unit.

## How to Select a File from the Music Search List

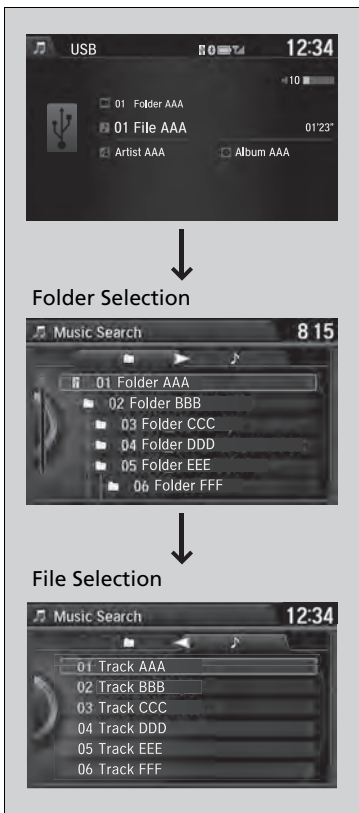

1. Press the **MENU** button.
2. Rotate to select **Music Search**, then press .
3. Rotate , move or , then press to select a file from the **Music Search** list.

## ▶▶ Playing a USB Flash Drive

You can control a USB flash drive using voice commands.

**Voice Control Operation** P. 224

Use the recommended USB flash drives.

**USB Flash Drives** P. 280

Files in WMA format protected by digital rights management (DRM) are not played.

The audio system displays **Unplayable File**, and then skips to the next file.

If there is a problem, you may see an error message on the audio/information screen.

**iPod®/USB Flash Drive** P. 271





## How to Select a Play Mode

You can select scan, repeat, and random modes when playing a file.



Random/Repeat is selected.

### Interface Dial

1. Press the **MENU** button.
2. Rotate  to select **Scan** or **Random/Repeat**, then press .
3. Rotate  to select a mode, then press .

### Audio with Touch Screen

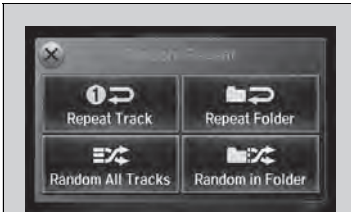

1. Select **More**.
2. Select **Random/Repeat**.
3. Select a mode.



Random/Repeat is selected.

## To turn off a play mode

### Interface Dial

1. Press the **MENU** button.
2. Rotate  to select the mode you want to turn off, then press .

### Audio with Touch Screen

1. Select **More**.
2. Select the mode you want to turn off.

## How to Select a Play Mode

### Play Mode Menu Items

#### Scan

**Scan Folders:** Provides 10-second sampling of the first file in each of the main folders.

**Scan Tracks:** Provides 10-second sampling of all files in the current folder.

#### Random/Repeat

**Repeat Folder:** Repeats all files in the current folder.

**Repeat Track:** Repeats the current file.

**Random in Folder:** Plays all files in the current folder in random order.

**Random All Tracks:** Plays all files in random order.

## Playing *Bluetooth*® Audio

Your audio system allows you to listen to music from your *Bluetooth*®-compatible phone.

This function is available when the phone is paired and connected to the vehicle's *Bluetooth*® HandsFreeLink® (HFL) system.

📄 **Phone Setup** P. 373

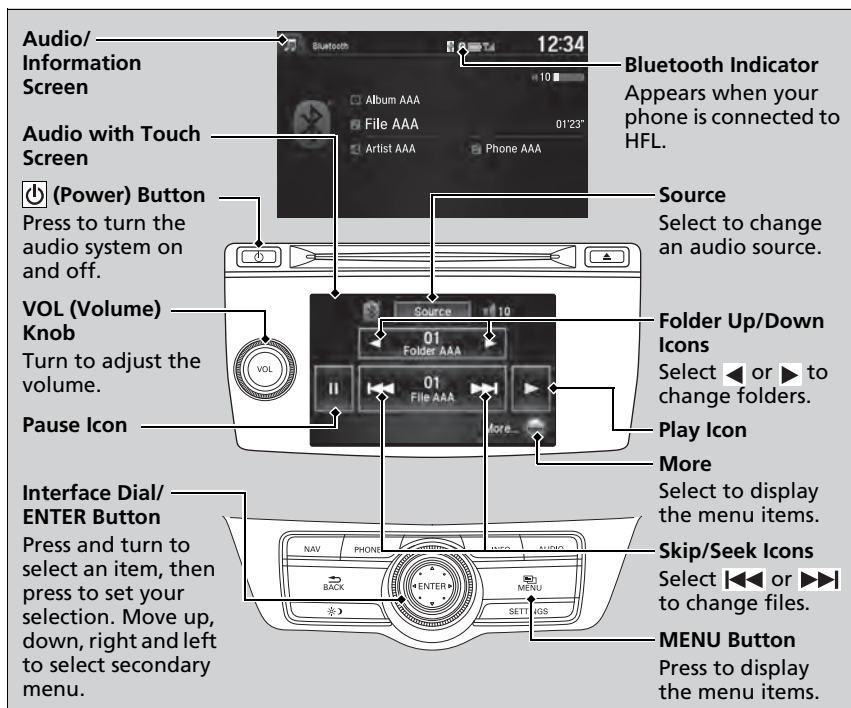

### ▶▶ Playing *Bluetooth*® Audio

Not all *Bluetooth*-enabled phones with streaming audio capabilities are compatible with the system. For a list of compatible phones:

- U.S.: Visit [www.handsfreelink.honda.com](http://www.handsfreelink.honda.com), or call 1-888-528-7876.
- Canada: Visit [www.handsfreelink.ca](http://www.handsfreelink.ca), or call 1-888-528-7876.

In some states, it may be illegal to perform some data device functions while driving.

If more than one phone is paired to the HFL system, there will be a delay before the system begins to play.

You can control *Bluetooth*® Audio using voice commands.

📄 **Voice Control Operation** P. 224

## To Play *Bluetooth*® Audio Files





1. Make sure that your phone is paired and connected to HFL.
2. Select the *Bluetooth*® Audio mode.

If the phone is not recognized, another HFL-compatible phone, which is not compatible for *Bluetooth*® Audio, may already be connected.

## To pause or resume a file

### Interface Dial

1. Press the **MENU** button.
2. Rotate  to select **Play** or **Pause**, then press .

### Audio with Touch Screen

Select the play icon or pause icon.

## Switching to HFL

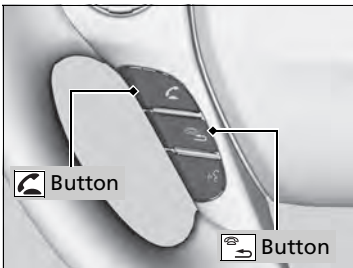

Press the  (pick-up) button on the steering wheel to receive a call when *Bluetooth*® Audio is playing.

 **Bluetooth**® HandsFreeLink® P. 367

Press the  (hang-up/back) button to end the call and return to *Bluetooth*® Audio.

## To Play *Bluetooth*® Audio Files

To play the audio files, you may need to operate your phone. If so, follow the phone maker's operating instructions.

The pause function may not be available on some phones.

Switching to another mode pauses the music playing from your phone.



## Switching to HFL

If you receive a call while *Bluetooth*® Audio is in the pause mode, it will resume play after ending the call.



## CD Player

If a disc error occurs, you may see the following error messages.

Audio system without touch screen

Error Message	Cause	Solution
<b>HEAT ERROR</b>	High temperature	<ul style="list-style-type: none"><li>• Turn the audio system off and allow the player to cool down until the error message is cleared.</li></ul>
<b>UNSUPPORTED</b>	Track/file format not supported	<ul style="list-style-type: none"><li>• Current track/file will be skipped. The next supported track/file plays automatically.</li></ul>
<b>BAD DISC PLEASE CHECK OWNERS MANUAL PUSH EJECT</b>	Mechanical error	<ul style="list-style-type: none"><li>• Press the  (eject) button and remove the disc, and check that the error message is cleared.</li><li>• Check that the disc is not damaged or deformed, and insert the disc again.<ul style="list-style-type: none"><li>➤ <b>Protecting CDs</b> P. 278</li></ul></li><li>• If the error message reappears, press the  button, and pull out the disc.</li><li>• Insert a different disc. If the new disc plays, there is a problem with the first disc.</li><li>• If the error message repeats, or the disc cannot be removed, contact your dealer. Do not try to force the disc out of the player.</li></ul>
<b>MECH ERROR</b>		
<b>CHANGER ERROR</b>		
<b>CHECK DISK LOAD</b>		
<b>BAD DISC PLEASE CHECK OWNERS MANUAL</b>	Servo error	<ul style="list-style-type: none"><li>• If the error message repeats, or the disc cannot be removed, contact your dealer. Do not try to force the disc out of the player.</li></ul>
<b>CHECK DISC</b>	Disc error	<ul style="list-style-type: none"><li>• Check that the disc is not damaged or deformed.<ul style="list-style-type: none"><li>➤ <b>Protecting CDs</b> P. 278</li></ul></li></ul>

## Audio system with touch screen

Error Message	Cause	Solution
<b>Unplayable File</b>	Track/file format not supported	<ul style="list-style-type: none"> <li>• Current track/file will be skipped. The next supported track/file plays automatically.</li> </ul>
<b>Bad Disc Please Check Owner's Manual Push Eject</b>	Mechanical error	<ul style="list-style-type: none"> <li>• Press the  (eject) button and remove the disc, and check that the error message is cleared.</li> <li>• Check that the disc is not damaged or deformed, and insert the disc again. <ul style="list-style-type: none"> <li>▶ <b>Protecting CDs</b> P. 278</li> </ul> </li> </ul>
<b>Mecha Error</b>		<ul style="list-style-type: none"> <li>• If the error message reappears, press the  button, and pull out the disc.</li> <li>• Insert a different disc. If the new disc plays, there is a problem with the first disc.</li> <li>• If the error message repeats, or the disc cannot be removed, contact a dealer. Do not try to force the disc out of the player.</li> </ul>
<b>Bad Disc Please Check Owner's Manual</b>	Servo error	<ul style="list-style-type: none"> <li>• If the error message reappears, press the  button, and pull out the disc.</li> <li>• Insert a different disc. If the new disc plays, there is a problem with the first disc.</li> <li>• If the error message repeats, or the disc cannot be removed, contact a dealer. Do not try to force the disc out of the player.</li> </ul>
<b>Check Disc</b>	Disc error	<ul style="list-style-type: none"> <li>• Check that the disc is not damaged or deformed. <ul style="list-style-type: none"> <li>▶ <b>Protecting CDs</b> P. 278</li> </ul> </li> </ul>
<b>Heat Error</b>	High temperature	<ul style="list-style-type: none"> <li>• Turn the audio system off and allow the player to cool down until the error message is cleared.</li> </ul>

Models with navigation system

## Hard Disc Drive (HDD) Audio

If an error occurs while playing the Hard Disc Drive (HDD) Audio, you may see the following error messages. If you cannot clear the error message, contact a dealer.

Error Message	Solution
<b>Navigation system is suspended due to low air pressure. System will resume when vehicle moves to an area of lower altitude.</b>	The HDD is inoperable due to low atmospheric pressure. Move your vehicle to a lower altitude where atmospheric pressure is higher.
<b>HDD access error. Please consult your dealer.</b>	—
<b>The navigation system temperature is too high. For protection, the system will shut off until it cools down.</b>	Turn the audio system off and allow the player to cool down until the error message is cleared.
<b>The navigation system temperature is too low. For protection, the system will shut off until it warms up.</b>	The navigation system has difficulty reading the HDD when the temperature is below approximately -22°F (-30°C). The navigation system starts up automatically when the display warms up.
<b>Unplayable File</b>	Appears when a file format not supported. Current track will be skipped. The next supported track plays automatically.



## iPod®/USB Flash Drive

If an error occurs while playing an iPod® or USB flash drive, you may see the following error messages. If you cannot clear the error message, contact a dealer.

### Audio system without touch screen

Error Message	Solution
<b>USB ERROR</b>	There is a problem with the USB adapter unit.
<b>BAD USB DEVICE PLEASE CHECK OWNERS MANUAL</b>	An incompatible device is connected. Disconnect the device. Then turn the audio system off, and turn it on again. Do not reconnect the device that caused the error.
<b>iPod NO SONG</b>	Appears when the iPod® is empty.
<b>UNSUPPORTED VER.</b>	Appears when an unsupported iPod® is connected. If it appears when a supported iPod® is connected, update the iPod® software to the newer version.
<b>CONNECT RETRY</b>	Appears when the system does not acknowledge the iPod®. Reconnect the iPod®.
<b>UNPLAYABLE FILE</b>	Appears when the files in the USB flash drive are DRM or an unsupported format. This error message appears for about 3 seconds, then plays the next song.
<b>USB NO SONG</b>	Appears when the USB flash drive is empty or there are no MP3, WMA, or AAC files in the USB flash drive.
<b>UNSUPPORTED</b>	Appears when an unsupported device is connected. If it appears when the supported device is connected, reconnect the device.

Audio system with touch screen

Error Message	Solution
<b>USB Error</b>	Appears when there is a problem with the USB adapter unit. Check if the device is compatible with the USB adapter unit.
<b>Incompatible USB Device Please Check Owner's Manual</b>	Appears when an incompatible device is connected. Disconnect the device. Then turn the audio system off, and turn it on again. Do not reconnect the device that caused the error.
<b>Unsupported Version</b>	Appears when an unsupported iPod® is connected. If it appears when a supported iPod® is connected, update the iPod® software to the newer version.
<b>Connect Retry</b>	Appears when the system does not acknowledge the iPod®. Reconnect the iPod®.
<b>Unplayable File</b>	Appears when the files in the USB flash drive are DRM or an unsupported format. This error message appears for about 3 seconds, then plays the next song.
<b>No Data</b>	<p><b>iPod®</b> Appears when the iPod® is empty.</p>
	<p><b>USB flash drive</b> Appears when the USB flash drive is empty or there are no MP3, WMA, or AAC files in the USB flash drive.</p>
	<p><b>iPod® and USB flash drive</b> Check that compatible files are stored on the device.</p>
<b>Unsupported</b>	Appears when an unsupported device is connected. If it appears when a supported device is connected, reconnect the device.

U.S. models

**Pandora®\***

If an error occurs while playing Pandora®, you may see the following error messages.

If you cannot clear the error message, contact a dealer.

Error Message	Solution
<b>Incompatible USB Device</b> <b>Please Check Owner's Manual</b>	Appears when an incompatible device is connected. Disconnect the device. Then turn the audio system off, and turn it again. Do not reconnect the device that caused the error.
<b>Audio/Information Screen</b> <b>There is no station list in the device.</b> <b>Please add the station list to your device.</b> <b>Audio with Touch Screen</b> <b>No stations have been created.</b> <b>Please create a station on the device.</b>	Appears when there is no station list on the device. Use the device to create a station.
<b>Audio/Information Screen</b> <b>Music licenses force us to limit the number of tracks you may skip each hour.</b> <b>Audio with Touch Screen</b> <b>Music licenses force us to limit the number of tracks you may skip each hour.</b>	Appears when you try to skip a song or select <b>Dislike</b> over the predetermined number of times in an hour.

Error Message	Solution
<p><b>Unable to save rating. Unable to save bookmark or Unable to skip</b></p>	<p>Appears when the commanded operation is failed. Try again later.</p>
<p><b>No data</b></p>	<p>Appears when no data is available with Pandora® activated. Reboot the app and reconnect the device.</p>
<p><b>PANDORA ver unsupport</b></p>	<p>Appears when Pandora® version is not supported. Update Pandora® to the latest version.</p>
<p><b>PANDORA system maintenance</b></p>	<p>Appears when the Pandora® server is in maintenance. Try again later.</p>
<p><b>Cannot connect to PANDORA. When stopped, check your mobile phone.</b></p>	<p>Appears when Pandora® is unable to play music. Check your device.</p>

U.S. models

**Aha™\***

If an error occurs while playing Aha™, you may see the following error messages.

If you cannot clear the error message, contact a dealer.

Error Message	Solution
<b>Cannot connect to HondaLink. When stopped, check your mobile device.</b>	Appears when the Aha™ app is not activated. Check your device.
<b>Incompatible USB Device Please Check Owner's Manual</b>	Appears when an incompatible device is connected. Disconnect the device. Then turn the audio system off, and turn it on again. Do not reconnect the device that caused the error.

## XM® Radio Service \*

### ■ Subscribing to XM® Radio

1. You need your radio ID ready before registering for subscription. To see the ID in the display: Turn the **MENU/SEL** (Selector) knob or the interface dial until **0** appears.
2. Have your radio ID and credit card number ready, and either call or visit the XM® website to subscribe.

### ■ Receiving XM® Radio

Switch to the XM® mode by pressing the **SOURCE** button repeatedly or operating the audio with touch screen, and stay in this mode for about 30 minutes until the service is activated. Make sure your vehicle is in an open area with good reception.

### ■ XM® Radio Display Messages

#### **Loading:**

XM® is loading the audio or program information.

#### **Ch off air:**

The channel is not currently broadcasting.

#### **Ch unauthorized:**

XM® radio is receiving information update from the network.

#### **No signal:**

The signal is too weak in the current location.

#### **Ch unavailable:**

No such channel exists, the channel is not part of your subscription, or the artist or title information is unavailable.

#### **Check antenna:**

There is a problem with the XM® antenna. Contact a dealer.

### ☒ Subscribing to XM® Radio

Contact Information for XM® Radio:

US: XM® Radio at [www.siriusxm.com](http://www.siriusxm.com) or (800) 852-9696

Canada: XM® Canada at [www.xmradio.ca](http://www.xmradio.ca), or (877) 209-0079

### ☒ Receiving XM® Radio

The XM® satellites are in orbit over the equator; therefore, objects south of the vehicle may cause satellite reception interruptions. Satellite signals are more likely to be blocked by tall buildings and mountains the farther north you travel from the equator.

You may experience reception problems under the following circumstances:

- In a location with an obstruction to the south of your vehicle.
- In tunnels
- On the lower level of a multi-tiered road
- Large items carried on the roof rack

## Recommended CDs

- Use only high-quality CD-R or CD-RW discs labeled for audio use.
- Use only CD-R or CD-RW discs on which the recordings are closed.
- Play only standard round-shaped CDs.

The CD packages or jackets should have one of these marks.



Models with navigation system  
Also includes:



### CDs with MP3, WMA, or AAC files

- Some software files may not allow for audio play or text data display.
- Some versions of MP3, WMA, or AAC formats may be unsupported.

### Recommended CDs

A Dual-disc cannot play on this audio unit. If recorded under certain conditions, a CD-R or CD-RW may not play either.

Manufactured under license under U.S. Patent Nos: 5,956,674; 5,974,380; 6,487,535 & other U.S. and worldwide patents issued & pending. DTS, the Symbol, & DTS and the Symbol together are registered trademarks & DTS 2.0 Channel is a trademark of DTS, Inc. Product includes software. ©DTS, Inc. All Rights Reserved.

## ■ Protecting CDs

Follow these precautions when handling or storing CDs:

- Store a CD in its case when it is not being played.
- When wiping a CD, use a soft clean cloth from the center to the outside edge.
- Handle a CD by its edge. Never touch either surface.
- Never insert foreign objects into the CD player.
- Keep CDs out of direct sunlight and extreme heat.
- Do not place stabilizer rings or labels on the CD.
- Avoid fingerprints, liquids, and felt-tip pens on the CD.

## ▶▶ Protecting CDs

### NOTICE

Do not insert a damaged CD. It may be stuck inside and damage the audio unit.

### Examples:

- Bubbled, wrinkled, labeled, and excessively thick CDs

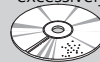

Bubbled/  
Wrinkled



With Label/  
Sticker



Using  
Printer Label  
Kit

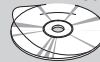

Sealed



With Plastic Ring

- Damaged CDs

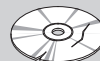

Chipped/  
Cracked



Warped



Burrs

- Poor quality CDs

- Small CDs



3-inch  
(8-cm)  
CD



## Compatible iPod® and USB Flash Drives

### ■ iPod® and iPhone® Model Compatibility

#### Audio system without touch screen

Model
iPod classic® 80GB/160GB
iPod classic® 120GB
iPod classic® 160GB (launch in 2009)
iPod® (5th generation)
iPod nano®
iPod touch®

#### Audio system with touch screen

Model
iPod® (5th generation)
iPod classic® 80GB/160GB
iPod classic® 120GB
iPod classic® 160GB (launch in 2009)
iPod nano®
iPod touch®
iPhone® 3G/iPhone® 3GS/iPhone® 4/iPhone® 4S

### ⌘ iPod® and iPhone® Model Compatibility

This system may not work with all software versions of these devices.

## ■ USB Flash Drives

- Use a recommended USB flash drive of 256 MB or higher.
- Some digital audio players may not be compatible.
- Some USB flash drives (e.g., a device with security lockout) may not work.
- Some software files may not allow for audio play or text data display.
- Some versions of MP3, WMA, or AAC formats may be unsupported.

## ▣ USB Flash Drives



Files on the USB flash drive are played in their stored order. This order may be different from the order displayed on your PC or device.

# Customized Features\*

Use the audio/information screen to customize certain features.

## ■ How to customize

### Models without navigation system

With the ignition switch in ON \*, press and hold the **DISP** button, then rotate  to select **Audio Settings**, **Phone Settings**, **Camera Settings**, **Vehicle Settings**, **System Settings** or **Info Settings** and press .

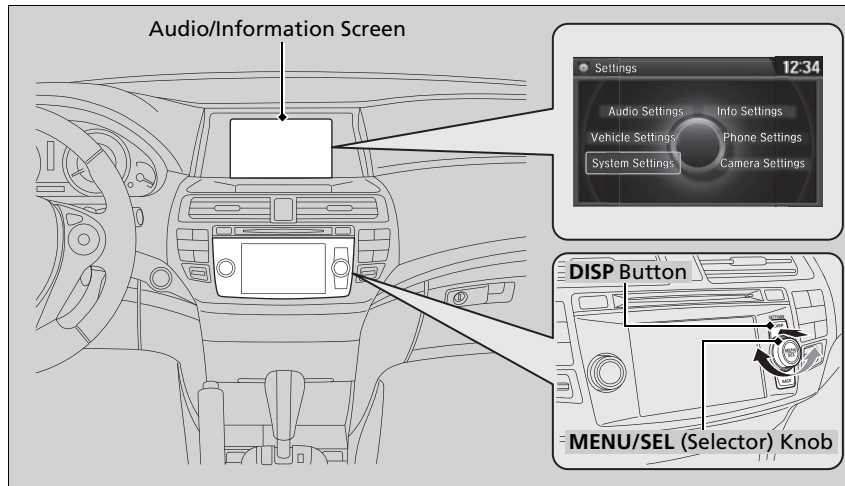

\*1: Models with the smart entry system have an **ENGINE START/STOP** button instead of an ignition switch.



\* Not available on all models

*Continued*

## ⌘ Customized Features\*



### Models without navigation system

When you customize settings, make sure that the vehicle is at a complete stop and shift to **P**.

To customize other features, rotate , and press .

➤ **List of customizable options** P. 294

**Models with navigation system**



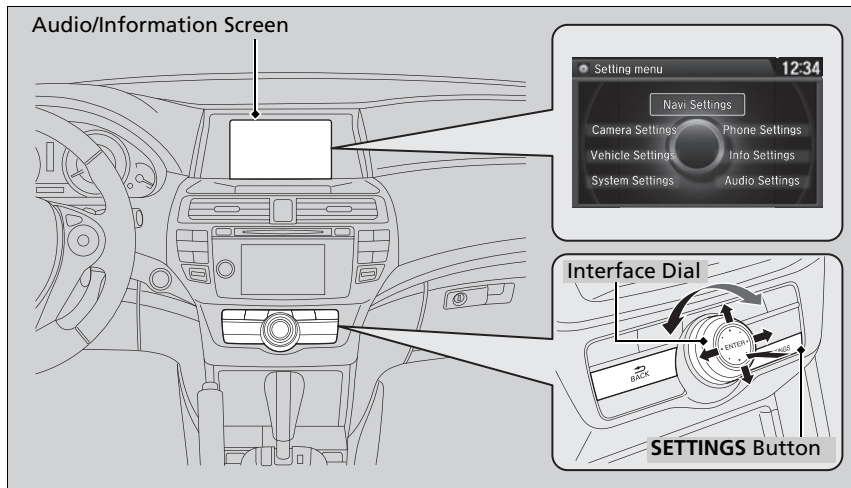



With the ignition switch in ON **II**\*1, press the **SETTINGS** button. Rotate  to select **Audio Settings**, **Phone Settings**, **Camera Settings**, **Vehicle Settings**, **System Settings**, **Info Settings**, or **Navi Settings** and press .



▶▶ Customized Features\*

**Models with navigation system**

When you customize setting, make sure that the vehicle is at a complete stop and shift to **P**.

To customize other features, rotate , move , , , , or , and press .

➔ **List of customizable options** P. 304

\*1: Models with the smart entry system have an **ENGINE START/STOP** button instead of an ignition switch.

\* Not available on all models

Models without navigation system

■ Customization flow

Press and hold the DISP button.

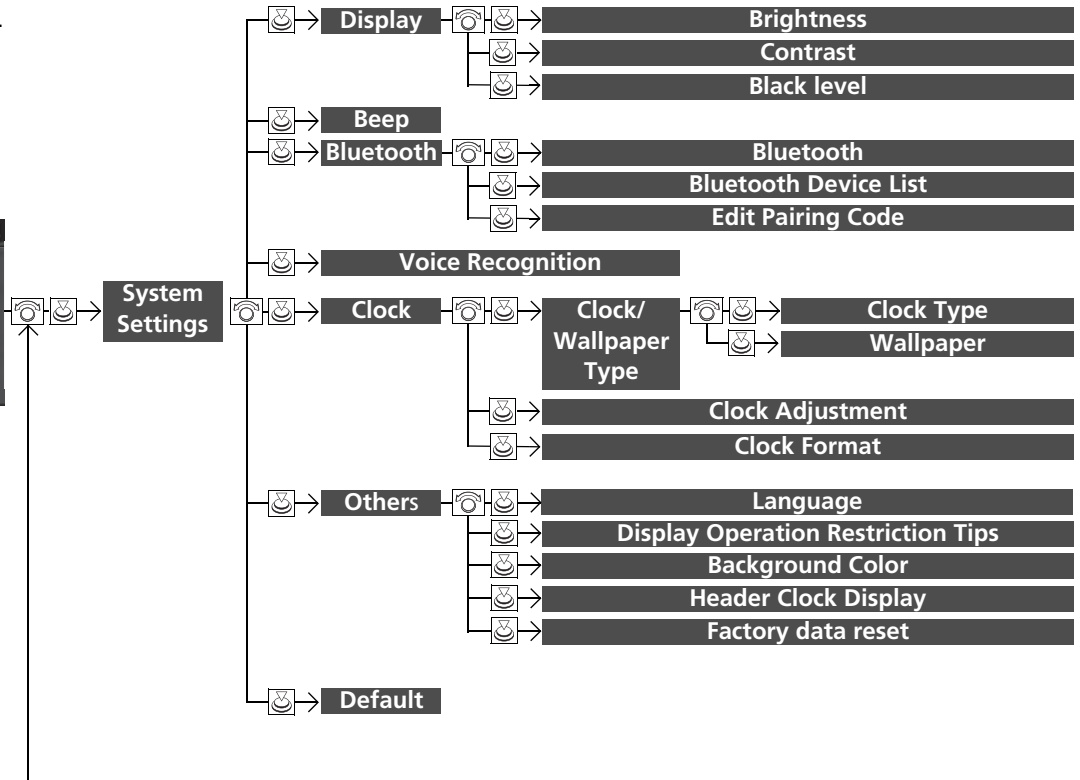

Features

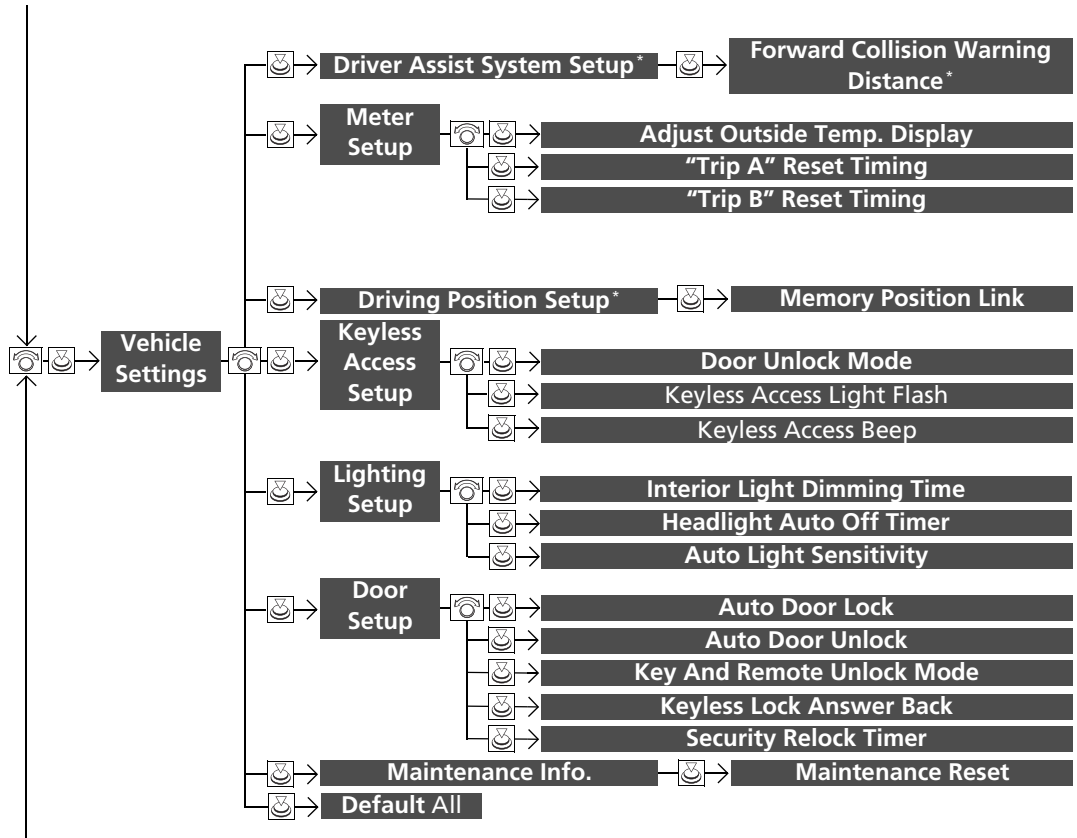

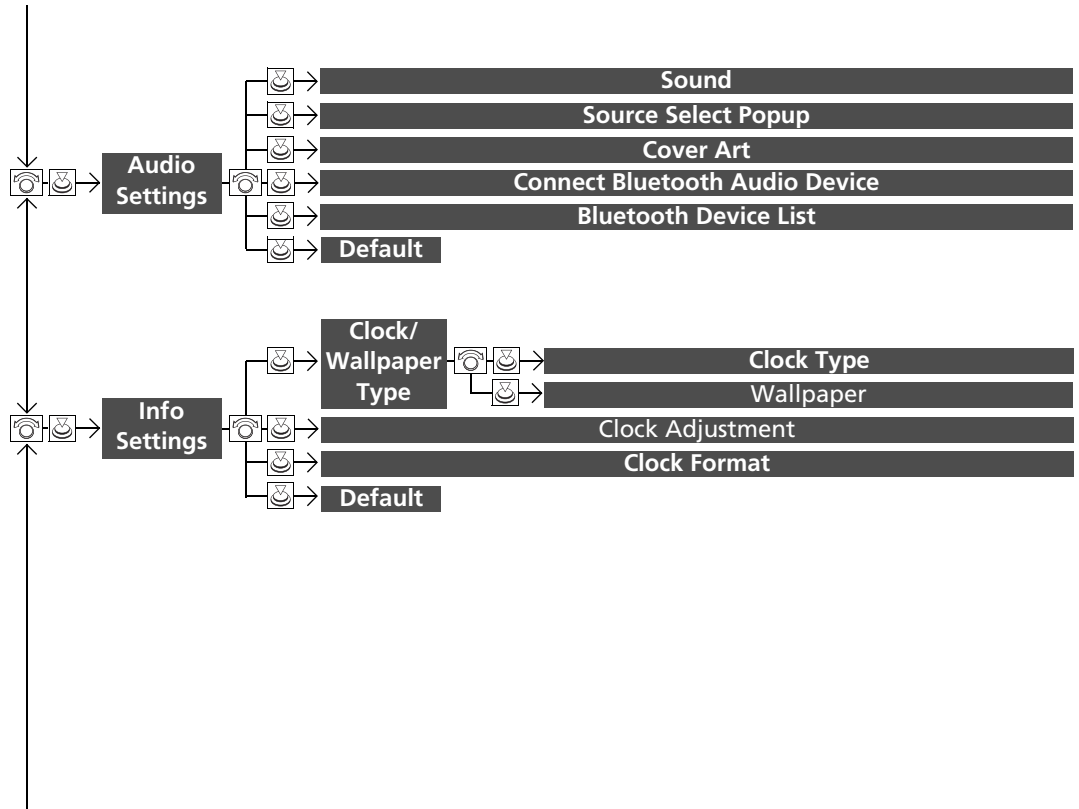

Features

\* Not available on all models

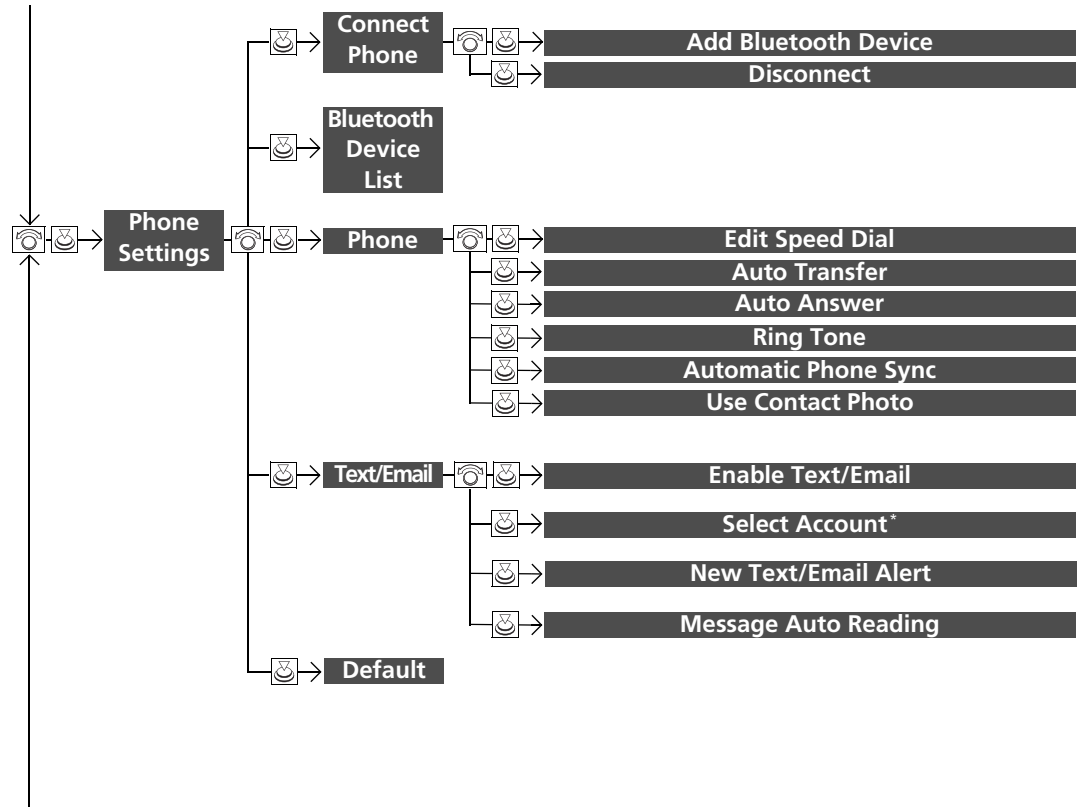



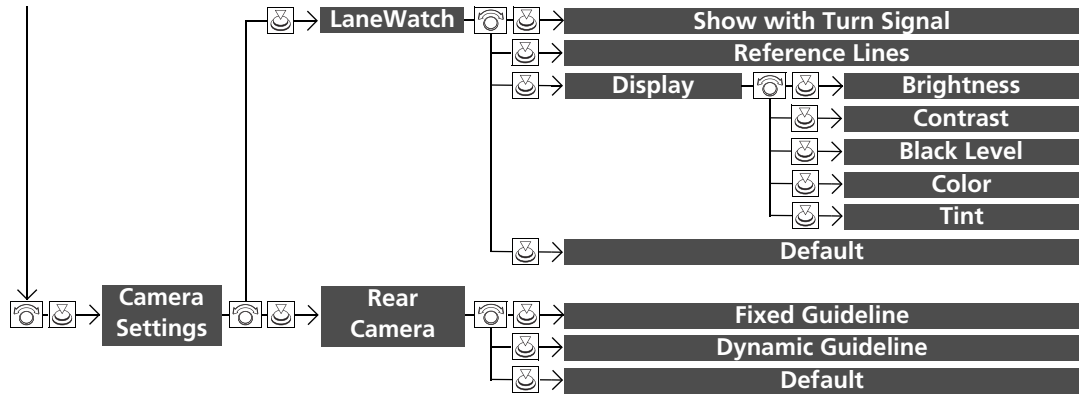

Features

Models with navigation system

■ Customization flow

Press the **SETTINGS** button.

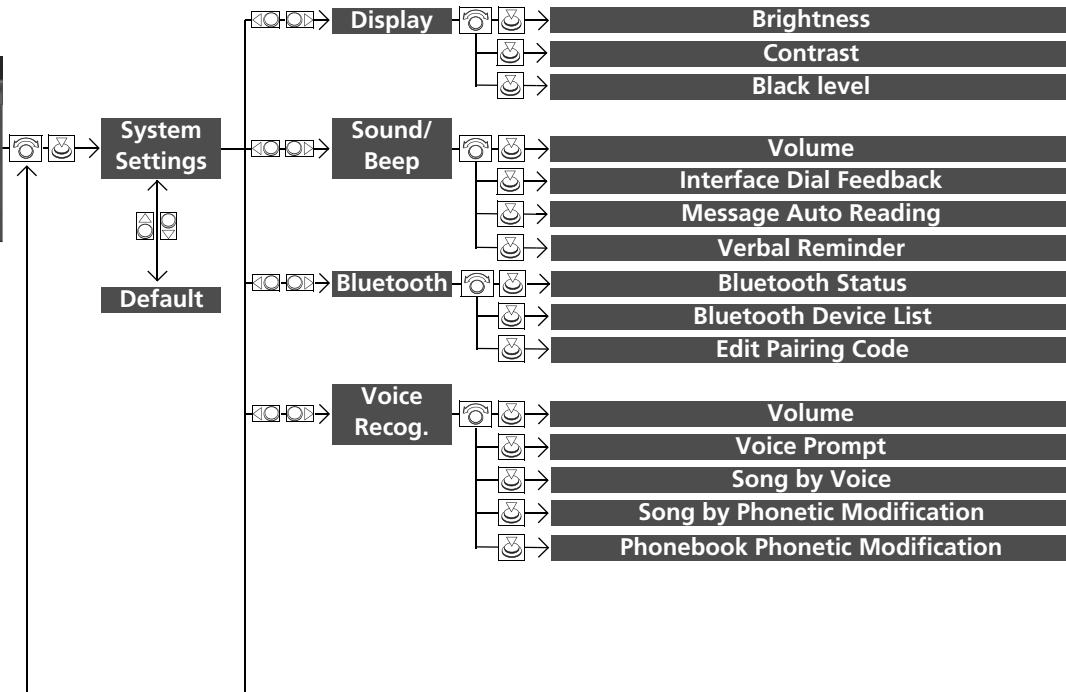
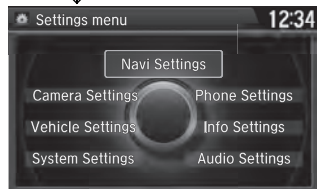

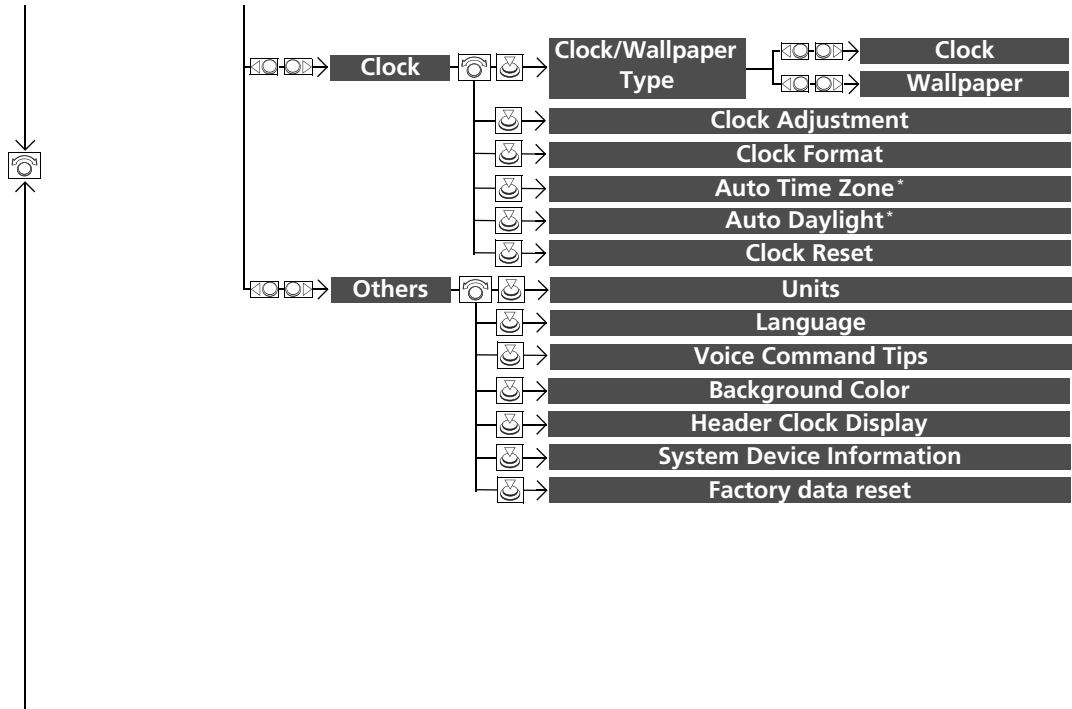

Features

\* Not available on all models

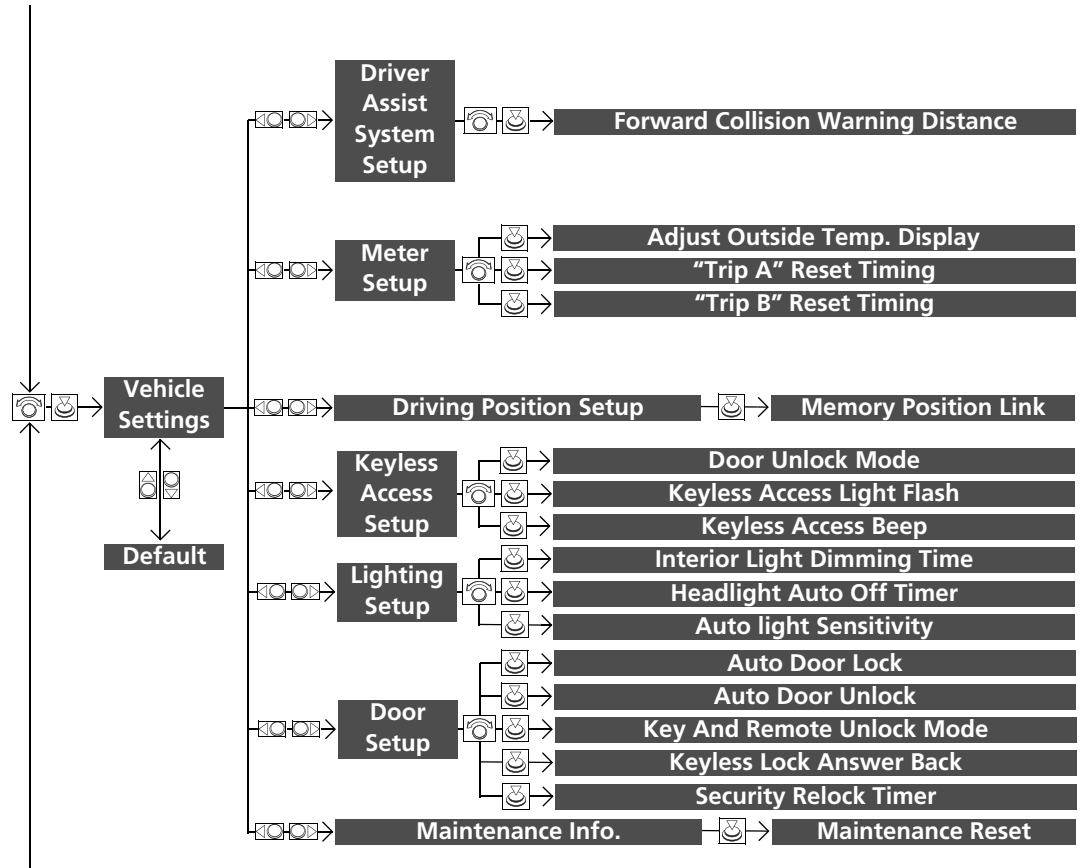

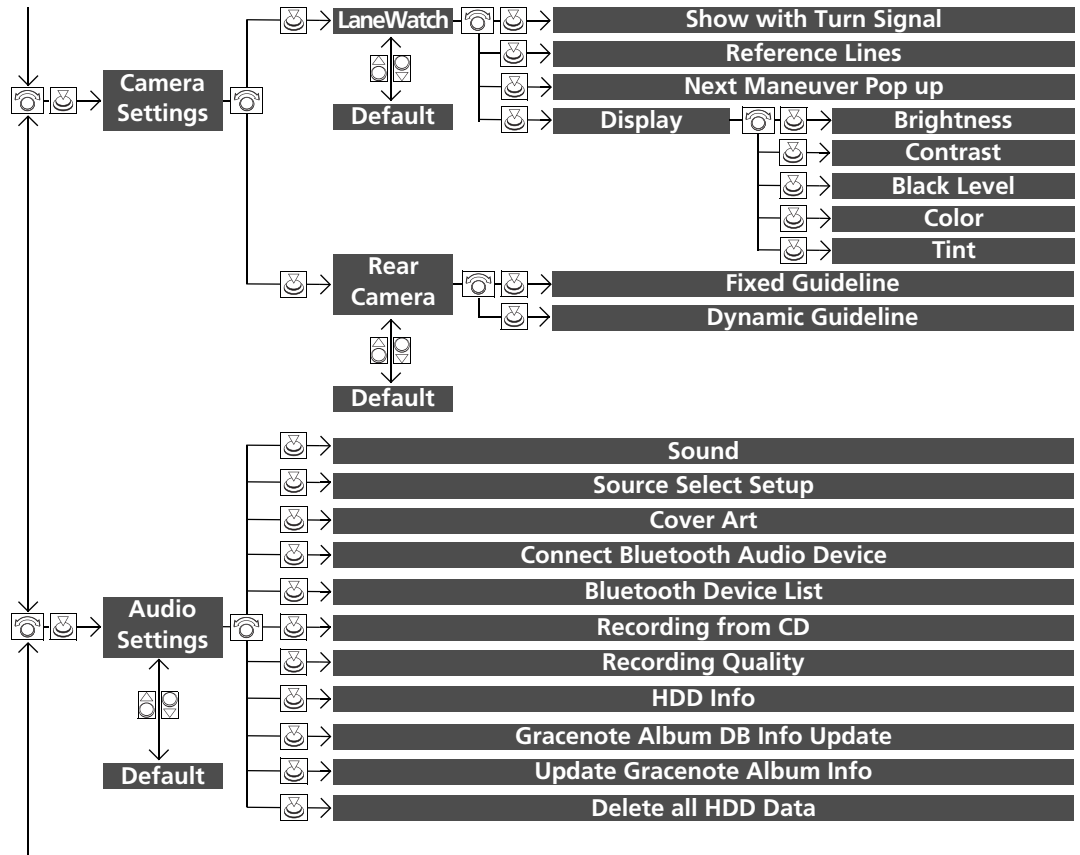

Features

\* Not available on all models

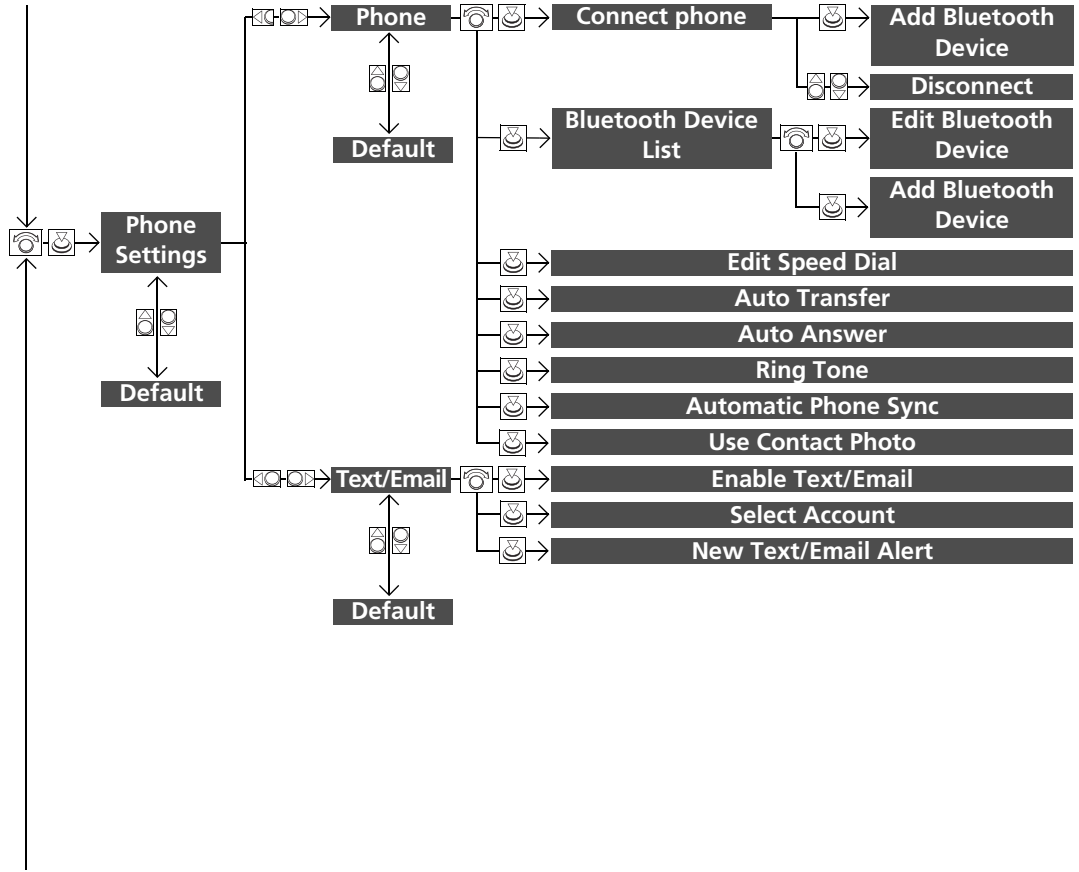

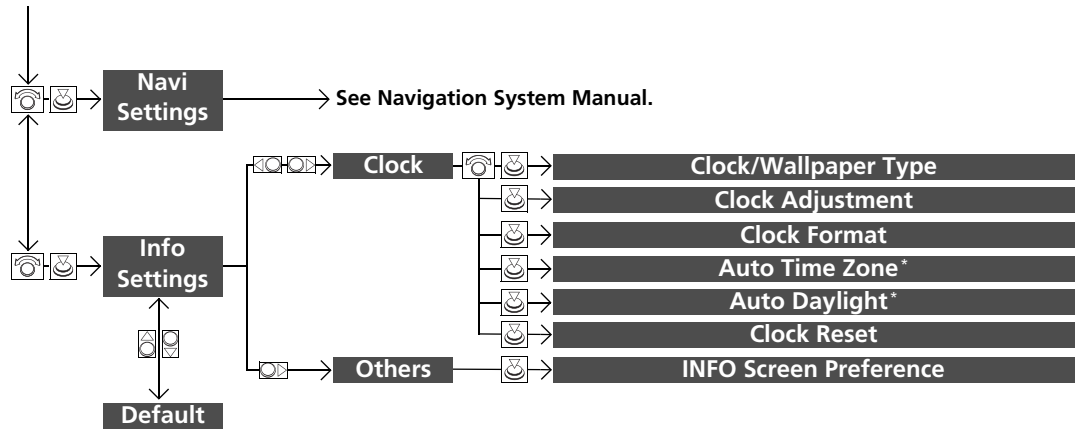

\* Not available on all models



■ List of customizable options

Models without navigation system

Setup Group	Customizable Features	Description	Selectable Settings	
System Settings	<b>Brightness</b>	Changes the brightness of the audio/information screen.	—	
	<b>Display</b>	<b>Contrast</b>	Changes the contrast of the audio/information screen.	—
		<b>Black level</b>	Changes the black level of the audio/information screen.	—
	<b>Beep</b>	Selects whether a beeper sounds or not when you operate the selector knob.	<b>On*<sup>1</sup>/Off</b>	
	<b>Blue-tooth</b>	<b>Bluetooth</b>	Turns the <i>Bluetooth</i> ® on and off.	<b>On*<sup>1</sup>/Off</b>
		<b>Bluetooth Device List</b>	Pairs a new phone to HFL, edits and deletes a paired phone, and create a security PIN. ➤ <b>Phone Setup</b> P. 339	—
		<b>Edit Pairing Code</b>	Changes a pairing code. ➤ <b>To change the pairing code setting</b> P. 341	<b>Random*<sup>1</sup>/Fixed</b>
	<b>Voice Recognition</b>	Turns the voice recognition on and off.	<b>On*<sup>1</sup>/Off</b>	

\*1:Default Setting



Setup Group	Customizable Features		Description	Selectable Settings
System Settings	Clock	<b>Clock Type</b>	Changes the clock display type.	<b>Analog/Digital*<sup>1</sup>/Small Digital/Off</b>
		<b>Clock/Wallpaper Type</b>	<ul style="list-style-type: none"> <li>Changes the wallpaper type.</li> <li>Imports an image file for a new wallpaper.</li> <li>Deletes an image file for a wallpaper.   <b>Wallpaper Setup</b> P. 189</li> </ul>	<b>Blank/Galaxy*<sup>1</sup>/Metallic/Add New</b>
		<b>Wallpaper</b>		
		<b>Clock Adjustment</b>	Adjust Clock.  <b>Setting the Clock</b> P. 88	—
		<b>Clock Format</b>	Selects the digital clock display from 24H to 12H.	<b>12H*<sup>1</sup>/24H</b>
		<b>Language</b>	Changes the display language.	<b>English*<sup>1</sup>/French/Spanish</b>
		<b>Display Operation Restriction Tips</b>	Selects whether the display operation restriction message is shown or not.	<b>On*<sup>1</sup>/Off</b>
	<b>Others</b>	<b>Background Color</b>	Changes the background color of the audio/information screen and the audio with touch screen*.	<b>Blue*<sup>1</sup>/Amber/Red/Green</b>
		<b>Header Clock Display</b>	Selects whether the clock display comes on or not.	<b>On*<sup>1</sup>/Off</b>
		<b>Factory Data Reset</b>	Resets all the settings to their factory default.  <b>Defaulting All the Settings</b> P. 315	<b>Yes/No</b>
<b>Default</b>		Cancels /Resets all customized items in the <b>System Settings</b> group as default.	<b>Yes/No</b>	

\*1:Default Setting

\* Not available on all models

Setup Group	Customizable Features	Description	Selectable Settings
Vehicle Settings	<b>Driver Assist System Setup*</b>	<b>Forward Collision Warning Distance*</b>	Changes at which distance FCW alerts, or turns FCW on and off. <b>Long*<sup>1</sup>/Normal/Short/Off</b>
	<b>Meter Setup</b>	<b>Adjust Outside Temp. Display</b>	Adjust the temperature reading by a few degrees. <b>-5°F ~ ±0°F*<sup>1</sup> ~ +5°F (U.S.) -3°C ~ ±0°C*<sup>1</sup> ~ +3°C (Canada)</b>
		<b>"Trip A" Reset Timing</b>	Changes the setting of how to reset trip meter A and average fuel economy A. <b>With Refuel/IGN Off/Manually Reset*<sup>1</sup></b>
		<b>"Trip B" Reset Timing</b>	Changes the setting of how to reset trip meter B and average fuel economy B. <b>With Refuel/IGN Off/Manually Reset*<sup>1</sup></b>
	<b>Driving Position Setup*</b>	<b>Memory Position Link</b>	Changes the driver's seat and door mirror positions to a stored setting. <b>On*<sup>1</sup>/Off</b>

\*1:Default Setting

Setup Group	Customizable Features	Description	Selectable Settings
<b>Vehicle Settings</b>	<b>Keyless Access Setup</b>	<b>Door Unlock Mode</b>	Changes which doors unlock when you grab the driver's door handle. <b>Driver Door Only*<sup>1</sup>/ All Doors</b>
		<b>Keyless Access Light Flash</b>	Causes some exterior lights to blink when you unlock/lock the doors. <b>On*<sup>1</sup>/Off</b>
		<b>Keyless Access Beep</b>	Sets the beeper sound or not when you grab either front door handle. <b>On*<sup>1</sup>/Off</b>
		<b>Interior Light Dimming Time</b>	Changes the length of time the interior lights stay on after you close the doors. <b>60seconds/ 30seconds*<sup>1</sup>/ 15seconds</b>
	<b>Lighting Setup</b>	<b>Headlight Auto Off Timer</b>	Changes the length of time the exterior lights stay on after you close the driver's door. <b>60seconds/ 30seconds/ 15seconds*<sup>1</sup>/ 0seconds</b>
		<b>Auto Light Sensitivity</b>	Changes the timing for the headlights to come on. <b>Max/High/Mid*<sup>1</sup>/ Low/Min</b>

\*1:Default Setting

Setup Group	Customizable Features	Description	Selectable Settings
<b>Vehicle Settings</b>	<b>Auto Door Lock</b>	Changes the setting for the automatic locking feature.	<b>With Vehicle Speed*<sup>1</sup>/ Shift from P/Off</b>
	<b>Auto Door Unlock</b>	Changes the setting for when the doors unlock automatically.	<b>Driver Door with Shift to P*<sup>1</sup>/All Doors with Shift to P/Driver Door with IGN Off/All Doors with IGN Off/Off</b>
	<b>Door Setup</b> <b>Key And Remote Unlock Mode</b>	Sets up either the driver's door or all doors to unlock on the first push of the remote.	<b>Driver Door*<sup>1</sup>/All Doors</b>
	<b>Keyless Lock Answer Back</b>	LOCK/UNLOCK- The exterior lights flash. LOCK (2nd push)- The beeper sounds.	<b>On*<sup>1</sup>/Off</b>
	<b>Security Relock Timer</b>	Changes the time it takes for the doors and the tailgate to relock and the security system to set after you unlock the vehicle without opening any door or the tailgate.	<b>90seconds/ 60seconds/ 30seconds*<sup>1</sup></b>
	<b>Maintenance Info.</b> <b>Maintenance Reset</b>	Resets the engine oil life display when you have performed the maintenance service.	—
<b>Default All</b>		Cancels/Resets all customized items in the <b>Vehicle Settings</b> group as default.	<b>Yes/No</b>

\*1:Default Setting

Setup Group	Customizable Features	Description	Selectable Settings
Audio Settings	Sound	Adjusts the settings of the audio speaker's sound. ▶ <b>Adjusting the Sound</b> P. 191	<b>-6 ~ C*<sup>1</sup> ~ +6 (Bass, Treble, Fader, Balance and Subwoofer), Off/Low/Mid*<sup>1</sup>/High (SVC)</b>
	Source Select Popup	Selects whether the list of selectable audio sources comes on or not when <b>Audio</b> is selected on the <b>Function Change</b> screen.	<b>On/Off*<sup>1</sup></b>
	<i>Bluetooth®</i> Audio, Pandora® or Aha™ mode <b>Connect Bluetooth Audio Device</b>	Connects, disconnects or pairs a <i>Bluetooth®</i> Audio device to HFL.	—
	<i>Bluetooth®</i> Audio, Pandora® or Aha™ mode <b>Bluetooth Device List</b>	Edits or deletes a <i>Bluetooth®</i> Audio device paired to HFL.	—
	iPod®, <i>Bluetooth®</i> Audio, Pandora® or Aha™ mode <b>USB/Bluetooth Connection Priority*</b>	Selects the connection to have priority.	<b>Bluetooth/USB*<sup>1</sup></b>
	<b>Default</b>	Cancels/Resets all customized items in the <b>Audio Settings</b> group as default.	<b>Yes/No</b>

\*1:Default Setting

\* Not available on all models

Setup Group	Customizable Features	Description	Selectable Settings
Info Settings	Clock/ Wall- paper type	Clock Type	See <b>System Settings</b> on P. 294 to P. 295
		Wallpaper	
	Clock Adjustment		
	Clock Format		
	Default	Cancels/Resets all customized items in the <b>Info Settings</b> group as default.	Yes/No

Setup Group	Customizable Features	Description	Selectable Settings
Phone Settings	<b>Connect Phone</b>	Pairs a new phone to HFL, connects or disconnects a paired phone. ▶ <b>Phone Setup</b> P. 339	—
	<b>Bluetooth Device List</b>	Pairs a new phone to HFL, edits or deletes a paired phone, or creates a security PIN. ▶ <b>Phone Setup</b> P. 339	—
	<b>Edit Speed Dial</b>	Edits, adds or deletes a speed dial entry. ▶ <b>Speed Dial</b> P. 350	—
	<b>Auto Transfer</b>	Sets calls to automatically transfer from your phone to HFL when you enter the vehicle.	<b>On</b> *1/ <b>Off</b>
	<b>Auto Answer</b>	Sets whether to automatically answer an incoming call after about four seconds.	<b>On/Off</b> *1
	<b>Phone</b> <b>Ring Tone</b>	Selects the ring tone.	<b>Fixed</b> *1/ <b>Mobile Phone/Off</b>
	<b>Automatic Phone Sync</b>	Sets a phonebook data to be automatically imported when a phone is paired to HFL.	<b>On</b> *1/ <b>Off</b>
	<b>Use Contact Photo</b>	Displays a caller's picture on an incoming call screen.	<b>On</b> *1/ <b>Off</b>

\*1:Default Setting

Setup Group	Customizable Features	Description	Selectable Settings
<b>Phone Settings</b>	<b>Enable Text/Email</b>	Turns the text message/E-mail function on and off.	<b>On*<sup>1</sup>/Off</b>
	<b>Select Account*</b>	Selects a mail or text message account.	—
	<b>New Text/Email Alert</b>	Selects whether a pop-up alert comes on the screen when HFL receives a new text message/E-mail.	<b>On/Off*<sup>1</sup></b>
	<b>Message Auto Reading</b>	Sets the system to automatically read an incoming text message/E-mail. <ul style="list-style-type: none"> <li>• <b>On</b>- A text message/E-mail is always read aloud.</li> <li>• <b>Off</b>- A text message/E-mail is not read aloud.</li> <li>• <b>Auto</b>- A text message/E-mail is read aloud only when driving.</li> </ul>	<b>On/Off/Auto*<sup>1</sup></b>
	<b>Default</b>	Cancels/Resets all customized items in the <b>Phone Settings</b> group as default.	<b>Yes/No</b>

\*1:Default Setting



Setup Group	Customizable Features	Description	Selectable Settings	
Camera Settings	Lane-Watch	<b>Show with Turn Signal</b>	Select whether the LaneWatch display comes on when you move the turn signal lever to the passenger side.	On*1/Off
		<b>Reference Lines</b>	Selects whether the reference lines come on the LaneWatch monitor.	On*1/Off
	Display	<b>Brightness</b>	Adjusts the LaneWatch display settings.	—
		<b>Contrast</b>		
		<b>Black Level</b>		
		<b>Color</b>		
		<b>Tint</b>		
	<b>Default</b>	Cancels/Resets all customized items in the <b>LaneWatch</b> group as default.	Yes/No	
	<b>Default</b>	Cancels/Resets all customized items in the <b>LaneWatch</b> group as default.	Yes/No	
	Rear Camera	<b>Fixed Guideline</b>	Selects whether the fixed guidelines come on or not on the rear camera monitor.	On*1/Off
<b>Dynamic Guideline</b>		Selects whether the dynamic guidelines come on or not on the rear camera monitor.	On*1/Off	
<b>Default</b>		Cancels/Resets all customized items in the <b>Rear Camera</b> group as default.	Yes/No	

\*1:Default Setting

■ List of customizable options

Models with navigation system

Setup Group	Customizable Features	Description	Selectable Settings	
System Settings	Display	<b>Brightness</b>	Changes the brightness of the audio/information screen.	—
		<b>Contrast</b>	Changes the contrast of the audio/information screen.	—
		<b>Black Level</b>	Changes the black level of the audio/information screen.	—
	Sound/Beep	<b>Volume</b>	Changes the volume of the audio speakers.	—
		<b>Interface Dial Feedback*</b>	Sets if and when the system reads aloud a selection made using the Interface Dial.	On* <sup>1</sup> /Off/Auto
		<b>Message Auto Reading</b>	Selects whether the system automatically read out message, does not read, or read out only when driving.	On/Off/Auto* <sup>1</sup>
		<b>Verbal Reminder*</b>	Turns the verbal reminders on and off.	On* <sup>1</sup> /Off
	Blue-tooth	<b>Bluetooth</b>	Turns the <i>Bluetooth</i> ® on and off.	On* <sup>1</sup> /Off
		<b>Bluetooth Device List</b>	Pairs a new phone to HFL, edits and deletes a paired phone, and create a security PIN. ☞ <b>Phone Setup</b> P. 373	—
<b>Edit Pairing Code</b>		Changes a pairing code. ☞ <b>To change the pairing code setting</b> P. 375	Random* <sup>1</sup> /Fixed	

\*1:Default Setting

\* Not available on all models

Setup Group	Customizable Features	Description	Selectable Settings		
System Settings	Voice Recog.	<b>Volume</b>	Changes the volume of the voice prompt.	—	
		<b>Voice Prompt</b>	Turns the voice prompt on and off.	<b>On*<sup>1</sup>/Off</b>	
		<b>Song by Voice</b>	Turns the Song By Voice™ on and off. ▶ <b>Song By Voice™ (SBV)</b> P. 256	<b>On*<sup>1</sup>/Off</b>	
		<b>Song by Phonetic Modification</b>	Modifies a voice command for music stored in the HDD or an iPod®. ▶ <b>Phonetic Modification</b> P. 258	—	
		<b>Phonebook Phonetic Modification</b>	Modifies a voice command for the phonebook. ▶ <b>Phonebook Phonetic Modification</b> P. 388	—	
	Clock	Clock/ Wallpaper Type	<b>Clock</b>	Changes the clock display type.	<b>Analogue/Digital*<sup>1</sup>/ Small Digital/Off</b>
			<b>Wallpaper</b>	<ul style="list-style-type: none"> <li>• Changes the wallpaper type.</li> <li>• Imports an image file for a new wallpaper.</li> <li>• Deletes an image file for a wallpaper.</li> </ul> ▶ <b>Wallpaper Setup</b> P. 220	<b>Blank/Galaxy*<sup>1</sup>/ Metallic/Time Zone</b>
		<b>Clock Adjustment</b>	Adjust Clock. ▶ <b>Setting the Clock</b> P. 88	—	
		<b>Clock Format</b>	Selects the digital clock display from 12H to 24H.	<b>12H*<sup>1</sup>/24H</b>	
		<b>Auto Time Zone*</b>	Sets the navigation system to automatically adjust the clock when driving through different time zones.	<b>On*<sup>1</sup>/Off</b>	

\*1:Default Setting

\* Not available on all models

Continued

Setup Group	Customizable Features	Description	Selectable Settings	
<b>System Settings</b>	<b>Clock</b>	<b>Auto Daylight*</b>	Sets the navigation system to automatically adjust the clock ("spring ahead" or "fall back" by one hour) when a daylight saving time change occurs.	<b>On*<sup>1</sup>/Off</b>
		<b>Clock Reset</b>	Resets the settings of all items in the <b>Clock</b> group.	—
	<b>Other</b>	<b>Units*</b>	Changes the distance unit on the navigation map screen.	<b>miles*<sup>1</sup>/km</b>
		<b>Language</b>	Changes the display language.	<b>English*<sup>1</sup>/French/ Spanish</b>
		<b>Voice Command Tips</b>	Alerts you when manual control of the system is disabled to prevent distraction while driving. Only voice commands are available.	<b>On*<sup>1</sup>/Off</b>
		<b>Background Color</b>	Changes the background color of the audio/information screen and the audio with touch screen.	<b>Blue*<sup>1</sup>/Amber/Red/ Green</b>
		<b>Header Clock Display</b>	Selects whether the clock display comes on or not.	<b>On*<sup>1</sup>/Off</b>
		<b>System Device Information</b>	Displays the system/Device information.	—
		<b>Factory Data Reset</b>	Resets all the settings to their factory default.  <b>Defaulting All the Settings</b> P. 316	—
		<b>Default</b>	Cancels /Resets all customized items in the <b>System Settings</b> group as default.	<b>Default/OK</b>

\*1:Default Setting

\* Not available on all models

Setup Group	Customizable Features	Description	Selectable Settings
<b>Vehicle Settings</b>	<b>Driver Assist System Setup</b>	<b>Forward Collision Warning Distance</b>	Changes at which distance FCW alerts, or turns FCW on and off. <b>Long<sup>*1</sup>/Normal/Short/Off</b>
		<b>Adjust Outside Temp. Display</b>	Adjust the temperature reading by a few degrees. <b>-5°F ~ ±0°F<sup>*1</sup> ~ +5°F (U.S.) -3°C ~ ±0°C<sup>*1</sup> ~ +3°C (Canada)</b>
	<b>Meter Setup</b>	<b>"Trip A" Reset Timing</b>	Changes the setting of how to reset trip meter A, average fuel economy A, average speed A*, and elapsed time A*. <b>With Refuel/IGN Off/Manually Reset<sup>*1</sup></b>
		<b>"Trip B" Reset Timing</b>	Changes the setting of how to reset trip meter B, average fuel economy B, average speed B*, and elapsed time B*. <b>With Refuel/IGN Off/Manually Reset<sup>*1</sup></b>
		<b>Fuel Efficiency Backlight</b>	Turns the ambient meter feature on and off. <b>On<sup>*1</sup>/Off</b>
	<b>Keyless Start Guidance Screens</b>	Displays the push button start guidance when conditions are met to change power mode. <b>On<sup>*1</sup>/Off</b>	

\*1:Default Setting

Setup Group	Customizable Features	Description	Selectable Settings
Vehicle Settings	<b>Driving Position Setup</b> <b>Memory Position Link</b>	Changes the driver's seat and door mirror positions to a stored setting.	<b>On*<sup>1</sup>/Off</b>
	<b>Door Unlock Mode</b>	Changes which doors unlock when you grab the driver's door handle.	<b>Drivers Door Only*<sup>1</sup>/ All Doors</b>
	<b>Keyless Access Setup</b> <b>Keyless Access Light Flash</b>	Causes some exterior lights to blink when you unlock/lock the doors.	<b>On*<sup>1</sup>/Off</b>
	<b>Keyless Access Beep</b>	Causes the beeper to sound when you unlock/lock the doors.	<b>On*<sup>1</sup>/Off</b>
	<b>Interior Light Dimming Time</b>	Changes the length of time the interior lights stay on after you close the doors.	<b>60seconds/ 30seconds*<sup>1</sup>/ 15seconds</b>
	<b>Lighting Setup</b> <b>Headlight Auto Off Timer</b>	Changes the length of time the exterior lights stay on after you close the driver's door.	<b>60seconds/ 30seconds/ 15seconds*<sup>1</sup>/ 0seconds</b>
	<b>Auto Light Sensitivity</b>	Changes the timing for the headlights to come on.	<b>Max/High/Mid*<sup>1</sup>/ Low/Min</b>

\*1: Default Setting

Setup Group	Customizable Features	Description	Selectable Settings
Vehicle Settings	<b>Auto Door Lock</b>	Changes the setting for the automatic locking feature.	<b>With Vehicle Speed*<sup>1</sup>/ Shift from P/Off</b>
	<b>Auto Door Unlock</b>	Changes the setting for when the doors unlock automatically.	<b>Driver Door with Shift to P*<sup>1</sup>/All Doors with Shift to P/Driver Door with IGN Off/All Doors with IGN Off/Off</b>
	<b>Door Setup</b> <b>Key And Remote Unlock Mode</b>	Sets up either the driver's door or all doors to unlock on the first push of the remote.	<b>Driver Door*<sup>1</sup>/All Doors</b>
	<b>Keyless Lock Answer Back</b>	LOCK/UNLOCK- The exterior lights flash. LOCK (2nd push)- The beeper sounds.	<b>On*<sup>1</sup>/Off</b>
	<b>Security Relock Timer</b>	Changes the time it takes for the doors and the tailgate to relock and the security system to set after you unlock the vehicle without opening any door or the tailgate.	<b>90seconds/ 60seconds/ 30seconds*<sup>1</sup></b>
<b>Maintenance Info.</b>	<b>Maintenance Reset</b>	Resets the engine oil life display when you have performed the maintenance service.	—
<b>Default</b>		Cancels/Resets all customized items in the <b>Vehicle Settings</b> group as default.	<b>Default/OK</b>

\*1:Default Setting





Setup Group	Customizable Features	Description	Selectable Settings	
Camera Settings	Lane-Watch	<b>Show with Turn Signal</b>	Selects whether the LaneWatch display comes on when you move the turn signal lever to the passenger side.	On*1/Off
		<b>Reference Lines</b>	Selects whether the reference lines come on the LaneWatch monitor.	On*1/Off
		<b>Next Maneuver Pop up</b>	Selects whether a turn direction screen of the navigation system interrupts on the LaneWatch display.	On*1/Off
	Display	<b>Brightness</b>	Adjusts the LaneWatch display settings.	—
		<b>Contrast</b>		
		<b>Black Level</b>		
		<b>Color</b>		
		<b>Tint</b>		
		<b>Default</b>	Cancels/Resets all customized items in the <b>LaneWatch</b> group as default.	<b>Default/OK</b>
	Rear Camera	<b>Fixed Guideline</b>	Selects whether the fixed guidelines come on or not on the rear camera monitor.	On*1/Off
<b>Dynamic Guideline</b>		Selects whether the dynamic guidelines come on or not on the rear camera monitor.	On*1/Off	
<b>Default</b>		Cancels/Resets all customized items in the <b>Rear Camera</b> group as default.	<b>Default/OK</b>	

\*1: Default Setting



Setup Group	Customizable Features	Description	Selectable Settings
Audio Settings	<b>Sound</b>	Adjusts the settings of the audio speaker's sound. ▶ <b>Adjusting the Sound</b> P. 222	<b>-6 ~ C*1 ~ +6 (Bass, Treble, Fader, Balance and Subwoofer), Off/Low/Mid*1/High (SVC)</b>
	<b>Source Select Popup</b>	Selects whether the list of selectable audio sources comes on or not when the <b>AUDIO</b> button is pressed.	<b>On/Off*1</b>
	<b>Cover Art</b> CD (MP3/WMA/AAC), iPod®, USB, Pandora® or Aha™ mode	Turns on and off the cover art display.	<b>On*1/Off</b>
	<b>Connect Bluetooth Audio Device</b> Bluetooth® Audio, Pandora® or Aha™ mode	Connects, disconnects or pairs a <i>Bluetooth</i> ® Audio device to HFL.	—
	<b>Bluetooth Device List</b> Bluetooth® Audio, Pandora® or Aha™ mode	Edits or deletes a <i>Bluetooth</i> ® Audio device paired to HFL.	—
	<b>Recording from CD</b> CD mode	Selects whether the songs on music CDs are automatically recorded to the HDD or not.	<b>Auto*1/Manual</b>
	<b>Recording Quality</b> CD mode	Selects the quality of the music files recorded to the HDD.	<b>Standard*1/High</b>

\*1:Default Setting

Setup Group	Customizable Features	Description	Selectable Settings
Audio Settings	<b>HDD mode</b> <b>HDD Info</b>	Displays the HDD capacity.	—
	<b>CD or HDD mode</b> <b>Gracenote Album DB Info Update</b>	Update the Gracenote® Album Info (Gracenote® Media Database).	<b>Update from USB*1/ Update from CD</b>
	<b>CD or HDD mode</b> <b>Update Gracenote Album Info</b>	Update the Gracenote® Album Info (Gracenote® Media Database).	<b>Update by USB*1/ Update by CD</b>
	<b>HDD mode</b> <b>Delete all HDD Data</b>	 <b>Delete all HDD Data</b> P. 317	—
	<b>Default</b>	Cancels/Resets all customized items in the <b>Audio Settings</b> group as default.	<b>Default/OK</b>
Phone Settings	<b>Connect phone</b>	Pairs a new phone to HFL, connects or disconnects a paired phone.  <b>Phone Setup</b> P. 373	—
	<b>Bluetooth Device List</b>	Pairs a new phone to HFL, edits or deletes a paired phone, or creates a security PIN.  <b>Phone Setup</b> P. 373	—
	<b>Edit Speed Dial</b>	Edits, adds or deletes a speed dial entry.  <b>Phone Setup</b> P. 373	—

\*1:Default Setting

Setup Group	Customizable Features	Description	Selectable Settings	
Phone Settings	<b>Auto Transfer</b>	Sets calls to automatically transfer from your phone to HFL when you enter the vehicle.	<b>On<sup>*1</sup>/Off</b>	
	<b>Auto Answer</b>	Sets whether to automatically answer an incoming call after about four seconds.	<b>On/Off<sup>*1</sup></b>	
	<b>Phone</b>	<b>Ring Tone</b>	Selects the ring tone.	<b>Fixed/Mobile Phone<sup>*1</sup>/Off</b>
	<b>Automatic Phone Sync</b>	Sets a phonebook data to be automatically imported when a phone is paired to HFL.	<b>On<sup>*1</sup>/Off</b>	
	<b>Use Contact Photo</b>	Displays a caller's picture on an incoming call screen.	<b>On<sup>*1</sup>/Off</b>	
	<b>Text/Email</b>	<b>Enable Text/Email</b>	Turns the text message/E-mail function on and off.	<b>On<sup>*1</sup>/Off</b>
		<b>Select Account</b>	Selects a mail or text message account.	—
		<b>New Text/Email Alert</b>	Selects whether a pop-up alert comes on the screen when HFL receives a new text message/E-mail.	<b>On/Off<sup>*1</sup></b>

\*1:Default Setting

Setup Group	Customizable Features	Description	Selectable Settings												
Info Settings	<table border="1"> <tr> <td>Clock/ Wallpaper type</td> <td>Clock Wallpaper</td> </tr> <tr> <td>Clock Adjustment</td> <td></td> </tr> <tr> <td>Clock Format</td> <td></td> </tr> <tr> <td>Auto Time Zone*</td> <td></td> </tr> <tr> <td>Auto Daylight*</td> <td></td> </tr> <tr> <td>Clock Reset</td> <td></td> </tr> </table>	Clock/ Wallpaper type	Clock Wallpaper	Clock Adjustment		Clock Format		Auto Time Zone*		Auto Daylight*		Clock Reset		See <b>System Settings</b> on P. 304 to P. 306.	
	Clock/ Wallpaper type	Clock Wallpaper													
	Clock Adjustment														
	Clock Format														
	Auto Time Zone*														
	Auto Daylight*														
Clock Reset															
Other	<b>INFO Screen Preference</b>	Selects the top menu when the <b>INFO</b> button is pressed. <ul style="list-style-type: none"> <li>• <b>Info Top</b>- A brief menu pops up.</li> <li>• <b>Info Menu</b>- A full menu pops up.</li> <li>• <b>Off</b>- A menu does not pop up.</li> </ul>	<b>Info Top/Info Menu</b> *1/Off												
Default		Cancels/Resets all customized items in the <b>Info Settings</b> group as default.	<b>Default/OK</b>												

\*1:Default Setting

Models without navigation system

## Defaulting All the Settings

Reset all the menu and customized settings as the factory defaults.

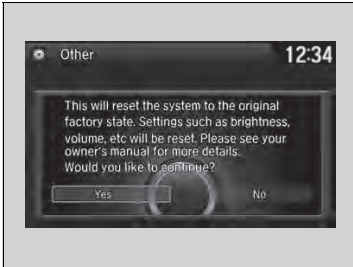

1. Press the **DISP** button.
2. Rotate to select **Settings**, then press .
3. Rotate to select **System Settings**, then press .
  - ▶ Repeat the procedure to select **Other**, then **Factory Data Reset**.
  - ▶ The confirmation message will appear.
4. Rotate to select **Yes**, then press to reset the settings.
5. Rotate to select **Yes**, then press again to reset the settings.
  - ▶ The confirmation message will appear. Press to select **OK**.

### Defaulting All the Settings

When you transfer the vehicle to a third party, reset all settings to default and delete all personal data.

Models with navigation system

## Defaulting All the Settings

Reset all the menu and customized settings as the factory defaults.

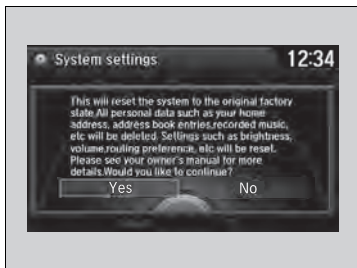

1. Press the **SETTINGS** button.
2. Rotate to select **System Settings**, then press .
3. Rotate to select **Other**, then press .
4. Rotate to select **Factory Data Reset**, then press
  - The pop-up menu appears on the screen.
5. Rotate to select **Yes**, then press
  - The confirmation message will appear.
6. Rotate to select **Yes**, then press again to reset the settings.
  - The confirmation message will appear. Press to select **OK**.

### ►► Defaulting All the Settings

When you transfer the vehicle to a third party, reset all settings to default and delete all personal data.

The following settings will be reset:





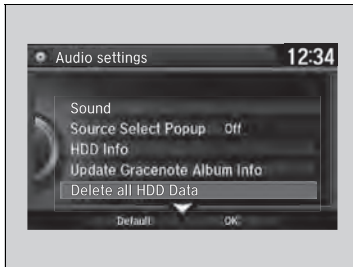

- Routing & Guidance: Rerouting, Unverified Area Routing, Traffic Rerouting, Edit Waypoint Search Area, Guidance Mode, Street Name Guidance
- Route Preference

Models with navigation system

## Deleting all HDD Data

Reset all the menu and customized settings, and delete all music data on the HDD.



1. Turn on the audio system and select the HDD mode.
2. Press the **SETTINGS** button.
3. Rotate  to select **Audio Settings**, then press .
4. Rotate  to select **Delete all HDD Data**, then press .
  - ▶ The confirmation message will appear.
5. Rotate  to select **Yes**, then press .

The HomeLink® Universal Transceiver can be programmed to operate up to three remote controlled devices around your home, such as garage doors, lighting, or home security systems.

## Important Safety Precautions

Refer to the safety information that comes with your garage door opener to test that the safety features are functioning properly. If you do not have the safety information, contact the manufacturer.

Before programming HomeLink, make sure that people and objects are out of the way of the garage or gate to prevent potential injury or damage.

When programming a garage door opener, park just outside the garage door's path.

## Training HomeLink

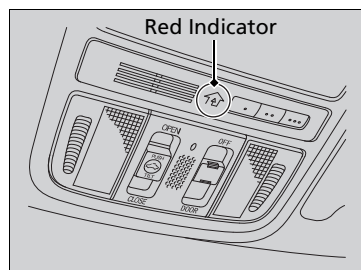

If you have not trained any of the buttons in HomeLink before, you should erase any previously learned codes. To do this:

- Press and hold the two outside buttons for about 20 seconds, until the red indicator blinks. Release the buttons, and proceed to step 1.
- If you are training the second or third button, go directly to step 1.

### HomeLink® Universal Transceiver\*

HomeLink® is a registered trademark of Johnson Controls, Inc.

Before programming HomeLink to operate a garage door opener, confirm that the opener has an external entrapment protection system, such as an "electronic eye," or other safety and reverse stop features. If it does not, HomeLink may not be able to operate it.



## ■ Training a Button

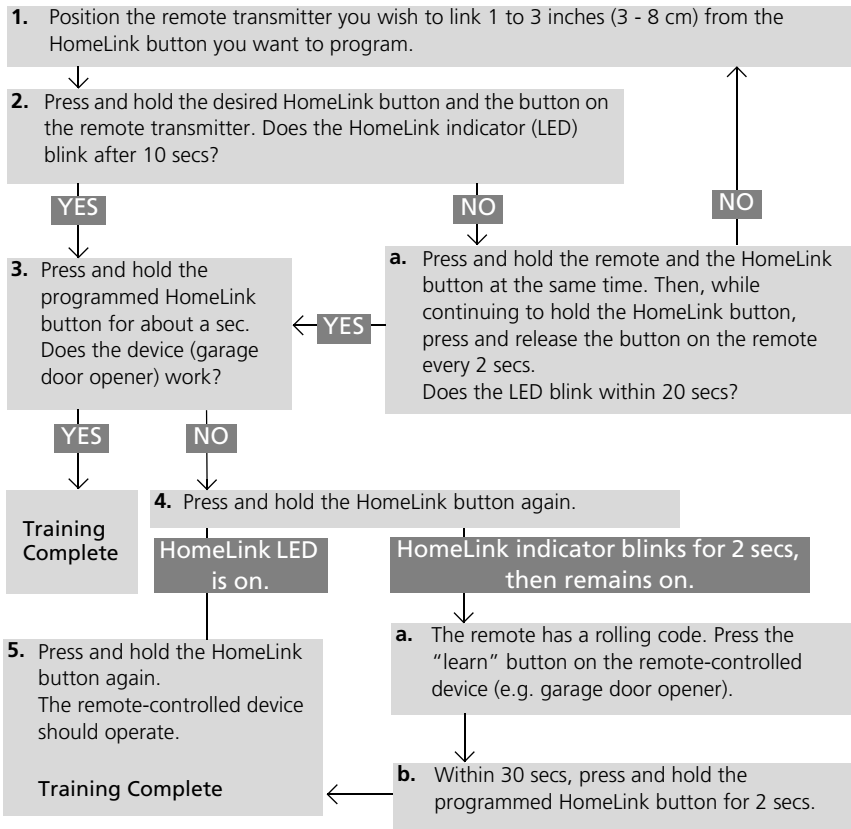

## ▣ Training a Button

**Retraining a Button**  
 If you want to retrain a programmed button for a new device, you do not have to erase all button memory. You can replace the existing memory code using this procedure:

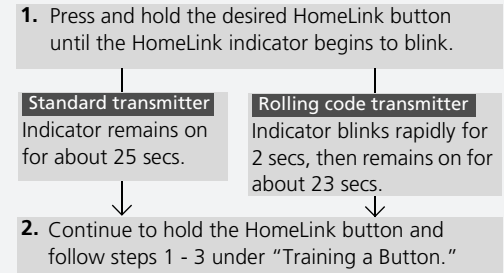

**Erasing Codes**  
 To erase all the codes, press and hold the two outside buttons until the HomeLink indicator begins to blink (about 10 to 20 secs). You should erase all codes before selling the vehicle.

If you have any problems, see the device's instructions, visit [www.homelink.com](http://www.homelink.com), or call HomeLink at (800) 355-3515.

## Models without navigation system

Bluetooth® HandsFreeLink® (HFL) allows you to place and receive phone calls using your vehicle's audio system, without handling your cell phone.

## Models without touch screen

### Using HFL

#### HFL Buttons

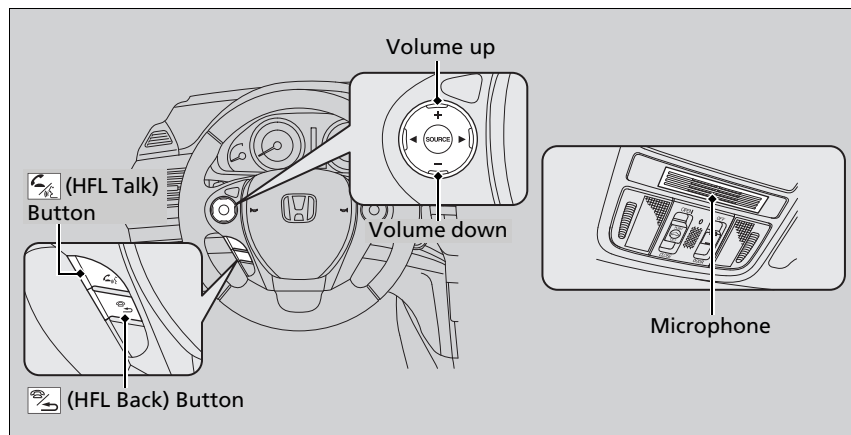

 **Button:** Press to give a command or answer a call.

 **Button:** Press to end a call, go back to the previous command, or cancel a command.

## Bluetooth® HandsFreeLink®

To use HFL, you need a *Bluetooth*-compatible cell phone. For a list of compatible phones, pairing procedures, and special feature capabilities:

- U.S.: Visit [www.handsfreelink.honda.com](http://www.handsfreelink.honda.com), or call (888) 528-7876.
- Canada: Visit [www.handsfreelink.ca](http://www.handsfreelink.ca), or call (888) 528-7876.

#### Voice control tips

- Adjust or close the vents and all windows, as noise coming from them may interfere with the microphone.
- Press and release the  button before giving a command. Speak clearly and naturally after a beep.
- If the microphone picks up voices other than yours, the command may be misinterpreted.
- A command that consists of several words can be spoken together. For example, say "Call 123-456-7890" at once.
- To change the volume level, use the audio system's volume knob or the remote audio controls on the steering wheel.

State or local laws may prohibit the operation of handheld electronic devices while operating a vehicle.

## Help Features

- To hear general HFL information and help, say *“Tutorial.”*
- Say *“Hands-free help”* or *“Help”* any time to get help or hear a list of commands.

## HFL Status Display

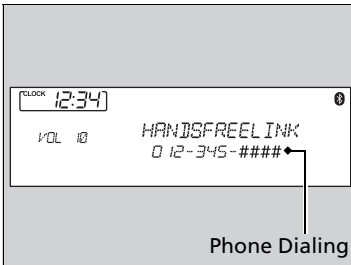

The audio display notifies you when there is an incoming call.

## Bluetooth® HandsFreeLink®

### Bluetooth® Wireless Technology

The *Bluetooth*® word mark and logos are registered trademarks owned by *Bluetooth* SIG, Inc., and any use of such marks by Honda Motors Co., Ltd., is under license. Other trademarks and trade names are those of their respective owners.

### HFL Limitations

An incoming call on HFL will interrupt the audio system when it is playing. It will resume when the call is ended.

## HFL Menus

The ignition switch must be in ACCESSORY **I** or ON **II** to use HFL.

▶ HFL Menu  
 To use HFL, you must first pair your *Bluetooth*-compatible cell phone to the system while the vehicle is parked.

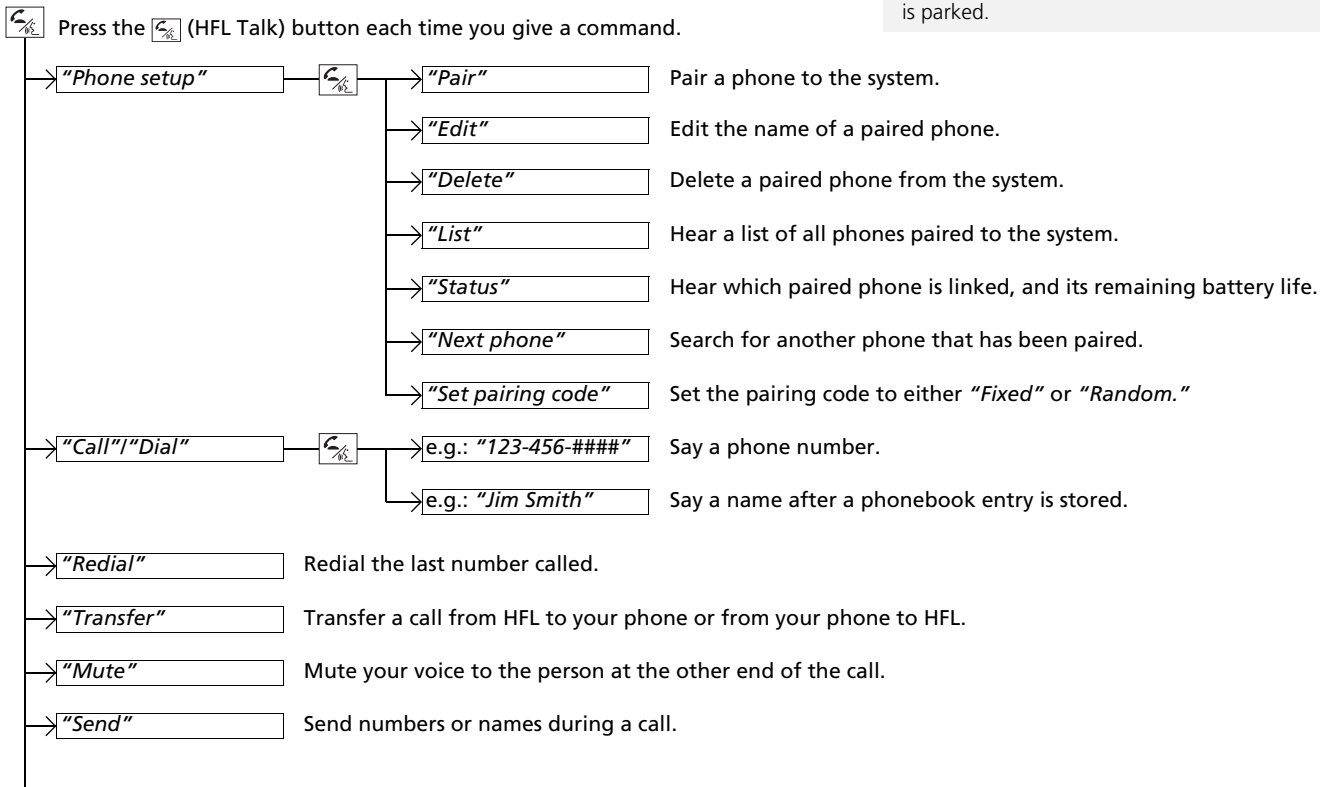

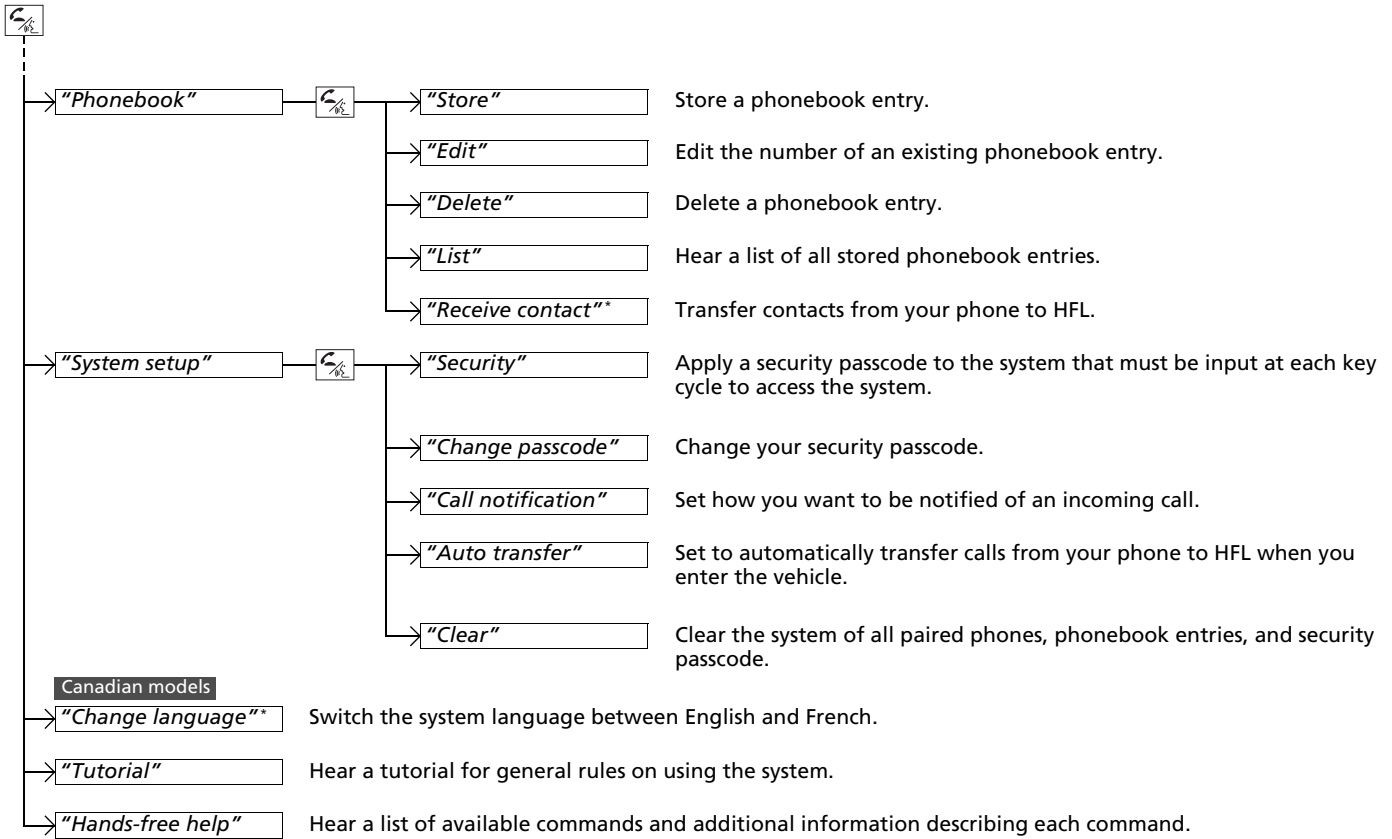

\* Not available on all models

## Phone Setup

### ■ To pair a cell phone

1. If no phone has been paired to the system before, HFL gives you information about how to pair the first phone.  
If a phone has already been paired: say *"Phone Setup"* and *"Pair"* after the HFL prompts.
2. Follow the HFL prompts and put your phone in discovery or search mode.  
▶ HFL gives you a four-digit code and begins searching for your phone.
3. When your phone finds a *Bluetooth*® device, select HFL from the options and enter the four-digit code.
4. Follow the HFL prompts and name the newly paired phone.

### ■ To rename a paired phone

1. Say *"Phone Setup."*
2. Say *"Edit"* after the prompts.
3. Follow the HFL prompts and rename the phone.  
▶ If there is more than one phone paired to the system, HFL asks you which phone's name you want to change.

### ■ To delete a paired phone

1. Say *"Phone Setup."*
2. Say *"Delete"* after the prompts.
3. Follow the HFL prompts.  
▶ HFL asks you which phone you want to delete.

## Phone Setup

Press the  button and wait for a beep before giving a command.

Your *Bluetooth*-compatible phone must be paired to HFL before you can make and receive hands-free calls.

### Phone Pairing Tips:

- You cannot pair your phone while the vehicle is moving.
- Your phone must be in the discoverable or search mode when pairing the phone. Refer to your phone's manual.
- Up to six phones can be paired.
- Your phone's battery may drain faster when it is paired to HFL.
- If your phone is not ready for pairing or not found by the system within three minutes, the system will time out and returns to idle.

**■ To hear the name of all paired phone**

1. Say *"Phone Setup."*
2. Say *"List"* after the prompts.
3. HFL reads out all the paired phone's names.

**■ To hear which paired phone is currently linked**

1. Say *"Phone Setup."*
2. Say *"Status"* after the prompts.
3. HFL tells you which phone is linked with the system.

**■ To change the currently linked phone**

1. Say *"Phone Setup."*
2. Say *"Next Phone"* after the prompts.
3. HFL disconnects the current phone, and searches for another paired phone.
4. Once another phone is found, it is connected to the system. HFL informs you which phone is now linked.

**■ To change the pairing code setting**

1. Say *"Phone Setup."*
2. Say *"Set Pairing Code"* after the prompts.
3. If you want HFL to create a random code each time you pair a phone, say *"Random."* If you want to create your own four-digit code, say *"Fixed."*
4. Follow the HFL prompts.

**☒ Phone Setup**

If no other phones are found or paired when trying to switch to another phone, HFL informs you that the original phone is linked again.

The *"Status"* and *"Next Phone"* commands use: Only one paired phone at a time can be linked to HFL. When there are two or more paired phones in the vehicle, the first paired phone that the system finds is linked.

## ■ Making a Call

You can make calls using any phone number or a name in the HFL phonebook, and redial the last number called.

### ■ Direct dialing a phone number

1. Say "Call" or "Dial."
2. Say the number you want to dial after the prompts.
3. Say "Call" or "Dial" after the prompts.

### ■ From the HFL phonebook

1. Say "Call" or "Dial."
2. Say the name stored in the HFL phonebook after the prompts.
3. Follow the HFL prompts.

### ■ To redial the last number called by HFL

Say "Redial."

### ■ To end a call

Press the  (HFL back) button.

## ▶▶ Making a Call

Press the  button and wait for a beep before giving a command.



HFL uses a Class 2 Bluetooth, with has a maximum range of about 30 feet (10 meters).

HFL allows you to talk up to 30 minutes after you remove the key from the ignition switch. However, this may weaken the vehicle's battery.

Once a call is connected, you can hear the voice of the person you are calling through the audio speakers.



## ■ Receiving a Call

Press the  button to answer the call, or the  button to hang up. When there is an incoming call, a call notification (if activated) sounds.

## ■ Transferring a Call

You can transfer a call from HFL to your phone, or from your phone to HFL. Press the  button and say "Transfer."

## ■ Muting a Call

To mute or unmute your voice during a call, press and release the  button and say "Mute."

## ▶▶ Receiving a Call

### Call Waiting

Press the  button to put the current call on hold to answer the incoming call.

Press the  button again to return to the current call.

Ignore the incoming call if you do not want to answer it.

Press the  button if you want to hang up the current and answer the incoming call.

## ■ Sending Numbers or Name During a Call

You can send numbers and names during a call. This is useful when calling a menu-driven phone system.

### ■ To send a number or name during a call

1. Say "Send."
2. Say the number or name you want to send after the prompts.
3. Follow the HFL prompts.

## ■ HFL Phonebook

You can store up to 50 names with their associated numbers in HFL. The numbers you store can be account numbers or passwords. These numbers can be sent to a menu-driven call.

### ■ To store a phonebook entry



1. Say "Phonebook."
2. Say "Store" after the prompts.
3. Say a name you want to list as your phonebook entry.
4. Say the number you want to store for the name entry.
5. Follow the HFL prompts and say "Enter" to store the entry.

### ■ To edit the number stored for a name

1. Say "Phonebook."
2. Say "Edit" after the prompts.
3. Say a name you want to edit. When asked, say the new number for that name.
4. Follow the HFL prompts and say "Enter" to store the entry.

## ☞ Sending Numbers or Name During a Call

Press the  button before a command.

To send a , say "Pound." To send a , say "Star."

## ☞ HFL Phonebook

- Avoid using duplicate name entries.
- Avoid using "home" as a name entry.
- It is easier for HFL to recognize a multisyllabic or longer name. For example, use "Peter" instead of "Pete," or "John Smith" instead of "John."

**■ To delete a name**

1. Say "Phonebook."
2. Say "Delete" after the prompts.
3. Say a name you want to delete.
4. Say "Yes," and follow the HFL prompts.

**■ To list all names in the phonebook**

1. Say "Phonebook."
2. Say "List" after the prompts.
3. HFL begins reading the names in the order they were stored.
4. When you hear a name you want to call, say "Call."

**■ To store a specific phone number from your cell phone directly to the HFL phonebook\***

1. Say "Phonebook."
2. Say "Receive Contact" after the prompts.
3. Follow the HFL prompts, select a number from your cell phone, and send it to HFL.
  - ▶ If it is not the number you want to store, say "Discard."
4. Say the name for that number.
5. Follow the HFL prompts to continue.

\* Not available on all models

## ■ System Setup

This command group allows you to change or customize HFL basic settings.

### ■ To set a four-digit passcode to lock the HFL system for security

1. Say *"System Setup."*
2. Say *"Security."*
3. Follow the HFL prompts and say the four-digit number of your choice.
4. Follow the HFL prompts and confirm the number.

### ■ To change the security passcode

1. Say *"System Setup."*
2. Say *"Change Passcode"* after the prompts.
3. Say the new four-digit passcode after the HFL prompts.
4. Follow the HFL prompts.

### ■ To select a ring tone or a prompt as the incoming call notification

1. Say *"System Setup."*
2. Say *"Call Notification"* after the prompts.
3. Say *"Ring Tone"* or *"Prompt"* after the prompts. For no audible notification, say *"Off."*

## ⌘ System Setup

Press the  button before a command.

Once a passcode is set, you are required to enter the passcode with every new key cycle to use HFL. If you forget the code, go to your dealer to have the passcode reset. You can also cancel the passcode by clearing all the data stored in the HFL system.

➤ **To clear the system** P. 331

The default setting of the incoming notification is a ring tone.

**■ To activate or deactivate the auto transfer function**

The call on your cell phone can be automatically transferred to HFL when you get into the vehicle and turn on the ignition.

1. Say "System Setup."
2. Say "Auto Transfer" after the prompts. HFL lets you know the current status.
3. Follow the HFL prompts to change the setting.

**■ To clear the system**

Paired phones, all stored or imported phonebook data, and any passcodes are erased.

1. Say "System Setup."
2. Say "Clear" after the prompts.
3. Follow the HFL prompts.

**■ Change Language\***

You can set the system language to French or English.

1. Say "Change Language."
2. Follow the HFL prompts.

If you have not named your paired phone in the selected language, HFL will ask you to name it in that language.

\* Not available on all models

**System Setup**

Press the  button before a command.

You can clear the system when you have forgotten the passcode and cannot access HFL. When HFL asks you for the passcode, say "System Clear."

**Change Language\***

Press the  button before a command.

**Quick Language Selection**

If you want to change the language, to French for example, say "Français," and follow the prompt.

## Models without navigation system

Bluetooth® HandsFreeLink® (HFL) allows you to place and receive phone calls using your vehicle's audio system, without handling your cell phone.

## Models with touch screen

### Using HFL

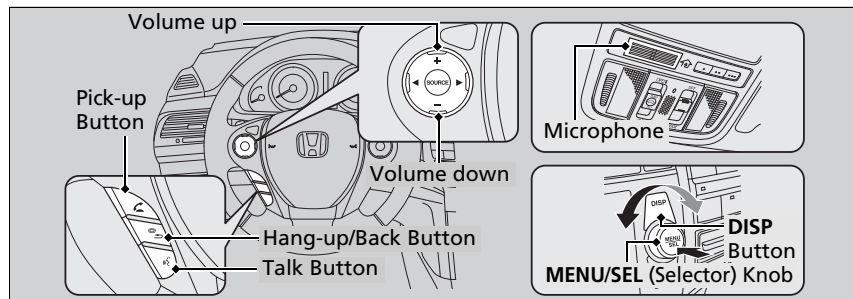

#### HFL Buttons





 **(Pick-up) button:** Press to display the phone menu on half of the screen, or to answer an incoming call.

 **(Hang-up/back) button:** Press to end a call or to cancel a command.

 **(Talk) button:** Press to call a number with a stored voice tag, a phonebook name, or a number.

**MENU/SEL (Selector) knob:** Rotate  to select an item on the audio/information screen, then press .

To go to the Phone screen:

1. Press the **DISP** button to switch the display to the **Function Change** screen.
2. Rotate  to select **Phone**, then press .

\* Not available on all models

## Bluetooth® HandsFreeLink®

To use HFL, you need a Bluetooth-compatible cell phone. For a list of compatible phones, pairing procedures, and special feature capabilities:

- U.S.: Visit [www.handsfreelink.honda.com](http://www.handsfreelink.honda.com), or call (888) 528-7876.
- Canada: Visit [www.handsfreelink.ca](http://www.handsfreelink.ca), or call (888) 528-7876.

To use HFL, the **Bluetooth** setting must be **On**.

 **Customized Features\*** P. 281

Voice control tips

- Aim the vents away from the ceiling and close the windows, as noise coming from them may interfere with the microphone.
- Press and release the  button when you want to call a number using a stored voice tag, a phonebook name, or a number. Speak clearly and naturally after a beep.
- If the microphone picks up voices other than yours, the command may be misinterpreted.
- To change the volume level, use the audio system's volume knob or the remote audio controls on the steering wheel.

State or local laws may prohibit the operation of handheld electronic devices while operating a vehicle.

## HFL Status Display

The audio/information screen notifies you when there is an incoming call.

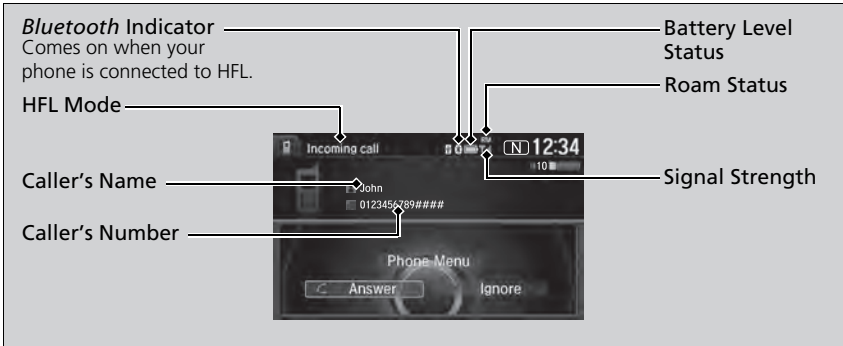

## Limitations for Manual Operation

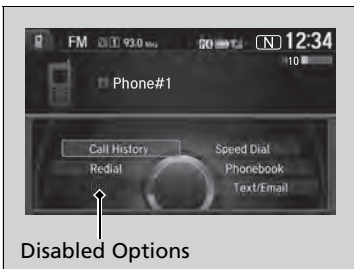

Certain manual functions are disabled or inoperable while the vehicle is in motion. You cannot select a grayed-out option until the vehicle is stopped.

Only previously stored speed dial entries with voice tags, phonebook names, or numbers can be called using voice commands while the vehicle is in motion.

▶ **Speed Dial** P. 350

## Bluetooth® HandsFreeLink®

### Bluetooth® Wireless Technology

The *Bluetooth*® word mark and logos are registered trademarks owned by Bluetooth SIG, Inc., and any use of such marks by Honda Motors Co., Ltd., is under license. Other trademarks and trade names are those of their respective owners.

### HFL Limitations

An incoming call on HFL will interrupt the audio system when it is playing. It will resume when the call is ended.

## HFL Status Display

The information that appears on the audio/information screen varies between phone models.

You can change the system language to English, French, or Spanish.

▶ **Customized Features\*** P. 281

\* Not available on all models

## HFL Menus

The ignition switch must be in ACCESSORY **I** or ON **II**\*1 to use HFL.

### ■ Phone Settings screen

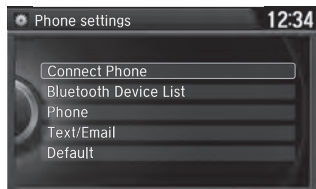

1. Press the **DISP** button.
2. Rotate to select **Settings**, then press .
3. Rotate to select **Phone Settings**, then press .

### ▶▶ HFL Menu

To use HFL, you must first pair your *Bluetooth*-compatible cell phone to the system while the vehicle is parked.

Some functions are limited while driving. A message appears on the screen when the vehicle is moving and the operation is canceled.

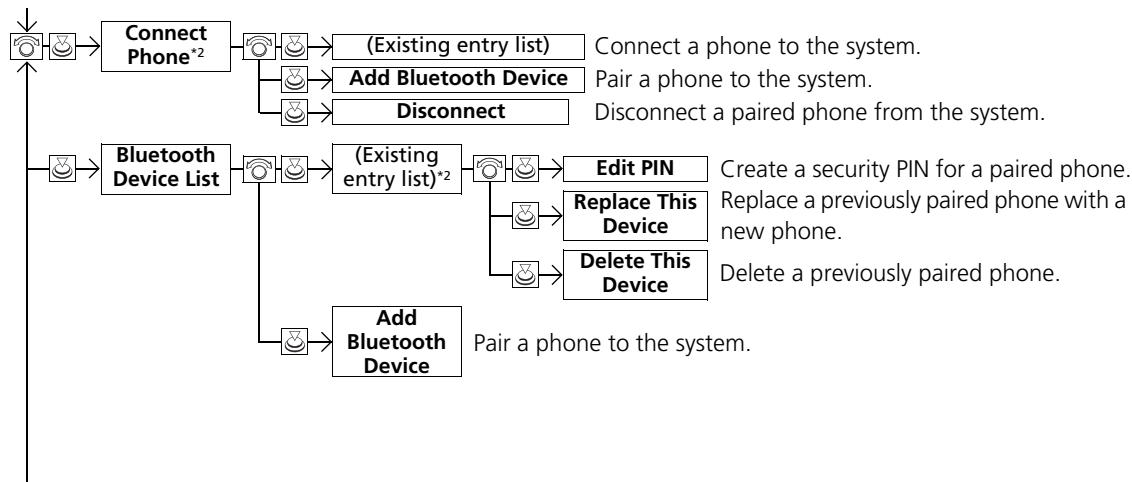

\*1: Models with the smart entry system have an **ENGINE START/STOP** button instead of an ignition switch.

\*2: Appears only when a phone is connected to HFL.



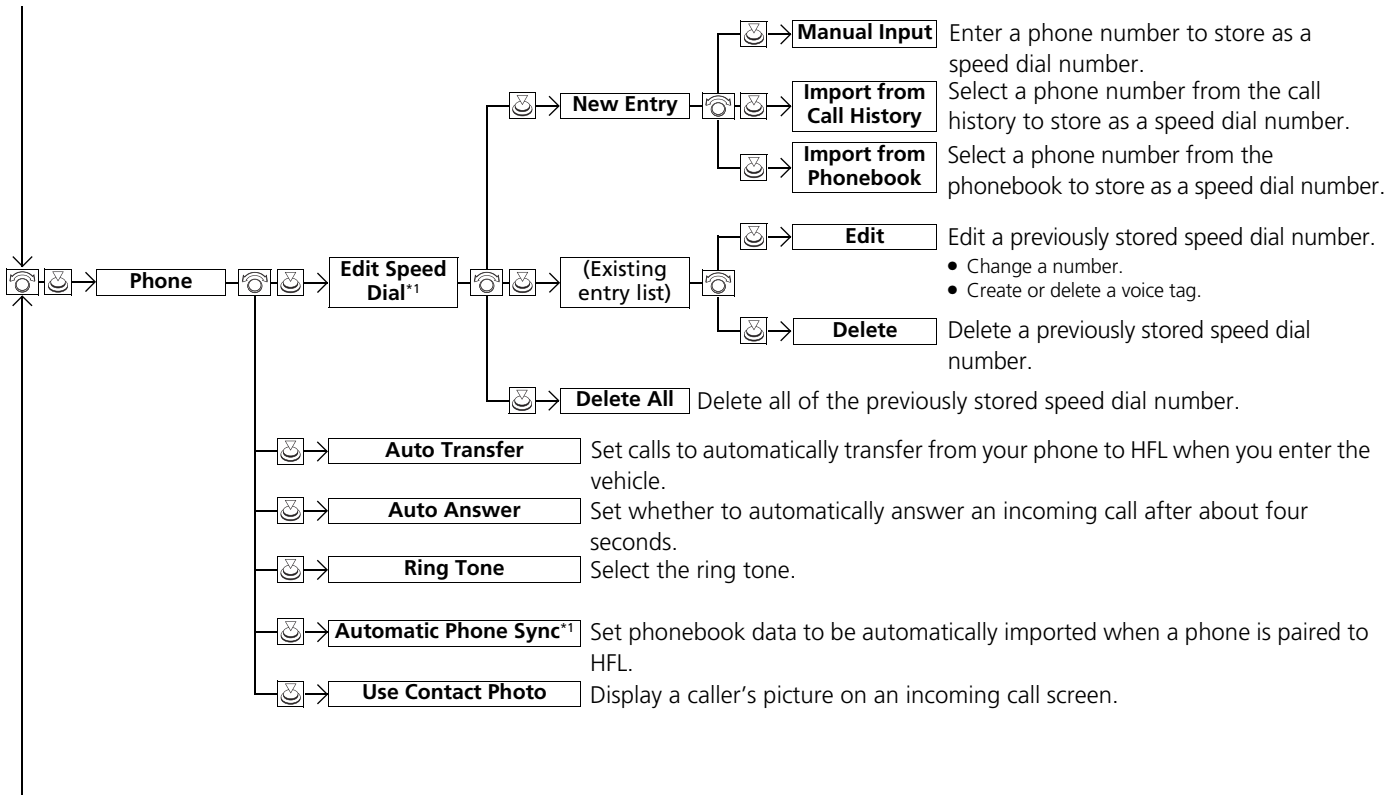

\*1: Appears only when a phone is connected to HFL.

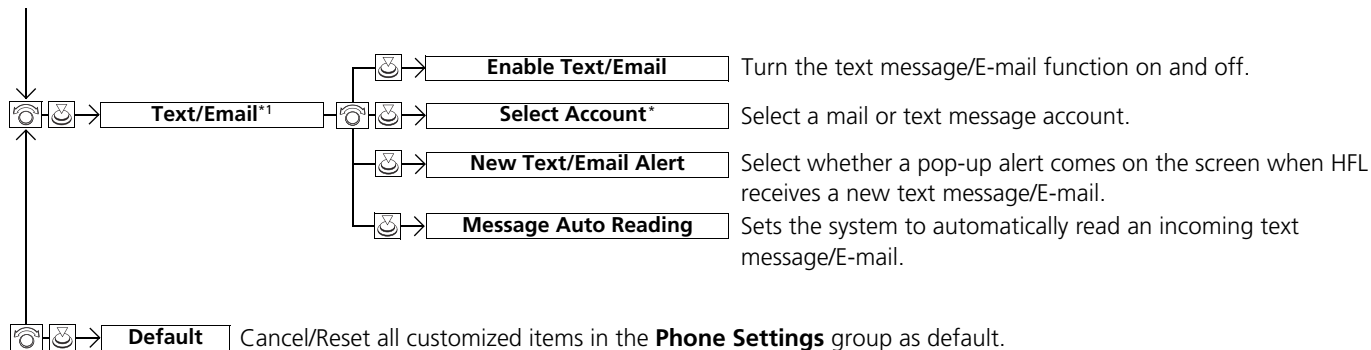

\*1: Appears only when a phone is connected to HFL.

■ Phone screen



1. Press the **DISP** button.
2. Rotate to select **Phone**, then press .

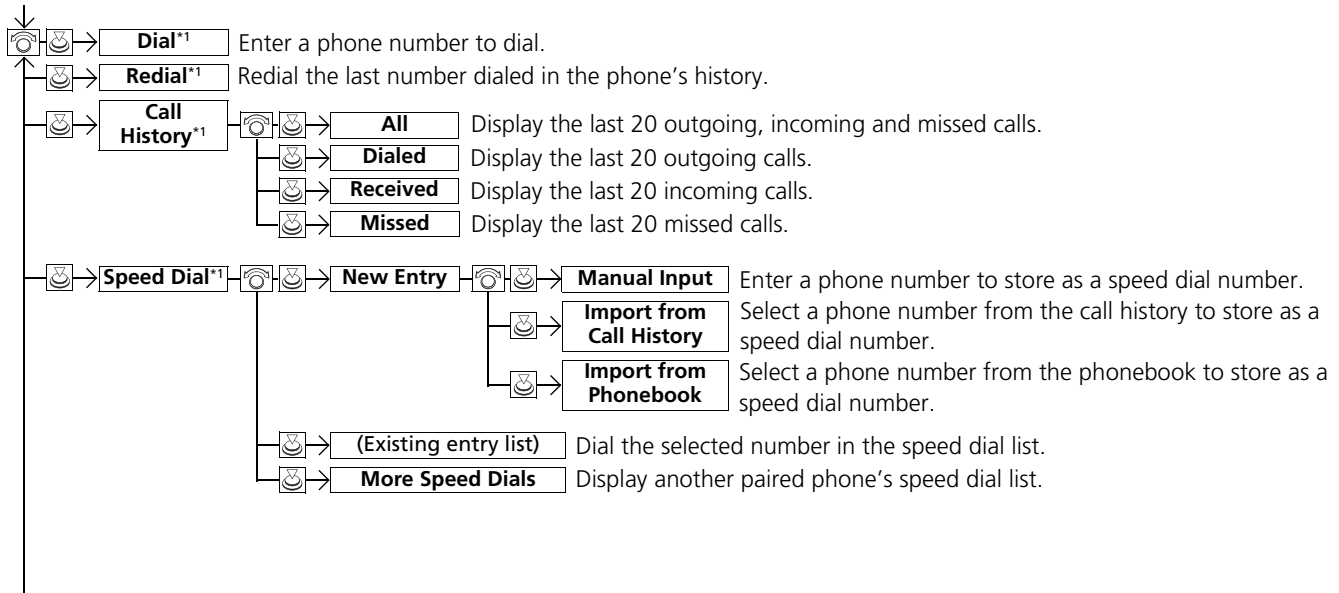

\*1: Appears only when a phone is connected to HFL.

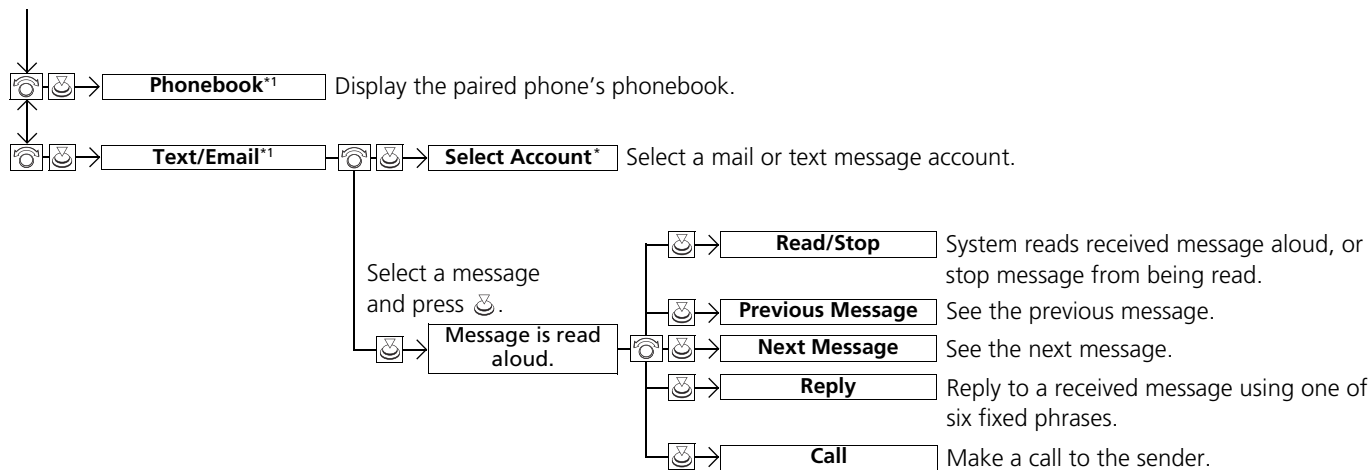

\*1: Appears only when a phone is connected to HFL.

## Phone Setup



### ■ To pair a cell phone (when there is no phone paired to the system)

1. Go to the Phone screen.  
 ▶ **Phone screen** P. 337
2. Rotate to select **Yes**, then press .
3. Make sure your phone is search or discoverable mode, then press .  
 ▶ HFL automatically searches for a *Bluetooth* device.
4. When your phone appears on the list, select it by pressing .  
 ▶ If your phone does not appear, you can select **Refresh** to search again.  
 ▶ If your phone still does not appear, select **Phone Not Found** and search for *Bluetooth* devices using your phone.  
 From your phone, select **HandsFreeLink**.
5. HFL gives you a pairing code on the audio/information screen.  
 ▶ Confirm if the pairing code on the screen and your phone match.  
 This may vary by phone.
6. You will receive a notification on the screen if pairing is successful.

## ☒ Phone Setup

Your *Bluetooth*-compatible phone must be paired to HFL before you can make and receive hands-free calls.

### Phone Pairing Tips:

- You cannot pair your phone while the vehicle is moving.
- Up to six phones can be paired.
- Your phone's battery may drain faster when it is paired to HFL.
- If your phone is not ready for pairing or not found by the system within three minutes, the system will time out and returns to idle.

Once you have paired a phone, you can see it displayed on the screen with one or two icons on the right side.

These icons indicate the following:

: The phone can be used with HFL.

: The phone is compatible with *Bluetooth*® Audio.

When pairing is completed, an **Automatic Phone Sync** prompt appears. Select **On** if you want your call history and phonebook automatically imported to HFL.

▶ **Changing the Automatic Phone Sync setting** P. 349

Continued

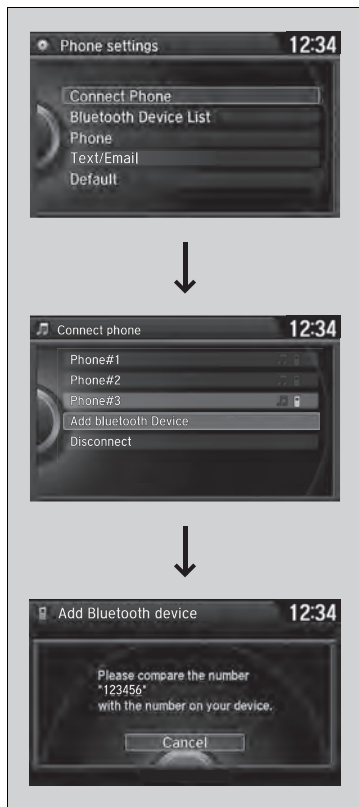

■ **To pair a cell phone (when a phone has already been paired to the system)**

1. Go to the **Phone Settings** screen.
  - ▶ **Phone Settings screen** P. 334
2. Rotate to select **Connect Phone**, then press .
  - ▶ Repeat the procedure to select **Add Bluetooth Device**.
3. Make sure your phone is in search or discoverable mode, then press .
  - ▶ HFL automatically searches for a *Bluetooth* device.
4. When your phone appears on the list, select it by pressing .
  - ▶ If your phone does not appear, you can select **Refresh** to search again.
  - ▶ If your phone still does not appear, select **Phone Not Found** and search for *Bluetooth* devices using your phone. From your phone, select **HandsFreeLink**.
5. HFL gives you a pairing code on the audio/ information screen.
  - ▶ Confirm if the pairing code on the screen and your phone match. This may vary by phone.
6. You will receive a notification on the screen if pairing is successful.



### ■ To change the pairing code setting

1. Press the **DISP** button.
2. Rotate to select **Settings**, then press .
3. Rotate to select **System Settings**, then press .
  - ▶ Repeat the procedure to select **Bluetooth**, then **Edit Pairing Code**.
4. Rotate to select **Fixed** or **Random**, then press .

### ☒ To change the pairing code setting

The pairing code may be six or four digits depending on your phone.

The default pairing code is **0000** until you change the setting.

To create your own, select **Fixed**, and delete the current code, then enter a new one.

For a randomly generated pairing code each time you pair a phone, select **Random**.

Continued



### ■ To replace an already-paired phone with a new phone

1. Go to the **Phone Settings** screen.
  - ▶ **Phone Settings screen** P. 334
2. Rotate to select **Bluetooth Device List**, then press .
3. Rotate to select a paired phone you want to replace, then press .
4. Rotate to select **Replace This Device**, then press .
5. HFL enters the pairing process and searches a new phone.
  - ▶ Follow the prompts to pair a new phone.
6. You will receive a notification on the screen if pairing is successful.

### ▶▶ To replace an already-paired phone with a new phone

The replaced phone will keep the same speed dial entries, call history, and security PIN information from the previously paired phone.









### ■ To delete a paired phone

1. Go to the **Phone Settings** screen.
  - ▶ **Phone Settings screen** P. 334
2. Rotate to select **Bluetooth Device List**, then press .
3. Rotate to select a phone you want to delete, then press .
4. Rotate to select **Delete This Device**, then press .
5. You will receive a confirmation message on the screen. Rotate to select **Yes**, then press .
6. You will receive a notification on the screen if it is successful.

## ■ To Set Up a Text Message/Email Options



### ■ To turn on or off the text/E-mail function

1. Go to the **Phone Settings** screen.
    - ▶ **Phone Settings screen** P. 334
  2. Rotate  to select **Text/Email**, then press .
  - ▶ Repeat the procedure to select **Enable Text/Email**.
  - ▶ A pop-up menu appears on the screen.
3. Rotate  to select **On** or **Off**, then press .

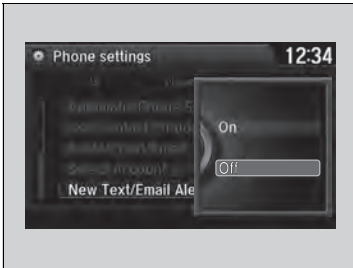

■ **To turn on or off the text/E-mail notice**

1. On the **Text/Email** screen, rotate to select **New Text/Email Alert**, then press .
- ▶ A pop-up menu appears on the screen.
2. Rotate to select **On** or **Off**, then press .

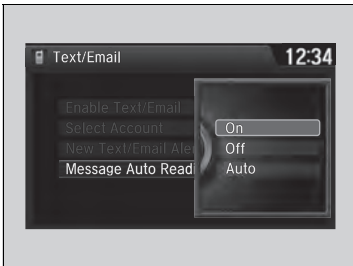

■ **To set up the auto reading option**

1. On the **Text Message** or the **Text/Email** screen, rotate to select **Message Auto Reading**, then press .
- ▶ A pop-up menu appears on the screen.
2. Rotate to select **On**, **Off** or **Auto** then press .

☒ To turn on or off the text/E-mail notice

- On:** A pop-up notification comes on every time you receive a new message.
- Off:** The message you receive is stored in the system without notification.

☒ To set up the auto reading option

- On:** A text message/Email is always read aloud.
- Off:** A text message/Email is not read aloud.
- Auto:** A text message/Email is read aloud only when driving.

Continued

## ■ To Create a Security PIN

You can protect each of the six cell phones with a security PIN.



1. Go to the **Phone Settings** screen.
  - ▶ **Phone Settings screen** P. 334
2. Rotate to select **Bluetooth Device List**, then press .
3. Rotate to select a phone you want to add a security PIN to, then press .
4. Rotate to select **Edit PIN**, then press .
5. Enter a new four-digit number.
  - ▶ Rotate to select, then press . Select to delete. Select **OK** to enter the security PIN.
6. Re-enter the four-digit number.
  - ▶ The screen returns to the screen in step 4.





## ▶▶ To Create a Security PIN

If the phone is already security PIN protected, you need to enter the current security PIN before clearing the PIN or creating a new one.

## Automatic Transferring

If you get into the vehicle while you are on the phone, the call can be automatically transferred to HFL.







1. Go to the **Phone Settings** screen.  
 ▶ **Phone Settings screen** P. 334
2. Rotate  to select **Phone**, then press .  
 ▶ Repeat the procedure to select **Auto Transfer**.
3. Rotate  to select **On**, then press .

## Auto Answer

You can set HFL to automatically answer an incoming call in four seconds.



1. Go to the **Phone Settings** screen.  
 ▶ **Phone Settings screen** P. 334
2. Rotate  to select **Phone**, then press .  
 ▶ Repeat the procedure to select **Auto Answer**.
3. Rotate  to select **On**, then press .

## ■ Ring Tone

You can change the ring tone setting.

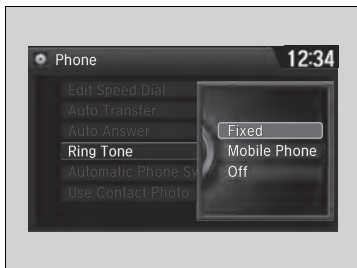

1. Go to the **Phone Settings** screen.  
▶ **Phone Settings screen** P. 334
2. Rotate to select **Phone**, then press .
- ▶ Repeat the procedure to select **Ring Tone**.
3. Rotate to select **Fixed**, **Mobile Phone** or **Off**, then press .

## ⌘ Ring Tone

**Fixed:** The fixed ring tone sounds from the speaker.

**Mobile Phone:** The ring tone stored in the connected cell phone sounds from the speaker.

**Off:** No ring tones sound from the speaker.

## Automatic Import of Cellular Phonebook and Call History

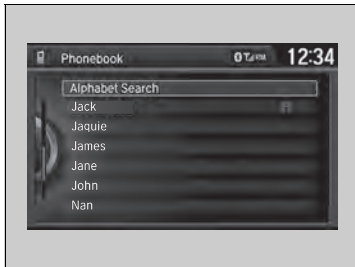

### ■ When Automatic Phone Sync is set to On:

When your phone is paired, the contents of its phonebook and call history are automatically imported to HFL.

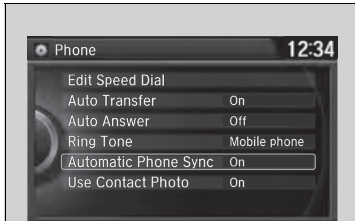

### ■ Changing the Automatic Phone Sync setting

1. Go to the **Phone Settings** screen.  
 ▶ **Phone Settings screen** P. 334
2. Rotate to select **Phone**, then press .  
 ▶ Repeat the procedure to select **Automatic Phone Sync**.
3. Rotate to select **On** or **Off**, then press .

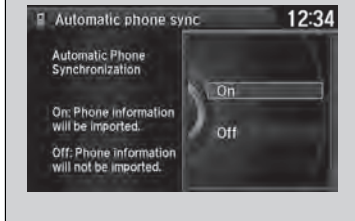

### ⊗ Automatic Import of Cellular Phonebook and Call History

When you select a person from the list in the cellular phonebook, you can see up to three category icons. The icons indicate what types of numbers are stored for that name.

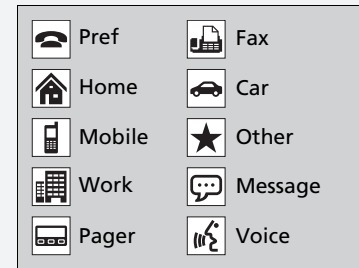

On some phones, it may not be possible to import the category icons to HFL.

The phonebook is updated after every connection. Call history is updated after every connection or call.

Continued

## ■ Speed Dial

Up to 20 speed dial numbers can be stored per phone.

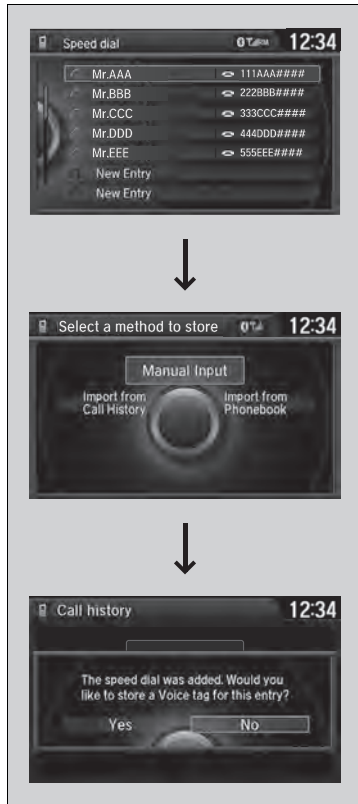

To store a speed dial number:

1. Go to the Phone screen.  
 ▶ **Phone screen** P. 337
2. Rotate to select **Speed Dial**, then press .  
 ▶ Repeat the procedure to select **New Entry**.
3. Rotate to select a place to choose a number from, then press .  
 From **Import from Call History**:  
 ▶ Select a number from the call history.  
 From **Manual Input**:  
 ▶ Input the number manually.  
 From **Import from Phonebook**:  
 ▶ Select a number from the linked cell phone's imported phonebook.
4. When the speed dial is successfully stored, you are asked to create a voice tag for the number. Rotate to select **Yes** or **No**, then press .
5. Using the button, follow the prompts to store a voice tag for the speed dial entry.

## ▶▶ Speed Dial

When a voice tag is stored, press the button to call the number using the voice tag. Say "Call" and the voice tag name.





■ **To add a voice tag to a stored speed dial number**

1. Go to the **Phone Settings** screen.
  - ▶ **Phone Settings screen** P. 334
2. Rotate to select **Phone**, then press .
  - ▶ Repeat the procedure to select **Edit Speed Dial**.
3. Select an existing speed dial entry.
  - ▶ From the pop-up menu, rotate to select **Edit**, then press .
4. Rotate to select **Voice Tag**, then press .
  - ▶ From the pop-up menu, rotate to select **Record**, then press .
5. Using the button, follow the prompts to complete the voice tag.

☒ Speed Dial

Avoid using duplicate voice tags.  
 Avoid using "home" as a voice tag.  
 It is easier for HFL to recognize a longer name. For example, use "John Smith" instead of "John."

Continued

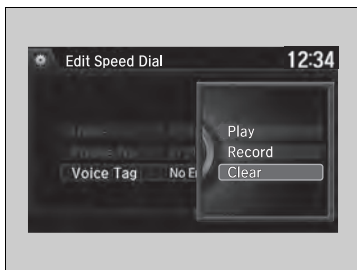

■ **To delete a voice tag**

1. Go to the **Phone Settings** screen.
  - ▶ **Phone Settings screen** P. 334
2. Rotate to select **Phone**, then press .
  - ▶ Repeat the procedure to select **Edit Speed Dial**.
3. Select an existing speed dial entry.
  - ▶ From the pop-up menu, rotate to select **Edit**, then press .
4. Rotate to select **Voice Tag**, then press .
  - ▶ From the pop-up menu, rotate to select **Clear**, then press .
5. You will receive a confirmation message on the screen. Rotate to select **Yes**, then press .



■ **To delete a speed dial**

1. Go to the **Phone Settings** screen.
  - ▶ **Phone Settings screen** P. 334
2. Rotate to select **Phone**, then press .
  - ▶ Repeat the procedure to select **Edit Speed Dial**.
3. Select an existing speed dial entry.
  - ▶ From the pop-up menu, rotate to select **Delete**, then press .
4. You will receive a confirmation message on the screen. Rotate to select **Yes**, then press .

## Making a Call



You can make calls by inputting any phone number, or by using the imported phonebook, call history, speed dial entries, or redial.

### ☒ Making a Call

Any voice-tagged speed dial entry, phonebook name, or number can be dialed by voice from most screens. Press the  button and say "Call" and the voice tag name, "Call by name" and the phonebook name, or the phone number.

The maximum range between your phone and vehicles is 30 feet (10 meters).

Once a call is connected, you can hear the voice of the person you are calling through the audio speakers.

Continued



### ■ To make a call using the imported phonebook

1. Go to the Phone screen.
  - ▶ **Phone screen** P. 337
2. Rotate to select **Phonebook**, then press .
3. Rotate to select a name, then press .
  - ▶ You can also search by letter. Rotate to select **Alphabet Search**, then press .
4. Rotate to select a number, then press .
  - ▶ Dialing starts automatically.

### ▶▶ To make a call using the imported phonebook

This function is disabled while the vehicle is moving. However, you can call a stored voice-tagged speed dial number using voice commands.

- ▶ **Limitations for Manual Operation** P. 333
- ▶ **Speed Dial** P. 350



### ■ To make a call using a phone number

1. Go to the Phone screen.  
 ▶ **Phone screen** P. 337
2. Rotate to select **Dial**, then press .
3. Rotate to select a number, then press .
4. Rotate to select , then press .  
 ▶ Dialing starts automatically.



### ■ To make a call using redial

1. Go to the Phone screen.  
 ▶ **Phone screen** P. 337
2. Rotate to select **Redial**, then press .  
 ▶ Dialing starts automatically.

### ☒ To make a call using a phone number

This function is disabled while the vehicle is moving. However, you can call a stored voice-tagged speed dial number, phonebook name, or number using voice commands.

- ▶ **Limitations for Manual Operation** P. 333
- ▶ **Speed Dial** P. 350

### ☒ To make a call using redial

Press and hold the button to redial the last number dialed in your phone's history.









### ■ To make a call using the call history

Call history is stored by **All**, **Dialed**, **Received**, and **Missed**.

1. Go to the Phone screen.

▶ **Phone screen** P. 337

2. Rotate  to select **Call History**, then press .
  3. Rotate  to select **All**, **Dialed**, **Received**, or **Missed**, then press .
  4. Rotate  to select a number, then press .
- ▶ Dialing starts automatically.



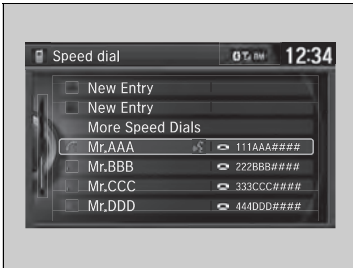

### ▶▶ To make a call using the call history

The call history displays the last 20 dialed, received, or missed calls.

(Appears only when a phone is connected to HFL.)



■ **To make a call using a speed dial entry**

1. Go to the Phone screen.  
 ▶ **Phone screen** P. 337
2. Rotate  to select **Speed Dial**, then press .
3. Rotate  to select a number, then press .  
 ▶ Dialing starts automatically.

☒ To make a call using a speed dial entry

Select **More Speed Dials** to view another paired phone's speed dial list. You can make a call from that list using the currently connected phone.

When a voice tag is stored, press the  button to call the number using the voice tag.

▶ **Speed Dial** P. 350

Any voice-tagged speed dial entry, phonebook name, or number can be dialed by voice from any screen. Press the  button and follow the prompts.

## Receiving a Call

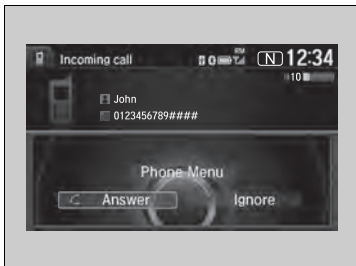

When there is an incoming call, an audible notification sounds (if activated) and the **Incoming Call** screen appears.

Press the  button to answer the call.

Press the  button to decline or end the call.

## Receiving a Call

### Call Waiting

Press the  button to put the current call on hold to answer the incoming call.

Press the  button again to return to the current call.

Ignore the incoming call if you do not want to answer it.

Press the  button if you want to hang up the current call.



## Options During a Call

The following options are available during a call.



**Mute:** Mute your voice.

**Transfer:** Transfer a call from HFL to your phone.

**Touch Tones:** Send numbers during a call. This is useful when you call a menu-driven phone system.



The available options are shown on the lower half of the screen.

Rotate  to select the option, then press .

- ▶ The mute icon appears when **Mute** is selected. Select **Mute** again to turn it off.

## Options During a Call



**Touch Tones:** Available on some phones.

## ■ Receiving a Text Message/E-mail

HFL can display newly received text messages as well as 20 of the most recently received messages on a linked cell phone. Each received message can be read aloud and replied to using a fixed common phrase.

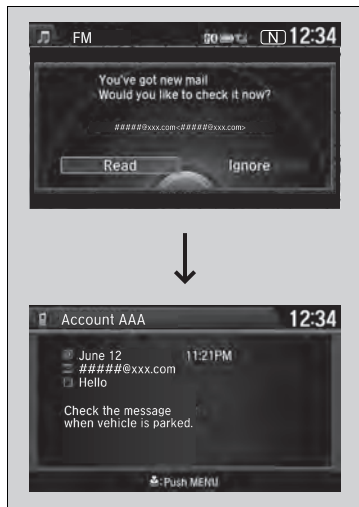
HFL can also display E-mails.



1. A pop-up appears and notifies you of a new text message or E-mail.
2. Rotate  to select **Read** to listen to the message, then press .
  - ▶ The text message or E-mail is displayed. The system automatically starts reading out the message.
3. To discontinue the message read-out, press .

## ☞ Receiving a Text Message/E-mail

The system does not display any received messages while you are driving. You can only hear them read aloud.

With some phones, you may be able to display up to 20 most recent text messages and E-mails.

State or local laws may limit your use of the HFL text message/E-mail feature. Only use the text message/E-mail feature when conditions allow you to do so safely.

When you receive a text message or E-mail for the first time after the phone is paired to HFL, you are asked to turn the **New Text/Email Alert** setting to **On**.

☞ **To turn on or off the text/E-mail notice**  
P. 345

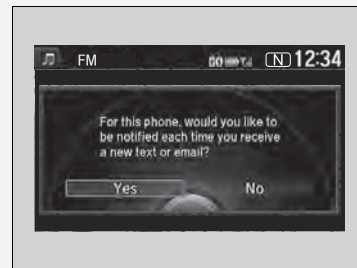

## Selecting a Mail Account

If a paired phone has text message or mail accounts, you can select one of them to be active and receive notifications.

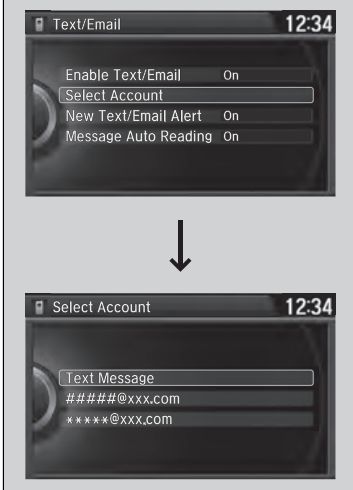

1. Go to the **Phone Settings** screen.  
 ▶ **Phone Settings screen** P. 334
2. Rotate to select **Text/Email**, then press .
- ▶ Repeat the procedure to select **Select Account**.
3. Rotate to select **Text message** or an E-mail account you want, then press .

## Selecting a Mail Account

You can also select a mail account from the folder list screen or the message list screen.

Rotate to select **Select Account** on the top of the list, then press .

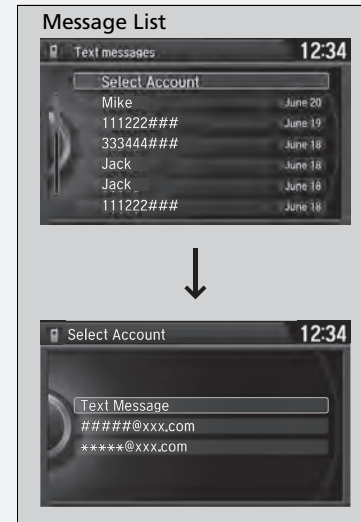

You can only receive notifications from one text message or mail account at a time.

## ■ Displaying Messages

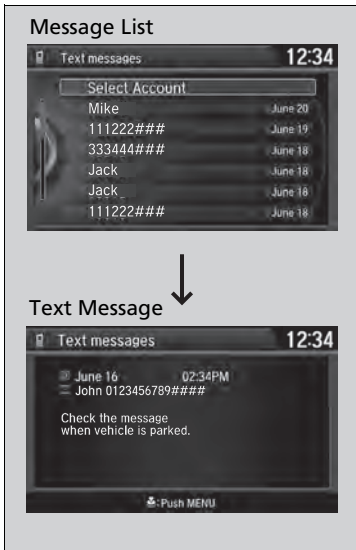

### ■ Displaying text messages

1. Go to the Phone screen.
  - ▶ **Phone screen** P. 337
2. Rotate to select **Text/Email**, then press .
  - ▶ Select account if necessary.
3. Rotate to select a message, then press .
  - ▶ The text message is displayed. The system automatically starts reading the message aloud.

### ▶▶ Displaying Messages

The icon appears next to an unread message.

If you delete a message on the phone, the message is also deleted in the system. If you send a message from the system, the message goes to your phone's mailbox.

To see the previous or next message, press on the text message screen. From the pop-up menu, rotate to select **Previous Message** or **Next Message**, then press .

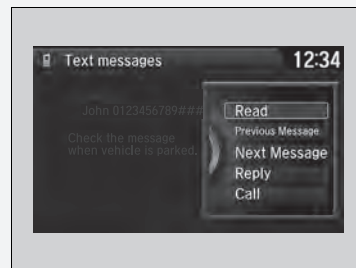



### ■ Displaying E-mails



1. Go to the Phone screen.  
 ▶ Phone screen P. 337
2. Rotate to select **Text/Email**, then press .
- ▶ Select account if necessary.
3. Rotate to select a folder, then press .
4. Rotate to select a message, then press .
- ▶ The E-mail is displayed. The system automatically starts reading the message aloud.

### ⌘ Displaying E-mails

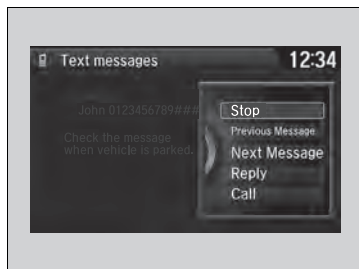
Received text messages and E-mails may appear in the message list screen at the same time. In this case, text messages are titled **No Subject**.



### ■ Using the Stop or Read option

1. Go to the text message or E-mail screen.
  - ▶ The system automatically starts reading the message aloud.
  - **Displaying Messages** P. 362
2. Press  to have the pop-up menu appear on the screen.
3. Rotate  to select **Stop** or **Read**, then press .

### ▣ Using the Stop or Read option

This option changes to:

- **Stop** while the text message/E-mail is read out. Select this option to discontinue the message read out.
- **Read** when the system has finished reading out the text message/E-mail, or after you selected **Stop**. Select this option to hear the system read out the selected message.



### ■ Reply to a message

1. Go to the text message or E-mail screen.
  - ▶ The system automatically starts reading the message aloud.
    - **Displaying Messages** P. 362
2. Press to have the pop-up menu appear on the screen.
3. Rotate to select **Reply**, then press .
4. Rotate to select the reply message, then press .
  - ▶ The pop-up menu appears on the screen.
5. Select **Send** to send the message.
  - ▶ **Complete** appears on the screen when the reply message was successfully sent.

### ☒ Reply to a message



The available fixed reply messages are as follows:

- **Talk to you later, I'm driving.**
- **I'm on my way.**
- **I'm running late.**
- **OK**
- **Yes**
- **No**

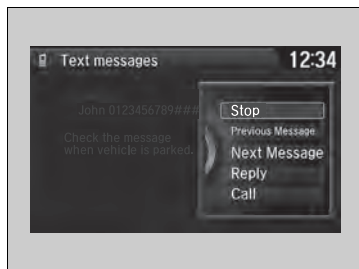
You cannot add, edit, or delete reply messages.



### ■ Making a call to a sender

1. Go to the text message screen.
  - ▶ The system automatically starts reading the message aloud.
  - **Displaying text messages** P. 362
2. Press  to have the pop-up menu appear on the screen.
3. Rotate  to select **Call**, then press .





## Models with navigation system

Bluetooth® HandsFreeLink® (HFL) allows you to place and receive phone calls using your vehicle's navigation system, without handling your cell phone.

## Using HFL

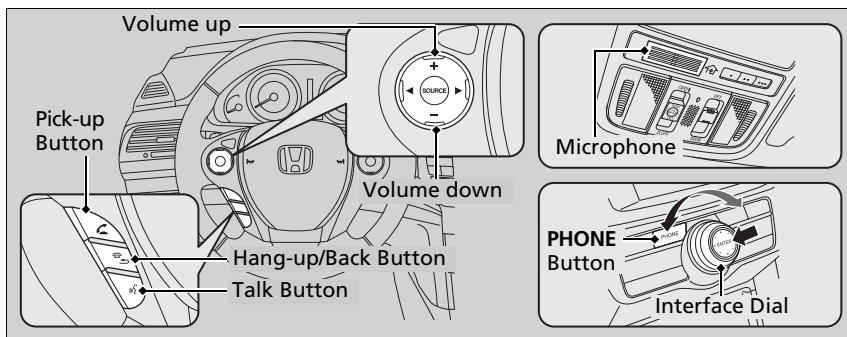
### HFL Buttons







 **(Pick-up) button:** Press to go to the **Phone Call** screen or to answer an incoming call.

 **(Hang-up/back) button:** Press to end a call or to cancel a command.

 **(Talk) button:** Press to give HFL voice commands.

**PHONE button:** Press to go directly to the Phone screen.

**Interface dial:** Rotate  to select an item on the screen, then press . Move ,  or  to select secondary menu.

## Bluetooth® HandsFreeLink®

To use HFL, you need a *Bluetooth*-compatible cell phone. For a list of compatible phones, pairing procedures, and special feature capabilities:

- U.S.: Visit [www.handsfreelink.honda.com](http://www.handsfreelink.honda.com), or call (888) 528-7876.
- Canada: Visit [www.handsfreelink.ca](http://www.handsfreelink.ca), or call (888) 528-7876.

To use HFL, the **Bluetooth** setting must be **On**.

 **Customized Features\*** P. 281

Voice control tips

- Aim the vents away from the ceiling and close the windows, as noise coming from them may interfere with the microphone.
- Press and release the  button when you want to call a number using a stored voice tag, a phonebook name, or a number. Speak clearly and naturally after a beep.
- If the microphone picks up voices other than yours, the command may be misinterpreted.
- To change the volume level, use the audio system's volume knob or the remote audio controls on the steering wheel.

State or local laws may prohibit the operation of handheld electronic devices while operating a vehicle.

## ■ HFL Status Display

The audio/information screen notifies you when there is an incoming call.

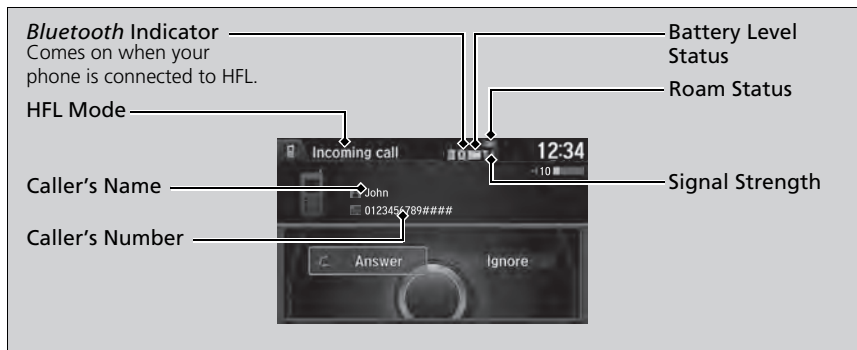

## ■ Limitations for Manual Operation

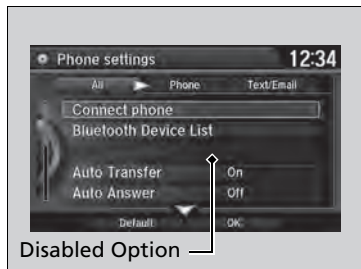

Certain manual functions are disabled or inoperable while the vehicle is in motion. You cannot select a grayed-out option until the vehicle is stopped.

Only previously stored speed dial entries with voice tags, phonebook names, or numbers can be called using voice commands while the vehicle is in motion.

▶ **Speed Dial** P. 385

## ▶▶ Bluetooth® HandsFreeLink®

**Bluetooth® Wireless Technology**  
The *Bluetooth®* word mark and logos are registered trademarks owned by Bluetooth SIG, Inc., and any use of such marks by Honda Motors Co., Ltd., is under license. Other trademarks and trade names are those of their respective owners.

**HFL Limitations**  
An incoming call on HFL will interrupt the audio system when it is playing. It will resume when the call is ended.

## ▶▶ HFL Status Display

The information that appears on the audio/information screen varies between phone models.

You can change the system language to English, French, or Spanish.

▶ **Customized Features\*** P. 281

# HFL Menus

The ignition switch must be in ACCESSORY  or ON \*1 to use HFL.

## ■ Phone Settings screen



1. Press the **SETTINGS** button.
2. Rotate  to select **Phone Settings**, then press .

**HFL Menus**

To use HFL, you must first pair your *Bluetooth*-compatible cell phone to the system while the vehicle is parked.

Some functions are limited while driving. A message appears on the screen when the vehicle is moving and the operation is canceled.

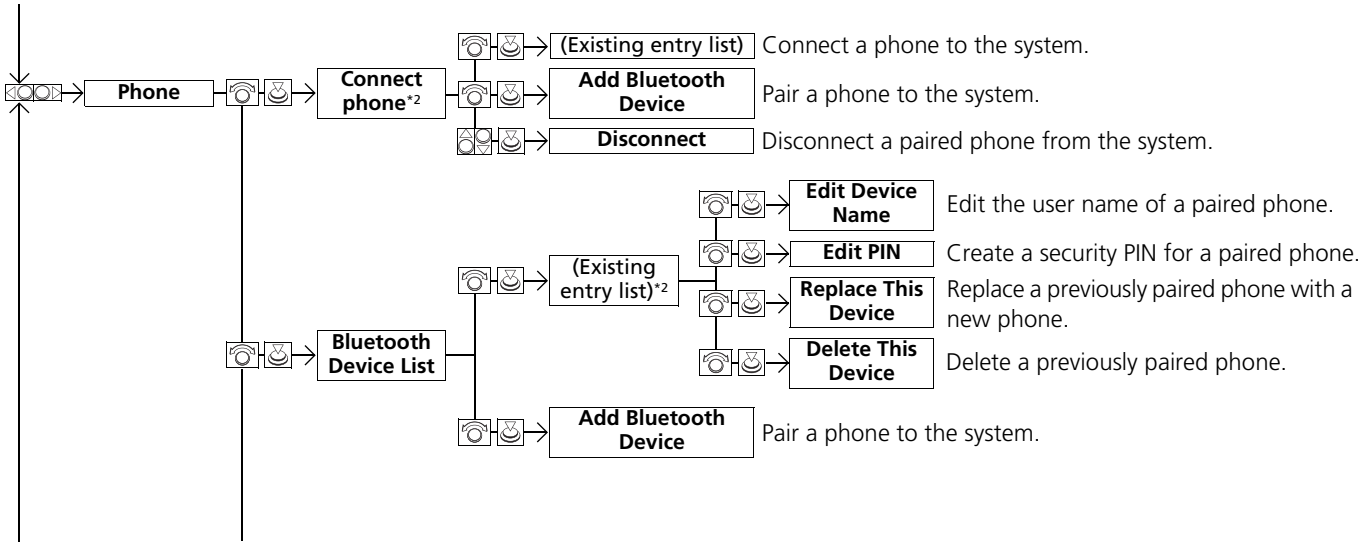

\*1: Models with the smart entry system have an **ENGINE START/STOP** button instead of an ignition switch.

\*2: Appears only when a phone is connected to HFL.

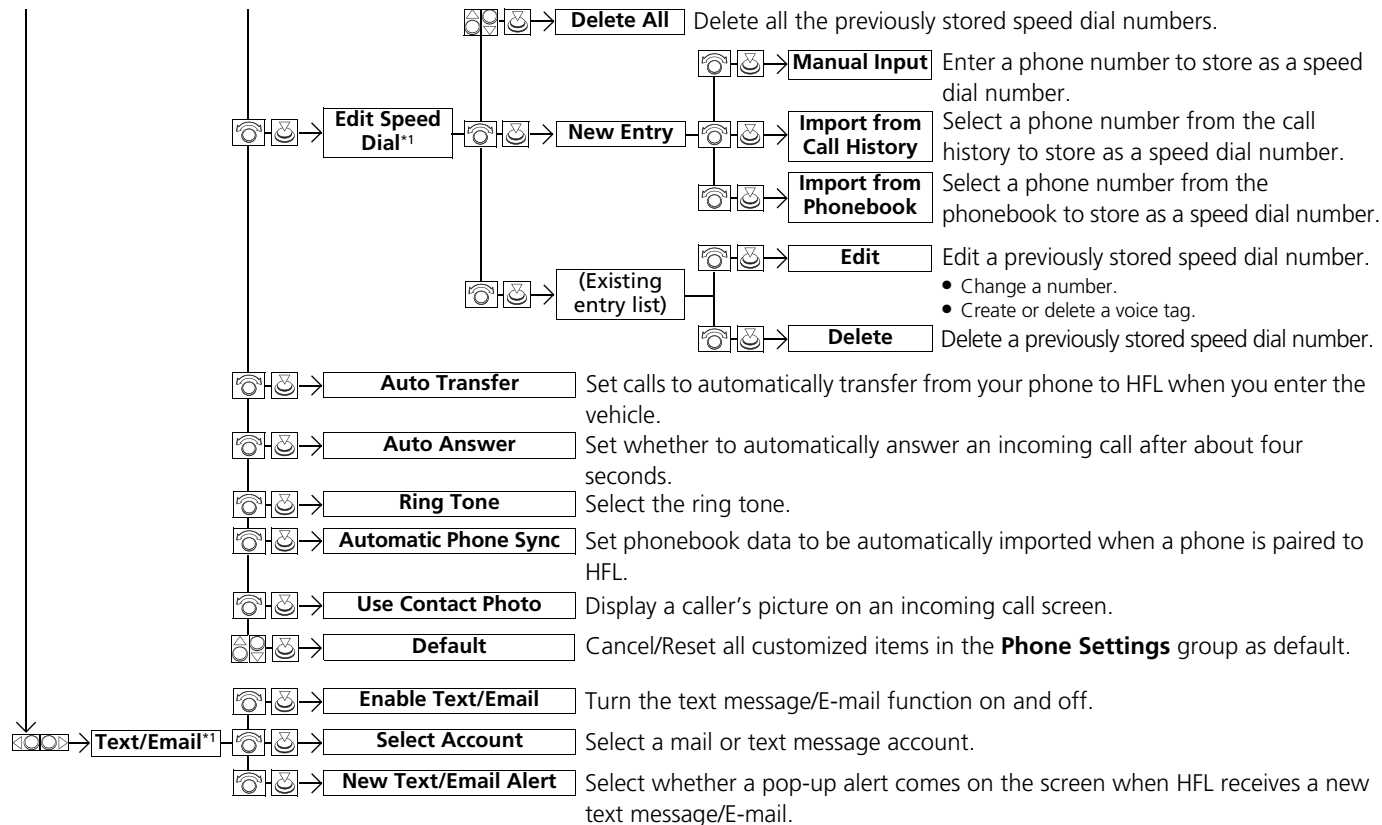

\*1: Appears only when a phone is connected to HFL.

## Phone screen



1. Press the **PHONE** button.
2. Press the **MENU** button to display the menu items.

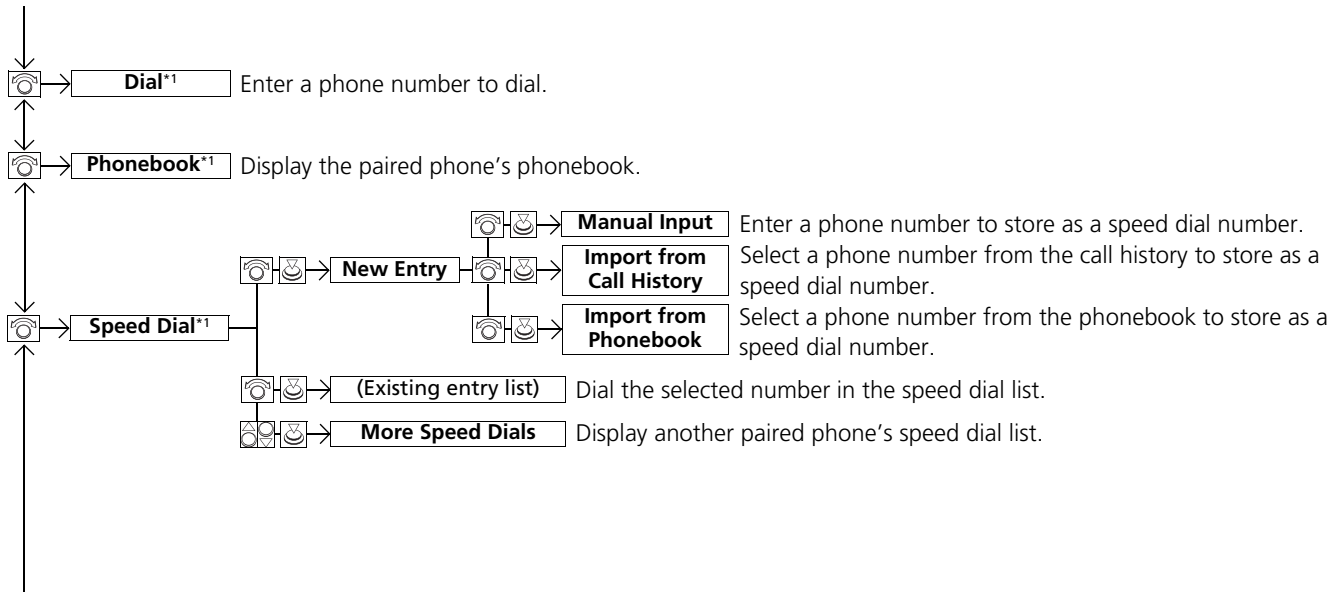

\*1: Appears only when a phone is connected to HFL.

Continued

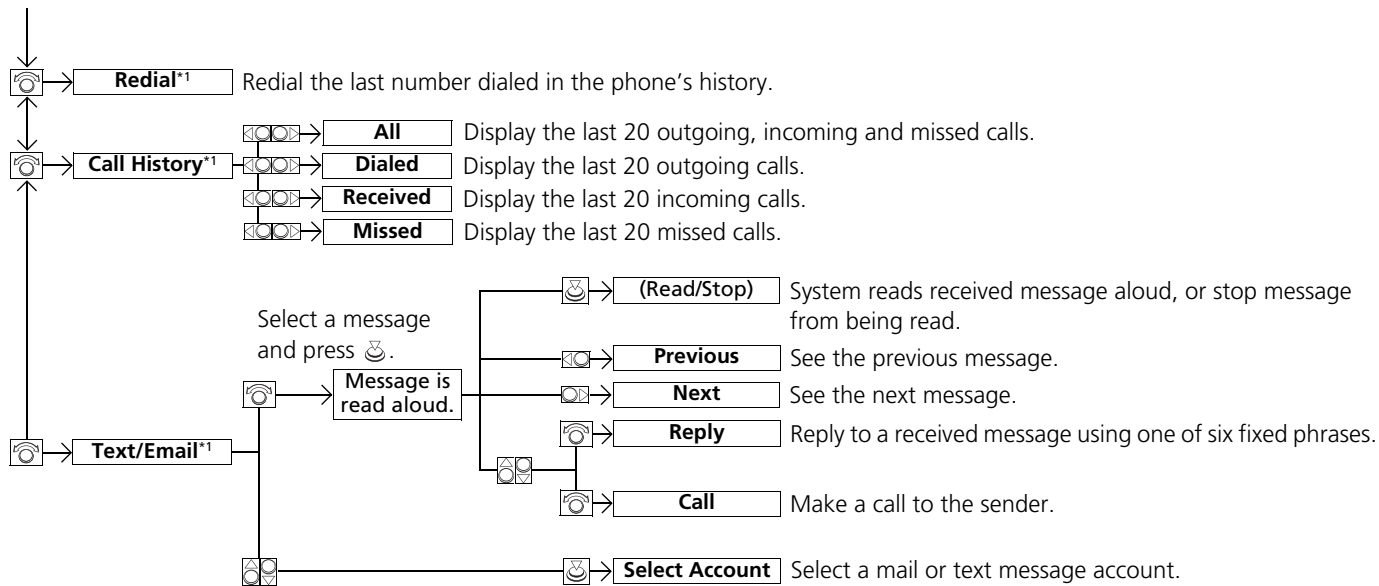

\*1: Appears only when a phone is connected to HFL.

## Phone Setup



### ■ To pair a cell phone (when there is no phone paired to the system)

1. Press the **PHONE** button.
2. Rotate to select **Yes**, then press .
3. Make sure your phone is search or discoverable mode, then press .
  - ▶ HFL automatically searches for a *Bluetooth* device.
4. When your phone appears on the list, select it by pressing .
  - ▶ If your phone does not appear, you can select **Refresh** to search again.
  - ▶ If your phone still does not appear, move to select **Phone Not Found?** and search for *Bluetooth* devices using your phone. From your phone, select **HandsFreeLink**.
5. HFL gives you a pairing code on the audio/information screen.
  - ▶ Confirm if the pairing code on the screen and your phone match. This may vary by phone.
6. You will receive a notification on the screen if pairing is successful.

## ☒ Phone Setup

Your *Bluetooth*-compatible phone must be paired to HFL before you can make and receive hands-free calls.

### Phone Pairing Tips:

- You cannot pair your phone while the vehicle is moving.
- Up to six phones can be paired.
- Your phone's battery may drain faster when it is paired to HFL.
- If your phone is not ready for pairing or not found by the system within three minutes, the system will time out and returns to idle.

Once you have paired a phone, you can see it displayed on the screen with one or two icons on the right side.

These icons indicate the following:

: The phone can be used with HFL.

: The phone is compatible with *Bluetooth*® Audio.

When pairing is completed, an **Automatic Phone Sync** prompt appears. Select **On** if you want your call history and phonebook automatically imported to HFL.

➤ **Changing the Automatic Phone Sync setting** P. 384

Continued

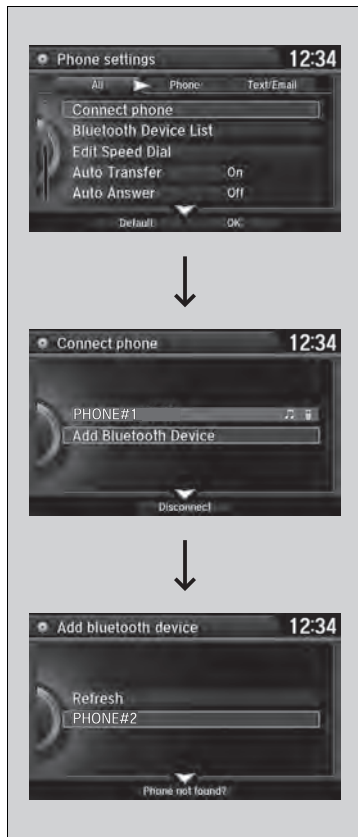

■ **To pair a cell phone (when a phone has already been paired to the system)**

1. Press the **SETTINGS** button.
2. Rotate to select **Phone Settings**, then press .
- ▶ Repeat the procedure to select **Connect Phone**, then **Add Bluetooth Device**.
3. Make sure your phone is in search or discoverable mode, then press .
- ▶ HFL automatically searches for a *Bluetooth* device.
4. When your phone appears on the list, select it by pressing .
- ▶ If your phone does not appear, you can select **Refresh** to search again.
- ▶ If your phone still does not appear, move to select **Phone Not Found?** and search for *Bluetooth* devices using your phone. From your phone, select **HandsFreeLink**.
5. HFL gives you a pairing code on the audio/ information screen.
- ▶ Confirm if the pairing code on the screen and your phone match.  
This may vary by phone.
6. You will receive a notification on the screen if pairing is successful.





■ **To change the pairing code setting**

1. Press the **SETTINGS** button.
2. Rotate to select **System Settings**, then press .
- ▶ Repeat the procedure to select **Edit Pairing Code**.
3. Rotate to select **Fixed** or **Random**, then press .

☒ To change the pairing code setting

The pairing code may be six or four digits depending on your phone.

The default pairing code is **0000** until you change the setting.

To create your own, select **Fixed**, and delete the current code, then enter a new one.

For a randomly generated pairing code each time you pair a phone, select **Random**.



■ **To replace an already-paired phone with a new phone**

1. Press the **SETTINGS** button.
2. Rotate to select **Phone Settings**, then press .
  - ▶ Repeat the procedure to select **Bluetooth Device List**.
3. Rotate to select a paired phone you want to replace, then press .
4. Rotate to select **Replace This Device**, then press .
5. HFL enters the pairing process and searches a new phone.
  - ▶ Follow the prompts to pair a new phone.
6. You will receive a notification on the screen if pairing is successful.

▶▶ To replace an already-paired phone with a new phone

The replaced phone will keep the same speed dial entries, call history, and security PIN information from the previously paired phone.

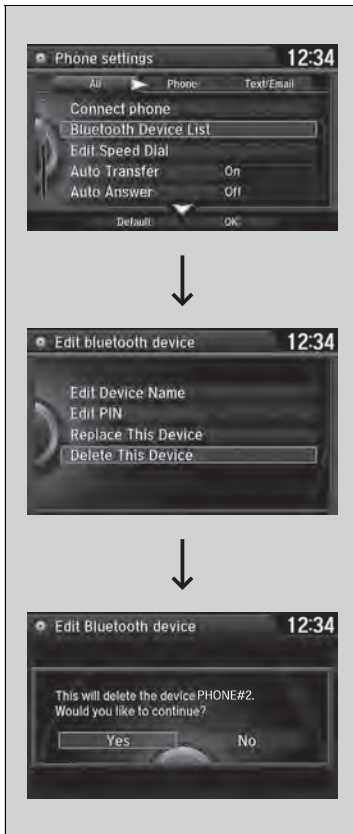

■ **To delete a paired phone**

1. Press the **SETTINGS** button.
2. Rotate to select **Phone Settings**, then press .
- ▶ Repeat the procedure to select **Bluetooth Device List**.
3. Rotate to select a phone you want to delete, then press .
4. Rotate to select **Delete This Device**, then press .
5. You will receive a confirmation message on the screen. Rotate to select **Yes**, then press .
6. You will receive a notification on the screen if it is successful.

## ■ To Set Up a Text Message/E-mail Options

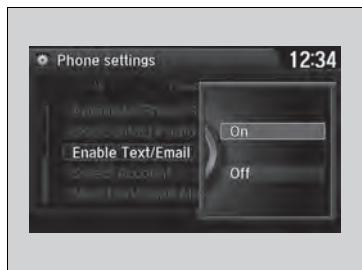

### ■ To turn on or off the text/E-mail function

1. Press the **SETTINGS** button.
2. Rotate to select **Phone Settings**, then press .
- ▶ Repeat the procedure to select **Enable Text/Email**.
- ▶ A pop-up menu appears on the screen.
3. Rotate to select **On** or **Off**, then press .

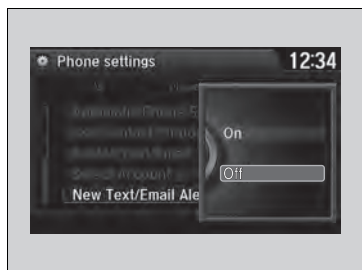

### ■ To turn on or off the text/E-mail notice





1. Press the **SETTINGS** button.
2. Rotate to select **Phone Settings**, then press .
- ▶ Repeat the procedure to select **New Text/Email Alert**.
- ▶ A pop-up menu appears on the screen.
3. Rotate to select **On** or **Off**, then press .

### ☒ To turn on or off the text/E-mail notice

- On:** A pop-up notification comes on every time you receive a new text message.
- Off:** The message you receive is stored in the system without notification.



■ **To set up the auto reading option**

1. Press the **SETTINGS** button.
2. Rotate  to select **System Settings**, then press .
  - ▶ Repeat the procedure to select **Message Auto Reading**.
  - ▶ A pop-up menu appears on the screen.
3. Rotate  to select **On**, **Off** or **Auto**, then press .

☒ To set up the auto reading option

- On:** A text message/Email is always read aloud.
- Off:** A text message/Email is not read aloud.
- Auto:** A text message/Email is read aloud only when driving.

## ■ To Create a Security PIN

You can protect each of the six cell phones with a security PIN.



1. Press the **SETTINGS** button.
2. Rotate to select **Phone Settings**, then press .
- ▶ Repeat the procedure to select **Bluetooth Device List**.
3. Rotate to select a phone you want to add a security PIN to, then press .
4. Rotate to select **Edit PIN**, then press .
5. Enter a new four-digit number.
  - ▶ Rotate to select, then press .
  - Move to delete. Rotate to select **OK** to enter the security PIN.
6. Re-enter the four-digit number.
  - ▶ The screen returns to the screen in step 4.

## ▶▶ To Create a Security PIN

If the phone is already security PIN protected, you need to enter the current security PIN before clearing the PIN or creating a new one.

## Editing User Name

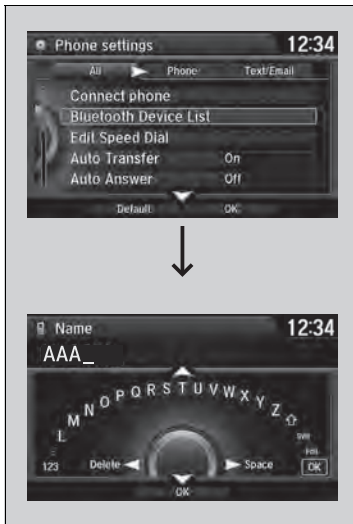

Edit the user name of a paired phone as follows:

1. Press the **SETTINGS** button.
2. Rotate to select **Phone Settings**, then press .
- ▶ Repeat the procedure to select **Bluetooth Device List**.
3. Rotate to select a phone you want to edit, then press .
4. Rotate to select **Edit Device Name**, then press .
5. Enter a new name of the phone.
  - ▶ Rotate to select, then press .
  - Move to delete. Rotate or move to select **OK** then press to enter the name.

## ■ Automatic Transferring

If you get into the vehicle while you are on the phone, the call can be automatically transferred to HFL.



1. Press the **SETTINGS** button.
2. Rotate to select **Phone Settings**, then press .
- ▶ Repeat the procedure to select **Auto Transfer**.
3. Rotate to select **On**, then press .

## ■ Auto Answer

You can set HFL to automatically answer an incoming call in four seconds.

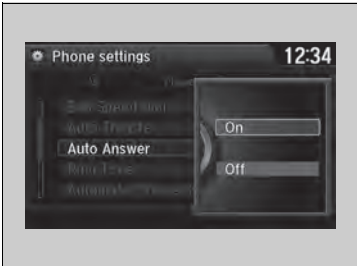





1. Press the **SETTINGS** button.
2. Rotate to select **Phone Settings**, then press .
- ▶ Repeat the procedure to select **Auto Answer**.
3. Rotate to select **On**, then press .

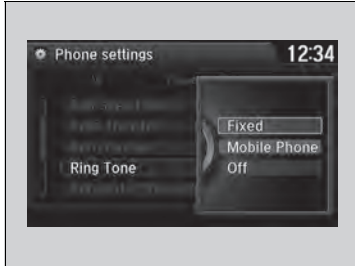

## Ring Tone

You can change the ring tone setting.



1. Press the **SETTINGS** button.
2. Rotate  to select **Phone Settings**, then press .
  - ▶ Repeat the procedure to select **Ring Tone**.
3. Rotate  to select **Fixed**, **Mobile Phone** or **Off**, then press .

### Ring Tone

**Fixed:** The fixed ring tone sounds from the speaker.

**Mobile Phone:** The ring tone stored in the connected cell phone sounds from the speaker.

**Off:** No ring tones sound from the speaker.

## ■ Automatic Import of Cellular Phonebook and Call History

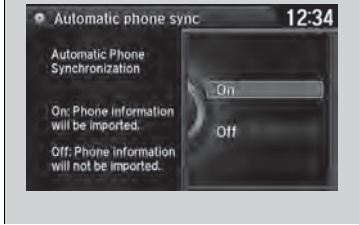
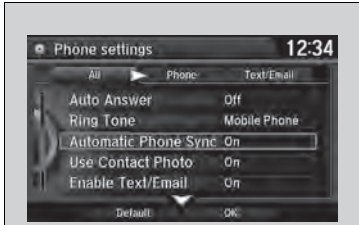

### ■ When Automatic Phone Sync is set to On:

When your phone is paired, the contents of its phonebook and call history are automatically imported to HFL.

### ■ Changing the Automatic Phone Sync setting

1. Press the **SETTINGS** button.
2. Rotate to select **Phone Settings**, then press .
- ▶ Repeat the procedure to select **Automatic Phone Sync**.
3. Rotate to select **On** or **Off**, then press .

## ▶▶ Automatic Import of Cellular Phonebook and Call History

When you select a person from the list in the cellular phonebook, you can see up to three category icons. The icons indicate what types of numbers are stored for that name.

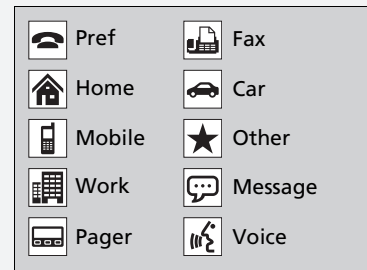

On some phones, it may not be possible to import the category icons to HFL.

The phonebook is updated after every connection. Call history is updated after every connection or call.

## Speed Dial

Up to 20 speed dial numbers can be stored per phone.

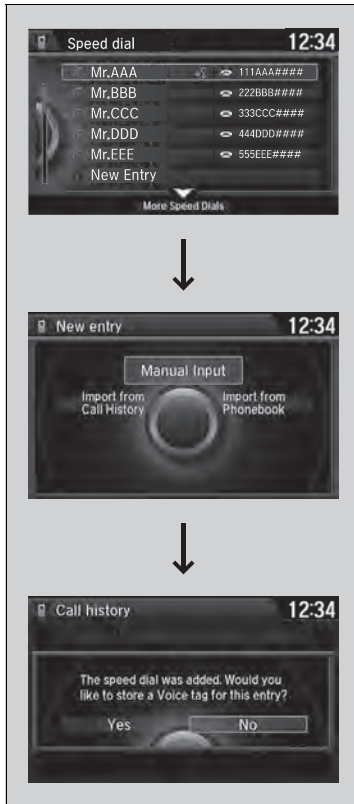

To store a speed dial number:

1. Press the **PHONE** button.
2. Press the **MENU** button.
3. Rotate to select **Speed Dial**, then press .
- ▶ Repeat the procedure to select **New Entry**.
4. Rotate to select a place to choose a number from, then press .
  - From **Import from Call History**:
    - ▶ Select a number from the call history.
  - From **Manual Input**:
    - ▶ Input the number manually.
  - From **Import from Phonebook**:
    - ▶ Select a number from the linked cell phone's imported phonebook.
5. When the speed dial is successfully stored, you are asked to create a voice tag for the number. Rotate to select **Yes** or **No**, then press .
6. Using the button, follow the prompts to store a voice tag for the speed dial entry.

### Speed Dial

When a voice tag is stored, press the button to call the number using the voice tag. Say "Call" and the voice tag name.



■ **To add a voice tag to a stored speed dial number**

1. Press the **SETTINGS** button.
2. Rotate to select **Phone Settings**, then press .
  - ▶ Repeat the procedure to select **Edit Speed Dial**.
3. Select an existing speed dial entry.
  - ▶ From the pop-up menu, rotate to select **Edit**, then press .
4. Rotate to select **Voice Tag**, then press .
  - ▶ From the pop-up menu, rotate to select **Record**, then press .
5. Using the button, follow the prompts to complete the voice tag.

☒ Speed Dial

Avoid using duplicate voice tags.  
 Avoid using "home" as a voice tag.  
 It is easier for HFL to recognize a longer name. For example, use "John Smith" instead of "John."

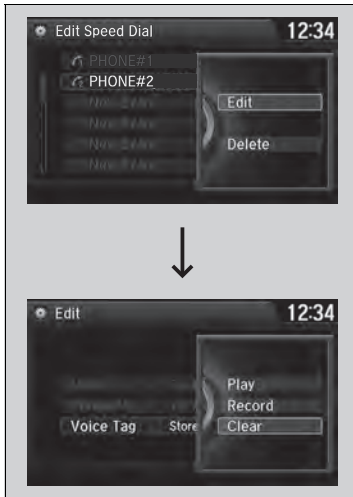

■ **To delete a voice tag**

1. Press the **SETTINGS** button.
2. Rotate to select **Phone Settings**, then press .
  - ▶ Repeat the procedure to select **Edit Speed Dial**.
3. Select an existing speed dial entry.
  - ▶ From the pop-up menu, rotate to select **Edit**, then press .
4. Rotate to select **Voice Tag**, then press .
  - ▶ From the pop-up menu, rotate to select **Clear**, then press .
5. You will receive a confirmation message on the screen. Rotate to select **Yes**, then press .



■ **To delete a speed dial**

1. Press the **SETTINGS** button.
2. Rotate to select **Phone Settings**, then press .
  - ▶ Repeat the procedure to select **Edit Speed Dial**.
3. Select an existing speed dial entry.
  - ▶ From the pop-up menu, rotate to select **Delete**, then press .
4. You will receive a confirmation message on the screen. Rotate to select **Yes**, then press .

Continued

## ■ Phonebook Phonetic Modification

Add phonetic modifications or a new voice tag to the phone's contact name so that it is easier for HFL to recognize voice commands.



### ■ To add a new voice tag

1. Press the **SETTINGS** button.
2. Rotate to select **System Settings**, then press .
3. Rotate to select **Phonebook Phonetic Modification**, then press .
4. Rotate to select the phone you want to add phonetic modification to, then press .

## ☒ Phonebook Phonetic Modification

Phonetic Modification is grayed out when **Song By Voice** is set to **Off**.

You can store up to 20 phonetic modification items.

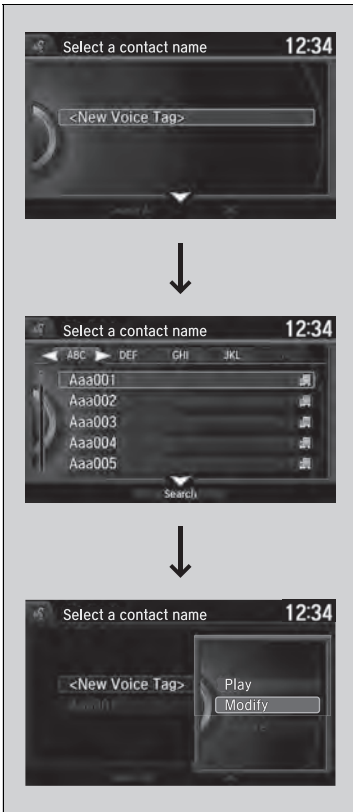

5. Rotate to select **New Voice Tag**, then press .
6. Move or and rotate to select a contact name, then press .
  - ▶ The pop-up menu appears on the screen.
7. Rotate to select **Modify**, then press .
8. Using the button, follow the prompts to complete the voice tag.
9. You will receive a confirmation message on the screen. Rotate to select **OK**, then press .



■ **To modify a voice tag**

1. Press the **SETTINGS** button.
2. Rotate to select **System Settings**, then press .
3. Rotate to select **Phonebook Phonetic Modification**, then press .
4. Rotate to select the phone you want to add phonetic modification to, then press .
5. Rotate to select a contact name you want to modify, then press .
  - ▶ The pop-up menu appears on the screen.
6. Rotate to select **Modify**, then press .
7. Using the button, follow the prompts to complete the voice tag.
8. You will receive a confirmation message on the screen. Rotate to select **OK**, then press .

▶▶ Phonebook Phonetic Modification

You cannot modify or delete a contact name if it is edited with a phone other than the phone connected to HFL.





■ **To delete a modified voice tag**

1. Press the **SETTINGS** button.
2. Rotate to select **System Settings**, then press .
3. Rotate to select **Phonebook Phonetic Modification**, then press .
4. Rotate to select the phone you want to delete phonetic modification, then press .
5. Rotate to select a contact name you want to delete, then press .
  - ▶ The pop-up menu appears on the screen.
6. Rotate to select **Delete**, then press .
7. Move and rotate to select **OK**, then press .



### ■ To delete all modified voice tags

1. Press the **SETTINGS** button.
2. Rotate to select **System Settings**, then press .
3. Rotate to select **Phonebook Phonetic Modification**, then press .
4. Rotate to select the phone you want to delete phonetic modification, then press .
  - ▶ The contact name list appears.
5. Move and rotate to select **Delete All**, then press .
6. You will receive a confirmation message on the screen. Rotate to select **Yes**, then press .

## Making a Call



You can make calls by inputting any phone number, or by using the imported phonebook, call history, speed dial entries, or redial.

### ☒ Making a Call

Any voice-tagged speed dial entry, phonebook name, or number can be dialed by voice from most screens. Press the  button and say "Call" and the voice tag name, "Call by name" and the phonebook name, or the phone number.

The maximum range between your phone and vehicles is 30 feet (10 meters).

Once a call is connected, you can hear the voice of the person you are calling through the audio speakers.

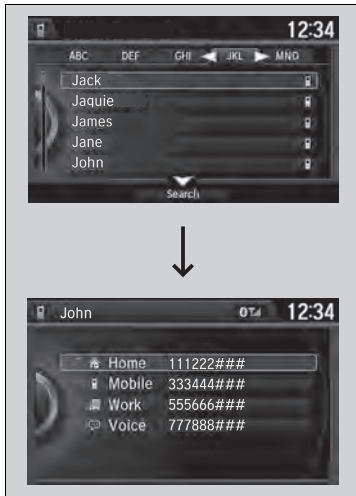

### ■ To make a call using the imported phonebook

1. Press the **PHONE** button.
  2. Press the **MENU** button.
  3. Rotate to select **Phonebook**, then press .
  4. The phonebook is stored alphabetically. Move to **Search**.
  5. Rotate to select a number, then press .
- ▶ Dialing starts automatically.

### ▶▶ To make a call using the imported phonebook

This function is disabled while the vehicle is moving. However, you can call a stored voice-tagged speed dial number, phonebook name, or number using voice commands.

- ▶ **Limitations for Manual Operation** P. 368
- ▶ **Speed Dial** P. 385



■ **To make a call using a phone number**

1. Press the **PHONE** button.
2. Press the **MENU** button.
3. Rotate to select **Dial**, then press .
4. Rotate to select a number, then press .
5. Rotate to select , then press .
  - ▶ Dialing starts automatically.



■ **To make a call using redial**

1. Press the **PHONE** button.
2. Press the **MENU** button.
3. Rotate to select **Redial**, then press .
  - ▶ Dialing starts automatically.

☒ To make a call using a phone number

This function is disabled while the vehicle is moving. However, you can call a stored voice-tagged speed dial number, phonebook name, or number using voice commands.

- ▶ **Limitations for Manual Operation** P. 368
- ▶ **Speed Dial** P. 385

☒ To make a call using redial

Press and hold the button to redial the last number dialed in your phone's history.

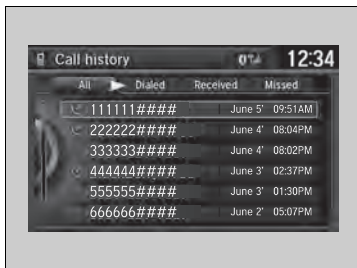

■ **To make a call using the call history**

1. Press the **PHONE** button.
2. Press the **MENU** button.
3. Rotate to select **Call History**, then press .
4. Move or to select **All, Dialed, Received, and Missed**.
5. Rotate to select a number, then press .
  - ▶ Dialing starts automatically.

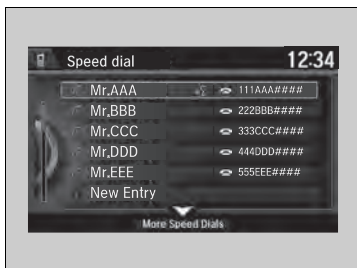

■ **To make a call using a speed dial entry**

1. Press the **PHONE** button.
2. Press the **MENU** button.
3. Rotate to select **Speed Dial**, then press .
4. Rotate to select a number, then press .
  - ▶ Dialing starts automatically.

▶▶ To make a call using the call history

The call history displays the last 20 dialed, received, or missed calls.  
(Appears only when a phone is connected to HFL.)

These icons next to the number indicate the following:

- : Dialed calls.
- : Received calls.
- : Missed calls.

▶▶ To make a call using a speed dial entry

Move to select **More Speed Dials** to view another paired phone's speed dial list. You can make a call from that list using the currently connected phone.

When a voice tag is stored, press the button to call the number using the voice tag.



**Speed Dial** P. 385

Any voice-tagged speed dial entry, phonebook name or number can be dialed by voice from any screen. Press the button and follow the prompts.

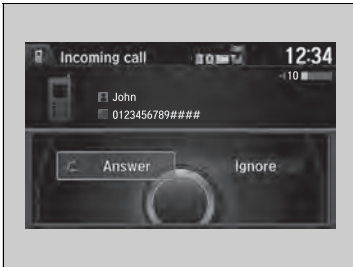
## Receiving a Call





When there is an incoming call, an audible notification sounds (if activated) and the **Incoming call** screen appears.

Press the  button to answer the call.  
Press the  button to decline or end the call.

## Receiving a Call

### Call Waiting

Press the  button to put the current call on hold to answer the incoming call.

Press the  button again to return to the current call.

Ignore the incoming call if you do not want to answer it.

Press the  button if you want to hang up the current call.

## ■ Options During a Call

The following options are available during a call.



**Mute:** Mute your voice.

**Transfer:** Transfer a call from HFL to your phone.

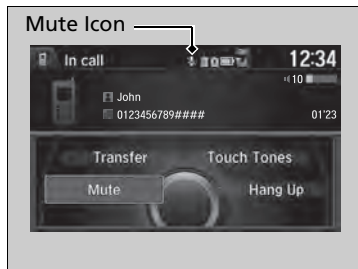
**Touch Tones:** Send numbers during a call. This is useful when you call a menu-driven phone system.



The available options are shown on the Phone screen.

Rotate  to select the option, then press .

- ▶ The mute icon appears when **Mute** is selected. Select **Mute** again to turn it off.

## ☞ Options During a Call

**Touch Tones:** Available on some phones.



## Receiving a Text Message/E-mail

HFL can display newly received text messages and E-mails as well as 20 of the most recently received messages on a linked cell phone. Each received message can be read aloud and replied to using a fixed common phrase.



1. A pop-up appears and notifies you of a new text message or E-mail.
2. Rotate to select **Read** to listen to the message, then press .
  - ▶ The text message or E-mail is displayed. The system automatically starts reading out the message.
3. To discontinue the message read-out, press .

## Receiving a Text Message/E-mail

The system does not display any received messages while you are driving. You can only hear them read aloud.

With some phones, you may be able to display up to 20 most recent text messages and E-mails.

State or local laws may limit your use of the HFL text message/E-mail feature. Only use the text message/E-mail feature when conditions allow you to do so safely.

When you receive a text message or E-mail for the first time since the phone is paired to HFL, you are asked to turn the **New Text/Email Alert** setting to **On**.

- ▶ **To turn on or off the text/E-mail notice**  
P. 378

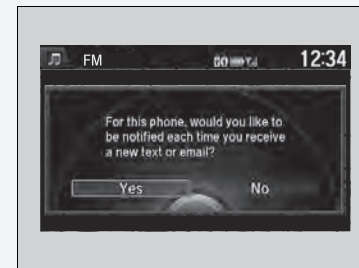

Continued

## ■ Selecting a Mail Account

If a paired phone has text message or mail accounts, you can select one of them to be active and receive notifications.



1. Press the **SETTINGS** button.
2. Rotate to select **Phone Settings**, then press .
- ▶ Repeat the procedure to select **Select Account**.
3. Rotate to select **Text message** or an E-mail account you want, then press .

## ▶▶ Selecting a Mail Account

You can also select a mail account from the folder list screen or the message list screen.

Move to select **Select Account**, then press .

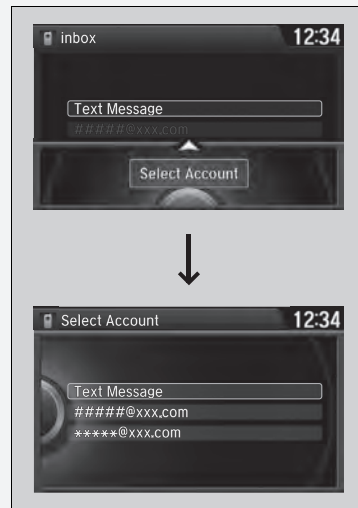





You can only receive notifications from one text message or mail account at a time.

## Displaying Messages





### ■ Displaying text messages

1. Press the **PHONE** button.
2. Press the **MENU** button.
3. Rotate  to select **Text/Email**, then press .
  - ▶ Select account if necessary.
4. Rotate  to select a message, then press .
  - ▶ The text message is displayed. The system automatically starts reading the message aloud.

### ⌘ Displaying Messages

The  icon appears next to an unread message.

If you delete a message on the phone, the message is also deleted in the system. If you send a message from the system, the message goes to your phone's mailbox.

To see the previous or next message, move  or  on the text message screen.

Continued

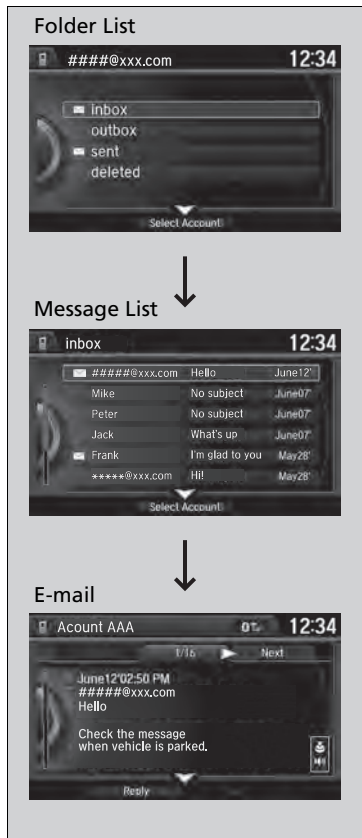

### ■ Displaying E-mails

1. Press the **PHONE** button.
2. Press the **MENU** button.
3. Rotate to select **Text/Email**, then press .
4. Rotate to select a folder, then press .
5. Rotate to select a message, then press .
  - ▶ The E-mail is displayed. The system automatically starts reading the message aloud.

### » Displaying E-mails

Received text messages and E-mails may appear in the message list screen at the same time. In this case, text messages are titled **No subject**.

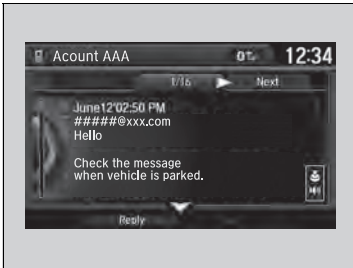

### ■ Read or stop reading a message

1. Go to the text message or E-mail screen.
  - ▶ The system automatically starts reading the message aloud.
  - ▣ **Displaying Messages** P. 401
2. Press to stop reading. Press again to start reading the message from the beginning.



### ■ Reply to a message

1. Go to the text message or E-mail screen.
  - ▶ The system automatically starts reading the message aloud.
  - ▣ **Displaying Messages** P. 401
2. Move and rotate to select **Reply**, then press .
3. Rotate to select the reply message, then press .
  - ▶ The pop-up menu appears on the screen.
4. Select **Send** to send the message.
  - ▶ **Complete** appears on the screen when the reply message was successfully sent.

### ▣ Reply to a message



The available fixed reply messages are as follows:

- **Talk to you later, I'm driving.**
- **I'm on my way.**
- **I'm running late.**
- **OK**
- **Yes**
- **No**

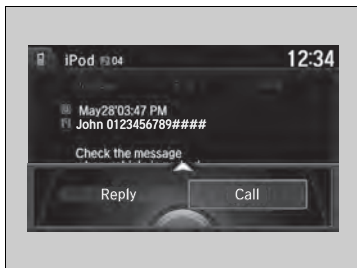
You cannot add, edit, or delete reply messages.



### ■ Making a call to a sender

1. Go to the text message screen.
  - ▶ The system automatically starts reading the message aloud.
  - ▶ **Displaying text messages** P. 401
2. Move  and rotate  to select **Call**, then press .

## Canadian models



## Models without audio touch screen

When you turn the ignition switch to ON , the compass self-calibrates, and the compass display appears.

## Compass Calibration

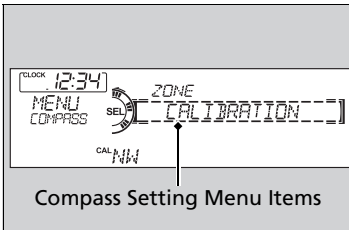
If the compass indicates the wrong direction, or the **CAL** indicator blinks, you need to manually calibrate the system.



1. Turn the ignition switch to ON .
2. Press and hold the **MENU** button until the display shows the compass setting menu list.
3. Rotate  to select **CALIBRATION**, then press .

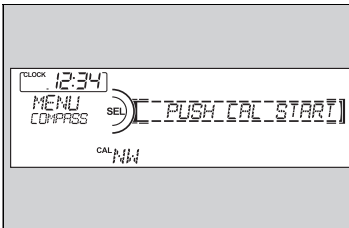

4. When the display changes to **PUSH CAL START**, press .
5. Drive the vehicle slowly in two circles.
  - ▶ The compass starts to show a direction after the calibration. The **CAL** indicator goes off.

### Compass\*

Compass operation can be affected under the following conditions:

- Driving near power lines or stations
- Crossing a bridge
- Passing a large vehicle, or driving near a large object that can cause a magnetic disturbance
- When accessories such as antennas and roof racks are mounted by magnets

### Compass Calibration

Calibrate the compass in an open area.

While setting the compass:

- The **RETURN** button returns to the previous screen.
- The **MENU** button cancels the setting mode.

These indications are used to show how to operate the selector knob.





Rotate  to select.

Press  to enter.

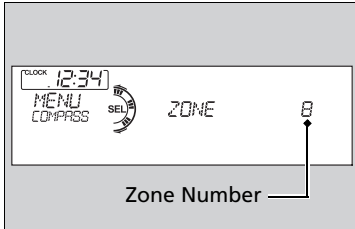
\* Not available on all models

## Compass Zone Selection



1. Turn the ignition switch to ON .
2. Press and hold the **MENU** button until the display shows the compass setting menu list.
3. Rotate  to select **ZONE**, then press . The display shows the current zone number.
4. Rotate  to select the zone number of your area (See Zone Map), then press .

### ▶▶ Compass Zone Selection

The zone selection is done to compensate the variation between magnetic north and true north.

If the calibration starts while the audio system is in use, the display returns to normal after the calibration is completed.

### Zone Map

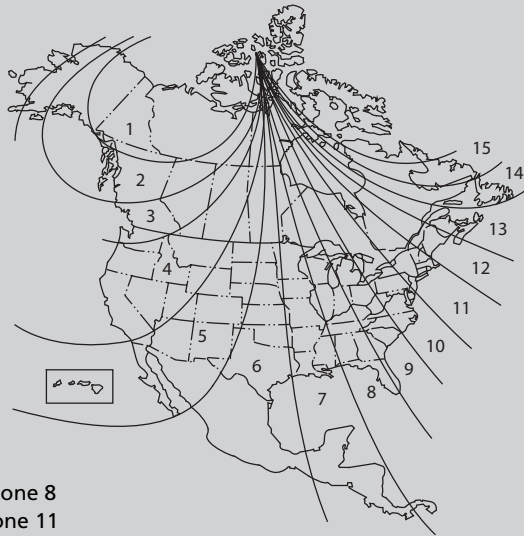

Guam Island: Zone 8  
Puerto Rico: Zone 11







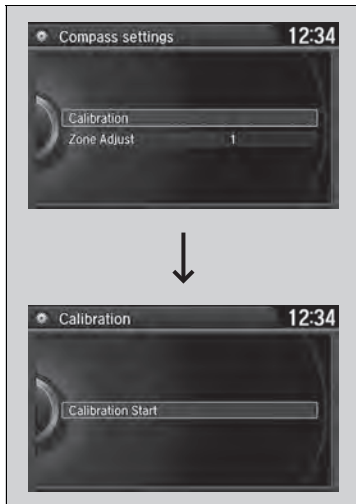

## Models with audio touch screen

When you turn the ignition switch to ON \*, the compass self-calibrates, and the compass display appears.

## Compass Calibration

If the compass indicates the wrong direction, or the **CAL** indicator blinks, you need to manually calibrate the system.



1. Turn the ignition switch to ON \*.
2. On the top screen of any audio source, press and hold  for 5 seconds.
  - ▶ The display switches to the **Compass Settings** screen.
3. Rotate  to select **Calibration**, then press .
4. When the display changes to **Calibration Start**, press .
5. Drive the vehicle slowly in two circles.
  - ▶ The compass starts to show a direction after the calibration. The **CAL** indicator goes off.

\*1: Models with the smart entry system have an **ENGINE START/STOP** button instead of an ignition switch.

\* Not available on all models

### Compass\*

Compass operation can be affected under the following conditions:

- Driving near power lines or stations
- Crossing a bridge
- Passing a large vehicle, or driving near a large object that can cause a magnetic disturbance
- When accessories such as antennas and roof racks are mounted by magnets





### Compass Calibration

Calibrate the compass in an open area.

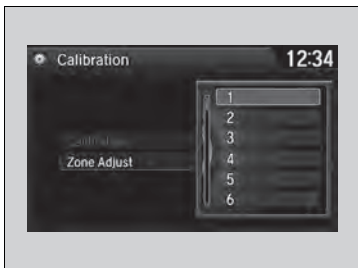
While setting the compass, press the **BACK** button to cancel the setting mode and return to the previous screen.

## Compass Zone Selection



1. Turn the ignition switch to ON **II**\*1.
2. On the top screen of any audio source, press and hold  for 5 seconds.
  - ▶ The display switches to the **Compass Settings** screen.
3. Rotate  to select **Zone Adjust**, then press .
- ▶ The display shows the current zone number.
4. Rotate  to select the zone number of your area (See Zone Map), then press .

### Compass Zone Selection

The zone selection is done to compensate the variation between magnetic north and true north.

If the calibration starts while the audio system is in use, the display returns to normal after the calibration is completed.

### Zone Map

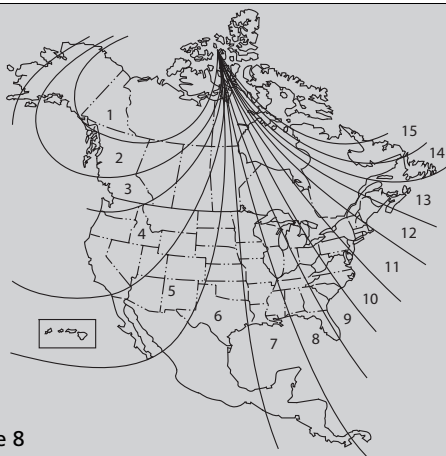

Guam Island: Zone 8

Puerto Rico: Zone 11

\*1: Models with the smart entry system have an **ENGINE START/STOP** button instead of an ignition switch.



# Driving

This chapter discusses driving, refueling, and information on items such as accessories.

## Before Driving

Driving Preparation .....	410
Maximum Load Limit.....	413

## Towing a Trailer

Towing Preparation.....	415
Driving Safely with a Trailer.....	418
Towing Your Vehicle.....	419

## When Driving

Starting the Engine .....	420
Precautions While Driving.....	424
Automatic Transmission .....	425
Shifting.....	426

Cruise Control .....	432
Forward Collision Warning (FCW)* ..	435
Lane Departure Warning (LDW)* .....	439
VSA® (Vehicle Stability Assist), aka ESC (Electronic Stability Control), System ..	442
LaneWatch™* .....	444
TPMS (Tire Pressure Monitoring System)..	446
Tire Pressure Monitoring System (TPMS) - Required Federal Explanation .....	447

## Braking

Brake System .....	449
ABS (Anti-lock Brake System) .....	451

Brake Assist System .....	452
---------------------------	-----

## Parking Your Vehicle

When Stopped .....	453
--------------------	-----

## Rearview Camera

.....	454
-------	-----

## Multi-View Rear Camera

.....	455
-------	-----

## Refueling

Fuel Information .....	456
How to Refuel .....	457

## Fuel Economy

Improving Fuel Economy.....	459
-----------------------------	-----

## Accessories and Modifications

.....	460
-------	-----

\* Not available on all models

## Driving Preparation

Check the following items before you start driving.

### Exterior Checks

- Make sure there are no obstructions on the windows, door mirrors, exterior lights, or other parts of the vehicle.
  - ▶ Remove any frost, snow, or ice.
  - ▶ Remove any snow on the roof, as this can slip down and obstruct your field of vision while driving. If frozen solid, remove ice once it has softened.
  - ▶ When removing ice from around the wheels, be sure not to damage the wheel or wheel components.
- Make sure the hood is securely closed.
  - ▶ If the hood opens while driving, your front view will be blocked.
- Make sure the tires are in good condition.
  - ▶ Check air pressure, and check for damage and excessive wear.
    - ✎ **Checking and Maintaining Tires** P. 497
- Make sure there are no people or objects behind or around the vehicle.
  - ▶ There are blind spots from the inside.

### Exterior Checks

#### NOTICE

When doors are frozen shut, use warm water around the door edges to melt any ice. Do not try to force them open, as this can damage the rubber trim around the doors. When done, wipe dry to avoid further freezing.

Do not pour warm water into the key cylinder. You will be unable to insert key if the water freezes in the hole.

Heat from the engine and exhaust can ignite flammable materials left under the hood, causing a fire. If you've parked your vehicle for an extended period, inspect and remove any debris that may have collected, such as dried grass and leaves that have fallen or have been carried in for use as a nest by a small animal. Also check under the hood for leftover flammable materials after you or someone else has performed maintenance on your vehicle.

## Interior Checks

- Store or secure all items on board properly.
  - ▶ Carrying too much cargo, or improperly storing it, can affect your vehicle's handling, stability, stopping distance, and tires, and make it unsafe.
    - ✦ **Maximum Load Limit** P. 413
- Do not pile items higher than the seat height.
  - ▶ They can block your view and may be thrown forward in the event of sudden braking.
- Do not place anything in the front seat footwells. Make sure to secure the floor mat.
  - ▶ An object or unsecured floor mat can interfere with your brake and accelerator pedal operation while driving.
- If you have any animals on board, do not let them move around in the vehicle.
  - ▶ They may interfere with driving and a crash could occur.
- Securely close and lock all doors and the tailgate.
  - ✦ **Locking/Unlocking the Doors from the Inside** P. 99
- Adjust your seating position properly.
  - ▶ Adjust the head restraint, too.
    - ✦ **Adjusting the Seats** P. 133
    - ✦ **Adjusting the Head Restraints** P. 136
- Adjust the mirrors and steering wheel properly for your driving.
  - ▶ Adjust them while sitting in the proper driving position.
    - ✦ **Adjusting the Steering Wheel** P. 129
    - ✦ **Adjusting the Mirrors** P. 130

## Interior Checks

The headlight aim is set by the factory, and does not need to be adjusted. However, if you regularly carry heavy items in the cargo area or tow a trailer, have the aiming readjusted at a dealer or by a qualified technician.

- Be sure items placed on the floor behind the front seats cannot roll under the seats.
  - ▶ They can interfere with the driver's ability to operate the pedals, the operation of the seats, or the operation of the sensors under the seats.
- Everyone in the vehicle must fasten their seat belt.
  - 📄 **Fastening a Seat Belt** P. 35
- Make sure that the indicators in the instrument panel come on when you start the vehicle, and go off soon after.
  - ▶ Always have a dealer check the vehicle if a problem is indicated.
    - 📄 **Indicators** P. 70

## Maximum Load Limit

The maximum load for your vehicle is 850 lbs (385 kg). See Tire and Loading Information label attached to the driver's doorjamb.

Label Example

TIRE	SIZE	COLD TIRE PRESSURE	SEE OWNER'S MANUAL FOR ADDITIONAL INFORMATION
FRONT	XXXX/XXXX XXX	XXXKPA, XXPSI	
REAR	XXXX/XXXX XXX	XXXKPA, XXPSI	
SPARE	XXXX/XXXX XXX	XXXKPA, XXPSI	

This figure includes the total weight of all occupants, cargo, and accessories, and the tongue load if you are towing a trailer. Steps for Determining Correct Load Limit -

- (1)** Locate the statement "The combined weight of occupants and cargo should never exceed XXX kg or XXX lbs." on your vehicle's placard.
- (2)** Determine the combined weight of the driver and passengers that will be riding in your vehicle.
- (3)** Subtract the combined weight of the driver and passengers from XXX kg or XXX lbs.
- (4)** The resulting figure equals the available amount of cargo and luggage load capacity. For example, if the "XXX" amount equals 1,400 lbs. and there will be five 150 lb. passengers in your vehicle, the amount of available cargo and luggage load capacity is 650 lbs.  
(1,400 - 750 (5 x 150) = 650 lbs.)

Continued

### Maximum Load Limit

## ⚠ WARNING

Overloading or improper loading can affect handling and stability and cause a crash in which you can be hurt or killed.

Follow all load limits and other loading guidelines in this manual.

Gross Vehicle Weight Rating (GVWR):

The maximum allowable weight of the vehicle, all occupants, all accessories, all cargo, and the tongue load.

📖 **Specifications** P. 546, 548

Gross Axle Weight Rating (GAWR):





The maximum allowable weight of the vehicle axle.

📖 **Specifications** P. 546, 548

- (5) Determine the combined weight of luggage and cargo being loaded on the vehicle. That weight may not safely exceed the available cargo and luggage load capacity calculated in step 4.
- (6) If your vehicle will be towing a trailer, load from your trailer will be transferred to your vehicle. Consult this manual to determine how this reduces the available cargo and luggage load capacity of your vehicle.

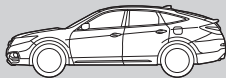
In addition, the total weight of the vehicle, all occupants, accessories, cargo, and trailer tongue load must not exceed the Gross Vehicle Weight Rating (GVWR) or the Gross Axle Weight Rating (GAWR). Both are on a label on the driver's doorjamb.

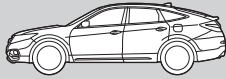
**Load Limits Example**

Example1		$\geq$		+	
	<p>Max Load 850 lbs (385 kg)</p>		<p>Passenger Weight 150 lbs x 2 = 300 lbs (68 kg x 2 = 136 kg)</p>		<p>Cargo Weight 550 lbs (249 kg)</p>
Example2		$\geq$		+	
	<p>Max Load 850 lbs (385 kg)</p>		<p>Passenger Weight 150 lbs x 5 = 750 lbs (68 kg x 5 = 340 kg)</p>		<p>Cargo Weight 100 lbs (45 kg)</p>



## Towing Preparation

### Towing Load Limits

Your vehicle can tow a trailer if you carefully observe the load limits, use the proper equipment, and follow the towing guidelines. Check the load limits before driving.

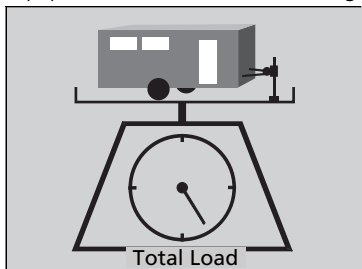

#### ■ Total trailer weight

Maximum allowable weight of the trailer, cargo, and everything in or on it must not exceed 1,500 lbs (680 kg) for 6-cylinder models and 1,000 lbs (453 kg) for 4-cylinder models. Towing loads in excess of this can seriously affect vehicle handling and performance and can damage the engine and drivetrain.

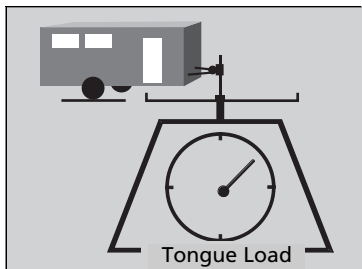

#### ■ Tongue load

The weight of the tongue with a fully loaded trailer on the hitch should be approximately 10% of the total trailer weight.

- Excessive tongue load reduces front tire traction and steering control. Too little tongue load can make the trailer unstable and cause it to sway.
- To achieve a proper tongue load, start by loading 60% of the load toward the front of the trailer and 40% toward the rear. Readjust the load as needed.

### ⊠ Towing Load Limits

## ⚠ WARNING

Exceeding any load limit or improperly loading your vehicle and trailer can cause a crash in which you can be seriously hurt or killed.

Check the loading of your vehicle and trailer carefully before starting to drive.

Check if all loads are within limits at a public scale. If a public scale is not available, add the estimated weight of your cargo load to the weight of your trailer (as quoted by the manufacturer), and the tongue load.

#### Break-in Period

Avoid towing a trailer during your vehicle's first 600 miles (1,000 km).

Never exceed the gross weight ratings.

Gross weight information

⊠ **Vehicle Specifications** P. 546, 548

## ■ Towing Equipment and Accessories

Towing equipment varies by the size of your trailer, how much load you are towing, and where you are towing.

### ■ Hitches

The hitch must be of an approved type and properly bolted to the underbody.

### ■ Safety chains

Always use safety chains when you tow a trailer. Leave enough slack to allow the trailer to turn corners easily, but do not allow the chains to drag on the ground.

### ■ Trailer brakes

There are two common types of trailer brakes: surge and electric. Surge brakes are common for boat trailers, since the brakes will get wet. If you choose electric brakes, be sure they are electronically actuated. Do not attempt to attach trailer brakes to your vehicle's hydraulic system, as it will lower braking effectiveness and create a potential hazard.

### ■ Additional towing equipment

Many states and provinces/territories require special outside mirrors when towing a trailer. Even if mirrors are not required in your locale, you should install special mirrors if visibility is restricted in any way.

## ► Towing Equipment and Accessories

Make sure that all equipment is properly installed and maintained, and that it meets federal, state, province/territory, and local regulations.

Consult your trailer sales or rental agency if any other items are recommended or required for your towing situation.

The lighting and wiring of trailers can vary by type and brand. If a connector is required, it should only be installed by a qualified technician.

## ■ Trailer light

Trailer lights and equipment must comply with federal, state, province/territory, and local regulations. Check with your local trailer sales or rental agency for the requirements in the area where you plan to tow.

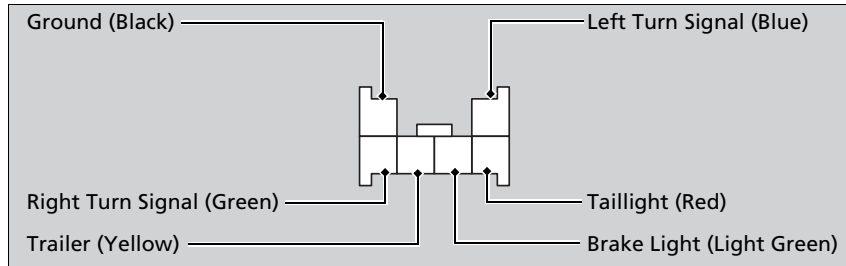

Your trailer lighting connector is located behind the left side panel in the cargo area. Each pin's purpose and wiring color code are shown in the image.

When using a non-Honda trailer lighting harness and converter, get the connector and pins for your vehicle from a dealer.

## Driving Safely with a Trailer

### ■ Things You Need To Know Before Towing a Trailer

- Have the trailer properly serviced and keep it in good condition.
- Make sure that all the weights and load in the vehicle and trailer are within limits.
  - ✦ **Towing Load Limits** P. 415
- Securely attach the hitch, safety chains, and other necessary parts to the trailer.
- Securely store all the items in and on the trailer so that they do not shift while driving.
- Check if the lights and brakes on the trailer are working properly.
- Check the pressures of the trailer tires, including the spare.

### ■ Towing Speeds and Gears

- Drive slower than normal.
- Obey posted speed limits for vehicles with trailers.
- Use the **[D]** position when towing a trailer on level roads.

### ■ Turning and Braking

- Turn more slowly and with a wider turning arc than normal.
- Allow more time and distance for braking.
- Do not brake or turn suddenly.

### ►► Driving Safely with a Trailer

#### Parking

In addition to the normal precautions, place wheel chocks at each of the trailer's tires.

## Driving in Hilly Terrain

- Monitor your temperature gauge. If it nears the red (Hot) mark, turn off the heating and cooling system\*/climate control system\* and reduce speed. Pull to the side of the road safely to cool down the engine if necessary.
- Shift to the **[S]** or **[D3]** position if the transmission shifts frequently.

## Towing Your Vehicle

Your vehicle is not designed to be towed behind a motor home. If your vehicle needs to be towed in an emergency, refer to the emergency towing information.

📖 **Emergency Towing** P. 542

Models without smart entry system

## Starting the Engine

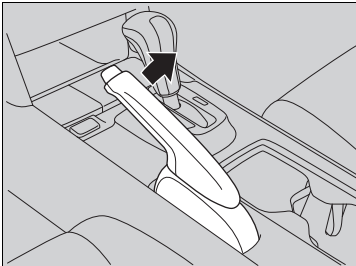

1. Make sure the parking brake is applied.

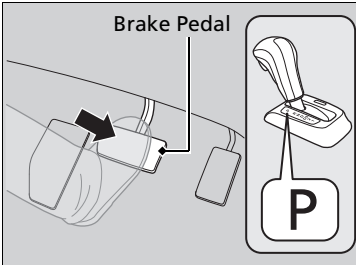

2. Check that the shift lever is in **P**, then depress the brake pedal.

▶ Although it is possible to start the vehicle in **N**, it is safer to start it in **P**.

### Starting the Engine

Keep your foot firmly on the brake pedal when starting the engine.

The engine is harder to start in cold weather and in thinner air found at altitudes above 8,000 feet (2,400 meters).

When starting the engine in cold weather, turn off all electrical accessories such as the lights, heating and cooling system\*/climate control system\*, and rear defogger in order to reduce battery drain.

If you live in a region where winter is extremely cold, an engine block heater will improve starting and warming of the engine. If temperatures consistently below -22°F (-30°C) are expected, the coolant mixture should be charged to a higher concentration to prevent freezing. Consult a dealer for details.

If the exhaust system sounds abnormal or you can smell exhaust gas inside the vehicle, have your vehicle checked by a dealer. There may be a problem with the engine or exhaust system.

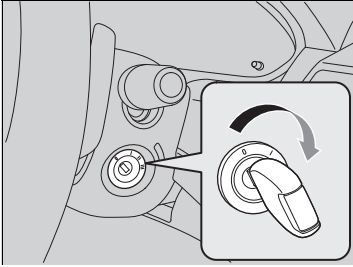

3. Turn the ignition switch to START  without depressing the accelerator pedal.

## Starting to Drive

1. Keeping your right foot on the brake pedal, release the parking brake. Check that the parking brake indicator has gone off.  
 **Parking Brake** P. 449
2. Put the shift lever in **D**. Select **R** when reversing.
3. Gradually release the brake pedal and gently depress the accelerator pedal to pull away.

### Starting the Engine

Do not hold the key in START  for more than 15 seconds.

- If the engine does not start right away, wait for at least 10 seconds before trying again.
- If the engine starts, but then immediately stops, wait at least 10 seconds before repeating step 3 while gently depressing the accelerator pedal. Release the accelerator pedal once the engine starts.

The immobilizer system protects your vehicle from theft. If an improperly coded key (or other device) is used, the engine's fuel system is disabled.

 **Immobilizer System** P. 107

Models with smart entry system

## Starting the Engine

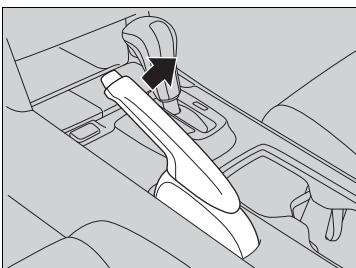

1. Make sure the parking brake is applied.

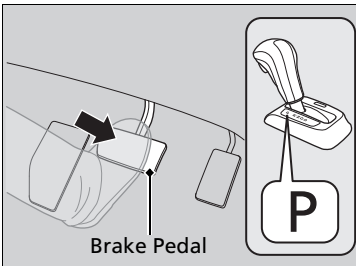

2. Check that the shift lever is in **P**, then depress the brake pedal.

▶ Although it is possible to start the vehicle in **N**, it is safer to start it in **P**.

### Starting the Engine

Keep your foot firmly on the brake pedal when starting the engine.

The engine is harder to start in cold weather and in thinner air found at altitudes above 8,000 feet (2,400 meters).

When starting the engine in cold weather, turn off all electrical accessories such as the lights, climate control system, and rear defogger in order to reduce battery drain.

If you live in a region where winter is extremely cold, an engine block heater will improve starting and warming of the engine. If temperatures consistently below -22°F (-30°C) are expected, the coolant mixture should be changed to a higher concentration to prevent freezing. Consult a dealer for details.

If the exhaust system sounds abnormal or you can smell exhaust gas inside the vehicle, have your vehicle checked by a dealer. There may be a problem with the engine or exhaust system.

The immobilizer system protects your vehicle from theft.

If an improperly coded device is used, the engine's fuel system is disabled.

▶ **Immobilizer System** P. 107



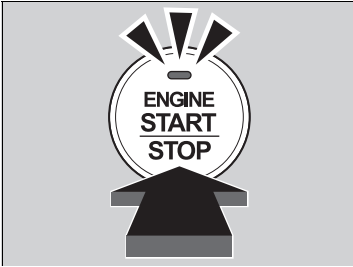

3. Press the **ENGINE START/STOP** button without depressing the accelerator pedal.

## Stopping the Engine

You can turn the engine off when the vehicle is completely stopped.

1. Shift to **P**.
2. Press the **ENGINE START/STOP** button.

## Starting to Drive

1. Keeping your right foot on the brake pedal, release the parking brake. Check that the parking brake indicator has gone off.
  - ▶ **Parking Brake** P. 449
2. Put the shift lever in **D**. Select **R** when reversing.
3. Gradually release the brake pedal and gently depress the accelerator pedal to pull away.

### Starting the Engine

Bring the smart entry remote close to the **ENGINE START/STOP** button if the battery in the smart entry remote is weak.

- ▶ **If the Smart Entry Remote Battery is Weak**  
P. 526

The engine may not start if the smart entry remote is subjected to strong radio waves.

Do not hold the **ENGINE START/STOP** button to start the engine.  
If the engine does not start, wait at least 10 seconds before trying again.

## Precautions While Driving

### In Rain

Avoid driving in deep water and on flooded roads. This can damage the engine or driveline, or cause electrical component failure.

### Other Precautions

If there is a strong impact with something under the vehicle, stop in a safe location. Check the underside of the vehicle for damage or any fluid leaks.

### Precautions While Driving

#### NOTICE

Do not operate the shift lever while pressing the accelerator pedal. You could damage the transmission.

If the ignition switch is turned to ACCESSORY [I] or LOCK [0]\*1 while driving, the engine will shut down and all steering and brake power assist functions will stop, making it difficult to control the vehicle.

Do not put the shift lever in [N], as you will lose engine braking (and acceleration) performance.

During the first 600 miles (1,000 km) of operation, avoid sudden acceleration or full throttle operation so as to not damage the engine or powertrain.

Avoid hard braking for the first 200 miles (300 km). You should also follow this when the brake pads are replaced.

\*1: Models with the smart entry system have an **ENGINE START/STOP** button instead of an ignition switch.

## Automatic Transmission

---

### ■ Creeping

The engine runs at a higher idle speed and creeping increases. Keep the brake pedal firmly depressed when stopped.

### ■ Kickdown

Quickly depressing the accelerator pedal while driving uphill may cause the transmission to drop to a lower gear, unexpectedly increasing vehicle speed. Depress the accelerator pedal carefully, especially on slippery roads and curves.

Automatic transmission models without paddle shifters

## Shifting

Change the shift position in accordance with your driving needs.

### ■ Shift lever positions

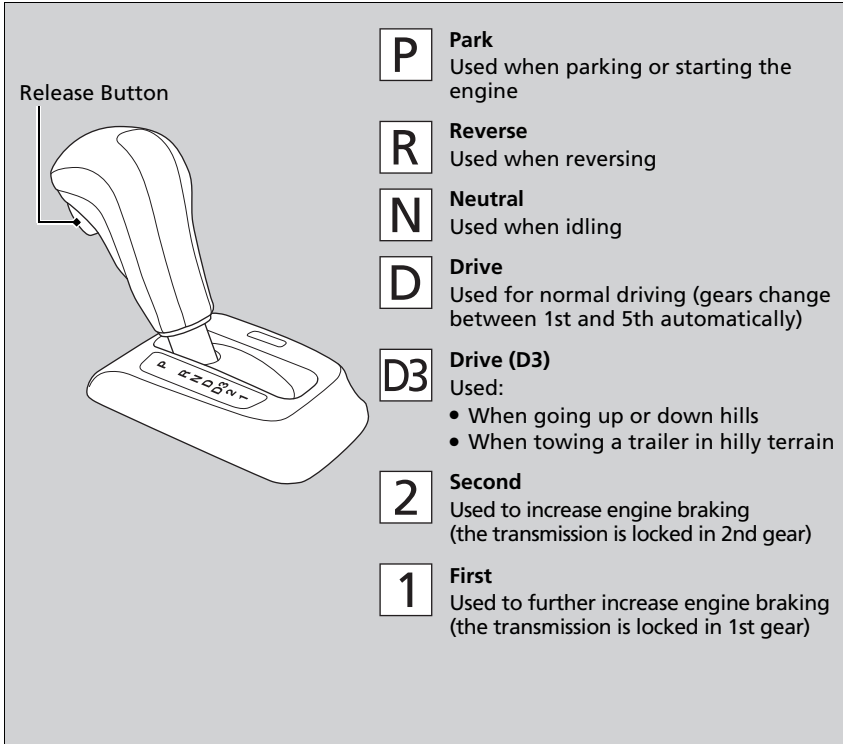

Release Button

**P** **Park**  
Used when parking or starting the engine

**R** **Reverse**  
Used when reversing

**N** **Neutral**  
Used when idling

**D** **Drive**  
Used for normal driving (gears change between 1st and 5th automatically)

**D3** **Drive (D3)**  
Used:  
• When going up or down hills  
• When towing a trailer in hilly terrain

**2** **Second**  
Used to increase engine braking (the transmission is locked in 2nd gear)

**1** **First**  
Used to further increase engine braking (the transmission is locked in 1st gear)

### ▶▶ Shifting

You cannot turn the ignition switch to LOCK **[O]** and remove the key unless the shift lever is in **[P]**.

The vehicle may move forward very slightly even in **[N]** while the engine is cold.

Depress the brake pedal firmly and, when necessary, apply the parking brake.

The engine may cut in and out in **[R]** or depending on the road condition, even when the engine speed is lower than the tachometer's red zone. This is the engine's computer working to protect the transmission.

## Shift Lever Operation

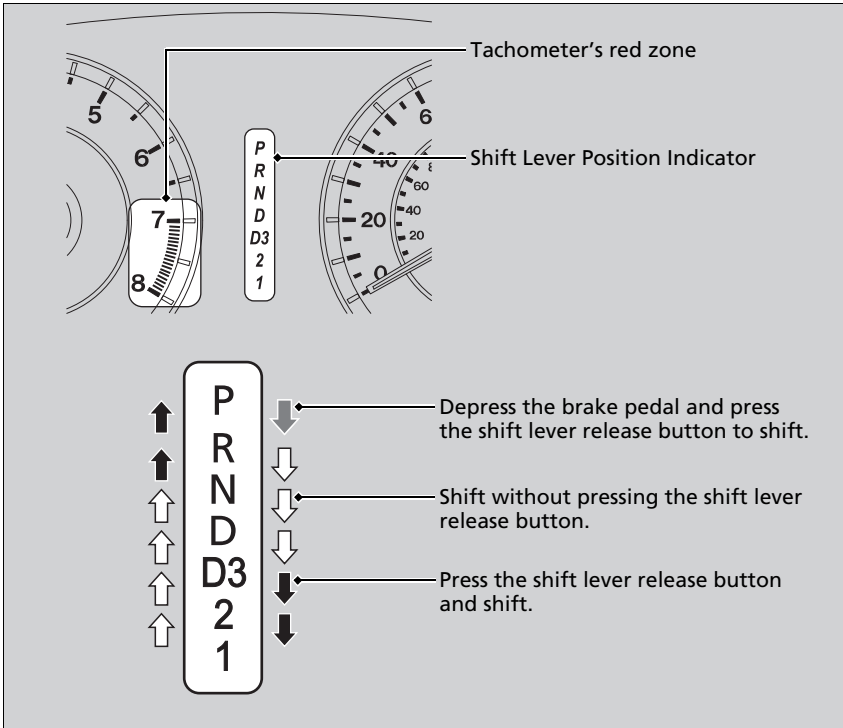

### Shift Lever Operation

#### NOTICE

When you change the shift lever from **[D]** to **[R]** and vice versa, come to a complete stop and keep the brake pedal depressed.

Operating the shift lever before the vehicle has come to a complete standstill can damage the transmission.

Use the shift lever position indicator to check the lever position before pulling away.

Whichever position the shift lever is in when driving, a blinking **[D]** indicator indicates a transmission problem.

Avoid sudden acceleration and have the transmission checked by a dealer as soon as possible.

The fuel supply may be cut off if you drive at engine speeds in or over the tachometer's red zone (engine speed limit). If this happens, you may experience a slight jolt.

It may not be possible to operate the shift lever if the brake pedal is applied while the shift lever release button is held down.

Depress the brake pedal first.

Automatic transmission models with paddle shifters

## Shifting

Change the shift position in accordance with your driving needs.

### ■ Shift lever positions

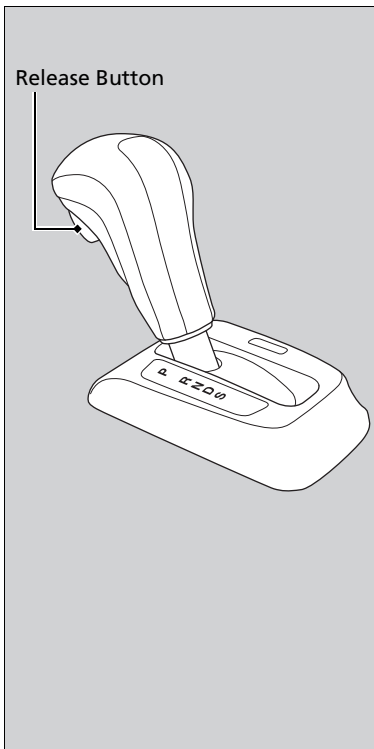

**P** **Park**  
Used when parking or starting the engine

**R** **Reverse**  
Used when reversing

**N** **Neutral**  
Used when idling

**D** **Drive**  
Used:  
• For normal driving (gears change between 1st and 6th automatically)  
• When temporarily driving in the sequential mode

**S** **Drive (S)**  
Used:  
• When automatically changing gears between 1st and 5th (5th gear is used only at high speed)  
• When driving in the sequential mode  
• When towing a trailer in hilly terrain  
• To increase engine braking

### ▶▶ Shifting

You cannot change the power mode from ON to VEHICLE OFF (LOCK) unless the shift lever is in **P**.

The vehicle may move forward very slightly even in **N** while the engine is cold.

Depress the brake pedal firmly and, when necessary, apply the parking brake.

The engine may cut in and out in **R** or depending on the road condition, even when the engine speed is lower than the tachometer's red zone. This is the engine's computer working to protect the transmission.

## Shift Lever Operation

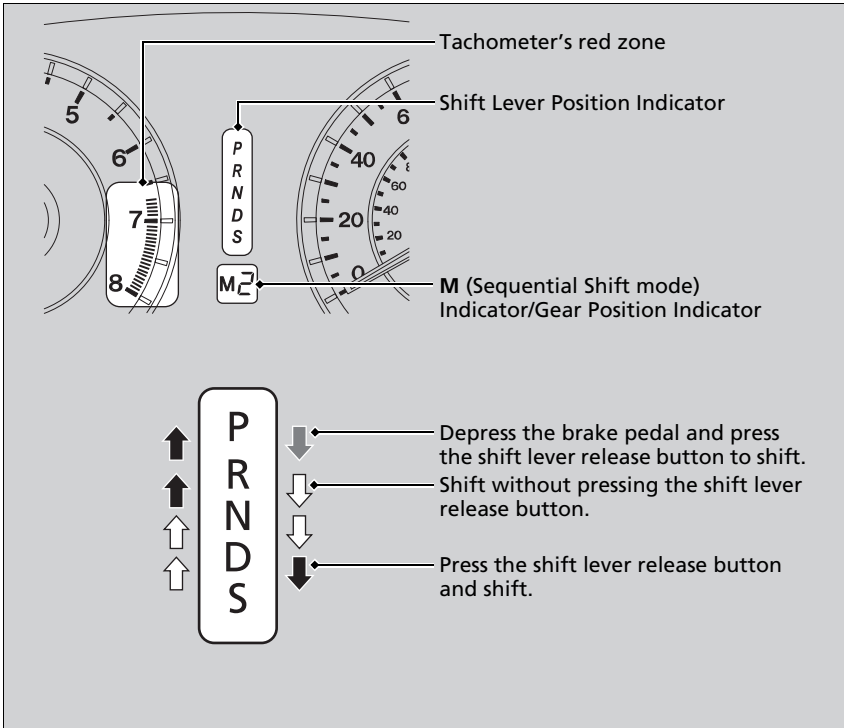

### Shift Lever Operation

#### NOTICE

When you change the shift lever from **[D]** to **[R]** and vice versa, come to a complete stop and keep the brake pedal depressed. Operating the shift lever before the vehicle has come to a complete standstill can damage the transmission.

Use the shift lever position indicator to check the lever position before pulling away.

Whichever position the shift lever is in when driving, a blinking **[D]** indicator indicates a transmission problem.

Avoid sudden acceleration and have the transmission checked by a dealer as soon as possible.

The fuel supply may be cut off if you drive at engine speeds in or over the tachometer's red zone (engine speed limit). If this happens, you may experience a slight jolt.

It may not be possible to operate the shift lever if the brake pedal is applied while the shift lever release button is held down.

Depress the brake pedal first.

## ■ Sequential Shift Mode

Use the paddle shifters to change between 1st and 6th gears without removing your hands from the steering wheel. The transmission will switch to the sequential shift mode.

### ■ When the shift lever is in **D**:

The vehicle will go into the sequential shift mode momentarily, and the gear position indicator will come on.

Once you start traveling at a constant speed, the sequential shift mode will automatically switch off, and the gear position indicator will go off.

Hold the **[+]** paddle shifter for two seconds to return to normal drive.

### ■ When the shift lever is **S**:

The vehicle will go into the sequential shift mode, and the **M** (sequential shift mode) indicator and gear position indicator will come on. At speeds of 6 mph (10 km/h) or less, the vehicle automatically shifts down into 1st gear. If you do not operate the paddle shifters while in 1st gear, the transmission automatically shifts up to 2nd gear. Once in 2nd gear, the transmission must be manually upshifted to the remaining gears using the **[+]** paddle shifter.

You can only pull away in 1st or 2nd gear.

When switching out of the sequential shift mode, move the shift lever from **S** to **D**. When the sequential shift mode is canceled, the **M** indicator and gear position indicator go off.



### ■ Second gear lock mode

If you pull the **+** paddle shifter while stopped or driving at 6 mph (10 km/h) or less, the gear position will be locked in 2nd gear. This makes it easier to pull away on slippery surfaces such as snow covered roads.

To cancel the 2nd gear lock mode, pull the **-** paddle shifter, or move the shift lever from **S** to **D**.

### ■ Sequential Shift Mode Operation

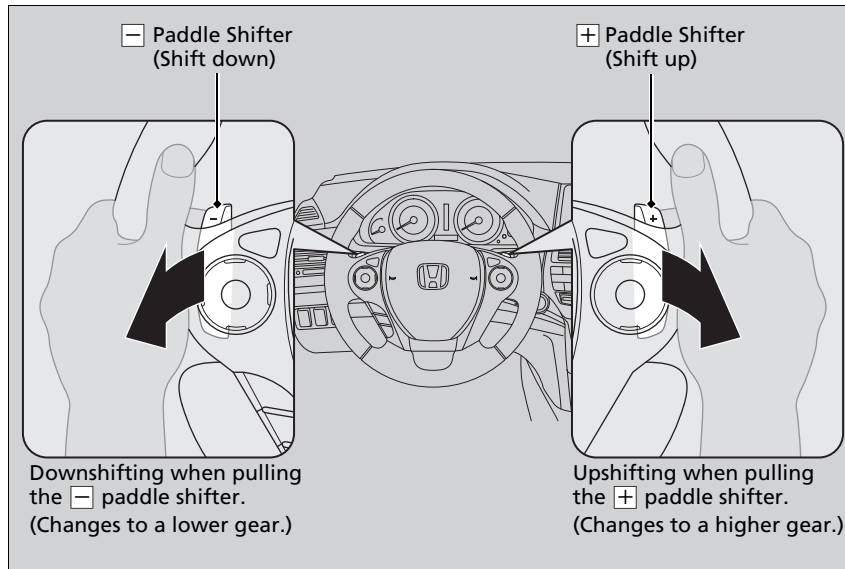

### ▣ Sequential Shift Mode Operation

Each paddle shift operation makes a single gear change. To change gears continuously, release the paddle shifter before pulling it again for the next gear.

#### Recommended Shift Points

Use this table as a guideline for efficient fuel economy and effective emission control.

Shift Up	Normal Acceleration
1st to 2nd	17.4 mph (28.0 km/h)
2nd to 3rd	27.1 mph (43.6 km/h)
3rd to 4th	35.7 mph (57.5 km/h)
4th to 5th	41.0 mph (66.0 km/h)
5th to 6th	44.2 mph (71.1 km/h)

The gear position indicator blinks when you cannot shift up or down. It indicates that your vehicle speed is not in its allowable gear shifting range. Slightly accelerate to shift up and decelerate to shift down while the indicator is blinking.

## Cruise Control

Maintains a constant vehicle speed without having to keep your foot on the accelerator. Use cruise control on freeways or open roads where you can travel at a constant speed with little acceleration or deceleration.

### ⌘ Cruise Control

## ⚠ WARNING

Improper use of the cruise control can lead to a crash.

Use the cruise control only when traveling on open highways in good weather.

It may not be possible to maintain a constant speed when driving uphill or downhill.

When not using cruise control:  
Turn off cruise control by pressing the **CRUISE** button.

### When to use

- Vehicle speed for cruise control:  
Desired speed in a range above roughly 25 mph (40 km/h) ~
- Shift positions for cruise control:

Models without paddle shifters

In **D** or **D3**

Models with paddle shifters

In **D** or **S**

Always keep sufficient distance between you and the vehicle in front of you.

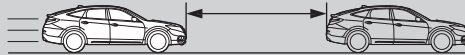

### How to use

- Press the **CRUISE** button on the steering wheel.

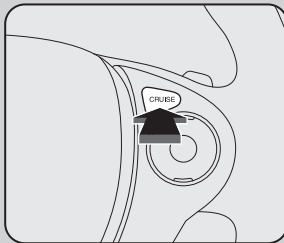

CRUISE  
MAIN

CRUISE MAIN is on in the instrument panel.  
Cruise control is ready to use.

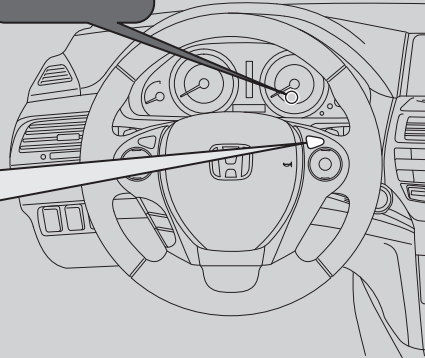

## ■ To Set the Vehicle Speed

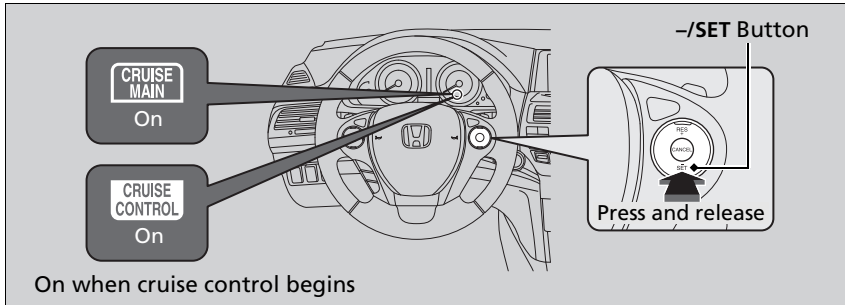

Take your foot off the pedal and press the **-/SET** button when you reach the desired speed.

The moment you release the **-/SET** button, the set speed is fixed, and cruise control begins. The **CRUISE CONTROL** indicator comes on.

## ■ To Adjust the Vehicle Speed

Increase or decrease the vehicle speed using the **RES/+** or **-/SET** buttons on the steering wheel.

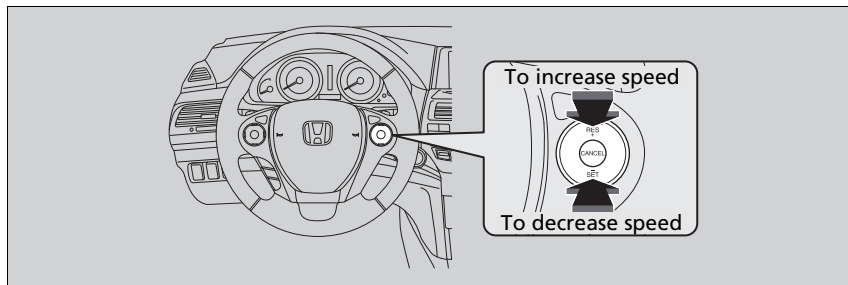

- Each time you press the button, the vehicle speed is increased or decreased by about 1 mph (1.6 km/h).
- If you keep the button pressed, the vehicle speed increases or decreases until you release it. This speed is then set.

## ■ To Cancel

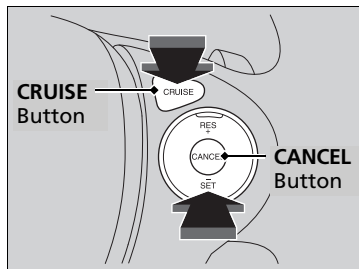

To cancel cruise control, do any of the following:

- Press the **CANCEL** button.
- Press the **CRUISE** button.
- Depress the brake pedal.

The **CRUISE CONTROL** indicator goes off.

## ▶▶ To Adjust the Vehicle Speed

You can set the vehicle speed using the **-/SET** button on the steering wheel when adjusting the speed with the accelerator and brake pedals.

## ▶▶ To Cancel

Resuming the prior set speed:  
After cruise control has been canceled, you can still resume the prior set speed by pressing the **RES/+** button while driving at a speed of at least 25 mph (40 km/h) or more.

You cannot set or resume in the following situations:

- When vehicle speed is less than 25 mph (40 km/h)
- When the **CRUISE** button is turned off

At vehicle speeds of 22 mph (35 km/h) or less, cruise control is canceled automatically.

## Forward Collision Warning (FCW)\*

Alerts you when it detects the possibility of your vehicle colliding with the vehicle in front of yours.

If the system determines a collision is possible, it gives both visual and audible alerts.

- ▶ Take appropriate action to prevent a collision (apply the brakes, change lanes, etc.).

### ■ How the system works

The system may give warnings of potential collisions when your vehicle speed is above 10 mph (15 km/h).

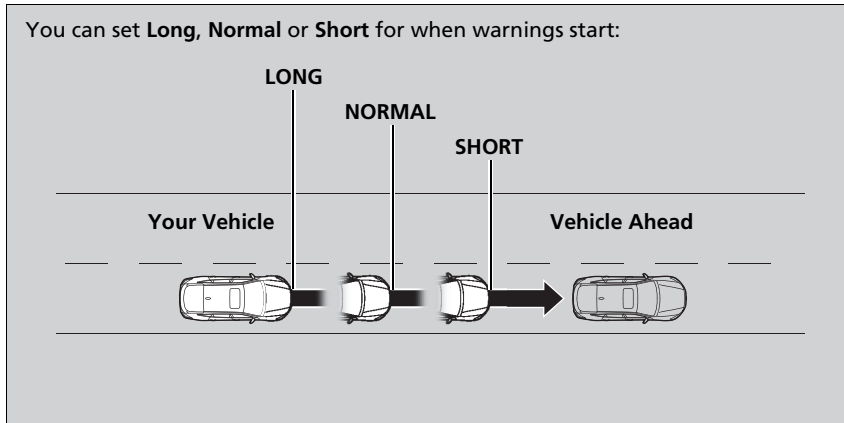

### ⊞ Forward Collision Warning (FCW)\*

#### Important Safety Reminder

FCW cannot detect all objects ahead and may not detect a given object; accuracy of the system will vary based on weather, speed and other factors. FCW does not include a braking function. It is always your responsibility to safely operate the vehicle and avoid collisions.

You can change the Forward Collision Warning Distance setting or turn the system on and off.

➤ **Customized Features\*** P. 281

For the FCW system to work properly:

The camera is shared with Lane Departure Warning (LDW).

➤ **LDW Camera** P. 440

\* Not available on all models

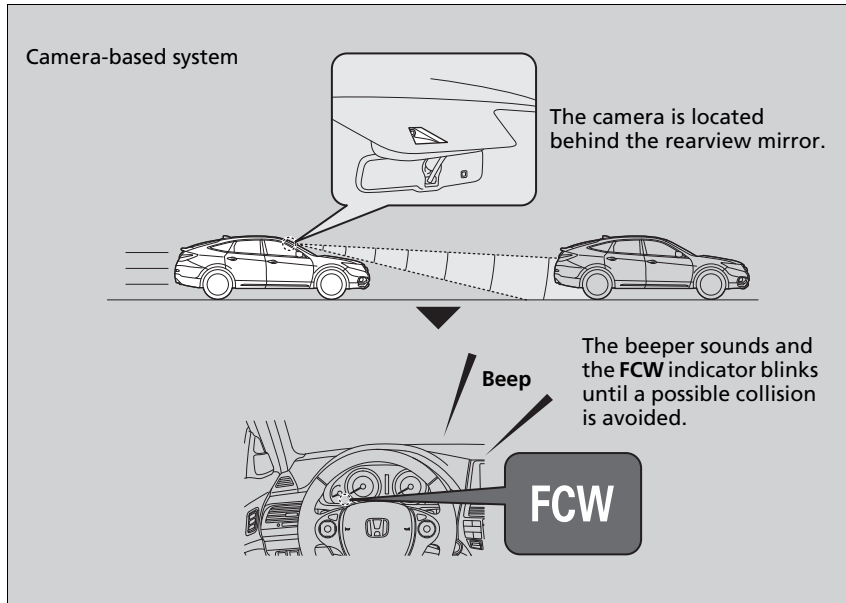

⚠ Forward Collision Warning (FCW)\*

Never apply a film or attach any objects to the windshield that could obstruct the FCW camera's field of vision. Scratches, nicks, and other damage to the windshield within the FCW camera's field of vision can cause the system to operate abnormally. If this occurs, we recommend that you replace the windshield with a genuine Honda replacement windshield. Making even minor repairs within the camera's field of vision or installing an aftermarket replacement windshield may also cause the system to operate abnormally. After replacing the windshield, have a dealer recalibrate the camera. Proper calibration of the FCW camera is necessary for the system to operate properly.

## ■ Automatic shutoff

FCW may automatically shut itself off and the **FCW** indicator comes and stays on when:

- The temperature inside the system is high.
- The windshield is blocked by dirt, mud, leaves, wet snow, etc.

Once the conditions that caused FCW to shut off improve or are addressed (e.g., cleaning), the system comes back on.

### ⓘ Automatic shutoff

To help reduce the likelihood that high interior temperatures will cause the camera system to shut off, when parking, find a shady area or face the front of the vehicle away from the sun. Also, do not use a reflective sunshade that can concentrate heat on the camera.

If the **CAMERA HOT** message appears:

- Use the climate control system to cool down the interior and, if necessary, the defroster mode when windows are fogged.
- Start driving the vehicle to lower the windshield temperature, which cools down the area around the FCW system.

## FCW Limitations

FCW may not activate or may not detect a vehicle in front of your vehicle, and may activate even when you are aware of a vehicle ahead of you, or when there is no vehicle ahead under the following conditions.

### Condition

- The distance between your vehicle and the vehicle ahead of you is too short.
- A vehicle cuts in front of you at a slow speed, and it brakes suddenly.
- A vehicle suddenly crosses in front of you.
- When either your vehicle or the vehicle ahead of you accelerates rapidly.
- The vehicle ahead of you is a motorcycle, a small vehicle, or a unique vehicle such as a tractor.
- When you drive off-road or on a mountain road, or curved and winding road for an extended period that makes it difficult for the camera to properly detect a vehicle in front of you.
- When there are pedestrians or animals in front of your vehicle.
- When you drive in bad weather (rain, fog, etc.).
- A heavy load in the rear or modifications to the suspension tilts your vehicle.
- An abnormal tire condition is detected (wrong tire size, flat tire, etc.).
- When the windshield is blocked by dirt, mud, leaves, wet snow, etc.
- When the temperature inside the system is high.
- A sudden change between light and dark such as an entrance or exit of a tunnel.
- You drive into the sunlight (e.g. at dawn or dusk).
- When the windshield is dirty or cloudy.
- When streetlights are perceived as the taillight of a vehicle in front of yours.
- When driving at night, the vehicle ahead of you is running with either taillight bulb burned out.
- When you drive in the shadows of trees, buildings, etc.
- When your vehicle is towing a trailer.



## Lane Departure Warning (LDW)\*

Alerts you when the system detects a possibility of your vehicle unintentionally crossing over left or right side lane markings.

### How the System Works

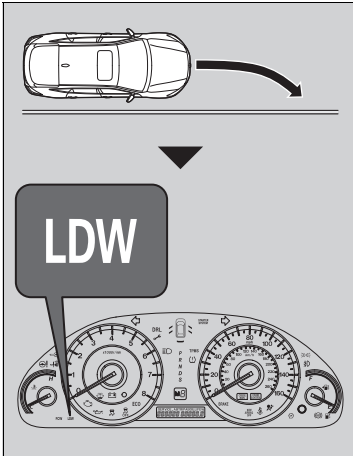

If your vehicle is getting too close to detected left or right side lane markings without a turn signal activated, LDW will give audible and visual alerts.

The beeper sounds and the **LDW** indicator blinks, letting you know that you need to take appropriate action.

### ☒ Lane Departure Warning (LDW)\*

#### Important Safety Reminder

Like all assistance systems, LDW has limitations. Over-reliance on LDW may result in a collision. It is always your responsibility to keep the vehicle within your driving lane.

LDW only alerts you when lane drift is detected without a turn signal in use. LDW may not detect all lane markings or lane departures; accuracy will vary based on weather, speed and lane marker condition. It is always your responsibility to safely operate the vehicle and avoid collisions.

\* Not available on all models

## ■ How the System Activates

The system begins to search for lane markings when all the following conditions are met:

- The vehicle is traveling between at 40-90 mph (64-145 km/h).
- The vehicle is on a straight or slightly curved road.
- The turn signals are off.
- The brake pedal is not pressed.

## ■ LDW Camera

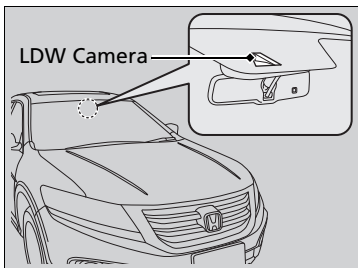

The camera is located behind the rearview mirror.

## ■ LDW On and Off

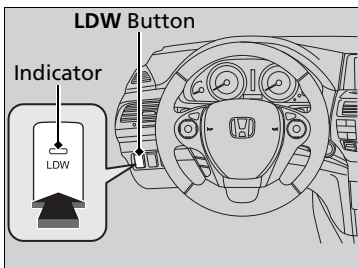

Press the **LDW** button to turn the system on and off.

- ▶ The indicator in the button comes on when the system is on.

## ▶▶ How the System Activates

LDW may automatically shut off and the **LDW** indicator comes and stays on.

- ▶ **Indicators** P. 77

## ▶▶ LDW Camera

Never apply a film or attach any objects to the windshield that could obstruct the LDW camera's field of vision.

Scratches, nicks, and other damage to the windshield within the LDW camera's field of vision can cause the system to operate abnormally. If this occurs, we recommend that you replace the windshield with a genuine Honda replacement windshield. Making even minor repairs within the camera's field of vision or installing an aftermarket replacement windshield may also cause the system to operate abnormally. After replacing the windshield, have a dealer recalibrate the camera. Proper calibration of the LDW camera is necessary for the system to operate properly.

To help reduce the likelihood that high interior temperatures will cause the camera system to shut off, when parking, find a shady area or face the front of the vehicle away from the sun. Also, do not use a reflective sunshade that can concentrate heat on the camera.

If the **CAMERA HOT** message appears:

- Use the climate control system to cool down the interior and, if necessary, the defroster mode when windows are fogged.
- Start driving the vehicle to lower the windshield temperature, which cools down the area around the LDW system.

## LDW Limitations

LDW may not activate or may not recognize lanes, and may activate even when keeping in the middle of a lane under the following conditions.

### Condition

- When you drive in bad weather (rain, fog, etc.).
- A heavy load in the rear or modifications to the suspension tilts your vehicle.
- An abnormal tire condition is detected (wrong tire size, flat tire, etc.).
- When the windshield is blocked by dirt, mud, leaves, wet snow, etc.
- When the temperature inside the system is high.
- A sudden change between light and dark such as an entrance or exit of a tunnel.
- You drive into the sunlight (e.g. at dawn or dusk).
- When the windshield is dirty or cloudy.
- When you drive in the shadows of trees, buildings, etc.
- When your vehicle is towing a trailer.
- When you drive on a wet road surface following another vehicle.
  - ▶ The camera may perceive the tire tracks in the water as lane lines.
- When there is snow or wheel tracks on the side of the road.
- When the road has many repaired area or an erased lane line.
- When the vehicle is running over painted signs or crosswalk markings.
- When you drive in a lane with specific lane markups (e.g., Botts' dots).

## VSA® (Vehicle Stability Assist), aka ESC (Electronic Stability Control), System

VSA® helps to stabilize the vehicle during cornering if the vehicle turns more or less than what was intended. It also assists in maintaining traction on slippery surfaces. It does so by regulating engine output and selectively applying the brakes.

### ■ VSA® Operation

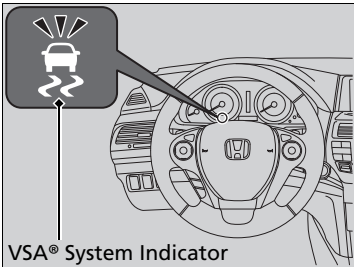

When VSA® activates, you may notice that the engine does not respond to the accelerator. You may also notice some noise from the hydraulic system. You will also see the indicator blink.

### ⚠ VSA® (Vehicle Stability Assist), aka ESC (Electronic Stability Control), System

The VSA® may not function properly if tire type and size are mixed. Make sure to use the same size and type of tire, and the air pressures as specified.

When the VSA® indicator comes on and stays on while driving, there may be a problem with the system. While this may not interfere with normal driving, have your vehicle checked by a dealer immediately.

VSA® cannot enhance stability in all driving situations and does not control the entire braking system. You still need to drive and corner at speeds appropriate for the conditions and always leave a sufficient margin of safety.

The main function of the VSA® system is generally known as Electronic Stability Control (ESC). The system also includes a traction control function.

## VSA® On and Off

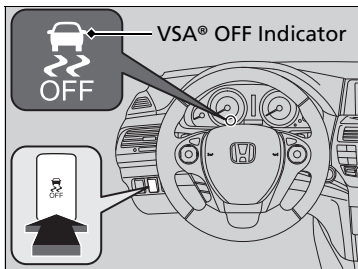

This button is on the driver side control panel. To turn the VSA® system on and off, press and hold it until you hear a beep.

VSA® will stop and the indicator will come on.

To turn it on again, press the  (VSA® OFF) button until you hear a beep.

VSA® is turned on every time you start the engine, even if you turned it off the last time you drove the vehicle.

## VSA® (Vehicle Stability Assist), aka ESC (Electronic Stability Control), System

Without VSA®, your vehicle will have normal braking and cornering ability, but it will not have VSA® traction and stability enhancement.

In certain unusual conditions when your vehicle gets stuck in shallow mud or fresh snow, it may be easier to free it with the VSA® temporarily switched off.

When the VSA® system is off, the traction control system is also off. You should only attempt to free your vehicle with the VSA® off if you are not able to free it when the VSA® is on.

Immediately after freeing your vehicle, be sure to switch VSA® on again. We do not recommend driving your vehicle with the VSA® and traction control systems switched off.

If the low tire pressure, or TPMS indicator comes on or blinks, the VSA® system comes on automatically. In this case, you cannot turn the system off by pressing the  button.

You may hear a motor sound coming from the engine compartment while system checks are being performed immediately after starting the engine or while driving. This is normal.

## LaneWatch™\*

Is an assistance system that allows you to check the passenger side rear areas displayed on the audio/information screen when the turn signal is activated to the passenger's side. A camera in the passenger side door mirror monitors these areas and allows you to check for vehicle, in addition to your visual check and use of the passenger door mirror. You can also keep the system on for your convenience while driving.

**1** The system activates when you:

Move the turn signal lever to the passenger side.      Press the LaneWatch button.



The system deactivates when you:

Pull the turn signal lever back.      Press the LaneWatch button again.

**2**

The passenger side view display appears on the audio/information screen.



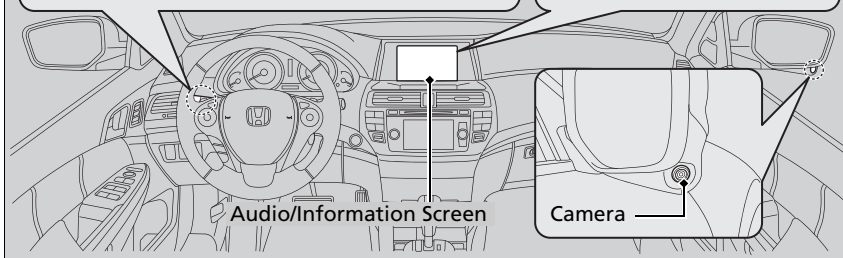

Audio/Information Screen

Camera

### ▶ LaneWatch™\*

## ⚠ WARNING

Failure to visually confirm that it is safe to change lanes before doing so may result in a crash and serious injury or death.

Do not rely only on LaneWatch while driving.

Always look in your mirrors, to either side of your vehicle, and behind you for other vehicles before changing lanes.

### Important Safety Reminder

Like all assistance systems, LaneWatch has limitations. Over reliance on LaneWatch may result in a collision.

The LaneWatch function can be affected by weather, lighting (including headlights and low sun angle), ambient darkness, camera condition, and loading.

The LaneWatch camera view is restricted. Its unique lens makes objects on the screen slightly look different from what they are.

LaneWatch display does not come on when the shift lever is in **R**.

## ■ Customizing the LaneWatch settings

You can customize the following items using the audio/information screen.

- **Show with Turn Signal:** Selects whether LaneWatch monitor comes on when you operate the turn signal light lever.
- **Reference Lines:** Selects whether the reference lines appear on the LaneWatch monitor.
- **Next Maneuver Pop up**\*: Selects whether a turn direction screen of the navigation system interrupts the LaneWatch display.
- **Display:** Adjusts display settings.
  - ☒ **Customized Features**\* P. 281

## ■ Reference Lines

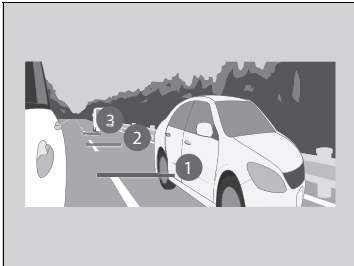

Three lines that appear on the screen can give an idea of how far the vehicles or objects on the screen are from your vehicle, respectively. If an object is near line 1 (in red), it indicates that it is close to your vehicle whereas an object near line 3 farther away.

### ☒ LaneWatch™\*

For a proper LaneWatch use:

- The camera is located in the passenger side door mirror. Always keep this area clean. If the camera lens is covered with dirt or moisture, use a soft, moist cloth to keep the lens clean and free of debris.
- Do not cover the camera lens with labels or stickers of any kind.
- Do not touch the camera lens.

### ☒ Reference Lines

The area around the reference line 1 (red) is very close to your vehicle. As always, make sure to visually confirm the safety of a lane change before changing lanes.

The distance between your vehicle and lines 1, 2 and 3 on the screen vary depending on road condition and vehicle loading. For example, reference lines on the screen may seem to appear closer than the actual distances when the rear of your vehicle is more heavily loaded.

Consult a dealer if:

- The passenger side door mirror, or area around it is severely impacted, resulting in changing the camera angle.
- The LaneWatch display does not come on at all.

\* Not available on all models

## TPMS (Tire Pressure Monitoring System)

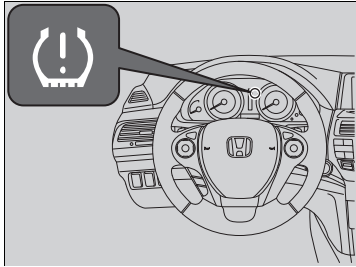

Monitors the tire pressure while you are driving. If your vehicle's tire pressure becomes significantly low, the low tire pressure indicator comes on.

### ⚠ TPMS (Tire Pressure Monitoring System)

Conditions such as low ambient temperature and altitude change directly affect tire pressure and can trigger the low tire pressure indicator to come on.

#### ❏ **If the Low Tire Pressure Indicator Comes On** P. 537

Tire pressure checked and inflated in:

- Warm weather can become under-inflated in colder weather.
- Cold weather can become over-inflated in warmer weather.

The low tire pressure indicator will not come on as a result of over inflation.



## U.S. models

## Tire Pressure Monitoring System (TPMS) - Required Federal Explanation

---

Each tire, including the spare (if provided), should be checked monthly when cold and inflated to the inflation pressure recommended by the vehicle manufacturer on the vehicle placard or tire inflation pressure label.

(If your vehicle has tires of a different size than the size indicated on the vehicle placard or tire inflation pressure label, you should determine the proper tire inflation pressure for those tires.)

As an added safety feature, your vehicle has been equipped with a tire pressure monitoring system (TPMS) that illuminates a low tire pressure telltale



when one or more of your tires is significantly under-inflated.

Accordingly, when the low tire pressure telltale illuminates, you should stop and check your tires as soon as possible, and inflate them to the proper pressure.

Driving on a significantly under-inflated tire causes the tire to overheat and can lead to tire failure. Under-inflation also reduces fuel efficiency and tire tread life, and may affect the vehicle's handling and stopping ability.

Please note that the TPMS is not a substitute for proper tire maintenance, and it is the driver's responsibility to maintain correct tire pressure, even if under-inflation has not reached the level to trigger illumination of the TPMS low tire pressure telltale.

Your vehicle has also been equipped with a TPMS malfunction indicator to indicate when the system is not operating properly. The TPMS malfunction indicator is provided by a separate telltale, which displays the symbol "TPMS" when illuminated.

When the malfunction indicator is illuminated,



the system may not be able to detect or signal low tire pressure as intended.

TPMS malfunctions may occur for a variety of reasons, including the installation of replacement or alternate tires or wheels on the vehicle that prevent the TPMS from functioning properly.

Always check the TPMS malfunction telltale after replacing one or more tires or wheels on your vehicle to ensure that the replacement or alternate tires and wheels allow the TPMS to continue to function properly.

## Brake System

### ■ Parking Brake

Use the parking brake to keep the vehicle stationary when parking.

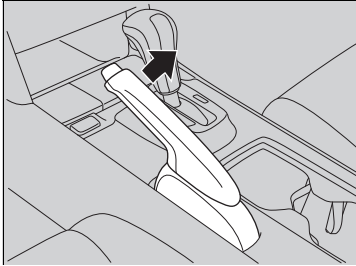

#### **To apply:**

Pull the lever fully up without pressing the release button.

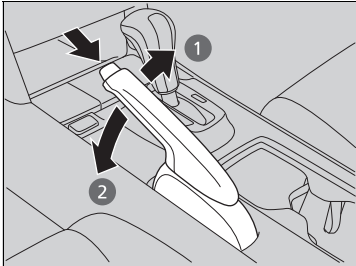

#### **To release:**

1. Pull the lever slightly, and press and hold the release button.
2. Lower the lever down all the way, then release the button.

### ☒ Parking Brake

#### **NOTICE**

Release the parking brake fully before driving. The rear brakes and axle can be damaged if you drive with the parking brake applied.

If you start driving without fully releasing the parking brake, a buzzer sounds as a warning.

Always apply the parking brake when parking.

## ■ Foot Brake

Your vehicle is equipped with disc brakes at all four wheels. A vacuum power assist helps reduce the effort needed on the brake pedal. The brake assist system increases the stopping force when you depress the brake pedal hard in an emergency situation. The anti-lock brake system (ABS) helps you retain steering control when braking very hard.

➤ **Brake Assist System** P. 452

➤ **ABS (Anti-lock Brake System)** P. 451

## ☒ Foot Brake

Check the brakes after driving through deep water, or if there is a buildup of road surface water. If necessary, dry the brakes by lightly depressing the pedal several times.

If you hear a continuous metallic friction sound when applying the brakes, the brake pads need to be replaced. Have the vehicle checked by a dealer.

Constantly using the brake pedal while going down a long hill builds up heat, which reduces the brake effectiveness. Apply engine braking by taking your foot off the accelerator pedal and downshifting to a lower gear.

Do not rest your foot on the brake pedal while driving, as it will lightly apply the brakes and cause them to lose effectiveness over time and reduce pad life. It will also confuse drivers behind you.

## ABS (Anti-lock Brake System)

### ■ ABS

Helps prevent the wheels from locking up, and helps you retain steering control by pumping the brakes rapidly, much faster than you.

The electronic brake distribution (EBD) system, which is part of the ABS, also balances the front-to-rear braking distribution according to vehicle loading.

You should never pump the brake pedal. Let the ABS work for you by always keeping firm, steady pressure on the brake pedal. This is sometimes referred to as “stomp and steer.”

### ■ ABS operation

The brake pedal may pulsate slightly when the ABS is working. Keep holding the pedal firmly down. On dry pavement, you will need to press on the brake pedal very hard before the ABS activates. However, you may feel the ABS activate immediately if you are trying to stop on snow or ice.

When the vehicle speed goes under 6 mph (10 km/h), the ABS stops.

### ⓘ ABS (Anti-lock Brake System)

#### NOTICE

The ABS may not function correctly if you use an incorrect tire type and size.

When the **ABS** indicator comes on while driving, there may be a problem with the system. While normal braking is not affected, there is a possibility of the ABS not operating. Have the vehicle checked by a dealer immediately.

The ABS does not reduce the time or distance it takes to stop the vehicle. It only helps with steering control during hard braking.

In the following cases, your vehicle may need more stopping distance than a vehicle without the ABS:

- When driving on rough road surfaces, including when driving on uneven surfaces, such as gravel or snow.
- When tire chains are installed.

You may hear a motor sound coming from the engine compartment while system checks are being performed immediately after starting the engine or while driving. This is normal.

## Brake Assist System

---

Designed to assist the driver by generating greater braking force when you depress the brake pedal hard during emergency braking.

### ■ Brake assist system operation

Press the brake pedal firmly for more powerful braking.

When brake assist operates, the pedal may wiggle slightly and an operating noise may be heard. This is normal. Keep holding the brake pedal firmly down.

## When Stopped

1. Depress the brake pedal firmly.
2. Firmly apply the parking brake.
3. Move the shift lever from **D** to **P**.
4. Turn off the engine.

Always set the parking brake firmly, in particular if you are parked on an incline.

### ▣ Parking Your Vehicle

Do not park your vehicle near flammable objects, such as dry grass, oil, or timber. Heat from the exhaust can cause a fire.

### ▣ When Stopped

#### NOTICE

The following can damage the transmission:

- Depressing the accelerator and brake pedals simultaneously.
- Holding the vehicle in place when facing uphill by depressing the accelerator pedal.
- Moving the shift lever into **P** before the vehicle stops completely.

Raise the wiper arms when snow is expected.

## About Your Rearview Camera

### Models without touch screen

An image of the rear view is shown in your vehicle's rearview mirror when the shift lever is moved to **R**.

### Rearview Camera Display Area

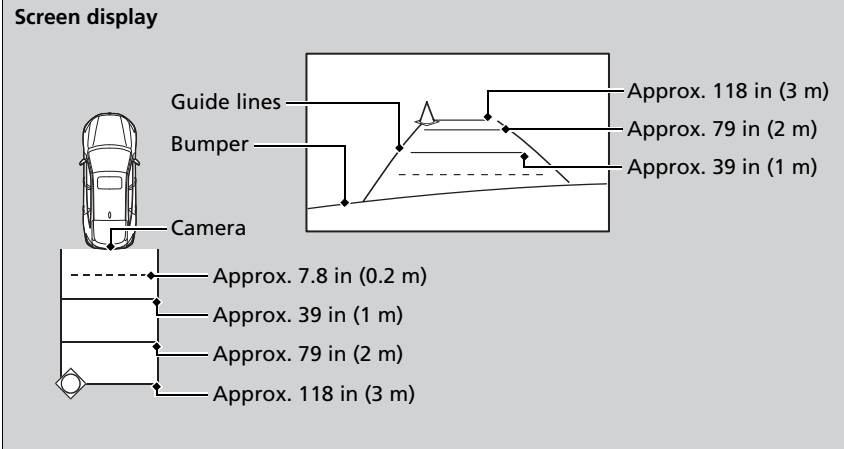

The rearview camera has a unique lens that makes objects appear closer or further than they actually are.

### About Your Rearview Camera

The rear camera view is restricted. You cannot see the corner ends of the bumper and what is underneath the bumper.

Visually confirm that it is safe to drive on before backing up. Do not rely on the rearview display, which does not give you complete information.

Certain conditions (such as weather, lighting, and high temperatures) may also restrict the rear view. Use a soft, moist cloth to keep the lens clean and free of debris.

You can select to have the guide lines appearing on the rearview camera display while the shift lever is in **R**. Press the Auto button for about five seconds to turn them on or off.

The rearview display is turned on every time you shift to **R**.

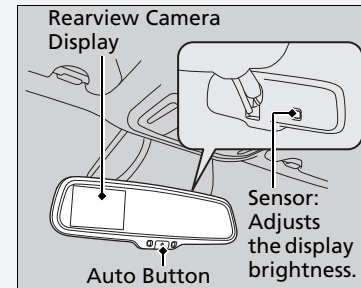

The rearview mirror gets hot if the rearview display is used for an extended period.



# Multi-View Rear Camera

Models with touch screen

## About Your Multi-View Rear Camera

The audio/information screen can display your vehicle's rear view. The display automatically changes to the rear view when the shift lever is moved to **R**.

### Multi-View Rear Camera Display Area

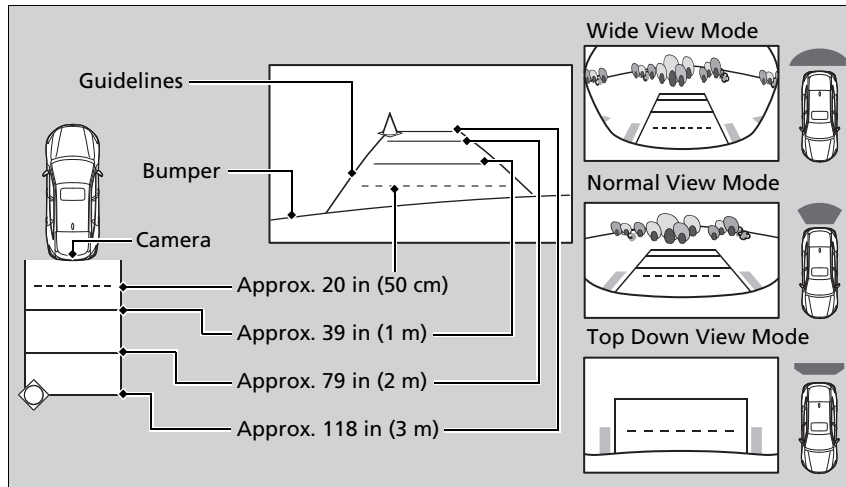

You can view three different camera angles on the rearview display. Press the **MENU/SEL** (Selector) knob or the interface dial to switch the angle.

If the last used viewing mode is Wide or Normal, the same mode is selected the next time you shift into **R**. If Top View was last used, Wide mode is selected.

\* Not available on all models

### About Your Multi-View Rear Camera

The rear camera view is restricted. You cannot see the corner ends of the bumper or what is underneath the bumper. Its unique lens also makes objects appear closer or farther than they actually are.

Visually confirm that it is safe to drive before backing up. Certain conditions (such as weather, lighting, and high temperatures) may also restrict the rear view. Do not rely on the rearview display which does not give you all information about conditions at the back of your vehicle.

If the camera lens is covered with dirt or moisture, use a soft, moist cloth to keep the lens clean and free of debris.

You can change the **Fixed Guideline** and **Dynamic Guideline** settings.

➤ **Customized Features\*** P. 281

#### Fixed Guideline

**On:** Guidelines appear when you shift into **R**.

**Off:** Guidelines do not appear.

#### Dynamic Guideline

**On:** Guidelines move according to the steering wheel direction.

**Off:** Guidelines do not move.

## Fuel Information

### ■ Fuel recommendation

**Unleaded gasoline, pump octane number 87 or higher**

Use of lower octane gasoline can cause a persistent, heavy metallic knocking noise that can lead to engine damage.

### ■ Top tier detergent gasoline

Because the level of detergency and additives in gasoline vary in the market, Honda endorses the use of “TOP TIER Detergent Gasoline” where available to help maintain the performance and reliability of your vehicle. TOP TIER Detergent Gasoline meets a new gasoline standard jointly established by leading automotive manufacturers to meet the needs of today’s advanced engines.

Qualifying gasoline retailers will, in most cases, identify their gasoline as having met “TOP TIER Detergent Gasoline” standards at the retail location. This fuel is guaranteed to contain the proper level of detergent additives and be free of metallic additives. The proper level of detergent additives, and absence of harmful metallic additives in gasoline, help avoid build-up of deposits in your engine and emission control system.

For further important fuel-related information for your vehicle, or on information on gasoline that does not contain MMT, visit [www.hondacars.com](http://www.hondacars.com). In Canada, visit [www.honda.ca](http://www.honda.ca) for additional information on gasoline. For more information on top tier gasoline, visit [www.toptiergas.com](http://www.toptiergas.com).

### ■ Fuel tank capacity: 18.5 US gal (70 liters)

### » Fuel Information

#### NOTICE

We recommend quality gasoline containing detergent additives that help prevent fuel system and engine deposits. In addition, in order to maintain good performance, fuel economy, and emissions control, we strongly recommend the use of gasoline that does NOT contain harmful manganese-based fuel additives such as MMT, if such gasoline is available.

Use of gasoline with these additives may adversely affect performance, and cause the malfunction indicator lamp on your instrument panel to come on. If this happens, contact a dealer for service.

Some gasoline today is blended with oxygenates such as ethanol. Your vehicle is designed to operate on oxygenated gasoline containing up to 10% ethanol by volume. Do not use gasoline containing methanol. If you notice any undesirable operating symptoms, try another service station or switch to another brand of gasoline.

## How to Refuel

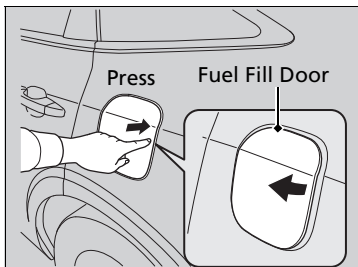
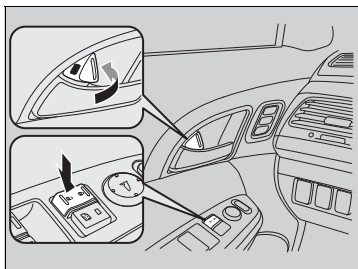

1. Stop your vehicle with the service station pump on the left side of the vehicle in the rear.
2. Turn off the engine.
3. Unlock the driver's door using the lock tab or the master door lock switch.
  - ▶ The fuel fill door on the outer side of the vehicle will unlock.
4. Press the area indicated by the arrow to release the fuel fill door. You will hear a click.

### How to Refuel

## ⚠ WARNING

Gasoline is highly flammable and explosive. You can be burned or seriously injured when handling fuel.

- Stop the engine, and keep heat, sparks, and flame away.
- Handle fuel only outdoors.
- Wipe up spills immediately.

Use the lock tab or the master door lock switch to unlock the fuel fill door. The vehicle doors and fuel fill door automatically relock if the remote unlock function is used. This can be deactivated by briefly opening then closing the driver's door.

### NOTICE

The fuel fill door and its latching mechanism can be permanently damaged if the fuel fill door is forced closed when the driver's door is locked.

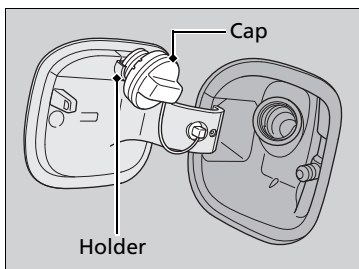
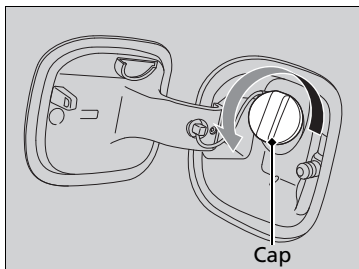

5. Remove the fuel fill cap slowly. If you hear a release of air, wait until this stops, then turn the knob slowly to open the fuel fill cap.

6. Place the fuel fill cap in the holder.

7. Insert the filler nozzle fully.

▶ When the tank is full, the fuel nozzle will click off automatically. This leaves space in the fuel tank in case the fuel expands with a change in the temperature.

8. After filling, replace the fuel fill cap, tightening it until you hear it click at least once.

▶ Shut the fuel fill door by hand.

#### How to Refuel

The filler nozzle automatically stops to leave space in the fuel tank so that fuel does not overflow as a result of changes in air temperature.

If the fuel nozzle keeps turning off when the tank is not full, there may be a problem with the pump's fuel vapor recovery system. Try filling at another pump. If this does not fix the problem, consult a dealer.

Do not continue to add fuel after the nozzle has automatically stopped. Additional fuel can exceed the full tank capacity.

## Improving Fuel Economy

Fuel economy depends on several conditions, including driving conditions, your driving habits, the condition of your vehicle, and loading. Depending on these and other conditions, you may or may not achieve the rated fuel economy of this vehicle.

### Maintenance and Fuel Economy

You can optimize your fuel economy with proper maintenance of your vehicle. Always maintain your vehicle in accordance with the messages displayed on the information display.

- Use the recommended viscosity engine oil, displaying the API Certification Seal.
- Maintain the specified tire pressure.
- Do not load the vehicle with excess cargo.
- Keep your vehicle clean. A buildup of snow or mud on your vehicle's underside adds weight and increases wind resistance.

### Improving Fuel Economy

Direct calculation is the recommended method to determine actual fuel consumed while driving.

Miles driven	÷	Gallons of fuel	=	Miles per Gallon		
100	×	Liter	÷	Kilometers	=	L per 100 km

In Canada, posted fuel economy numbers are established following a simulated test. For more information on how this test is performed, please visit <http://oee.nrcan.gc.ca/>

## Accessories

When installing accessories, check the following:

- Do not install accessories on the windshield. They can obstruct your view and delay your reaction to driving conditions.
  - ❏ **Forward Collision Warning (FCW)\*** P. 435
  - ❏ **Lane Departure Warning (LDW)\*** P. 439
- Do not install accessories on the side pillars or across the side windows. Accessories installed in these areas may interfere with proper operation of the side curtain airbags.
- Be sure electronic accessories do not overload electrical circuits or interfere with proper operation of your vehicle.
  - ❏ **Fuses** P. 538
- Before installing any electronic accessory, have the installer contact a dealer for assistance. If possible, have a dealer inspect the final installation.

## Modifications

Do not modify your vehicle or use non-Honda components that can affect its handling, stability, and reliability.

Overall vehicle performance can be affected. Always make sure all equipment is properly installed and maintained, and that it meets federal, state, province, territory, and local regulations.

### Accessories and Modifications

#### **WARNING**

Improper accessories or modifications can affect your vehicle's handling, stability, and performance, and cause a crash in which you can be seriously hurt or killed.

Follow all instructions in this owner's manual regarding accessories and modifications.

Honda Genuine accessories are recommended to ensure proper operation on your vehicle.

# Maintenance

This chapter discusses basic maintenance.



## Before Performing Maintenance

Inspection and Maintenance .....	462
Safety When Performing Maintenance.....	463
Parts and Fluids Used in Maintenance	
Service .....	464

## Maintenance Minder™ .....

465

## Maintenance Under the Hood

Maintenance Items Under the Hood.....	469
Opening the Hood .....	471
Recommended Engine Oil .....	472
Oil Check .....	473
Adding Engine Oil .....	475
Changing the Engine Oil and Oil Filter .....	476

Engine Coolant .....	478
Transmission Fluid .....	480
Brake Fluid .....	481
Power Steering Fluid Check* .....	482
Refilling Window Washer Fluid.....	483
<b>Replacing Light Bulbs</b> .....	484
<b>Checking and Maintaining Wiper Blades</b> ...	493
<b>Checking and Maintaining Tires</b>	
Checking Tires .....	497
Tire and Loading Information Label .....	498
Tire Labeling .....	498
DOT Tire Quality Grading (U.S. Vehicles).....	500
Wear Indicators.....	502

Tire Service Life .....	502
Tire and Wheel Replacement .....	503
Tire Rotation .....	504
Winter Tires .....	505
<b>Battery</b> .....	506
<b>Remote Transmitter Care</b> .....	507
Replacing the Button Battery .....	507
<b>Heating and Cooling System*/Climate Control System* Maintenance</b> .....	509
<b>Cleaning</b>	
Interior Care .....	510
Exterior Care.....	512

\* Not available on all models

## Inspection and Maintenance

For your safety, perform all listed inspections and maintenance to keep your vehicle in good condition. If you become aware of any abnormality (noise, smell, insufficient brake fluid, oil residue on the ground, etc.), have your vehicle inspected by a dealer. (Note, however, that service at a dealer is not mandatory to keep your warranties in effect.) Refer to the separate maintenance booklet for detailed maintenance and inspection information.

### Types of Inspection and Maintenance

#### ■ Daily inspections

Perform inspections before long distance trips, when washing the vehicle, or when refueling.

#### ■ Periodic inspections

- Check the brake fluid level monthly.
  - **Checking the Brake Fluid** P. 481
- Check the tire pressure monthly. Examine the tread for wear and foreign objects.
  - **Checking and Maintaining Tires** P. 497
- Check the operation of the exterior lights monthly.
  - **Replacing Light Bulbs** P. 484
- Check the condition of the wiper blades at least every six months.
  - **Checking and Maintaining Wiper Blades** P. 493

### Inspection and Maintenance

#### U.S. models

**Maintenance, replacement, or repair of emissions control devices and systems may be done by any automotive repair establishment or individuals using parts that are "certified" to EPA standards.**

According to state and federal regulations, failure to perform maintenance on the maintenance main items marked with # will not void your emissions warranties. However, all maintenance services should be performed in accordance with the intervals indicated by the information display.

➤ **Maintenance Service Items** P. 467

If you want to perform complex maintenance tasks that require more skills and tools, you can purchase a subscription to the Service Express website at [www.techinfo.honda.com](http://www.techinfo.honda.com).

➤ **Authorized Manuals** P. 557

If you want to perform maintenance yourself, make sure that you have the necessary tools and skills first. After performing maintenance, update the records in the separate maintenance booklet.



## Safety When Performing Maintenance

Some of the most important safety precautions are given here. However, we cannot warn you of every conceivable hazard that can arise in performing maintenance. Only you can decide whether or not you should perform a given task.

### Maintenance Safety

- To reduce the possibility of fire or explosion, keep cigarettes, sparks, and flames away from the battery and all fuel related parts.
- Never leave rags, towels, or other flammable objects under the hood.
  - ▶ Heat from the engine and exhaust can ignite them causing a fire.
- To clean parts, use a commercially available degreaser or parts cleaner, not gasoline.
- Wear eye protection and protective clothing when working with the battery or compressed air.
- Engine exhaust contains carbon monoxide, which is poisonous and can kill you.
  - ▶ Only operate the engine if there is sufficient ventilation.

### Vehicle Safety

- The vehicle must be in a stationary condition.
  - ▶ Make sure your vehicle is parked on level ground, the parking brake is set, and the engine is off.
- Be aware that hot parts can burn you.
  - ▶ Make sure to let the engine and exhaust system cool thoroughly before touching vehicle parts.
- Be aware that moving parts can injure you.
  - ▶ Do not start the engine unless instructed, and keep your hands and limbs away from moving parts.

#### ⚠ Safety When Performing Maintenance

### ⚠ WARNING

Improperly maintaining this vehicle or failing to correct a problem before driving can cause a crash in which you can be seriously hurt or killed.

Always follow the inspection and maintenance recommendations according to the schedules in this owner's manual.

### ⚠ WARNING

Failure to properly follow maintenance instructions and precautions can cause you to be seriously hurt or killed.

Always follow the procedures and precautions in this owner's manual.

## Parts and Fluids Used in Maintenance Service

---



The use of Honda genuine parts and fluids is recommended when maintaining and servicing your vehicle. Honda genuine parts are manufactured according to the same high quality standards used in Honda vehicles.

If the engine oil life is less than 15%, you will see the Maintenance Minder messages appear on the information display every time you turn the ignition switch to ON \*1. The messages notify you when to change the engine oil, or when to bring your vehicle to a dealer for indicated maintenance services.

## To Use Maintenance Minder™

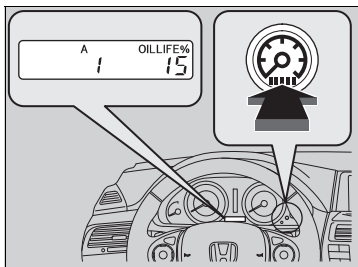
### ■ Displaying the Engine Oil Life



1. Turn the ignition switch to ON \*1.
2. Press the  (Select/Reset) knob repeatedly until the engine oil life appears on the information display.

The Maintenance Minder indicator () stays on in the instrument panel after the engine oil life becomes **0%**. Have the indicated maintenance done by a dealer immediately.

### ▣ Displaying the Engine Oil Life





Based on the engine operating conditions, the remaining engine oil life is calculated and displayed as a percentage.

Displayed Engine Oil Life (%)	Calculated Engine Oil Life (%)
100	100 to 91
90	90 to 81
80	80 to 71
70	70 to 61
60	60 to 51
50	50 to 41
40	40 to 31
30	30 to 21
20	20 to 16
15	15 to 11
10	10 to 6
5	5 to 1
0	0

\*1: Models with the smart entry system have an **ENGINE START/STOP** button instead of an ignition switch.

## ■ Maintenance Minder Messages on the Information Display

To switch the display, press the  (Select/Reset) knob.

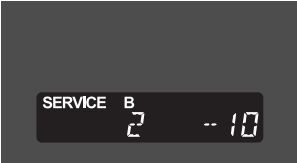
Oil Life Display	Explanation	Information	Maintenance Minder Indicator
	The engine oil life indicator starts to appear along with other due soon maintenance item codes when the remaining oil life becomes 15 percent.	The engine oil is approaching the end of its service life.	 Starts to come on when the remaining engine oil life becomes 15 percent. It goes off when the display is switched.
	The <b>SERVICE</b> message also starts to appear along with the engine oil life indicator and the maintenance item codes.	The engine oil has almost reached the end of its service life, and the maintenance items should be inspected and serviced as soon as possible.	 Stays on as a reminder even when the display is switched.
	The remaining engine oil life has passed its service life, and a negative distance appears after driving over 10 miles (U.S. models) or 10 km (Canadian models). The negative distance on the display blinks.	The engine oil life has passed. The maintenance items must be inspected and serviced immediately.	

## Maintenance Service Items

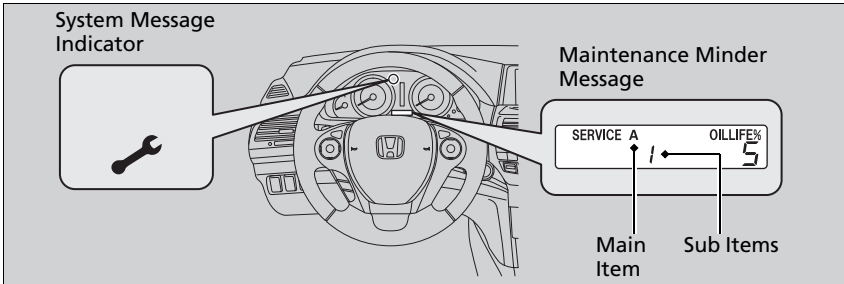

### Maintenance Service Items

- Independent of the Maintenance Minder information, replace the brake fluid every 3 years.
- Inspect idle speed every 160,000 miles (256,000 km).
- Adjust the valves during services A, B, 1, 2, or 3 if they are noisy.

CODE	Maintenance Main Items
A	<ul style="list-style-type: none"> <li>• Replace engine oil*<sup>1</sup></li> </ul>
B	<ul style="list-style-type: none"> <li>• Replace engine oil*<sup>1</sup> and oil filter</li> <li>• Inspect front and rear brakes</li> <li>• Check parking brake adjustment</li> <li>• Inspect tie rod ends, steering gearbox, and boots</li> <li>• Inspect suspension components</li> <li>• Inspect driveshaft boots</li> <li>• Inspect brake hoses and lines (Including ABS/VSA)</li> <li>• Inspect all fluid levels and condition of fluids</li> <li>• Inspect exhaust system<sup>#</sup></li> <li>• Inspect fuel lines and connections<sup>#</sup></li> </ul>

\*1: If a message **SERVICE** does not appear more than 12 months after the display is reset, change the engine oil every year.

# : See information on maintenance and emissions warranty.

CODE	Maintenance Sub Items
1	<ul style="list-style-type: none"> <li>• Rotate tires</li> </ul>
2	<ul style="list-style-type: none"> <li>• Replace air cleaner element*<sup>2</sup></li> <li>• Replace dust and pollen filter*<sup>3</sup></li> <li>• Inspect drive belt</li> </ul>
3	<ul style="list-style-type: none"> <li>• Replace transmission and transfer*<sup>4</sup> fluid</li> </ul>
4	<ul style="list-style-type: none"> <li>• Replace spark plugs</li> <li>• Replace timing belt and inspect water pump*<sup>5</sup>, *<sup>6</sup></li> <li>• Inspect valve clearance</li> </ul>
5	<ul style="list-style-type: none"> <li>• Replace engine coolant</li> </ul>
6	<ul style="list-style-type: none"> <li>• Replace rear differential fluid*<sup>4</sup></li> </ul>

\*2: If you drive in dusty conditions, replace the air cleaner element every 15,000 miles (24,000 km).

\*3: If you drive primarily in urban areas that have high concentrations of soot in the air from industry and from diesel-powered vehicles, replace the dust and pollen filter every 15,000 miles (24,000 km).

\*4: 4WD only

\*5: 6-cylinder models



\*6: If you drive regularly in very high temperatures (over 110°F, 43°C), in very low temperatures (under -20°F, -29°C), or tow a trailer, replace every 60,000 miles (U.S.)/100,000 km (Canada).

Continued

## ■ Resetting the Display

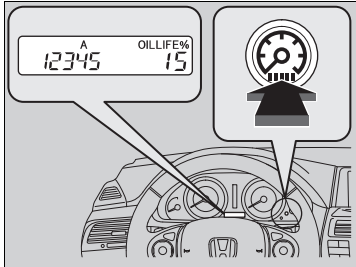
Reset the engine oil life display if you have performed the maintenance service.



1. Turn the ignition switch to ON **II**\*1.
2. Display the engine oil life by repeatedly pressing the  (Select/Reset) knob.
3. Press and hold the  knob for ten seconds or more.
  - The engine oil life indicator and the maintenance item codes blink.
4. Press the  knob for five seconds or more.
  - The displayed maintenance items disappear, and the engine oil life display returns to **100%**.

## ►► Resetting the Display

### NOTICE

Failure to reset the engine oil life after a maintenance service results in the system showing incorrect maintenance intervals, which can lead to serious mechanical problems.

The dealer will reset the engine oil life display after completing the required maintenance service. If someone other than a dealer performs maintenance service, reset the engine oil life display yourself.

### Models with audio/information screen

You can reset the engine oil life display using the audio/information screen.

► **Customized Features\*** P. 281

\*1: Models with the smart entry system have an **ENGINE START/STOP** button instead of an ignition switch.

\* Not available on all models

## Maintenance Items Under the Hood

4-cylinder models

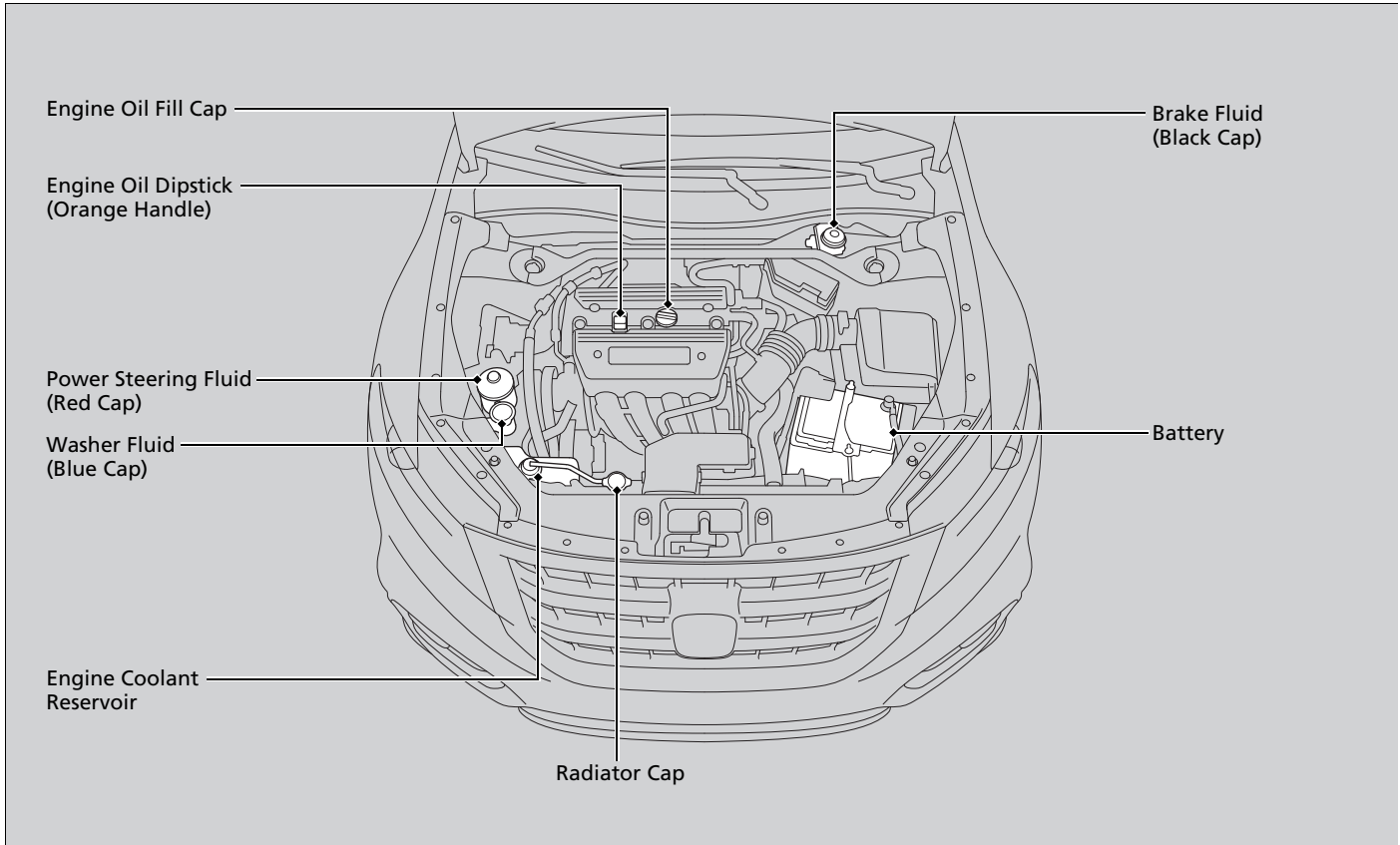

6-cylinder models

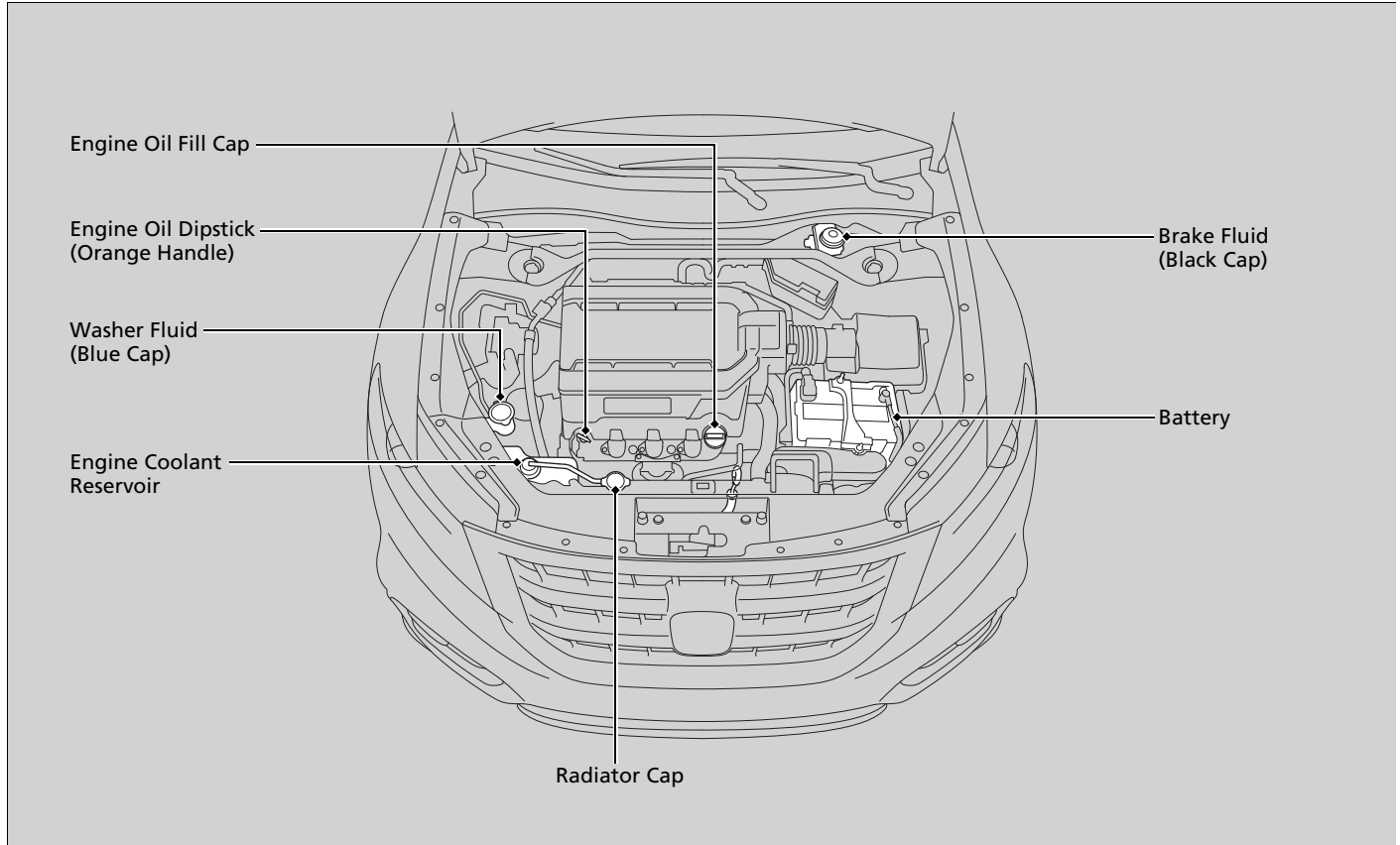



## Opening the Hood

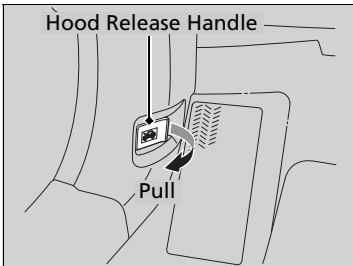

1. Park the vehicle on a level surface, and set the parking brake.
2. Pull the hood release handle under the lower left corner of the dashboard.
  - The hood will pop up slightly.

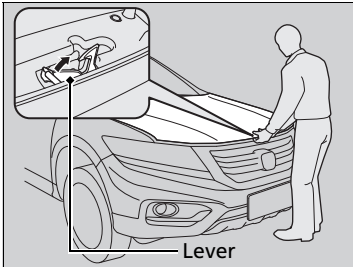

3. Push up the hood latch lever in the center of the hood to release the lock mechanism, and open the hood.

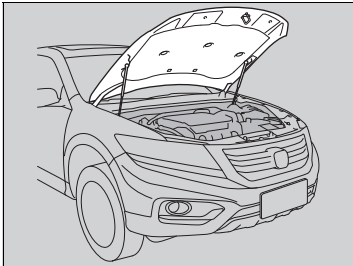

4. Lift the hood up most of the way.
  - The hydraulic supports will lift it up the rest of the way and hold it up.

When closing, lower it to approximately 12 inches (30 cm), then press down firmly with your hands.

### Opening the Hood

#### NOTICE

Do not open the hood when the wiper arms are raised. The hood will strike the wipers, and may damage either the hood or the wipers.

When closing the hood, check that the hood is securely latched.

If the hood latch lever moves stiffly, or if you can open the hood without lifting the lever, the latch mechanism should be cleaned and lubricated.

## Recommended Engine Oil

- **Genuine Honda Motor Oil**
- **Premium-grade 0W-20 detergent oil with an API Certification Seal on the container.**



Oil is a major contributor to your engine's performance and longevity. If you drive the vehicle with insufficient or deteriorated oil, the engine may fail or be damaged.

This seal indicates the oil is energy conserving and that it meets the American Petroleum Institute's latest requirements.

Use a Genuine Honda Motor Oil or another commercial engine oil of suitable viscosity for the ambient temperature as shown.

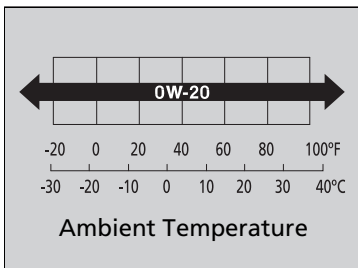

### ■ Synthetic oil

You may also use synthetic motor oil if it is labeled with the API Certification Seal and is the specified viscosity grade.

### ►► Recommended Engine Oil

#### Engine Oil Additives

Your vehicle does not require oil additives. In fact, they may adversely affect the engine performance and durability.

## Oil Check

We recommend that you check the engine oil level every time you refuel.

Park the vehicle on level ground.

Wait approximately three minutes after turning the engine off before you check the oil.

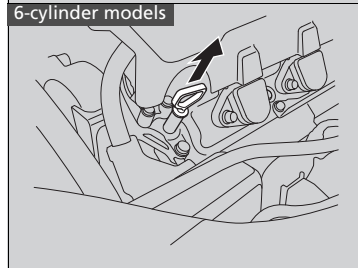
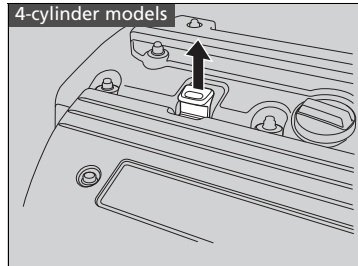

1. Remove the dipstick (orange handle).
2. Wipe the dipstick with a clean cloth or paper towel.
3. Insert the dipstick back all the way into its hole.

### Oil Check

If the oil level is near or below the lower mark, slowly add oil being careful not to overfill.

*Continued*

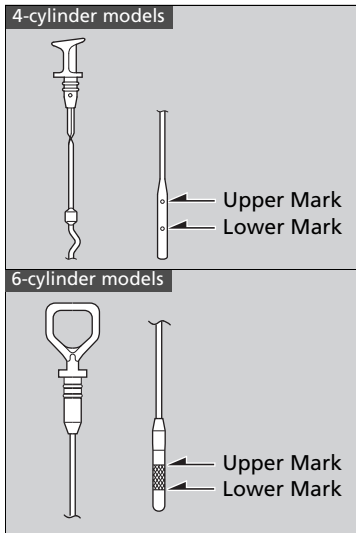

4. Remove the dipstick again, and check the level. It should be between the upper and lower marks. Add oil if necessary.

## Adding Engine Oil

4-cylinder models

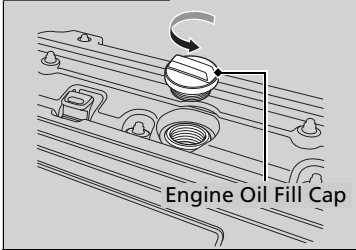

6-cylinder models

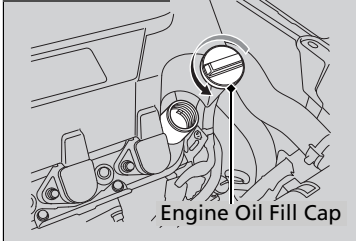

1. Unscrew and remove the engine oil fill cap.
2. Add oil slowly.
3. Reinstall the engine oil fill cap, and tighten it securely.
4. Wait for three minutes and recheck the engine oil dipstick.

### Adding Engine Oil

If any oil spills, wipe it up immediately. Spilled oil may damage the engine compartment components.

#### NOTICE

Do not fill the engine oil above the upper mark. Overfilling the engine oil can result in leaks and engine damage.

## Changing the Engine Oil and Oil Filter

You must change the engine oil and oil filter regularly in order to maintain the engine's lubrication. The engine may be damaged if they are not changed regularly.

Change the oil and filter in accordance with the maintenance message on the information display\*/multi-information display\*.

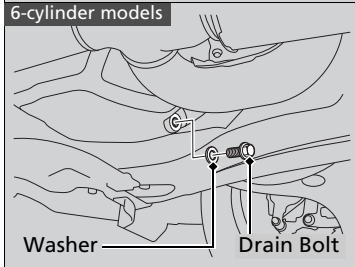
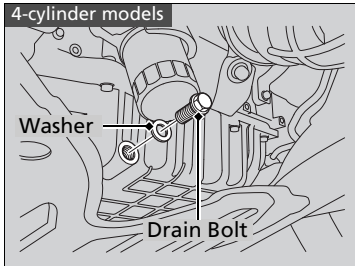

1. Run the engine until it reaches normal operating temperature, and then turn the engine off.
2. Open the hood and remove the engine oil fill cap.
3. Remove the drain bolt and washer from the bottom of the engine, and drain the oil into a suitable container.

### Changing the Engine Oil and Oil Filter

#### NOTICE

You may damage the environment if you do not dispose of the oil in a suitable way. If you are changing the oil by yourself, appropriately dispose of the used oil. Put the oil in a sealed container and take it to a recycling center. Do not throw the oil away into a garbage can or onto the ground.

4-cylinder models

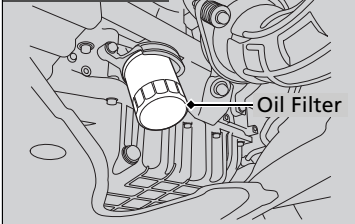

6-cylinder models

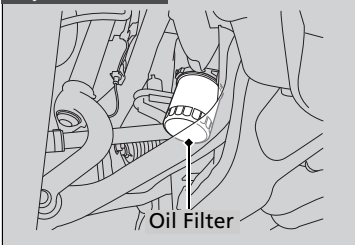

4. Remove the oil filter and dispose of the remaining oil.
5. Check that the filter gasket is not stuck to the engine contact surface.
  - If it is stuck, you must detach it.
6. Wipe away dirt and dust adhering to the contact surface of the engine block, and install a new oil filter.
  - Apply a light coat of new engine oil to the oil gasket.
7. Put a new washer on the drain bolt, then reinstall the drain bolt.
  - Tightening torque:  
29 lbf·ft (39 N·m, 4.0 kgf·m)
8. Pour the recommended engine oil into the engine.
  - Engine oil change capacity (including filter):
    - 4-cylinder models**  
4.2 US qt (4.0 L)
    - 6-cylinder models**  
4.5 US qt (4.3 L)
9. Reinstall the engine oil fill cap securely and start the engine.
10. Run the engine for a few minutes, and then check that there is no leak from the drain bolt or oil filter.
11. Stop the engine, wait for three minutes, and then check the oil level on the dipstick.
  - If necessary, add more engine oil.

#### ►► Changing the Engine Oil and Oil Filter

You will need a special wrench to replace the oil filter. You can buy this wrench from a dealer.

When installing the new oil filter, follow the instructions supplied with the oil filter.

Reinstall the engine oil fill cap. Start the engine. The low oil pressure indicator should go off within five seconds. If it does not, turn off the engine, and check your work.

## Engine Coolant

### Specified coolant: Honda Long Life Antifreeze/Coolant Type 2

This coolant is premixed with 50% antifreeze and 50% water. Do not add any straight antifreeze or water.

We recommend you check the engine coolant level every time you refuel. Check the reserve tank first. If it is completely empty, also check the coolant level in the radiator. Add the engine coolant accordingly.

### Reserve Tank

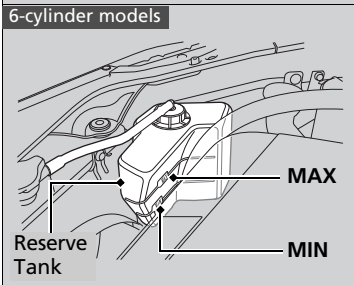
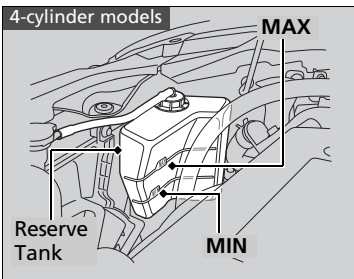

1. Check the amount of coolant in the reserve tank.

### Engine Coolant

#### NOTICE

If temperatures consistently below  $-22^{\circ}\text{F}$  ( $-30^{\circ}\text{C}$ ) are expected, the coolant mixture should be changed to a higher concentration. Consult a dealer for more information.

If Honda antifreeze/coolant is not available, you may use another major brand non-silicate coolant as a temporary replacement. Check that it is a high quality coolant recommended for aluminum engines. Continued use of any non-Honda coolant can result in corrosion, causing the cooling system to malfunction or fail. Have the cooling system flushed and refilled with Honda antifreeze/coolant as soon as possible.

Do not add rust inhibitors or other additives to your vehicle's coolant system. They may not be compatible with the coolant or with the engine components.



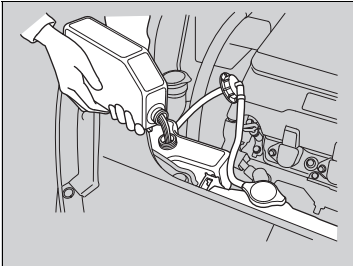

2. If the coolant level is below the **MIN** mark, add the specified coolant until it reaches the **MAX** mark.
3. Inspect the cooling system for leaks.

## Radiator

### 4-cylinder models

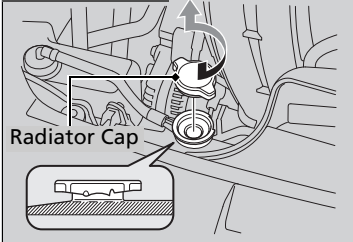

1. **Make sure the engine and radiator are cool.**
2. Turn the radiator cap counterclockwise and relieve any pressure in the coolant system. Do not push the cap down when turning.
3. Push down and turn the radiator cap counterclockwise to remove it.
4. The coolant level should be up to the base of the filler neck. Add coolant if it is low.
5. Put the radiator cap back on, and tighten it fully.
6. Pour coolant into the reserve tank until it reaches the **MAX** mark. Put the cap back on the reserve tank.

### 6-cylinder models

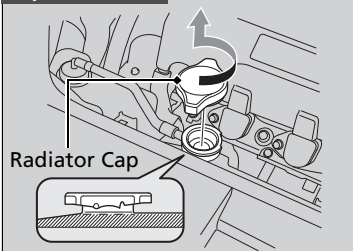

### ⌘ Radiator

## ⚠ WARNING

Removing the radiator cap while the engine is hot can cause the coolant to spray out, seriously scalding you.

Always let the engine and radiator cool down before removing the radiator cap.

### NOTICE

Pour the fluid slowly and carefully so you do not spill any. Clean up any spills immediately; they can damage components in the engine compartment.

## Transmission Fluid

### ■ Automatic Transmission Fluid

**Specified fluid: Honda ATF DW-1 (automatic transmission fluid)**

Have a dealer check the fluid level and replace if necessary.

#### » Automatic Transmission Fluid

##### NOTICE

**Do not mix Honda ATF DW-1 with other transmission fluids.**

Using a transmission fluid other than Honda ATF DW-1 may adversely affect the operation and durability of your vehicle's transmission, and damage the transmission.

Any damage caused by using a transmission fluid that is not equivalent to Honda ATF DW-1 is not covered by Honda's new vehicle warranty.

## Brake Fluid

**Specified fluid: Honda Heavy Duty Brake Fluid DOT 3**

### Checking the Brake Fluid

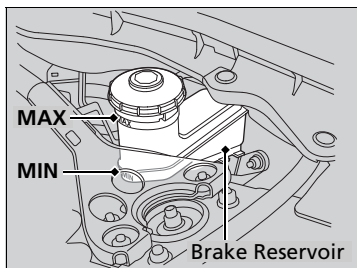

The fluid level should be between the **MIN** and **MAX** marks on the side of the reservoir.

### Brake Fluid

#### NOTICE

Brake fluid marked DOT 5 is not compatible with your vehicle's braking system and can cause extensive damage.

If the specified brake fluid is not available, you should use only DOT 3 or DOT 4 fluid from a sealed container as a temporary replacement.

Using any non-Honda brake fluid can cause corrosion and decrease the longevity of the system. Have the brake system flushed and refilled with Honda Heavy Duty Brake Fluid DOT 3 as soon as possible.

If the brake fluid level is at or below the **MIN** mark, have a dealer inspect for leaks or worn brake pads as soon as possible.

## Power Steering Fluid Check\*

4-cylinder models

### Specified fluid: Honda Power Steering Fluid

We recommend that you check the power steering fluid level every time you refuel. Check when the engine is not running.

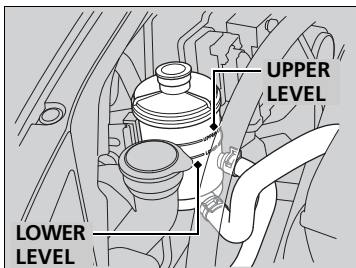

1. Look at the side of the reservoir. The fluid should be between the **UPPER LEVEL** and **LOWER LEVEL**.
2. Add power steering fluid if necessary to the **UPPER LEVEL** mark.
  - Inspect the system for a leak. If the fluid level goes below the **LOWER LEVEL** frequently, have the system inspected as soon as possible.

### ►► Power Steering Fluid Check\*

#### NOTICE

Turning the steering wheel to full left or right lock and holding it there can damage the power steering pump.

#### NOTICE

Pour the fluid slowly and carefully so you do not spill any. Clean up any spills immediately; it could damage components in the engine compartment.

## Refilling Window Washer Fluid

Check the amount of window washer fluid using the washer fluid level gauge on the cap.

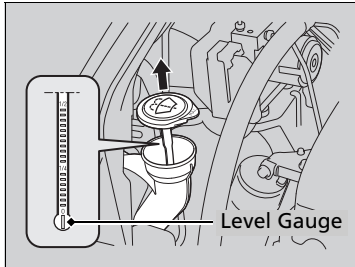

If the level is low, fill the washer reservoir.

### Canadian models

If the washer fluid is low, the washer level indicator comes on.

Pour the washer fluid carefully. Do not overflow the reservoir.

### Refilling Window Washer Fluid

#### NOTICE

Do not use engine antifreeze or a vinegar/water solution in the windshield washer reservoir. Antifreeze can damage your vehicle's paint. A vinegar/water solution can damage the windshield washer pump.

## Headlight Bulbs

When replacing, use the following bulbs.

**High beam headlight: 60W (HB3 for halogen bulb type)**

**Low beam headlight: 55W (H11 for halogen bulb type)**

### High Beam Headlight

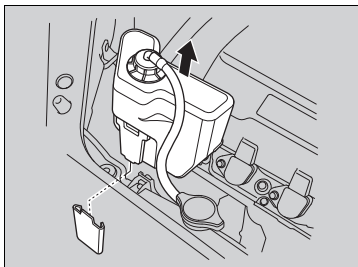

Passenger side

1. Remove the engine coolant reservoir.

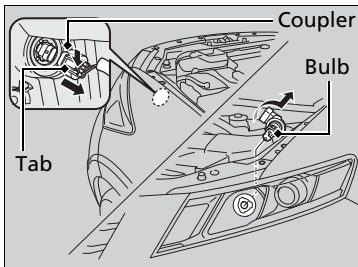

2. Push the tab to remove the coupler.

3. Rotate the old bulb to the left to remove.

4. Insert a new bulb into the headlight assembly and turn it to the right.

5. Insert the coupler into the connector of the bulb.

### Headlight Bulbs

#### NOTICE

Halogen bulbs get very hot when lit. Oil, perspiration, or a scratch on the glass can cause the bulb to overheat and shatter.

The headlight aim is set by the factory, and does not need to be adjusted. However, if you regularly carry heavy items in the cargo area or tow a trailer, have the aiming readjusted at a dealer or by a qualified technician.

When replacing a halogen bulb, handle it by its base, and protect the glass from contact with your skin or hard objects. If you touch the glass, clean it with denatured alcohol and a clean cloth.

The exterior lights' inside lenses (headlights, brake lights, etc.) may fog temporarily after a car wash or while driving in the rain. This does not impact the exterior light function. However, if you see a large amount of water or ice accumulated inside the lenses, have your vehicle inspected by a dealer.

## Low Beam Headlights

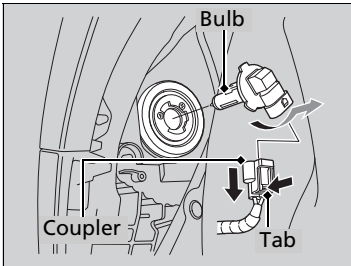
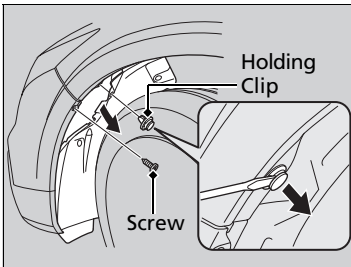

1. Turn the steering wheel all the way to the opposite side from the light being replaced.  
**Passenger side:** Turn the steering wheel to the left.  
**Driver side:** Turn the steering wheel to the right.
2. Remove the holding clip and screw, and pull the inner fender back.
3. Push the tab to remove the coupler.
4. Rotate the old bulb to the left to remove.
5. Insert a new bulb into the headlight assembly and turn it to the right.
6. Insert the coupler into the connector of the bulb.

## Headlight Bulbs

Insert a flat-tip screwdriver, lift and remove the central pin to remove the clip.

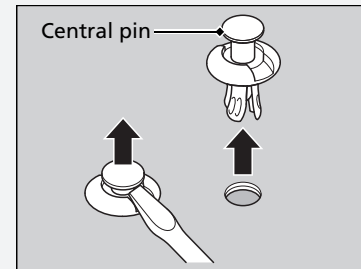

Insert the clip with the central pin raised, and push until it is flat.

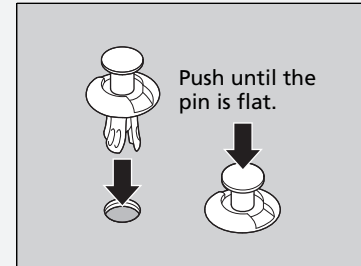

## Fog Light Bulbs

When replacing, use the following bulbs.

**Fog Light: 55 W (H11 for halogen bulb type)**

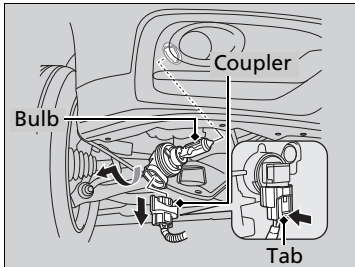
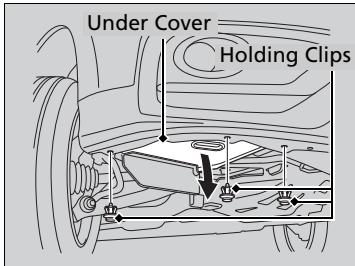

### Passenger side

1. Remove the holding clips, then push up the under cover.
2. Push the tab to remove the coupler.
3. Rotate the old bulb to the left to remove.
4. Insert a new bulb into the fog light assembly and turn it to the right.
5. Insert the coupler into the connector of the bulb.

### ► Fog Light Bulbs

#### NOTICE

Halogen bulbs get very hot when lit. Oil, perspiration, or a scratch on the glass can cause the bulb to overheat and shatter.

When replacing a halogen bulb, handle it by its plastic case, and protect the glass from contact with your skin or hard objects. If you touch the glass, clean it with denatured alcohol and a clean cloth.

Remove the clip by using a flat-tip screwdriver.

► **Low Beam Headlights** P. 485



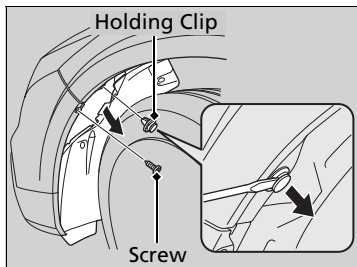

**Driver side**

1. Turn the steering wheel all the way to the right.
2. Remove the holding clips and screw, and pull the inner fender back.

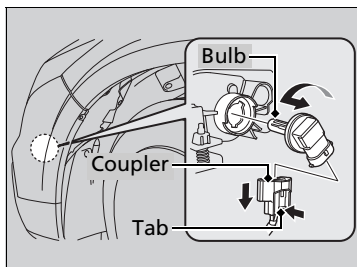

3. Push the tab to remove the coupler.
4. Rotate the old bulb to the left to remove.
5. Insert a new bulb into the headlight assembly and turn it to the right.
6. Insert the coupler into the connector of the bulb.

▶ Fog Light Bulbs

Remove the clip by using a flat-tip screwdriver.

▶ **Low Beam Headlights** P. 485

## Front Side Marker Light Bulb

When replacing, use the following bulbs.

**Front Side Marker Light: 5 W**

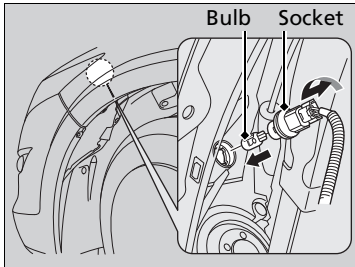
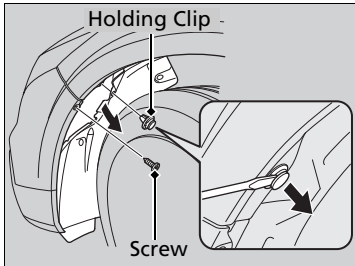

1. Turn the steering wheel all the way to the opposite side from the light being replaced.  
**Passenger side:** Turn the steering wheel to the left.  
**Driver side:** Turn the steering wheel to the right.
2. Remove the holding clips and screw, and pull the inner fender back.
3. Turn the socket to the left and remove it, then remove the old bulb.
4. Insert a new bulb.

### Front Side Marker Light Bulb

Remove the clip by using a flat-tip screwdriver.

➤ **Low Beam Headlights** P. 485

## Front Turn Signal/Parking Light Bulbs

When replacing, use the following bulbs.

### Front Turn Signal/Parking: 24/2.2CP

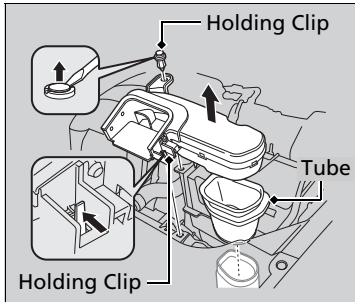

#### Driver side

#### 6-cylinder models

1. Unlock the holding clips, then remove the upper part of the air intake duct and the air intake tube.

#### Passenger side

#### All models

1. Remove the engine coolant reservoir.

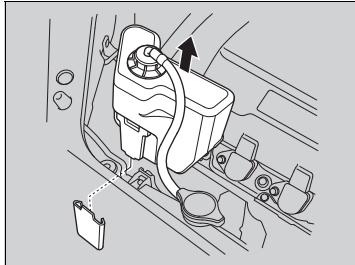

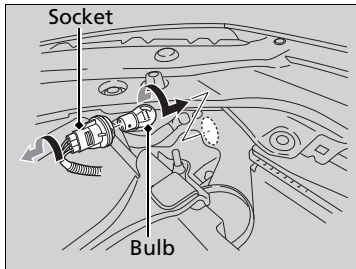

2. Turn the socket to the left and remove it.
3. Push in the old bulb, rotate to the left until it unlocks, and remove.
4. Insert new bulb.

## Brake/Taillights, Back-Up Light, Rear Turn Signal Light and Rear Side Marker Light Bulbs

When replacing, use the following bulbs.

**Brake/Taillight: 21/5 W**  
**Back-Up Light: 21 W**  
**Rear Turn Signal Light: 21 W (Amber)**  
**Rear Side Marker Light: 3 CP**

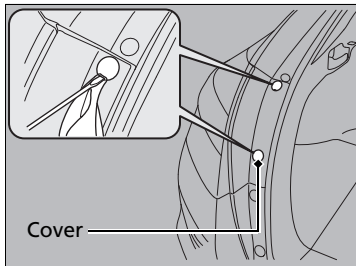

1. Pry on the edge of the cover using a flat-tip screwdriver to remove the covers.
  - Wrap the flat-tip screwdriver with a cloth to prevent scratches.

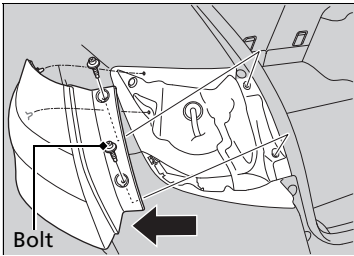

2. Use a Phillip-head screwdriver to remove the bolts.
3. Pull the light assembly out of the rear pillar.

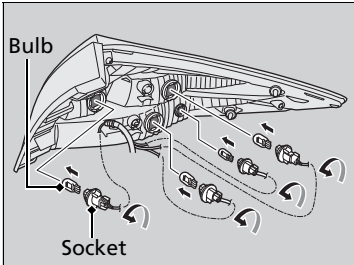

4. Turn the socket to the left and remove it. Remove the old bulb.
5. Insert a new bulb.

## Rear License Plate Light Bulb

When replacing, use the following bulb.

**Rear License Plate Light: 5 W**

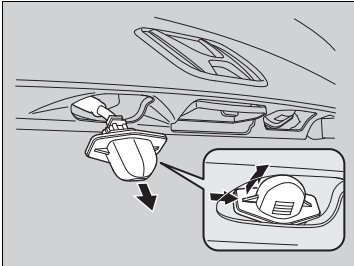

1. Push the left edge of the lens to the right and pull out the licence light assembly.

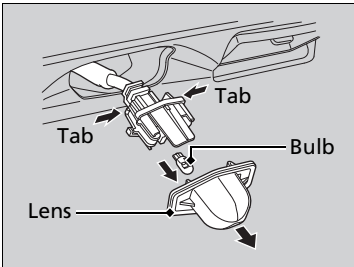

2. Push the tabs to remove the lens.
3. Remove the old bulb.
4. Insert a new bulb.

## High-Mount Brake Light Bulb

High-mount brake light bulbs are LED type. Have an authorized Honda dealer inspect and replace the light bulbs.

## Checking Wiper Blades

If the wiper blade rubber has deteriorated, it will leave streaks and the metal wiper arm may scratch the window glass.

## Changing the Front Wiper Blade Rubber

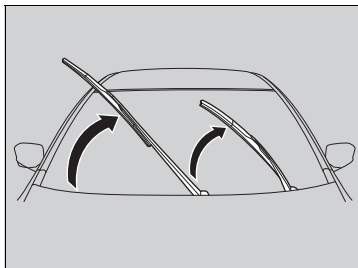

1. Lift the driver side wiper arm first, then the passenger side.

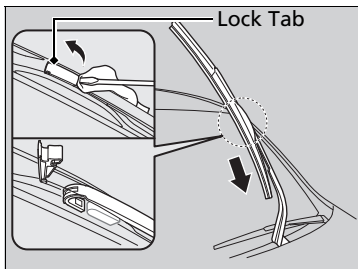

2. Pry on the edge of the lock tab using a flat-tip screwdriver to push it up.
  - ▶ Wrap the flat-tip screwdriver with a cloth to prevent scratches.
3. Slide the blade from the wiper arm.

### ✘ Changing the Front Wiper Blade Rubber

#### NOTICE

Avoid dropping the wiper arm; it may damage the windshield.

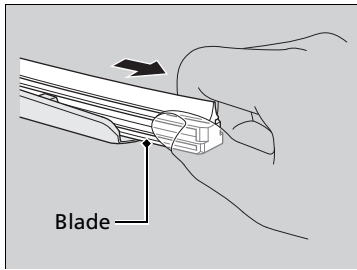

4. Slide the wiper blade out from its holder by pulling the tabbed end out.

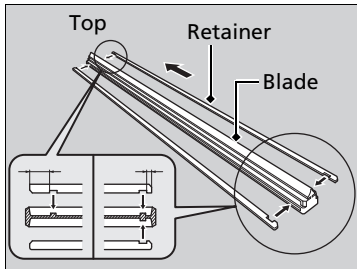

5. Remove the retainers from the rubber blade that has been removed, and mount to a new rubber blade.
  - ▶ Correctly align the rubber protrusion and the retainer grooves.

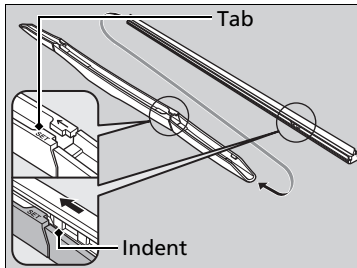

6. Slide the new wiper blade onto the holder from the bottom end.
  - ▶ The tab on the holder should fit in the indent of the wiper blade.
7. Slide the wiper blade onto the wiper arm, then push down the lock tab.
8. Lower the passenger side wiper arm first, then the driver side.



## Changing the Rear Wiper Blade Rubber

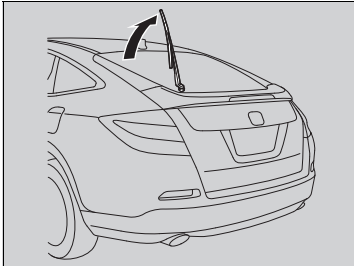

1. Raise the wiper arm off.

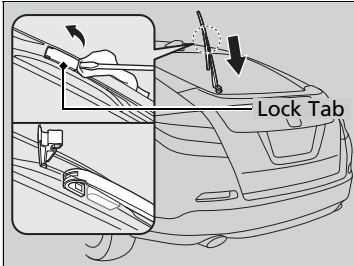

2. Pry on the edge of the lock tab using a flat-tip screwdriver to push it up.

▶ Wrap the flat-tip screwdriver with a cloth to prevent scratches.

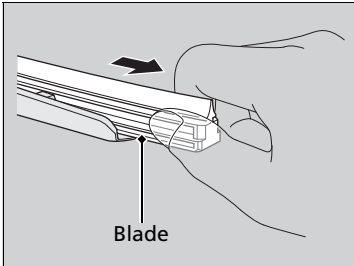

3. Slide the wiper blade out from the end with the indent.

### Changing the Rear Wiper Blade Rubber

#### NOTICE

Avoid dropping the wiper arm; it may damage the rear window.

Continued

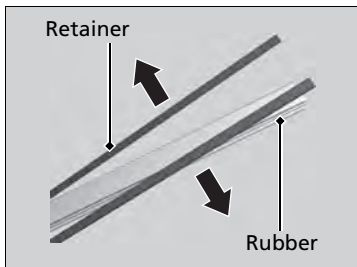

4. Remove the retainers from wiper blade and mount to a new rubber blade.

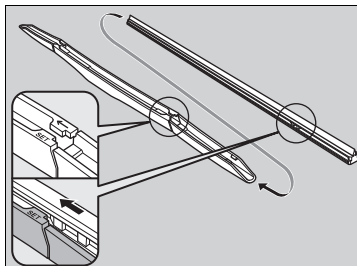

5. Slide the wiper blade onto the holder.

- ▶ Make sure it is engaged correctly, then install the wiper blade assembly onto the wiper arm.

## Checking Tires

To safely operate your vehicle, your tires must be of the proper type and size, in good condition with adequate tread, and properly inflated.

### ■ Inflation guidelines

Properly inflated tires provide the best combination of handling, tread life, and comfort. Refer to the driver's doorjamb label or specification's page for the specified pressure.

Underinflated tires wear unevenly, adversely affect handling and fuel economy, and are more likely to fail from overheating.

Overinflated tires make your vehicle ride harshly, are more prone to road hazards, and wear unevenly.

Every day before you drive, look at each of the tires. If one looks lower than the others, check the pressure with a tire gauge.

At least once a month or before long trips, use a gauge to measure the pressure in all tires, including the spare. Even tires in good condition can lose 1 to 2 psi (10 to 20 kPa, 0.1 to 0.2 kgf/cm<sup>2</sup>) per month.

### ■ Inspection guidelines

Every time you check inflation, also examine the tires and valve stems. Look for:

- Bumps or bulges on the side or in the tread. Replace the tire if you find any cuts, splits, or cracks in the side of the tire. Replace it if you see fabric or cord.
- Remove any foreign objects and inspect for air leaks.
- Uneven tread wear. Have a dealer check the wheel alignment.
- Excessive tread wear.

➤ **Wear Indicators** P. 502

- Cracks or other damage around valve stem.

### ☒ Checking Tires

## ⚠ WARNING

Using tires that are excessively worn or improperly inflated can cause a crash in which you can be seriously hurt or killed.

Follow all instructions in this owner's manual regarding tire inflation and maintenance.

Measure the air pressure when tires are cold. This means the vehicle has been parked for at least three hours, or driven less than 1 mile (1.6 km). If necessary, add or release air until the specified pressure is reached.

If checked when hot, tire pressure can be as much as 4–6 psi (30–40 kPa, 0.3–0.4 kgf/cm<sup>2</sup>) higher than if checked when cold.

Have a dealer check the tires if you feel a consistent vibration while driving. New tires and any that have been removed and reinstalled should be properly balanced.

## Tire and Loading Information Label

The label attached to the driver's doorjamb provides necessary tire and loading information.

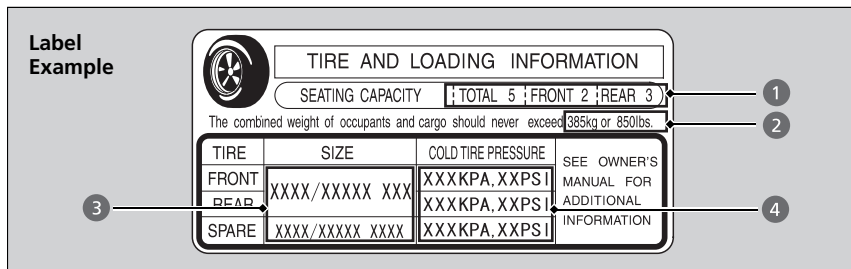

### ▶▶ Tire and Loading Information Label

The tire and loading information label attached to the driver's doorjamb contains:

- 1 The number of people your vehicle can carry.
- 2 The total weight your vehicle can carry. Do not exceed this weight.
- 3 The original tire sizes for front, rear, and spare.
- 4 The proper cold tire pressure for front, rear, and spare.

## Tire Labeling

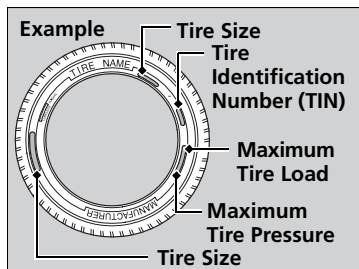

The tires that came on your vehicle have a number of markings. Those you should be aware of are described below.

### ▶▶ Tire Sizes

Following is an example of tire size with an explanation of what each component means.

#### **225/60 R18 100H**

225: Tire width in millimeters.

60: Aspect ratio (the tire's section height as a percentage of its width).

R: Tire construction code (R indicates radial).

18: Rim diameter in inches.

100: Load index (a numerical code associated with the maximum load the tire can carry).

H: Speed symbol (an alphabetical code indicating the maximum speed rating).

### Tire Sizes

Whenever tires are replaced, they should be replaced with tires of the same size.

## ■ Tire Identification Number (TIN)

The tire identification number (TIN) is a group of numbers and letters that look like the example in the side column. TIN is located on the sidewall of the tire.

## ■ Glossary of Tire Terminology

**Cold Tire Pressure** – The tire air pressure when the vehicle has been parked for at least three hours or driven less than 1 mile (1.6 km).

**Load Rating** – Means the maximum load that a tire is rated to carry for a given inflation pressure.

**Maximum Inflation Pressure** – The maximum tire air pressure that the tire can hold.

**Maximum Load Rating** – Means the load rating for a tire at the maximum permissible inflation pressure for that tire.

**Recommended Inflation Pressure** – The cold tire inflation pressure recommended by the manufacturer.

**Treadwear Indicators (TWI)** – Means the projections within the principal grooves designed to give a visual indication of the degrees of wear of the tread.

### ☒ Tire Identification Number (TIN)

#### **DOT B97R FW6X 2209**

DOT: This indicates that the tire meets all requirements of the U.S. Department of Transportation.

B97R: Manufacturer's identification mark.

FW6X: Tire type code.

22 09: Date of manufacture.

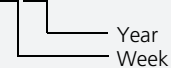

## DOT Tire Quality Grading (U.S. Vehicles)

The tires on your vehicle meet all U.S. Federal Safety Requirements. All tires are also graded for treadwear, traction, and temperature performance according to Department of Transportation (DOT) standards. The following explains these gradings.

### ■ Uniform Tire Quality Grading

Quality grades can be found where applicable on the tire sidewall between tread shoulder and maximum section width.

### ■ Treadwear

The treadwear grade is a comparative rating based on the wear rate of the tire when tested under controlled conditions on a specified government test course. For example, a tire graded 150 would wear one and one-half (1 1/2) times as well on the government course as a tire graded 100. The relative performance of tires depends upon the actual conditions of their use, however, and may depart significantly from the norm due to variations in driving habits, service practices and differences in road characteristics and climate.

### ▣ Uniform Tire Quality Grading

For example:  
**Treadwear 200**  
**Traction AA**  
**Temperature A**

All passenger car tires must conform to Federal Safety Requirements in addition to these grades.

## ■ Traction

The traction grades, from highest to lowest, are AA, A, B, and C. Those grades represent the tire's ability to stop on wet pavement as measured under controlled conditions on specified government test surfaces of asphalt and concrete. A tire marked C may have poor traction performance.

## ■ Temperature

The temperature grades are A (the highest), B, and C, representing the tire's resistance to the generation of heat and its ability to dissipate heat when tested under controlled conditions on a specified indoor laboratory test wheel. Sustained high temperature can cause the material of the tire to degenerate and reduce tire life, and excessive temperature can lead to sudden tire failure. The grade C corresponds to a level of performance which all passenger car tires must meet under the Federal Motor Vehicle Safety Standard No. 109. Grades B and A represent higher levels of performance on the laboratory test wheel than the minimum required by law.

### ⌘ Traction

Warning: The traction grade assigned to this tire is based on straight-ahead braking traction tests, and does not include acceleration, cornering, hydroplaning, or peak traction characteristics.

### ⌘ Temperature

Warning: The temperature grade for this tire is established for a tire that is properly inflated and not overloaded. Excessive speed, underinflation, or excessive loading, either separately or in combination, can cause heat buildup and possible tire failure.

## Wear Indicators

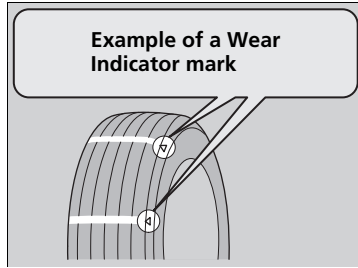

The groove where the wear indicator is located is 1/16 inch (1.6 mm) shallower than elsewhere on the tire. If the tread has worn so that the indicator is exposed, replace the tire.

**Worn out tires have poor traction on wet roads.**

## Tire Service Life

The life of your tires is dependent on many factors, including driving habits, road conditions, vehicle loading, inflation pressure, maintenance history, speed, and environmental conditions (even when the tires are not in use).

In addition to regular inspections and inflation pressure maintenance, it is recommended that you have annual inspections performed once the tires reach five years old. All tires, including the spare, should be removed from service after 10 years from the date of manufacture, regardless of their condition or state of wear.



## Tire and Wheel Replacement

Replace your tires with radials of the same size, load range, speed rating, and maximum cold tire pressure rating (as shown on the tire's sidewall). Using tires of a different size or construction can cause the ABS and VSA® (vehicle stability assist) system to work incorrectly.

It is best to replace all four tires at the same time. If that isn't possible, replace the front or rear tires in pairs.

Make sure that the wheel's specifications match those of the original wheels.

If you replace a wheel, only use TPMS specified wheels approved for your vehicle.

### ⚠ Tire and Wheel Replacement

#### **⚠ WARNING**

Installing improper tires on your vehicle can affect handling and stability. This can cause a crash in which you can be seriously hurt or killed.

Always use the size and type of tires recommended in this owner's manual.

## Tire Rotation

Rotating tires according to the maintenance messages on the information display/ multi-information display helps to distribute wear more evenly and increase tire life.

### ■ Tires without rotation marks

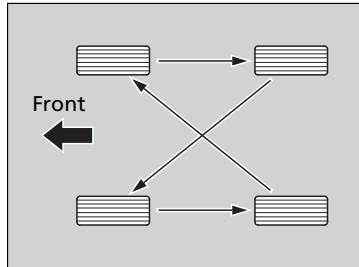

Rotate the tires as shown here.

### ■ Tires with rotation marks

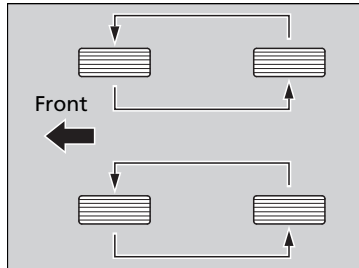

Rotate the tires as shown here.

### ►► Tire Rotation

Tires with directional tread patterns should only be rotated front to back (not from one side to the other). Directional tires should be mounted with the rotation indication mark facing forward, as shown below.

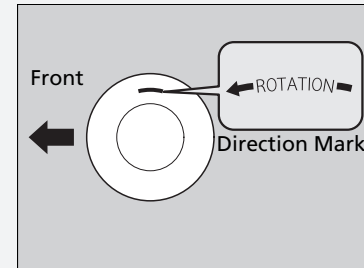

## Winter Tires

If driving on snowy or frozen roads, mount all season marked **M+S** tires, snow tires, or tire chains; reduce speed; and maintain sufficient distance between vehicles when driving.

Be particularly careful when operating the steering wheel or brakes to prevent skidding.

Use tire chains, snow tires, or all season tires when necessary or according to the law.

When mounting, refer to the following points.

For winter tires:

- Select the size and load ranges that are the same as the original tires.
- Mount the tires to all four wheels.

For tire chains:

- Install them on the front tires only.
- Because your vehicle has limited tire clearance, we strongly recommend using the chains listed below:

### 4-cylinder models

**Cable-type: SCC Radial Chain SC1042**

### 6-cylinder models

**Cable-type: SCC Radial Chain TC2111 MM**

- Follow the chain manufacturer's instruction when installing. Mount them as tightly as you can.
- Check that the chains do not touch the brake lines or suspension.
- Drive slowly.

### Winter Tires

## ⚠ WARNING

Using the wrong chains, or not properly installing chains, can damage the brake lines and cause a crash in which you can be seriously injured or killed.

Follow all instructions in this owner's manual regarding the selection and use of tire chains.

### NOTICE

Traction devices that are the wrong size or improperly installed can damage your vehicle's brake lines, suspension, body, and wheels. Stop driving if they are hitting any part of the vehicle.

When tire chains are mounted, follow the chain manufacturer's instructions regarding vehicle operational limits.

If your vehicle is equipped with summer tires, be aware that these tires are not designed for winter driving conditions. For more information, contact a dealer.

## Checking the Battery

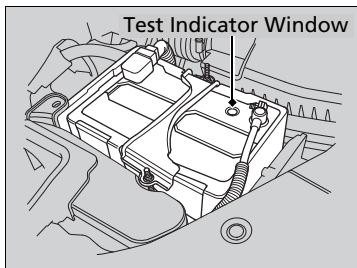

Check the battery condition monthly. Look at the test indicator window and check the terminals for corrosion.

If your vehicle's battery is disconnected or goes dead:

- The audio system is disabled.
  - **Reactivating the audio system** P. 166
- The clock resets.
  - **Setting the Clock** P. 88
- The navigation system\* is disabled.
  - **Refer to the navigation system manual**

## Charging the Battery

Disconnect both battery cables to prevent damaging your vehicle's electrical system. Always disconnect the negative (-) cable first, and reconnect it last.

### ⓘ Battery

## ⚠ WARNING

The battery gives off explosive hydrogen gas during normal operation.

A spark or flame can cause the battery to explode with enough force to kill or seriously hurt you.

When conducting any battery maintenance, wear protective clothing and a face shield, or have a skilled technician do it.

**WARNING:** Battery post, terminals, and related accessories contain lead and lead compounds.  
**Wash your hands after handling.**

The test indicator's color information is on the battery.

When you find corrosion, clean the battery terminals by applying a baking powder and water solution. Clean the terminals with a damp towel. Cloth/towel dry the battery. Coat the terminals with grease to help prevent future corrosion.

## Replacing the Button Battery

If the indicator does not come on when the button is pressed, replace the battery.

### Master Keys with Remote Transmitter\*

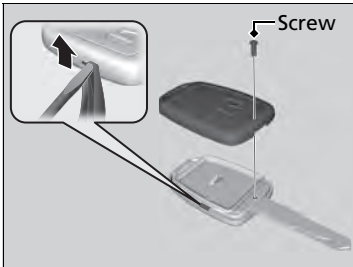

#### Battery type: CR1620

1. Unscrew the cover with a small Phillips-head screwdriver.
2. Open the remote transmitter.
  - ▶ Wrap the small flat-tip screwdriver with a cloth to prevent scratching the transmitter.
3. Remove the button battery with the small flat-tip screwdriver.
4. Make sure to replace the battery with the correct polarity.

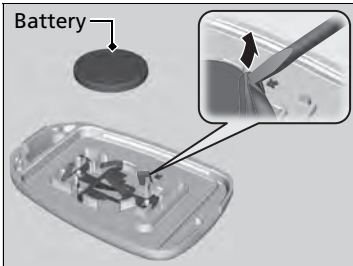

### Replacing the Button Battery

#### NOTICE

An improperly disposed of battery can damage the environment. Always confirm local regulations for battery disposal.

Replacement batteries are commercially available or at a dealer.

\* Not available on all models

## ■ Smart Entry Remote \*



**Battery type: CR2032**

1. Remove the built-in key.
2. Remove the upper half by carefully prying on the edge with a coin.
  - ▶ Remove carefully to avoid losing the buttons.
  - ▶ Wrap a coin with a cloth to prevent scratching the smart entry remote.
3. Make sure to replace the battery with the correct polarity.

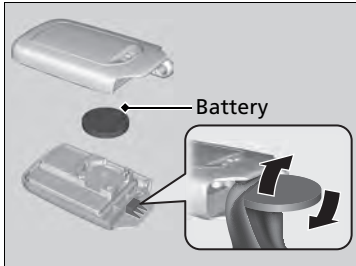

## Dust and Pollen Filter

The heating and cooling system\*/climate control system\* is equipped with a dust and pollen filter that collects pollen, dust, and other debris in the air. The Maintenance Minder™ messages will let you know when to replace the filter.

We recommend that you replace the dust and pollen filter sooner when using your vehicle in areas with high concentrations of dust.

### ☒ Dust and Pollen Filter

If the airflow from the heating and cooling system\*/climate control system\* deteriorates noticeably, and the windows fog up easily, the filter may need to be replaced. Please contact a dealer for replacement.

\* Not available on all models

## Interior Care

Use a damp cloth with a mixture of mild detergent and warm water to remove dirt. Use a clean cloth to remove detergent residue.

### Cleaning Seat Belts

Use a soft brush with a mixture of mild soap and warm water to clean the seat belts. Let the belts air dry. Wipe the openings of the seat belt anchors using a clean cloth.

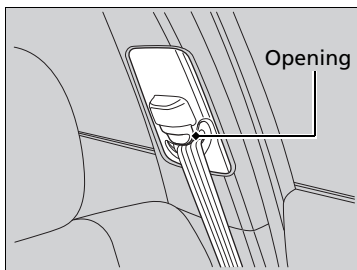

### Interior Care

Do not spill liquids inside the vehicle. Electrical devices and systems may malfunction if liquids are splashed on them.

Do not use silicone based sprays on electrical devices such as audio devices and switches. Doing so may cause the items to malfunction or a fire inside the vehicle.

If a silicone based spray is inadvertently used on electrical devices, consult a dealer.

Depending on their composition, chemicals and liquid aromatics may cause discoloration, wrinkles, and cracking to resin-based parts and textiles. Do not use alkali solvents or organic solvents such as benzene or gasoline.

After using chemicals, make sure to gently wipe them off using a dry cloth.

Do not place used cloths on top of resin based parts or textiles for long periods of time without washing.



## ■ Floor Mats

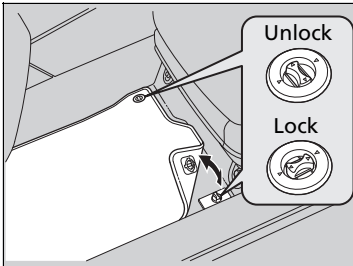

The driver's floor mat hooks over the floor anchors, which keep the mat from sliding forward. To remove a mat for cleaning, turn the anchor knobs to the unlock position. When reinstalling the mat after cleaning, turn the knobs to the lock position.

**Do not put additional floor mats on top of the anchored mat.**

## ■ Maintaining Genuine Leather\*

Vacuum dirt and dust from the leather frequently. Pay close attention to the pleats and seams. Clean the leather with a soft cloth dampened with a 90% water and 10% neutral soap solution. Then buff it with a clean, dry cloth. Remove any dust or dirt on leather surfaces immediately.

## ▣ Floor Mats

If you use any floor mats that were not originally provided with your vehicle, make sure they are designed for your specific vehicle, fit correctly, and are securely anchored by the floor anchors. Position the rear seat floor mats properly. If they are not properly positioned, the floor mats can interfere with the front seat functions.

\* Not available on all models

## Exterior Care

Dust off the vehicle body after you drive.

Regularly inspect your vehicle for scratches on painted surfaces. A scratch on a painted surface can result in body rust. If you find a scratch, promptly repair it.

### ■ Washing the Vehicle

Wash the vehicle regularly. Wash more frequently when driving in the following conditions:

- If driving on roads with road salt.
- If driving in coastal areas.
- If tar, soot, bird droppings, insects, or tree sap are stuck to painted surfaces.

### ■ Using an Automated Car Wash

Fold in the door mirrors. Make sure to follow the instructions indicated on the automated car wash.

### ■ Using High Pressure Cleaners

- Keep sufficient distance between the cleaning nozzle and the vehicle body.
- Take particular care around the windows. Standing too close may cause water to enter the vehicle interior. Do not spray water into the engine compartment.

### ⌘ Washing the Vehicle

Do not spray water into the air intake vents or engine compartment. It can cause a malfunction.

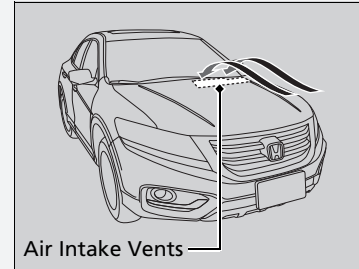

## ■ Applying Wax

A good coat of automotive body wax helps protect your vehicle's paint from the elements. Wax will wear off over time and expose your vehicle's paint to the elements, so reapply as necessary.

## ■ Maintaining the Bumpers and Other Resin Coated Parts

If you get gasoline, oil, engine coolant, or battery fluid on resin coated parts, they may be stained or the coating may peel. Promptly wipe it away using a soft cloth and clean water.

## ■ Cleaning the Window

Wipe using a glass cleaner.

## ■ Maintaining Aluminum Wheels

Aluminum is susceptible to deterioration caused by salt and other road contaminants. Use a sponge and mild detergent to wipe away promptly. Be careful not to use harsh chemicals (including some commercial wheel cleaners) or a stiff brush. They can damage the clear coat of the aluminum alloy wheels that helps keep the aluminum from corroding and tarnishing.

### ☒ Applying Wax

#### NOTICE

Chemical solvents and strong cleaners can damage the paint, metal, and plastic on your vehicle. Wipe up spills immediately.

### ☒ Maintaining the Bumpers and Other Resin Coated Parts

Ask a dealer about the correct coating material when you want to repair the painted surface of the parts made of resin.

### ☒ Cleaning the Window

Wires are mounted to the inside of the rear window. Wipe along the same direction as the wires with a soft cloth so as not to damage them.



# Handling the Unexpected

This chapter explains how to handle unexpected troubles.



## **Tools**

Types of Tools..... 516

## **If a Tire Goes Flat**

Changing a Flat Tire..... 517

## **Engine Does Not Start**

Checking the Engine..... 525

If the Smart Entry Remote Battery is

Weak..... 526

Emergency Engine Stop ..... 527

**Jump Starting**..... 528

**Shift Lever Does Not Move**..... 531

## **Overheating**

How to Handle Overheating..... 532

## **Indicator, Coming On/Blinking**

If the Low Oil Pressure Indicator Comes

On..... 534

If the Charging System Indicator Comes

On..... 534

If the Malfunction Indicator Lamp Comes

On or Blinks ..... 535

If the Brake System Indicator (Red) Comes

On..... 536

If the EPS System Indicator Comes On... 536

If the Low Tire Pressure Indicator Comes

On ..... 537

If the TPMS Indicator Comes On ..... 537

## **Fuses**

Fuse Locations ..... 538

Inspecting and Changing Fuses..... 541

**Emergency Towing**..... 542

**When You Cannot Unlock the Fuel Fill**

**Door**..... 543

**When You Cannot Open the Tailgate** .. 544

## Types of Tools

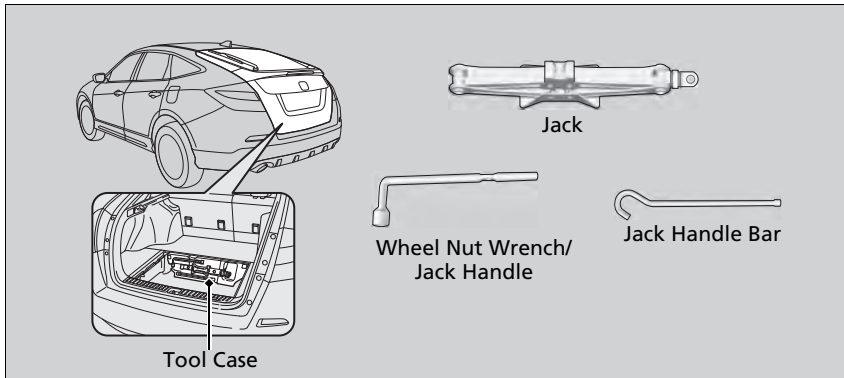

### Types of Tools

The tools were stored in the cargo area.

## Changing a Flat Tire

If a tire goes flat while driving, grasp the steering wheel firmly, and brake gradually to reduce speed. Then, stop in a safe place. Replace the flat tire with a compact spare tire. Go to a dealer as soon as possible to have the full-size tire repaired or replaced.

1. Park the vehicle on firm, level, and non-slippery surface and apply the parking brake.
2. Move the shift lever to **P**.
3. Turn on the hazard warning lights and turn the ignition switch to LOCK **0**\*1.

\*1: Models with the smart entry system have an **ENGINE START/STOP** button instead of an ignition switch.

### Changing a Flat Tire

Periodically check the tire pressure of the compact spare. It should be set to the specified pressure.  
Specified Pressure: 60 psi (420 kPa, 4.2 kgf/cm<sup>2</sup>)

When driving with the compact spare tire, keep the vehicle speed under 50 mph (80 km/h). Replace with a full-size tire as soon as possible.

The compact spare tire and wheel in your vehicle are specifically for this model.

Do not use them with another vehicle.

Do not use another type of compact spare tire or wheel with your vehicle.

Do not mount tire chains on a compact spare tire.

If a chain-mounted front tire goes flat, remove one of the full-size rear tires and replace it with the compact spare tire. Remove the flat front tire and replace it with the full-size tire that was removed from the rear. Mount the tire chains on the front tire.

Do not use a puncture-repairing agent on a flat tire, as it can damage the tire pressure sensor.

## ■ Getting Ready to Replace the Flat Tire

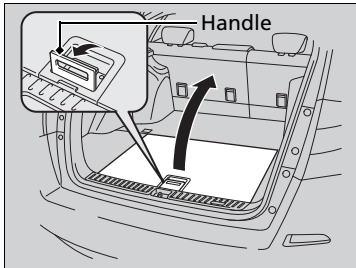

1. Push the rear edge of the handle on the front cargo floor lid and open the lid.

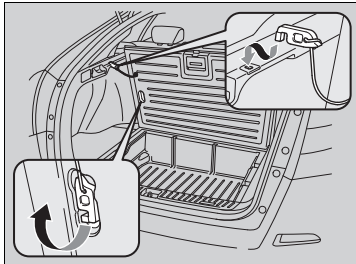

2. Remove the hook from the back of the cargo floor lid.  
Pull the hook to the hole on the side panel.

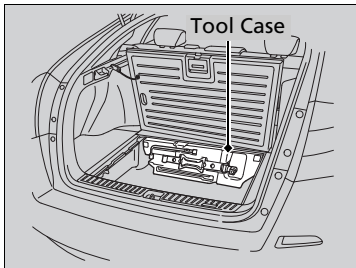

3. Take out the removable box.  
▶ **Under-floor Storage Area** P. 150
4. Take the jack, extension bar, and wheel nut wrench out of the tool case.

## ▶▶ Changing a Flat Tire

### NOTICE

Do not use the jack if it doesn't work properly. Call your dealer or a professional towing service.



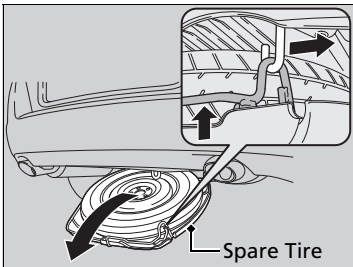
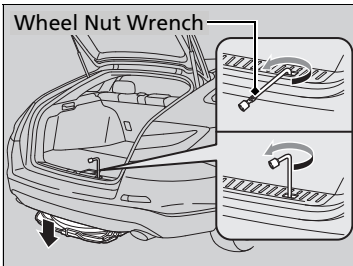
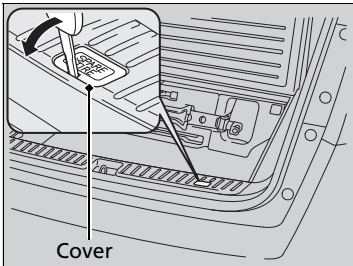

5. Remove the cover on the cargo area lining to access the shaft for the spare tire hoist.

6. Attach the short end of the wheel nut wrench to the spare tire holder shaft. Turn the wrench to the left to loosen the shaft.

7. Attach the longer section of the wrench to the shaft, and turn it until you can see the spare tire.

► Do not turn the wrench any further once you feel resistance.

8. Lift up the spare tire holder, then slide the hook to lift down the holder.

9. Remove the spare tire from the holder.

►► Changing a Flat Tire

**NOTICE**

The wheel nut wrench supplied with your vehicle is specially adapted to fit the holder shaft. Do not use any other tool.

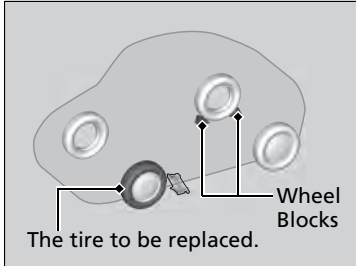

- 10.** Place a wheel block or rock in front and rear of the wheel diagonal to the flat tire.

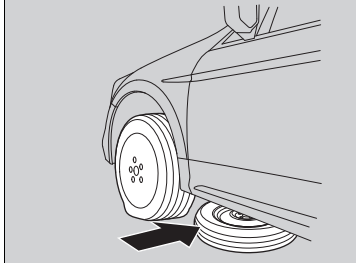

- 11.** Place the compact spare tire (wheel side up) under the vehicle body, near the tire that needs to be replaced.

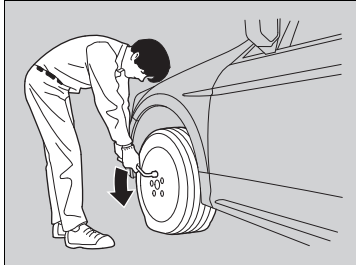

- 12.** Loosen each wheel nut about one turn using the wheel nut wrench.

## How to Set Up the Jack

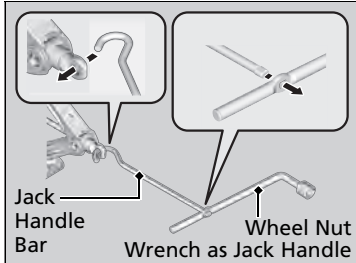
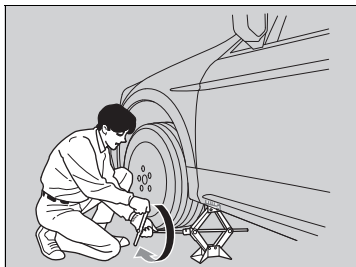
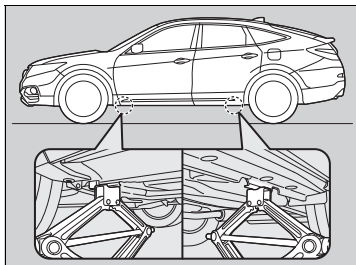

1. Place the jack under the jacking point closest to the tire to be changed.

2. Turn the end bracket (as shown in the image) clockwise until the top of the jack contacts the jacking point.  
▶ Make sure that the jacking point tab is resting in the jack notch.

3. Raise the vehicle, using the jack handle bar and the jack handle, until the tire is off the ground.

### How to Set Up the Jack

## ⚠ WARNING

The vehicle can easily roll off the jack, seriously injuring anyone underneath.

Follow the directions for changing a tire exactly, and never get under the vehicle when it is supported only by the jack.

Do not use the jack with people or luggage in the vehicle.

Use the jack provided in your vehicle. Other jacks may not support the weight ("load") or their shape may not match.

The following instructions must be followed to use the jack safely.

- Do not use while the engine is running.
- Use only where the ground is firm and level.
- Use only at the jacking points.
- Do not get in the vehicle while using the jack.
- Do not put anything on top of or underneath the jack.

## ■ Replacing the Flat Tire

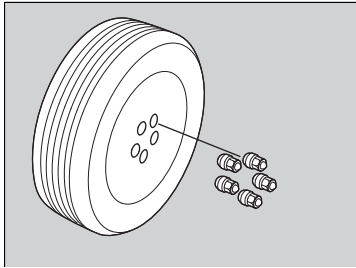

1. Remove the wheel nuts and flat tire.

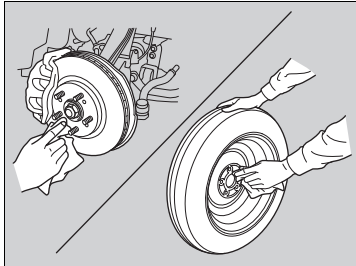

2. Wipe the mounting surfaces of the wheel with a clean cloth.
3. Mount the compact spare tire.
4. Screw the wheel nuts until they touch the lips around the mounting holes, and stop rotating.

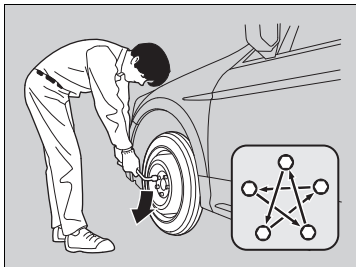

5. Lower the vehicle and remove the jack. Tighten the wheel nuts in the order indicated in the image. Go around, tightening the nuts, two to three times in this order.

**Wheel nut torque:**

80 lbf·ft (108 N·m, 11 kgf·m)

## ▣ Replacing the Flat Tire

Do not over tighten the wheel nuts by applying extra torque using your foot or a pipe.

## Storing the Flat Tire

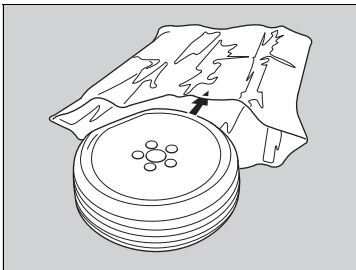

1. Put the Flat tire in the storage bag provided with your vehicle.  
▶ The storage bag is in the tool case.
2. Knot the top of the storage bag.
3. Securely put the jack and wheel nut wrench back in the tool case.

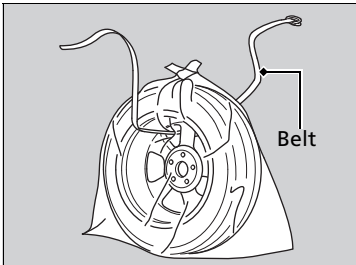

4. Bore through the bag, and pass the holding belt through the hole of the bag and the wheel of the flat tire as shown.

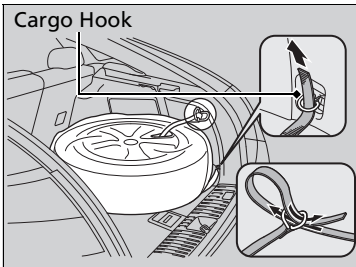

5. Place the flat tire in the cargo area, and thread the belt through the cargo hook as shown.
6. Pass the belt through the ring, and tighten the belt to secure the flat tire in place.

## Storing the Flat Tire

### **⚠ WARNING**

Loose items can fly around the interior in a crash and can seriously injure the occupants.

Store the wheel, jack, and tools securely before driving.

Always raise the spare tire holder, even if you are not stowing a tire. If the holder is left down, it will be damaged during driving and need to be replaced.

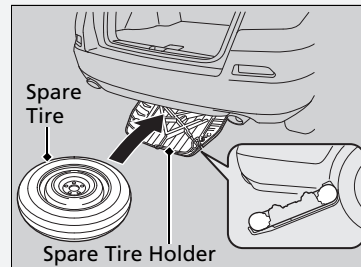

To reinstall the spare tire, place it facing up on the spare tire holder.

### **NOTICE**

If you store the spare tire face down, it can be damaged and needs to be replaced.

### ■ TPMS and the Spare Tire

If you replace a flat tire with the spare tire, the low tire pressure indicator comes on while you are driving. After driving for a few miles (kilometers), the indicator will go off and the **TPMS** indicator comes on, but this is normal.

If you replace the tire with a specified regular tire, the low tire pressure or **TPMS** indicator will go off after a few miles (kilometers).

### ▣ TPMS and the Spare Tire

The system cannot monitor the pressure of the spare tire. Manually check the spare tire pressure to be sure that it is correct.

Use TPMS specific wheels. Each is equipped with a tire pressure sensor mounted inside the tire behind the valve stem.

## Checking the Engine

If the engine does not start, turn the ignition switch to START \*1 and check the starter.

### Checking the Engine

If you must start the vehicle immediately, use an assisting vehicle to jump start it.

➤ **Jump Starting** P. 528

### Starter condition

### Checklist

#### Starter doesn't turn or turns over slowly.

The battery may be dead. Check each of the items on the right and respond accordingly.

#### Models with smart entry

Check for a message on the information display.

- If the **NO KEY** message appears
  - ▶ Make sure the smart entry remote is in its operating range.

➤ **ENGINE START/STOP Button Operating Range** P. 115

#### Check brightness of the interior light.

Turn on interior lights and check brightness.

- If the interior lights are dim or do not come on at all
  - **Battery** P. 506
- If the interior lights come on normally ➤ **Fuses** P. 538

#### The starter turns over normally but the engine doesn't start.

There may be a problem with the fuse. Check each of the items on the right and respond accordingly.

#### Review the engine start procedure.

Follow its instructions, and try to start the engine again. ➤ **Starting the Engine** P. 420, 422

#### Check the immobilizer system indicator.

When the immobilizer system indicator is blinking, the engine cannot be started.

➤ **Immobilizer System** P. 107

#### Check the fuel level.

There should be enough fuel in the tank. ➤ **Fuel Gauge** P. 83

#### Check the fuse.

Check all fuses, or have the vehicle checked by a dealer.

➤ **Inspecting and Changing Fuses** P. 541

#### If the problem continues:

➤ **Emergency Towing** P. 542

\*1: Models with the smart entry system have an **ENGINE START/STOP** button instead of an ignition switch.

Models with smart entry system

## If the Smart Entry Remote Battery is Weak

If the beeper sounds, the indicator on the **ENGINE START/STOP** button flashes, and the engine won't start. Start the engine as follows.

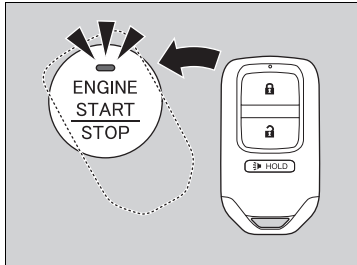

1. Touch the center of the **ENGINE START/STOP** button with the **H** logo on the smart entry remote while the indicator on the **ENGINE START/STOP** button is flashing. The buttons on the smart entry remote should be facing you.
  - ▶ The indicator flashes for about 30 seconds.

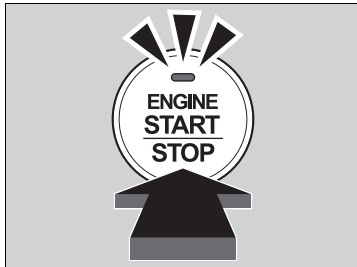

2. Depress the brake pedal and press the **ENGINE START/STOP** button within 10 seconds after the beeper sounds and the indicator stays on.
  - ▶ If you don't depress the pedal, the mode will change to ACCESSORY.



Models with smart entry system

## Emergency Engine Stop

If you cannot stop the engine by pressing the **ENGINE START/STOP** button, do either of the following operations:

- Press and hold the **ENGINE START/STOP** button for about two seconds.
- Firmly press the **ENGINE START/STOP** button two times.

The steering wheel will not lock.

The power mode changes to VEHICLE OFF with the shift lever in **P**, and to ACCESSORY with the shift lever in any position other than **P**.

### Emergency Engine Stop

Do not press the button while driving unless it is absolutely necessary for the engine to be switched off.

## Jump Starting Procedure

Turn off the power to electric devices, such as audio and lights. Turn off the engine, then open the hood.

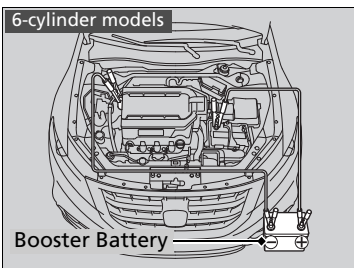
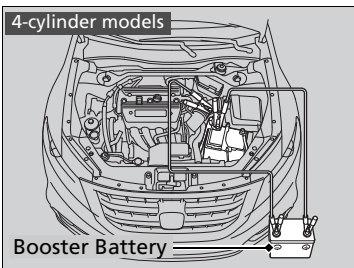

1. Connect the first jumper cable to your vehicle's battery  $\oplus$  terminal.
2. Connect the other end of the first jumper cable to the booster battery  $\oplus$  terminal.  
▶ Use a 12-volt booster battery only.
3. Connect the second jumper cable to the booster battery  $\ominus$  terminal.

## Jump Starting

### **WARNING**

A battery can explode if you do not follow the correct procedure, seriously injuring anyone nearby.

Keep all sparks, open flames, and smoking materials away from the battery.

Securely attach the jumper cables clips so that they do not come off when the engine vibrates. Also be careful not to tangle the jumper cables or allow the cable ends to touch each other while attaching or detaching the jumper cables.

4-cylinder models

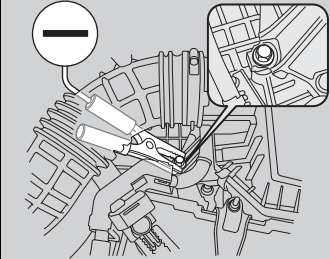

6-cylinder models

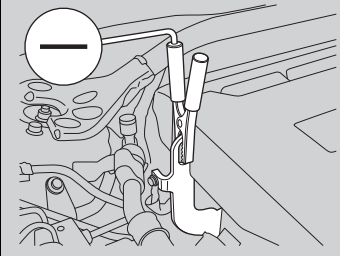

4. Connect the other end of the second jumper cable to the engine mounting bolt (4-cylinder models)/engine hanger (6-cylinder models) as shown. Do not connect this jumper cable to any other part.
5. If your vehicle is connected to another vehicle, start the assisting vehicle's engine and increase its rpm slightly.
6. Attempt to start your vehicle's engine. If it turns over slowly, check that the jumper cables have good metal-to-metal contact.

#### ⚠ Jump Starting

Battery performance degrades in cold conditions and may prevent the engine from starting.

*Continued*

## ■ What to Do After the Engine Starts

Once your vehicle's engine has started, remove the jumper cables in the following order.

1. Disconnect the jumper cable from your vehicle's ground.
2. Disconnect the other end of the jumper cable from the booster battery ⊖ terminal.
3. Disconnect the jumper cable from your vehicle's battery ⊕ terminal.
4. Disconnect the other end of the jumper cable from the booster battery ⊕ terminal.

Have your vehicle inspected by a nearby service station or a dealer.

# Shift Lever Does Not Move

Follow the procedure below if you cannot move the shift lever out of the **P** position.

## Releasing the Lock

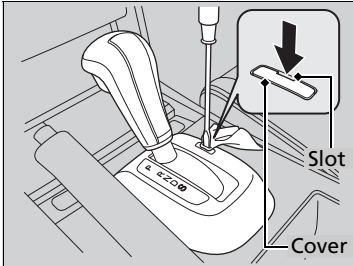

1. Set the parking brake.

### Models without smart entry system

2. Remove the key from the ignition switch.

### Models with smart entry system

2. Remove the built-in key from the smart entry remote.

### All models

3. Wrap a cloth around the tip of a small flat-tip screwdriver. Put it into the shift lock release slot as shown in the image, and remove the cover.
4. Insert the key into the shift lock release slot.
5. While pushing the key down, press the shift lever release button and place the shift lever into **N**.
  - ▶ The lock is now released. Have the shift lever checked by a dealer as soon as possible.

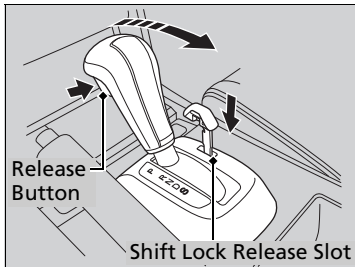

## How to Handle Overheating

Overheating symptoms are as follows:

- The temperature gauge needle is at the **H** mark or the engine suddenly loses power.
- Steam is coming out of the engine compartment.

### ■ First thing to do

1. Immediately park the vehicle in a safe place.
2. Turn off all accessories and turn on the hazard warning lights.
  - ▶ **No steam or spray present:** Keep the engine running and open the hood.
  - ▶ **Steam or spray is present:** Turn off the engine and wait until it subsides. Then open the hood.

### 🔗 How to Handle Overheating

## ⚠️ WARNING

Steam and spray from an overheated engine can seriously scald you.

Do not open the hood if steam is coming out.

### NOTICE

Continuing to drive with the temperature gauge needle at the **H** mark may damage the engine.

### ■ Next thing to do

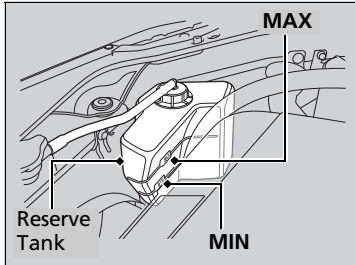

1. Check that the cooling fan is operating and stop the engine once the temperature gauge needle comes down.
  - ▶ If the cooling fan is not operating, immediately stop the engine.
2. Once the engine has cooled down, inspect the coolant level and check the coolant system components for leaks.
  - ▶ If the coolant level in the reserve tank is low, add coolant until it reaches the **MAX** mark.
  - ▶ If there is no coolant in the reserve tank, check that the radiator is cool. Cover the radiator cap with a heavy cloth and open the cap. If necessary, add coolant up to the base of the filler neck, and put the cap back on.

### ■ Last thing to do

Once the engine has cooled sufficiently, restart it and check the temperature gauge. If the temperature needle has gone down, resume driving. If it has not gone down, contact a dealer for repairs.

#### ▶▶ How to Handle Overheating

### ⚠ WARNING

Removing the radiator cap while the engine is hot can cause the coolant to spray out, seriously scalding you.

Always let the engine and radiator cool down before removing the radiator cap.

If the coolant is leaking, contact a dealer for repairs.

Use water as an emergency/temporary measure only. Have a dealer flush the system with proper antifreeze as soon as possible.

## If the Low Oil Pressure Indicator Comes On



### ■ Reasons for the indicator to come on

Comes on when the engine oil pressure is low.

### ■ What to do as soon as the indicator comes on

1. Immediately park the vehicle in a safe place.
2. If necessary, turn the hazard warning lights on.

### ■ What to do after parking the vehicle

1. Stop the engine and let it sit for about one minute.
2. Open the hood and check the oil level.
  - ▶ Add oil as necessary.
3. Start the engine and check the low oil pressure indicator.
  - ▶ The light goes out: Start driving again.
  - ▶ The light does not go out within 10 seconds: Stop the engine and contact a dealer for repairs immediately.

## If the Charging System Indicator Comes On



### ■ Reasons for the indicator to come on

Comes on when the battery is not being charged.

### ■ What to do when the indicator comes on

Turn off the heating and cooling system\*/climate control system\*, rear defogger, and other electrical systems, and immediately contact a dealer for repairs.

### ☒ If the Low Oil Pressure Indicator Comes On

#### NOTICE

Running the engine with low oil pressure can cause serious mechanical damage almost immediately.

### ☒ If the Charging System Indicator Comes On

If you need to stop temporarily, do not turn off the engine. Restarting the engine may rapidly discharge the battery.



## If the Malfunction Indicator Lamp Comes On or Blinks



### ■ Reasons for the indicator lamp to come on or blink

- Comes on when there is a problem with the engine emissions control system, or the fuel fill cap is missing, or loose.
- Blinks when engine misfiring is detected.

### ■ What to do when the indicator lamp comes on

Avoid high speeds and immediately get your vehicle inspected at a dealer.

### ■ What to do when the indicator lamp blinks

Park the vehicle in a safe place with no flammable items and wait at least ten minutes or more with the engine stopped until it cools.

## ■ Check Fuel Cap Message

### ■ The message appears on when:

An evaporative system leak is detected. This may be caused by the fuel fill cap being loose or not being installed.

### ■ What to do when the message appears:

1. Stop the engine.
2. Check that the fuel fill cap is fully installed.
  - ▶ If not, loosen the cap, and then retighten it until it clicks at least once.
3. Drive for several days of normal driving.
  - ▶ The message should go off.

### ■ When the malfunction indicator lamp comes on

Malfunction indicator lamp comes on if the system continues to detect a leak of gasoline vapor. If this happens, check the fuel fill cap using the procedures described above.

### ▶▶ If the Malfunction Indicator Lamp Comes On or Blinks

#### NOTICE

If you drive with the malfunction indicator lamp on, the emissions control system and the engine could be damaged.

If the malfunction indicator lamp blinks again when restarting the engine, drive to the nearest dealer at 31 mph (50 km/h) or less. Have your vehicle inspected.

## If the Brake System Indicator (Red) Comes On

U.S.



Canada



### ■ Reasons for the indicator to come on

- The brake fluid is low.
- There is a malfunction in the brake system.

### ■ What to do when the indicator comes on while driving

Press the brake pedal lightly to check pedal pressure.

- If normal, check the brake fluid level the next time you stop.
- If abnormal, take immediate action. If necessary, downshift the transmission to slow the vehicle using engine braking.

### ☒ If the Brake System Indicator (Red) Comes On

Have your vehicle repaired immediately.

It is dangerous to drive with low brake fluid. If there is no resistance from the brake pedal, stop immediately in a safe place. If necessary downshift the gears.

If the brake system indicator and **ABS** indicator come on simultaneously, the electronic brake distribution system is not working. This can result in vehicle instability under sudden braking.

Have your vehicle inspected by a dealer immediately.

## If the EPS System Indicator Comes On

6-cylinder models



### ■ Reasons for the indicator to come on

- Comes on when there is a problem with EPS system.
- If you depress the accelerator pedal repeatedly to increase the engine speed while the engine is idling, the indicator comes on, and sometimes the steering wheel becomes harder to operate.

### ■ What to do when the indicator comes on

Stop the vehicle in a safe place and restart the engine.

If the indicator comes on and stays on, immediately have your vehicle inspected by a dealer.

### ☒ If the EPS System Indicator Comes On

#### NOTICE

If you repeatedly turn the steering wheel at an extremely low speed, or hold the steering wheel on the full left or right position for a while, the system heats up. The system goes into a protective mode, and limits its performance. The steering wheel becomes harder and harder to operate. Once the system cools down, EPS is restored. Repeated operation under these conditions can eventually damage the system.

## If the Low Tire Pressure Indicator Comes On



### ■ Reasons for the indicator to come on

A tire pressure is significantly low. If the compact spare tire is installed, the indicator stays on for a while, and then goes off after driving a few miles (kilometers).

### ■ What to do when the indicator comes on

Stop your vehicle in a safe place. Check the tire pressure and adjust the pressure to the specified level. The specified tire pressure is on a label on the driver side doorjamb.

## If the TPMS Indicator Comes On



### ■ Reasons for the indicator to come on

- Comes on when there is a problem with the TPMS.
- If the compact spare is installed, the indicator comes on after driving for a few miles (kilometers).

### ■ What to do when the indicator comes on

Have the tire inspected by a dealer as soon as possible. If the compact spare tire causes the indicator to come on, change the tire to a full-size tire. The indicator goes off after driving a few miles (kilometers).

### ▶▶ If the Low Tire Pressure Indicator Comes On

#### NOTICE

Driving on an extremely underinflated tire can cause it to overheat. An overheated tire can fail. Always inflate your tires to the prescribed level.

## Fuse Locations

If any electrical devices are not working, turn the ignition switch to LOCK **0**\*<sup>1</sup> and check to see if any applicable fuse is blown.

### ■ Engine Compartment Fuse Box

Located near the brake fluid reservoir. Push the tabs to open the box.

Fuse locations are shown on the fuse box cover. Locate the fuse in question by the fuse number and box cover number.

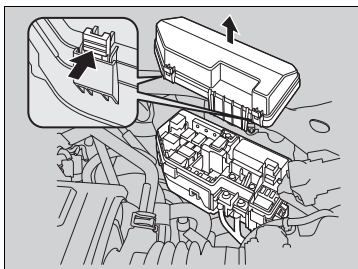

Handling the Unexpected

### ■ Circuit protected and fuse rating

	Circuit Protected	Amps
1	Battery	120 A* <sup>3</sup>
	Battery	100 A* <sup>2</sup>
	Passenger's Fuse Box	40 A
2	ESP MTR	70 A
	VSA SFR	40 A
	VSA Motor	30 A
	AS F/B OP	40 A
	Headlight washer*	30 A
	–	–
3	IG Main	50 A
	–	–
	Passenger Side Light Main	30 A
	DR F/B STD	60 A
	Driver Side Light Main	30 A
	Main Fan	30 A
	Wiper Motor	30 A
	Sub Fan	30 A
4	Fan Relay	7.5 A
5	Rear Defroster	40 A
6	Sub Fan Motor* <sup>2</sup>	20 A

	Circuit Protected	Amps
7	Hazard	15 A
8	Horn, STOP	20 A
9	–	–
10	Trailer	15 A
11	IG Coil	15 A
12	FI Sub	15 A
13	IGI Main 1* <sup>3</sup>	30 A
14	IGI Main 2* <sup>3</sup>	30 A
15	Back up	10 A
16	Interior Lights	7.5 A
17	FI Main	15 A
18	DBW	15 A
19	ACM* <sup>3</sup>	20 A
20	Heater Motor	40 A
21	MG Clutch	7.5 A

\*1: Models with the smart entry system have an **ENGINE START/STOP** button instead of an ignition switch.

\*2: 4-cylinder models

\*3: 6-cylinder models

## Interior Fuse Box

Locate the fuse in question by the fuse number and label number.

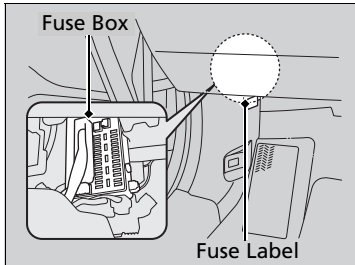

### Driver side

Located under the dashboard.

Fuse locations are shown on the label under the dashboard.

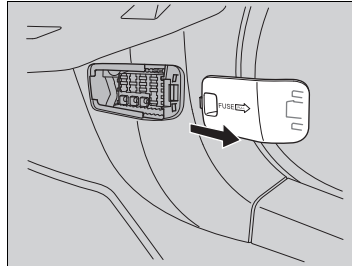

### Passenger side

Located on the lower side panel. Take off the cover to open.

Fuse locations are shown on the fuse box cover.

## Circuit protected and fuse rating

### Driver side

	Circuit Protected	Amps
1	–	–
2	Seat Memory*	7.5 A
3	Washer	15 A
4	Wiper	10 A
5	ODS	7.5 A
6	ABS/VSA	7.5 A
7	–	–
8	–	–
9	Fuel Pump	20 A
10	VB SOL 2	10 A
11	Meter	7.5 A
12	ACG	15 A
13	SRS	10 A
14	–	–
15	Daytime Running Lights	7.5 A
16	A/C	7.5 A

\* Not available on all models

	Circuit Protected	Amps
17	Accessory, Key, Lock	7.5 A
18	Accessory	7.5 A
19	Left Power Seat Sliding	20 A
20	Moonroof	20 A
21	Left Power Seat Reclining	20 A
22	Rear Left Power Window	20 A
23	Front Accessory Power Socket	15 A
24	Front Left Power Window	20 A
25	Left Door Lock	15 A
26	Front Left Fog Light	10 A
27	Left Small Lights (Exterior)	10 A
28	Left Headlight High Beam	10 A
29	TPMS	7.5 A
30	Left Headlight Low Beam	15 A
31	–	–
32 <sup>*3</sup>	ST MG DIODE <sup>*,*1</sup>	7.5 A
	Stop <sup>*,*2</sup>	7.5 A
33 <sup>*3</sup>	STRLD <sup>*</sup>	7.5 A

\*1:4-cylinder models

\*2:6-cylinder models

\*3:Sub fuse box

Passenger side

	Circuit Protected	Amps
1	Right Headlight High Beam	10 A
2	Right Small Lights (Exterior)	10 A
3	Front Right Fog Light	10 A
4	Right Headlight Low Beam	15 A
5	–	–
6	Interior Lights	7.5 A
7	–	–
8	Right Power Seat Reclining	20 A
9	Right Power Seat Sliding	20 A
10	Right Door Lock	10 A
11	Rear Right Power Window	20 A
12	SMART <sup>*</sup>	10 A
13	Front Right Power Window	20 A
14	–	–
15	Audio Amp	20 A
16	Accessory Power Socket (Cargo Area)	15 A
17	–	–
18	Power Lumbar <sup>*</sup>	7.5 A
19	Seat Heaters <sup>*</sup>	15 A
20	–	–
21	–	–
22	–	–

## Inspecting and Changing Fuses

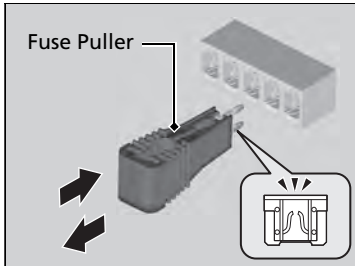
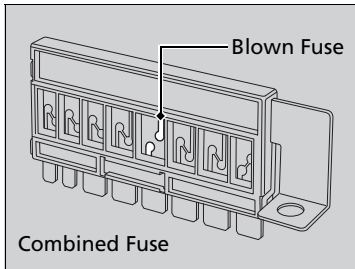

1. Turn the ignition switch to LOCK [0]\*1. Turn headlights and all accessories off.
2. Remove the fuse box cover.
3. Check the large fuse in the engine compartment.
  - If the fuse is blown, use a Phillips-head screwdriver to remove the screw and replace it with a new one.
4. Inspect the small fuses in the engine compartment and the vehicle interior.
  - If there is a burned out fuse, remove it with the fuse puller and replace it with a new one.

### Inspecting and Changing Fuses

#### NOTICE

Replacing a fuse with one that has a higher rating greatly increases the chances of damaging the electrical system.

Replace fuse with a spare fuse of the same specified amperage.

Confirm the specified amperage using the charts on P. 538 to 540.

There is a fuse puller on the back of the engine compartment fuse box cover.

\*1: Models with the smart entry system have an **ENGINE START/STOP** button instead of an ignition switch.

Call a professional towing service if you need to tow your vehicle.

## All models

### ■ Flat bed equipment

The operator loads your vehicle on the back of a truck.

**This is the best way to transport your vehicle.**

## 2WD models

### ■ Wheel lift equipment

The tow truck uses two pivoting arms that go under the front tires and lift them off the ground. The rear tires remain on the ground. **This is an acceptable way to tow your vehicle.**

## » Emergency Towing

### NOTICE

Trying to lift or tow your vehicle by the bumpers will cause serious damage. The bumpers are not designed to support the vehicle's weight.

### NOTICE

Improper towing such as towing behind a motorhome or other motor vehicle can damage the transmission.

Never tow your vehicle with just a rope or chain. It is very dangerous, since ropes or chains may shift from side to side or break.



# When You Cannot Unlock the Fuel Fill Door

## What to Do When Unable to Unlock the Fuel Fill Door

If you cannot unlock the fuel fill door, use the following procedure.

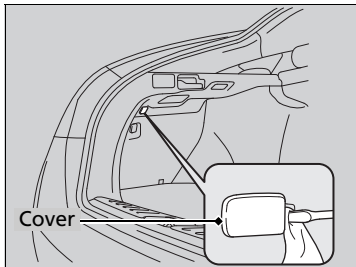

1. Open the tailgate.
2. Pry on the front edge of the cover using a flat-tip screwdriver to remove the cover.
  - ▶ Wrap the flat-tip screwdriver with a cloth to prevent scratches.

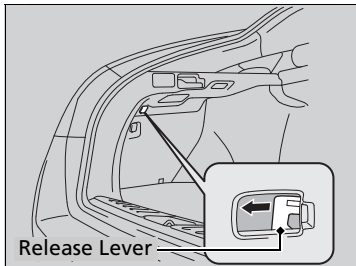

3. Pull the release lever towards you.
  - ▶ The release lever unlocks and opens the fuel fill door when it is pulled.

## What to Do When Unable to Unlock the Fuel Fill Door

After taking these steps, contact a dealer to have the vehicle checked.

## What to Do When Unable to Open the Tailgate

If you cannot open the tailgate, use the following procedure.

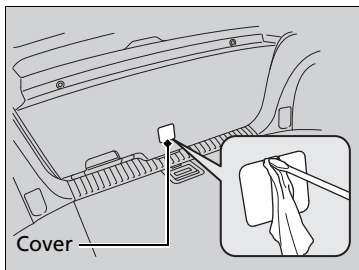

1. Use a flat-tip screwdriver and remove the cover on the inside of the tailgate.

► Wrap the flap-tip screwdriver with a cloth to prevent scratches.

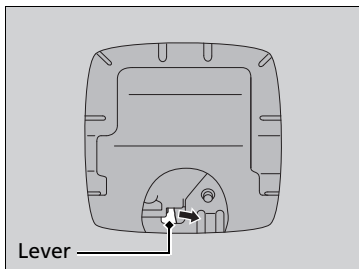

2. To open the tailgate, push the tailgate while sliding the lever to the side using a flat-tip screwdriver.

## What to Do When Unable to Open the Tailgate

What to do—Following up

After taking these steps, contact a dealer to have the vehicle checked.

When you open the tailgate from inside, make sure there is enough space around the tailgate, and it does not hit anyone or any object.

# Information

This chapter includes your vehicle's specifications, locations of identification numbers, and other information required by regulation.

<b>Specifications</b> .....	546
<b>Identification Numbers</b>	
Vehicle Identification Number (VIN) ...	550
Engine Number and Transmission Number.....	550
<b>Devices that Emit Radio Waves</b> .....	551
<b>Reporting Safety Defects</b> .....	552
<b>Emissions Testing</b>	
Testing of Readiness Codes.....	553
<b>Warranty Coverages</b> .....	555
<b>Authorized Manuals</b> .....	557
<b>Customer Service Information</b> .....	558

## 4-cylinder models

### ■ Vehicle Specifications

Model	Crosstour
No. of Passengers:	
Front	2
Rear	3
Total	5
Weights:	
Gross Vehicle Weight	U.S.: 4,784 lbs (2,170 kg)
Rating	Canada: 2,170 kg
Gross Axle Weight	
Rating (Front)	U.S.: 2,469 lbs (1,120 kg)
	Canada: 1,120 kg
Gross Axle Weight	
Rating (Rear)	U.S.: 2,381 lbs (1,080 kg)
	Canada: 1,080 kg
Air Conditioning:	
Refrigerant Type	HFC-134a (R-134a)
Charge Quantity	14.1 – 15.9 oz (400 – 450 g)
Lubricant Type	ND-OIL 8

### ■ Engine Specifications

Displacement	144 cu-in (2,354 cm <sup>3</sup> )
Spark Plugs	NGK ILZKR7B11S
	DENSO SXU22HCR11S

### ■ Fuel

Fuel:	Unleaded gasoline, Pump octane number of 87 or higher
Type	
Fuel Tank Capacity	18.5 US gal (70 ℓ)

### ■ Battery

Capacity/Type	38AH(5)/47AH(20)
	52AH(5)/65AH(20) <sup>*1</sup>

\*1: Canadian models

### ■ Washer Fluid

Tank Capacity	5.3 US qt (5.0 ℓ)
---------------	-------------------

### ■ Light Bulbs

Headlights (Low Beam)	55W (H11)
Headlights (High Beam)	60W (HB3)
Fog Lights	55W (H11)
Front Side Marker Lights	5W
Front Turn Signal/Parking Lights	24/2.2CP (Amber)
Brake/Taillights	21/5W
Rear Side Marker Lights	3CP
Back-Up Lights	21W
Rear Turn Signal Lights	21W (Amber)
High-Mount Brake Light	LED
Rear License Plate Lights	5W
Cargo Area Light	5W
Interior Lights	
Map Lights	8W
Ceiling Light	8W
Vanity Mirror Lights	1.4W
Glove Box Light	1.4W
Ambient Light	LED
Courtesy Lights	2CP

■ **Brake Fluid**

Specified	Honda Heavy Duty Brake Fluid DOT 3
-----------	------------------------------------

■ **Automatic Transmission Fluid**

Specified	Honda ATF DW-1 (automatic transmission fluid)
Capacity	Change 2.6 US qt (2.5 ℓ)

■ **Power Steering Fluid**

Specified	Honda Power Steering Fluid
-----------	----------------------------

■ **Engine Oil**

Recommended	-Genuine Honda Motor Oil 0W-20 -API Premium-grade 0W-20 detergent oil
Change	4.0 US qt (3.8 ℓ)
Capacity	Change including filter 4.2 US qt (4.0 ℓ)

■ **Engine Coolant**

Specified	Honda Long-Life Antifreeze/Coolant Type2
Ratio	50/50 with distilled water 1.66 US gal (6.3 ℓ)
Capacity	(change including the remaining 0.18 US gal (0.68 ℓ) in the reserve tank)

■ **Tire**

Regular	Size	225/65R17 102T
	Pressure psi (kPa [kgf/cm <sup>2</sup> ])	
	Front	32 (220 [2.2])
Compact Spare	Rear	32 (220 [2.2])
	Size	T155/90D16 110M
Wheel Size	Pressure psi (kPa [kgf/cm <sup>2</sup> ])	60 (420 [4.2])
	Regular	17 x 6 1/2J
	Compact Spare	16 x 4T

**6-cylinder models**

**Vehicle Specifications**

Model	Crosstour
No. of Passengers:	
Front	2
Rear	3
Total	5
<b>Weights:</b>	
Gross Vehicle Weight Rating	U.S.: 4,938 lbs (2,240 kg) <sup>*1</sup> 5,115 lbs (2,320 kg) <sup>*2</sup> Canada: 2,240 kg <sup>*1</sup> 2,320 kg <sup>*2</sup>
Gross Axle Weight Rating (Front)	U.S.: 2,623 lbs (1,190 kg) <sup>*1</sup> 2,668 lbs (1,210 kg) <sup>*2</sup> Canada: 1,190 kg <sup>*1</sup> 1,210 kg <sup>*2</sup>
Gross Axle Weight Rating (Rear)	U.S.: 2,381 lbs (1,080 kg) <sup>*1</sup> 2,513 lbs (1,140 kg) <sup>*2</sup> Canada: 1,080 kg <sup>*1</sup> 1,140 kg <sup>*2</sup>
<b>Air Conditioning:</b>	
Refrigerant Type	HFC-134a (R-134a)
Charge Quantity	14.1 – 15.9 oz (400 – 450 g)
Lubricant Type	ND-OIL 8

\*1: 2WD models  
\*2: 4WD models

**Engine Specifications**

Displacement	212 cu-in (3,471 cm <sup>3</sup> )	
Spark Plugs	NGK	ILZKR7B11
	DENSO	SXU22HCR11

**Fuel**

Fuel Type	Unleaded gasoline, Pump octane number of 87 or higher
Fuel Tank Capacity	18.5 US gal (70 ℓ)

**Battery**

Capacity/Type	60AH(5)/72AH(20)
---------------	------------------

**Washer Fluid**

Tank Capacity	5.3 US qt (5.0 ℓ)
---------------	-------------------

**Light Bulbs**

Headlights (Low Beam)	55W (H11)
Headlights (High Beam)	60W (HB3)
Fog Lights	55W (H11)
Front Side Marker Lights	5W
Front Turn Signal/Parking Lights	24/2.2CP (Amber)
Brake/Taillights	21/5W
Rear Side Marker Lights	3CP
Back-Up Lights	21W
Rear Turn Signal Lights	21W (Amber)
High-Mount Brake Light	LED
Rear License Plate Lights	5W
Cargo Area Light	5W
<b>Interior Lights</b>	
Map Lights	8W
Ceiling Light	8W
Vanity Mirror Lights	1.4W
Glove Box Light	1.4W
Ambient Light	LED
Courtesy Lights	2CP

■ Brake Fluid

Specified	Honda Heavy Duty Brake Fluid DOT 3
-----------	------------------------------------

■ Automatic Transmission Fluid

Specified	Honda ATF DW-1 (automatic transmission fluid)
Capacity	Change 3.28 US qt (3.1 ℓ)

■ Rear Differential Fluid

Specified	Honda Dual Pump Fluid II
Capacity	Change 1.3 US qt (1.2 ℓ)

■ Transfer Assembly Fluid

Specified	-SAE 90 Viscosity Hypoid Gear Oil -API Service Classified GL4 or GL5 only
Capacity	Change 0.43 US qt (0.41 ℓ)

■ Engine Oil

Recommended	-Genuine Honda Motor Oil 0W-20 -API Premium-grade 0W-20 detergent oil
Change	4.2 US qt (4.0 ℓ)
Capacity	Change including filter 4.5 US qt (4.3 ℓ)

■ Engine Coolant

Specified	Honda Long-Life Antifreeze/Coolant Type2
Ratio	50/50 with distilled water 1.92 US gal (7.3 ℓ)
Capacity	(change including the remaining 0.17 US gal (0.64 ℓ) in the reserve tank)

■ Tire

Regular	Size	225/60R18 100H
	Pressure psi (kPa [kgf/cm <sup>2</sup> ])	33 (230 [2.3])
	Front	
	Rear	33 (230 [2.3])
Compact Spare	Size	T155/90D16 110M <sup>*1</sup> T155/90D17 101M <sup>*2</sup>
	Pressure psi (kPa [kgf/cm <sup>2</sup> ])	60 (420 [4.2])
Wheel Size	Regular	18 x 7J
	Compact Spare	16 x 4T <sup>*1</sup>
		17 x 4T <sup>*2</sup>

\*1: 2WD models

\*2: 4WD models

## Vehicle Identification Number (VIN)

Your vehicle has a 17-digit vehicle identification number (VIN) used to register your vehicle for warranty purposes, and for licensing and insuring your vehicle. See the image below for the VIN locations.

## Engine Number and Transmission Number

See the image below for the locations of your vehicle's engine number and transmission number.

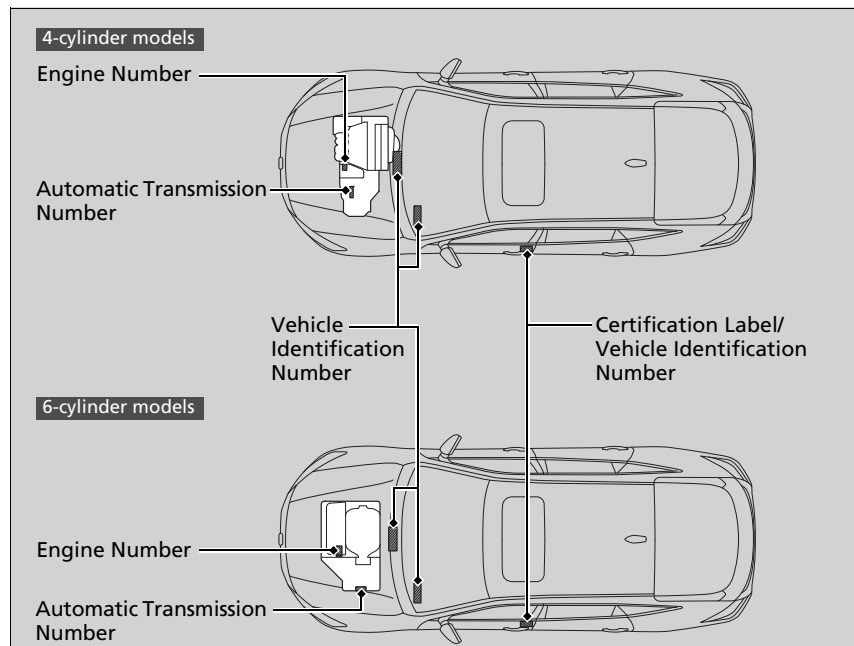

### Engine Number and Transmission Number

The transmission number is located on the side of the transmission.



## Devices that Emit Radio Waves

The following products and systems on your vehicle emit radio waves when in operation.

### Audio System

*Bluetooth*® Audio

*Bluetooth*® HandsFreeLink®

HomeLink® Universal Transceiver

### Immobilizer System

Smart Entry System

Remote Transmitter

Tire Pressure Monitoring System (TPMS)

Each of the above complies with the appropriate requirements or the required standards of FCC (Federal Communications Commission) and Industry Canada Standard, described below:

As required by the FCC:

This device complies with Part 15 of the FCC rules. Operation is subject to the following two conditions: (1) This device may not cause harmful interference, and (2) this device must accept any interference received, including interference that may cause undesired operation.

Changes or modifications not expressly approved by the party responsible for compliance could void the user's authority to operate the equipment.

This device complies with Industry Canada Standard RSS-Gen/210/310. Operation is subject to the following two conditions: (1) this device may not cause interference, and (2) this device must accept any interference, including interference that may cause undesired operation of the device.

In the U.S.

If you believe that your vehicle has a defect which could cause a crash or could cause injury or death, you should immediately inform the National Highway Traffic Safety Administration (NHTSA) in addition to notifying American Honda Motor Co., Inc.

If NHTSA receives similar complaints, it may open an investigation, and if it finds that a safety defect exists in a group of vehicles, it may order a recall and remedy campaign. However, NHTSA cannot become involved in individual problems between you, your dealer, or American Honda Motor Co., Inc.

To contact NHTSA, you may call the Vehicle Safety Hotline toll-free at 1-888-327-4236 (TTY: 1-800-424-9153); go to <http://www.safercar.gov>; or write to: Administrator, NHTSA, 1200 New Jersey Avenue, SE., Washington, DC 20590. You can also obtain other information about motor vehicle safety from <http://www.safercar.gov>.

In Canada

If you believe that your vehicle has a defect which could cause a crash or could cause injury or death, you should immediately inform Honda Canada Inc. and you may also inform Transport Canada.

If Transport Canada receives similar complaints, it may open an investigation, and if it finds that a safety defect exists in a group of vehicles, it may lead to a recall and remedy campaign. However, Transport Canada cannot become involved in individual problems between you, your dealer, or Honda Canada Inc.

To contact Transport Canada's Defect Investigations and Recalls Division, you may call 1-800-333-0510. For more information on reporting safety defects or about motor vehicle safety, go to <http://www.tc.gc.ca/roadsafety>.

## Testing of Readiness Codes

Your vehicle uses “readiness codes,” as part of its onboard self diagnostic system. Some states refer to these codes during testing to see if your vehicle’s emissions components are working properly. The codes may not be read if you go through the testing just after the battery has gone dead or been disconnected.

To check if they are set, turn the ignition switch to ON **II**\*1, without starting the engine. The malfunction indicator lamp will come on for several seconds. If it then goes off, the readiness codes are set. If it blinks five times, the readiness codes are not set.

If you are required to have your vehicle tested before the readiness codes are ready, prepare the vehicle for retesting by doing the following:

1. Fill the gas tank to approximately 3/4 full.
2. Park the vehicle and leave the engine off for 6 hours or more.
3. Make sure the ambient temperature is between 40°F and 95°F (4°C and 35°C).
4. Start the engine without touching the accelerator pedal, and let it idle for 20 seconds.
5. Keep the vehicle in **P**. Increase the engine speed to 2,000 rpm, and hold it there for about 3 minutes.
6. Let the engine idle with your foot off the accelerator for 20 seconds.

\*1: Models with the smart entry system have an **ENGINE START/STOP** button instead of an ignition switch.

### Testing of Readiness Codes

The readiness codes are erased when the battery is disconnected, and set again only after several days of driving under a variety of conditions.

If a testing facility determines that the readiness codes are not set, you may be requested to return at a later date to complete the test.

If the testing facility determines the readiness codes are still not set, see a dealer.

7. Select a nearby, lightly traveled major highway where you can maintain a speed of 50 to 60 mph (80 to 97 km/h) for at least 20 minutes. Drive on the highway in **D**. Do not use cruise control. When traffic allows, drive for 90 seconds without moving the accelerator pedal. (Vehicle speed may vary slightly; this is okay.) If you cannot do this for a continuous 90 seconds because of traffic conditions, drive for at least 30 seconds, then repeat it two more times (for a total of 90 seconds).
8. Drive in city/suburban traffic for at least 10 minutes. When traffic conditions allow, let the vehicle coast for several seconds without using the accelerator pedal or the brake pedal.
9. Park the vehicle and leave the engine off for 30 minutes.

## ■ U.S. Owners

Your new vehicle is covered by these warranties:

***New Vehicle Limited Warranty*** – covers your new vehicle, except for the emissions control systems and accessories, against defects in materials and workmanship.

***Emissions Control Systems Defects Warranty and Emissions Performance Warranty*** – these two warranties cover your vehicle's emissions control systems. Time, mileage, and coverage are conditional. Please read your warranty booklet for exact information.

***Seat Belt Limited Warranty*** – a seat belt that fails to function properly is covered by a limited warranty. Please read your warranty booklet for details.

***Rust Perforation Limited Warranty*** – all exterior body panels are covered for rust-through from the inside for the specified time period with no mileage limit.

***Accessory Limited Warranty*** – Honda accessories are covered under this warranty. Time and mileage limits depend on the type of accessory and other factors. Please read your warranty booklet for details.

***Replacement Parts Limited Warranty*** – covers all Honda replacement parts against defects in materials and workmanship.

**Replacement Battery Limited Warranty** – provides prorated coverage for a replacement battery purchased from a dealer.

**Replacement Muffler Lifetime Limited Warranty** – provides coverage for as long as the purchaser of the muffler owns the vehicle.

Restrictions and exclusions apply to all these warranties. Please read the 2013 Honda warranty information booklet that came with your vehicle for precise information on warranty coverages. Your vehicle's original tires are covered by their manufacturer. Tire warranty information is in a separate booklet.

■ **Canadian Owners**

Please refer to the 2013 warranty manual that came with your vehicle.

## ■ Service Express

For electronic copies of service publications, you can purchase a subscription to Service Express. Visit [www.techinfo.honda.com](http://www.techinfo.honda.com) for pricing and options.

## ■ For U.S. Owners:

The publications listed below can be purchased from Helm Incorporated. You can order a manual by phone at (800) 782-4356 (credit card orders only), or online at [www.helminc.com](http://www.helminc.com).

Make an inquiry to Helm Inc. at (800) 782-4356 if you are interested in ordering other models' or other years' manuals.

Publication Form Number	Form Description
61TY401	2013 Crosstour L4 Service Manual
61TP603	2010-2013 Crosstour V6 Service Manual
61TP631	2010-2012 Model Series Crosstour Body Repair Manual
31TP6630	2013 Crosstour Owner's Manual
31TP6830	2013 Crosstour Navigation System Owner's Manual
31TP6M30	2013 Crosstour Service History
31TP6A30	2013 Crosstour Technology Reference Guide (EX)
31TP6B30	2013 Crosstour Technology Reference Guide (EX-L)
31TP6C30	2013 Crosstour Technology Reference Guide (EX/EL-L with Navigation)
HON-R	Order Form for Previous Years- Indicate Year and Model Desired

## ☒ Authorized Manuals

### Service Manual:

Covers maintenance and recommended procedures for repair to engine and chassis components. It is written for the journeyman technician, but it is simple enough for most mechanically inclined owners to understand.

### Body Repair Manual:

Describes the procedures involved in the replacement of damaged body parts.

### For Canadian Owners:

Si vous avez besoin d'un Manuel du Conducteur en français, veuillez demander à votre concessionnaire de commander le numéro de pièce 33TP6C30

Honda dealership personnel are trained professionals.

They should be able to answer all your questions. If you encounter a problem that your dealership does not solve to your satisfaction, please discuss it with the dealership's service manager or general manager. If you are dissatisfied with the decision made by the dealership's management, contact Honda Customer Services.

## **U.S. Owners:**

American Honda Motor Co., Inc.  
Honda Automobile Customer Services  
Mail Stop 500-2N-7A  
1919 Torrance Blvd.  
Torrance, CA 90501-2746  
Tel: (800) 999-1009

## **Canadian Owners:**

Honda Canada Inc.  
Customer Relations  
180 Honda Boulevard  
Markham, ON  
L6C 0H9  
Tel: 1-888-9-HONDA-9  
Fax: 1-877-939-0909  
E-mail: Honda\_cr@ch.honda.com

## **In Puerto Rico and the U.S. Virgin Islands:**

Bella International  
P.O. Box 190816  
San Juan, PR 00919-0816  
Tel: (787) 620-7546

## Customer Service Information

When you call or write, please give us the following information:

- Vehicle Identification Number
  - **Vehicle Identification Number (VIN)**  
P. 550
- Date of purchase
- Odometer reading of your vehicle
- Your name, address, and telephone number
- A detailed description of the problem
- Name of the dealer who sold the vehicle to you



## Gracenote Music Recognition Service (CDDB)



Music recognition technology and related data are provided by Gracenote®. Gracenote is the industry standard in music recognition technology and related content delivery.

For more information, visit [www.gracenote.com](http://www.gracenote.com).

When music is recorded to the HDD from a CD, information such as the recording artist and track name are retrieved from the Gracenote Database and displayed (when available).

Gracenote may not contain information for all albums.

Gracenote is an internet-based music recognition service that allows artist, album, and track information from CDs to display on the HDD.

Gracenote users are allowed 4 free updates a year. More information about Gracenote, its features, and downloads are available at

[www.honda.com](http://www.honda.com) (in U.S.) or [www.honda.ca](http://www.honda.ca) (in Canada). CD and music-related data from Gracenote, Inc., copyright © 2000 to present Gracenote. Gracenote Software, copyright © 2000 to present Gracenote. One or more patents owned by Gracenote apply to this product and service. See the Gracenote website for a non-exhaustive list of applicable Gracenote patents. Gracenote, CDDB, MusicID, MediaVOCS, the Gracenote logo and logotype, and the "Powered by Gracenote" logo are either registered trademarks or trademarks of Gracenote in the United States and/or other countries.

## Gracenote® END USER LICENSE AGREEMENT

This application or device contains software from Gracenote, Inc. of Emeryville, California ("Gracenote"). The software from Gracenote (the "Gracenote Software") enables this application to perform disc and/or file identification and obtain music-related information, including name, artist, track, and title information ("Gracenote Data") from online servers or

embedded databases (collectively, "Gracenote Servers") and to perform other functions. You may use Gracenote Data only by means of the intended End-User functions or this application or device.

You agree that you will use Gracenote Data, the Gracenote Software, and Gracenote Servers for your own personal non-commercial use only.

You agree not to assign, copy, transfer, or transmit the Gracenote Software or any Gracenote Data to any third party.

YOU AGREE NOT TO USE OR EXPLOIT GRACENOTE DATA, THE GRACENOTE SOFTWARE, OR GRACENOTE SERVERS, EXCEPT AS EXPRESSLY PERMITTED HEREIN.

You agree that your non-exclusive license to use the Gracenote Data, the Gracenote Software, and Gracenote Servers will terminate if you violate these restrictions. If your license terminates, you agree to cease any and all use of the Gracenote Data, the Gracenote Software, and Gracenote Servers.

Gracenote reserves all rights in Gracenote Data, the Gracenote Software, and the Gracenote Servers, including all ownership rights. Under no circumstances will Gracenote become liable for any payment to you for any information that you provide. You agree that Gracenote, Inc. may enforce its rights under this Agreement against you directly in its own name.

The Gracenote service uses a unique identifier to track queries for statistical purposes. The purpose of a randomly assigned numeric identifier is to allow the Gracenote service to count queries without knowing anything about who you are. For more information, see the web page for the Gracenote Privacy Policy for the Gracenote service.

The Gracenote Software and each item of Gracenote Data are licensed to you "AS IS."

Gracenote makes no representations or warranties, express or implied, regarding the accuracy of any Gracenote Data from in the Gracenote Servers. Gracenote reserves the right to delete data from the Gracenote Servers or to change data categories for any

cause that Gracenote deems sufficient. No warranty is made that the Gracenote Software or Gracenote Servers are error-free or that functioning of Gracenote Software or Gracenote Servers will be uninterrupted.

Gracenote is not obligated to provide you with new enhanced or additional data types or categories that Gracenote may provide in the future and is free to discontinue its services at any time.

GRACENOTE DISCLAIMS ALL WARRANTIES EXPRESS OR IMPLIED, INCLUDING, BUT NOT LIMITED TO, IMPLIED WARRANTIES OF MERCHANTABILITY, FITNESS FOR A PARTICULAR PURPOSE, TITLE, AND NONINFRINGEMENT. GRACENOTE DOES NOT WARRANT THE RESULTS THAT WILL BE OBTAINED BY YOUR USE OF THE GRACENOTE SOFTWARE OR ANY GRACENOTE SERVER. IN NO CASE WILL GRACENOTE BE LIABLE FOR ANY CONSEQUENTIAL OR INCIDENTAL DAMAGES OR FOR ANY LOST PROFITS OR LOST REVENUES.

copyright © 2000 to present Gracenote

## Disclaimer of Pandora®

Requirements to access Pandora®

- Latest version of the Pandora app installed on your Android, Blackberry, or iPhone.
- Registered Pandora account (you can create a free account at [www.pandora.com](http://www.pandora.com) <<http://www.pandora.com/>> or on your smartphone)
- Connection to the internet via WiFi or cellular data network.

### Limitations

- Access to Pandora requires an active internet connection
- Ability to access Pandora through this system is subject to change without notice
- Certain functionality of Pandora service is not available when accessing the service through this system including, but not limited to, creating new stations, deleting stations, emailing current stations, buying songs, viewing additional text information, logging in to Pandora, and adjusting Cell Network Audio Quality. Pandora internet radio is a music service not affiliated with HONDA. More information is available at <http://www.pandora.com> <<http://www.pandora.com/>>. Pandora, the Pandora logo, and the Pandora trade dress are trademarks or registered trademarks of Pandora Media, Inc., used with permission.
- Mobile access requires a smartphone with an active data plan. Standard data rates may apply.
- Pandora is only available in the United States.

## A

ABS (Anti-lock Brake System).....	451
Accessories and Modifications.....	460
Accessory Power Sockets.....	147
Additives	
Coolant.....	478
Engine Oil.....	472
Washer.....	483
Additives, Engine Oil.....	472
Adjusting	
Armrest.....	141
Front Seats.....	133
Head Restraints.....	136
Mirrors.....	130
Rear Seats.....	139
Steering Wheel.....	129
Aha™.....	209, 262
Air Conditioning System (Climate Control System).....	157
Changing the Mode.....	157, 158
Defrosting the Windshield and Windows.....	159
Dust and Pollen Filter.....	509
Recirculation/Fresh Air Mode.....	157, 158
Sensors.....	162
Synchronized Mode.....	161
Using Automatic Climate Control.....	157
Air Conditioning System (Heating and Cooling System).....	154
Cooling.....	156

Defrosting the Windshield and Windows.....	156
Dust and Pollen Filter.....	509
Heating.....	155
Air Pressure.....	498, 547, 549
Airbags	
Advanced Airbags.....	45
Airbag Care.....	53
Event Data Recorder.....	24
Front Airbags (SRS).....	42
Indicator.....	50, 73, 79
Passenger Airbag Off Indicator.....	51
Sensors.....	39
Side Airbag Cutoff System.....	48
Side Airbag Off Indicator.....	52
Side Airbags.....	46
Side Curtain Airbags.....	49
AM/FM Radio.....	171, 193, 232
Anti-lock Brake System (ABS).....	451
Indicator.....	73
Armrest.....	141
Audio Remote Controls.....	168
Audio System.....	164
Adjusting the Sound.....	170, 191, 222
Auxiliary Input Jack.....	165
Error Messages.....	268
General Information.....	276
HDD.....	242
Internet Radio.....	207, 260
iPod®.....	203, 252
MP3/WMA/AAC.....	179, 210, 263

Reactivating.....	166
Recommended CDs.....	277
Recommended Devices.....	279
Remote Controls.....	168
Security Code.....	166
Theft Protection.....	166
Touch Screen.....	183, 216
USB Adapter Cable.....	165
USB Flash Drives.....	280
Authorized Manuals.....	557
Auto Door Locking/Unlocking.....	101
Customize.....	298, 309
Automatic Lighting.....	120
Automatic Transmission.....	425
Creeping.....	425
Fluid.....	480
Kickdown.....	425
Operating the Shift Lever.....	18, 427, 429
Shift Lever Does Not Move.....	531
Shifting.....	426, 428
Auxiliary Input Jack.....	165

## B

Battery.....	506
Charging System Indicator.....	71, 534
Jump Starting.....	528
Maintenance (Checking the Battery).....	506
Maintenance (Replacing).....	507
Belts (Seat).....	32
Beverage Holders.....	146

<i>Bluetooth</i> ® Audio.....	213, 266	<b>Changing Bulbs</b> .....	484	<b>Controls</b> .....	87
<i>Bluetooth</i> ® HandsFreeLink® ....	320, 332, 367	<b>Charging System Indicator</b> .....	71, 534	<b>Coolant (Engine)</b> .....	478
<b>Booster Seats (For Children)</b> .....	65	<b>Child Safety</b> .....	54	Adding to the Radiator.....	479
<b>Brake System</b> .....	449	Childproof Door Locks.....	100	Adding to the Reserve Tank.....	478
Anti-lock Brake System (ABS) .....	451	<b>Child Seat</b> .....	54	Overheating .....	532
Brake Assist System.....	452	Booster Seats.....	65	<b>Creeping (Automatic Transmission)</b> .....	425
Fluid .....	481	Child Seat for Infants.....	56	<b>Cruise Control</b> .....	432
Foot Brake .....	450	Child Seat for Small Children .....	57	Indicator.....	81
Indicator .....	70, 536	Installing a Child Seat with a Lap/ Shoulder Seat Belt .....	61	<b>Cup Holders</b> .....	146
Parking Brake.....	449	Larger Children.....	64	<b>Customer Service Information</b> .....	558
<b>Brightness Control (Instrument Panel)</b> ...	125	Rear-facing Child Seat .....	56	<b>Customized Features</b> .....	281
<b>Bulb Replacement</b> .....	484	Selecting a Child Seat .....	58		
Brake Light, Taillight, Back-Up Light, Rear Turn Signal Light and Lower Rear Side Marker Light.....	490	<b>Childproof Door Locks</b> .....	100	<b>D</b>	
Fog Lights.....	486	<b>Cleaning the Exterior</b> .....	512	<b>Daytime Running Lights</b> .....	122
Front Turn Signal/Parking Light .....	489	<b>Cleaning the Interior</b> .....	510	<b>Dead Battery</b> .....	528
Headlights .....	484	<b>Climate Control System</b> .....	157	<b>Defrosting the Windshield and</b> <b>Windows</b> .....	156, 159
High-Mount Brake Light.....	492	Changing the Mode .....	157	<b>Devices that Emit Radio Waves</b> .....	551
Rear License Plate Light.....	492	Defrosting the Windshield and Windows .....	159	<b>Dimming</b>	
Side Marker Lights .....	488	Dust and Pollen Filter.....	509	Headlights.....	119
<b>Bulb Specifications</b> .....	546, 548	Recirculation and Fresh Air Mode .....	158	Rearview Mirror.....	130
		Recirculation/Fresh Air Mode .....	157	<b>Dipstick (Engine Oil)</b> .....	473
		Sensors.....	162	<b>Directional Signals (Turn Signal)</b> .....	119
		Synchronized Mode.....	161	<b>Display Button</b> .....	186, 218
		Using Automatic Climate Control .....	157	<b>Door Mirrors</b> .....	131
<b>C</b>		<b>Clock</b> .....	88	<b>Doors</b> .....	91
<b>Carbon Monoxide Gas</b> .....	66	<b>Coat Hook</b> .....	148	Auto Door Locking .....	101
<b>Cargo Hook</b> .....	149	<b>Compact Spare Tire</b> .....	517, 547, 549	Auto Door Unlocking .....	101
<b>Carrying Cargo</b> .....	411, 413	<b>Compass</b> .....	405, 407	Door and Trunk Open Indicator .....	74
<b>CD Player</b> .....	173, 200, 239	<b>Console Compartment</b> .....	145	Door Open Indicator.....	31
<b>Center Pocket</b> .....	152				
<b>Certification Label</b> .....	550				

- Keys ..... 91
  - Locking/Unlocking the Doors from the
    - Inside ..... 99
    - Locking/Unlocking the Doors from the
      - Outside ..... 94
    - Lockout Prevention System ..... 98
  - DOT Tire Quality Grading ..... 500
  - Driver's Seat Lumbar Support ..... 133
  - Driving ..... 409
    - Automatic Transmission ..... 425
    - Braking ..... 449
    - Cruise Control ..... 432
    - Shifting Gear ..... 426, 428
    - Starting the Engine ..... 420, 422
  - Driving Position Memory System ..... 127
  - Dust and Pollen Filter ..... 509
- E**
- Electric Power Steering (EPS) System
    - Indicator ..... 74, 536
  - Electronic Stability Control (ESC) ..... 442
  - Emergency ..... 542
  - Emissions Testing (Readiness Codes) ..... 553
  - Engine ..... 550
    - Coolant ..... 478
    - Jump Starting ..... 528
    - Oil ..... 472
    - Starting ..... 420, 422
    - Switch Buzzer ..... 114
  - Engine Coolant ..... 478
    - Adding to the Radiator ..... 479
    - Adding to the Reserve Tank ..... 478
    - Overheating ..... 532
    - Temperature Gauge ..... 83
  - Engine Oil ..... 472
    - Adding ..... 475
    - Checking ..... 473
    - Displaying Oil Life ..... 465
    - Low Oil Pressure Indicator ..... 70, 534
    - Recommended Engine Oil ..... 472
  - ENGINE START/STOP Button ..... 115
  - EPS (Electric Power Steering)
    - System ..... 74, 536
  - Exhaust Gas Hazard (Carbon Monoxide) .. 66
  - Exterior Care (Cleaning) ..... 512
  - Exterior Mirrors ..... 131
- F**
- Features ..... 163
  - Filters
    - Dust and Pollen ..... 509
    - Oil ..... 476
  - Flat Tire ..... 517
  - Floor Mats ..... 511
  - Fluids
    - Automatic Transmission ..... 480
    - Brake ..... 481
    - Engine Coolant ..... 478
    - Windshield Washer ..... 483
  - Fog Light Indicator ..... 79
  - Folding Down the Rear Seats ..... 139
  - Foot Brake ..... 450
  - Front Airbags (SRS) ..... 42
  - Front Seats ..... 133
    - Adjusting ..... 133
  - Fuel ..... 19, 456
    - Economy ..... 459
    - Gauge ..... 83
    - Low Fuel Indicator ..... 72
    - Recommendation ..... 456
    - Refueling ..... 456
  - Fuel Economy ..... 459
  - Fuel Fill Cap ..... 19, 458
    - Message ..... 535
  - Fuel Fill Door ..... 457
  - Fuses ..... 538
    - Inspecting and Changing ..... 541
    - Locations ..... 538, 539
- G**
- Gasoline (Fuel)
    - Economy ..... 459
    - Gauge ..... 83
    - Information ..... 456
    - Low Fuel Indicator ..... 72
    - Refueling ..... 456
  - Gauges ..... 83
  - Gear Shift Lever Positions
    - Automatic Transmission ..... 426, 428

Glass (care) .....	513
Glove Box .....	144

## H

Halogen Bulbs .....	486
Handling the Unexpected .....	515
HandsFreeLink® (HFL) .....	320, 332, 367
Auto Answer .....	347, 382
Automatic Import of Cellular Phonebook and Call History .....	349, 384
Automatic Transferring .....	347, 382
Displaying Messages .....	362, 401
Editing User Name .....	381
HFL Buttons .....	320, 332, 367
HFL Menus .....	322, 334, 369
HFL Status Display .....	321, 333, 368
Limitations for Manual Operation....	333, 368
Making a Call .....	353, 393
Options During a Call .....	359, 398
Phone Setup .....	324, 339, 373
Phonebook Phonetic Modification .....	388
Receiving a Call .....	358, 397
Receiving a Text Message/E-mail .....	360, 399
Ring Tone .....	348, 383
Selecting a Mail Account .....	361, 400
Speed Dial .....	350, 385
To Create a Security PIN .....	346, 380
To Set Up a Text Message/E-mail Options .....	344, 378
Hard Disc Drive (HDD) Audio .....	242

Hazard Warning Button .....	2
Head Restraints .....	136
Headlights .....	119
Aiming .....	484
Automatic Operation .....	120
Dimming .....	119, 122
Operating .....	119
Heaters (Seat) .....	153
Heating and Cooling System .....	154
Cooling .....	156
Defrosting the Windshield and Windows .....	156
Dust and Pollen Filter .....	509
Heating .....	155
HFL (HandsFreeLink®) .....	320, 332, 367
High Beam Indicator .....	79
HomeLink® Universal Transceiver .....	318

## I

Identification Numbers	
Engine and Transmission .....	550
Vehicle Identification .....	550
Ignition Switch .....	114
Illumination Control .....	125
Knob .....	125
Immobilizer System .....	107
Indicator .....	80
Indicators .....	70
ABS (Anti-lock Brake System) .....	73
Charging System .....	71, 534

CRUISE CONTROL .....	81, 433
CRUISE MAIN .....	81, 432
Door and Trunk Open .....	74
Door Open .....	31
EPS (Electric Power Steering) System ..	74, 536
Fog Light .....	79
Forward Collision Warning (FCW) .....	76
High Beam .....	79
Immobilizer System .....	80
Lane Departure Warning (LDW) .....	77
Lights On .....	79
Low Fuel .....	72
Low Oil Pressure .....	70, 534
Low Tire Pressure .....	75, 446, 447
Maintenance Minder .....	81, 465
Malfunction Indicator Lamp .....	71, 535
Parking Brake and Brake System .....	70, 536
Seat Belt Reminder .....	33, 71
Security System Alarm .....	80
Side Airbag Off .....	52, 79
Smart Entry System .....	78
Starter System .....	78
Supplemental Restraint System .....	50, 73
TPMS .....	75, 448
Transmission .....	72
Turn Signal .....	78
VSA® (Vehicle Stability Assist) System .....	73, 442
VSA® OFF .....	73, 443
Washer Level .....	81
Information .....	545

Information Display.....	84
Instrument Panel.....	69
Brightness Control.....	125
Interface Dial.....	215
Interior Lights.....	142
Interior Rearview Mirror.....	130

## J

Jack (Wheel Nut Wrench).....	521
Jump Starting.....	528

## K

Key Number Tag.....	92
Keyless Lockout Prevention.....	98
Keys.....	91
Lockout Prevention.....	98
Master Keys.....	91
Number Tag.....	92
Rear Door Won't Open.....	100
Remote Transmitter.....	94
Types and Functions.....	91
Valet Key.....	92
Won't Turn.....	22
Kickdown (Automatic Transmission).....	425

## L

Lane Departure Warning (LDW).....	439
LaneWatch™.....	444
Language (HFL).....	321, 333, 368

LATCH (Child Seats).....	59, 62
Lights.....	119, 484
Automatic.....	120
Bulb Replacement.....	484
Daytime Running Lights.....	122
Fog Lights.....	122
High Beam Indicator.....	79
Interior.....	142
Light Switches.....	119
Lights On Indicator.....	79
Turn Signals.....	119
Load Limits.....	413
Locking/Unlocking.....	91
Auto Door Locking/Unlocking.....	101
Childproof Door Locks.....	100
From Inside.....	99
From Outside.....	94
Keys.....	91
Using a Key.....	98
Lockout Prevention System.....	98
Low Battery Charge.....	534
Low Fuel Indicator.....	72
Low Oil Pressure Indicator.....	70, 534
Lower Anchors.....	59, 62
Lubricant Specifications Chart.....	546, 548
Luggage (Maximum Load Limit).....	413

## M

Maintenance.....	461
Battery.....	506

Brake Fluid.....	481
Cleaning.....	510
Climate Control System.....	509
Coolant.....	478
Heating and Cooling System.....	509
Maintenance Minder™.....	465
Oil.....	473
Precautions.....	462
Radiator.....	479
Remote Transmitter.....	507
Replacing Light Bulbs.....	484
Safety.....	463
Service Items.....	467
Tires.....	497
Transmission Fluid.....	480
Under the Hood.....	469
<b>Malfunction Indicator Lamp.....</b>	<b>71, 535</b>
Map Lights.....	143
Maximum Load Limit.....	413
Meters, Gauges.....	83
Mirrors.....	130
Adjusting.....	130
Door.....	131
Exterior.....	131
Interior Rearview.....	130
Modifications (and Accessories).....	460
Moonroof.....	113
MP3.....	173, 179, 200, 210, 239, 263
Multi-View Rear Camera.....	455



## N

Numbers (Identification) ..... 550

## O

Odometer ..... 84

Oil (Engine) ..... 472

Adding ..... 475

Checking ..... 473

Displaying Oil Life ..... 465

Low Oil Pressure Indicator ..... 70, 534

Recommended Engine Oil ..... 472

Viscosity ..... 472

### Opening/Closing

Hood ..... 471

Moonroof ..... 113

Power Windows ..... 110

Tailgate ..... 105

Outside Temperature ..... 86

Adjusting ..... 86

Overheating ..... 532

## P

Paddle Shifters (Sequential Shift  
Mode) ..... 430

Pandora® ..... 208, 261

Panic Mode ..... 109

Parking ..... 453

Parking Brake ..... 449

### Parking Brake and Brake System

Indicator ..... 70, 536

Passenger Airbag Off Indicator ..... 51

Passing Indicators ..... 119

Power Windows ..... 110

Precautions While Driving ..... 424

Rain ..... 424

Pregnant Women ..... 37

Puncture (Tire) ..... 517

## R

Radiator ..... 479

Radio (AM/FM) ..... 171, 193, 232

Radio (XM®) ..... 197, 236

Radio Data System (RDS) ..... 172, 195, 234

RDS (Radio Data System) ..... 172, 195, 234

Readiness Codes (Emissions Testing) ..... 553

### Rear Defogger/Heated Door Mirror

Button ..... 126

Rear Seats (Folding Down) ..... 139

Rearview Mirror ..... 130

Refueling ..... 456

Fuel Gauge ..... 83

Gasoline ..... 456, 546, 548

Low Fuel Indicator ..... 72

Regulations ..... 447, 500, 551

Remote Transmitter ..... 94

### Replacement

Battery ..... 507

Bulbs ..... 484

Front Wiper Blade Rubber ..... 493

Fuses ..... 538, 539

Rear Wiper Blade Rubber ..... 495

Tires ..... 503

Reporting Safety Defects ..... 552

Resetting a Trip Meter ..... 85

## S

Safe Driving ..... 27

Safety Check ..... 31

Safety Labels ..... 67

Safety Message ..... 25

Seat Belts ..... 32

Adjusting the Shoulder Anchor ..... 36

Automatic Seat Belt Tensioners ..... 34

Checking ..... 38

Fastening ..... 35

Installing a Child Seat with a Lap/  
Shoulder Seat Belt ..... 61

Pregnant Women ..... 37

Reminder ..... 33

Warning Indicator ..... 33, 71

Seat Heaters ..... 153

Seats ..... 133

Adjusting ..... 133

Driver's Seat Lumbar Support ..... 133

Front Seats ..... 133

Rear Seats ..... 139

Seat Heaters ..... 153

Security System .....	107	Engine Switch Buzzer .....	114	Spare Tire .....	517, 547, 549
Immobilizer System Indicator .....	80	Jump Starting .....	528	Summer .....	505
Security System Alarm Indicator .....	80	<b>Steering Wheel</b> .....	129	Tire Chains .....	505
<b>Select Lever</b> .....	18, 426, 428	Adjusting .....	129	Wear Indicators .....	502
Operation .....	18, 427, 429	<b>Stopping</b> .....	453	Winter .....	505
Releasing .....	531	<b>Summer Tires</b> .....	505	<b>Tools</b> .....	516
Won't Move .....	531	<b>Sunglasses Holder</b> .....	152	<b>Towing a Trailer</b> .....	415
<b>Select/Reset Knob</b> .....	84	<b>Supplemental Restraint System (SRS)</b> .....	42	Equipment and Accessories .....	416
<b>Selecting a Child Seat</b> .....	58	<b>Switches (Around the Steering</b>		Load Limits .....	415
<b>Selector Knob (Audio)</b> .....	169, 182	Wheel) .....	2, 3, 114	<b>Towing Your Vehicle</b> .....	419
<b>Sequential Shift Mode</b> .....	430	<b>Synchronized Mode</b> .....	161	Emergency .....	542
<b>Setting the Clock</b> .....	88			<b>TPMS (Tire Pressure Monitoring</b>	
<b>Shift Lever</b> .....	18, 426, 428	<b>T</b>		System) .....	446
<b>Shift Lever Position Indicator</b> .....	427, 429	<b>Tachometer</b> .....	83	Indicator .....	75, 537
<b>Shifting (Transmission)</b> .....	426, 428	<b>Tailgate</b> .....	105	<b>Transmission</b> .....	426, 428
<b>Shoulder Anchor</b> .....	36	Unable to Open .....	544	Automatic .....	426, 428
<b>Side Airbags</b> .....	46	<b>Temperature Gauge</b> .....	83	Fluid .....	480
Cutoff System .....	48	<b>Temperature Sensor</b> .....	162	Number .....	550
Off Indicator .....	48	<b>Time (Setting)</b> .....	88	Shift Lever Position Indicator .....	427, 429
<b>Side Curtain Airbags</b> .....	49	<b>Tire Pressure Monitoring System</b>		<b>Trip Meter</b> .....	85
<b>Smart Entry with Push Button Start</b>		(TPMS) .....	446	<b>Troubleshooting</b> .....	515
System .....	96	Indicator .....	75, 537	Blown Fuse .....	538, 539
<b>Snow Tires</b> .....	505	<b>Tires</b> .....	497	Brake Pedal Vibrates .....	22
<b>Spare Tire</b> .....	517, 547, 549	Air Pressure .....	498, 547, 549	Buzzer Sounds When Opening Door .....	23
<b>Spark Plugs</b> .....	546, 548	Checking and Maintaining .....	497	Emergency Towing .....	542
<b>Specifications</b> .....	546	Inspection .....	497	Engine Won't Start .....	525
<b>Specified Fuel</b> .....	456, 546, 548	Labeling .....	498	Noise When Braking .....	23
<b>Speedometer</b> .....	83	Puncture (Flat Tire) .....	517	Overheating .....	532
<b>SRS Airbags (Airbags)</b> .....	42	Regulations .....	500	Puncture/Flat Tire .....	517
<b>Starting the Engine</b> .....	420, 422	Rotation .....	504	Rear Door Won't Open .....	22, 100
Does Not Start .....	525			Select Lever Won't Move .....	531

Warning Indicators.....	70
<b>Trunk</b>	
Light Bulb .....	546, 548
<b>Turn Signals</b> .....	119
Indicators (Instrument Panel) .....	78

## U

Unlocking the Doors.....	94
USB Adapter Cable .....	164, 165
USB Flash Drives .....	280
Using the Smart Entry with Push Button Start System.....	96

## V

Valet Key .....	92
Vanity Mirrors .....	5
Vehicle Identification Number .....	550
Vehicle Stability Assist (VSA®) .....	442
Off Button .....	443
Off Indicator .....	73
System Indicator .....	73
Ventilation .....	158
Viscosity (Oil).....	472, 547, 549
VSA® (Vehicle Stability Assist) .....	442

## W

Warning and Information Messages .....	82
Warning Indicator On/Blinking.....	534
Warning Labels .....	67

<b>Warranties (Warranty Manual provided separately)</b> .....	555
<b>Watts</b> .....	546, 548
<b>Wear Indicators (Tire)</b> .....	502
<b>Wheel Nut Wrench (Jack Handle)</b> .....	521
<b>Window Washers</b> .....	123
Adding/Refilling Fluid.....	483
Switch .....	123
<b>Windows (Opening and Closing)</b> .....	110
<b>Windshield</b> .....	123
Cleaning.....	513
Defrosting/Defogging .....	156, 159
Washer Fluid .....	483
Wiper Blades .....	493
Wipers and Washers.....	123
<b>Winter Tires</b> .....	505
Snow Tires.....	505
Tire Chains .....	505
<b>Wipers and Washers</b> .....	123
Checking and Replacing Wiper Blades .....	493
Front .....	123
Rear .....	124
<b>WMA</b> .....	173, 179, 200, 210, 239, 263
<b>Worn Tires</b> .....	497

## X

<b>XM® Radio</b> .....	197, 236
------------------------	----------