



13/02/07 11:38:50 32MJG600\_001



# Honda GOLDWING F6B

**OWNER'S MANUAL**



**USO E MANUTENZIONE**



**MANUAL DEL PROPIETARIO**



© Honda Motor Co., Ltd. 2013

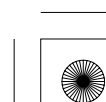



---

## **IMPORTANT INFORMATION**

### **• OPERATOR AND PASSENGER**

(Except KO, SI type)

This motorcycle is designed to carry the operator and one passenger. Never exceed the maximum weight capacity as shown on the accessories and loading label.

(KO, SI type)

This motorcycle is designed to carry the operator and one passenger. Never exceed the maximum weight capacity.

### **• ON-ROAD USE**

This motorcycle is designed to be used only on the road.

### **• READ THIS OWNER'S MANUAL CAREFULLY**

Pay special attention to the safety messages that appear throughout the manual. These messages are fully explained in the "A Few Words About Safety" section which appears before the "Contents" page.

This manual should be considered a permanent part of the motorcycle and should remain with the motorcycle when resold.

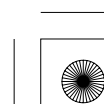
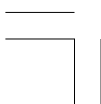

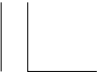

---

# **Honda GOLDWING F6B OWNER'S MANUAL**

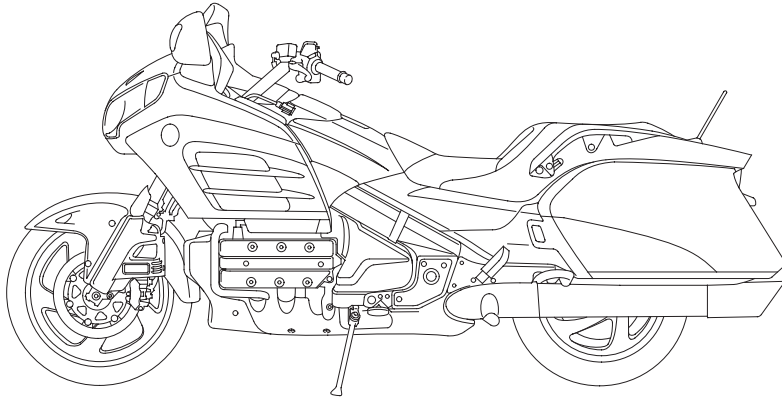

**All information in this publication is based on the latest production information available at the time of approval for printing. Honda Motor Co., Ltd. reserves the right to make changes at any time without notice and without incurring any obligation.**

**No part of this publication may be reproduced without written permission.**

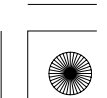



## WELCOME

---

The motorcycle presents you a challenge to master the machine, a challenge to adventure. You ride through the wind, linked to the road by a vehicle that responds to your commands as no other does. Unlike an automobile, there is no metal cage around you. Like an airplane, a pre-ride inspection and regular maintenance are essential to your safety. Your reward is freedom.

To meet the challenges safely, and to enjoy the adventure fully, you should become thoroughly familiar with this owner's manual **BEFORE YOU RIDE THE MOTORCYCLE**.

As you read this manual, you will find information that is preceded by a **NOTICE** symbol. This information is intended to help you avoid damage to your motorcycle, other property, or the environment.

Pleasant riding, and thank you for choosing a Honda !

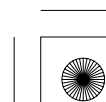
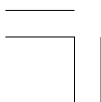



- 
- The following codes in this manual indicate each country.

E	UK
F	France
ED	European direct sales
KO	Korea
U	Australia New Zealand
SI	Singapore

- The specifications may vary with each locale.
- The illustrations herein are based on the ED type.
- This vehicle pictured in this owner's manual may not match your actual vehicle.

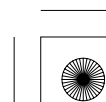
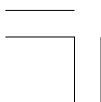



## A FEW WORDS ABOUT SAFETY

---

Your safety, and the safety of others, is very important. And operating this motorcycle safely is an important responsibility.

To help you make informed decisions about safety, we have provided operating procedures and other information on labels and in this manual. This information alerts you to potential hazards that could hurt you or others.

Of course, it is not practical or possible to warn you about all hazards associated with operating or maintaining a motorcycle. You must use your own good judgment.

You will find important safety information in a variety of forms, including:

- **Safety Labels** — on the motorcycle.
- **Safety Messages** — preceded by a safety alert symbol  and one of three signal words: **DANGER**, **WARNING**, or **CAUTION**.

These signal words mean:

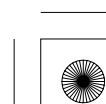
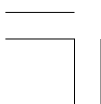

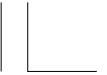

---

**⚠ DANGER**

You **WILL** be **KILLED** or **SERIOUSLY HURT** if you don't follow instructions.

**⚠ WARNING**

You **CAN** be **KILLED** or **SERIOUSLY HURT** if you don't follow instructions.

**⚠ CAUTION**

You **CAN** be **HURT** if you don't follow instructions.

- **Safety Headings** — such as Important Safety Reminders or Important Safety Precautions.
- **Safety Section** — such as Motorcycle Safety.
- **Instructions** — how to use this motorcycle correctly and safely.

This entire manual is filled with important safety information — please read it carefully.





# CONTENTS

---

## OPERATION

Page

### **1 MOTORCYCLE SAFETY**

- 1 IMPORTANT SAFETY INFORMATION
- 2 PROTECTIVE APPAREL
- 4 LOAD LIMITS AND GUIDELINES
- 8 IMAGE LABELS
- 17 SAFETY LABELS

### **20 PARTS LOCATION**

- 23 INSTRUMENTS AND INDICATORS
- 28 MULTI INFORMATION DISPLAY

### **36 MAJOR COMPONENTS**

**(Information you need to operate this motorcycle)**

- 36 REAR SUSPENSION
- 37 BRAKES
- 40 CLUTCH
- 42 COOLANT
- 44 FUEL
- 47 ENGINE OIL
- 48 TUBELESS TYRES

### **53 ESSENTIAL INDIVIDUAL COMPONENTS**

- 53 IGNITION SWITCH
- 54 KEYS
- 55 IMMOBILIZER SYSTEM (HISS)
- 58 RIGHT HANDLEBAR CONTROLS
- 59 LEFT HANDLEBAR CONTROLS

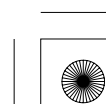
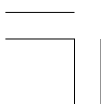





---

Page

**60 FEATURES**

**(Not required for operation)**

- 60 STEERING LOCK
- 60 HELMET HOLDER
- 61 SADDLEBAGS
- 63 FAIRING POCKET/SHELTER CASE
- 64 DOCUMENTS
- 65 HEADLIGHT AIM VERTICAL ADJUSTMENT
- 66 ACC TERMINAL
- 67 AUDIO SYSTEMS
- 83 RADIO
- 99 AUXILIARY FUNCTION
- 101 iPod®/USB FLASH DRIVE
- 115 INTERCOM (I-COM) SYSTEM

**118 OPERATION**

- 118 PRE-RIDE INSPECTION
- 119 STARTING THE ENGINE
- 122 RUNNING-IN
- 123 RIDING
- 124 BRAKING
- 127 PARKING
- 128 ANTI-THEFT TIPS

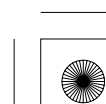
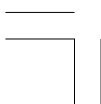



# CONTENTS

---

## MAINTENANCE

Page

### 129 MAINTENANCE

129	THE IMPORTANCE OF MAINTENANCE
130	MAINTENANCE SAFETY
131	SAFETY PRECAUTIONS
132	MAINTENANCE SCHEDULE
134	TOOL KIT
135	SERIAL NUMBERS
136	COLOUR LABEL
137	COVER REMOVAL
142	CLIP
143	ENGINE OIL
148	CRANKCASE BREATHER
149	SPARK PLUGS
151	COOLANT
152	FRONT AND REAR SUSPENSION INSPECTION
153	SIDE STAND
154	WHEEL REMOVAL
162	BRAKE PAD WEAR
163	BRAKE SYSTEM INSPECTION
164	BATTERY
166	FUSE REPLACEMENT
168	BULB REPLACEMENT

### 175 CLEANING

### 179 STORAGE GUIDE

179	STORAGE
180	REMOVAL FROM STORAGE

### 181 TAKING CARE OF THE UNEXPECTED

### 182 SPECIFICATIONS

### 185 CATALYTIC CONVERTER

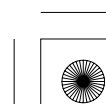
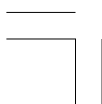



# MOTORCYCLE SAFETY

---

## **IMPORTANT SAFETY INFORMATION**

Your motorcycle can provide many years of service and pleasure — if you take responsibility for your own safety and understand the challenges that you can meet on the road.

There is much that you can do to protect yourself when you ride. You'll find many helpful recommendations throughout this manual. Following are a few that we consider to be most important.

### **Always Wear a Helmet**

It's a proven fact: helmets significantly reduce the number and severity of head injuries. So always wear an approved motorcycle helmet and make sure your passenger does the same. We also recommend that you wear eye protection, sturdy boots, gloves, and other protective gear (page 2 ).

### **Make Yourself Easy to See**

Some drivers do not see motorcycles because they are not looking for them. To make yourself more visible, wear bright reflective clothing, position yourself so other drivers can see you, signal before turning or changing lanes, and use your horn when it will help others notice you.

### **Ride Within Your Limits**

Pushing the limits is another major cause of motorcycle crashes. Never ride beyond your personal abilities or faster than conditions warrant. Remember that alcohol, drugs, fatigue and inattention can significantly reduce your ability to make good judgements and ride safely.

### **Don't Drink and Ride**

Alcohol and riding don't mix. Even one drink can reduce your ability to respond to changing conditions, and your reaction time gets worse with every additional drink. So don't drink and ride, and don't let your friends drink and ride either.

### **Keep Your Bike in Safe Condition**

For safe riding, it's important to inspect your motorcycle before every ride and perform all recommended maintenance. Never exceed load limits, and only use accessories that have been approved by Honda for this motorcycle. See page 4 for more details.



# MOTORCYCLE SAFETY

---

## PROTECTIVE APPAREL

For your safety, we strongly recommend that you always wear an approved motorcycle helmet, eye protection, boots, gloves, trousers, and a long-sleeved shirt or jacket whenever you ride. Although complete protection is not possible, wearing proper gear can reduce the chance of injury when you ride.

Following are suggestions to help you choose proper gear.

### **WARNING**

Not wearing a helmet increases the chance of serious injury or death in a crash.

Be sure you and your passenger always wear a helmet, eye protection and other protective apparel when you ride.



## Helmets and Eye Protection

Your helmet is your most important piece of riding gear because it offers the best protection against head injuries. A helmet should fit your head comfortably and securely. A bright-coloured helmet can make you more noticeable in traffic, as can reflective strips.

An open-face helmet offers some protection, but a full-face helmet offers more. Always wear a face shield or goggles to protect your eyes and help your vision.

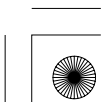
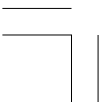



---

### **Additional Riding Gear**

In addition to a helmet and eye protection, we also recommend:

- Sturdy boots with non-slip soles to help protect your feet and ankles.
- Leather gloves to keep your hands warm and help prevent blisters, cuts, burns and bruises.
- A motorcycle riding suit or jacket for comfort as well as protection. Bright-coloured and reflective clothing can help make you more noticeable in traffic. Be sure to avoid loose clothes that could get caught on any part of your motorcycle.

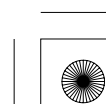
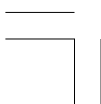



# MOTORCYCLE SAFETY

---

## LOAD LIMITS AND GUIDELINES

Your motorcycle has been designed to carry you, one passenger, cargo and accessories. When you add cargo or carry a passenger, you may feel some difference during acceleration and braking. But so long as you keep your motorcycle well-maintained, with good tyres and brakes, you can safely carry loads within the limits and guidelines given below.

However, exceeding the weight limit or carrying an unbalanced load can seriously affect your motorcycle's handling, braking and stability. Non-Honda accessories, improper modifications, and poor maintenance can also reduce your safety margin.

The following pages give more specific information on loading, accessories and modifications.

### Loading

How much weight you put on your motorcycle, and how you load it, are important to your safety. Anytime you ride with a passenger or cargo you should be aware of the following information.

#### **WARNING**

Overloading or improper loading can cause a crash and you can be seriously hurt or killed.

Follow all load limits and other loading guidelines in this manual.





---

### Load Limits

Following are the load limits for your motorcycle:

<b>Maximum weight capacity:</b>	= 190 kg (419 lb) (Except KO type)
Includes the weight of the rider, passenger, all cargo and all accessories	172 kg (379 lb) (KO type only)

Putting too much weight in individual storage compartments can also affect stability and handling. So be sure to stay within the limits given below:

<b>Maximum cargo weight:</b>	= 27 kg (60 lb) (Except KO type)
includes following maximum compartment weights:	30 kg (66 lb) (KO type only)
<b>each saddlebag</b>	= 8.0 kg (17.6 lb) (Except KO type)
	9.0 kg (20.0 lb) (KO type only)
<b>shelter case</b>	= 3.0 kg (6.6 lb)
<b>fairing pocket</b>	= 2.0 kg (4.5 lb)

The weight of added accessories will reduce the maximum cargo weight you can carry.

### Loading Guidelines

Improperly loading your motorcycle can affect its stability and handling. Even if your motorcycle is properly loaded, you should ride at reduced speeds and never exceed 130 km/h (80 mph) when carrying cargo.

Follow these guidelines whenever you carry a passenger or cargo:

- Check that both tyres are properly inflated (page 48).
- If you change your normal load, you may need to adjust your rear suspension (page 36).





# MOTORCYCLE SAFETY

---

- To prevent loose items from creating a hazard, make sure that storage lids are properly closed and that any other cargo is securely tied down before you ride away.
- Cargo weight should be carried as low and as close to the centre of a motorcycle as possible.
- Balance cargo weight evenly on both sides. When loading the saddlebags, for example, be sure the weight in each bag is about the same.

## Accessories and Modifications

Modifying your motorcycle or using non-Honda accessories can make your motorcycle unsafe. Before you consider making any modifications or adding an accessory, be sure to read the following information.

### **WARNING**

Improper accessories or modifications can cause a crash in which you can be seriously hurt or killed.

Follow all instructions in this owner's manual regarding accessories and modifications.

## Accessories

We strongly recommend that you use only Honda Genuine Accessories that have been specifically designed and tested for your motorcycle. Because Honda cannot test all other accessories, you must be personally responsible for proper selection, installation and use of non-Honda accessories. Check with your dealer for assistance and always follow these guidelines:

- Make sure the accessory does not obscure any lights, reduce ground clearance and banking angle, limit suspension travel or steering travel, alter your riding position or interfere with operating any controls.







- 
- Be sure electrical equipment does not exceed the motorcycle's electrical system capacity (page 183 ). A blown fuse can cause a loss of lights or engine power.
  - Do not pull a trailer or sidecar with your motorcycle. This motorcycle was not designed for these attachments, and their use can seriously impair your motorcycle's handling.

### **Modifications**

We strongly advise you not to remove any original equipment or modify your motorcycle in any way that would change its design or operation. Such changes could seriously impair your motorcycle's handling, stability and braking, making it unsafe to ride.

Removing or modifying your lights, mufflers, emission control system or other equipment can also make your motorcycle illegal.

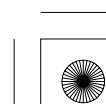
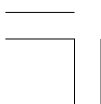



# MOTORCYCLE SAFETY





---

## IMAGE LABELS

Except KO, SI type

The following pages describe the label meanings. Some labels warn you of potential hazards that could cause serious injury. Others provide important safety information. Read this information carefully and don't remove the labels.

There is a specific symbol on each label. The meanings of each symbol and label are as follows.

	Read instructions contained in Owner's Manual carefully.
	Read instructions contained in Shop Manual carefully. In the interest of safety, take the motorcycle to be serviced only by your dealer.
	<b>DANGER (with RED background)</b> You WILL be KILLED or SERIOUSLY HURT if you don't follow instructions.
	<b>WARNING (with ORANGE background)</b> You CAN be KILLED or SERIOUSLY HURT if you don't follow instructions.
	<b>CAUTION (with YELLOW background)</b> You CAN be HURT if you don't follow instructions.





### RADIATOR CAP LABEL

#### DANGER

NEVER OPEN WHEN HOT.

Hot coolant will scald you.

Relief pressure valve begins to open at 1.1 kgf/cm<sup>2</sup>.

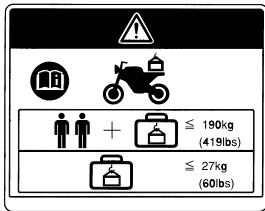

### ACCESSORIES AND LOADING WARNING LABEL

#### WARNING

#### ACCESSORIES AND LOADING

- The safety stability and handling of this motorcycle may be affected by the addition of accessories and luggage.
- Read carefully the instructions contained in user's manual and installation guide before installing any accessory.
- The total weight of accessories and luggage added to rider's and passenger's weight should not exceed 190 kg (419 lb), which is the maximum weight capacity.
- The luggage weight must not exceed 27 kg (60 lb) under any circumstances.
- The fitting of large fork-mounted or large handlebar-mounted fairing is not recommended.

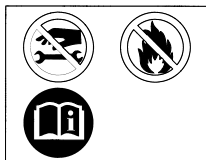

### SADDLEBAG DAMPER LABEL

#### CONTENTS UNDER PRESSURE

Do not puncture, take apart or apply heat.

Do not apply side force.





# MOTORCYCLE SAFETY



## REAR CUSHION LABEL

**GAS FILLED**

Do not open.  
Do not heat.

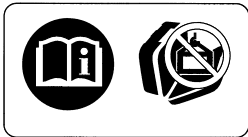

## SADDLEBAG LABEL

**NOTICE**

Heavy cargo placed on the open lid can damage the saddlebag and lid.



## ACG CABLE LABEL

**NOTICE**

Before removing alternator cable, disconnect battery negative cable to prevent damage to the main fuse.

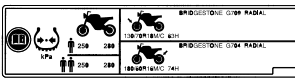

## TYRE INFORMATION LABEL

**Cold tyre pressure:**

[Driver only]

Front 250 kPa (2.50 kgf/cm<sup>2</sup>, 36 psi)

Rear 280 kPa (2.80 kgf/cm<sup>2</sup>, 41 psi)

[Driver and passenger]

Front 250 kPa (2.50 kgf/cm<sup>2</sup>, 36 psi)

Rear 280 kPa (2.80 kgf/cm<sup>2</sup>, 41 psi)

**Tyre size:**

Front 130/70R18M/C 63H

Rear 180/60R16M/C 74H

**Tyre brand: BRIDGESTONE**

Front G709 RADIAL

Rear G704 RADIAL





**SAFETY REMINDER LABEL**

For your protection, always wear your helmet while riding.

**FUEL LABEL**

UNLEADED PETROL ONLY



**CARGO LIMIT LABEL**

Do not exceed 2.0 kg (4.5 lb) .



**CARGO LIMIT LABEL**

Do not exceed 3.0 kg (6.6 lb) .



**CARGO LIMIT LABEL**

Do not exceed 8.0 kg (17.6 lb) .

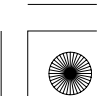
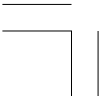



# MOTORCYCLE SAFETY

---



## BATTERY LABEL

### DANGER

- Keep flames and sparks away from the battery.
- The battery produces explosive gas that can cause an explosion.
- Wear eye protection and rubber gloves when handling the battery to avoid risk of burns or loss of eyesight if exposed to battery electrolyte.
- Do not allow children to handle the battery, under any circumstance. Ensure that anyone handling the battery has a proper understanding of the hazards and correct handling procedures involved.
- Handle battery electrolyte with extreme care, as it contains dilute sulfuric acid. Exposure to eyes or skin can cause burns or loss of eyesight.
- Read this manual carefully, and understand it before handling the battery. Failure to do so can cause personal injury and damage to the vehicle.
- Do not use the battery if the level of electrolyte is at or below the recommended level. Using the battery with low electrolyte can cause it to explode, causing serious injury.

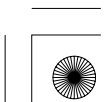
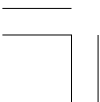

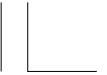

**BATTERY LABEL**



**FUEL/SAFETY REMINDER LABEL**

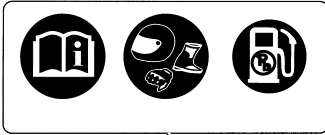

**ACG CABLE LABEL**

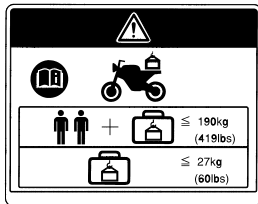
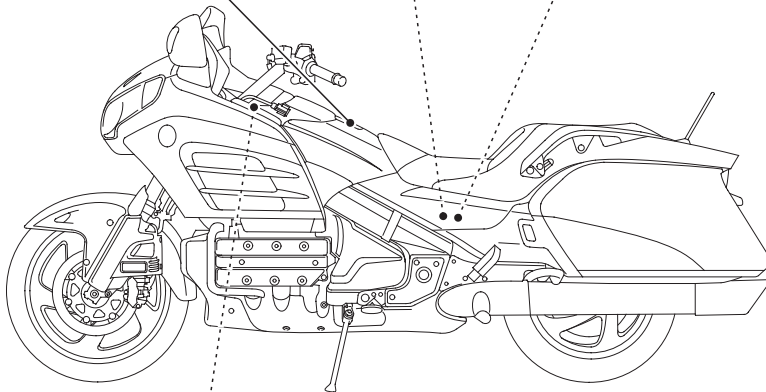

**ACCESSORIES AND LOADING WARNING LABEL**





# MOTORCYCLE SAFETY

**CARGO LIMIT LABEL**

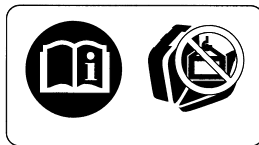
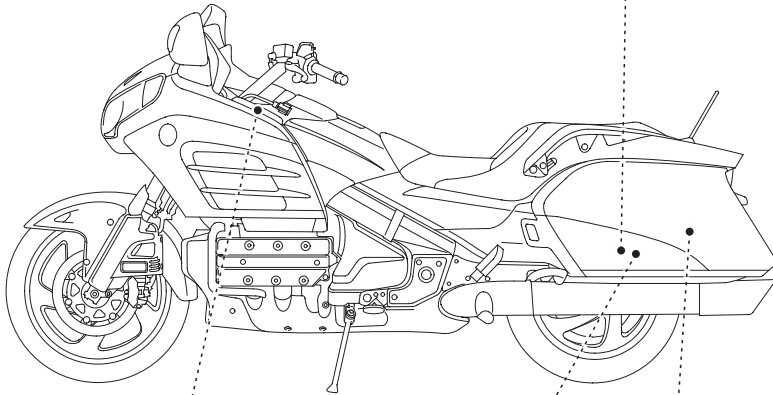
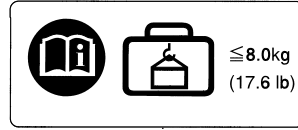

**SADDLEBAG LABEL**

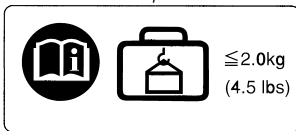

**CARGO LIMIT LABEL**

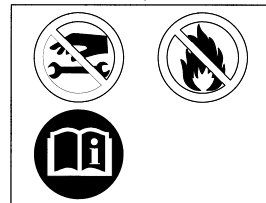





**SADDLEBAG DAMPER LABEL**







### TYRE INFORMATION LABEL

  kPa	 250    280	 130/70R18M/C 63H	BRIDGESTONE G709 RADIAL
			 180/60R16M/C 74H

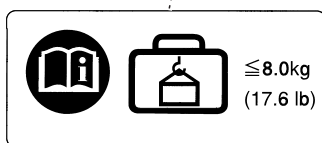
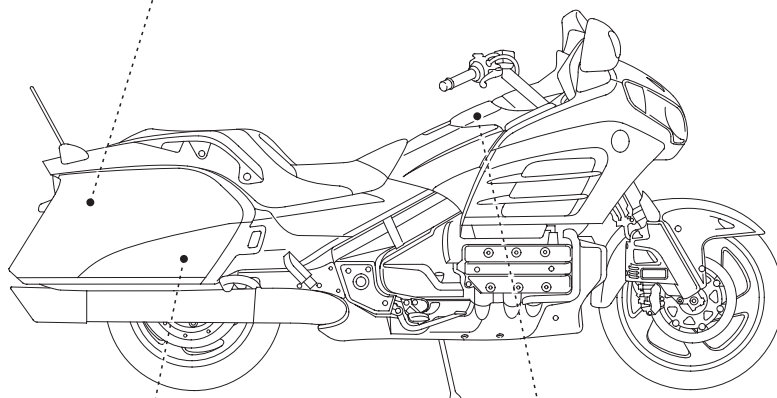

**CARGO LIMIT LABEL**

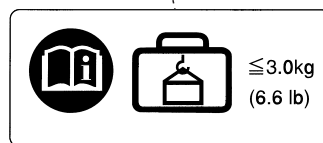

**CARGO LIMIT LABEL**

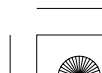

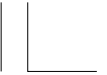

# MOTORCYCLE SAFETY

---

**REAR CUSHION LABEL**



**RADIATOR CAP LABEL**

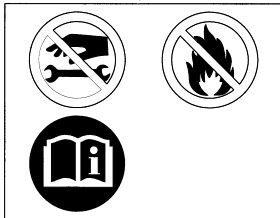
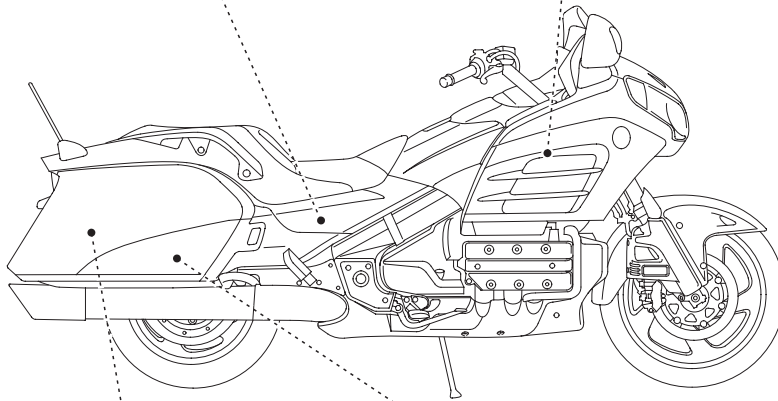

**SADDLEBAG DAMPER LABEL**

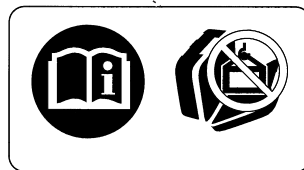

**SADDLEBAG LABEL**

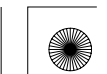



---

## **SAFETY LABELS**

### **KO, SI type**

The following pages show the locations of safety labels on your motorcycle. Some labels warn you of potential hazards that could cause serious injury. Others provide important safety information. Read these labels carefully and don't remove them.

If a label comes off or becomes hard to read, contact your dealer for a replacement.

**SAFETY REMINDER LABEL**

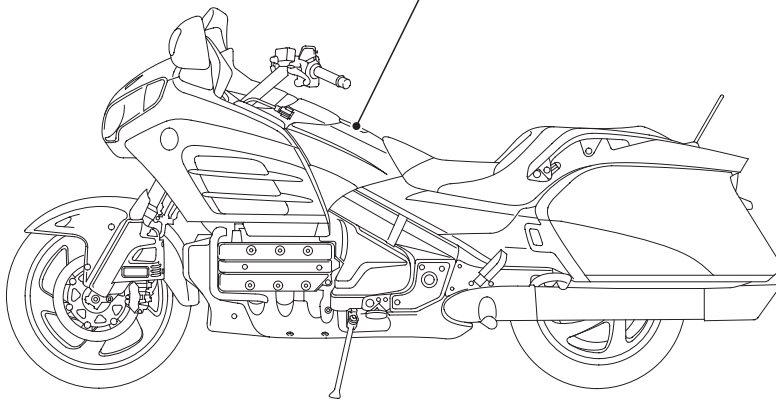

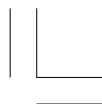

# MOTORCYCLE SAFETY

---

For SI type

Cargo Limit

8.0 kg / 17.6 lbs

For KO type

CARGO LIMIT

9.0 kg / 20.0 lbs

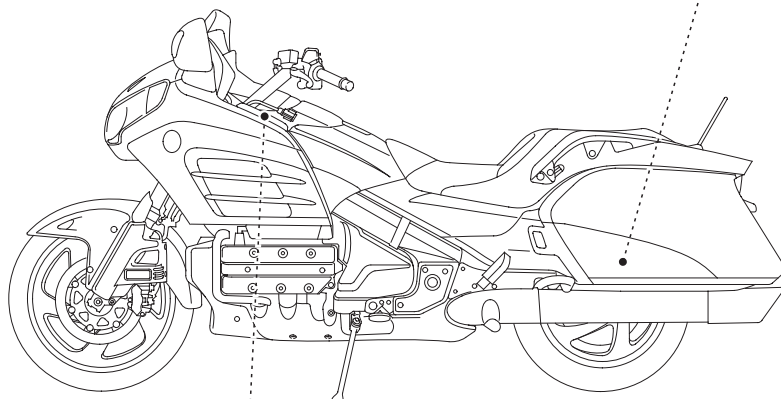

CARGO LIMIT

2.0 kg / 4.5 lbs





**TYRE INFORMATION LABEL**

Cargo Limit  
3.0kg / 6.6lbs

**RADIATOR CAP LABEL**

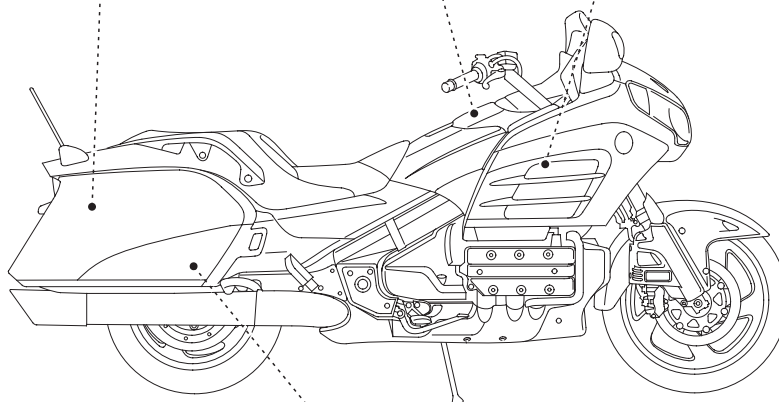

For SI type

Cargo Limit  
8.0kg / 17.6lbs

For KO type

CARGO LIMIT  
9.0kg / 20.0lbs





# PARTS LOCATION

---

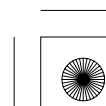
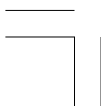
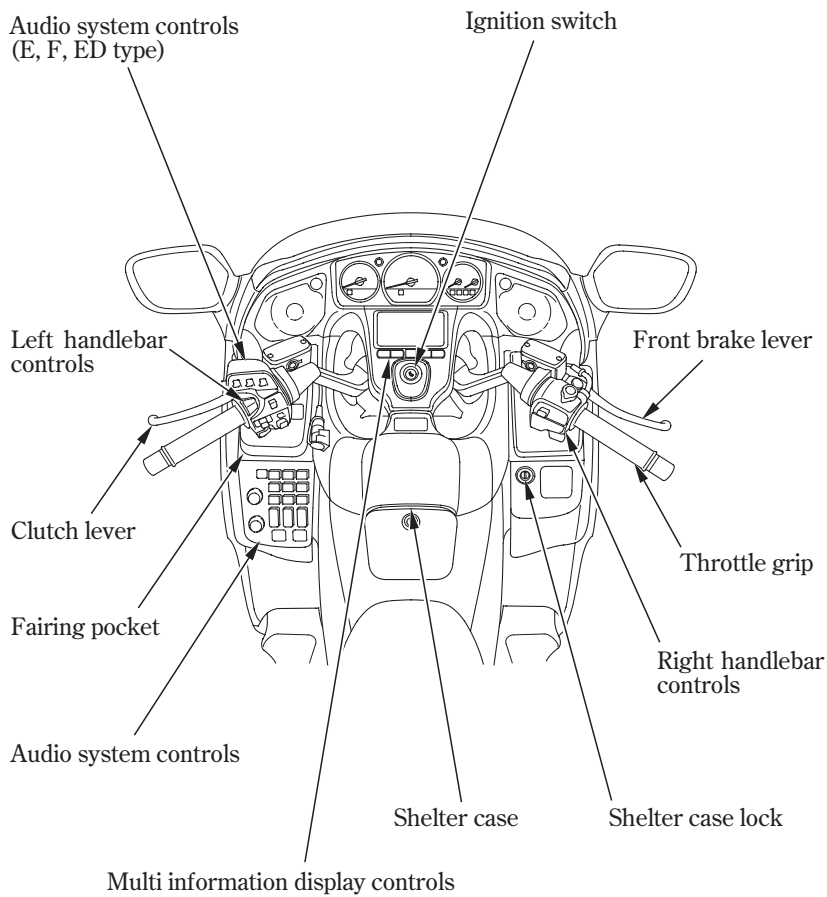

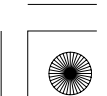
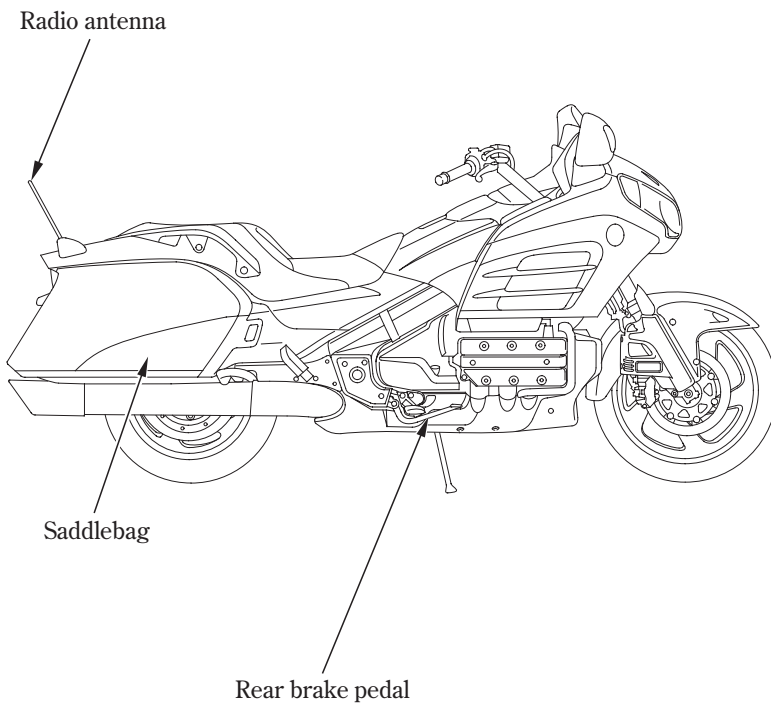

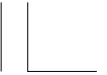

# PARTS LOCATION

---

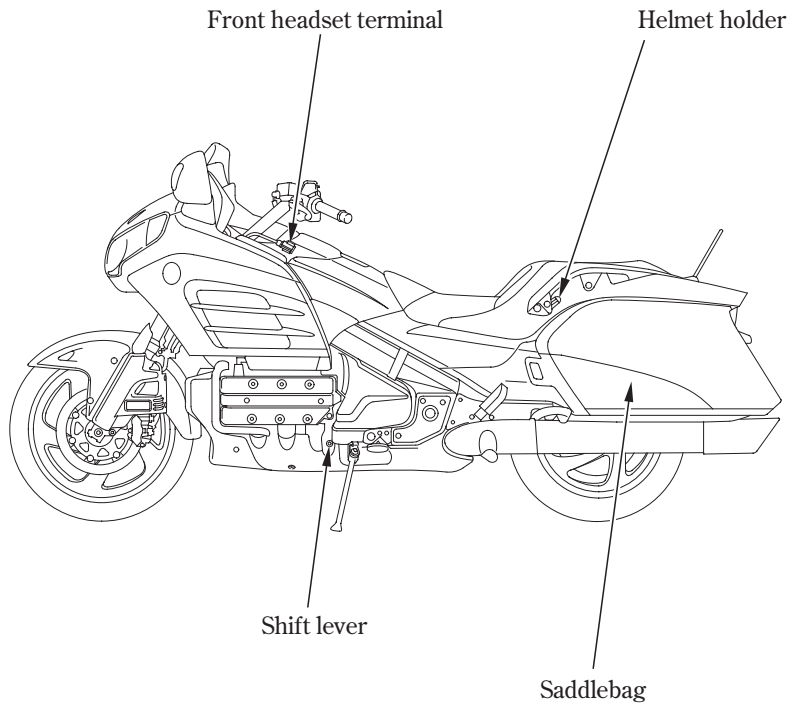



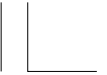

---

## INSTRUMENTS AND INDICATORS

The indicators and warning lights are incorporated in the instrument panel. Their functions are described on the following pages.

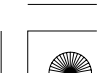
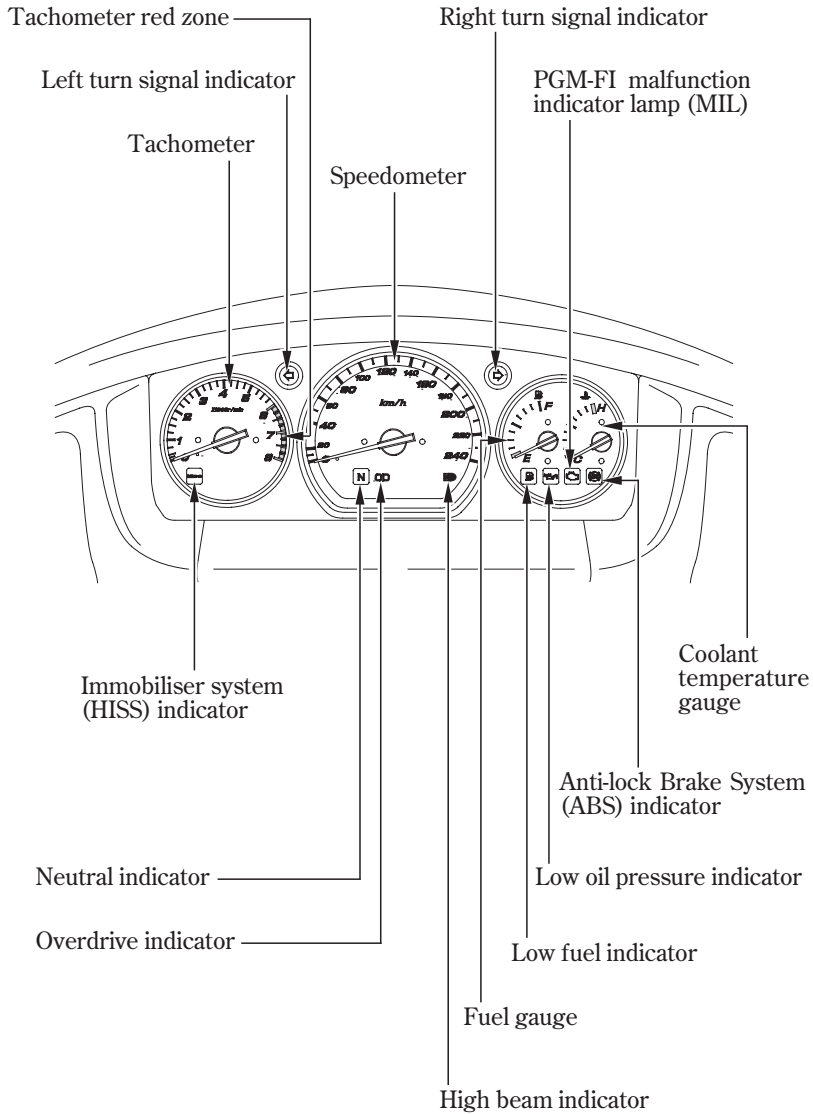



# PARTS LOCATION



Speedometer

Shows riding speed.

This shows your speed in kilometers per hour (km/h) and/or miles per hour (mph) depending on the type.



Tachometer

Shows engine speed in revolutions per minute.



Tachometer red zone

Never allow the tachometer needle to enter the red zone, even after the engine has been broken in.

**NOTICE**

Running the engine beyond recommended maximum engine speed (the beginning of the tachometer red zone) can damage the engine.



Turn signal indicators (green)

Flashes when a turn signal operates.



Neutral indicator (green)

Lights when the transmission is in neutral.



**OD**

Overdrive indicator (orange)

Lights when the transmission is in overdrive (5th gear).



Low oil pressure indicator (red)

Lights when the engine oil pressure is below normal operating range. Should light when ignition switch is ON and engine is not running. Should go out when the engine starts, except for occasional flickering at or near idling speed when engine is warm.

**NOTICE**

Running the engine with insufficient oil pressure may cause serious engine damage.

PGM-FI malfunction indicator lamp (MIL)  
(orange)

Lights when there is any abnormality in the PGM-FI (Programmed Fuel Injection) system. Should also light for a few seconds and then go off when the ignition switch is turned ON and engine stop switch is at  (RUN). If the indicator comes on at any other time, reduce speed and take the motorcycle to your dealer as soon as possible.

Anti-lock Brake System  
(ABS) indicator  
(orange)

This light normally comes on when the ignition is turned ON, and goes off after you ride the motorcycle at speed above 10 km/h (6 mph). If there is a problem with the Anti-lock Brake System, this light flashes and remains on (page 120).

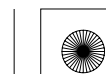



# PARTS LOCATION



High beam indicator (blue)

Lights when the headlight is on high beam.



Immobilizer system  
(HISS) indicator  
(red)

This indicator lights for a few seconds when the ignition switch is turned ON and the engine stop switch is at  (RUN). It will then go off if the properly-coded key has been inserted. If an improperly-coded key has been inserted, the indicator will remain on and the engine will not start (page 55 ).



Low fuel indicator (orange)

Lights when there is only few fuel left in the fuel tank. Amount of fuel left in the tank with the vehicle set upright is approximately;  
4.4 ℓ (1.16 US gal , 0.97 Imp gal)



Fuel gauge

Shows approximate fuel supply available (page 27 ).



Coolant temperature gauge

Shows engine coolant temperature (page 27 ).





---

### Fuel Gauge

When the gauge needle enters the red band, fuel will be low and you should refill the tank as soon as possible.

The amount of fuel left in the tank when the needle enters the red band and with the vehicle set upright is approximately:

3.0 ℓ (0.79 US gal , 0.66 Imp gal)

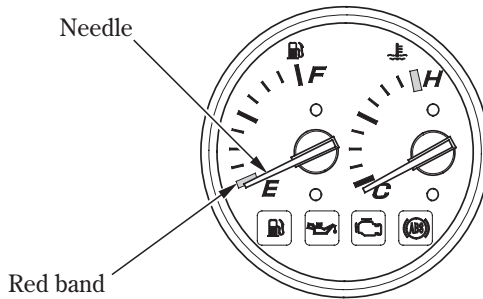

### Coolant Temperature Gauge

When the needle begins to move above the C (Cold) mark, the engine is warm enough for the motorcycle to be ridden. The normal operating temperature range is within the section between the H and C marks. If the needle reaches the H (Hot) mark, stop the engine and check the reserve tank coolant level. Read pages 42 – 43 and do not ride the motorcycle until the problem has been corrected.

### NOTICE

Exceeding maximum running temperature may cause serious engine damage.

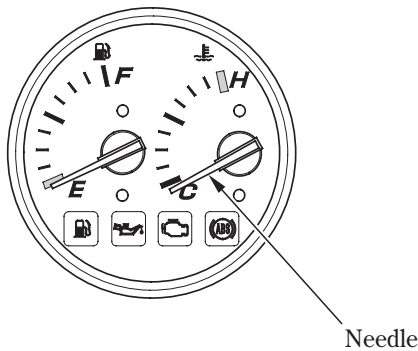



## PARTS LOCATION

---

### MULTI INFORMATION DISPLAY

Your motorcycle is equipped with a Multi Information Display that presents various displays. This section explains display functions and operations.

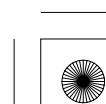
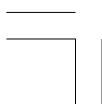
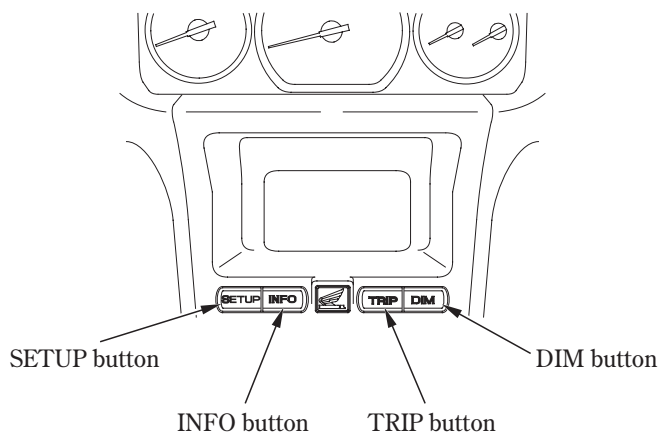



---

### Opening/Ending Ceremony

When the ignition switch is turned ON or ACC, the display presents an “opening ceremony”.

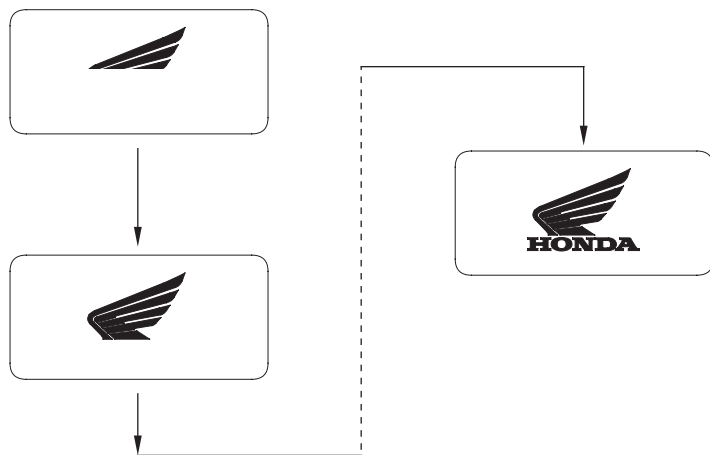

When the ignition switch is turned OFF, the display presents an “ending ceremony”.

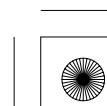
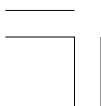
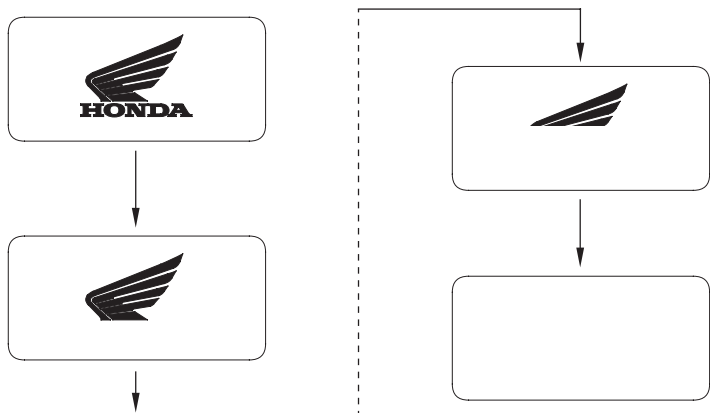



## PARTS LOCATION

---

The opening/ending ceremony can be turned off.

1. Push the SETUP button to show the CLOCK ADJUST display.
2. Push the DIM button to show the OPENING/ENDING CEREMONY display.
3. Push the TRIP or INFO button to switch ON/OFF.
4. Push the SETUP button to fix the setting.

When approximately 5 seconds pass without operating a button on the OPENING/ENDING CEREMONY display, the display automatically returns to the previous display.

### Ceremony Display ON

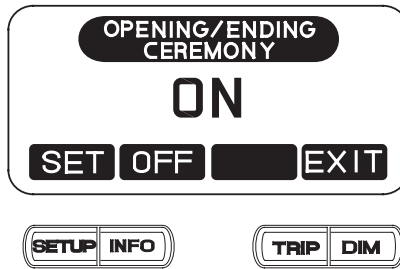

### Ceremony Display OFF

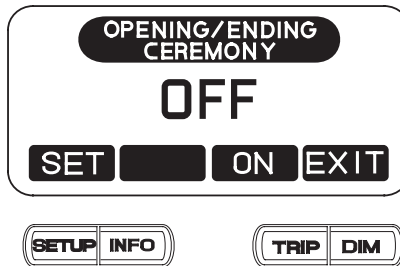





### Odometer/Tripmeter

- ODO (Odometer) — shows the total miles (For E type) or kilometer (Except E type) ridden.
- TRIP (Tripmeter) — shows the number of miles (For E type) or kilometer (Except E type) ridden.

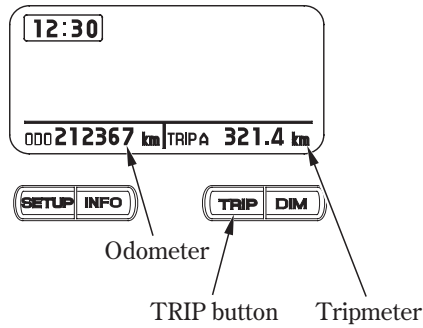

The tripmeter will show mileage in two sub modes, “TRIP A” and “TRIP B.” Push the TRIP button to select the “TRIP A” or “TRIP B” mode.



To reset the tripmeter, push and hold the TRIP button with the display in the “TRIP A” or “TRIP B” mode.



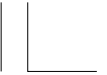

# PARTS LOCATION

---

## Display Illumination Adjustment

To adjust the brightness of the display:

Push the DIM button once. "DIMMER" will display.

- To brighten the display — push the TRIP button (+).
- To darken the display — push the INFO button (-).  
(The brighter and darker ranges each have six steps.)
- To set the selected step — push the SETUP button.

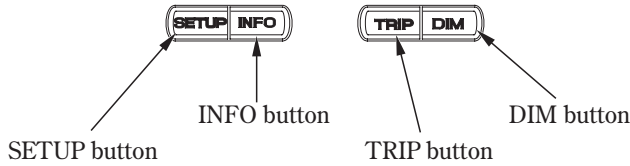
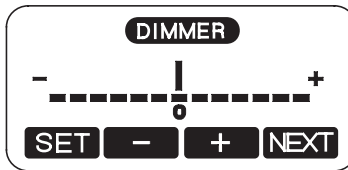

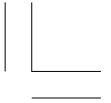

---

### Digital Clock

The display shows the hour and minute.

To adjust the time:

1. Turn the ignition switch to ON or ACC.
2. Push the SETUP button once. "CLOCK ADJUST" will display.
3. To set the hour, press and release the INFO button until the desired hour appears.
  - Quick setting — push and hold the INFO button until the desired hour appears.
4. To set the minute, press and release the TRIP button until the desired minute appears.
  - Quick setting — push and hold the TRIP button until the desired minute appears.
5. Once the time is selected, push the SETUP button to enter the time.

When approximately 5 seconds pass without operating a button on the CLOCK ADJUST display, the display automatically returns to the previous display.

Be sure to push the SETUP button to enter your adjusted time in the system.

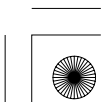
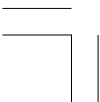
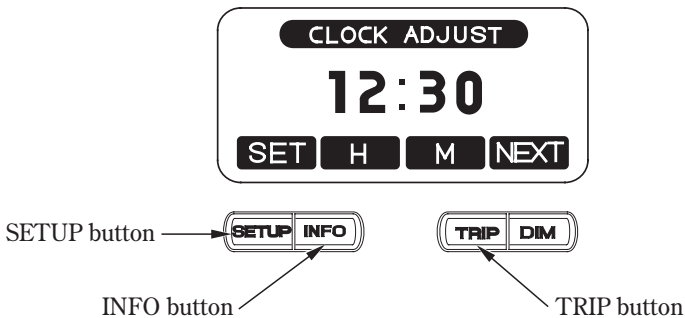



## PARTS LOCATION

---

### Air Temperature Meter

Push the INFO button once to display the air temperature.

After 5 seconds, the previous display returns.

### Temperature Display

Below $-11^{\circ}\text{C}$	“ — ” is displayed.
Between: $-10^{\circ}\text{C}$ — $50^{\circ}\text{C}$	Actual air temperature is indicated.
Above $50^{\circ}\text{C}$	The display will remain “ $50^{\circ}\text{C}$ ”.

The temperature sensor is located in the upper fairing. The temperature reading can be affected by heat reflecting from the road surface, engine heat, and the exhaust from surrounding traffic. This can cause an error in the temperature reading when your speed is under 30 km/h (19 mph).



**23°C**



↑  
INFO button

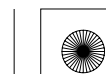



---

### Saddlebags Open Indicator

This indicator turns on when the ignition switch is ON and your motorcycle's saddlebags are open.

If saddlebag(s) are not fully closed, the display will blink OPEN and indicate the open saddlebag(s).

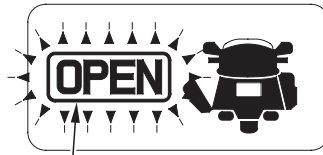

Open indicator

### Saddlebag Open





# MAJOR COMPONENTS

## (Information you need to operate this motorcycle)

---

### REAR SUSPENSION

#### Spring Preload:

The spring preload adjuster is located behind the right side cover.

The spring preload adjuster knob has 35 spring preload positions (clicks) or more for different load or riding conditions.

To adjust the spring preload, turn the adjuster knob.

To reduce (LOW) :

Turn the adjuster counterclockwise toward LOW for a light load and smooth road condition.

To increase (HIGH) :

Turn the adjuster clockwise toward HIGH for a firmer ride and rough road condition.

To adjust to the standard position:

1. Remove the right side cover (page138).
2. Turn the spring preload adjuster knob counterclockwise until it will no longer turn (lightly seats).  
This is the full LOW setting.  
Turn the adjuster clockwise for 1 click. This is the standard position.

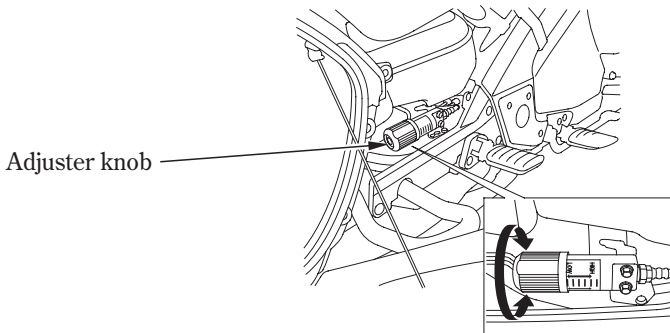

The rear shock absorber assembly includes a damper unit that contains high pressure nitrogen gas. Do not attempt to disassemble or service the damper; it cannot be rebuilt and must be replaced when worn out. Disposal should only be done by your dealer. The instructions found in this owner's manual are limited to adjustment of the shock assembly only.





---

## **BRAKES**

Both the front and rear brakes are the hydraulic disc types.

As the brake pads wear, the brake fluid level drops.

There are no adjustments to perform, but fluid level and pad wear must be inspected periodically. The system must be inspected frequently to ensure there are no fluid leaks. If the control lever or pedal free travel becomes excessive and the brake pads are not worn beyond the recommended limit (page 162 ), there is probably air in the brake system and it must be bled. See your dealer for this service.

### Front Brake Fluid Level:

With the motorcycle in an upright position, check the fluid level. It should be above the LOWER level mark. If the level is at or below the LOWER level mark, check the brake pads for wear (page 162 ).

Worn pads should be replaced. If the pads are not worn, have your brake system inspected for leaks.

The recommended brake fluid is Honda DOT 4 brake fluid from a sealed container, or an equivalent.

LOWER level mark

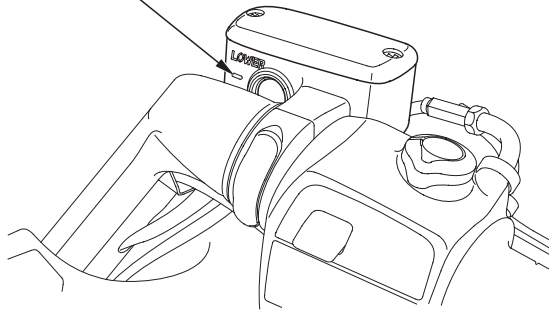



## MAJOR COMPONENTS (Information you need to operate this motorcycle)

---

The distance between the tip of the brake lever and the grip can be adjusted.

1. Turn the adjuster dial while pushing the brake lever forward.
2. Align the index mark on the brake lever with the numbers on the adjuster dial.
3. Apply the brake, release it, then spin the wheel and check that it rotates freely. Repeat this procedure several times.

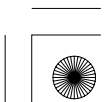
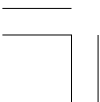
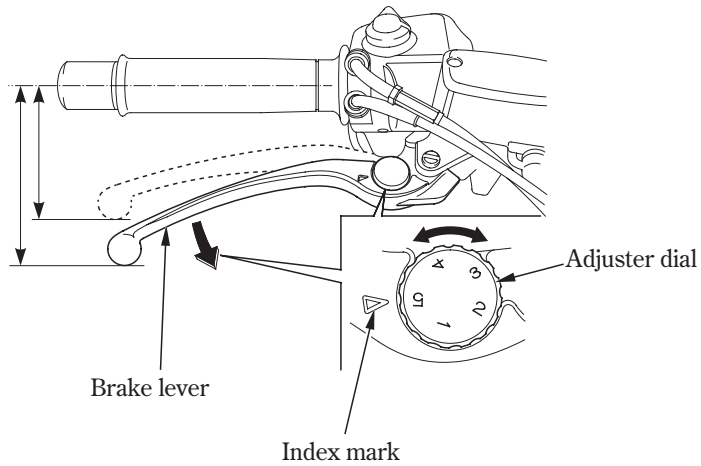



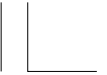

---

**Rear Brake Fluid Level:**

With the motorcycle in an upright position, check the fluid level. It should be between the UPPER and LOWER level marks. If the level is at or below the LOWER level mark, check the brake pads for wear (page 162 ).

Worn pads should be replaced. If the pads are not worn, have your brake system inspected for leaks.

The recommended brake fluid is Honda DOT 4 brake fluid from a sealed container, or an equivalent.

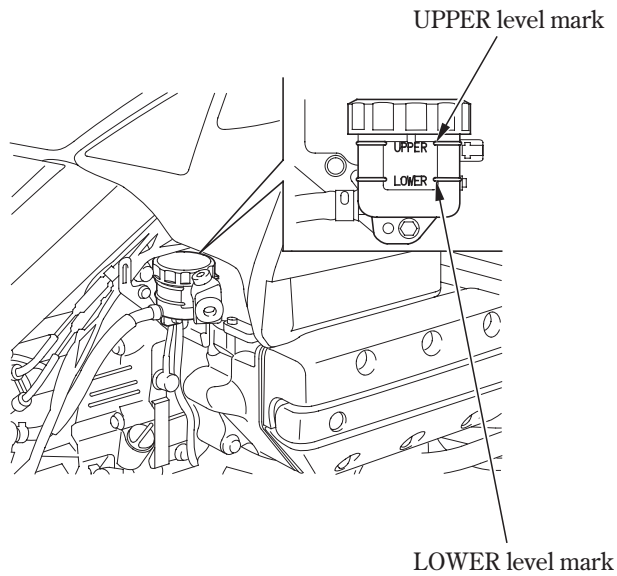

**Other Checks:**

Make sure there are no fluid leaks. Check for deterioration or cracks in the hoses and fittings.





## MAJOR COMPONENTS (Information you need to operate this motorcycle)

---

### CLUTCH

This motorcycle has a hydraulically actuated clutch. There are no adjustments to perform, but the clutch system must be inspected periodically for fluid level and leakage.

If the motorcycle creeps or stalls when shifted into gear, or if the clutch slips, causing acceleration to lag behind engine speed, there is probably air in the clutch system and it must be bled out. See your dealer for this service.

#### Fluid Level:

Check that the fluid level is above the LOWER level mark. If the fluid level is near the LOWER level mark, it indicates fluid leakage. See your dealer for repair.

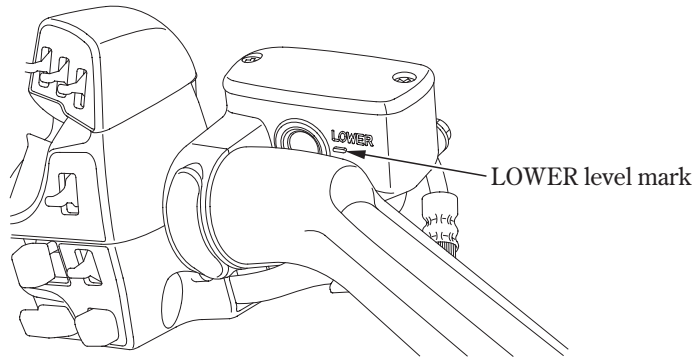

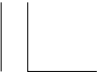

---

The distance between the tip of the clutch lever and the grip may be adjusted.

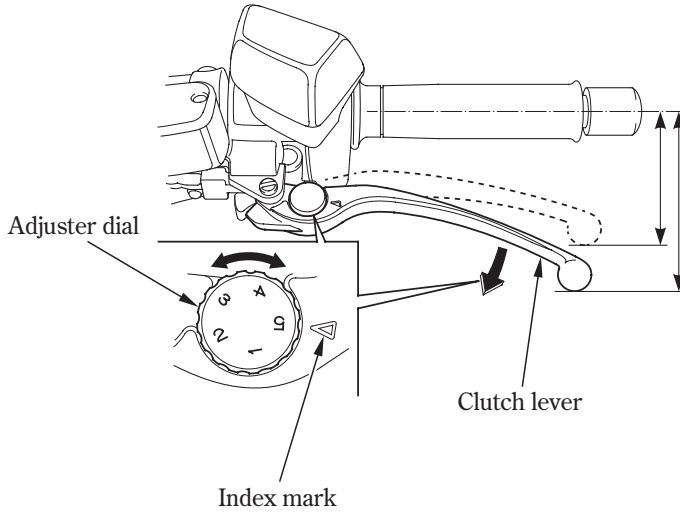

1. Turn the adjuster dial while pushing the clutch lever forward.
2. Align the index mark on the clutch lever with the numbers on the adjuster dial.
3. Start the engine, pull in the clutch lever and shift into gear. Make sure the engine does not stall and the motorcycle does not creep. Gradually release the clutch lever and open the throttle. The motorcycle should begin to move smoothly and accelerate gradually.

Other Checks:

Make sure there are no fluid leaks. Check for deterioration or cracks in the hoses and fittings.

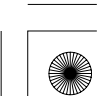



## **MAJOR COMPONENTS**

### **(Information you need to operate this motorcycle)**

---

#### **COOLANT**

##### **Coolant Recommendation**

The owner must properly maintain the coolant to prevent freezing, overheating, and corrosion. Use only high quality ethylene glycol antifreeze containing corrosion protection inhibitors specifically recommended for use in aluminum engines. (SEE ANTIFREEZE CONTAINER LABEL).

Use only low-mineral drinking water or distilled water as a part of the antifreeze solution. Water that is high in mineral content or salt may be harmful to the aluminum engine.

Using coolant with silicate inhibitors may cause premature wear of water pump seals or blockage of radiator passages.

Using tap water may cause engine damage.

The factory provides a 50/50 solution of antifreeze and distilled water in this motorcycle. This coolant solution is recommended for most operating temperatures and provides good corrosion protection. A higher concentration of antifreeze decreases the cooling system performance and is recommended only when additional protection against freezing is needed. A concentration of less than 40/60 (40% antifreeze) will not provide proper corrosion protection. During freezing temperatures, check the cooling system frequently and add higher concentrations of antifreeze (up to a maximum of 60% antifreeze) if required.

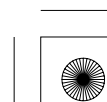
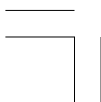



---

### Inspection

The reserve tank is behind the left engine side cover.  
Remove the left engine side cover (page 139 ).

Check the coolant level in the reserve tank while the engine is at normal operating temperature with the motorcycle in an upright position. Add coolant to the reserve tank as required to bring coolant level to the UPPER level mark. Always add coolant to the reserve tank. Do not attempt to add coolant by removing the radiator cap.

If the reserve tank is empty, or if coolant loss is excessive, check for leaks and see your dealer for repair.

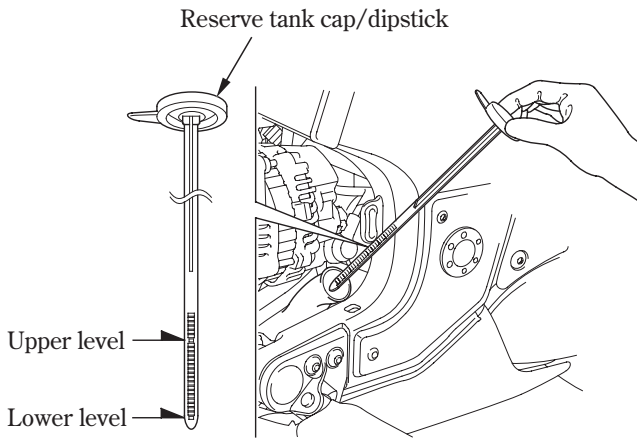



# MAJOR COMPONENTS

## (Information you need to operate this motorcycle)

---

### FUEL

#### Fuel Tank

The fuel tank capacity including the reserve supply is:

25 ℓ (6.6 US gal , 5.5 Imp gal)

To open the fuel fill cap, insert the ignition key and turn it clockwise to open the fuel filler lid. Turn the fuel fill cap counterclockwise to remove it.

Do not overfill the tank. There should be no fuel in the filler neck.

After refueling, be sure to tighten the fuel fill cap firmly by turning it clockwise until it clicks.

Close the fuel fill lid.

Remove the key from the fuel fill lid.

### **⚠ WARNING**

Petrol is highly flammable and explosive. You can be burned or seriously injured when handling fuel.

- Stop the engine and keep heat, sparks, and flame away.
- Refuel only outdoors.
- Wipe up spills immediately.

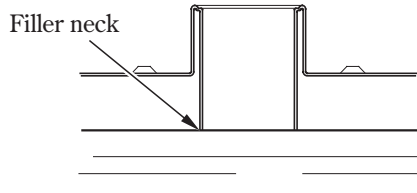
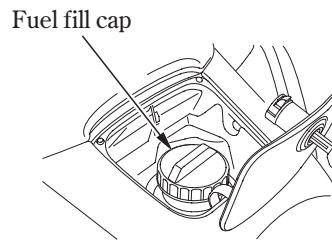
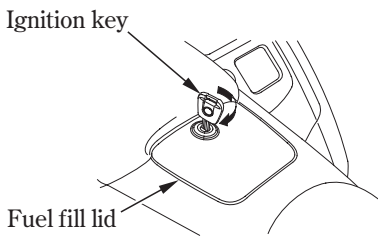



---

Use unleaded petrol with a research octane number of 91 or higher.  
The use of leaded petrol will cause premature damage to the catalytic converter.

Occasionally you may experience light spark knock while operating under heavy loads. This is no cause for concern, it simply means your engine is operating efficiently.

**NOTICE**

If “spark knock” or “pinking” occurs at a steady engine speed under normal load, change brands of petrol. If spark knock or pinking persists, consult your dealer. Failure to do so is considered misuse, and damage caused by misuse is not covered by Honda’s Limited Warranty.

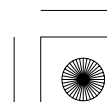
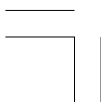



## **MAJOR COMPONENTS**

### **(Information you need to operate this motorcycle)**

---

#### **Petrol Containing Alcohol**

If you decide to use a petrol containing alcohol (gasohol), be sure it's octane rating is at least as high as that recommended by Honda. There are two types of "gasohol": one containing ethanol, and the other containing methanol. Do not use petrol that contains more than 10 % ethanol. Do not use petrol containing methanol (methyl or wood alcohol) that does not also contain cosolvents and corrosion inhibitors for methanol. Never use petrol containing more than 5 % methanol, even if it has cosolvents and corrosion inhibitors.

The use of petrol containing more than 10 % ethanol (or more than 5 % methanol) may:

- Damage the painting of the fuel tank.
- Damage the rubber tubes of the fuel line.
- Cause corrosion of the fuel tank.
- Cause poor drivability.

Before buying fuel from an unfamiliar station, try to find out if the fuel contains alcohol. If it does, confirm the type and percentage of alcohol used. If you notice any undesirable operating symptoms while using a petrol that contains alcohol, or one that you think contains alcohol, switch to a petrol that you know does not contain alcohol.







---

## ENGINE OIL

### Engine Oil Level Check

Check engine oil level each day before operating the motorcycle.

#### To Check the Oil Level:

1. Remove the right engine side cover (page 139 ).
2. Start the engine and let it idle for 3–5 minutes.
3. Stop the engine and hold the motorcycle in an upright position on a firm, level ground.
4. After 2–3 minutes, remove the oil fill cap/dipstick, wipe it clean, and reinsert the oil fill cap/dipstick without screwing it in. Remove the oil fill cap/dipstick. The oil level should be between the upper and lower level marks on the oil fill cap/dipstick.
5. If required, add the specified oil up to the upper level mark. Do not overfill.
6. Reinstall the oil fill cap/dipstick, and the right engine side cover.

#### **NOTICE**

Running the engine with insufficient oil can cause serious engine damage.



Oil fill cap/dipstick

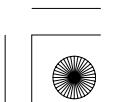
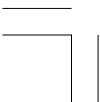
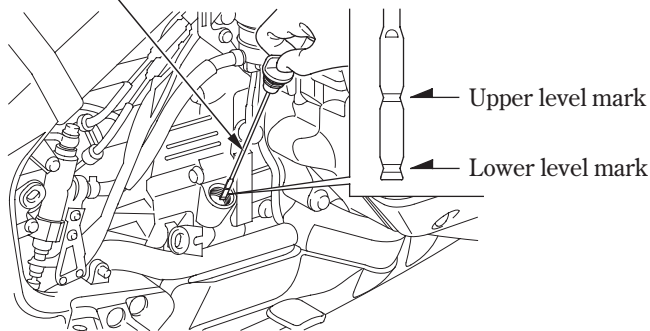



# MAJOR COMPONENTS

## (Information you need to operate this motorcycle)

---

### TUBELESS TYRES

To safely operate your motorcycle, your tyres must be the proper type and size, in good condition with adequate tread, and correctly inflated for the load you are carrying. The following pages give more detailed information on how and when to check your air pressure, how to inspect your tyres for damage, and what to do when your tyres need to be repaired or replaced.

### **WARNING**

Using tyres that are excessively worn or improperly inflated can cause a crash in which you can be seriously hurt or killed.

Follow all instructions in this owner's manual regarding tyre inflation and maintenance.

### **Air Pressure**

Keeping your tyres properly inflated provides the best combination of handling, tread life and riding comfort. Generally, underinflated tyres wear unevenly, adversely affect handling, and are more likely to fail from being overheated. Overinflated tyres make your motorcycle ride harshly, are more prone to damage from road hazards, and wear unevenly.

We recommend that you visually check your tyres before every ride and use a gauge to measure air pressure at least once a month or any time you think the tyres might be low.

Tubeless tyres have some self-sealing ability if they are punctured. However, because leakage is often very slow, you should look closely for punctures whenever a tyre is not fully inflated.





---

Always check air pressure when your tyres are “cold” – when the motorcycle has been parked for at least three hours. If you check air pressure when your tyres are “warm” – when the motorcycle has been ridden for even a few kilometers – the readings will be higher than if the tyres were “cold”. This is normal, so do not let air out of the tyres to match the recommended cold air pressures given below. If you do, the tyres will be underinflated.

The recommended “cold” tyre pressures are:

Front	250 kPa (2.50 kgf/cm <sup>2</sup> , 36 psi)
Rear	280 kPa (2.80 kgf/cm <sup>2</sup> , 41 psi)

### Inspection

Whenever you check the tyre pressures, you should also examine the tyre treads and sidewalls for wear, damage, and foreign objects:

Look for:

- Bumps or bulges in the side of the tyre or the tread. Replace the tyre if you find any bumps or bulges.
- Cuts, splits or cracks in the tyre. Replace the tyre if you can see fabric or cord.
- Excessive tread wear.

Also, if you hit a pothole or hard object, pull to the side of the road as soon as you can safely and carefully inspect the tyres for damage.





## MAJOR COMPONENTS (Information you need to operate this motorcycle)

---

### Tread Wear

Replace tyres before tread depth at the centre of the tyre reaches the following limit:

Minimum tread depth	
Front	1.5 mm (0.06 in)
Rear	2.0 mm (0.08 in)

< For Germany >

German law prohibits use of tyres whose tread depth is less than 1.6 mm.

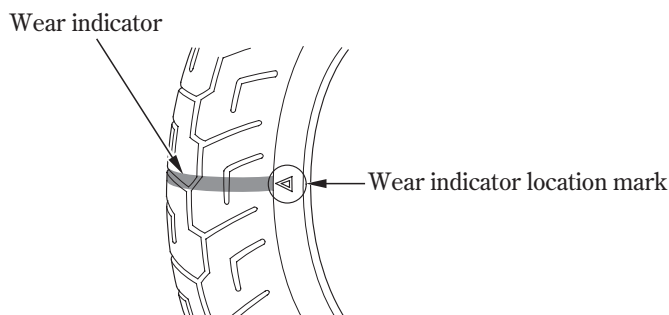

### Tyre Repair

If a tyre is punctured or damaged, you should replace it, not repair it. As discussed below, a tyre that is repaired, either temporarily or permanently, will have lower speed and performance limits than a new tyre.

A temporary repair, such as an external tubeless tyre plug, may not be safe for normal speeds and riding conditions. If a temporary or emergency repair is made to a tyre, you should ride slowly and cautiously to a dealer and have the tyre replaced. If possible, you should not carry a passenger or cargo until a new tyre is installed.

Even if a tyre is professionally repaired with a permanent internal patch plug, it will not be as good as a new tyre. You should not exceed 80 km/h (50 mph) for the first 24 hours, or 130 km/h (80 mph) at any time thereafter. In addition, you may not be able to safely carry as much weight as with a new tyre. Therefore, we strongly recommend that you replace a damaged tyre. If you choose to have a tyre repaired, be sure the wheel is balanced before you ride.

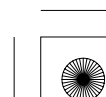



### Tyre Replacement

The tyres that came on your motorcycle were designed to match the performance capabilities of your motorcycle and provide the best combination of handling, braking, durability and comfort.

<b>⚠ WARNING</b>	
<p>Installing improper tyres on your motorcycle can affect handling and stability. This can cause a crash in which you can be seriously hurt or killed.</p> <p>Always use the size and type of tyres recommended in this owner's manual.</p>	

The recommended tyres for your motorcycle are:

Front	130/70R18M/C 63H
	BRIDGESTONE G709 RADIAL
Rear	180/60R16M/C 74H
	BRIDGESTONE G704 RADIAL
Type	radial, tubeless

Whenever you replace a tyre, use one that is equivalent to the original and be sure the wheel is balanced after the new tyre is installed.





## MAJOR COMPONENTS (Information you need to operate this motorcycle)

---

### Important Safety Reminders

- Do not install a tube inside a tubeless tyre on this motorcycle. Excessive heat build-up can cause the tube to burst.
- Use only tubeless tyres on this motorcycle. The rims are designed for tubeless tyres, and during hard acceleration or braking, a tube-type tyre could slip on the rim and cause the tyre to rapidly deflate.
- Do not install a bias-ply tyre on this motorcycle. Mixing bias-ply and radial tyres can adversely affect handling and stability.
- Do not install car tyres on this motorcycle. During installation the tyre may separate from the rim with enough force to cause serious injury or death.
- When replacing tyres, use only the recommended tyres as shown above and on the tyre information label. Use of other tyres on the model equipped with ABS may impair proper ABS function.

The ABS computer works by comparing wheel speed.

Non-recommended tyres can affect wheel speed and may confuse the ABS computer.

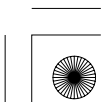
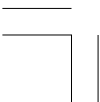



# ESSENTIAL INDIVIDUAL COMPONENTS

## IGNITION SWITCH

The ignition switch is on the handlebar cover.

Key Position	Function	Key Removal
ACC	Only the accessory circuits function.	cannot be removed
ON	Electrical circuits on.	cannot be removed
OFF	No electrical circuits function.	can be removed
LOCK (steering lock)	No electrical circuits function. Locks the steering head.	can be removed

If your motorcycle is stopped with the ignition switch ON and the engine stop switch ☒ (OFF), the headlight and taillight will still be on, resulting in battery discharge.

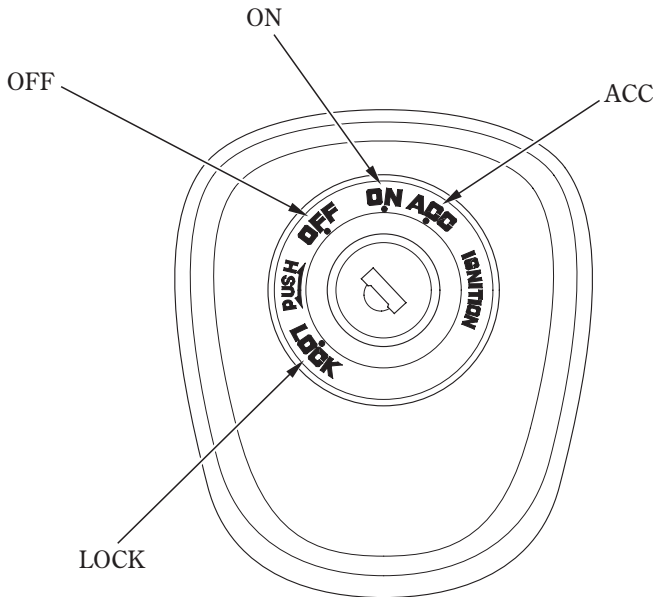



## ESSENTIAL INDIVIDUAL COMPONENTS

---

### KEYS

This motorcycle has two keys and a key number plate.

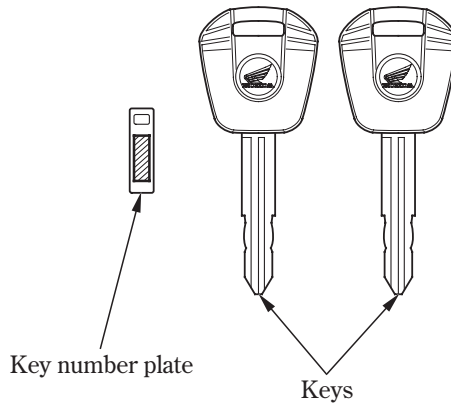

You will need the key number if you ever have to replace a key. Store the plate in a safe place.



To reproduce keys, bring all keys, key number plate and motorcycle to your dealer.

Up to four keys can be registered with the immobilizer system (HISS), including the ones in hand.

If all keys are lost, the PGM-FI unit/ignition control module must be replaced. To avoid this possibility we recommend that if only one key is left, you immediately have it reproduced to ensure that a back-up is available.

These keys contain electronic circuits that are activated by the immobilizer system (HISS). They will not work to start the engine if the circuits are damaged.

- Do not drop the keys or set heavy objects on them.
- Do not grind, drill or in any way alter the original shape of the keys.
- Keep the keys away from magnetic objects.

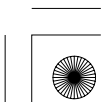
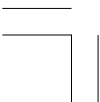





---

## IMMOBILIZER SYSTEM (HISS)

HISS is the abbreviation of Honda Ignition Security System.

The immobilizer system (HISS) protects your motorcycle from theft. A properly-coded key must be used in the ignition switch for the engine to start. If an improperly-coded key (or other device) is used the engine's starting circuit is disabled.

When the ignition switch is turned ON and the engine stop switch is at “” (RUN), the immobilizer system (HISS) indicator lights for a few seconds, then goes off. If the indicator remains on, it means the system does not recognize the coding of the key. Turn the ignition switch to OFF, remove the key, reinsert and turn the switch ON again.

When the ignition switch is turned OFF, the immobilizer system (HISS) indicator continues to flash every 2 seconds during 24 hours. After this period, the indicator automatically switches off.

To operate this function, proceed as follows:

1. Turn the ignition switch ON or ACC.
2. Push the SETUP button and push the DIM button. Push the INFO or TRIP button to select ON or OFF. Be sure to push the SETUP button to enter your setting in the system.
3. Turn the ignition switch OFF.

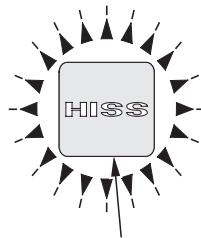
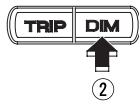
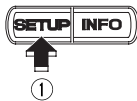

Immobilizer system (HISS) indicator





## ESSENTIAL INDIVIDUAL COMPONENTS

---

Whenever the ignition switch is turned ON, the light operation is canceled.

When approximately 5 seconds past without operating a button, the display automatically returns to the previous display.

If the system repeatedly does not recognize the coding of your key, contact your dealer.

- The system may not recognize the key's coding if any other immobilizer key is near the ignition switch. To make sure the system recognizes the key code, keep each immobilizer key on a separate ring.
- Do not attempt to alter the immobilizer system (HISS) or add other devices to it. Electrical problems could result, making it impossible to start your motorcycle.
- If all keys are lost, the PGM-FI unit/ignition control module must be replaced.

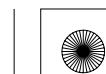



EC Directives

This immobilizer system complies with the R & TTE (Radio equipment and telecommunications terminal equipment and the mutual recognition of their conformity) Directive.



The declaration of conformity to R & TTE Directive is provided to the owner at the time of purchase. The declaration of conformity should be kept at a safe place. When the declaration of conformity is lost or is not provided, contact your dealer.

(South Africa only)



(Singapore only)



(Morocco only)

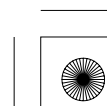
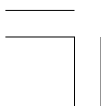





# ESSENTIAL INDIVIDUAL COMPONENTS

---

## RIGHT HANDLEBAR CONTROLS

### Engine Stop Switch

The three position engine stop switch is next to the throttle grip. When the switch is in the  (RUN) position, the engine will operate. When the switch is in either  (OFF)-position, the engine will not operate. This switch is intended primarily as an emergency switch and should normally remain in the  (RUN) position.

### Start Button

The start button is below the engine stop switch. When the start button is pressed, the starter motor cranks the engine, the headlight will automatically go out, but the taillight will stay on. If the engine stop switch is in the (OFF) position, the starter motor will not operate. See page 119 for Starting Procedure.

### Hazard Warning System Switch

This system should be used only when your motorcycle is stopped under emergency or hazardous conditions. To turn it on, turn the ignition key to the ON or ACC position, and then push the switch marked . The front and rear turn signals will blink simultaneously.

Be sure to turn the switch off when the hazard warning is no longer required, or the turn signals will not work properly, and may confuse other drivers.

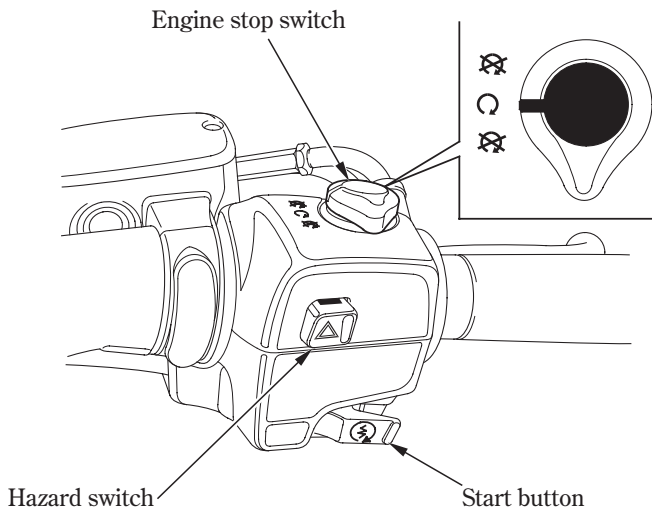





## ESSENTIAL INDIVIDUAL COMPONENTS

---

### LEFT HANDLEBAR CONTROLS

The controls next to left handlebar grip are:

#### Headlight Dimmer Switch

Push the dimmer switch to  (HI) to select high beam or to  (LO) to select low beam.



#### Passing Light Control Switch

When this switch is pressed, the headlight flashes on to signal approaching cars or when passing.

#### Horn Button

Press the button to sound the horn.

#### Turn Signal Switch

Move the switch to  (L) to signal a left turn, to  (R) to signal a right turn; the appropriate turn signal and indicator will blink. The switch returns to centre when it is released. The indicator and turn signal will automatically stop blinking after completing the turn. Blinking may be stopped manually by pushing in on the switch.

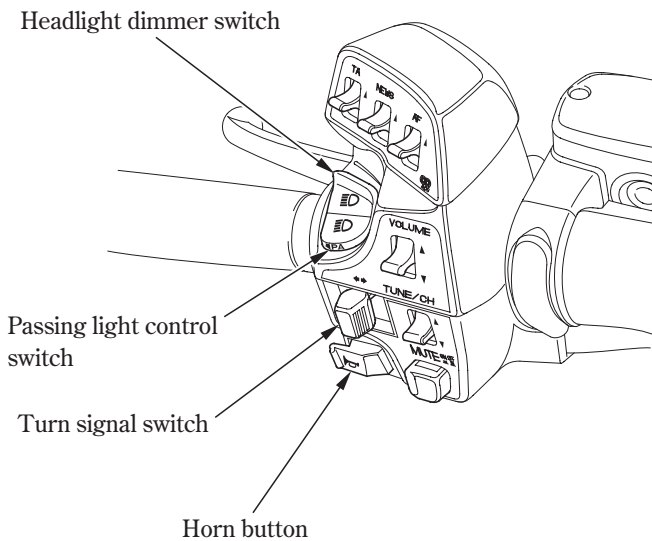



## FEATURES

### (Not required for operation)

---

#### STEERING LOCK

To lock the steering, turn the handlebars all the way to the left or right, turn the key to LOCK while pushing in. Remove the key.

To unlock the steering, turn the key to OFF while pushing in.

Do not turn the key to LOCK while riding the motorcycle; loss of vehicle control will result.

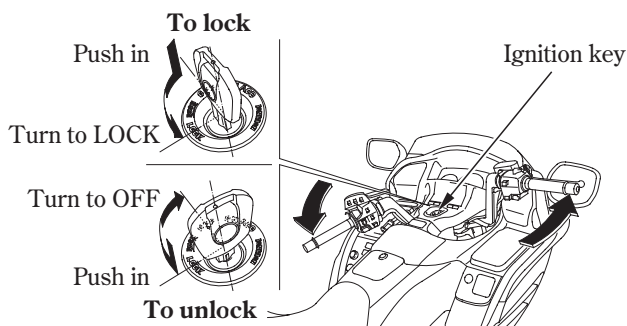

#### HELMET HOLDER

Insert the ignition key and turn it counterclockwise to unlock the helmet holder.

Hang the helmet on the holder pin by the helmet D-ring and push in on the holder pin to lock it.

Remove the ignition key.

To install two helmets on the helmet holder, use the helmet set wire provided.

Route either end of the helmet set wire through the D-ring of both helmets and hang the hoops of the wire on the holder pin and lock as above.

The helmet set wire provided with each machine is located in the left saddlebag when not in use.

The helmet holder is designed for helmet security while parked. Do not ride with a helmet attached to the holder.

#### NOTICE

Riding with a helmet attached to the helmet holder can cause damage to the helmet, or damage to the paint or finish of your motorcycle.



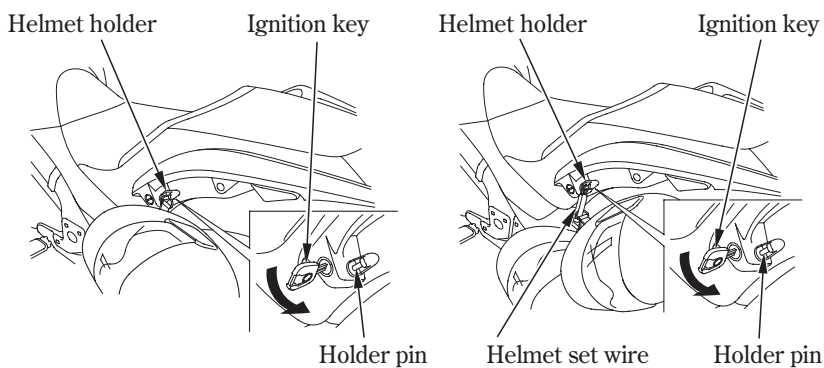

### SADDLEBAGS

The saddlebags are for lightweight items.

Cargo should not exceed:

- Except KO type      8.0 kg (17.6 lb)
- For KO type         9.0 kg (20.0 lb)

#### To Lock & Unlock the Saddlebags

The saddlebags can be locked and unlocked with the ignition key.

To unlock:

Insert the ignition key and turn it clockwise.

To lock:

Insert the ignition key and turn it counterclockwise.

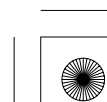
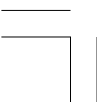
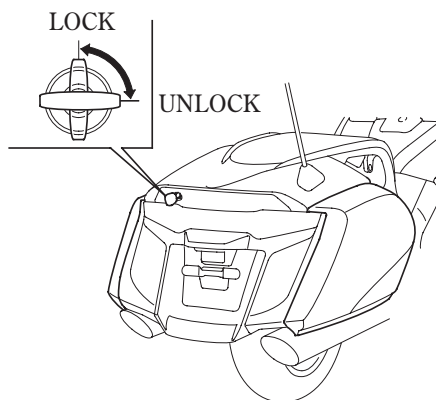



## FEATURES (Not required for operation)

---

### To Open & Shut the Saddlebags

To open the right or left saddlebag, pull the right or left latch lever.

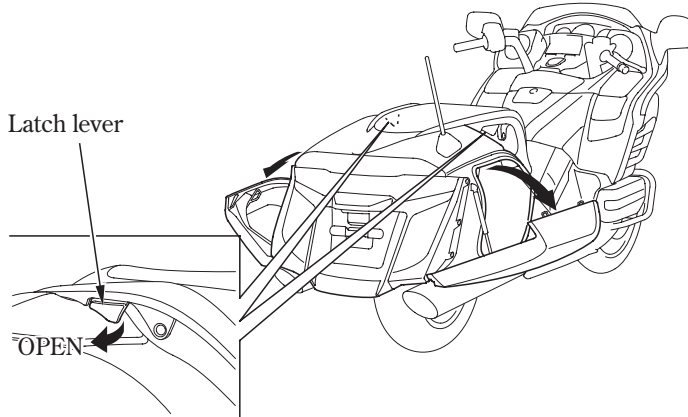

To shut saddlebags, place your hands flat on the edges of its lid and press down until it is firmly closed and check the saddlebags open indicator is not displayed.

To lock the saddlebags, use the ignition key.

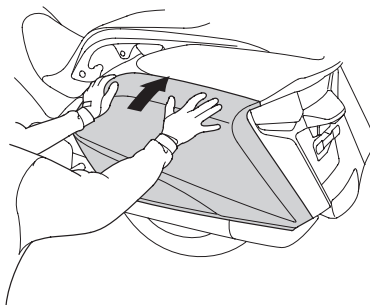

If a saddlebag won't open, see your dealer.

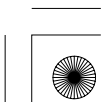
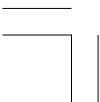



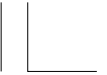

---

### FAIRING POCKET/SHELTER CASE

The fairing pocket and shelter case are for lightweight items.

Cargo should not exceed:

- in fairing pocket      2.0 kg (4.5 lb)
- in shelter case        3.0 kg (6.6 lb)

To open the fairing pocket, push the button.

To open the shelter case, insert the ignition key, turn it clockwise.

To close the fairing pocket and/or shelter case, place your hands flat on the edges of its lid and press down until it is firmly closed.

Make sure the fairing pocket and shelter case are closed before riding.

When washing your motorcycle, be careful not to flood this area with water. Take care to keep petrol, brake fluid, or other chemical solvents off the lids. They will damage the surface of the lids.

Do not store valuables in the fairing pocket and shelter case.

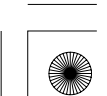
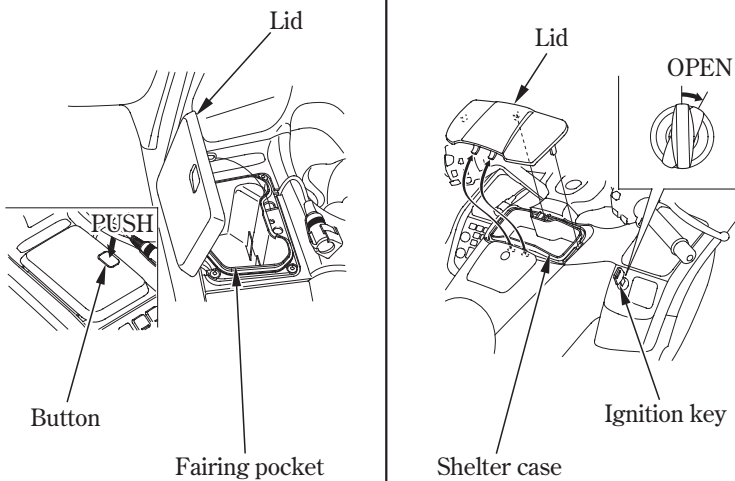

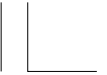

# FEATURES

## (Not required for operation)

---

### DOCUMENTS

The owner's manual and other documents should be stored in the left saddlebag. When washing your motorcycle, be careful not to flood this area.

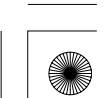
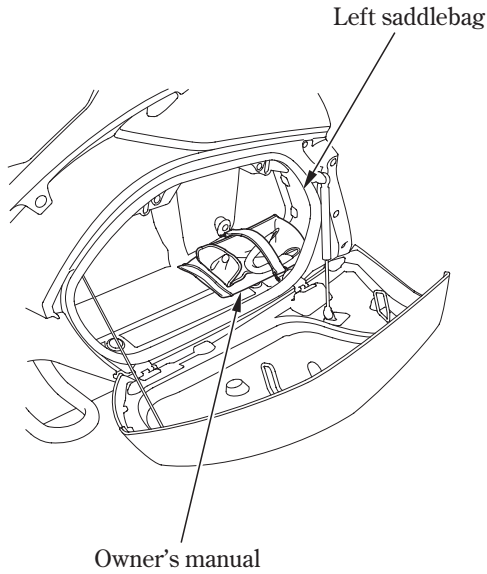

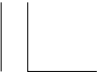

---

### **HEADLIGHT AIM VERTICAL ADJUSTMENT**

Vertical adjustment can be made by turning the headlight beam adjustment knob as necessary.

Obey local laws and regulations.

To operate, start the engine.

To lower the beam, turn headlight beam adjustment knob clockwise. To raise the beam, turn the knob counterclockwise.

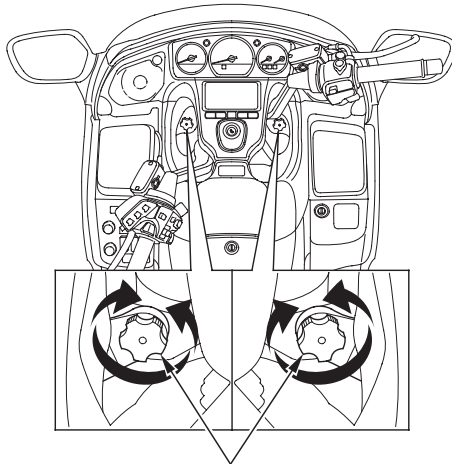

Headlight beam adjustment knob

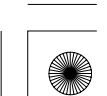
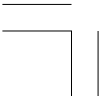



## FEATURES (Not required for operation)

---

### ACC TERMINAL

The ACC terminal is in the fuse box (page 166 ). The terminal and optional socket provide 12 V DC power for electrical accessories. When both terminal and socket are being used, the combined power rating of each accessory should be 60 watts (5 amps) or less. If equipped with accessories, check the battery frequently to determine the state of charge and examine it for possible sulfation. Higher current demands may blow the fuse or discharge the battery. Review the Accessories and Modifications (page 6 ) before installing accessories. Connect accessory electrical leads securely, and keep them insulated, away from hot parts and sharp edges.

Do not exceed 5 amps for prolonged current demands.

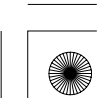
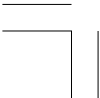
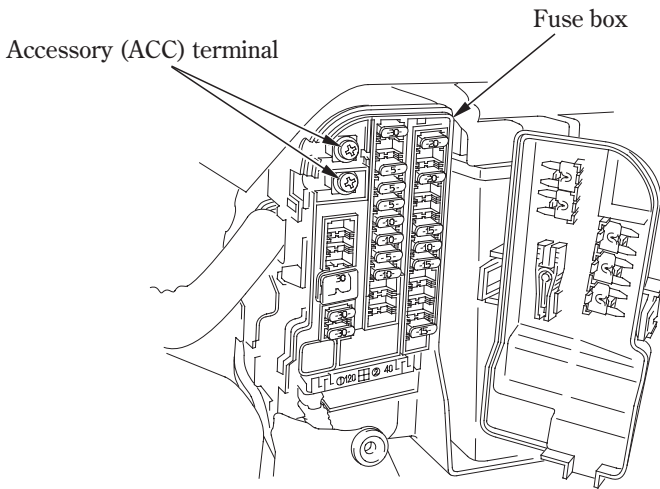



---

## AUDIO SYSTEMS

The audio system can be used with the ignition switch at ACC or ON.

Keep both hands on the handlebars.

Do not turn up the volume so loud that emergency vehicles or traffic cannot be heard.

(E, F, ED type)

Your Honda's audio system provides clear reception on each band while the preset buttons allow you to easily select your favorite stations.

In some countries, you can also utilize many convenient features provided by the Radio Data System (RDS).

(Italy only)

This product conforms to DM 28/8/1995, N. 548, by complying with the requirements specified in DM 25/6/1985 (par. 3, All. A) and DM 27/8/1987 (All. I).

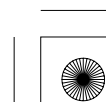
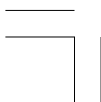



# FEATURES

## (Not required for operation)

### Display Location (E, F, ED type)

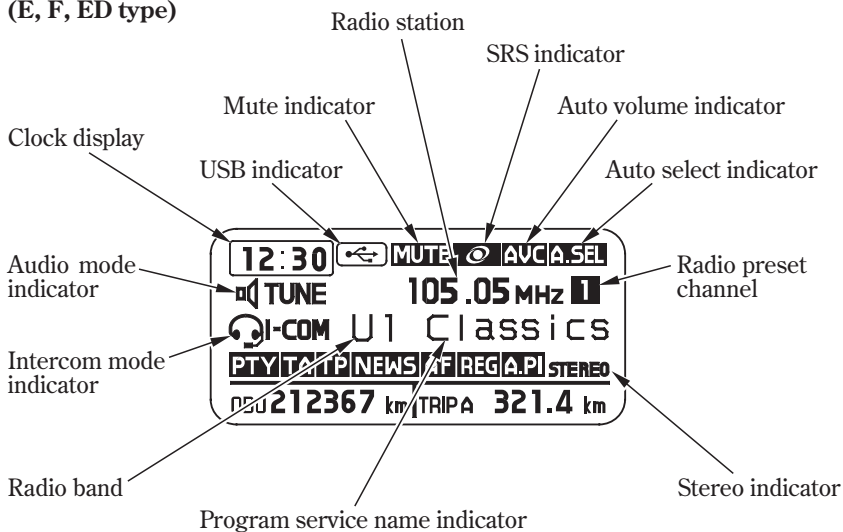

### (KO, U, SI type)

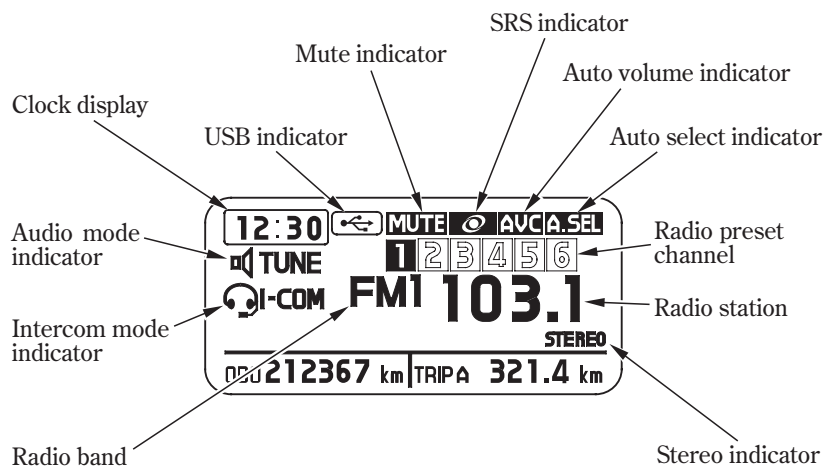



### Audio System for E, F, ED type Controls Locations

#### LEFT HANDLEBAR CONTROLS

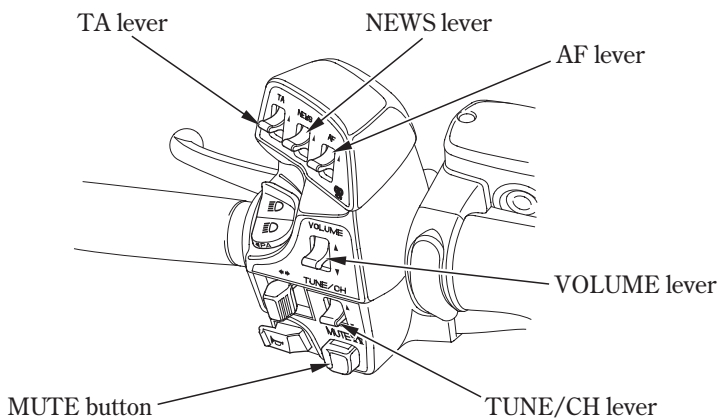

#### AUDIO CONTROL BUTTONS

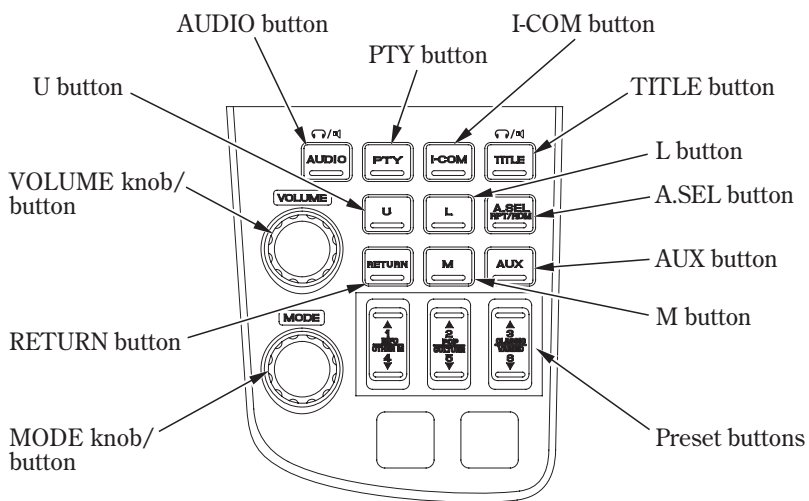

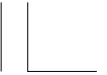

# FEATURES

## (Not required for operation)

Audio System for KO, U, SI type  
Controls Locations

### LEFT HANDLEBAR CONTROLS

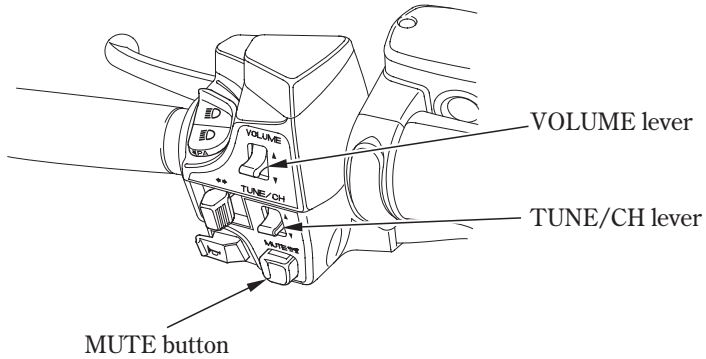

### AUDIO CONTROL BUTTONS

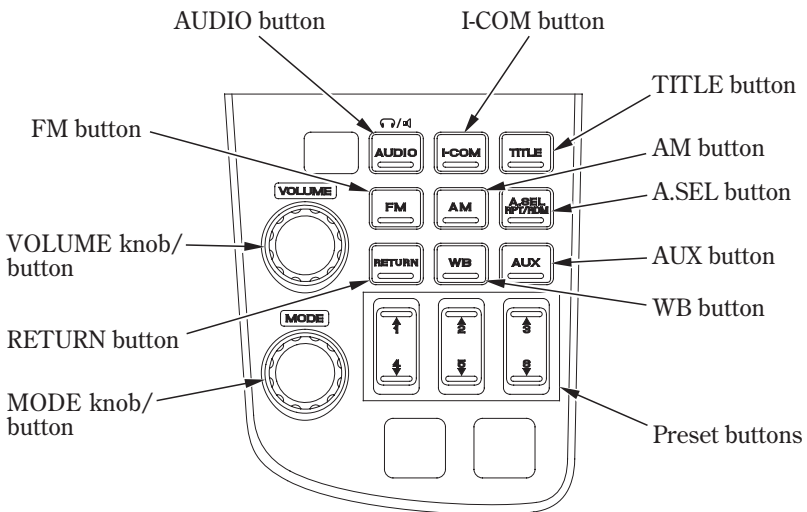





### MODE Knob/Button Function

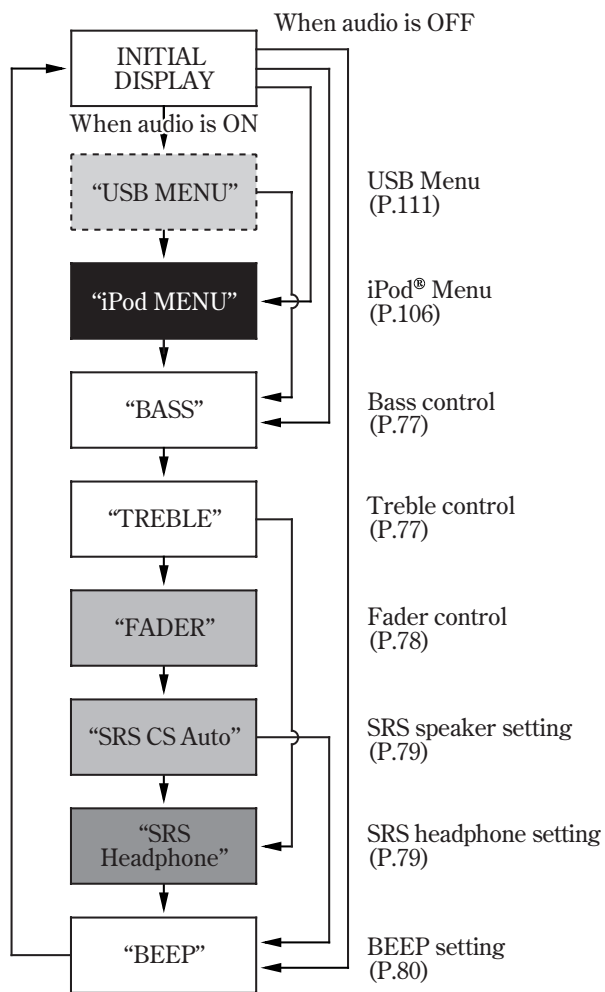

- —————> Push the MODE Knob/Button
- When the speaker is used
- When the headset is used
- When USB flash drive is used
- When iPod® is used





# FEATURES (Not required for operation)

## VOLUME Knob/Button Function

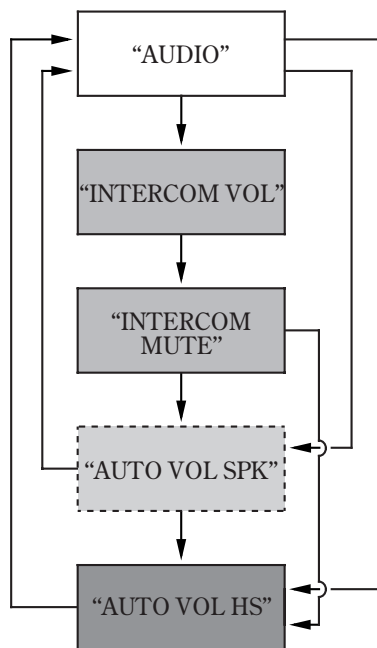

- —————> Push the VOLUME Knob/Button
- When INT. COM is ON
- When the headset is used
- When the speaker is used





---

## Audio Component Locations

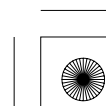
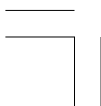
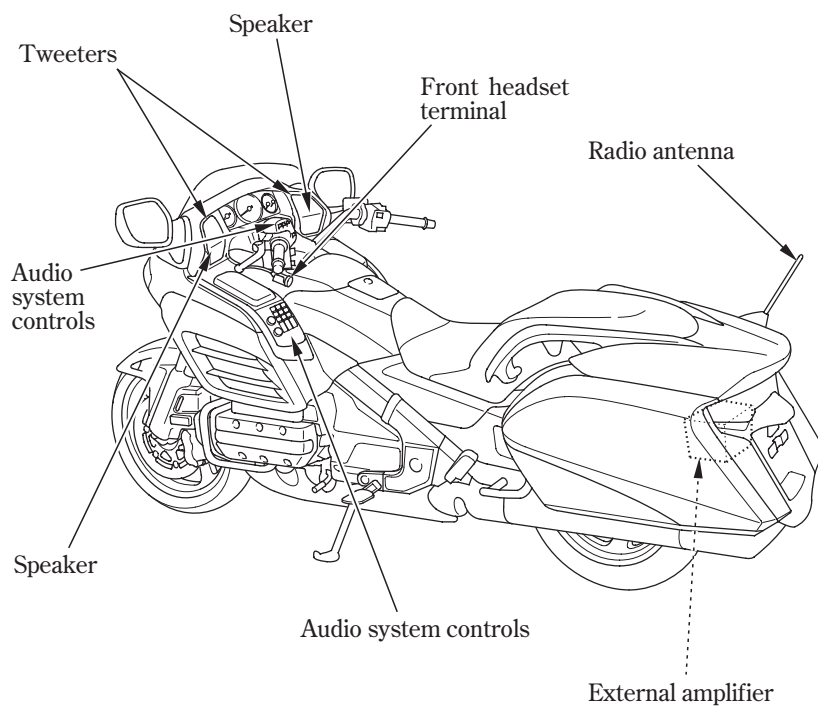



# FEATURES

## (Not required for operation)

---

### System Control

To turn the audio system on – push the AUDIO button.

To turn the audio system off – push and hold the AUDIO button.

(E, F, ED type)

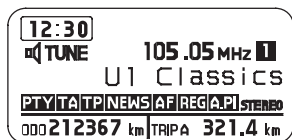

AUDIO button



(KO, U, SI type)

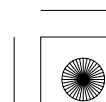
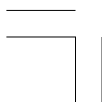
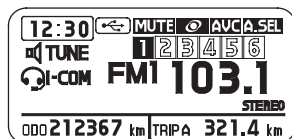



### Switch Output

When the audio system is turned on, you can switch its output between Speaker and Headset. (Headset is optional equipment.)

- Pushing the AUDIO button switches the output.

(E, F, ED type)

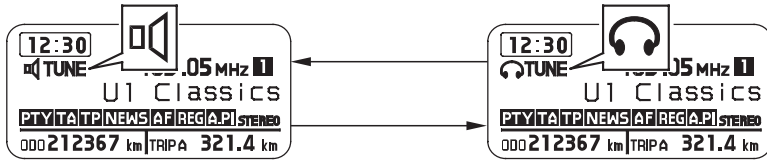

(KO, U, SI type)

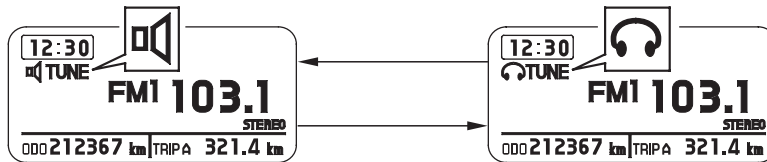



# FEATURES

## (Not required for operation)

---

### VOLUME Control

- To increase the volume — push the VOLUME lever up or turn the VOLUME knob/button clockwise.
- To decrease the volume — push the VOLUME lever down or turn the VOLUME knob/button counterclockwise.

To increase or decrease the volume rapidly — push the VOLUME lever up or down and hold it down.

(VOLUME level range: from 0 to 30)

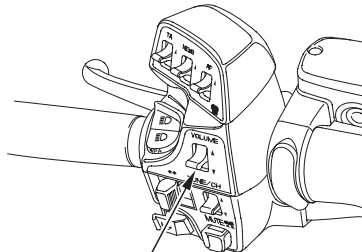

VOLUME lever

### VOLUME

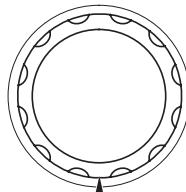

VOLUME knob/button





---

### Tone Control

- The tone (Bass – Treble) is automatically adjusted in accordance with the vehicle speed.

#### Bass:

To select the Bass control, push the MODE knob/button until “BASS” is displayed (page 71 ). Then, within 5 seconds, change the bass control.

- To emphasize bass — turn the MODE knob/button clockwise.
- To reduce bass — turn the MODE knob/button counterclockwise.  
(Bass control ranges from 6 down to –6.)

#### Treble:

To select the Treble control, push the MODE knob/button until “TREBLE” is displayed (page 71 ). Then, within 5 seconds, change the treble control.

- To emphasize treble — turn the MODE knob/button clockwise.
- To reduce treble — turn the MODE knob/button counterclockwise.  
(Treble level ranges from 6 down to –6.)

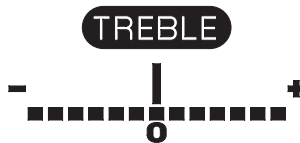
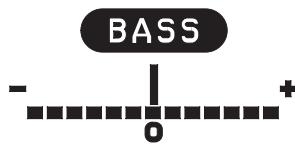
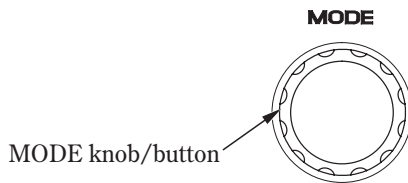



## FEATURES

### (Not required for operation)

---

#### Fader Control

Adjusting the fader control changes the speaker volume — push the MODE knob/button until “FADER” is displayed (page 71 ). Then, within 5 seconds, change the fader control. (Setting the fader control to the F increases the speaker volume. Setting the fader control to the R decreases the speaker volume.)

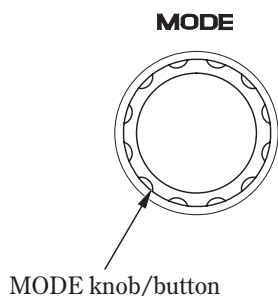



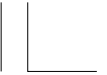

**SRS**

SRS CS Auto™ creates a surround sound experience in the car and provides rich bass and an elevated audio image.

SRS Headphone™ creates a realistic and immersive 3D stereo headphone listening experience.

**srs** and **srs** are trademarks of SRS Labs, Inc.

CS Auto and Headphone technologies are incorporated under license from SRS Labs, Inc.



- To use the circuit ————— push the MODE knob/button until “SRS CS Auto” is displayed (page 71 ). To select the SRS of headset, push the MODE knob/button until “SRS HP” is displayed. Then, within 5 seconds, change the SRS setting.
- To change the setting ————— turn the MODE knob/button.  
SRS CS Auto has three settings – HI, LOW, OFF.  
SRS HP has two settings – ON, OFF.

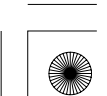
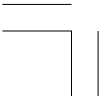
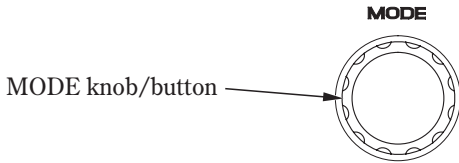



## FEATURES (Not required for operation)

---

### Beep set

- To use the circuit ————— push the MODE knob/button until “BEEP” is displayed (page 71 ). Then, within 5 seconds, change the beep setting.
- To change the setting ————— turn the MODE knob/button. (ON or OFF)

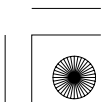
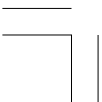
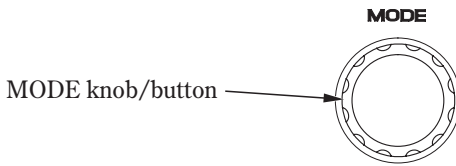



---

### Auto Volume Control (AVC)

To automatically increase volume as the speed of the motorcycle increases. Push the VOLUME knob/button until “AUTO VOL SPK” is displayed (page 72). To select the volume control of headset, push the VOLUME knob/button until “AUTO VOL HS” is displayed (page 72 ). Then, within 5 seconds, change the AVC setting.

AUTO VOL SPK has four settings – HI, MID, LO, and OFF.

AUTO VOL HS has three settings – HI, LO, and OFF.

**VOLUME**

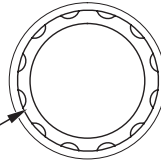

VOLUME knob/button

**AUTO VOL SPK**  
**MID**

**AUTO VOL HS**  
**OFF**

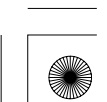
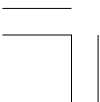



## FEATURES (Not required for operation)

---

### Muting

To instantly lower the radio's volume so you may hear surrounding sounds more clearly — push the MUTE button.

The display will indicate “MUTE”.

To restore the original volume — push the MUTE button again to restore the original volume.

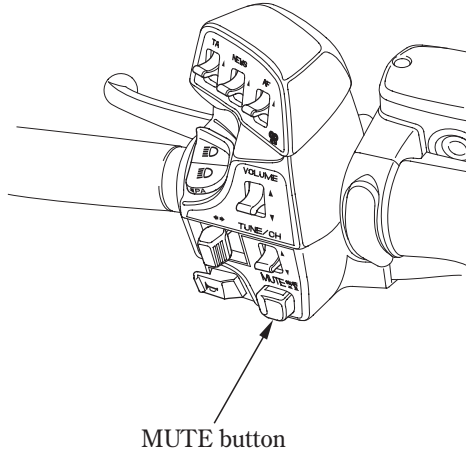

**MUTE**





---

## **RADIO**

### **Radio Antenna**

To remove the radio antenna, turn it counterclockwise.

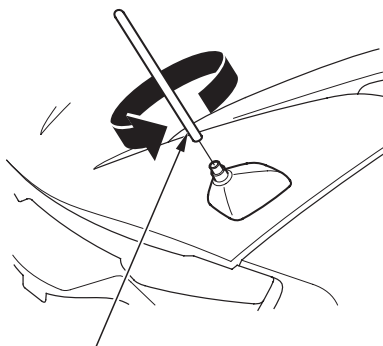

Radio antenna



Read the appropriate pages in this section for operation of the radio in your motorcycle.



- Page 84 to 93 for E, F and ED Types.
- Page 94 to 99 for KO, U and SI Types.

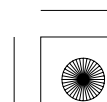
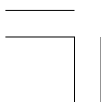

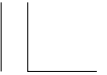

# FEATURES

## (Not required for operation)

(E, F, ED type)

### Select Band

To change bands when you are in the radio mode – push the U, M and L buttons.

Push the U button to switch to U1/U2.

Reception of a stereo signal is indicated when the STEREO indicator appears in the display. (Stereo reception is available only for FM stereo broadcasts.) As FM stereo reception becomes weaker, special circuits in the radio gradually blend the sound toward mono to maintain some sound quality, even though the STEREO indicator remains ON.

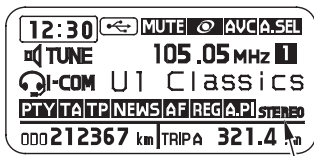
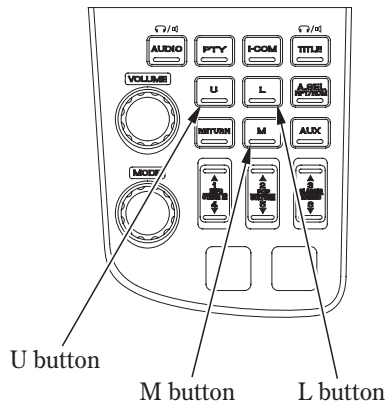

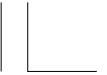

---

### Select Station

To raise the radio frequency – push the TUNE/CH lever up.

To lower the radio frequency – push the TUNE/CH lever down.

To move up or down the radio frequencies in sequence, move the lever one click at a time. The U (FM) frequency display moves in 100 KHz steps. The M (MW) frequency display moves in 9 KHz steps. The L (LW) frequency display moves in 3 KHz steps.

The SEEK function searches the band for a station with a strong signal. To activate it, push the TUNE/CH lever up or down and release it. The frequency display will begin moving. Depending on which way you push the switch, the system scans upward or downward from the current frequency. It stops when it finds a station with a strong signal.

When the frequency display reaches either end, it transitions to the other end of the band and continues in the same direction.

To reach a known frequency rapidly – push the TUNE/CH lever up or down and continue to hold it down until you see the desired frequency.

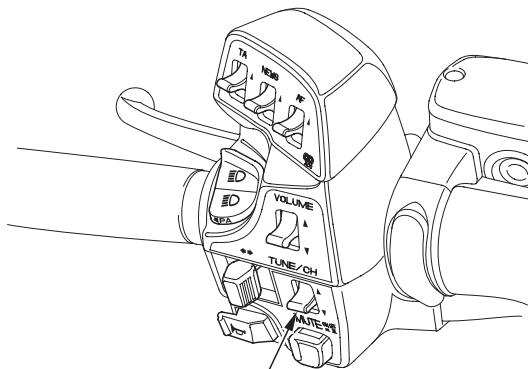

TUNE/CH lever

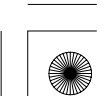

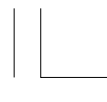

## FEATURES (Not required for operation)

---

### Preset Stations

You can store the frequencies of your favorite radio stations in the six preset buttons. Each button will store one frequency on the LW, MW bands, and two frequencies on the UKW band.

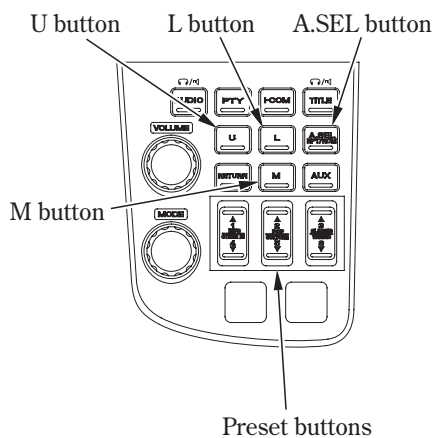

1. Check that A. SEL is not turned on. If it is on, push the A. SEL button to turn it off.
2. Select the desired band, LW, MW or UKW. U1 and U2 let you store two frequencies with each Preset button.
3. Use the TUNE or SEEK function to tune the radio to a desired station.
4. Pick the Preset button you want for that station. Press the button and hold it.
5. Repeat steps 1 to 3 to store a total of six stations on LW, MW and twelve on UKW.

Once a station's frequency is stored, simply press and release the proper Preset button to tune to it. The preset frequencies will be lost if your motorcycle's battery goes low (or dead) or is disconnected, or if the radio fuse is removed.





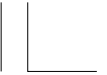

---

### Auto Select

If you are traveling far from home and can no longer receive the stations you preset, you can use the Auto Select feature to find stations in the local area.

To activate Auto Select, push the A.SEL button. A.SEL will appear in the display, and the system will go into scan mode for several seconds.

It automatically scans both bands, looking for stations with strong signals. It stores the frequencies of six LW, MW stations and twelve UKW stations in the preset buttons (page 86 ). You can then use the preset buttons to select those stations.

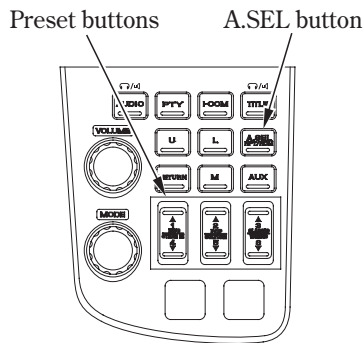

If you are in a remote area, Auto Select may not find six strong LW, MW stations or twelve strong UKW stations. If this happens, you will see a “0” displayed when you push any preset button that does not have a station stored.

With Auto Select on, you cannot manually store any frequencies in the preset buttons. If you do not like the stations found by Auto Select, you can use the TUNE and SEEK functions to find other stations.

Auto Select does not erase the frequencies that you preset previously. When you return home, turn off Auto Select by pressing the A.SEL button. The preset buttons will then select the frequencies you originally set.

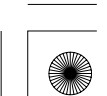

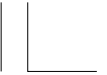

# FEATURES

## (Not required for operation)

### Radio Data System (RDS) Features

With your audio system, you can utilize many convenient features provided by the Radio Data System (RDS).

The Alternative Frequencies (AF) function turns on automatically when you turn the system on. If the station you are listening to is an RDS station, the frequency display will disappear and the station name will be displayed. Then, the system will automatically keep selecting the frequency with the strongest signal from the frequencies that carry the same programs. This can save you the trouble of re-tuning to obtain the same station as long as you are in the same RDS network area.

When the signals of the RDS station become so weak that the system can no longer follow the station, the system will hold the last tuned frequency and the display will change from the station name to the frequency.

### *U Button*

With the UKW (FM) band selected, you can keep listening to the same station even if its frequency changes as you enter different regions while you are travelling.

U button

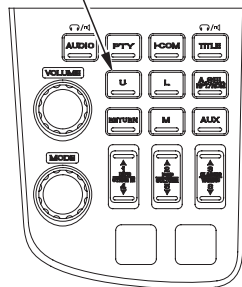

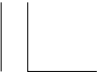

**AF Lever**

To turn the AF on — push the AF lever up, “AF” will light in the display.  
To turn the AF off — push and hold the AF lever up.

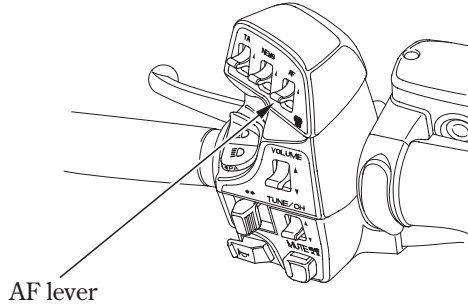

In some countries, you cannot utilize features provided by RDS as the RDS function is not provided in all stations.

**Program Service Name Indicator**

If the station you are listening to is an RDS station, the frequency display will disappear and the station name information will be displayed.

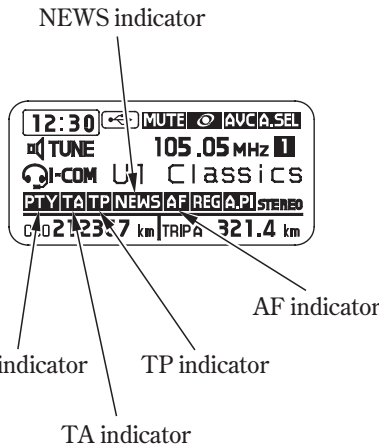



## FEATURES

### (Not required for operation)

---

#### ***TA (Traffic Announcement Standby) Function***

To activate this function, select the U (FM) band.

When the TA lever is up, "TA" will light on the display and the system will stand by for traffic announcements.

When a traffic information (TP) station is selected, "TP" will light on the display indicating that traffic reports can be received from this station. When the EON (Enhanced Other Network) TP station is selected, "TP" will also light on the display.

EON information cross-references other program services that broadcast traffic information, and when EON information is received, traffic reports can be received through another program service.

To turn off the TA function, push the TA lever up again. "TA" will go out on the display.

#### ***Adjusting the Volume***

The volume will be automatically adjusted while traffic information is broadcasted regardless of the VOLUME knob position. If you adjust the volume level, the new volume level for traffic information is temporarily stored in memory. The next time you listen to traffic information, the volume will be at the previous level.

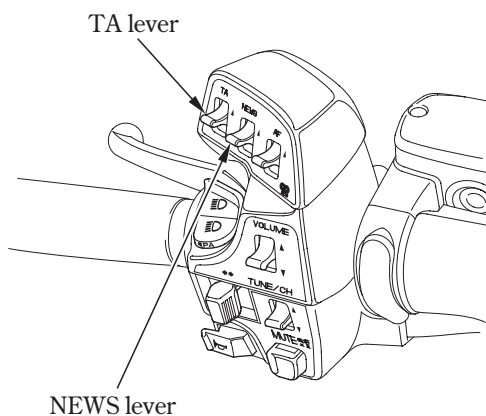



---

***TA (Traffic Announce)***

When you turn on TA function, an alarm will sound 5 times, if the signal from TP station cannot be received.

If the signal from a TP station becomes weak while you are listening to the radio, the “TP” indicator will disappear, and 5 minutes later an alarm will sound and TP indicator flashes once to tell you to tune to another TP station.

***News (News Interrupt Function)***

To activate this function, push the NEWS lever up, “NEWS” will light on the display.

Volume level information is the same as for TA function (see page 90 ).

Your audio system has another interrupt function (including TA function). The priority of interrupt is in the order of “NEWS”, “TA”, and “ALARM”. To activate the other interrupt function, turn off the currently activated interrupt function.

***Alarm***

The PTY code “ALARM” is used for emergency announcements, such as natural disasters. When this code is received, “ALARM” goes on the display. Volume level information is the same as for TA function (see page 90 ). When the alarm is cancelled, the system will return to the normal operation mode.

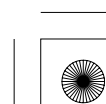
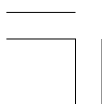



# FEATURES

## (Not required for operation)

### *PTY Display Function (Station Name and Information Display)*

When the PTY button is pressed, the PTY display function turns on. The PTY indicator will light on the display as a reminder. This function lets you know the type of programs the selected RDS station is broadcasting. For example, if the station is broadcasting CLASSIC, "CLASSIC" is shown in the display. If it is a station of culture programs, "CULTURE" will be shown. The principal PTYs are shown in the following.

INFO: General information and advice.

POP: Commercial music of popular appeal.

CLASSIC: Serious classics; performances of major orchestral works.

OTHER M: Other types of music, such as, Jazz, R & B, Folk, Country, Reggae.

CULTURE: Programs concerned with any aspect of national or regional culture.

VARIED: Light entertainment programs.

PTY button

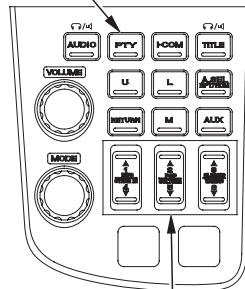

Select buttons



**PTY Genre Preset**

1. Check that A. SEL is not turned on. If it is on, push the A. SEL button to turn it off.
2. Select the UKW band and push the PTY button.
3. Push the select button and select the PTY group.

CH1	CH2	CH3	CH4	CH5	CH6
INFO	POP	CLASSIC	OTHER M	CULTURE	VARIED

4. When the select button which is the same as the chosen PTY group is pushed for two seconds, it becomes the establishment mode of the following PTY genre.

CH1	CH2	CH3	CH4	CH5	CH6
FINANCE	EASY MUS	CLASSICS	COUNTRY	AFFAIRS	CHILDREN
INFO	POP MUS	L. CLASS	FORK MUS	CULTURE	DRAMA
NEWS	ROCK MUS		JAZZ	DOCUMENT	LEISURE
TRAVEL			NATION M	EDUCATE	PHONE IN
WEATHER			OLDIES	RELIGION	SPORT
			OTH M	SCIENCE	VARIED
				SOCIAL A	

5. Push the select button and select the PTY genre.
6. Push the select button for two seconds, the PTY genre is set.
7. Repeat steps 3 to 6 to set the other PTY genres.



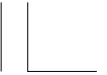

# FEATURES

## (Not required for operation)

(KO, U, SI type)

### Select Band

To change to AM or FM when you are in the radio mode — push the AM or FM button.

Push the FM button to switch to FM1/FM2.

Reception of a stereo signal is indicated when the STEREO indicator appears in the display. (Stereo reception is available only for FM stereo broadcasts.) As FM stereo reception becomes weaker, special circuits in the radio gradually blend the sound toward mono to maintain some sound quality, even though the STEREO indicator remains ON.

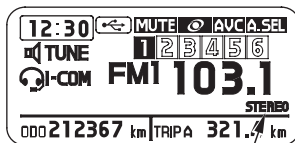
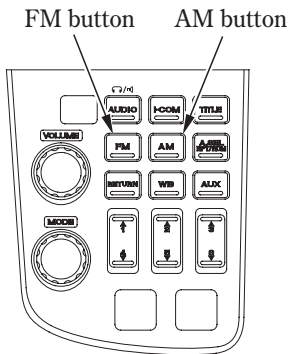

STEREO indicator





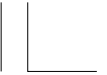

---

### Select Station

To raise the radio frequency – push the TUNE/CH lever up.

To lower the radio frequency – push the TUNE/CH lever down.

(KO, U, SI type)

To move up or down the radio frequencies in sequence, move the lever one click at a time. The AM frequency display moves in 9 KHz steps. The FM frequency moves in 100 KHz steps.

The SEEK function searches the band for a station with a strong signal. To activate it, push the TUNE/CH lever up or down and release it. The frequency display will begin moving. Depending on which way you push the switch, the system scans upward or downward from the current frequency.

It stops when it finds a station with a strong signal.

When the frequency display reaches either end, it transitions to the other end of the band and continues in the same direction.

To reach a known frequency rapidly – push the TUNE/CH lever up or down and continue to hold it down until you see the desired frequency.

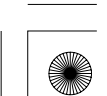
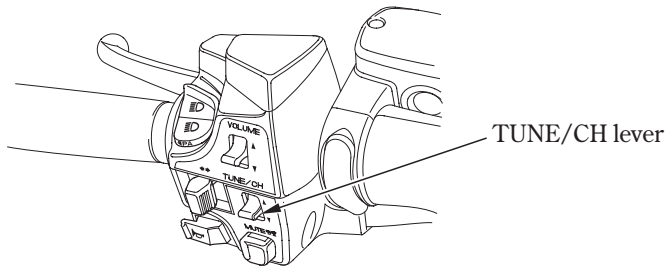



## FEATURES

### (Not required for operation)

---

#### Preset Stations

You can store the frequencies of your favorite radio stations in the six preset buttons. Each button will store one frequency on the AM band, and two frequencies on the FM band.

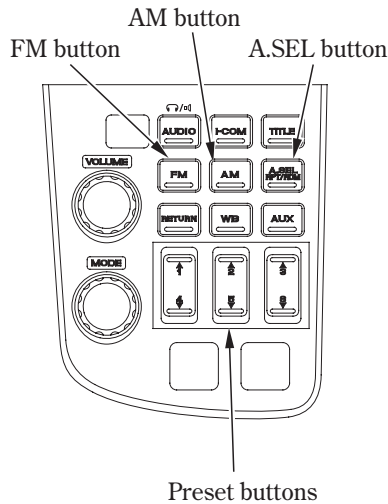

1. Check that A. SEL is not turned on. If it is on, push the A. SEL button to turn it off.
2. Select the desired band, AM or FM. FM1 and FM2 let you store two frequencies with each Preset button.
3. Use the TUNE or SEEK function to tune the radio to a desired station.
4. Pick the Preset button you want for that station. Press the button and hold it.
5. Repeat steps 1 to 3 to store a total of six stations on AM and twelve on FM.

Once a station's frequency is stored, simply press and release the proper Preset button to tune to it. The preset frequencies will be lost if your motorcycle's battery goes low (or dead) or is disconnected, or if the radio fuse is removed.

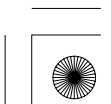
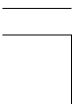



### Auto Select

If you are traveling far from home and can no longer receive the stations you preset, you can use the Auto Select feature to find stations in the local area.

To activate Auto Select, push the A.SEL button. A.SEL will appear in the display, and the system will go into scan mode for several seconds.

It automatically scans both bands, looking for stations with strong signals. It stores the frequencies of six AM stations and twelve FM stations in the preset buttons (page 96 ). You can then use the preset buttons to select those stations.

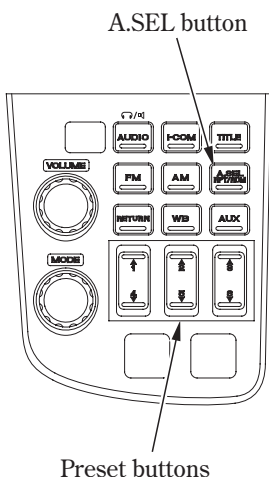

If you are in a remote area, Auto Select may not find six strong AM stations or twelve strong FM stations. If this happens, you will see a “0” displayed when you push any preset button that does not have a station stored.

With Auto Select on, you cannot manually store any frequencies in the preset buttons. If you do not like the stations found by Auto Select, you can use the TUNE and SEEK functions to find other stations.

Auto Select does not erase the frequencies that you preset previously. When you return home, turn off Auto Select by pressing the A.SEL button. The preset buttons will then select the frequencies you originally set.

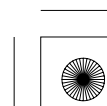
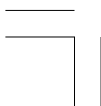



# FEATURES

## (Not required for operation)

### Weather Band (WB)

To listen to the Weather Band – push the WB button.

To cancel the Weather Band – push another button.

To select channels 1 – 6 – push the desired preset button.

To select channel 7 – push the TUNE/CH lever up or down until channel 7 is selected. (The TUNE/CH lever may be used to select any of the 7 channels. The lever must be used to select channel 7.)

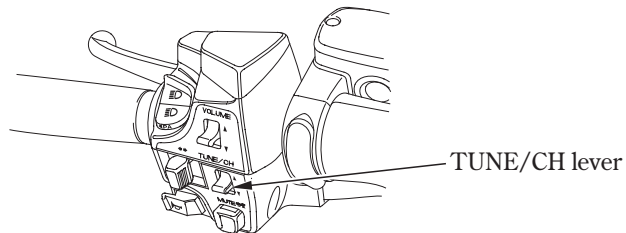
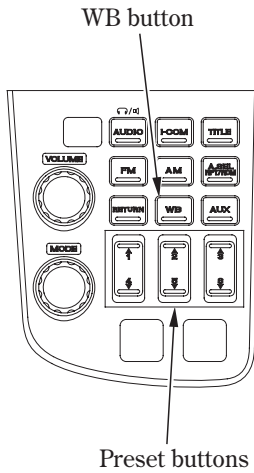



---

## AUXILIARY FUNCTION

### Auxiliary (AUX) Input

Use this function to listen to other audio:

Connect the input jack connector to listen to other audios.

Connect the iPod®/USB flash drive to the USB cable to operate and listen to it (see page 101).

- To turn the function on — push the AUX button. (AUX appears on the display.)
- To turn the function off — push another button.

The following functions operate the same as they do with the radio:  
Switch output, Tone control, Fader control, SRS, AVC, BEEP, Muting.



AUX button

The display changes as follows each time the AUX button is pushed.

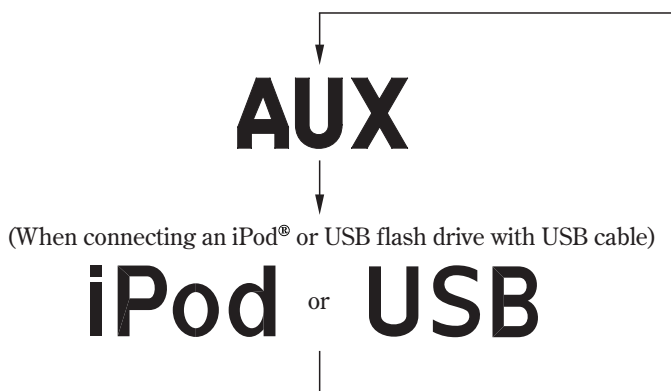



# FEATURES

## (Not required for operation)

---

### Input Jack Setup

The auxiliary input jack connector is located under the left fairing pocket. To use it:

1. Attach a cloth to the cover and remove the cover with care using a flat-tip screwdriver.
2. Open the left fairing pocket cover and remove the clips and grommet A.
3. Lift out the fairing pocket.

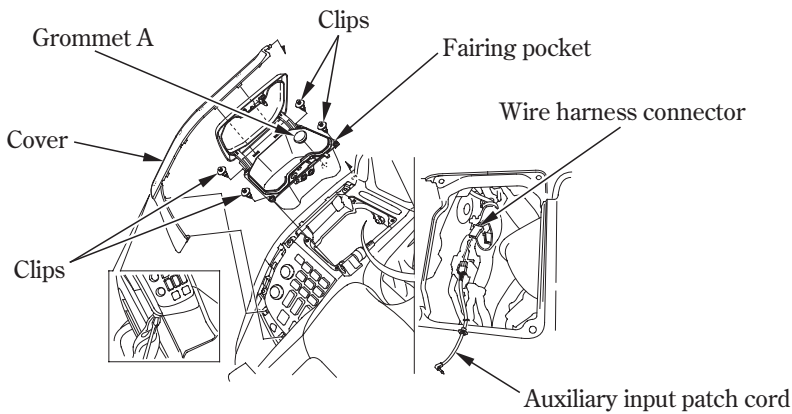

4. Plug the auxiliary input patch cord into the wire harness connector.
  5. Route the auxiliary input patch cord through the hole in the bottom of the fairing pocket.
  6. Install the grommet B to left fairing pocket.
- Do not pull on the auxiliary cord as the wires could be damaged.

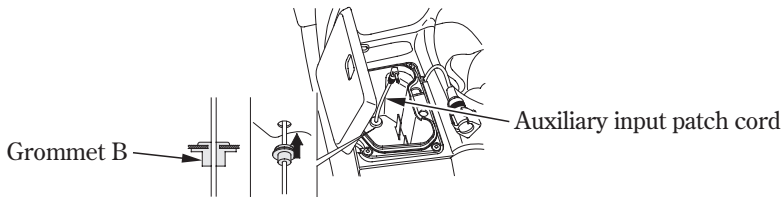

Some portable audio systems may pick up noise from the ignition. Adjust the volume of the portable audio system so that it is about the same level as the GL's radio volume. If the volume of the portable audio system is set too high, the sound coming out from the speakers or headset may be distorted.





**iPod®/USB FLASH DRIVE**

This audio system can play the audio files on the iPod® and a USB flash drive. To play an iPod® or a USB flash drive, connect it to the USB cable in the left saddlebag (page 62 ).

iPod touch®, iPod®, iPod nano® are registered trademarks of Apple Inc. in the U.S. and other countries.

Use any USB flash drive and iPod® at your own risk.

**Playable iPod®/USB Flash Drive**

Compatible Devices

iPods® and USB flash drives compatible with your audio system are:

Device	Support Requirements
USB flash drive	256 M bytes or more
Hard disk drive	Not supported
Card reader/Memory reader	Not supported
CD/DVD/FD drive	Not supported
USB hub	Not supported
iPod nano® 1st generation	F/W Ver. 1.2.0 or later
iPod nano® 2nd generation	F/W Ver. 1.1.2 or later
iPod nano® 3rd generation	F/W Ver. 1.0.0 or later
iPod nano® 4th generation	F/W Ver. 1.0.0 or later
iPod nano® 5th generation	F/W Ver. 1.0.0 or later
iPod nano® 6th generation	F/W Ver. 1.0.0 or later
iPod touch® 1st generation	F/W Ver. 1.2.0 or later
iPod touch® 2nd generation	F/W Ver. 1.0.0 or later
iPod touch® 3rd generation	F/W Ver. 4.2.0 or later

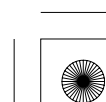
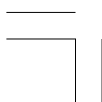



## FEATURES (Not required for operation)

---

- Do not leave iPods®/USB flash drives in the vehicle (left saddlebag). High heat will damage it.
- Read precaution statements on the provided instructions of your iPods®/USB flash drives.
- Use iPod® with the latest version of firmware.
- Some USB flash drives (such as devices with security lockout features, etc.) may not be used or restricted to its function.
- Do not use hard disks, card readers, and memory readers which may damage the device and data. If you faultily connect the one of them, turn the ignition switch OFF and remove it.
- We recommend backing up your data before playing it.
- iPods® can be charged with the USB cable when the ignition switch is in the ON or ACC position.  
The charging time may be longer than usual.
- We recommend covering your iPods®/USB flash drives with soft fabric or cover to protect from damage.

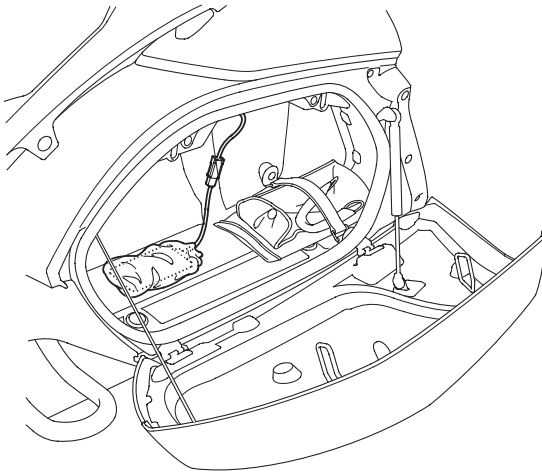

- Be careful to not get the USB connector wet.
- Do not connect with a hub.
- Do not connect incompatible iPods®/USB flash drives.
- Music information may not be displayed. If the character code in use is not supported, “.” will be displayed.
- If the audio system does not recognize the iPod®, try reconnecting it a few times or reboot the device.







### Playable Music Files

In the audio function, MP3/WMA music files in USB flash drives can be played. Read the followings before recording files in your USB flash drives which may have restrictions.

- Do not change the file name extensions. Playing USB flash drives containing these kind of files can cause troubles such as the device or speakers failure.

MP3/WMA files in your USB flash drives can be played on the following specifications.

#### MP3

Items	Contents
Standards	MPEG1 Audio Layer 2,3 MPEG2 Audio Layer 2,3 MPEG2.5 Audio Layer 2,3
Sampling periodicity (kHz)	MPEG1 32/44.1/48 kHz MPEG2 16/22.05/24 kHz MPEG2.5 8/11.025/12 kHz
Bit rates (kbit/s)	MPEG1 Audio Layer 2: 32-384/VBR/CBR MPEG1 Audio Layer 3: 32-320/VBR/CBR MPEG2 Audio Layer 2: 8-160/VBR/CBR MPEG2 Audio Layer 3: 8-160/VBR/CBR MPEG2.5 Audio Layer 3: 8-160/VBR/CBR If the files are low bit rate and/or small data size, you may not be played the files.
File systems	FAT12/16/32
Channel modes	Stereo/Joint stereo/Dual channel/Monaural
Maximum hierarchies	8 hierarchies (including the root directory)
Maximum folders	999 folders
Maximum files	65,025 files (255 files in one folder)
Available tags	ID3v1 (v1.0/v1.1), ID3v2 (v2.2/v2.3/v2.4)
Available number of characters	max: 16 characters (According to the character code or the number of songs, the maximum number of characters may not be displayed.)



## FEATURES

### (Not required for operation)

---

#### WMA

Items	Contents
Standards	Windows Media Audio Version 7/8/9
Sampling periodicity (kHz)	32/44.1/48
Bit rates (kbit/s)	48-320/VBR
File systems	FAT 12/16/32
Channel modes	Stereo/Monaural
Maximum hierarchies	8 hierarchies (including the root directory)
Maximum folders	999 folders
Maximum files	65,025 files (255 files in one folder)
Available tags	WMA: ASF TOP-LEVEL HEADER OBJECT Only songs, artists and albums available. (The albums registered by Windows Media Player is only available.)
Available number of characters	max: 16 characters (According to the character code or the number of songs, the maximum number of characters may not be displayed.)

Windows Media is a registered trademark of Microsoft Corporation. in the U.S. and other countries.





---

## **USB Cable**

### To connect

1. Open the left saddlebag (see page 62 ).
2. Unclip the USB connector.
3. Connect your iPod® with dock connector or the USB flash drive to the USB connector.

### To disconnect

You can disconnect the iPod®/USB flash drive at any time. Make sure to follow the iPod®'s instructions on how to disconnect the dock connector from the USB cable.

When you disconnect the iPod®/USB flash drive, the USB indicator will disappear.

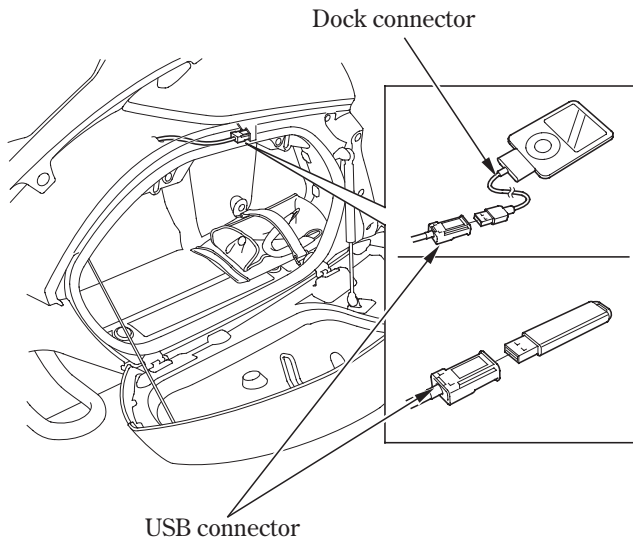



## FEATURES (Not required for operation)

---

### Playing an iPod®

Connect the iPod® using your dock connector to the USB cable (see page 105 ), then push the AUX button twice and iPod® indicator will be displayed.

If you see an error message in the display, see page 114 .

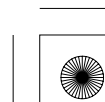
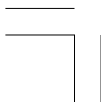
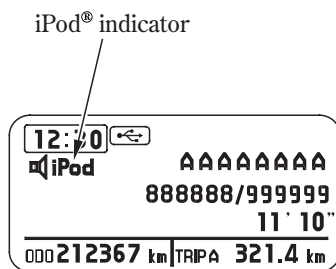



Select a playlist, artist, album and song by using the MODE knob/button. Push the MODE knob/button until the iPod® menu is displayed, then select the desired list by turning the MODE knob/button. Push the MODE knob/button to set your selection.

The display shows items on the selected list. Turn the MODE knob/button to select an item, then push the MODE knob/button to set your selection.

If you select “ALL”, all available files on the selected list are played.

Selecting “RETURN” goes back to the previous display.

Push the TITLE button to change the title display of albums, songs and artists. Push and hold the TITLE button to display the text data of albums, songs and artists from first 8 characters to next 8 characters.

Push the RETURN button to go back to the previous menu while selecting a playlist, artist, album and song.



RETURN button

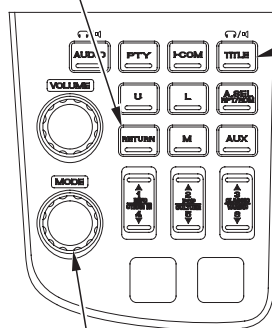

TITLE button

MODE knob/button

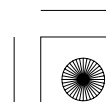
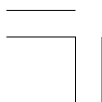

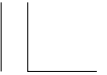

## FEATURES (Not required for operation)

---

You can also change or select playlists, artists and albums on the iPod® menu, use the TUNE/CH lever (see page 109).



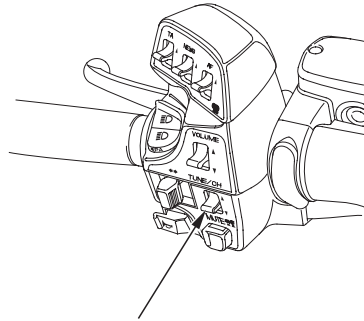

Use the TUNE/CH lever while an iPod® is playing to change files.  
Push the TUNE/CH lever up to change to the next file.  
Push the TUNE/CH lever down to change to the previous file.

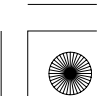
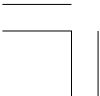

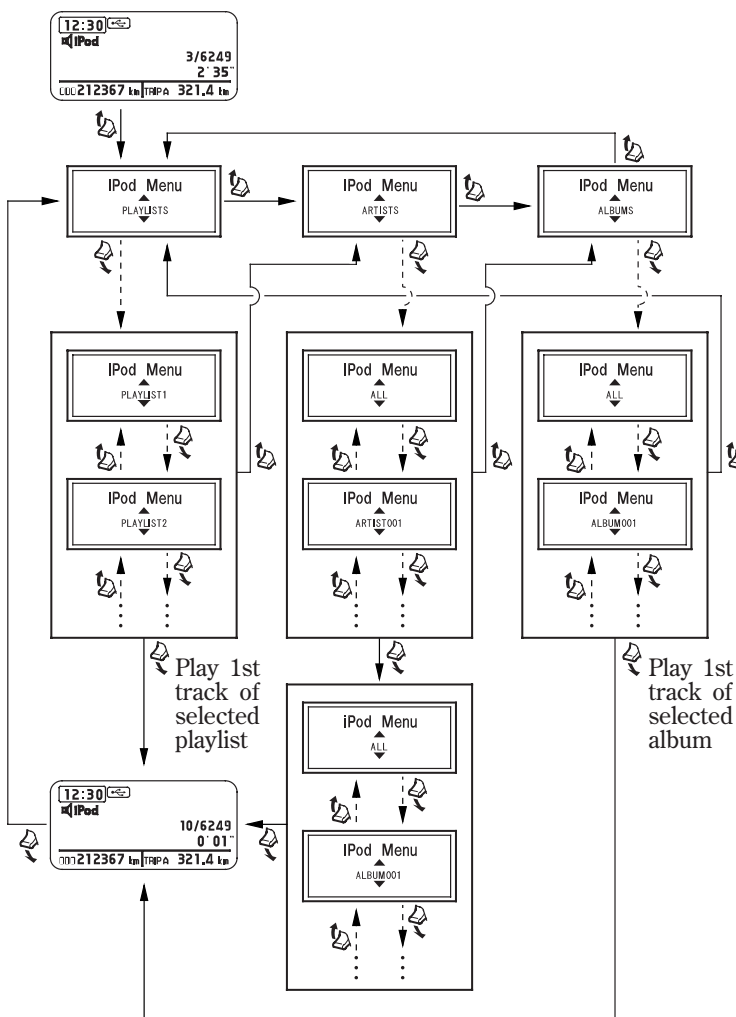
TUNE/CH lever

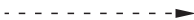



- Push the TUNE/CH lever: 
- Push and hold the TUNE/CH lever: 
- Push the TUNE/CH lever up: 
- Push the TUNE/CH lever down: 





# FEATURES

## (Not required for operation)

You can select repeat and random play modes when playing a file.

### To select a play mode

Push the A.SEL RPT/RDM button until the desired play mode is displayed.

The display changes as follows each time the A.SEL RPT/RDM button is pushed.

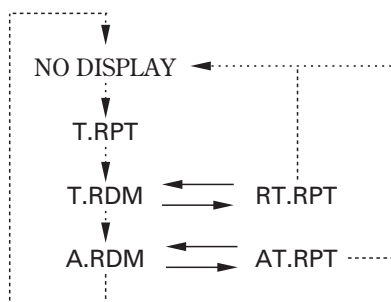

Push the A.SEL RPT/RDM button: .....▶

Push and hold the A.SEL RPT/RDM button: ————▶

### Play Mode Menu Items

Mode	Function
T.RPT	Repeats the current track.
T.RDM	Plays all available files in a selected list (playlists, artists, albums or songs) in random order.
A.RDM	Plays all available albums in random order.
RT.RPT	Repeats current file in T.RDM play mode.
AT.RPT	Repeats current file in A.RDM play mode.







### Playing a USB Flash Drive

Connect your USB flash drive to the USB cable (see page 105 ), then push the AUX button twice and USB indicator will be displayed.

If you see an error message in the display, see page 114 .

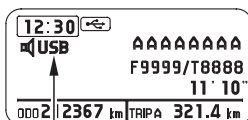

USB indicator

Select a folder or file by using the MODE knob/button. Push the MODE knob/button until the USB menu is displayed, then select the desired folder or file list by turning the MODE knob/button. Push the MODE knob/button to set your selection.

The display shows items on the selected list. Turn the MODE knob/button to select an item, then push the MODE knob/button to set your selection.

Selecting "RETURN" goes back to the previous display.

Files on the USB flash drive are played in their stored order. This order may be different from the order displayed on your PC or device.

Push the TITLE button to change the title display of folders, files, artists, albums and songs.

Push and hold the TITLE button to display the text data of from first 8 characters to next 8 characters.

Push the RETURN button to go back to the previous menu while selecting a folder, file, artist, album and song.

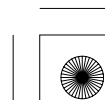
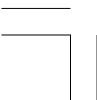

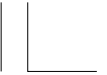

# FEATURES

## (Not required for operation)

---

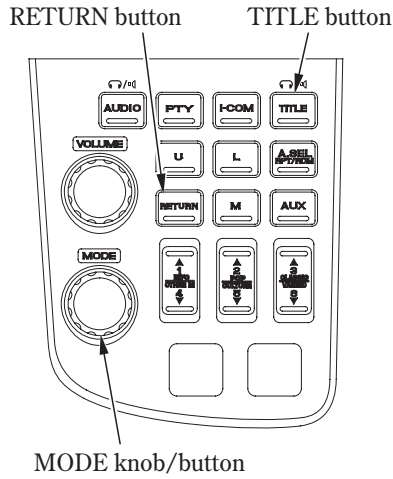

You can also change or select files and folders by using TUNE/CH lever while a USB flash drive is playing files.

Push the TUNE/CH lever up to change to the next file.

Push the TUNE/CH lever down to change to the previous file.

To change the folders, push and hold the TUNE/CH lever up or down.

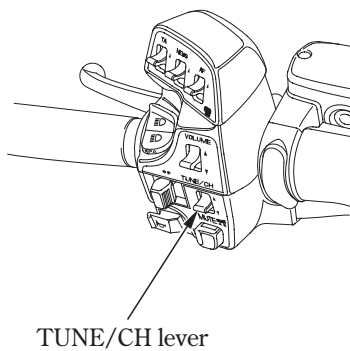



You can select repeat and random play modes when playing a file.

To select a play mode

Push the A.SEL RPT/RDM button until the desired play mode is displayed. The display changes as follows each time the A.SEL RPT/RDM button is pushed.

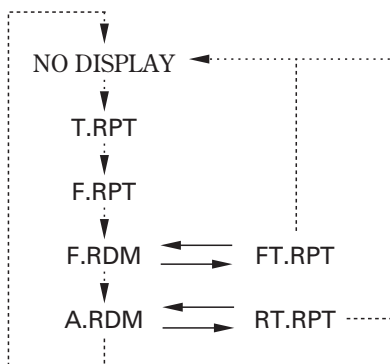

Push the A.SEL RPT/RDM button: .....>

Push and hold the A.SEL RPT/RDM button: ———>

Play Mode Menu Items

Mode	Function
T.RPT	Repeats the current file.
F.RPT	Repeats all files in the current folder.
F.RDM	Plays all files in the current folder in random order.
A.RDM	Plays all files in random order.
FT.RPT	Repeats current file in F.RDM play mode.
RT.RPT	Repeats current file in A.RDM play mode.





## FEATURES

### (Not required for operation)

---

#### USB Error Messages

If an error occurs while playing an iPod® or USB flash drive, you may see the following error messages. If you cannot clear the error message, contact a dealer.

Error Message	Cause	Solution
BAD USB DEVICE	Problem with the device or USB cable.	Turn the ignition switch off once and turn it on again. Reconnect the device. Do not reconnect the device that caused the error.
CHECK USB	Problem with the device or USB cable.	Turn the ignition switch off once and turn it on again. Reconnect the device. Do not reconnect the device that caused the error.
USB ERROR	Problem with the device or USB cable.	Turn the ignition switch off once and turn it on again. Reconnect the device. Do not reconnect the device that caused the error.
NO SONG	No files in device.	Check the files in device.
UNSUPPORTED	Use of unsupported device.	Update the firmware. Use supported device.
UNPLAYABLE	Problem with the audio unit or device.	Turn the ignition switch off once and turn it on again. Reconnect the device.





---

## INTERCOM (I-COM) SYSTEM

### System Control

Some local governments prohibit the use of a headset by the operator of a motor vehicle. Always obey applicable laws and regulations.

The intercom system may be used to communicate with your passenger. (If you want to use this system, you must have headsets.)

#### Power Switch:

- To turn the system on — push the I-COM button. (I-COM appears on the display.)
- To turn the system off — push and hold the I-COM button. (I-COM disappears.)

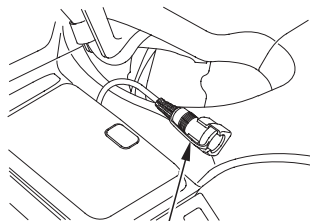

Front headset terminal

I-COM button



I-COM indicator



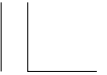

# FEATURES

## (Not required for operation)

---

### VOLUME Control

To select the Volume control, push the VOLUME knob/button until “INTERCOM VOL” is displayed (page 72 ). Then, within 5 seconds, change the volume control.

- To increase the volume — push the VOLUME lever up or turn the VOLUME knob/button clockwise.
- To decrease the volume — push the VOLUME lever down or turn the VOLUME knob/button counterclockwise.

To increase or decrease the volume rapidly — push the VOLUME lever up or down and hold it down.

(VOLUME level range: from 0 to 20)

VOLUME

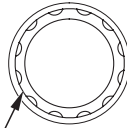

VOLUME knob/button

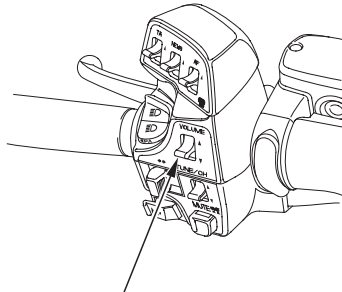

VOLUME lever

**INTERCOM VOL**

**VOL 8**





---

### Intercom Muting

The intercom mute system automatically lowers (does not silence) the music/program volume when you speak through the intercom.

The sensitivity of the intercom microphone to your voice or ambient sound sets the level at which the intercom system mutes the music/program volume.

To adjust this system – push the VOLUME knob/button until “INTERCOM MUTE” is displayed (page 72 ).

- To increase microphone sensitivity — turn the VOLUME knob/button clockwise.
- To decrease microphone sensitivity — turn the VOLUME knob/button counterclockwise. (Intercom Mute control range: from 0 to 20.)

**VOLUME**

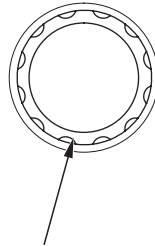

VOLUME knob/button

**INTERCOM MUTE**

**VOL 8**





## OPERATION

---

### PRE-RIDE INSPECTION

For your safety, it is very important to take a few moments before each ride to walk around your motorcycle and check its condition. If you detect any problem, be sure you take care of it, or have it corrected by your dealer.

#### **WARNING**

Improperly maintaining this motorcycle or failing to correct a problem before riding can cause a crash in which you can be seriously hurt or killed.

Always perform a pre-ride inspection before every ride and correct any problems.



- Fuel level – Fill fuel tank when necessary (page 44).
- Throttle – Check for smooth opening and full closing in all steering positions.
- Engine oil level – Add engine oil if necessary (page 47). Check for leaks.
- Coolant level – Add coolant if required (page 43). Check for leaks.
- Brakes – Check operation;  
Front and Rear: check brake fluid level and pads wear (page 37 – 39).
- Lights and horn – Check that lights, indicators and horn function properly.
- Engine stop switch – Check for proper function (page 58).
- Clutch – Check clutch fluid level.
- Side stand ignition cut-off system – Check for proper function (page 153).
- Wheels and tyres – Check condition, air pressure and adjust if necessary (page 48).

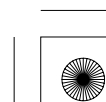
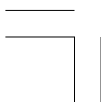





---

## **STARTING THE ENGINE**

Always follow the proper starting procedure described below.

This motorcycle is equipped with a side stand ignition cut-off system. The engine cannot be started if the side stand is down, unless the transmission is in neutral. If the side stand is up, the engine can be started in neutral or in gear with the clutch lever pulled in. After starting with the side stand down, the engine will shut off if the transmission is put in gear before raising the side stand.

To protect the catalytic converter in your motorcycle's exhaust system, avoid extending idling and the use of leaded petrol.

Your motorcycle's exhaust contains poisonous carbon monoxide gas. High levels of carbon monoxide can collect rapidly in enclosed areas such as a garage. Do not run the engine with the garage door closed. Even with the door open, run the engine only long enough to move your motorcycle out of the garage.

Do not use the electric starter for more than 5 seconds at a time. Release the start button for approximately 10 seconds before pressing it again.

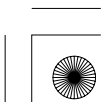
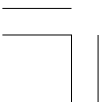



# OPERATION

---

## Preparation

Before starting, insert the key, turn the ignition switch ON and confirm the following:

- The transmission is in neutral  
(neutral indicator is ON).
- The engine stop switch is at  (RUN).
- The low oil pressure indicator is ON.
- The PGM-FI malfunction indicator lamp (MIL) is OFF.
- The immobilizer system (HISS) indicator is OFF.
- The ABS indicator light is ON.

The low oil pressure indicator should go off a few seconds after the engine starts. If the low oil pressure indicator lights during operation, stop the engine immediately and check the engine oil level.

## NOTICE

Operating the engine with insufficient oil pressure can cause serious engine damage.

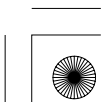
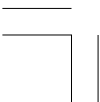



---

### Starting Procedure

This motorcycle has a fuel-injected engine with an automatic fast idle. Follow the procedure indicated below.

#### Any Air Temperature:

- Press the start button with the throttle completely closed.

The engine will not start if the throttle is fully open (because the electronic control module cuts off the fuel supply).

Snapping the throttle or fast idling for more than 5 minutes may cause exhaust pipe discolouration.

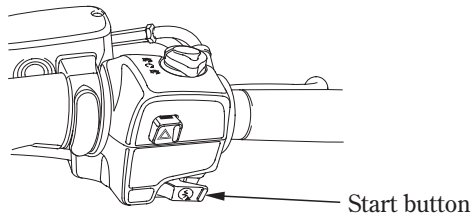

### Flooded Engine

If the engine fails to start after repeated attempts, it may be flooded with excess fuel. To clear a flooded engine.

1. Leave the engine stop switch set to  (RUN).
2. Open throttle fully.
3. Press the start button for 5 seconds.
4. Follow the normal starting procedure.
5. If the engine starts with unstable idle, open the throttle slightly.

If the engine does not start, wait for 10 seconds, then follow steps 1–4 again.

### Ignition Cut Off

Your motorcycle is designed to automatically stop the engine and fuel pump if the motorcycle is over-turned (a banking sensor cuts off the ignition system). Before restarting the engine, you must turn the ignition switch to the OFF position and then back to ON.





# OPERATION

---

## **RUNNING-IN**

Help assure your motorcycle's future reliability and performance by paying extra attention to how you ride during the first 500 km (300 miles).

During this period, avoid full-throttle starts and rapid acceleration.

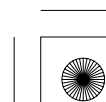
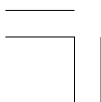



---

## RIDING

Review Motorcycle Safety (pages 1 – 19) before you ride.

Make sure you understand the function of the side stand mechanism. (See MAINTENANCE SCHEDULE on page 133 and explanation for SIDE STAND on page 153).

Make sure flammable materials such as dry grass or leaves do not come in contact with the exhaust system when riding, idling, or parking your motorcycle.

1. After the engine has been warmed up, the motorcycle is ready for riding.
2. While the engine is idling, pull in the clutch lever and depress the shift lever to shift into 1st (low) gear.
3. Slowly release the clutch lever and at the same time gradually increase engine speed by opening the throttle. Coordination of the throttle and clutch lever will assure a smooth positive start.
4. When the motorcycle attains a moderate speed, close the throttle, pull in the clutch lever and shift to 2nd gear by raising the shift lever.  
This sequence is repeated to progressively shift to 3rd, 4th, and OD (top) gear.
5. Coordinate the throttle and brakes for smooth deceleration.
6. Both front and rear brakes should be used at the same time and should not be applied strongly enough to lock the wheel, or braking effectiveness will be reduced and control of the motorcycle be difficult.

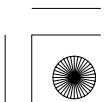
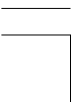
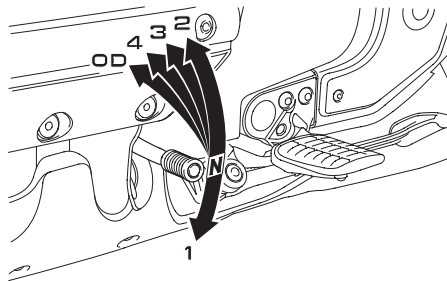



# OPERATION

---

## **BRAKING**

This motorcycle is equipped with a Dual CBS (Linked Braking System). Operating the front brake lever applies the front brake and a portion of the rear brake. Operating the rear brake pedal applies the rear brake and a portion of the front brake. For full braking effectiveness, use both the lever and pedal simultaneously, as you would with a conventional motorcycle braking system.

As with a conventional motorcycle braking system, excessively hard application of the brake controls may cause wheel lock, reducing control of the motorcycle.

For normal braking, apply both the brake pedal and lever while down-shifting to match your road speed. For maximum braking, close the throttle and firmly apply the pedal and lever; pull in the clutch lever before coming to a complete stop to prevent stalling the engine.

Important Safety Reminders:

- When possible, reduce speed or brake before entering a turn; closing the throttle or braking in mid-turn may cause wheel slip. Wheel slip will reduce control of the motorcycle.
- When riding in wet or rainy conditions, or on loose surfaces, the ability to maneuver and stop will be reduced. All of your actions should be smooth under these conditions. Rapid acceleration, braking or turning may cause loss of control. For your safety, exercise extreme caution when braking, accelerating or turning.
- When descending a long, steep grade, use engine compression braking by down-shifting, with intermittent use of both brakes. Continuous brake application can overheat the brakes and reduce their effectiveness.
- Riding with your foot resting on the brake pedal or your hand on the brake lever may actuate the brakelight, giving a false indication to other drivers. It may also overheat the brakes, reducing effectiveness.



---

### **Combined ABS**

This model is also equipped with an Anti-lock Brake System (ABS) designed to help prevent wheel lock up during hard braking on uneven or other poor surfaces while running straight. Although the wheel may not lock up—if you are braking too hard in a turn the motorcycle can still lose traction, causing a loss of control.

In some situations, a motorcycle with ABS may require a longer stopping distance to stop on loose or uneven surfaces than an equivalent motorcycle without ABS.

ABS cannot make up for road conditions, bad judgment, or improper operation of the brakes. It is still your responsibility to ride at reasonable speeds for weather, road surface, and traffic conditions, and to leave a margin of safety.

ABS is self-checking and always on.

ABS may be activated by riding over a sharp drop or rise in the road level. It is important to follow the tyre recommendations (page 48 ). The ABS computer works by comparing wheel speed. Non-recommended tyres can affect wheel speed and may confuse the ABS computer.

ABS does not function at low speeds (approximately 10 km/h (6 mph) or below).

ABS does not function if the battery is discharged.

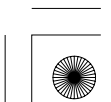
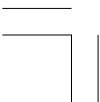



## OPERATION

---

### ABS Indicator Light

Normally, this light comes on when the ignition is turned ON and goes off after starting to ride. If there is an ABS problem, the indicator light comes on and remains on — or blinks. The ABS system does not operate when the ABS indicator light is on or blinking.

If the ABS indicator light blinks while riding, stop the motorcycle in a safe place and turn off the engine.

Turn the ignition ON again. The light should come on, and then go off after starting to ride. If it does not go off or if it blinks again, ABS is not functioning, but the brakes still work a Dual CBS and provide normal stopping ability. However, you should have the system checked by your dealer as soon as possible.

The ABS indicator light may blink if you turn the rear wheel placing the motorcycle upright on the stand. This is normal. Turn the ignition OFF to stop the blinking.

A orange LED is used for the ABS indicator light. Be sure that the LED lights when the ignition is ON. If the LED fails to light, see your dealer.

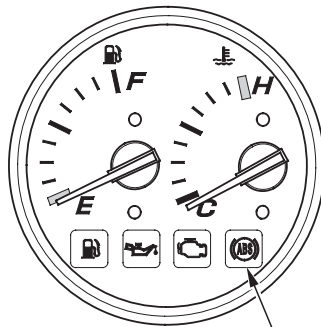

ABS indicator light







---

## **PARKING**

1. After stopping the motorcycle, shift the transmission into neutral, turn the ignition switch OFF and remove the key.
2. Use the side stand to support the motorcycle while parked.

Park the motorcycle on firm, level ground to prevent it from falling over. If you must park on a slight incline, aim the front of the motorcycle uphill to reduce the possibility of rolling off the side stand or overturning.

3. Lock the steering to help prevent theft (page 60 ).

Make sure flammable materials such as dry grass or leaves do not come in contact with the exhaust system when parking your motorcycle.

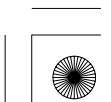
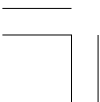



# OPERATION

---

## ANTI-THEFT TIPS

1. Always lock the steering and never leave the key in the ignition switch. This sounds simple but people do forget.
2. Be sure the registration information for your motorcycle is accurate and current.
3. Park your motorcycle in a locked garage whenever possible.
4. Use an additional anti-theft device of good quality.
5. Put your name, address, and phone number in this Owner's Manual and keep it on your motorcycles at all times.  
Many times stolen motorcycles are identified by information in the Owner's Manuals that are still with them.

NAME: \_\_\_\_\_

ADDRESS: \_\_\_\_\_

\_\_\_\_\_

\_\_\_\_\_

PHONE NO: \_\_\_\_\_

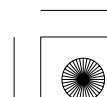
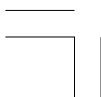



# MAINTENANCE

---

## THE IMPORTANCE OF MAINTENANCE

A well-maintained motorcycle is essential for safe, economical and trouble-free riding. It will also help reduce air pollution.

To help you properly care for your motorcycle, the following pages include a Maintenance Schedule and a Maintenance Record for regularly scheduled maintenance.

These instructions are based on the assumption that the motorcycle will be used exclusively for its designed purpose. Sustained high speed operation or operation in unusually wet or dusty conditions will require more frequent service than specified in the Maintenance Schedule. Consult your dealer for recommendations applicable to your individual needs and use.

If your motorcycle overturns or becomes involved in a crash, be sure your dealer inspects all major parts, even if you are able to make some repairs.

### **WARNING**

Improperly maintaining this motorcycle or failing to correct a problem before you ride can cause a crash in which you can be seriously hurt or killed.

Always follow the inspection and maintenance recommendations and schedules in this owner's manual.

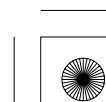
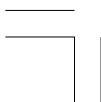



# MAINTENANCE

---

## MAINTENANCE SAFETY

This section includes instructions on some important maintenance tasks. You can perform some of these tasks with the tools provided — if you have basic mechanical skills.

Other tasks that are more difficult and require special tools are best performed by professionals. Wheel removal should normally be handled only by a Honda technician or other qualified mechanic; instructions are included in this manual only to assist in emergency service.

Some of the most important safety precautions follow. However, we cannot warn you of every conceivable hazard that can arise in performing maintenance. Only you can decide whether or not you should perform a given task.

### **WARNING**

Failure to properly follow maintenance instructions and precautions can cause you to be seriously hurt or killed.

Always follow the procedures and precautions in this owner's manual.

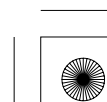
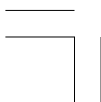



---

## SAFETY PRECAUTIONS

- Make sure the engine is off before you begin any maintenance or repairs. This will help eliminate several potential hazards:

- \* **Carbon monoxide poisoning from engine exhaust.**

- Be sure there is adequate ventilation whenever you operate the engine.

- \* **Burns from hot parts.**

- Let the engine and exhaust system cool before touching.

- \* **Injury from moving parts.**

- Do not run the engine unless instructed to do so.

- Read the instructions before you begin, and make sure you have the tools and skills required.
- To help prevent the motorcycle from falling over, park it on a firm, level surface, using the side stand or a maintenance stand to provide support.
- To reduce the possibility of a fire or explosion, be careful when working around petrol or batteries. Use only nonflammable solvent, not petrol, to clean parts. Keep cigarettes, sparks and flames away from the battery and all fuel-related parts.



Remember that your Honda dealer knows your motorcycle best and is fully equipped to maintain and repair it.

To ensure the best quality and reliability, use only new Honda Genuine Parts or their equivalents for repair and replacement.

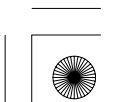
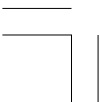



# MAINTENANCE

---

## MAINTENANCE SCHEDULE

Perform the Pre-ride Inspection (page 118) at each scheduled maintenance period.

I: INSPECT AND CLEAN, ADJUST, LUBRICATE OR REPLACE IF NECESSARY

C: CLEAN R: REPLACE A: ADJUST L: LUBRICATE

The following Maintenance Schedule specifies all maintenance required to keep your motorcycle in peak operating condition. Maintenance work should be performed in accordance with standards and specifications of Honda by properly trained and equipped technicians. Your dealer meets all of these requirements.

- \* Should be serviced by your dealer, unless the owner has proper tools and service data and is mechanically qualified. Refer to the Official Honda Shop Manual.
- \*\* In the interest of safety, we recommend these items be serviced only by your dealer.

Honda recommends that your dealer should road test your motorcycle after each periodic maintenance is carried out.

### NOTES (※):

- ※1. At higher odometer readings, repeat at the frequency interval established here.
- ※2. Service more frequently if the motorcycle is ridden in unusually wet or dusty areas.
- ※3. Service more frequently if the motorcycle is ridden often at full throttle or in the rain.
- ※4. Replacement requires mechanical skill.





ITEM	FREQUENCY	PRE-RIDE CHECK (P.118)	ODOMETER READING (*1)						ANNUAL CHECK	REGULAR REPLACE	Refer to page
			× 1000 km	1	12	24	36	48			
			× 1000 mi	0.6	8	16	24	32			
* FUEL LINE				I	I	I	I	I		—	
FUEL LEVEL	I									44	
* THROTTLE OPERATION	I			I	I	I	I	I		—	
* AIR CLEANER *2					R		R			—	
CRANKCASE BREATHER *3				C	C	C	C	C		148	
SPARK PLUG					R		R			149	
* VALVE CLEARANCE					I		I			—	
ENGINE OIL	I		R	R	R	R	R	R		143	
ENGINE OIL FILTER			R	R	R	R	R	R		145	
* ENGINE IDLE SPEED				I	I	I	I	I		—	
RADIATOR COOLANT *4	I			I	I	I	I	I	3 years	42, 151	
* COOLING SYSTEM				I	I	I	I	I		—	
* SECONDARY AIR SUPPLY SYSTEM				I	I	I	I	I		—	
* FINAL DRIVE OIL									3 years	—	
BRAKE FLUID *4	I			I	I	I	I	I	2 years	37, 39	
BRAKE PADS WEAR	I			I	I	I	I	I		162	
BRAKE SYSTEM				I	I	I	I	I		37, 39, 162	
* BRAKELIGHT SWITCH				I	I	I	I	I		—	
* HEADLIGHT AIM				I	I	I	I	I		65	
LIGHTS/HORN	I									59	
ENGINE STOP SWITCH	I									58	
CLUTCH SYSTEM				I	I	I	I	I		40	
CLUTCH FLUID *4	I			I	I	I	I	I	2 years	40	
SIDE STAND	I			I	I	I	I	I		153	
* SUSPENSION				I	I	I	I	I		152	
* NUTS, BOLTS, FASTENERS				I	I	I	I	I		—	
** WHEELS/TYRES	I			I	I	I	I	I		—	
** STEERING HEAD BEARINGS				I	I	I	I	I		—	





# MAINTENANCE

---

## TOOL KIT

The tool kit is located in the left saddlebag (page 62 ).

Some roadside repairs, minor adjustments and parts replacement can be performed with the tools contained in the kit.

- Spark plug wrench
- 8 mm Open end wrench
- 10 × 12 mm Open end wrench
- 14 × 17 mm Open end wrench
- 10 × 12 mm Box end wrench
- 14 × 17 mm Box end wrench
- Pliers
- Screwdriver handle
- No. 2 Phillips screwdriver
- No. 2 screwdriver
- 5 mm Hex wrench
- 6 mm Hex wrench
- 8 mm Box wrench
- 0.7 mm Feeler gauge
- Tool bag

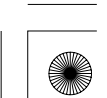
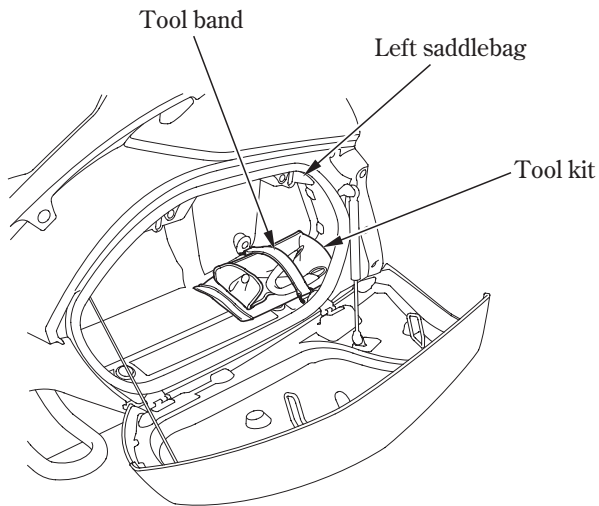



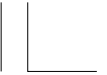

---

### SERIAL NUMBERS

The frame and engine serial numbers are required when registering your motorcycle. They may also be required by your dealer when ordering replacement parts.

Record the numbers here for your reference.

The frame number is stamped on the right side of the steering head.

The engine number is stamped on the right side of the crankcase, near the oil level gauge.

FRAME NO. \_\_\_\_\_

ENGINE NO. \_\_\_\_\_

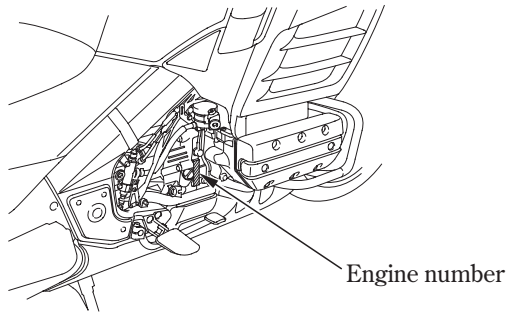
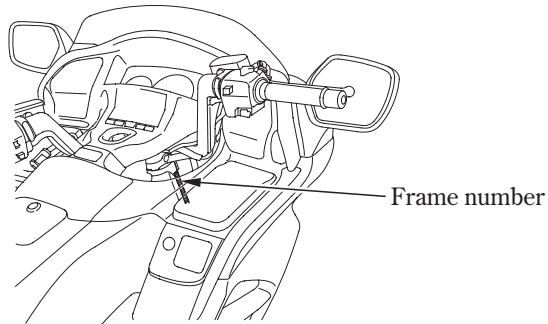



# MAINTENANCE

---

## COLOUR LABEL

The colour label is attached inside the fuel filler lid (page 44 ).

It is helpful when ordering replacement parts. Record the colour and code here for your reference.

COLOUR \_\_\_\_\_

CODE \_\_\_\_\_

Colour label

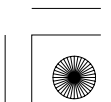
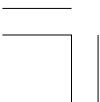
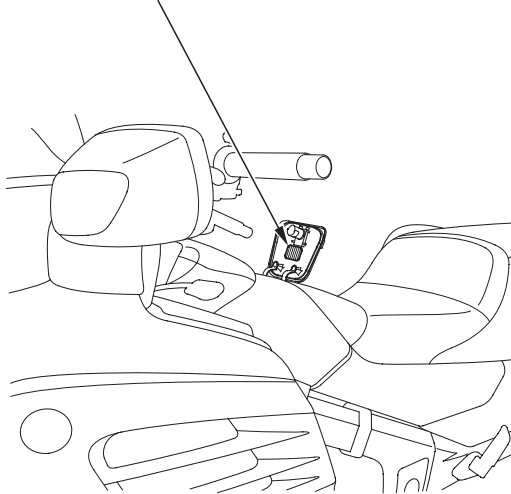

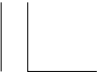

---

## COVER REMOVAL

Refer to the Safety Precautions on page 131.

Left side shown; right side similar.

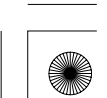
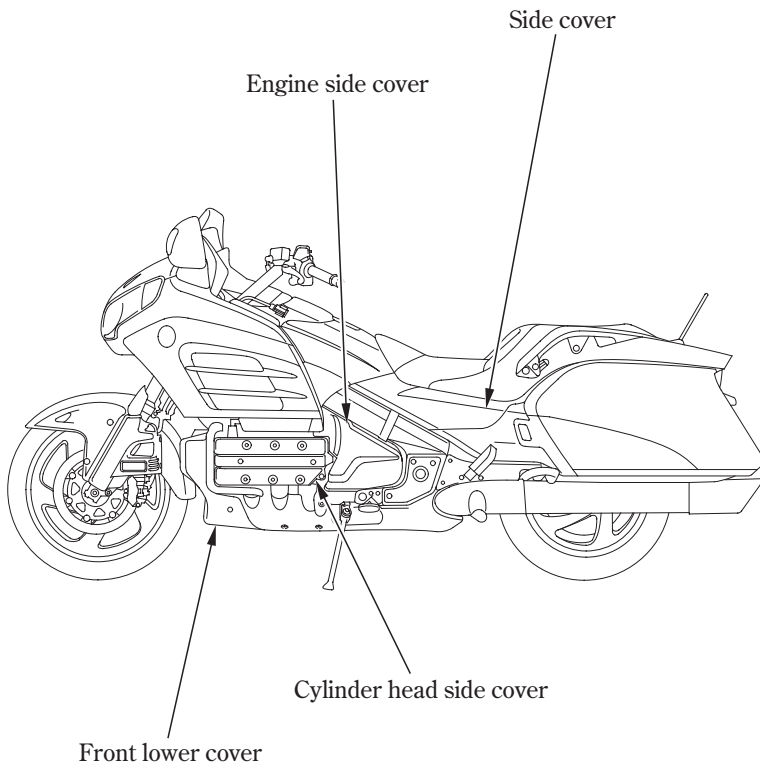



# MAINTENANCE

---

## Side Cover

### Removal:

1. Open the saddlebag (page 62 ).
2. Pull the side cover out until the prongs A are clear of the frame grommets.
3. Carefully pull the side cover out until the prongs B are clear of the frame grommets.
4. Carefully remove the side cover.

### Installation:

1. Insert the top edge of the side cover under the seat.
2. Position the side cover so the prongs on the inside of the cover are lined up above their securing grommets.
3. Push the cover in place.
4. Close the saddlebag.

### **NOTICE**

Failure to use extreme care removing or installing the side covers may damage the side cover hooks.

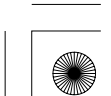
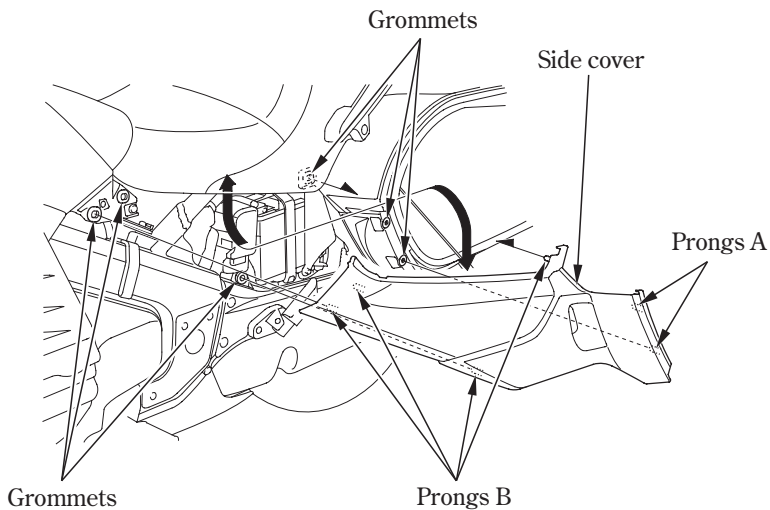



---

## Engine Side Cover

### Removal:

1. Carefully pull the rear of the engine side cover out until the prongs are clear of their securing slots.
2. Remove the engine side cover backward.

### Installation:

- Installation can be done in the reverse order of removal.

### **NOTICE**

Failure to use extreme care removing or installing the side covers may damage the side cover hooks.

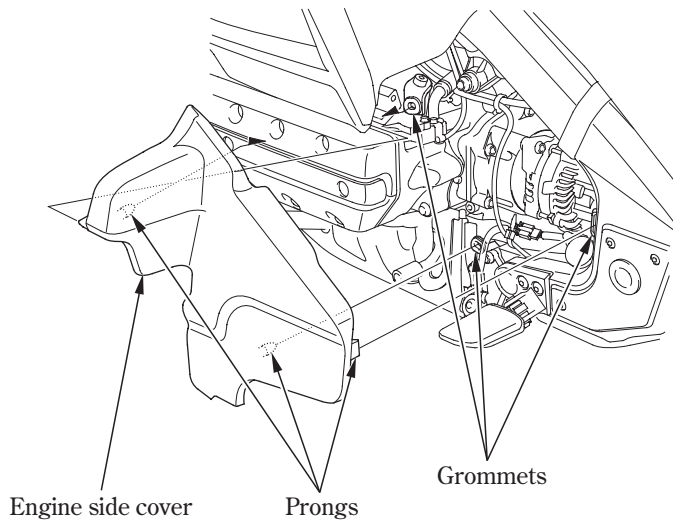

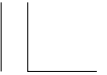

# MAINTENANCE

---

## Cylinder Head Side Cover

### Removal:

1. Remove the rubber plugs.
2. Remove the bolts.

### Installation:

- Installation can be done in the reverse order of removal.

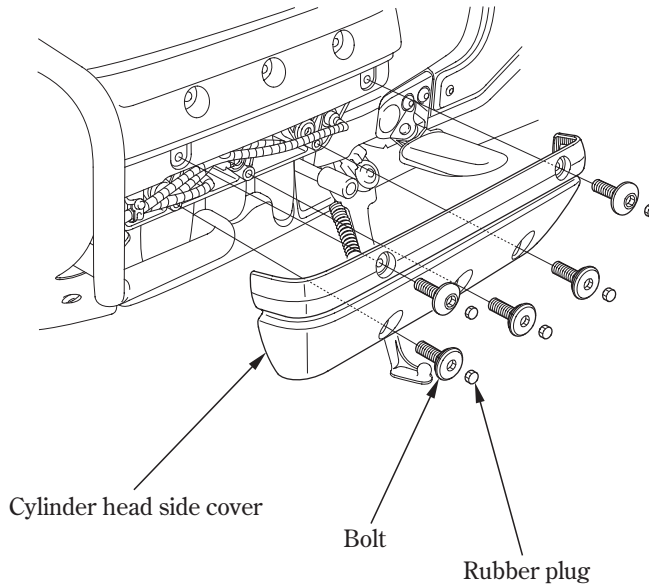

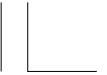

---

### Front Lower Cover

#### Removal:

1. Remove the clips.
2. Remove the bolt A and bolts B.

#### Installation:

- Installation can be done in the reverse order of removal.

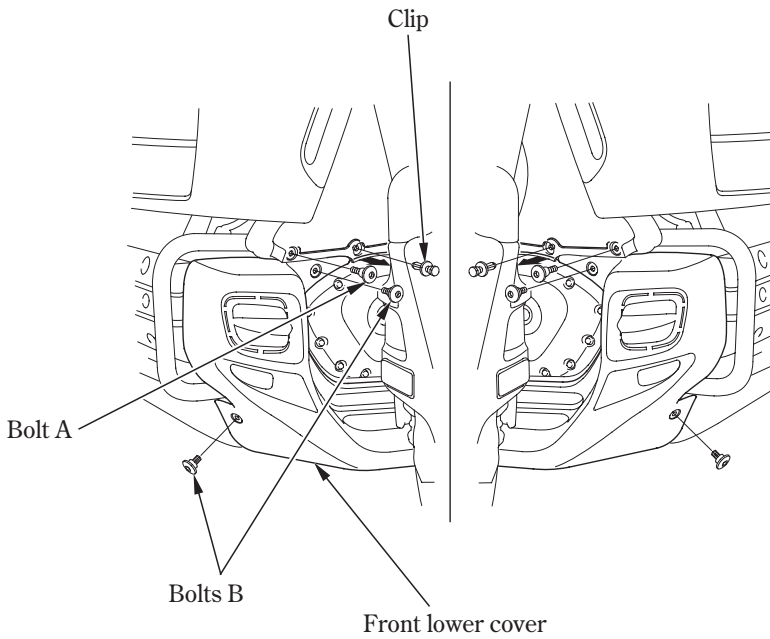



# MAINTENANCE

---

## CLIP

### Removal:

1. Press down on the centre pin to release the lock.
2. Pull out the clip from the hole.

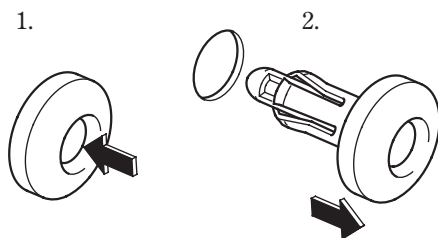

### Installation:

1. Push the bottom of the pin.
2. Insert the clip into the hole.
3. Lightly press down on the centre pin to lock the clip.

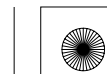
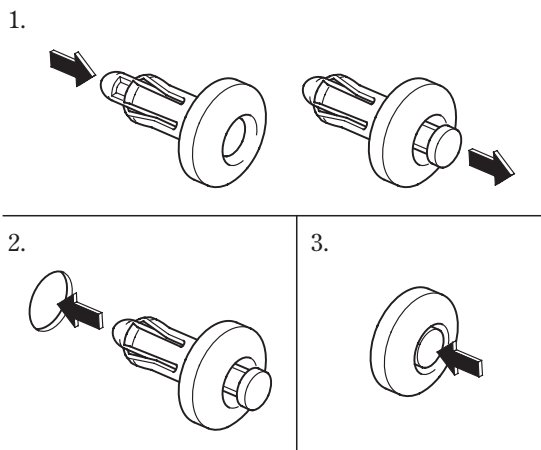



**ENGINE OIL**

Refer to the Safety Precautions on page 131.

**Oil Recommendation**

API classification	SG or higher except oils labeled as energy conserving or resource conserving on the circular API service label
Viscosity	SAE 10W-30
JASO T 903 standard	MA

**Suggested Oil**

Honda "4-STROKE MOTORCYCLE OIL" or equivalent.

Your motorcycle does not need oil additives. Use the recommended oil.

Do not use oils with graphite or molybdenum additives. They may adversely affect clutch operation.

Do not use API SH or higher oils displaying a circular API "energy conserving" or "resource conserving" service label on the container. They may affect lubrication and clutch performance.



NOT RECOMMENDED

OK

Do not use non-detergent, vegetable, or castor based racing oils.





# MAINTENANCE

---

## Viscosity:

Viscosity grade of engine oil should be based on average atmospheric temperature in your riding area. The following provides a guide to the selection of the proper grade or viscosity of oil to be used at various atmospheric temperatures.

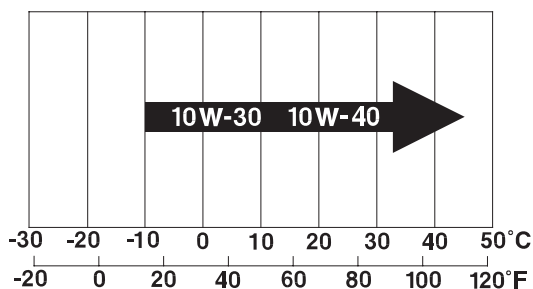

## JASO T 903 standard

The JASO T 903 standard is an index for engine oils for 4-stroke motorcycle engines.

There are two classes: MA and MB.

Oil conforming to the standard is labeled on the oil container. For example, the following label shows the MA classification.

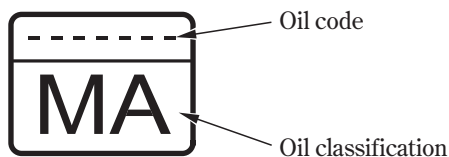



---

### **Engine Oil and Filter**

Engine oil quality is the chief factor affecting engine service life. Change the engine oil as specified in the maintenance schedule (page 133).

When running in very dusty conditions, oil changes should be performed more frequently than specified in the maintenance schedule.

Please dispose of used engine oil in a manner that is compatible with the environment. We suggest you take it in a sealed container to your local recycling centre or service station for reclamation. Do not throw it in the trash or pour it on the ground or down a drain.

Used engine oil may cause skin cancer if repeatedly left in contact with the skin for prolonged periods. Although this is unlikely unless you handle used oil on a daily basis, it is still advisable to thoroughly wash your hands with soap and water as soon as possible after handling used oil.

Changing the oil filter requires a special oil filter tool and a torque wrench. If you do not have these tools and the necessary skill, we recommend that you have your dealer perform this service.

If a torque wrench is not used for this installation, see your dealer as soon as possible to verify proper assembly.

Change the engine oil with the engine at normal operating temperature and the motorcycle on its centre stand to assure complete and rapid draining.

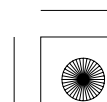
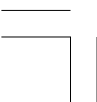



## MAINTENANCE

---

1. Park your motorcycle on a firm, level surface.
2. If the engine is cold, start it and let it idle for 3–5 minutes. Turn the engine off. Wait 2–3 minutes for the oil to settle.
3. Remove the right engine side cover (page 139 ).
4. Remove the front lower cover (page 141 ).
5. To drain the oil, remove the oil fill cap/dipstick, crankcase drain bolt, and sealing washer.
6. Remove the oil filter with a filter wrench and let the remaining oil drain out. Discard the oil filter.

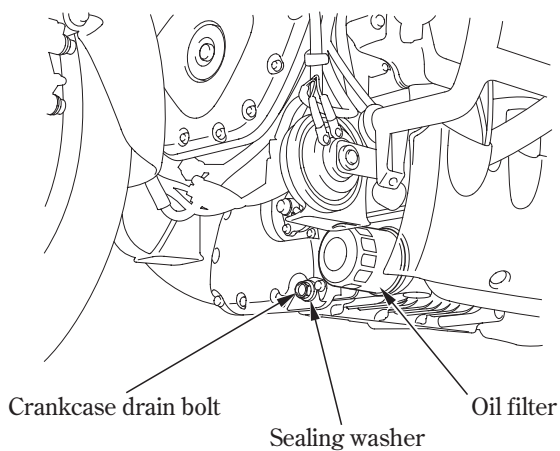

7. Apply a thin coat of engine oil to the new oil filter rubber seal.

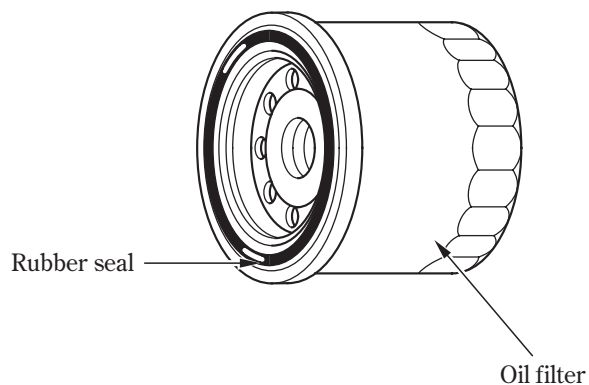



- 
- Using a special tool and a torque wrench, install the new oil filter and tighten to a torque of:

**26 N·m (2.7 kgf·m , 19 lbf·ft)**

Use only the Honda Genuine oil filter or a filter of equivalent quality specified for your model. Using the wrong Honda filter or a non-Honda filter which is not of equivalent quality may cause engine damage.

- Install a new sealing washer onto the drain bolt.  
Install the drain bolt and tighten.

Oil drain bolt torque:

**34 N·m (3.5 kgf·m , 25 lbf·ft)**

- Fill the crankcase with the recommended grade oil; approximately:

**3.7 ℓ (3.9 US qt , 3.3 Imp qt)**

- Install the oil fill cap/dipstick.

- Start the engine and let it idle for 3–5 minutes.

- 2–3 minutes after stopping the engine, check that the oil level is at the upper level mark on the oil fill cap/dipstick with the motorcycle upright on firm, level ground. Make sure there are no oil leaks.

- Install the right engine side cover (page 139).

- Install the front lower cover (page 141).

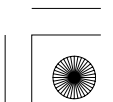
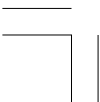



## MAINTENANCE

---

### CRANKCASE BREATHER

Refer to the Safety Precautions on page 131.

1. Remove the left cylinder head side cover (page 140).
2. Place a drain pan under the crankcase breather tube plug.
3. Remove the crankcase breather tube plug from the tube and drain deposits.
4. Reinstall the crankcase breather tube plug.
5. Reinstall the left cylinder head side cover.

Service more frequently when ridden in rain, at full throttle, or when deposits can be seen in the transparent section of the drain tube.

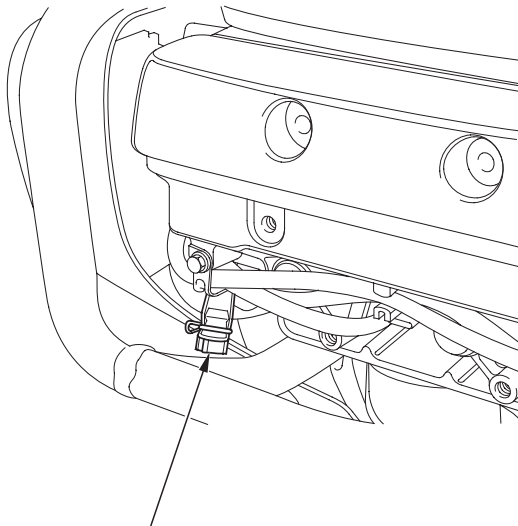

Crankcase breather tube plug





---

## SPARK PLUGS

Refer to the Safety Precautions on page 131.

Recommended plugs:

Standard:

BKR6E-11 (NGK) or K20PR-U11 (DENSO)

For cold climate: (Below 5°C, 41°F)

BKR5E-11 (NGK) or K16PR-U11 (DENSO)

For extended high speed riding:

BKR7E-11 (NGK) or K22PR-U11 (DENSO)

### NOTICE

Never use a spark plug with an improper heat range. Severe engine damage could result.

1. Remove the left and right cylinder head side cover (page 140).
2. Clean any dirt from around the spark plug bases.
3. Disconnect the spark plug caps. Take care to avoid damaging the spark plug wire when disconnecting the caps.
4. Using a spark plug wrench provided in the tool kit, remove the spark plugs.

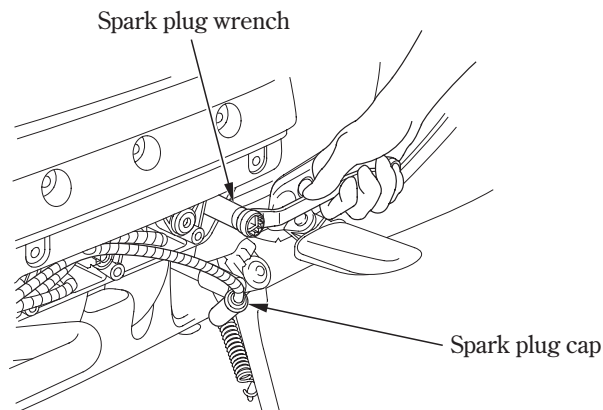



## MAINTENANCE

---

5. Discard the spark plug.
6. With the plug washers attached, thread the spark plugs in by hand to prevent cross-threading.
7. Tighten each spark plug:
  - If the old plug is good:  
1/8 turn after it seats.
  - If installing a new plug, tighten it twice to prevent loosening:
    - a) First, tighten the plug:  
NGK: 3/4 turn after it seats.  
DENSO: 1/2 turn after it seats.
    - b) Then loosen the plug.
    - c) Next, tighten the plug again:  
1/8 turn after it seats.

### NOTICE

Improperly tightened spark plugs can damage the engine. If a plug is too loose, a piston may be damaged. If a plug is too tight, the threads may be damaged.

8. Reinstall the spark plug caps. Take care to avoid pinching any cables or wires.
9. Reinstall the cylinder head side cover.

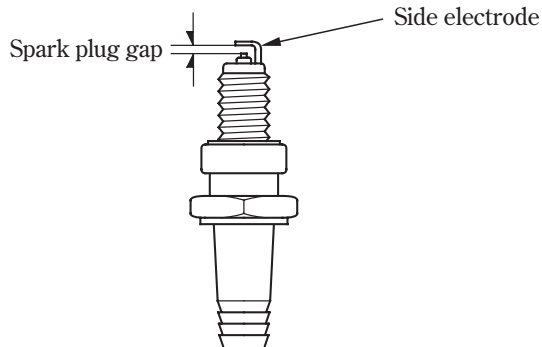





---

## COOLANT

Refer to the Safety Precautions on page 131 .

### Coolant Replacement

Coolant should be replaced by your dealer, unless the owner has proper tools and service data and is mechanically qualified. Refer to an official Honda Shop Manual.

Always add coolant to the reserve tank. Do not attempt to add coolant by removing the radiator cap.

### WARNING

Removing the radiator cap while the engine is hot can cause the coolant to spray out, seriously scalding you.

Always let the engine and radiator cool down before removing the radiator cap.

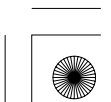
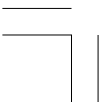



# MAINTENANCE

---

## FRONT AND REAR SUSPENSION INSPECTION

Refer to the Safety Precautions on page 131 .

1. Check the fork assembly by locking the front brake and pumping the fork up and down vigorously. Suspension action should be smooth and there must be no oil leakage.
2. Swingarm bearings should be checked by pushing hard against the side of the rear wheel while the motorcycle is on a support block. Freeplay indicates worn bearings.
3. Carefully inspect all front and rear suspension fasteners for tightness.

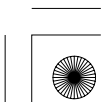
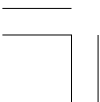



---

## **SIDE STAND**

Refer to the Safety Precautions on page 131.

Perform the following maintenance in accordance with the maintenance schedule.

### Functional Check:

- Check the spring for damage or loss of tension and the side stand assembly for freedom of movement.
- Check the side stand ignition cut-off system:
  1. Sit astride the motorcycle; put the side stand up and the transmission in neutral.
  2. Start the engine and with the clutch lever pulled in, shift the transmission into gear.
  3. Lower the side stand. The engine should stop as you put the side stand down.

If the side stand system does not operate as described, see your dealer for service.

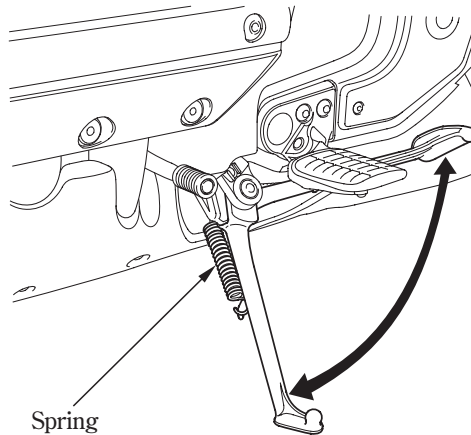



# MAINTENANCE

---

## WHEEL REMOVAL

Refer to the Safety Precautions on page 131 .

### Front Wheel Removal

We recommend wheel removal be done only by your dealer or another qualified mechanic. Do not attempt to remove the wheel on your own. Wheel removal requires mechanical skill and professional tools.

1. Park your motorcycle on a firm, level surface.
2. Raise the front wheel off the ground by placing a support block under the engine, being careful to avoid contact with the exhaust pipe and front lower cover.

3. Remove the parts in sequence, according to the order in the illustration.

- When removing and installing the wheel, be careful not to damage the sensor and pulser ring.
- To avoid damage to the brake hose during removal, support the caliper assembly so that it doesn't hang from the hose. Do not twist the brake hose.

Avoid getting grease, oil, or dirt on the disc or pad surfaces. Any contamination can cause poor brake performance or rapid pad wear after reassembly.

- Avoid depressing the brake lever and brake pedal when the wheel is off the motorcycle.

This will force the caliper pistons out of the cylinders. The result will be a loss of brake fluid. If this occurs, the brake system will require service. See your dealer for this service.

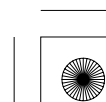
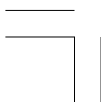

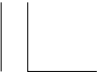

---

For related torque specifications, see page 157. Cover both sides of the front wheel with protective tape or an equivalent.  
The numbers indicate the disassembly sequence.

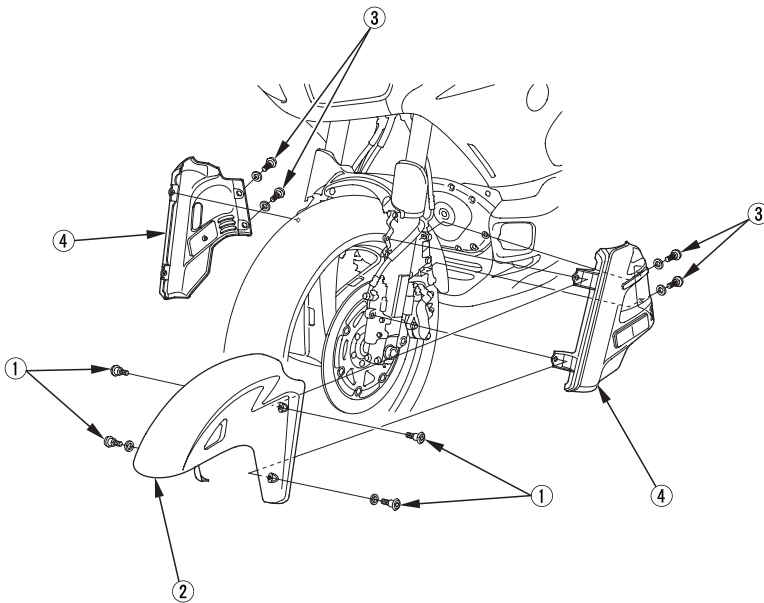
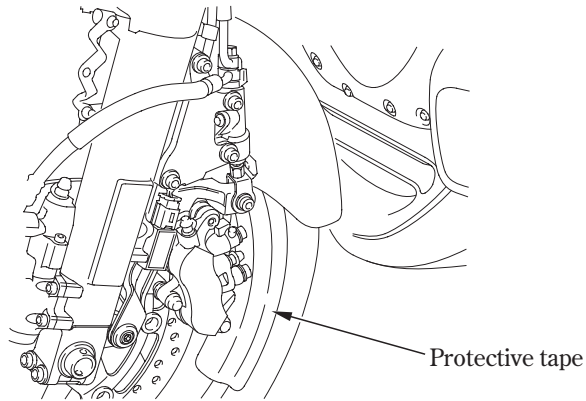



# MAINTENANCE

---

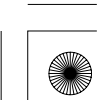
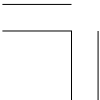
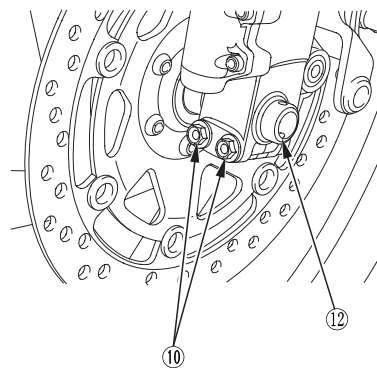
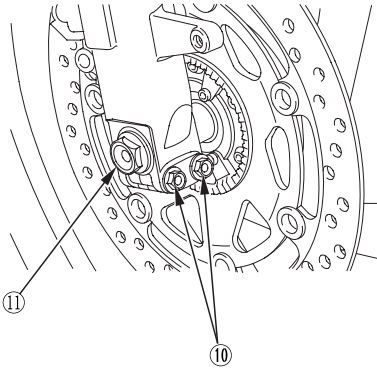
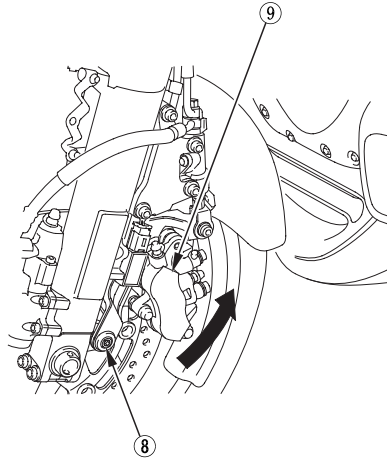
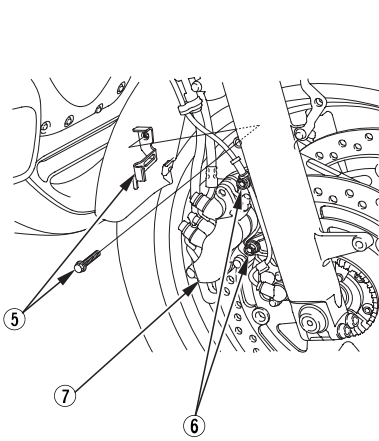



---

## Front Wheel Installation

1. Reassemble the removed parts in the reverse order of removal.

- Position the wheel between the fork legs and insert the front axle shaft from the left side, through the left fork leg and wheel hub.
- Align the index line of the front axle shaft with the recessed surface of the fork leg.

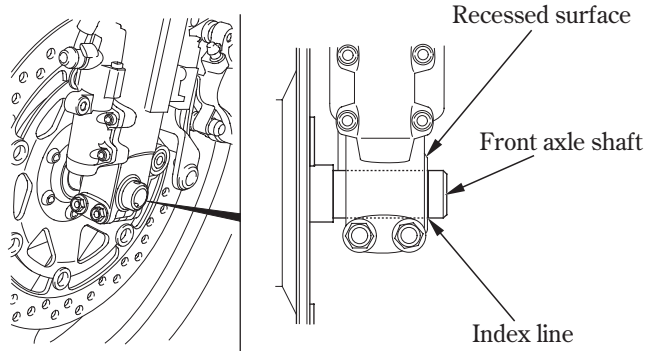

- Fit the brake disc carefully between the brake pads to avoid damaging the pads.

2. Install the bolts and tighten to the specified torque:

front axle bolt:

59 N·m (6.0 kgf·m , 44 lbf·ft)

right caliper fixing bolts:

31 N·m (3.2 kgf·m , 23 lbf·ft)

left caliper socket bolts:

31 N·m (3.2 kgf·m , 23 lbf·ft)

3. Measure the clearance between the brake disc and the caliper holder on each side with a 0.7 mm (0.028 in) feeler gauge.

- If the feeler gauge inserts easily, remove it and tighten the axle pinch bolts to the specified torque:  
22 N·m (2.2 kgf·m , 16 lbf·ft)
- If the feeler gauge cannot be inserted easily, loosen the left axle pinch bolt and pull the left fork outward or push inward to adjust the clearance. Then tighten the axle pinch bolts to the specified torque.





## MAINTENANCE

---

Failure to provide adequate disc to caliper holder clearance may damage the brake discs and impair braking efficiency.

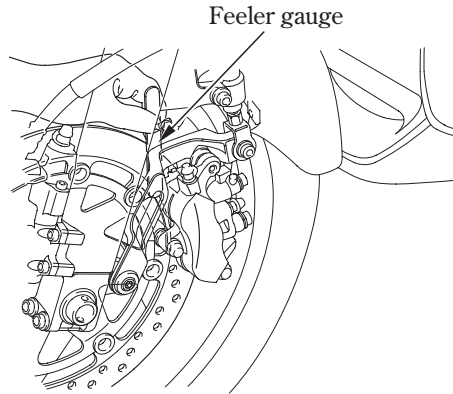

4. After installing the front wheel, apply the brake lever AND brake pedal several times, then recheck both discs for caliper holder to disc clearance. Do not operate the motorcycle without adequate clearance.

- Check for free wheel rotation after the brake lever and brake pedal are released. Recheck the wheel if the brake drags or if the wheel does not rotate freely.
- After installing the wheel, operate the brake lever AND brake pedal several times until you feel pressure. You must restore pressure from BOTH the lever AND the pedal because this motorcycle is equipped with a Dual Combined Brake System.
- Verify proper brake operation before riding.

5. Remove the protective tapes from the front wheel.

If a torque wrench is not used for installation, see your dealer as soon as possible to verify proper assembly. Improper assembly may lead to loss of braking capacity.







---

### **Rear Wheel Removal**

We recommend wheel removal be done only by your dealer or another qualified mechanic. Do not attempt to remove the wheel on your own. Wheel removal requires mechanical skill and professional tools.

1. Support the motorcycle securely, raise the rear wheel off the ground.
2. Remove the parts in sequence, according to the order in the illustration.
  - Avoid getting grease, oil, or dirt on the disc or pad surfaces. Any contamination can cause poor brake performance or rapid pad wear after reassembly.
  - When removing and installing the wheel, be careful not to damage the sensor and pulser ring.

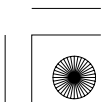
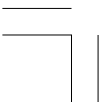



# MAINTENANCE

---

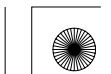
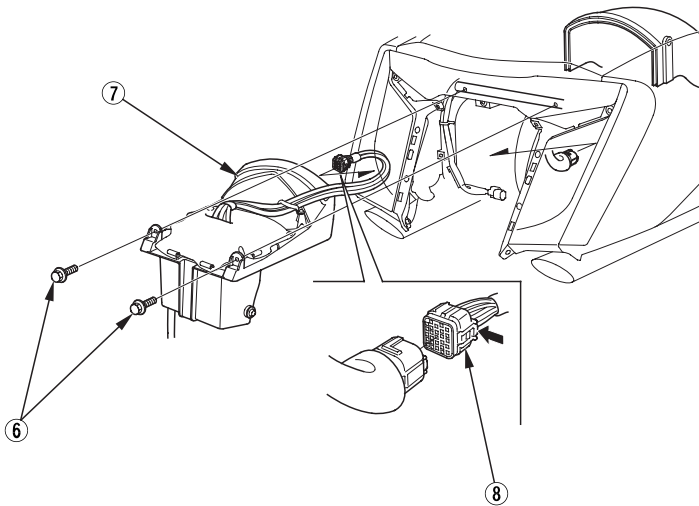
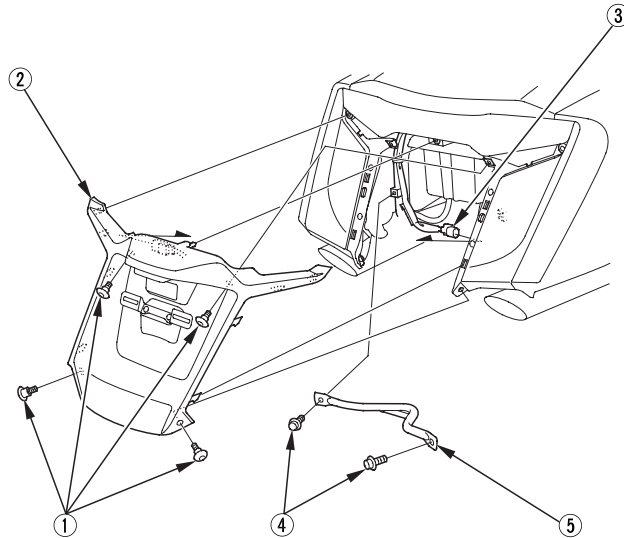

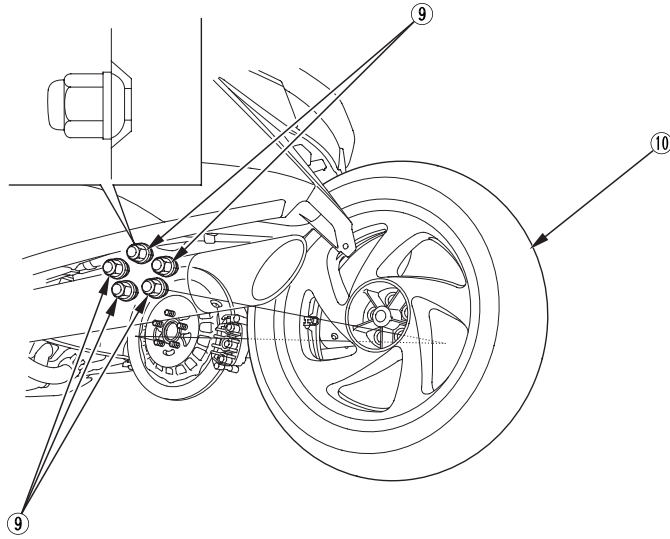

### Rear Wheel Installation

1. Reassemble the removed parts in the reverse order of removal.
2. Tighten the rear wheel nuts to the specified torque:  
108 N·m (11.0 kgf·m , 80 lbf·ft)
3. After installing the wheel, apply the brake several times and then check if the wheel rotates freely. Recheck the wheel if the brake drags or if the wheel does not rotate freely.

If a torque wrench is not used for installation, see your dealer as soon as possible to verify proper assembly. Improper assembly may lead to loss of braking capacity.

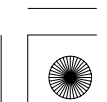
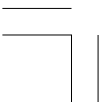



# MAINTENANCE

---

## **BRAKE PAD WEAR**

Refer to the Safety Precautions on page 131.

Brake pad wear depends upon the severity of usage, the type of riding, and road conditions. (Generally, the pads will wear faster on wet and dirty roads.) Inspect the pads at each regular maintenance interval (page 133).

### **Front Brake**

Always inspect each pad in both right and left brake calipers.

Check the grooves in each pad.

If either pad is worn to the grooves, replace both pads as a set. See your dealer for this service.

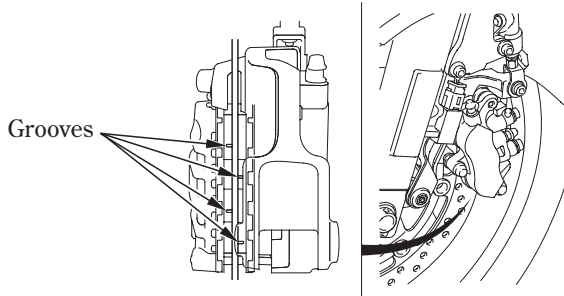

### **Rear Brake**

Check the cutout in each pad.

If either pad is worn to the cutout, replace both pads as a set. See your dealer for this service.

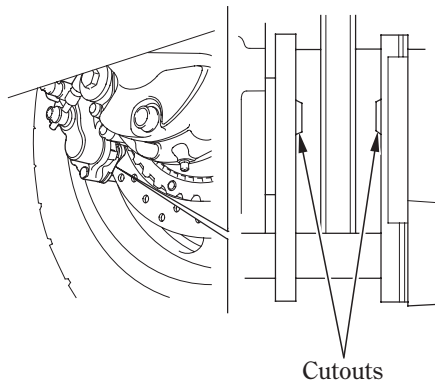



---

## **BRAKE SYSTEM INSPECTION**

Refer to the Safety Precautions on page 131.

Check the brake system as follows:

1. Place the motorcycle on its side stand, stop the engine, and place the transmission in neutral.
2. Support the motorcycle securely, raise the rear wheel off the ground.
3. Move the left caliper assembly upward while slowly rotating the rear wheel.  
The brake system is normal if the rear wheel stops. If the rear wheel does not stop, see your dealer.

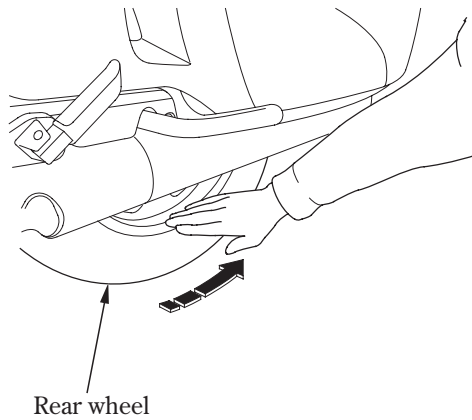
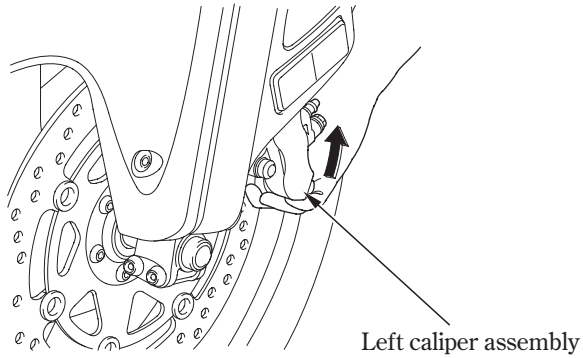



# MAINTENANCE

---

## BATTERY

Refer to the Safety Precautions on page 131.

It is not necessary to check the battery electrolyte level or add distilled water as the battery is a maintenance-free (sealed) type. If your battery seems weak and/or is leaking electrolyte (causing hard starting or other electrical troubles), contact your dealer.

### NOTICE

Your battery is a maintenance-free type and can be permanently damaged if the cap strip is removed.



This symbol on the battery means that this product must not be treated as household waste.

### NOTICE

An improperly disposed of battery can be harmful to the environment and human health.

Always confirm local regulations for battery disposal.

## WARNING

The battery gives off explosive hydrogen gas during normal operation.

A spark or flame can cause the battery to explode with enough force to kill or seriously hurt you.

Wear protective clothing and a face shield, or have a skilled mechanic do the battery maintenance.





---

The battery is located in the battery box behind the left side cover.  
After turning the ignition switch OFF, wait more than 10 seconds and then remove the negative cable of the battery.

**Removal:**

1. Make sure the ignition switch is OFF.
2. Remove the left side cover (page 138).
3. Pull the clip and remove battery plate.
4. Disconnect the negative (-) terminal lead from the battery first.
5. Remove the bolt and open the battery holder.
6. Disconnect the positive (+) terminal lead.
7. Pull the battery out of the battery box.

Be careful to avoid damaging the cover under the battery box when you remove the battery.

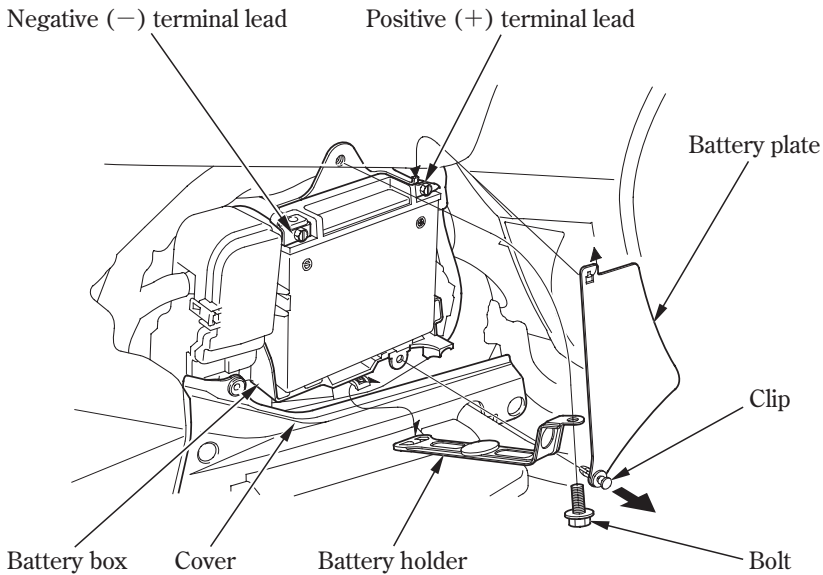

**Installation:**

1. Reinstall in the reverse order of removal. Be sure to connect the positive (+) terminal first, then the negative (-) terminal.
2. Check all bolts and other fasteners are secure.





# MAINTENANCE

---

## FUSE REPLACEMENT

Refer to the Safety Precautions on page 131.

When frequent fuse failure occurs, it usually indicates a short circuit or an overload in the electrical system. See your dealer for repair.

### NOTICE

Never use a fuse with a different rating from that specified. Serious damage to the electrical system or a fire may result, causing a dangerous loss of lights or engine power.

#### Recommended Fuses:

Main fuse A:	30 A
Main fuse B/External amplifier fuse:	120/40 A
Circuit fuses:	30 A, 20 A, 15 A, 10 A, 5 A

The fuse box (including spare fuses) is located behind the left side cover.  
The main fuse is located in the fuse box.

1. To prevent an accidental short circuit, turn the ignition switch OFF before checking or replacing the fuses.
2. Remove the left side cover (page 138).
3. Remove the fuse box cover.

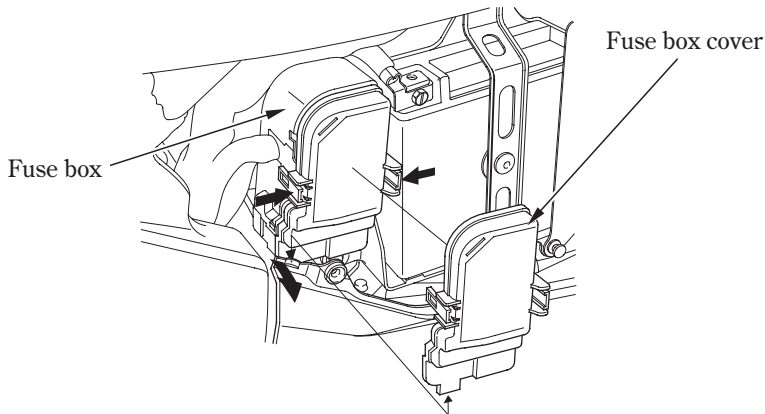





---

Main Fuse:

4. Check the main fuses (A & B/External Amplifier fuse) to see if they are blown.

To replace main fuses (A & B/External Amplifier fuse), see your dealer for this service.

Circuit Fuses:

5. To check or replace a circuit fuse, pull the old fuse out of its retaining clips with the fuse remover. Look for a burned wire inside the fuse. If the fuse is blown, replace it with a spare fuse the same rating or lower.

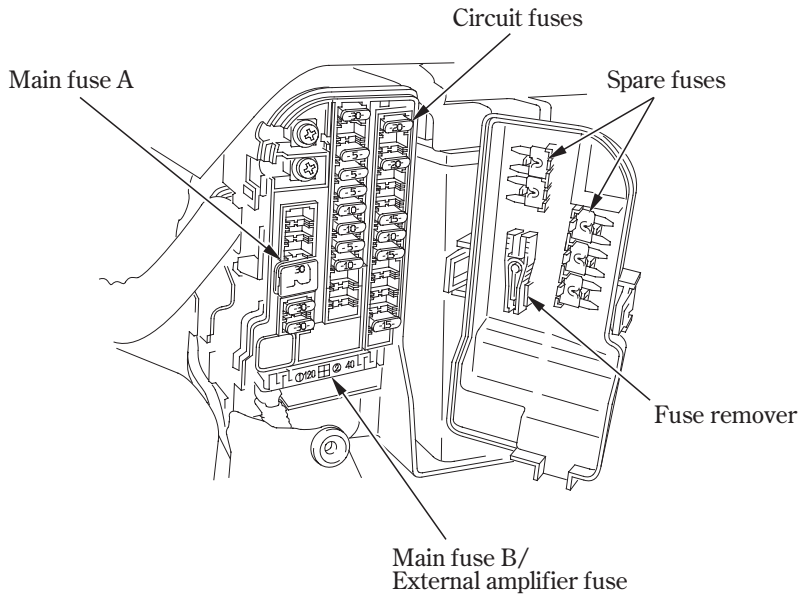

6. Close the fuse box cover.
7. Install the left side cover.





# MAINTENANCE

---

## **BULB REPLACEMENT**

Refer to the Safety Precautions on page 131 .

The light bulb becomes very hot while the light is ON, and remains hot for a while after it is turned OFF. Be sure to let it cool down before servicing.

Do not put finger prints on the headlight bulb, as they may create hot spots on the bulb and cause it to break.

Wear clean gloves while replacing the bulb.

If you touch the bulb with your bare hands, clean it with a cloth moistened with alcohol to prevent its early failure.

- Be sure to turn the ignition switch OFF when replacing the bulb.
- Do not use bulbs other than those specified.
- After installing a new bulb, check that the light operates properly.

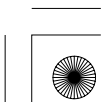



### High Beam Headlight Bulb

1. Attach a cloth and remove the cover with care using a flat-tip screwdriver.
2. Open the left fairing pocket cover and remove the clips (page 142).
3. Remove the bolts A and lid.

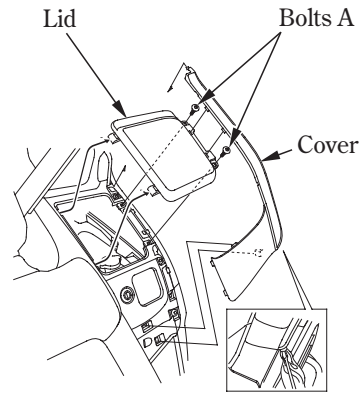
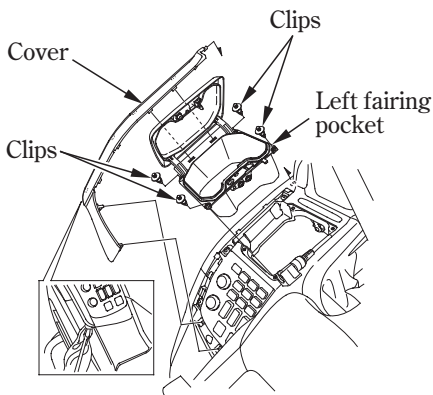

4. Pull off the socket without turning.
5. Remove the dust cover.
6. Remove the bulb while pressing down on the pin.
7. Pull out the bulb without turning.
8. Install a new bulb in the reverse order of removal.
  - Install the dust cover with its arrow mark facing up.

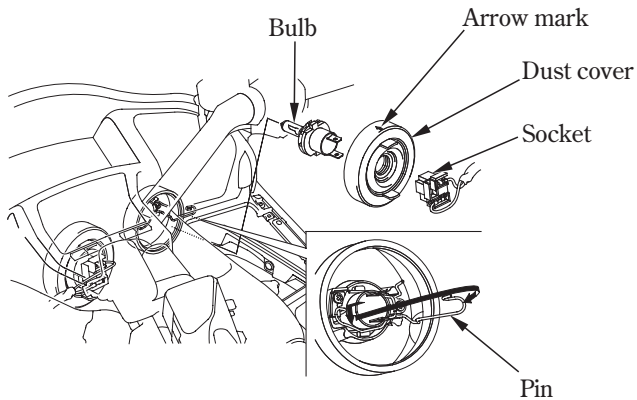



## MAINTENANCE

---

### Low Beam Headlight Bulb

1. Pull off the socket without turning.
2. Remove the dust cover.
3. Remove the bulb while pressing down on the pin.
4. Pull out the bulb without turning.
5. Install a new bulb in the reverse order of removal.
  - Install the dust cover with its arrow mark facing up.

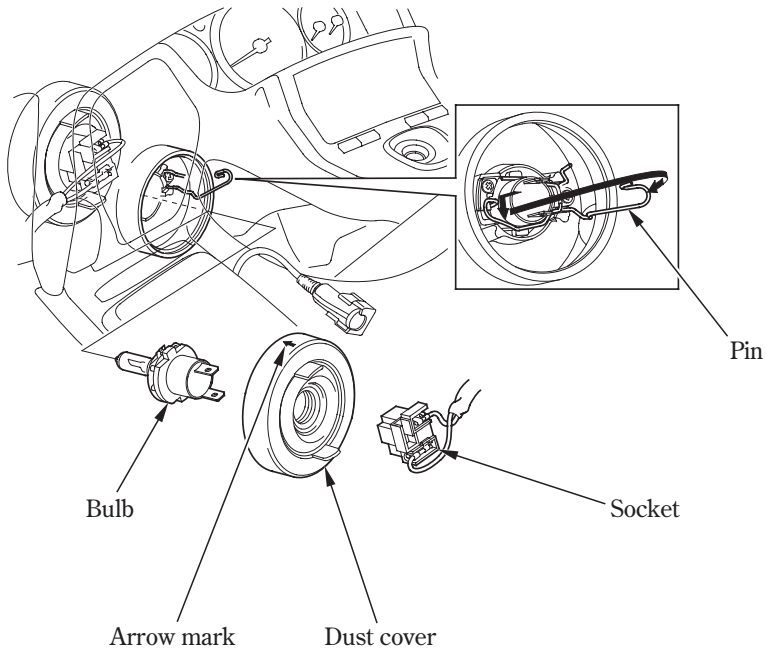



---

### Front Turn Signal Bulb

1. Remove the rearview mirror by removing the screw.

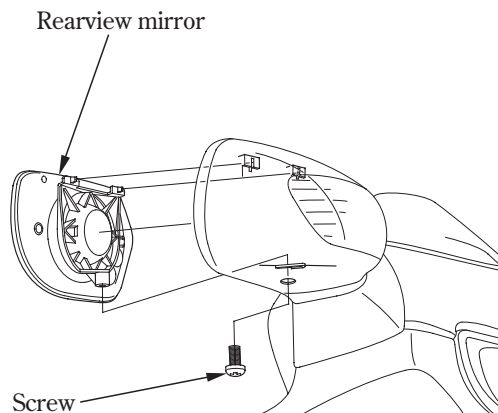

2. Turn the socket approximately 45° counterclockwise, then pull it out toward you.
3. Pull out the bulb without turning.
4. Install a new bulb in the reverse order of removal.

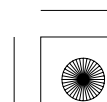
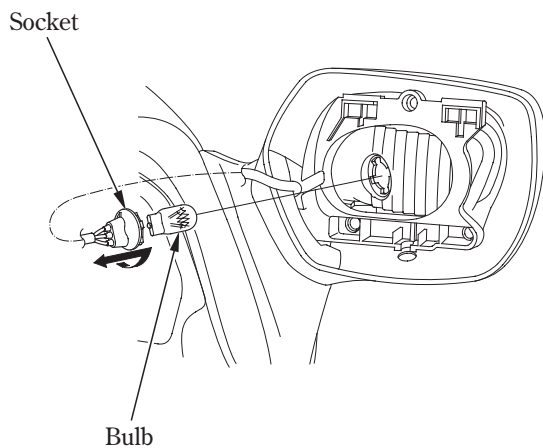



# MAINTENANCE

---

## Rear Turn Signal Bulb Brake/Tail Light Bulb

1. Remove the rear top end cover.

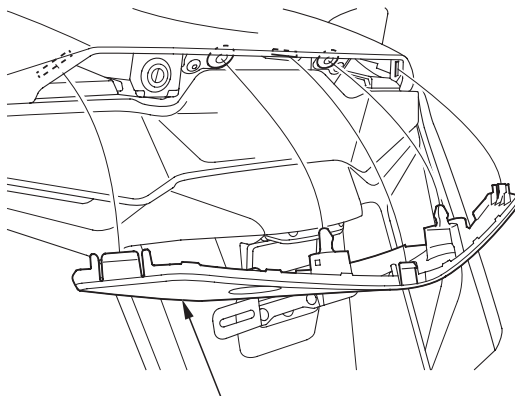

Rear top end cover

2. Open the saddlebags (page 62).
3. Remove the nuts and tail light assembly.

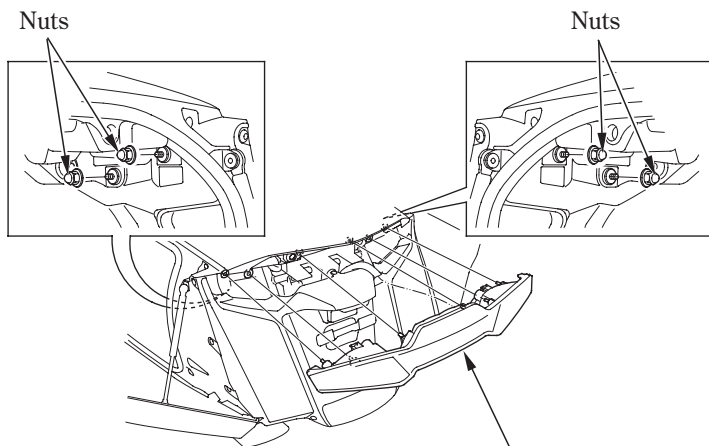

Tail light assembly





- 
4. Turn the socket approximately 45° counterclockwise, then pull it out toward you.
  5. Pull out the bulb without turning.
  6. Install a new bulb in the reverse order of removal.
    - Rear Turn Signal Bulb: Use only the amber bulb.

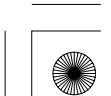
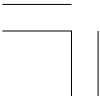
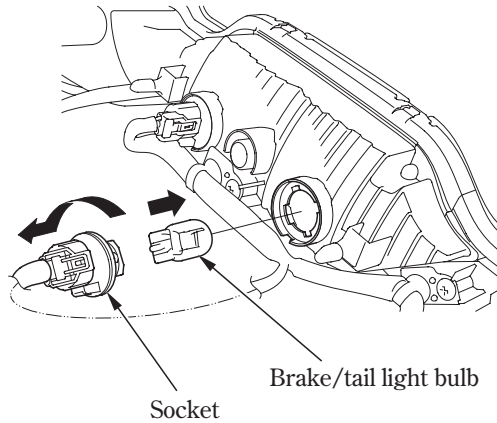
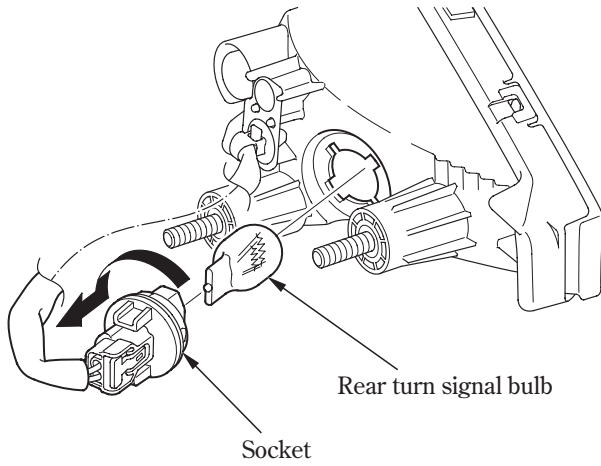



# MAINTENANCE

---

## License Light Bulb

1. Remove the license light cover by removing the screws.
2. Pull out the bulb without turning.
3. Install a new bulb in the reverse order of removal.

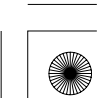
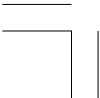
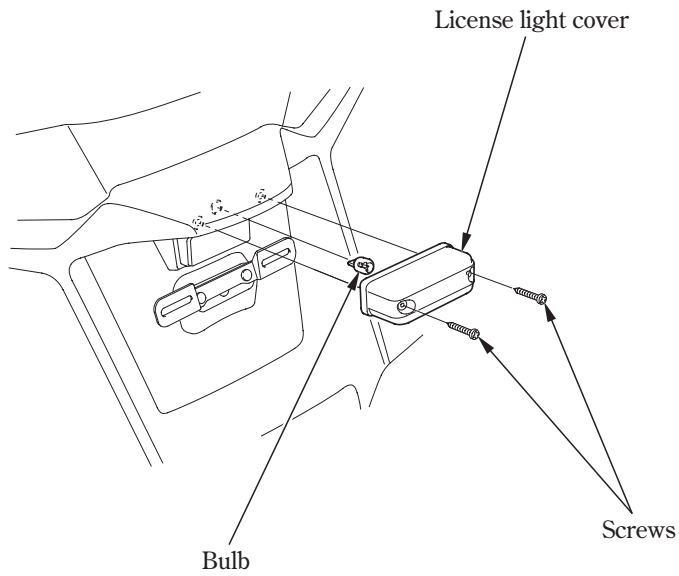





# CLEANING

---

## CLEANING

Clean your motorcycle regularly to protect the surface finishes and inspect for damage, wear, and oil, coolant, or fluid (brake and clutch) leakage.

Avoid cleaning products that are not specifically designed for motorcycle or automobile surfaces.

They may contain harsh detergents or chemical solvents that could damage the metal, paint, and plastic on your motorcycle.

If your motorcycle is still warm from recent operation, give the engine and exhaust system time to cool off.

Park in a shady area. Washing your motorcycle in bright sunlight may cause the finish to fade because water droplets intensify the sun's brightness. Spotting is also more likely because surface water can dry before you have time to wipe it off.

We recommend avoiding the use of high pressure water spray (typical in coin-operated car washes).

### NOTICE

High pressure water (or air) can damage certain parts of the motorcycle.

The audio system is designed to be weatherproof unless it is sprayed directly with a hose.

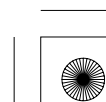
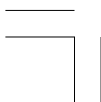



# CLEANING

---

## Washing the Motorcycle

1. Rinse the motorcycle thoroughly with cool water to remove loose dirt.
2. Clean the motorcycle with a sponge or soft cloth using cool water.  
Avoid directing water to muffler outlets and electrical parts.
3. Clean the plastic parts using a cloth or sponge dampened with a solution of mild detergent and water. Rub the soiled area gently rinsing it frequently with fresh water.  
Take care to keep brake fluid or chemical solvents off the motorcycle. They will damage the plastic and painted surfaces.

The inside of the headlight lens may be clouded immediately after washing the motorcycle. Moisture condensation inside the headlight lens will disappear gradually by lighting the headlight in high beam. Run the engine while keeping the headlight on.

4. After cleaning, rinse the motorcycle thoroughly with plenty of clean water and dry with a soft, clean cloth. Strong detergent residue can corrode alloy parts.
5. Dry the motorcycle, start the engine, and let it run for several minutes.
6. Test the brakes before riding the motorcycle. Several applications may be necessary to restore normal braking performance.

Braking efficiency may be temporarily impaired immediately after washing the motorcycle.  
Anticipate longer stopping distance to avoid a possible accident.

## Clean the Seat

Due to the top coat design, the seat surface tends to catch and trap dirt or dust in its texture.

Using plenty of water, clean the seat with a sponge and mild detergent.

After washing, dry with a soft, clean cloth.





---

### **Finishing Touches**

After washing your motorcycle, consider using a commercially-available spray cleaner/polish or quality liquid or paste wax to finish the job. Use only a non-abrasive polish or wax made specifically for motorcycles or automobiles. Apply the polish or wax according to the instructions on the container.

### **Removing Road Salt**

Road Salt used on roads during winter and salt from seawater causes rust. Wash your motorcycle as follows after it has run through salty water or on roads treated with Road Salt.

1. Clean the motorcycle using cool water (page 176 ).

Do not use warm water.  
This worsens the effect of the salt.

2. Dry the motorcycle and make sure the metal is protected with the wax.

### **Exhaust Pipe and Muffler Maintenance**

The exhaust pipe and muffler are stainless steel but may become stained by mud or dust.

To remove mud or dust, use a wet sponge and a liquid kitchen abrasive, then rinse well with clean water. Dry with chamois or a soft towel.

If necessary, remove heat stains by using a commercially available fine texture compound. Then rinse by the same manner as removing mud or dust.





# CLEANING

---

## **Painted Aluminum Wheel Maintenance**

Aluminum may corrode from contact with dirt, mud, or road salt. Clean the wheels after riding through any of these substances. Use a wet sponge and mild detergent. Avoid stiff brushes, steel wool, or cleaners containing abrasives or chemical compounds.

After washing, rinse with plenty of water and dry with a clean cloth.

## **Clean the Windscreen**

Using plenty of water, clean the windscreen with a soft cloth or sponge. (Avoid using detergents or any kind of chemical cleaner on the windscreen.) Dry with a soft, clean cloth.

### **NOTICE**

To avoid possible scratching or other damage, use only water and a soft cloth or sponge to clean the windscreen.

For a dirtier windscreen, use a diluted neutral detergent with a sponge and plenty of water. Make sure to wash off all the detergent. (Detergent residue may cause windscreen cracks.)

Replace the windscreen if scratches cannot be removed and they obstruct clear vision.

Do not let battery electrolyte, brake fluid or other acid chemicals get on the windscreen and screen garnish. They will damage the plastic.

## **Clean the Display and Light Lens**

Clean the display and light lens with a soft, damp cloth. You may use a mild cleaner intended for eyeglasses or computer displays. Harsher chemicals may damage the display and light lens.

### **NOTICE**

To avoid possible scratching or other damage, use only water and a soft cloth or sponge to clean the display and light lens.

Do not let battery electrolyte, brake fluid or other acid chemicals get on the display and light lens. They will damage the display and light lens.



## STORAGE GUIDE

---

Extended storage, such as for winter, requires that you take certain steps to reduce the effects of deterioration from non-use of the motorcycle. In addition, necessary repairs should be made BEFORE storing the motorcycle; otherwise, these repairs may be forgotten by the time the motorcycle is removed from storage.

### STORAGE

1. Change the engine oil and filter.
2. Make sure the cooling system is filled with a 50/50 % antifreeze solution.
3. Fill the fuel tank. Make sure the fuel fill cap is properly installed.
4. To prevent rusting in the cylinders, perform the following:
  - Remove the spark plug caps from the spark plugs. Using tape or string, secure the caps to any convenient plastic body part so that they are positioned away from the spark plugs.
  - Remove the spark plugs from the engine and store them in a safe place. Do not connect the spark plugs to the spark plug caps.
  - Pour a tablespoon (15–20 cm<sup>3</sup>) of clean engine oil into each cylinder and cover the spark plug holes with a piece of cloth.
  - Crank the engine several times to distribute the oil.
  - Reinstall the spark plugs and spark plug caps.

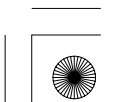
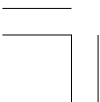



## STORAGE GUIDE

---

5. Remove the battery. Store in an area protected from freezing temperatures and direct sunlight.  
Slow charge the battery once a month.
6. Wash and dry the motorcycle. Wax all painted surfaces. Coat chrome with rustinhibiting oil.
7. Inflate the tyres to their recommended pressures. Place the motorcycle on blocks to raise both tyres off the ground.
8. Cover the motorcycle (don't use plastic or other coated materials) and store in an unheated area, free of dampness with a minimum of daily temperature variation. Do not store the motorcycle in direct sunlight.

### REMOVAL FROM STORAGE

1. Uncover and clean the motorcycle.
2. Change the engine oil if more than 4 months have passed since the start of storage.
3. Charge the battery as required. Install the battery.
4. Fill the fuel tank with fresh petrol.
5. Check the final drive oil, adding the recommended gear oil if necessary.  
Change the final drive oil as specified by the Maintenance Schedule.
6. Perform all Pre-ride Inspection checks (page 118).  
Test ride the motorcycle at low speeds in a safe riding area away from traffic.

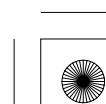
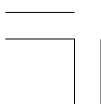



## TAKING CARE OF THE UNEXPECTED

---

### **IF YOU CRASH**

Personal safety is your first priority after a crash. If you or anyone else has been injured, take time to assess the severity of the injuries and whether it is safe to continue riding. Call for emergency assistance if needed. Also follow applicable laws and regulations if another person or vehicle is involved in the crash.

If you decide that you are capable of riding safely, first evaluate the condition of your motorcycle. If the engine is still running, turn it off and look it over carefully; inspect it for fluid leaks, check the tightness of critical nuts and bolts, and secure such parts as the handlebar, control levers, brakes, and wheels.

If there is minor damage, or you are unsure about possible damage, ride slowly and cautiously. Sometimes, crash damage is hidden or not immediately apparent, so you should have your motorcycle thoroughly checked at a qualified service facility as soon as possible. Also, be sure to have your dealer check the frame and suspension after any serious crash.

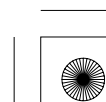
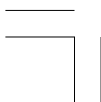



## SPECIFICATIONS

---

### DIMENSIONS

Overall length	2,605 mm (102.6 in)
Overall width	945 mm (37.2 in)
Overall height	1,255 mm (49.4 in)
Wheelbase	1,690 mm (66.5 in)

### CAPACITIES

Engine oil	
– After disassembly	4.6 ℓ (4.9 US qt , 4.0 Imp qt)
– After oil filter change	3.7 ℓ (3.9 US qt , 3.3 Imp qt)
– After draining	3.6 ℓ (3.8 US qt , 3.2 Imp qt)
Final drive gear oil	
– After draining	120 cm <sup>3</sup> (4.1 US oz , 4.2 Imp oz)
Fuel tank	25 ℓ (6.6 US gal , 5.5 Imp gal)
Cooling system capacity	4.5 ℓ (4.8 US qt , 4.0 Imp qt)
Passenger capacity	Operator and one passenger
Maximum weight capacity	190 kg (419 lb) ...Except KO type 172 kg (379 lb) ...KO type only

### ENGINE

Bore and stroke	74.0 × 71.0 mm (2.91 × 2.80 in)
Compression ratio	9.8 ± 0.2 : 1
Displacement	1,832 cm <sup>3</sup> (111.8 cu-in)
Spark plug standard	BKR6E-11 (NGK) or K20PR-U11 (DENSO)
For cold climate (Below 5° C, 41° F)	BKR5E-11 (NGK) or K16PR-U11 (DENSO)
For extended high speed riding	BKR7E-11 (NGK) or K22PR-U11 (DENSO)
Spark plug gap	1.00 – 1.10 mm (0.039 – 0.043 in)
Idle speed	730 ± 70 min <sup>-1</sup> (rpm)
Valve clearance (cold)	Intake: 0.15 mm (0.006 in) Exhaust: 0.22 mm (0.009 in)







---

### CHASSIS AND SUSPENSION

Caster	29° 15'
Trail	109 mm (4.3 in)
Tyre size, front	130/70R18M/C 63H BRIDGESTONE G709 RADIAL
Tyre size, rear	180/60R16M/C 74H BRIDGESTONE G704 RADIAL
Tyre type	radial, tubeless

### POWER TRANSMISSION

Primary reduction	1.591
Gear ratio, 1st	2.375
2nd	1.454
3rd	1.068
4th	0.843
OD	0.685
Final reduction	2.750

### ELECTRICAL

Battery	GYZ20L 12V – 20Ah (10HR) / 21.1Ah (20HR)
Generator	1.2 kW/5,000 min <sup>-1</sup> (rpm)

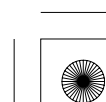
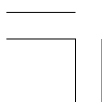



## SPECIFICATIONS

---

### LIGHTS

Headlight (high)	12 V-55 W × 2
(low)	12 V-55 W × 2
Brake/tail light	12 V-21/5 W × 2
Turn signal light (front)	12 V-21/5 W × 2
(rear)	12 V-21 W × 2
License light	12 V-5 W

### FUSES

Main fuse A	30 A
Main fuse B/External amplifier fuse	120/40 A
Other fuses	30 A, 20 A, 15 A, 10 A, 5 A

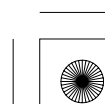
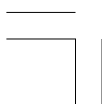



## CATALYTIC CONVERTER

---

This motorcycle is equipped with a catalytic converter.

The catalytic converter contains precious metals that serve as catalysts, promoting chemical reactions to convert the exhaust gasses without affecting the metals.

The catalytic converter acts on HC, CO, and NOx. A replacement unit must be an original Honda part or its equivalent.

The catalytic converter must operate at a high temperature for the chemical reactions to take place. It can set on fire any combustible materials that come near it. Park your motorcycle away from high grasses, dry leaves, or other flammables.

A defective catalytic converter contributes to air pollution, and can impair your engine's performance. Follow these guidelines to protect your motorcycle's catalytic converter.

- Always use unleaded petrol. Even a small amount of leaded petrol can contaminate the catalyst metals, making the catalytic converter ineffective.
- Keep the engine in good running condition.  
A poorly running engine can cause the catalytic converter to overheat causing damage to the converter or the motorcycle.
- If your engine is misfiring, backfiring, stalling, or otherwise not running properly, stop riding and turn off the engine. Have your motorcycle serviced as soon as possible.

