

## OPERATING INSTRUCTIONS

### *in*-VEHICLE ENTERTAINMENT SYSTEM

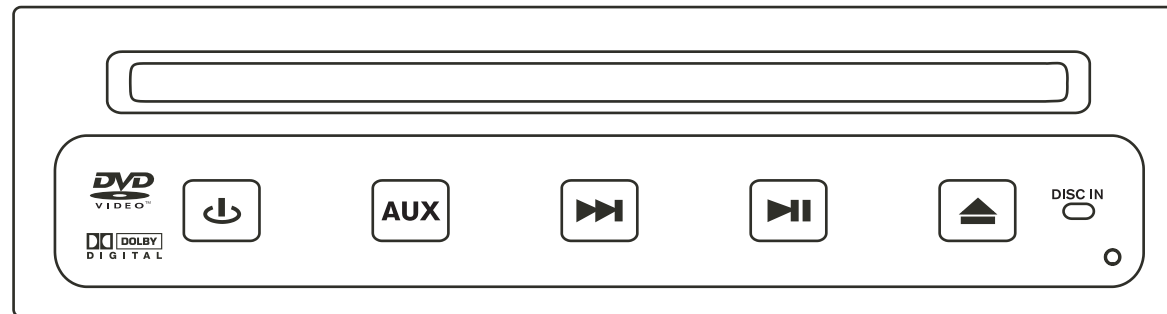

**P/N 08A23-2G1-010**

# HONDA

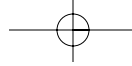

## WELCOME

Your *in-VEHICLE ENTERTAINMENT SYSTEM* is designed to give you and your family years of enjoyment. You can watch your favorite DVD-Video or Video-CD movies, you can listen to your favorite Audio-CD or MP3 albums, or plug-and-play a variety of standard video games. Please review these Operating Instructions to become familiar with the entertainment system's features and operation. Pay particular attention to the safety precautions for use of a video player in a vehicle. For additional information about your *in-VEHICLE ENTERTAINMENT SYSTEM* please contact your dealer.

## PRECAUTIONS

This video display is intended for rear seat passenger viewing only. Installation within the driver's view is illegal in most states, provinces, and countries, and may lead to driver distraction.

Do not insert foreign objects into the DVD Player disc slot.

**WARNING!** The front glass on the Liquid Crystal Display (LCD) may break when hit with a hard surface. If the glass breaks, do not touch the liquid crystalline material. In case of contact with skin, wash immediately with soap and water.

**CAUTION:** Do not expose the Liquid Crystal Display (LCD) to direct sunlight or intense ultraviolet rays for extensive time periods. Ultraviolet rays deteriorate the liquid crystal.

Please be sure to review the owner's manuals, consumer information, and precaution booklets for all video games and video equipment that you use as auxiliary inputs for your *in-VEHICLE ENTERTAINMENT SYSTEM*.

Do not operate video games and video equipment if the power cords or cables are broken, split, or damaged.

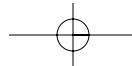
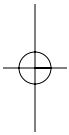
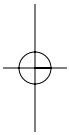

Avoid touching auxiliary input jacks with your fingers. Do not blow on them or allow them to get wet or dirty.

Do not clean any part of the unit with benzene, paint thinner, or any other solvent.





### ***Electrical Cautions and Warnings***

#### **CAUTION**

  Risk of electrical shock. Do not open DVD Player, LCD Screen, Remote Control, or FM Modulator.

**CAUTION: To reduce the risk of shock, do not remove the DVD Player, LCD Screen, Remote Control, or FM Modulator cover. No user-serviceable parts are inside. Refer servicing to qualified service personnel.**

 A lightning flash with arrowhead symbol within a triangle is intended to alert the user to the presence of un-insulated “dangerous voltage” within the product enclosure. The voltage may be of sufficient magnitude to constitute a risk of electric shock.

 An exclamation point within a triangle is intended to alert the user to the presence of important operating and maintenance (servicing) instructions in the literature accompanying the appliance (DVD).

---

**WARNING! To prevent fire or shock hazard, do not expose this product to rain or moisture.**

---

---

**CAUTION: The DVD Player, LCD Screen & FM Modulator should be used with 12V DC only. To prevent electrical shocks and fire hazards, DO NOT use any other power source.**

---

## Handling Discs

To remove the disc from its storage case, press down on the center of the case and lift the disc out, holding it carefully by the edges.

Removing the disc

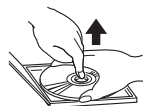

Proper way to hold the disc



Always handle the disc by the edges. Never touch the surface. To remove fingermarks and dust, use a soft cloth, and wipe in a straight line from the center of the disc to the circumference.

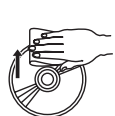

New discs may have some roughness around the edges. The unit may not work or the sound may skip if such discs are used. Use a ball-point pen or similar item to remove roughness from the edge of the disc.

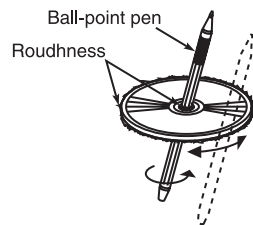

### Note on Discs

Never stick labels on the surface of the disc or mark the surface with a pencil or pen.

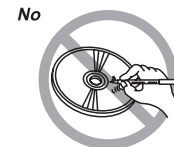

Do not use any solvents such as commercially available cleaners, anti-static spray, or thinner to clean discs.

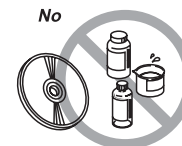

Do not use discs that have large scratches, are misshapen, or cracked, etc. Use of such discs will cause misoperation or damage.

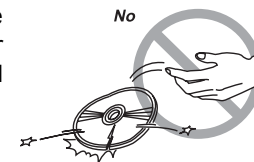

Do not expose discs to direct sunlight or any heat source.

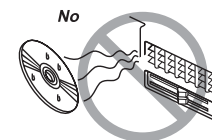

**Note:** Do not use commercially available disc protection sheets or discs equipped with stabilizers. These may get caught in the internal mechanism and damage the disc.

## Contents

1. Quick Start	
1.1. Stereo DVD Player	1
1.2. 7" Flip Down LCD Screen	2
1.3. Wireless Headphones	2
1.4. Remote Control	3
2. System Overview	4
3. <i>In-Vehicle</i> Entertainment System Operation	6
3.1. DVD Player Controls	6
3.2. Remote Control	7
3.3. Remote Battery Replacement	9
3.4. Flip-Down Screen	10
3.5. General Operating Tips	11
3.6. Inserting/Removing Disc	12
3.7. Play Operation	13
3.8. Fast Forward Or Rewind	13
3.9. Next Operation	14
3.10. Previous Operation	14
3.11. Special Effects Play	14
3.12. Special Effects Play (DVD-Video Only)	15
3.13. MP3 Play	16
3.14. Automatic Power Off Feature	16
3.15. Dual Stop Modes	16
4. Wireless Headphone	17
4.1. Special Features	17
4.2. Explanation of Controls	17
4.3. Headphone Battery Replacement	18
4.4. Operation	18
4.5. Adjusting Wireless Headphones	18
5. Auxiliary Input Device Connection	19
6. Care of the DVD Player	20
7. Troubleshooting Guide	21
8. Specifications	23
9. Dome Light Replacement	25

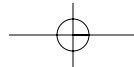
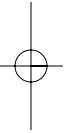
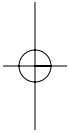
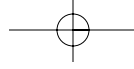

## 1. Quick Start

### 1.1. Stereo DVD Player

Turn the vehicle ignition key to ACC (I) or ON (II) to start using the DVD Player.

Operating the system for an extended period of time with the engine OFF will run down the vehicle's battery.



Press to turn the DVD Player ON/OFF.



Press to switch to between MAIN/AUX Inputs. Press and hold the button for 3 seconds to turn the FM Modulator ON/OFF.



Press to advance to the next chapter.



Press to play a disc or to pause play temporarily.

**NOTE:** To start many DVD discs, the "ENTER" button on the remote control must be pressed, not the "play" button.  
See section 1.4. Remote Control



Press to eject the disc from the DVD Player. Press and hold the button for 3 seconds to turn the DVD Player illumination ON/OFF.

To prolong the system life and optimize radio performance, turn the DVD power OFF when you are not using it.

## 1. Quick Start

### 1.2. 7" Flip Down LCD Screen

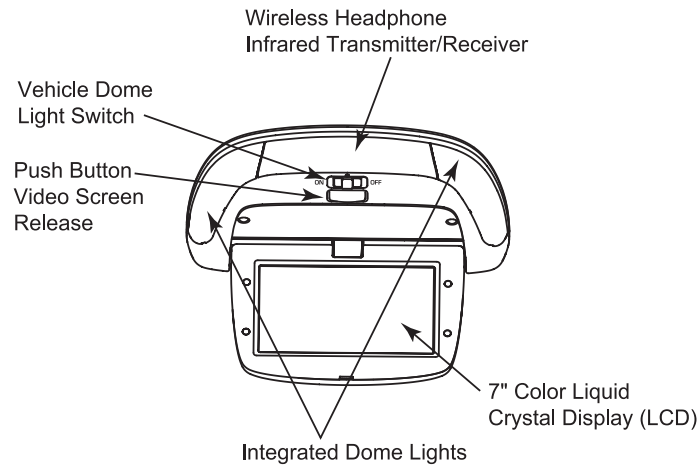

### 1.3. Wireless Headphones

An infrared transmitter transmits the audio signal to the headphones

#### Headphone Receivers

##### 1. Infrared Sensors

Receive audio signals from the transmitter.

##### 2. Battery Cover

To replace the batteries, slide cover down.

##### 3. Power Indicator LED

Is lit when headphones are ON.

##### 4. Power Switch

Turns headphone power ON/OFF.

##### 5. Volume Control

Use to adjust headphone volume.

##### 6. Auto On/Off

This battery power-saving feature automatically turns off the head phones when the headphones are not worn.

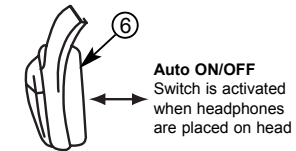
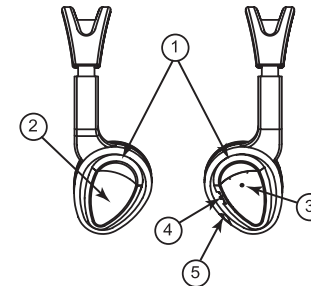

**NOTE:** Do not cup your hands over the earpiece when adjusting the volume. This may interfere with the signal to the headphones.



## 1. Quick Start

### 1.4. Remote Control

When using the remote, aim it at the infrared transmitter/receiver above the video display screen. (See 7" Flip Down LCD Screen, page 2)

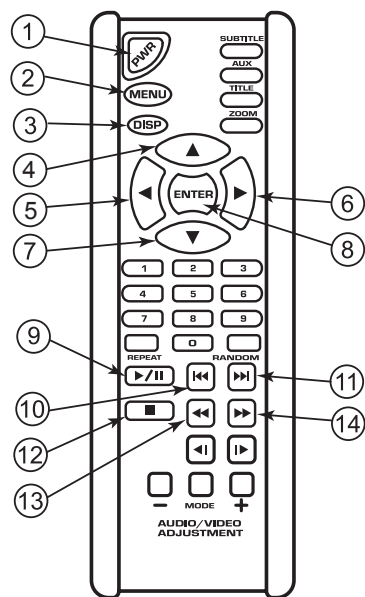

**1. PWR (DVD Player ON/OFF)**

**2. MENU**

Press to enter DVD Player Setup Menu if disc is loaded.  
Press to enter Disc Menu if disc is loaded.

**3. DISP**

Press to display Disc Information

**4. Up Arrow**

Press to navigate in the DVD menu and to control the zoom view area.

**5. Left Arrow**

Press to navigate in the DVD menu and to control the zoom view area.

**6. Right Arrow**

Press to navigate in the DVD menu and to control the zoom view area.

**7. Down Arrow**

Press to navigate in the DVD menu and to control the zoom view area.

**8. ENTER**

Press to select the highlighted option on the screen.

**9. Play/Pause**

Press to play a disc or to pause play temporarily.

**10. Previous**

Press to return to previous chapter or track (or beginning of current one).

**11. Next**

Press to advance to the start of the next chapter or track

**12. Stop**

Press to stop disc play.

**13. Rewind**

Press to search backward during play.

**14. Fast Forward**

Press to search forward during play.

## 2. System Overview

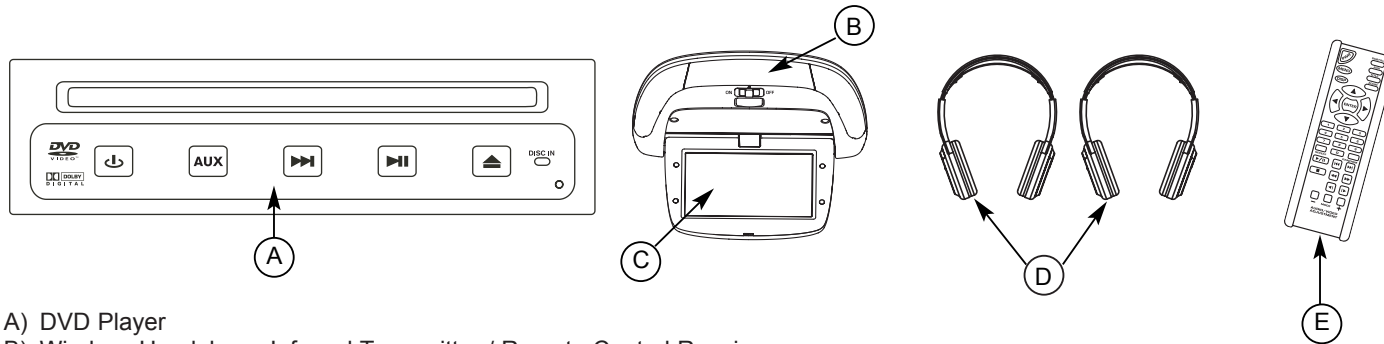

- A) DVD Player
- B) Wireless Headphone Infrared Transmitter / Remote Control Receiver
- C) 7" Color Liquid Crystal Display (LCD) Flip-Down Screen
- D) Infrared Wireless Headphones
- E) Remote Control
- F) FM Modulator - not shown

### GENERAL OPERATION NOTE

Your DVD Player supports many different types of media (CD-DA, DVD-Video, Video-CD, etc.). You will notice some slight differences in operation between these types of media. THIS IS NORMAL. These differences occur because of the flexibility of these types of media. At times you will have to read the instructions that appear on the video display screen when you insert a disc to determine what to do. It is normal that not all buttons on the Remote Control will function for all types of media. Also some buttons will work with one DVD-Video disc, but may work differently, or not at all, with a different DVD-Video disc.

For example, you may notice that you cannot use the number keys to select chapter on a DVD-Video, although you can use them to select a track on an Audio disc. You may also notice that the TITLE button may function for some DVD-Video discs, but will either function differently or not at all on other DVD-Video discs.

The DVD player is also programmed to shut off when ever the vehicle is turned off. To resume playing a disc, simply push POWER on the DVD player or PWR on the remote control.

↑  
Once the vehicle turned  
back ON

## 2. System Overview

### FEATURES

- High performance 7" flip-down LCD screen with adjustable settings for Brightness, Contrast, Color, Tint, Sharpness, & Dimmer control.
- Auxiliary video and audio jacks (standard RCA style connectors) for connecting video games and video equipment. (See NOTE)
- Wireless infrared remote control for DVD Player.
- Connects to vehicle audio system.
- Support for both wide screen (16:9) and standard (4:3) viewing.
- Multi-Language on screen display messaging.

**NOTE:** Auxiliary video or game equipment may require a 12-volt DC to 120-volt AC power inverter, which is not provided with the system.

### SUPPORTED FORMATS

#### Playable Discs

DVD -Video



Video-CD



CD-DA Audio CD



MP3 CD Audio on CD-R



The DVD player can play standard 5" (12cm) discs.

**NOTE:** Many new Audio CD's are coming with copy guard protection. The DVD Player is not guaranteed to play discs with copy guard protection. If these discs do play, you may notice abnormal behavior such as not all the disc tracks will be listed.

**NOTE:** This DVD player will only play DVD's whose region code is 1.



### 3. In -Vehicle Entertainment System Operation

#### AUDIO SYSTEM

Turning on the FM Modulator will enable you to listen to audio from the *in-VEHICLE ENTERTAINMENT SYSTEM* over the vehicle's speakers. To turn on the FM Modulator, press and hold the AUX button on either the Remote Control or DVD Player.

**NOTE:** *The wireless headphones remain operational regardless of the status of the FM Modulator. You must tune the vehicle's audio system to 88.5MHz (See NOTE) on the FM band to hear the audio.*

**WHILE THE FM MODULATOR IS TURNED ON, IT WILL NOT BE POSSIBLE TO LISTEN TO OTHER RADIO STATIONS.**

**NOTE:** *88.5 MHz is the recommended and factory set frequency for the FM Modulator. Installers may use 88.1 MHz or 88.9 MHz instead of 88.5 MHz if there is interference on that frequency. Please try these other frequencies if you experience no audio on 88.5 MHz.*

#### 3.1 DVD Player Controls

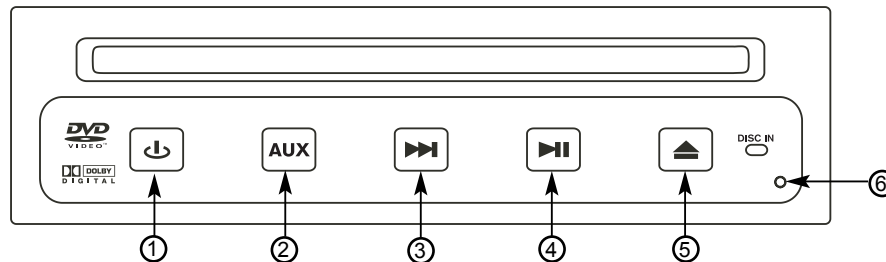

##### 1. POWER

Press to turn the DVD Player ON/OFF.

##### 2. AUX

Press to switch to between MAIN/AUX Inputs. Press and hold the button for 3 seconds to turn the FM Modulator ON/OFF.

##### 3. NEXT

Press to advance to the next chapter.

##### 4. PLAY / PAUSE

Press to play a disc or to pause play temporarily.

**NOTE:** *To start many DVD discs, the "ENTER" button on the*

*remote control must be pressed, not the "play" button.*

*See section 1.4. Remote Control*

##### 5. EJECT

Press to eject the disc from the DVD Player. Press and hold the button for 3 seconds to turn the DVD Player illumination ON/OFF.

##### 6. RESET

Press to reset DVD Player and restore original conditions.

### 3. In -Vehicle Entertainment System Operation

#### 3.2 Remote Control

**NOTE:** When using the remote, aim it at the infrared transmitter above the video display screen. (See page 10).

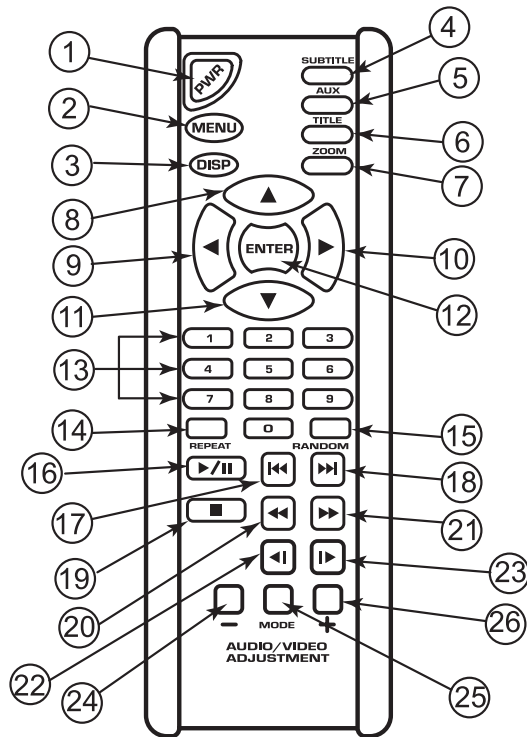

#### 1. PWR (DVD Player ON/OFF)

#### 2. MENU

Press to enter DVD Player Setup Menu if disc is not loaded, or is loaded and stopped.

Press to enter Disc Menu if disc is loaded.

The Setup Menu offers the following selections:

**Language:** OSD, Menu Subtitle, Audio, DVD Menu, OSD

**Video:** TV Shape 16:9 or 4:3, Video, Brightness, Edges

**Audio:** Dolby Digital, DTS, MP3.

**Ratings:** Password, Rating

Use the Arrow keys to cycle between selections.

#### 3. DISP

Press to display Disc Information.

#### 4. SUBTITLE

Press to turn video subtitles ON/OFF.

#### 5. AUX

Press to switch between Main and Auxiliary Input Modes.

Press and hold to turn FM Modulator ON/OFF.

#### 6. TITLE

Press to enter Disc Title (if available) selection if disc is loaded.

**NOTE:** The TITLE feature is DVD disc dependent. See "GENERAL OPERATION NOTE" on page 4.

### 3. In -Vehicle Entertainment System Operation

#### 7. ZOOM

Press to zoom in on the screen video image. In zoom mode, the arrow keys can be used to change the view area on the screen.

#### 8. Up Arrow

Press to navigate in on-screen menus and to control the zoom view area.

#### 9. Left Arrow

Press to navigate in on-screen menus and to control the zoom view area.

#### 10. Right Arrow

Press to navigate in on-screen menus and to control the zoom view area.

#### 11. Down Arrow

Press to navigate in on-screen menus and to control the zoom view area.

#### 12. ENTER

Press to select the highlighted option on the screen.

#### 13. 0 - 9

Use numbered key pad to select desired track number and for the Parental Lock password feature (see section 3.12 Parental Lock on page 15).

**NOTE:** *Number keys cannot be used to select DVD-Video or Video-CD chapters.*

#### 14. REPEAT

Press to change between the repeat mode options (1/All/Off).

#### 15. RANDOM

Press to turn random play order ON/OFF.

#### 16. Play/Pause

Press to play a disc or to pause play temporarily.

#### 17. Previous

Press to return to previous chapter or track (or beginning of current one).

#### 18. Next

Press to advance to the start of the next chapter or track.

#### 19. Stop

Press to stop disc play.

#### 20. Rewind

Press to search backward during play.

#### 21. Fast Forward

Press to search forward during play.

#### 22. Slow Reverse

Press to review backward in slow motion during play.

#### 23. Slow Forward

Press to review forward in slow motion during play.

#### 24. Down (—)

Press to adjust decrease levels of Mode Adjustment (see #25).

#### 25. MODE Adjustment Select

Press to enter video settings adjustment mode. This feature offers the following selections: Brightness, Contrast, Color, Tint, Sharpness, Flip, Mirror, Dimmer, TV System (Auto is the recommended setting), MEM Reset (Restores factory settings).

Use MODE button to cycle between selections. To make adjustments to the various settings, use the +/- buttons.

#### 26. Up (+)

Press to increase levels of Mode Adjustment (see #25).

### 3. In -Vehicle Entertainment System Operation

#### 3.3 Remote Battery Replacement

1. Battery replacement is usually required if the remote functions only when it is very close to the video display screen, or not at all.
2. Use your finger tip(s) to slide the battery cover down.
3. When replacing the battery, use two (2) AAA batteries, and install with the correct orientation as indicated on the remote.

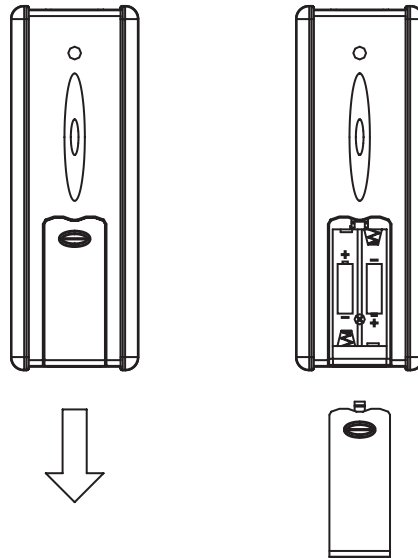

### 3. In -Vehicle Entertainment System Operation

#### 3.4 Flip-Down Screen

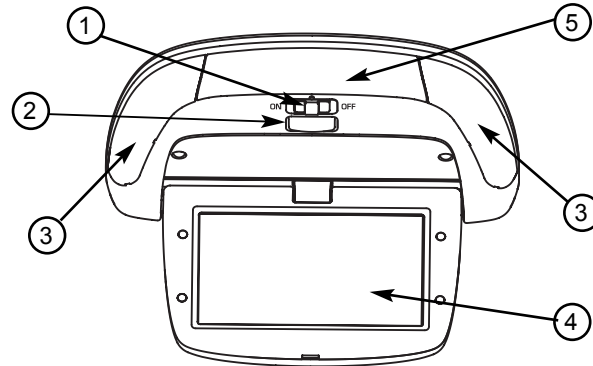

**1. Vehicle Dome Light Switch**

Slide this switch to select Dome Light Off, Dome Light On, or Dome Light Door Activated.

**2. Video Screen Release**

Push to release video screen from its closed position.

**3. Integrated Dome Lights**

Controlled by Vehicle Dome Light Switch.  
2x3W bulbs.

**4. 7" (diagonal) color liquid crystal display screen**

**5. Wireless Headphone And Remote Control Infrared Transmitter And Receiver**

Aim remote control to this area for proper function.



### 3. In -Vehicle Entertainment System Operation

#### 3.5 General Operating Tips

Operating the system for extended period of time with the engine OFF will run down the vehicle's battery. When the ignition key is turned OFF, the *in-VEHICLE ENTERTAINMENT SYSTEM* is also turned OFF.

To prolong system life and to optimize radio performance, turn the DVD player power OFF when you are not using it.

When the ignition is first turned ON, the *in-VEHICLE ENTERTAINMENT SYSTEM* will be powered OFF. Turn the system ON by pressing the POWER button on either the Remote Control (see page 7, button 1) or on the DVD Player (see page 6, button 1). Once the *in-VEHICLE ENTERTAINMENT SYSTEM* is powered ON, audio will be sent through the wireless headphones. To listen to the audio through the vehicle's speaker system, it will be necessary to tune the radio to FM 88.5MHz (see Audio System, page 6), and turn ON the FM Modulator. The FM Modulator can be turned ON/OFF by pressing and holding down the AUX button on the Remote Control (see page 7, button 5) or on the DVD Player (see page 6, button 2) for more than 3 seconds. When using the remote control, aim it at the infrared transmitter above the video display screen.

**WHILE THE FM MODULATOR IS TURNED ON, IT WILL NOT BE POSSIBLE TO LISTEN TO OTHER RADIO STATIONS.**

When using the remote control, aim it at the infrared transmitter above the video display screen.

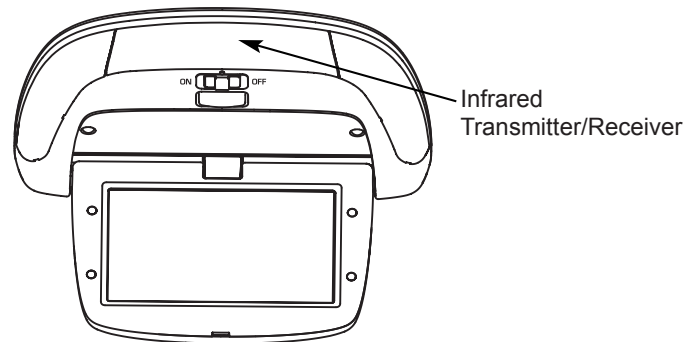

### 3. In -Vehicle Entertainment System Operation

#### 3.6. Inserting/Removing Disc

##### INSERTING DISC

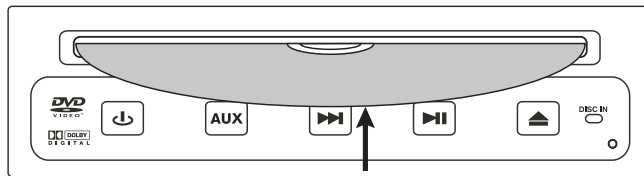

- To insert a disc, the vehicle ignition key must be turned to the ACC (I) or ON (II) position. (See NOTE)
- Insert the disc into the disc slot as shown in the picture above.
- Do not force the disc, as the DVD Player will grab the disc and load it into place.
- The disc insertion orientation should be that the side of the disc that you want to play faces the bottom of the DVD Player.
- Once the disc has been loaded, the DISC IN indicator light on the front of the DVD Player will light in an orange color.

**NOTE:** A disc can be inserted when the vehicle ignition key is turned to the OFF position, if the EJECT BUTTON is first pressed.

##### REMOVING DISC

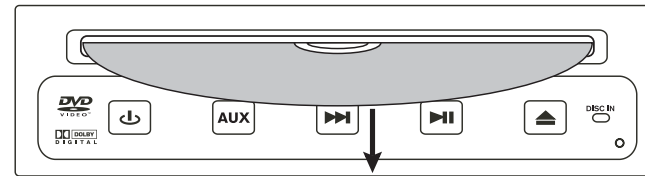

- Discs may be ejected when the vehicle ignition key is in the OFF position as well as when it is either in the ACC (I) or ON position (II).
- Press the EJECT button to eject the disc.
- If you do not remove the disc within 15 seconds after pressing the EJECT button, the DVD Player will automatically reload the disc.
- Once the disc has been ejected, the DISC IN indicator light on the front of the DVD Player will turn off.

### 3. In -Vehicle Entertainment System Operation

#### 3.7. Play Operation

- Turn the ignition key ON (or ACC).
- Press the POWER button on the DVD Player.
- Insert a disc into the DVD Player.
- The disc should begin to play.
- Press the STOP button to discontinue play. Press the EJECT button to remove the disc.

**Note:** *This unit has a "Dual Stop Mode" feature. See section 3.15 Dual Stop Mode for an explanation of the feature.*

**DVD Illumination:** When the DVD player is OFF, only the POWER button is illuminated. When the DVD player is ON, all of the buttons are lit. If desired, the illumination can be manually turned OFF and ON by pressing and hold the EJECT button for 3 seconds. See section **3.1 DVD Player Controls**.

**NOTE:** *The DVD Illumination is not controlled by the vehicle's dashboard dimmer.*

ting

#### 3.8. Fast Forward Or Rewind (While Media is Playing)

- While a disc is playing, momentarily press the FAST FORWARD, or REWIND, button on the remote control unit (see page 8, button 21 or button 20).
- The disc will start to play in the normal (fast forward) or reverse (rewind) direction at a speed of 2 times as fast as normal.

**The DVD Player supports multiple speeds of fast forward and rewind. Multiple momentary presses of the FAST FORWARD, or REWIND (see page 8, button 21 or button 20) will increase the fast forward, or reverse, rate ranging from 2 times, to 4 times, to 8 times, to 20 times faster than normal.**

- To play the disc at normal speed, press the PLAY/PAUSE button on either the remote control or the DVD Player.

### 3. In -Vehicle Entertainment System Operation

---

#### 3.9. Next Operation

- While a disc is playing, momentarily press the NEXT button on either the remote control (see page 8, button 18) or the DVD Player (see page 6, button 3).
- The DVD Player will advance to the beginning of the next chapter or track, and then begin playing at that point.

#### 3.10. Previous Operation

- While a disc is playing, momentarily press the PREVIOUS button on the remote control (see page 8, button 17).
- The DVD Player will reverse to the beginning of the previous chapter or track, and then begin playing at that point.

*From the beginning of a chapter or track, momentarily press the PREVIOUS button to reverse to the beginning of the previous track.*

#### 3.11. Special Effects Play

##### Still Play

While a disc is playing, press the PLAY/PAUSE button on the remote control. The disc will temporarily freeze to still frame. If the media is either a DVD-Video, or a Video-CD, the still image will appear on the screen. To return to normal operation, press the PLAY/PAUSE button again.

##### Repeated Play

When you first insert a disc, it will begin to play. The entire contents of the disc will be played 1 time. Once the disc has completed playing, then the DVD Player will stop playing. By enabling the repeat feature, you can make either the entire disc, or just a single chapter (or track) play over and over again. You can enable the repeat feature by pressing the REPEAT button on the remote control. You can select the style of the repeat feature by pressing the REPEAT button multiple times.

##### Random Play

When you first insert a disc, it will begin to play the disc. It should start from the beginning of the disc, and play the disc in a sequential order. It is possible to have the disc played in a non-sequential order. To turn this effect on, simply press the RANDOM button on the remote control. The message on the screen will indicate whether the random play is ON or OFF. If you want non-sequential order, then the random mode should be ON. If you want sequential order, then the random mode should be OFF.

### 3. In -Vehicle Entertainment System Operation

#### 3.12. Special Effects Play (DVD-Video Only)

##### Slow Play (forward or reverse)

While a disc is playing, press either the slow forward (see page 8, button 23) or slow reverse (see page 8, button 22). Play speed will decrease to 1/2 of normal speed. Pressing the button multiple times will further decrease the play speed from 1/2, to 1/3, to 1/4, to 1/5, to 1/6, and to 1/7 of normal speed.

To return to normal speed, press the PLAY/PAUSE button on either the remote control or the DVD Player.

##### ZOOM

While a disc is playing, press the ZOOM (see page 7, button 7) button on the remote control. You will see the image on the screen appear much closer to you. Once you have turned on the zoom feature, you can use the arrow keys (see page 7-8, buttons 8, 9, 10, 11) on the remote control to change the view area on the screen. Pressing the ZOOM button will cycle through the different levels of the zoom feature (zoom 1, zoom 2, zoom 3, zoom off).

##### Parental Control Lock

If you wish to control the type of content that is played on the DVD Player, you can do so by enabling the parental control lock. To enable this feature, there must not be a disc playing. Press the MENU button on the remote control. Use the ARROW KEYS to navigate to the heading called rating. You will then be prompted to insert a 4-digit numerical password, which is entered by using the keypad on the remote control. Then you will be allowed to select the type of content that can be played by the DVD Player. Press MENU again on the remote control to save your settings and exit the setup menu.

**NOTE:** *The parental lock feature is DVD disc dependent. Not all DVD discs have this feature. A "R" rated DVD disc may play even though the parental control feature in the DVD player has been set at "PG" or a rating less than "R". Always check for the parental lock feature when buying DVD's.*

**NOTE:** *It is very important that you remember this 4-digit password. There is no way to reset this feature. You can change the content level **ONLY** by using your password.*

### 3. In -Vehicle Entertainment System Operation

#### 3.13. MP3 Play

##### MP3 On Screen Display

When you are playing a MP3 CD, you will see the name of the folder on the top line of the screen. The names of the songs will be shown in the columns underneath.

##### MP3 Playing Order

When selected for play, folder selecting, or track selecting, files and folders are accessed in order in which they were written to the CD. Because of this, the order in which they are expected to be played may not match the order in which they are actually played. For example, a disc with the following folder/file hierarchy is subject to the folder selection, or track selection as shown.

Refer to Section 8. **SPECIFICATIONS** for additional details on MP3 file types and capabilities.

#### 3.14. Automatic Power Off Feature

If the DVD Player is left idle for 5 minutes, it will power itself OFF.

#### 3.15. Dual Stop Modes

The DVD Player is equipped with 2 separate stop modes.

The first stop mode can be referred to as resume stop mode. In this mode, if you are playing a disc, press the stop button on the remote control once, and then press play again, the disc will resume playing from the previous location prior to pushing stop.

The second stop mode can be referred to as reset stop mode. In this mode, if you are playing a disc, press the stop button on the remote control twice, and then press play again, the disc will begin playing from the beginning of the disc.

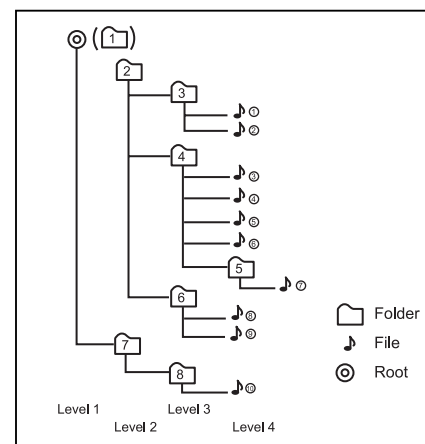

## 4. Wireless Headphones

### Wireless Headphones

To ensure the best performance from your wireless headphones, please read this carefully.

#### 4.1. Special Features

- Automatic level control prevents input signal overloading.
- Uses high-frequency infrared light to assure a clean signal for clear reception.
- Adjustable headphone band for proper fit.
- Auto off battery power savings feature automatically turns off headphones when they are not worn on your head.

#### 4.2. Explanation of Controls

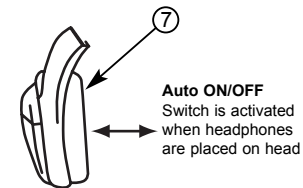
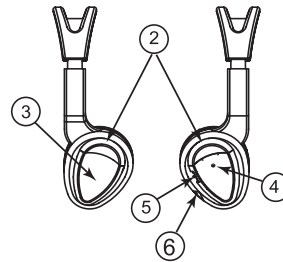
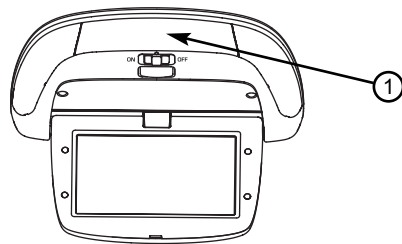

##### 1. Infrared Transmitter

Transmits audio signal to the headphones

##### 2. Infrared Sensors

Receive audio signals from the transmitter.

##### 3. Battery Cover

To replace the batteries, slide cover down.

##### 4. Power Indicator LED

Is lit when headphones are ON.

##### 5. Power Switch

Turns headphone power ON/OFF.

##### 6. Volume Control

Use to adjust headphone volume.

##### 7. Auto On/Off

This battery power-saving feature automatically turns off the headphones when the headphones are not worn.

**NOTE:** Do not cup your hands over the earpiece when adjusting the volume. This may interfere with the signal to the headphones.

## 4. Wireless Headphones

---

### 4.3. Headphone Battery Replacement

If you notice degraded sound or poor headphone performance, battery replacement maybe required.

- Use your finger tip(s) to slide the battery cover down.
- When replacing the battery, use 2xAAA batteries, making sure the battery polarity is correct.
- Replace the battery cover.

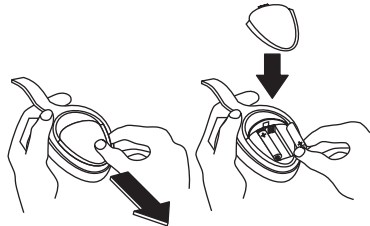

### 4.4. Operation

Please read carefully to prevent damage to the headphones or your ears.

- Be sure the batteries are properly installed in the headphones.
- Turn the headphone volume nearly OFF before turning on the power.
- Turn on the headphone power switch.
- Adjust the headphone volume to a comfortable level.

Make sure you turn off the power switch before storing the headphones to prevent any chance of battery drain.

### 4.5. Adjusting Wireless Headphones

The headphones may be adjusted to fit more comfortably. While holding the top of the headphones, pull down on each earpiece to make the straps longer, or push up on each earpiece to make the straps shorter.



## 5. Auxiliary Input Device Connection

The *in-VEHICLE ENTERTAINMENT SYSTEM* accepts video and audio RCA type connectors for all standard video games and video equipment (such as camcorders) in the auxiliary input jacks of the DVD Player.

### Playing Video Games

- Connect the video line to the YELLOW jack.
- Connect the left and right audio cables to the WHITE and RED jacks.
- Turn on the power to the video game.
- Turn the DVD Player ON.
- Press the AUX button on either the remote control (see page 7, button 5) or the DVD Player (see page 6, button 2). You will now be able to view the video game.



RCA Jacks for  
AUX function

### Playing Auxiliary Video Equipment

- Connect the video line to the YELLOW jack.
- Connect the left and right audio cables to the WHITE and RED jacks.
- Follow the operating instructions for the video equipment.
- Turn the DVD Player ON.

Press the AUX button on either the remote control (see page 7, button 5) or the DVD Player (see page 6, button 2).

**NOTE:** Auxiliary video equipment, including video games, may require a 12-volt DC to 120-volt AC power inverter. Please consult the owners guide for your AC power inverter and for your auxiliary device to check that a vehicle fuse will not be blown by high current (amps) drawn from the vehicle's electrical system.

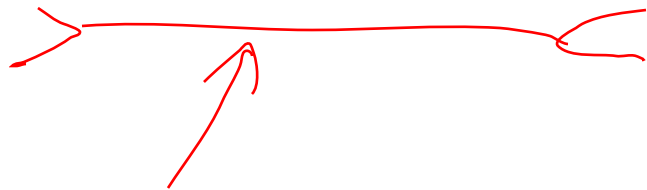

Inserts vehicle limitation for power outlet.  
(120 amp?)

## 6. Care of the DVD Player

### Environmental Extremes

DVD Players subjected to harsh environmental conditions may be damaged or operate at less than maximum performance. To prevent damage or poor performance of the DVD Player, remote control, disc, monitor, or headphones, avoid leaving the vehicle:

- in extremely hot or cold temperatures
- in direct sunlight
- in high humidity
- in a dusty environment
- on a surface that is unstable or subject to vibrations

### Temperature Extremes

If the vehicle is parked in the sun or in an extremely cold place for a long time, wait until the interior temperature is normalized before operating the system.

### Cleaning The DVD Player

Over time, particles will fall from the discs, and settle on the DVD Player optical pick-up. This along with dust particles in the air, can cause a dirty pick-up. This may cause your DVD Player to not be able to read a disc, or for the disc to skip. A variety of products are available at electronics stores to clean the DVD Player pick-up. Use these products sparingly. If normal pick-up cleaning procedures do not resolve the problem, have the system checked by your automobile dealer.

### Foreign Substances

Exercise care to prevent dirt and foreign objects from entering the DVD Player disc slot. Be especially careful not to spill liquids of any kind onto the DVD Player or any other component. If you accidentally spill liquid onto any component, immediately turn the component OFF (and remove batteries if applicable) and consult your automobile dealer.

### Cleaning the Display Screen

Clean the display screen with 70% isopropyl alcohol (rubbing alcohol). Apply a small amount of cleaner to a soft cloth, and rub gently until dirt or fingerprints are removed. To prevent damage of electronics, do not spray the screen directly. Do not apply excessive pressure while cleaning.

## 7. Troubleshooting Guide

Symptom	Possible Cause	Remedy
No Power. Vehicle ignition is ON, power indicator on DVD Player is OFF.	Blown fuse.	Check audio fuses in vehicle fuse panel. <i>Consult your dealer</i>
Remote control does not work.	Batteries in remote control are exhausted.	Replace with (2) AAA batteries.
	Remote control not pointed in the right direction.	Point front of remote control toward the Infrared Receiver on the OVERHEAD MONITOR.
Picture frozen on monitor. Remote control does not work.	The microprocessor has malfunctioned due to electrical noise.	Press the reset button with a thin rod. *
Player will not function, is operating in an incorrect manner.	The microprocessor has malfunctioned due to electrical noise.	Press the reset button with a thin rod. *
Player will not accept a disc.	A disc is already loaded.	Eject the disc before loading a new one.
	Vehicle ignition is OFF.	Press EJECT button. Player will wake up and attempt to eject for 2 seconds. After this time load a new disc.
Picture is jittery or skips.	The disc may be dirty.	Clean disc.
	Defective disc.	Try another disc.
	The microprocessor has malfunctioned due to electrical noise.	Press the reset button with a thin rod.
Disc will not Play.	The disc may be an unsupported type of media.	Try another disc.
	Defective disc.	
	Disc is scratched.	
	Disc has copy guard protection.	
No subtitles.	Subtitles not activated.	Press SUBTITLE button on remote to select and adjust the subtitle menu.
	Subtitles appear only w/discs that contain them.	
No audio through the vehicle speakers.	FM Modulator is turned OFF.	Press and hold the AUX button on the remote control or the DVD Player to turn ON the FM Modulator and tune radio to FM 88.5MHz.

\* Note: Pressing the reset button will restore the default settings. -21-

## 7. Troubleshooting Guide

Symptom	Possible Cause	Remedy
Audio cannot be heard through the headphone.	Power switch on headphone is OFF.	Turn power switch on headphone ON.
	Volume on headphone set too low.	Raise volume on headphone.
	Batteries in headphone are exhausted.	Replace with (2) AAA batteries.
	Vehicle speaker system is too loud.	Turn down volume on vehicle radio, or adjust radio fader to the front of the vehicle.
Desire radio but video system audio is heard through the vehicle speakers.	FM Modulator is turned ON.	Press and hold the AUX button on the remote control or the DVD Player to turn OFF the FM Modulator.
Erratic or no operation.	The microprocessor has malfunctioned due to electrical noise.	Press the reset button with a thin rod.
No radio reception for AM/FM stations.	FM Modulator is turned ON.	Press and hold the AUX button on the remote control or the DVD Player to turn OFF the FM Modulator.
DVD Player not operating properly.	Unit is processing previous operation.	Many actions that a DVD Player will perform require a moment to execute. The DVD Player may not recognize commands if they are entered in rapid succession.
Number keys on remote control do not work.	Number keys are not supported by all types of media.	Use the next and previous buttons on the remote control, or the arrow buttons to select what to play.

## 8. Specifications

### VIDEO PLAYER SPECIFICATIONS

Media Compatability	DVD-VIDEO, CD-DA, MP3, CD-R, Video CD
Video System	NTSC
Audio System	MPEG I, MPEG II
Mechanism Style	Direct Load: 5" (12cm) Disc
Video System	16:9 (Default), 4:3 Letter Box, 4:3 Pan Scan
Video Performance	Output Level: 1.0Vp-p / 75OHM
Horizontal Resolution	TV-LINE > 500
Video S/N Ratio	> 65dB
Input	0.5 V p-p to 2.0 V p-p @ 75 Ohm Unbalanced

### AUDIO SPECIFICATIONS (OUTPUT)

Output Level	2.0Vrms +/- 3dB
Frequency Response	17Hz - 20KHz + 0 / -1dB
De-Emphasis	-20 +/- 1dB
Harmonic Distortion	0.1% MAX (JIS-A, 20KHz LPF)
S/N Ratio	>= 80dB
Separation	>= 70dB
Channel Balance	1dB MAX

### VIDEO MONITOR SPECIFICATIONS

Display type	Color TFT active matrix LCD
Screen size	7" (16:9 diagonal)
Pixels	234 x 1440

### MP3 SPECIFICATIONS

Supported Compression		MPEG I, MPEG II
Supported Bit Rates	MPEG I	Fs: 44.1 KHz, 32 - 320 kbps
	MPEG II	Fs: 22.05 / 24 KHz: 8 - 160 kbps
	VBR	YES
Supported Sampling Frequency	MPEG I	32 KHz, 44.1 KHz, 48 KHz, 96 KHz
	MPEG II	32 KHz, 44.1 KHz, 48 KHz, 96 KHz
Multisession		Capable
M3U Playlist		Yes
File Systems	ISO 9660 Level 1, 2	
	Joliet	
Maximum Files		300 files
Maximum Folders		50 folders
Supported Sub Directories		8 levels of folders
CD - DA / MP3 mixed Disc		Not supported
Maximum Displayable Characters		Truncated to 8 characters for both files and folders
Available Character Type		English Alphanumeric character set

**NOTE:** When playing MP3 discs, only the MP3 file name is displayed. ID3 Tags are not shown.

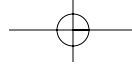

## 8. Specifications

---

For further improvement, specifications and design are subject to change without prior notice.

**NOTE:**

*1. This equipment has been tested and found to comply with the limits for a Class B digital device, pursuant to Part 15 of the FCC Rules. These limits are designed to provide reasonable protection against harmful interference in a residential installation. This equipment generates, uses and can radiate radio frequency energy and, if not installed and used in accordance with the instructions, may cause harmful interference to radio communications. However, there is no guarantee that interference will not occur in a particular installation. If this equipment does cause harmful interference to radio and television reception, which can be determined by turning the equipment off and on, the user is encouraged to try to correct the interference by one or more of the following measures:*

- *Reorient or relocate the receiving antenna.*
- *Increase the separation between the equipment and the receiver.*
- *Connect the equipment into an outlet on a circuit different from that to which the receiver is connected.*
- *Consult the dealer or an experienced radio / TV technician for help.*

*2. This equipment may experience radio frequency interference from cellular phone, two-way and CB radios and other radio frequency devices.*

*3. The manufacturer is not responsible for any radio or TV interference caused by unauthorized modifications to this equipment. Such modifications could void the user's authority to operate the equipment.*

This product incorporates copyright protection technology that is protected by method claims of certain U.S. patents and other intellectual property rights owned by Macrovision Corporation and other rights owners. Use of this copyright protection technology must be authorized by Macrovision Corporation, and is intended for home and other limited viewing uses only unless otherwise authorized by Macrovision Corporation. Reverse engineering or disassembly prohibited.

Manufactured under license from Dolby Laboratories.

"Dolby" and the double - D symbol are trademarks of Dolby Laboratories. Confidential Unpublished Works.

© 1992 - 1997 Dolby Laboratories, Inc. All rights reserved.

Manufactured under license from Digital Theater Systems, Inc. US Pat. No. 5,451,942, 5,956,674, 5,974,380, 5,978,762 and other world-wide patents issued and pending.

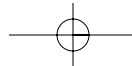

## 9. Dome Light Replacement

1. Turn the Monitor dome light switch to the OFF position.
2. Insert a small straight blade screw driver into the rear slot on the light lens. (see Fig. 1)  
Gently pivot the screw driver toward the rear of the monitor. The lens should pop out slightly.
3. Pivot the lens away from the monitor and towards the front of the monitor.
4. Remove the bulb by pushing toward the front clip.
5. Replace with a 12 V - 3 watt bulb. Insert the bulb into the front clip, and then position into the rear.

**Caution: Use only a 3-Watt bulb replacement. Do not use a 5-Watt bulb replacement! Use of a higher wattage bulb may cause damage to your system and increase the risk of a burn from high heat.**

6. Replace the lens by sliding the front edge under the dark plastic IR lens at the front of the monitor. (See Fig. 2)
7. Pivot the lens toward the rear of the monitor. Align the 2 tabs on the lens over the rectangular holes on the top of the monitor. Gently push the lens into the monitor at the rear snap. (See Fig. 3)

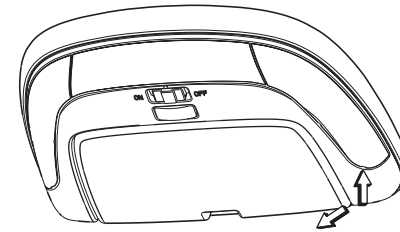

Fig. 1

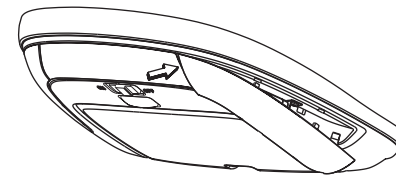

Fig. 2

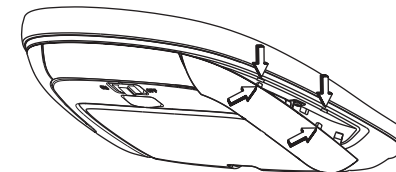
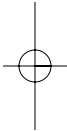
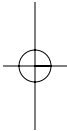
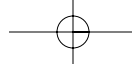

Fig. 3



**HONDA**

© American Honda Motor Co., Inc. 2002 All Rights Reserved

Ref. No.: 08A23-2G1-010  
Printed in China

