

This manual should be considered a permanent part of the motorcycle and should remain with the motorcycle when it is resold.

This publication includes the latest production information available before printing. Honda Motor Co., Ltd. reserves the right to make changes at any time without notice and without incurring any obligation.

No part of this publication may be reproduced without written permission.

The vehicle pictured in this owner's manual may not match your actual vehicle.

Welcome

Congratulations on your purchase of a new Honda motorcycle. Your selection of a Honda makes you part of a worldwide family of satisfied customers who appreciate Honda's reputation for building quality into every product.

To ensure your safety and riding pleasure:

- Read this owner's manual carefully.
- Follow all recommendations and procedures contained in this manual.
- Pay close attention to safety messages contained in this manual and on the motorcycle.

- The following codes in this manual indicate each country.
- The illustrations here in are based on the VFR1200XD ED type.

Country Codes

Code	Country
VFR1200X	
E	UK
ED	European direct sales
F	France, Belgium
U	Australia, New Zealand
KO	Korea
VFR1200XD	
E	UK
ED	European direct sales
F	France, Belgium
U	Australia, New Zealand
BR, II BR	Brazil

*The specifications may vary with each locale.

A Few Words About Safety

Your safety, and the safety of others, is very important. Operating this motorcycle safely is an important responsibility.

To help you make informed decisions about safety, we have provided operating procedures and other information on safety labels and in this manual. This information alerts you to potential hazards that could hurt you or others.

Of course, it is not practical or possible to warn you about all hazards associated with operating or maintaining a motorcycle. You must use your own good judgement.

You will find important safety information in a variety of forms, including:

- Safety labels on the motorcycle
- Safety Messages preceded by a safety alert symbol and one of three signal words: DANGER, WARNING, or CAUTION. These signal words mean:

DANGER

You **WILL** be **KILLED** or **SERIOUSLY HURT** if you don't follow instructions.

WARNING

You **CAN** be **KILLED** or **SERIOUSLY HURT** if you don't follow instructions.

CAUTION

You **CAN** be **HURT** if you don't follow instructions.

Other important information is provided under the following titles:

NOTICE Information to help you avoid damage to your motorcycle, other property, or the environment.

Contents

Motorcycle Safety P. 2

Operation Guide P. 18

Maintenance P. 48

Troubleshooting P. 90

Information P. 111

Specifications P. 125

Index P. 128

Motorcycle Safety

This section contains important information for safe riding of your motorcycle. Please read this section to ensure rider and passenger safety.

Safety Guidelines	P. 3
Image Labels	P. 6
Safety Precautions	P. 11
Riding Precautions	P. 12
Accessories & Modifications	P. 16
Loading	P. 17

Safety Guidelines

Follow these guidelines to ensure your safety:

- Perform all routine and regular inspections specified in this manual.
- Stop the engine and keep sparks and flame away before filling the fuel tank.
- Do not run the engine in enclosed or partly enclosed areas. Carbon monoxide in exhaust gases is toxic and can kill you.

Always Wear a Helmet

It's a proven fact: helmets and protective apparel significantly reduce the number and severity of head and other injuries. So always wear an approved motorcycle helmet and protective apparel. ➤ P. 11

Before Riding

Make sure that you are physically fit, mentally focused and free of alcohol and drugs. Check

that you and your passenger are both wearing an approved motorcycle helmet and protective apparel. Instruct your passenger on holding onto the grab rails, leaning with you in turns, and keeping their feet on the footpegs, even when the motorcycle is stopped.

Take Time to Learn & Practice

Even if you have ridden other motorcycles, practice riding in a safe area to become familiar with how this motorcycle works and handles, and to become accustomed to the motorcycle's size and weight.

Ride Defensively

Always pay attention to other vehicles around you, and do not assume that other drivers see you. Be prepared to stop quickly or perform an evasive maneuver.

Make Yourself Easy to See

Make yourself more visible, especially at night, by wearing bright reflective clothing, positioning yourself so other drivers can see you, signaling before turning or changing lanes, and using your horn when necessary.

Ride within Your Limits

Never ride beyond your personal abilities or faster than conditions warrant. Fatigue and inattention can impair your ability to use good judgement and ride safely.

Don't Drink and Ride

Alcohol and riding don't mix. Even one alcoholic drink can reduce your ability to respond to changing conditions, and your reaction time gets worse with every additional drink. Don't drink and ride, and don't let your friends drink and ride either.

Keep Your Honda in Safe Condition

It's important to keep your motorcycle properly maintained and in safe riding condition. Inspect your motorcycle before every ride and perform all recommended maintenance. Never exceed load limits (📄 P. 17), and do not modify your motorcycle or install accessories that would make your motorcycle unsafe (📄 P. 16).

If You are Involved in a Crash

Personal safety is your first priority. If you or anyone else has been injured, take time to assess the severity of the injuries and whether it is safe to continue riding. Call for emergency assistance if needed. Also follow applicable laws and regulations if another person or vehicle is involved in the crash.

If you decide to continue riding, first evaluate the condition of your motorcycle. If the engine is still running, turn it off. Inspect for fluid leaks,

check the tightness of critical nuts and bolts, and check the handlebar, control levers, brakes, and wheels. Ride slowly and cautiously. Your motorcycle may have suffered damage that is not immediately apparent. Have your motorcycle thoroughly checked at a qualified service facility as soon as possible.

Carbon Monoxide Hazard

Exhaust contains poisonous carbon monoxide, a colourless, odorless gas. Breathing carbon monoxide can cause loss of consciousness and may lead to death.

If you run the engine in confined or even partly enclosed area, the air you breathe could contain a dangerous amount of carbon monoxide. Never run your motorcycle inside a garage or other enclosure.

WARNING

Carbon monoxide gas is toxic. Breathing it can cause unconsciousness and even kill you.

Avoid any areas or activities that expose you to carbon monoxide.

Image Labels

Except KO, BR, II BR type

The following pages describe the label meanings. Some labels warn you of potential hazards that could cause serious injury. Others provide important safety information. Read this information carefully and don't remove the labels.

If a label comes off or becomes hard to read, contact your dealer for a replacement.

There is a specific symbol on each label. The meanings of each symbol and label are as follows.



Read instructions contained in Owner's Manual carefully.



Read instructions contained in Shop Manual carefully. In the interest of safety, take the motorcycle to be serviced only by your dealer.



DANGER (with RED background)

You **WILL** be **KILLED** or **SERIOUSLY HURT** if you don't follow instructions.

WARNING (with ORANGE background)

You **CAN** be **KILLED** or **SERIOUSLY HURT** if you don't follow instructions.

CAUTION (with YELLOW background)

You **CAN** be **HURT** if you don't follow instructions.



BATTERY LABEL DANGER

- Keep flame and spark away from the battery. Battery produce explosive gas that can cause explosion.
- Wear the eye protection and rubber gloves when handling the battery, or you can get burned or lose your eyesight by the battery electrolyte.
- Do not allow children and other people to touch a battery unless they understand proper handling and hazards of the battery very well.
- Handle the battery electrolyte with extreme care as it contains dilute sulfuric acid. Contact with your skin or eyes can burn you or cause loss of your eyesight.
- Read this manual carefully and understand it before handling the battery. Neglect of the instructions can cause personal injury and damage to the motorcycle.
- Do not use a battery with the electrolyte at or below the lower level mark. It can explode causing serious injury.



RADIATOR CAP LABEL

DANGER

NEVER OPEN WHEN HOT.

Hot coolant will scald you.

Relief pressure valve begins to open at **1.1 kgf/cm²**.

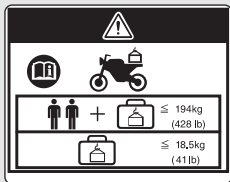

ACCESSORIES AND LOADING WARNING LABEL

WARNING

ACCESSORIES AND LOADING

- The safety stability and handling of this motorcycle may be affected by the addition of accessories and luggage.
- Read carefully the instructions contained in user's manual and installation guide before installing any accessory.
- The total weight of accessories and luggage added to rider's and passenger's weight should not exceed **194 kg (428 lb)**, which is the maximum weight capacity.
- The luggage weight must not exceed **18.5 kg (41 lb)** under any circumstances.
- The fitting of large fork-mounted or large handlebar mounted fairing is not recommended.

**REAR CUSHION LABEL**

GAS FILLED

Do not open. Do not heat.

TYRE INFORMATION LABEL

Cold tyre pressure:

[Driver only]

Front **250 kPa (2.50 kgf/cm², 36 psi)**Rear **290 kPa (2.90 kgf/cm², 42 psi)**

[Driver and passenger]

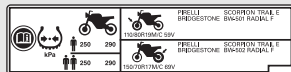
Front **250 kPa (2.50 kgf/cm², 36 psi)**Rear **290 kPa (2.90 kgf/cm², 42 psi)**

Tyre size:

Front **110/80R19M/C 59V**Rear **150/70R17M/C 69V**

Tyre brand: PIRELLI BRIDGESTONE

Front **SCORPION TRAIL E BW-501 RADIAL F**Rear **SCORPION TRAIL E BW-502 RADIAL F**



SAFETY REMINDER LABEL

For your protection, always wear helmet, protective apparel.

FUEL LABEL

Unleaded petrol only
Premium Recommended



CARGO LIMIT LABEL

Do not exceed **10 kg (22 lb)**

Safety Precautions

- Ride cautiously and keep your hands on the handlebar and feet on the footpegs.
- Keep passenger's hands onto the grab rail, passenger's feet on the footpegs while riding.
- Always consider the safety of your passenger, as well as other drivers and riders.

Protective Apparel

Make sure that you and any passenger are wearing an approved motorcycle helmet, eye protection, and high-visibility protective clothing. Ride defensively in response to weather and road conditions.

■ Helmet

Safety-standard certified, high-visibility, correct size for your head

- Must fit comfortably but securely, with the chin strap fastened

- Face shield with unobstructed field of vision or other approved eye protection

WARNING

Not wearing a helmet increases the chance of serious injury or death in a crash.

Make sure that you and any passenger always wear an approved helmet and protective apparel.

■ Gloves

Full-finger leather gloves with high abrasion resistance

■ Boots or Riding Shoes

Sturdy boots with non-slip soles and ankle protection

■ Jacket and Trousers

Protective, highly visible, long-sleeved jacket and durable trousers for riding (or a protective suit).

Riding Precautions

Running-in Period

During the first 500 km (300 miles) of running, follow these guidelines to ensure your motorcycle's future reliability and performance.

- Avoid full-throttle starts and rapid acceleration.
- Avoid hard braking and rapid down-shifts.
- Ride conservatively.

Brakes

Observe the following guidelines:

- Avoid excessively hard braking and down-shifts.
 - ▶ Sudden braking can reduce the motorcycle stability.
 - ▶ Where possible, reduce speed before turning; otherwise you risk sliding out.
- Exercise caution on low traction surfaces.
 - ▶ The tyres slip more easily on such surfaces and braking distances are longer.
- Avoid continuous braking.
 - ▶ Repeated braking, such as when descending long, steep slopes can seriously overheat the brakes, reducing their effectiveness. Use engine braking with intermittent use of the brakes to reduce speed.

Combined ABS

Your motorcycle is equipped with a brake system that distributes the braking force between the front and rear brakes.

The distribution of the braking force applied to the front and rear brakes is different when operating the lever only and when operating the pedal only.

For full braking effectiveness, operate both the lever and pedal together.

This model is also equipped with an Anti-lock Brake System (ABS) designed to help prevent the brakes from locking up during hard braking. Always use the recommended tyres to ensure correct ABS operation.

- ABS does not reduce braking distance. In certain circumstances, ABS may result in a longer stopping distance.
- ABS does not function at speeds below 10 km/h (6 mph).
- The brake lever and pedal may recoil slightly when applying the brakes. This is normal.

Engine Braking

Engine braking helps slow your motorcycle down when you release the throttle. For further slowing action, downshift to a lower gear. Use engine braking with intermittent use of the brakes to reduce speed when descending long, steep slopes.

Wet or Rainy Conditions

Road surfaces are slippery when wet, and wet brakes further reduce braking efficiency. Exercise extra caution when braking in wet conditions.

If the brakes get wet, apply the brakes while riding at low speed to help them dry.

Parking

- Park on a firm, level paved surface.
- If you must park on a slight incline or loose surface, park so that the motorcycle cannot move or fall over.
- Make sure that high-temperature parts cannot come into contact with flammable materials.
- Do not touch the engine, muffler, brakes and other high-temperature parts until they cool down.
- To reduce the likelihood of theft, always lock the handlebar and remove the key when leaving the motorcycle unattended. Use of an anti-theft device is also recommended.

■ Parking with the Side Stand

1. Stop the engine.
2. Push the side stand down.

3. Slowly lean the motorcycle to the left until its weight rests on the side stand.
4. Turn the handlebar fully to the left.
 - ▶ Turning the handlebar to the right reduces stability and may cause the motorcycle to fall.
5. Turn the ignition switch to the LOCK position and remove the key. ➤ P. 35

Refuelling and Fuel Guidelines

Follow these guidelines to protect the engine and catalytic converter:

- Use only unleaded petrol.
- Use recommended octane number. Using lower octane petrol will result in decreased engine performance.
- Do not use fuels containing a high concentration of alcohol. ➤ P. 116
- Do not use stale or contaminated petrol or an oil/petrol mixture.
- Avoid getting dirt or water in the fuel tank.

TCS (Traction Control System)

TCS (Traction Control System) assists you in maintaining traction while accelerating on slippery surfaces by regulating the engine's power output when it senses the rear wheel starting to lose traction.

TCS does not work in case of rear wheel lock caused by a sudden closing of the throttle. Do not close the throttle suddenly especially on the slippery road surface.

TCS may not compensate rough condition of roads or rapid and improper throttle operations. Always ride with a sufficient caution to the road and weather conditions.

In certain unusual conditions when your motorcycle gets stuck in shallow mud or fresh snow, it may be easier to free it with the TCS temporarily switched off.

It may also help to make it easier to maintain the balance and control in such condition as riding in an off-road terrain.

Always use the recommended tyres to ensure correct TCS operation.

Accessories & Modifications

We strongly advise that you do not add any accessories that were not specifically designed for your motorcycle by Honda or make modifications to your motorcycle from its original design. Doing so can make it unsafe. Modifying your motorcycle may also void your warranty and make your motorcycle illegal to operate on public roads and highways. Before deciding to install accessories on your motorcycle be certain the modification is safe and legal.

WARNING

Improper accessories or modifications can cause a crash in which you can be seriously hurt or killed.

Follow all instructions in this owner's manual regarding accessories and modifications.

Do not pull a trailer with, or attach a sidecar to, your motorcycle. Your motorcycle was not designed for these attachments, and their use can seriously impair your motorcycle's handling.

Loading

- Carrying extra weight affects your motorcycle's handling, braking and stability. Always ride at a safe speed for the load you are carrying.
- Avoid carrying an excessive load and keep within specified load limits.
 - ✘ **Maximum weight capacity / Maximum luggage weight** P. 125
- Tie all luggage securely, evenly balanced and close to the centre of the motorcycle.
- Do not place objects near the lights or the muffler.

WARNING

Overloading or improper loading can cause a crash and you can be seriously hurt or killed.

Follow all load limits and other loading guidelines in this manual.

Parts Location

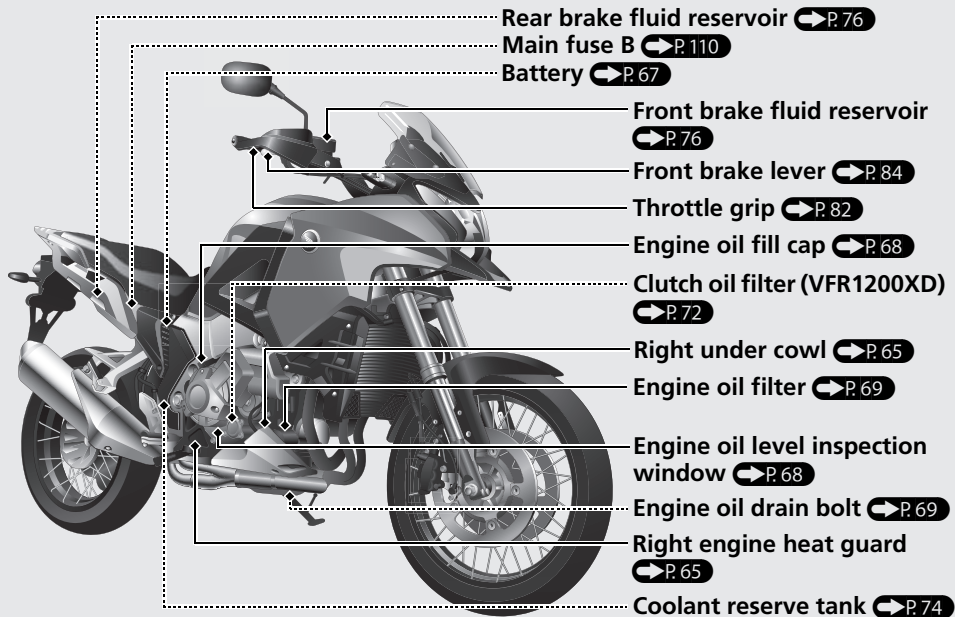

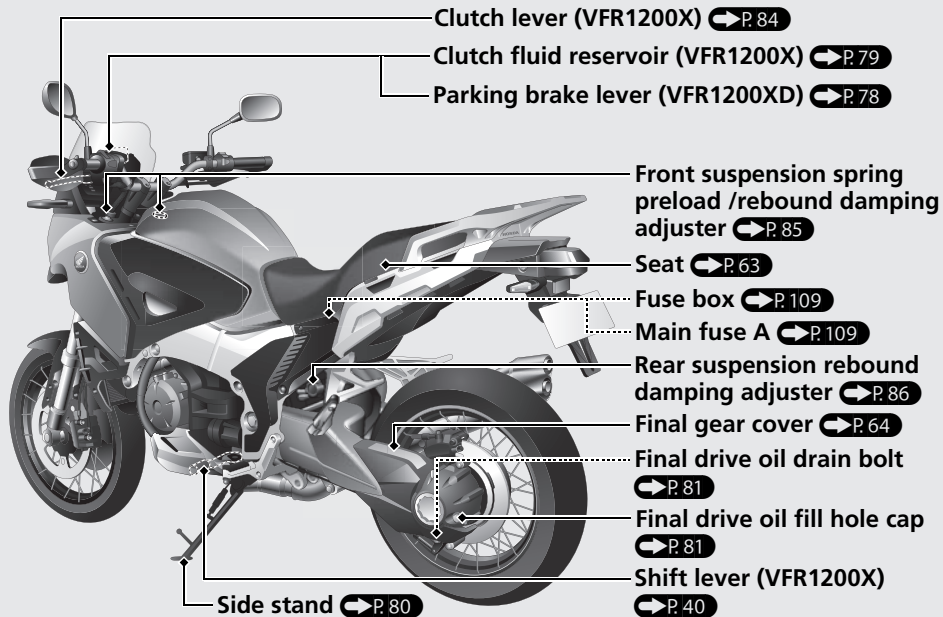

Instruments

(VFR1200X)

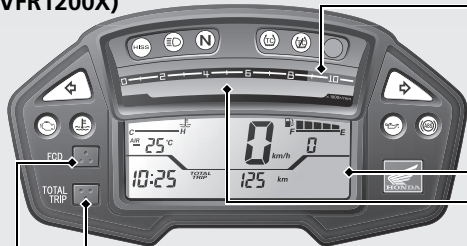

Tachometer red zone
(excessive engine rpm range)

Tachometer

NOTICE

Do not operate the engine in the tachometer red zone. Excessive engine speed can adversely affect engine life.

TOTAL/TRIP button

FCD button

TOTAL/TRIP button & **FCD** button

(E type only)

Press and hold both buttons to change the speed, mileage and fuel mileage units ("km/h" & "km" & "km/L" or "mph" & "mile" & "mile/L") for the speedometer, odometer, and tripmeter.

Press **FCD** button to select either "km/h" & "km" & "km/L" or "mph" & "mile" & "mile/L", then press **TOTAL/TRIP** button to set.

Speedometer



Fuel gauge

Remaining fuel when only 1st (E) segment starts flashing: approximately 4.0 litres (1.06 US gal, 0.88 Imp gal)



At the same time, the available driving distance is displayed.

Display Check

When the ignition switch is turned on, all the mode and digital segments will show. If any part of these displays does not come on when it should, have your dealer check for problems.

Instruments (Continued)



TOTAL/TRIP button

FCD button

Air temperature gauge (AIR)

Display range: -10 to 50 °C

- Below -11 °C: " - - " displays
 - Above 50 °C:
 - Air temperature gauge (flashing digits)
- The temperature readout may be incorrect at low speeds due to reflected heat.



Clock (12-hour display)

To set the clock P.24

Coolant temperature gauge (水温計)

- Above 122 °C:
 - High coolant temperature indicator lights
 - 5th (H) segment flashes
- ▶ Even if the engine coolant temperature is low, the cooling fan may start running when you rev up the engine. This is normal.

Backlight brightness adjustment P.25

Gear position indicator

Shows 1st to 6th gear position.

Odometer [TOTAL] & Tripmeter [TRIP A/B]

TOTAL/TRIP button switches between odometer & tripmeters.

- Odometer: Total distance ridden.
- Tripmeter: Distance ridden since tripmeter was reset (press and hold **TOTAL/TRIP** button to reset to 0.0 km/mile. At the same time reset the average fuel mileage).

Instruments *(Continued)*

To set the clock:

- 1 Turn the ignition switch ON while pressing and holding the **FCD** button. The hour digits start flashing.



- 2 Press **FCD** button until the desired hour is displayed.
 - ▶ Press and hold to advance the hour fast.



- 3 Press **TOTAL/TRIP** button. The minute digits start flashing.



- 4 Press **FCD** button until the desired minute is displayed.
 - ▶ Press and hold to advance the minute fast.



- 5 Press **TOTAL/TRIP** button. The clock is set.
 - ▶ The time can also be set by turning the ignition switch off.

The display will stop flashing automatically and the adjustment will be cancelled if the button is not pressed for about 30 seconds.

Backlight brightness adjustment:

You can adjust the brightness five levels.

- 1 Press and hold **TOTAL/TRIP** button when the display in the odometer. The brightness digits start flashing.
- 2 Press **FCD** button until the desired brightness is displayed.

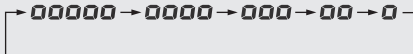

- 3 Press **TOTAL/TRIP** button. The brightness is set.
 - The brightness can also be set by turning the ignition switch off.The adjustment will be cancelled if the button is not pressed for about 30 seconds.

Instruments (Continued)



Fuel mileage meter

The current fuel mileage, average fuel mileage and no indication can be selected to press the **FCD** button.

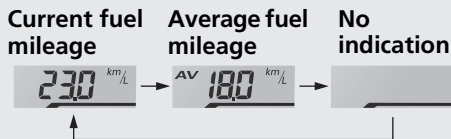

When the 1st (E) segment of the fuel gauge is flashed

Available driving distance is displayed. Then the amount of remaining fuel, current fuel mileage, average fuel mileage, no indication and available driving distance can be selected to press the **FCD** button.

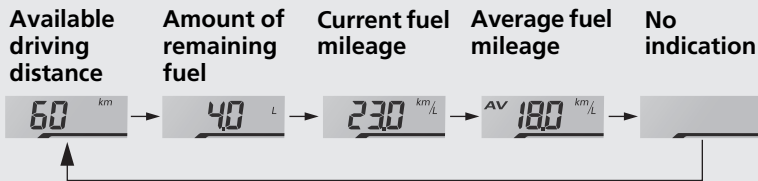

Indication mode change of current fuel mileage and average fuel mileage

Except E type

Press and hold **FCD** button to switch between "km/L" or "L/100 km".



Current fuel mileage

Current fuel mileage shows the current, or instant fuel mileage you are getting.

When your motorcycle speed is 5 km/h (3 mph) or below, " - - . - " is displayed.

Average fuel mileage

The average fuel mileage is based on the each tripmeter A and tripmeter B. The average fuel mileage since tripmeter was reset. When " - - . - " is displayed, see your dealer for service.

Average fuel mileage is also reset when the tripmeter is reset.  P.23

Available driving distance

When the 1st (E) segment of the fuel gauge is flashed (less than 4.0 litres), the estimated available driving distance is indicated. When the amount of remaining fuel becomes less than 1.0 litre, “- -” will be indicated. The indicated available driving distance is by calculation depending on the driving conditions, and the indicated figure may not always be the actual allowable distance. When the fuel gauge near to E or when E segment blinks, fill fuel promptly.



Remaining fuel

When the 1st (E) segment of the fuel gauge is flashed (less than 4.0 litres), the estimated amount of remaining fuel can be selected. When the amount of remaining fuel becomes less than 1.0 litre, “-.-” will be indicated. The amount of remaining fuel is calculated from the driving conditions. The indicated amount of remaining fuel may be different from the actual amount. When the fuel gauge near to E or when E segment blinks, fill fuel promptly.



Instruments (Continued)

(VFR1200XD)

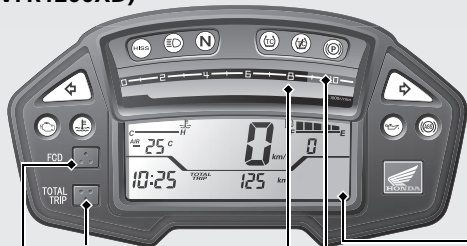

TOTAL/TRIP button

FCD button

TOTAL/TRIP button &

FCD button → P.20

Tachometer

NOTICE

Do not operate the engine in the tachometer red zone. Excessive engine speed can adversely affect engine life.

Tachometer red zone
(excessive engine rpm range)

Air temperature gauge (AIR) → P.22

Coolant temperature gauge ()

→ P.23

Speedometer

Fuel gauge → P.21



Fuel mileage meter → P.26

When the 1st (E) segment of the fuel gauge is flashed → P.27

Odometer [TOTAL] &
Tripmeter [TRIP A/B] → P.23

Clock (12-hour display)

To set the clock → P.24

Backlight brightness adjustment → P.25

D indicator



Comes on when the D mode is selected in the AT MODE.  P. 44

S indicator

Comes on when the S mode is selected in the AT MODE.  P. 44

Gear position indicator

The gear position is shown in the gear position indicator when the D, S mode or MT MODE are selected.

- ▶ "-" appears for a few seconds and then goes off when the engine starts.
- ▶ "-" flashes when the engine stop switch position is changed from RUN  to OFF  position with the ignition switch on.
- ▶ "-" flashes when the ignition switch is turned on with the engine stop switch OFF  position.

The indicator may flash if:

- ▶ The front wheel leaves the ground.
- ▶ You turn the wheel while the motorcycle is upright on the stand.

This is normal. To operate the system again, turn the ignition switch off, then on again.

If the "-" indicator is blinking in the gear position window while riding:  P. 97

Indicators

Parking brake indicator (VFR1200XD only)

Lights as a reminder that you have not released the parking brake lever.  P. 36

Low oil pressure indicator

Comes on when the ignition switch is turned on.

Goes off when the engine starts.

If it comes on while engine is running:  P. 93

ABS (Anti-lock Brake System) indicator

Comes on when the ignition switch is turned on. Goes off when your speed reaches approximately 10 km/h (6 mph).

If it comes on while riding:  P. 94

High coolant temperature indicator

If it comes on while riding:  P. 92



PGM-FI (Programmed Fuel Injection) malfunction indicator lamp (MIL)

Comes on briefly when the ignition switch is turned on with the engine stop switch in the RUN  position.

If it comes on while engine is running:  P. 93

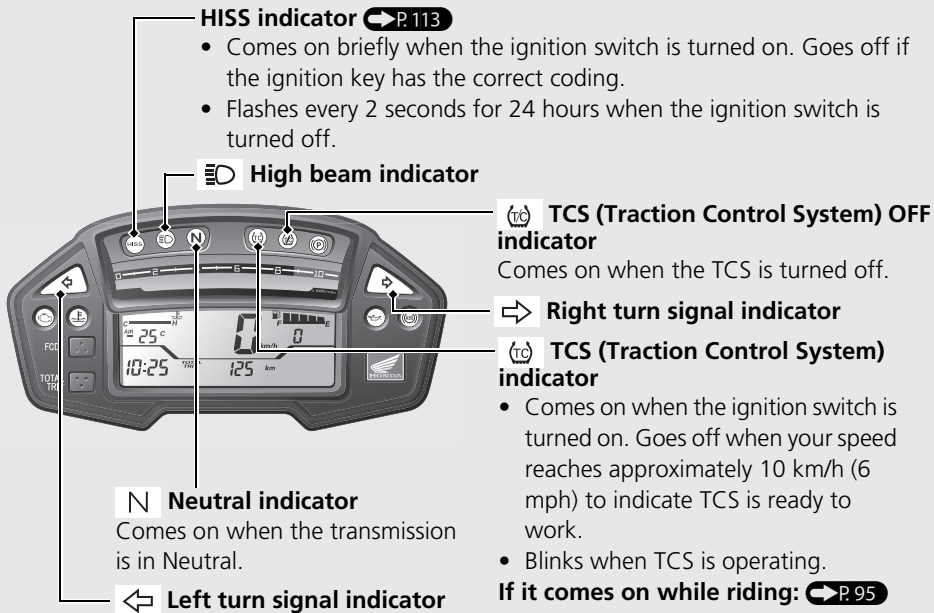

Switches

(VFR1200X)

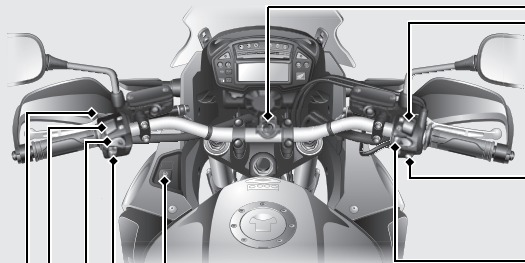

TCS (Traction Control System) OFF switch

Press and hold to turn the TCS on and off.

▶ The TCS OFF indicator comes on when TCS is turned off.



Turn signal switch

▶ Pressing the switch turns the turn signal off.



Horn button

Headlight dimmer switch

- ≡ D : High beam
- ≡ D : Low beam

Passing light control switch

Flashes the high beam headlight.

Engine stop switch

Should normally remain in the RUN  position.

▶ In an emergency, switch to the OFF  position to stop the engine.



Start button

Headlight turns off when operating the starter motor.



Hazard switch

Switchable when the ignition switch is on. Can be turned to off regardless of the ignition switch position.

▶ The signals continue flashing with the ignition switch is OFF or LOCK after the hazard switch is on.

Ignition Switch

Switches the electrical system on/off, locks the steering.

► Key can be removed when in the OFF or LOCK position.

Steering Lock

Lock the steering when parking to help prevent theft.

A U-shaped wheel lock or similar device is also recommended.

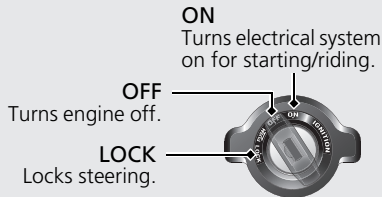
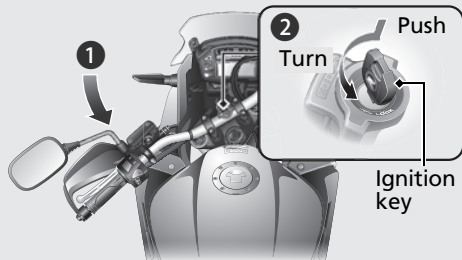

Locking

- 1 Turn the handlebar all the way to the left.
- 2 Push the key down, and turn the ignition switch to the LOCK position.
 - Jiggle the handlebar if the lock is difficult to engage.
- 3 Remove the key.

Unlocking

Insert the key, push it in, and turn the ignition switch to the OFF position.

Switches *(Continued)*

(VFR1200XD)

Parking brake lever and Release button

Be sure the parking brake is applied while parking and warming up the engine.

- ▶ Make sure the parking brake lever is released before riding.

To apply the parking brake lock

Pull the parking brake lever back to lock the rear wheel.

- ▶ Be sure the release button pops out and parking brake lever is not released.
- ▶ The parking brake lock will not function if the parking brake is not adjusted properly. **➡ P.78**

To release the parking brake lock

Release the parking brake lever by lightly pulling in the lever (1) and pressing the release button (2).

- ▶ Before riding, check that the parking brake indicator is turned off and make sure that the parking brake is fully released so there is no drag on the rear wheel.

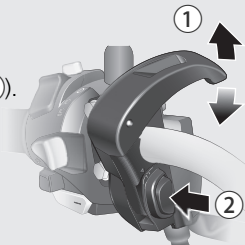



 **Hazard switch** **➡ P.34**

Shift up switch (+)

To shift up the gear. **➡ P.45**

**Headlight dimmer/
Passing light control
switch**

-  : High beam
-  : Low beam
-  : Flashes the high beam headlight.

 **Turn signal switch**

Shift down switch (-)

To shift down the gear.

➡ P.45

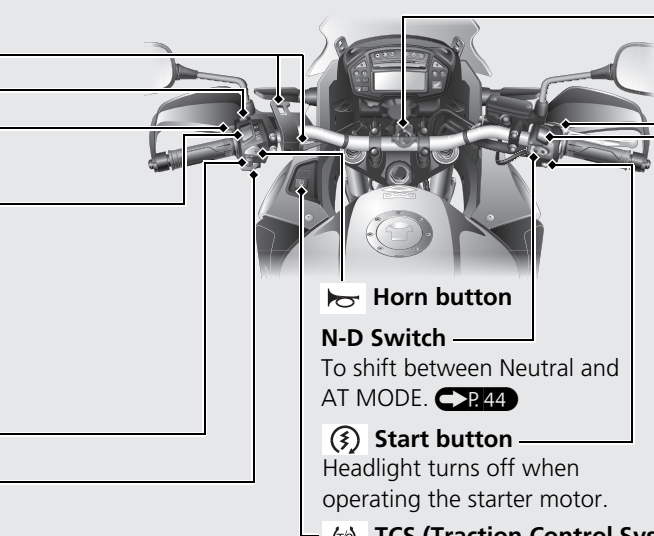

Ignition Switch

Switches the electrical system on/off, locks the steering.

- ▶ Key can be removed when in the OFF or LOCK position.

Steering Lock ➡ P.35

AT/MT Switch

To shift between the AT MODE and MT MODE.

➡ P.44

Engine stop switch

Should normally remain in the RUN  position.

- ▶ In an emergency, switch to the OFF  position to stop the engine.

Horn button

N-D Switch

To shift between Neutral and AT MODE. ➡ P.44

Start button

Headlight turns off when operating the starter motor.

TCS (Traction Control System) OFF switch

Press and hold to turn the TCS on and off.

- ▶ The TCS OFF indicator comes on when TCS is turned off.

Starting the Engine

(VFR1200X)

Start your engine using the following procedure, regardless of whether the engine is cold or warm.

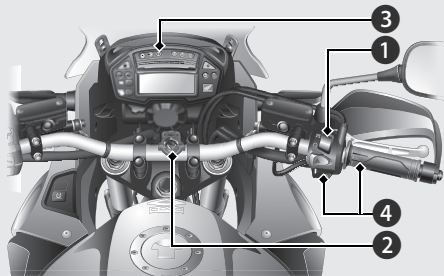

NOTICE

- If the engine does not start within 5 seconds, turn the ignition off and wait 10 seconds before trying to start the engine again for recovery of battery voltage.
- Extended fast idling and revving the engine can damage the engine, and the exhaust system.
- Snapping the throttle or fast idling for more than about 5 minutes may cause exhaust pipe discolouration.

- ① Make sure the engine stop switch is in the RUN  position.
- ② Turn the ignition switch to the ON position.
- ③ Shift the transmission to Neutral (**N** indicator comes on). Alternatively, pull in the clutch lever to start your motorcycle with the transmission in gear so long as the side stand is raised.
- ④ Press the start button with the throttle completely closed.

If the engine does not start:

- ① Open the throttle fully and press the start button for 5 seconds.
- ② Repeat the normal starting procedure.
- ③ If the engine starts, open the throttle slightly if idling is unstable.
- ④ If the engine does not start, wait 10 seconds before trying steps ① & ② again.



If Engine Will Not Start  P.91

(VFR1200XD)

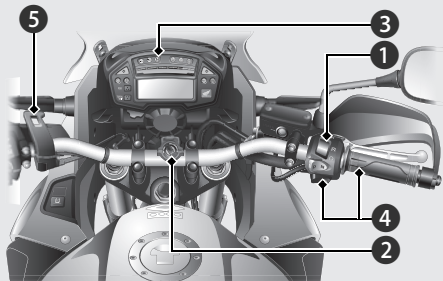
Start your engine using the following procedure, regardless of whether the engine is cold or warm.

**NOTICE**

- If the engine does not start within 5 seconds, turn the ignition off and wait 10 seconds before trying to start the engine again for recovery of battery voltage.
- Extended fast idling and revving the engine can damage the engine, and the exhaust system.
- Snapping the throttle or fast idling for more than about 5 minutes may cause exhaust pipe discolouration.

- 1 Make sure the engine stop switch is in the RUN  position.
- 2 Turn the ignition switch to the ON position.
- 3 Check the transmission in Neutral ( indicator comes on).
- 4 Press the start button with the throttle completely closed.
- 5 Make sure the parking brake lever is released before riding.

If Engine Does Not Start  P.38

When you stop the engine

- 1 To stop the engine, put gear to Neutral ( indicator comes on).
 - ▶ If you turn the ignition switch to the OFF position when the motorcycle is in gear, the engine will shut off with the clutch disengaged.
- 2 Turn the ignition switch off.
- 3 Pull the parking brake lever when you park the motorcycle.

Shifting Gears

(VFR1200X)

Your motorcycle transmission has six forward gears in a one-down, five-up shift pattern.

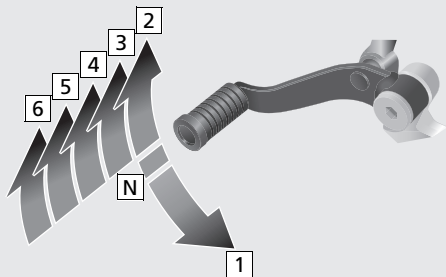

If you put the motorcycle in gear with the side stand down, the engine will shut off.

(VFR1200XD)

VFR1200XD is equipped with an automatically controlled 6-speed transmission. It can be shifted automatically (by AT MODE) or manually (by MT MODE).

Shifting Gears *(Continued)*

(VFR1200XD)

Dual Clutch Transmission

In order to respond to rider demands in a broad range of situations, the transmission is equipped with three operating modes, AT MODE (including D mode for regular operation and S mode for sporty riding); and MT MODE (MT mode for a 6-speed manual operation), which delivers the same shift feel as a manual transmission.

The Dual Clutch Transmission system runs a self check immediately after starting the engine. “-” appears in the gear position indicator window for a few seconds, then goes out. While “-” appears, you cannot shift into gear.

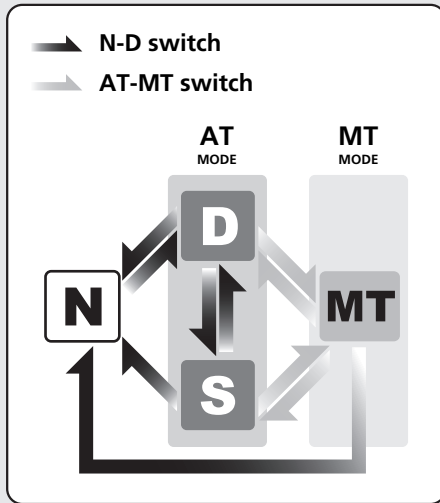

Neutral (N): Neutral is selected automatically when you turn the ignition switch to ON.

If neutral is not selected when you turn the ignition switch to ON:

- ▶ Turn the ignition off and on again.
- ▶ If neutral is still not selected after turning the engine off then on again.  **P. 97**
You may hear (click) noises when the transmission shifts to Neutral (N). This is normal.

When you can change between N and D:

- ▶ Motorcycle is stopped and the engine is idling.
- ▶ Throttle is completely off. It is not possible to change from Neutral to D mode while the throttle is applied.
- ▶ You cannot change between N and D mode while the wheels are rotating.
- ▶ Side stand is raised.

NOTICE

To prevent clutch damage, do not use the throttle to keep the motorcycle stopped uphill.

AT MODE: In this mode the gears are shifted automatically according to your riding conditions.

And also using the shift up switch (+) or shift down switch (-), you can temporarily shift up or down. These switches are convenient when you want to temporarily down-shift in front of a curve, etc.  **P. 45**

You can choose between two modes within AT MODE: D mode and S mode.

D mode (AT): This is the standard mode when AT MODE is selected. Select D mode for regular operation and efficient fuel economy.

S mode (AT): Select this mode while riding in AT MODE when you need more power, such as when overtaking, climbing hills, pulling away.

MT MODE: MT MODE (6-speed manual operation) You can choose between 6 gears in this mode.

Changing between Neutral and AT/MT

Changing from Neutral (N) to AT MODE

Press the D/S side of the N-D switch (①). The D mode indicator comes on, "1" is shown in the gear position indicator and first gear is selected.

Changing from AT or MT MODE to Neutral

Press N on the N-D switch (②).

Changing between D mode and S mode while in AT MODE

Press the D/S side of the N-D switch. The S or D mode indicator comes on (③,④).

Changing between AT MODE and MT MODE

Press the AT/MT switch (⑤).

The S or D indicator goes out while MT MODE is selected (⑥).

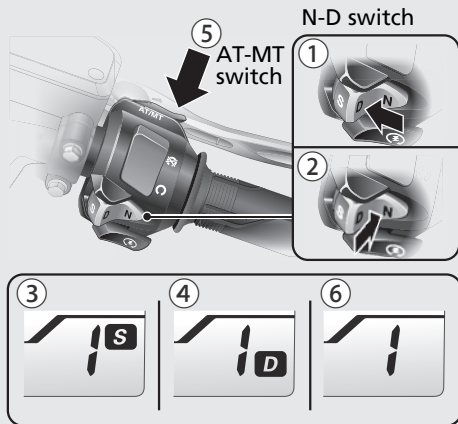

Riding in MT MODE

Shift up and down with the + and - switch. The selected gear is shown on the gear position indicator.

- ▶ If the MT MODE is selected, the transmission does not shift up automatically. Do not allow the engine revs to go into the red zone.
- ▶ The transmission automatically shifts down when you slow down, even in MT MODE.
- ▶ You will start from 1st gear even if MT MODE is selected.

Downshifting Blipping Control

In MT mode, this system controls down shifting with the throttle completely closed by increasing engine revs automatically to match the gear ratio.

- ▶ This system may not increase engine revs in some running conditions.

Gear shift operation

Shifting Up:

Press the shift up switch (+) (7).

Shifting Down:

Press the shift down switch (-) (8).

You cannot continue shifting gear by keeping the shift switch pressed.

To continue shifting gear release the switch and press it again.

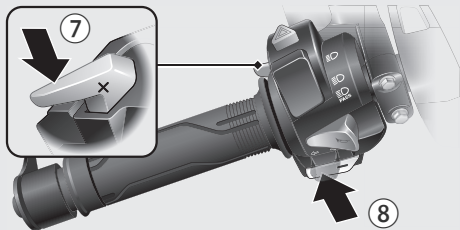

Shift Limit

You can't shift gear down if the engine revs exceed the limit.

Refuelling

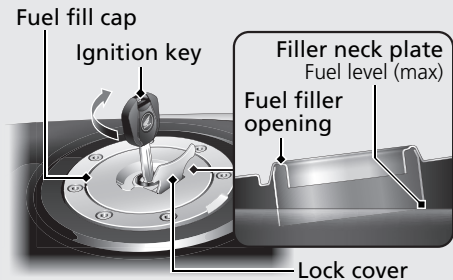

Do not fill with fuel above the plate.

Fuel type: Unleaded petrol only

Fuel octane number: Your motorcycle is designed to use Research Octane Number (RON) 95 or higher.

Tank capacity: 21.5 litres (5.68 US gal, 4.73 Imp gal)

Refuelling and Fuel Guideline ➔ P.15

Opening the Fuel Fill Cap

Open the lock cover, insert the ignition key, and turn it clockwise to open the cap.

Closing the Fuel Fill Cap

- 1 After refuelling, push the fuel fill cap closed until it locks.
- 2 Remove the key and close the cover.
 - ▶ The key cannot be removed if the cap is not locked.

⚠ WARNING

Petrol is highly flammable and explosive. You can be burned or seriously injured when handling fuel.

- Stop the engine, and keep heat, sparks, and flame away.
- Handle fuel only outdoors.
- Wipe up spills immediately.

Storage Equipment

A helmet holder, a helmet set wire (in the tool kit) and a tool kit are located under the seat. There is also space to store a U-shaped lock (Except BR type). The document bag is located on the underside of the seat.

Tool kit

U-shaped lock
(Except
BR type)

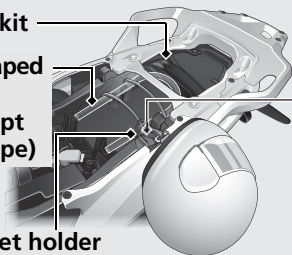

Helmet holder

- ▶ The U-shaped lock is held in place on the rear fender by a rubber strap.
- ▶ Use the helmet holder only when parked.
- ▶ Some U-shaped locks may not fit in the compartment due to their size or design.

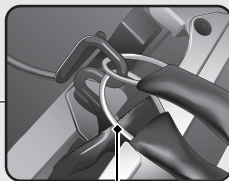

Helmet
set wire

Underside of the seat

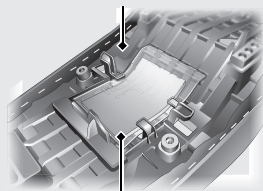

Document bag

⚠ WARNING

Riding with a helmet attached to the holder can interfere with the rear wheel or suspension and could cause a crash in which you can be seriously hurt or killed.

Use the helmet holder only while parked. Do not ride with a helmet secured by the holder.

Removing the seat. ➡ P.63

Maintenance

Please read “Importance of Maintenance” and “Maintenance Fundamentals” carefully before attempting any maintenance. Refer to “Specifications” for service data.

Importance of Maintenance	P. 49	Coolant	P. 74
Maintenance Schedule	P. 50	Brakes/Clutch	P. 76
Maintenance Fundamentals	P. 53	Side Stand	P. 80
Tool kit	P. 62	Final Drive Oil	P. 81
Removing & Installing Body Components ..	P. 63	Throttle	P. 82
Seat.....	P. 63	Other Adjustments	P. 84
Clip	P. 64	Clutch and Brake Levers.....	P. 84
Final Gear Cover	P. 64	Front Suspension	P. 85
Right Engine Heat Guard & Right Under Cowl ..	P. 65	Rear Suspension.....	P. 86
Battery	P. 67	Headlight Aim.....	P. 88
Engine Oil	P. 68	Brakelight Switch	P. 88
		Windscreen Height	P. 89

Importance of Maintenance

Keeping your motorcycle well-maintained is absolutely essential to your safety and to protect your investment, obtain maximum performance, avoid breakdowns, and reduce air pollution. Maintenance is the owner's responsibility. Be sure to inspect your motorcycle before each ride, perform the periodic checks specified in the Maintenance Schedule. ➔ P. 50

WARNING

Improperly maintaining your motorcycle or failing to correct a problem before you ride can cause a crash in which you can be seriously hurt or killed.

Always follow the inspection and maintenance recommendations and schedules in this owner's manual.

Maintenance Safety

Always read the maintenance instructions before you begin each task, and make sure that you have the tools, parts, and skills required. We cannot warn you of every conceivable hazard that can arise in performing maintenance. Only you can decide whether or not you should perform a given task.

Follow these guidelines when performing maintenance.

- Stop the engine and remove the key.
- Park your motorcycle on a firm, level surface using the side stand or a maintenance stand to provide support.
- Allow the engine, muffler, brakes, and other high-temperature parts to cool before servicing as you can get burned.
- Run the engine only when instructed, and do so in a well-ventilated area.









Maintenance Schedule

The maintenance schedule specifies the maintenance requirements necessary to ensure safe, dependable performance, and proper emission control.

Maintenance work should be performed in accordance with Honda's standards and specifications by properly trained and equipped technicians. Your dealer meets all of these requirements. Keep an accurate record of maintenance to help ensure that your motorcycle is properly maintained. Make sure that whomever performs the maintenance completes this record.

All scheduled maintenance is considered a normal owner operating cost and will be charged for by your dealer. Retain all receipts. If you sell the motorcycle, these receipts should be transferred with the motorcycle to the new owner.

Honda recommends that your dealer should road test your motorcycle after each periodic maintenance is carried out.

Items	Pre-ride Check P. 53	Frequency *1						Annual Check	Regular Replace	Refer to page
		x 1,000 km	1	12	24	36	48			
		x 1,000 mi	0.6	8	16	24	32			
Fuel Line				I	I	I	I	I		-
Fuel Level		I								46
Throttle Operation		I		I	I	I	I	I		82
Air Cleaner *2					R		R			-
Spark Plug					I		R			-
Valve Clearance					I		I			-
Engine Oil		I	R	R	R	R	R	R	R	68
Engine Oil Filter			R	R	R	R	R	R	R	69
Clutch Oil Filter		VFR1200XD	R		R		R			72
Engine Idle Speed			I	I	I	I	I	I		-
Radiator Coolant *3		I		I	I	I	I	I	3 Years	74
Cooling System				I	I	I	I	I		-
Secondary Air Supply System				I	I	I	I	I		-

Maintenance Level







 : Intermediate. We recommend service by your dealer, unless you have the necessary tools and are mechanically skilled. Procedures are provided in an official Honda Shop Manual.

 : Technical. In the interest of safety, have your motorcycle serviced by your dealer.

Maintenance Legend

I : Inspect (clean, adjust, lubricate, or replace if necessary)
R : Replace

Maintenance Schedule

Items	Pre-ride Check P. 53	Frequency *1						Annual Check	Regular Replace	Refer to page
		x 1,000 km	1	12	24	36	48			
		x 1,000 mi	0.6	8	16	24	32			
Final Drive Oil									3 Years	81
Brake Fluid *3	<input type="checkbox"/>			<input type="checkbox"/>	<input type="checkbox"/>	<input type="checkbox"/>	<input type="checkbox"/>	<input type="checkbox"/>	2 Years	76
Brake Pads Wear	<input type="checkbox"/>			<input type="checkbox"/>	<input type="checkbox"/>	<input type="checkbox"/>	<input type="checkbox"/>	<input type="checkbox"/>		77
Brake System			<input type="checkbox"/>	<input type="checkbox"/>	<input type="checkbox"/>	<input type="checkbox"/>	<input type="checkbox"/>	<input type="checkbox"/>		53
Brakelight Switch				<input type="checkbox"/>	<input type="checkbox"/>	<input type="checkbox"/>	<input type="checkbox"/>	<input type="checkbox"/>		88
Brake Lock Operation		VFR1200XD	<input type="checkbox"/>	<input type="checkbox"/>	<input type="checkbox"/>	<input type="checkbox"/>	<input type="checkbox"/>	<input type="checkbox"/>		78
Headlight Aim				<input type="checkbox"/>	<input type="checkbox"/>	<input type="checkbox"/>	<input type="checkbox"/>	<input type="checkbox"/>		88
Lights/Horn	<input type="checkbox"/>									-
Engine Stop Switch	<input type="checkbox"/>									-
Clutch System		VFR1200X		<input type="checkbox"/>	<input type="checkbox"/>	<input type="checkbox"/>	<input type="checkbox"/>	<input type="checkbox"/>		84
Clutch Fluid *3	<input type="checkbox"/>	VFR1200X		<input type="checkbox"/>	<input type="checkbox"/>	<input type="checkbox"/>	<input type="checkbox"/>	<input type="checkbox"/>	2 Years	79
Side Stand	<input type="checkbox"/>			<input type="checkbox"/>	<input type="checkbox"/>	<input type="checkbox"/>	<input type="checkbox"/>	<input type="checkbox"/>		80
Suspension				<input type="checkbox"/>	<input type="checkbox"/>	<input type="checkbox"/>	<input type="checkbox"/>	<input type="checkbox"/>		-
Nuts, Bolts, Fasteners			<input type="checkbox"/>	<input type="checkbox"/>	<input type="checkbox"/>	<input type="checkbox"/>	<input type="checkbox"/>	<input type="checkbox"/>		-
Wheels/Tyres		<input type="checkbox"/>	<input type="checkbox"/>	<input type="checkbox"/>	<input type="checkbox"/>	<input type="checkbox"/>	<input type="checkbox"/>	<input type="checkbox"/>		59
Steering Head Bearings			<input type="checkbox"/>	<input type="checkbox"/>	<input type="checkbox"/>	<input type="checkbox"/>	<input type="checkbox"/>	<input type="checkbox"/>		-

Notes:

*1 : At higher odometer readings, repeat at the frequency interval established here.





*2 : Service more frequently when riding in unusually wet or dusty areas.

*3 : Replacement requires mechanical skill.

Pre-ride Inspection



To ensure safety, it is your responsibility to perform a pre-ride inspection and make sure that any problem you find is corrected. A pre-ride inspection is a must, not only for safety, but because having a breakdown, or even a flat tyre, can be a major inconvenience.

Check the following items before you ride motorcycle:

- Fuel level – Fill fuel tank when necessary.  P. 46
- Throttle – Check for smooth opening and full closing in all steering positions.  P. 82
- Engine oil level – Add engine oil if necessary. Check for leaks.  P. 68
- Coolant level – Add coolant if required. Check for leaks.  P. 74

- Brakes – Check operation;
Front and Rear: check brake fluid level and pads wear.  P. 76, 77
- Lights and horn – Check that lights, indicators and horn function properly.
- Engine stop switch – Check for proper function.

(VFR1200X)

- Clutch – Check clutch fluid level.  P. 79
- Side stand ignition cut-off system – Check for proper function.  P. 80
- Wheels and tyres – Check condition, air pressure and adjust if necessary.  P. 59

Replacing Parts

Always use Honda Genuine Parts or their equivalents to ensure reliability and safety.

Except BR, II BR type

When ordering coloured components, specify the model name, colour, and code mentioned on the colour label. The colour label is attached to the rear fender under the seat. ➡ P. 63

Except BR, II BR type

Colour label

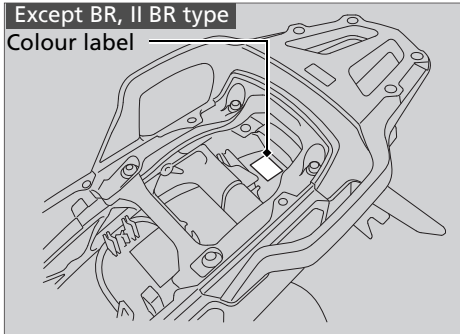

⚠ WARNING

Installing non-Honda parts may make your motorcycle unsafe and cause a crash in which you can be seriously hurt or killed.

Always use Honda Genuine Parts or equivalents that have been designed and approved for your motorcycle.

Battery

Your motorcycle has a maintenance-free type battery. You do not have to check the battery electrolyte level or add distilled water. Clean the battery terminals if they become dirty or corroded.

Do not remove the battery cap seals. There is no need to remove the cap when charging.

NOTICE

Your battery is a maintenance-free type and can be permanently damaged if the cap strip is removed.



This symbol on the battery means that this product must not be treated as household waste.

NOTICE

An improperly disposed of battery can be harmful to the environment and human health.

Always confirm local regulations for battery disposal.

WARNING

The battery gives off explosive hydrogen gas during normal operation.

A spark or flame can cause the battery to explode with enough force to kill or seriously hurt you.

Wear protective clothing and a face shield, or have a skilled mechanic do the battery servicing.

I Cleaning the Battery Terminals

1. Remove the battery.  P. 67
2. If the terminals are starting to corrode and are coated with a white substance, wash with warm water and wipe clean.

Maintenance Fundamentals

3. If the terminals are heavily corroded, clean and polish the terminals with a wire brush or sandpaper. Wear safety glasses.

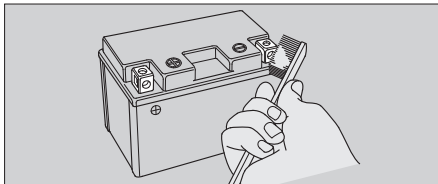

4. After cleaning, reinstall the battery.

The battery has a limited life span. Consult your dealer about when you should replace the battery. Always replace the battery with another maintenance-free battery of the same type.

NOTICE

Installing non-Honda electrical accessories can overload the electrical system, discharging the battery and possibly damaging the system.

Fuses

Fuses protect the electrical circuits on your motorcycle. If something electrical on your motorcycle stops working, check for and replace any blown fuses. ➤ P. 109

Inspecting and Replacing Fuses

Turn off the ignition switch to remove and inspect fuses. If a fuse is blown, replace with a fuse of the same rating. For fuse ratings, see "Specifications." ➤ P. 127

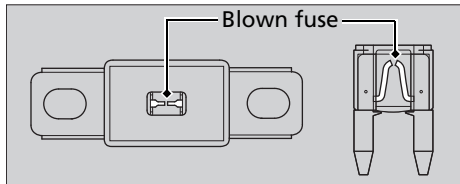

NOTICE

Replacing a fuse with one that has a higher rating greatly increases the chance of damage to the electrical system.

If a fuse fails repeatedly, you likely have an electrical fault. Have your motorcycle inspected by your dealer.

Engine Oil

Engine oil consumption and oil quality deteriorates according to riding conditions and time elapsed.

Check the engine oil level regularly, and add the recommended engine oil if necessary. Dirty oil or old oil should be changed as soon as possible.

Selecting the Engine Oil

For recommended engine oil, see “Specifications.” ➤ P. 126

If you use non-Honda engine oil, check the label to make sure that the oil satisfies all of the following standards:

- JASO T 903 standard*1: MA
- SAE standard*2: 10W-30
- API classification*3: SG or higher

- *1. The JASO T 903 standard is an index for engine oils for 4-stroke motorcycle engines. There are two classes: MA and MB. For example, the following label shows the MA classification.

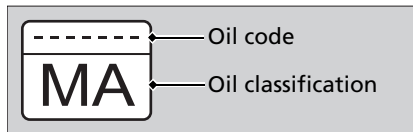

- *2. The SAE standard grades oils by their viscosity.
- *3. The API classification specifies the quality and performance rating of engine oils. Use SG or higher oils, excluding oils marked as “Energy Conserving” on the circular API service symbol.

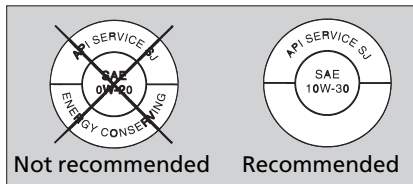

Brake Fluid (Clutch Fluid)

Do not add or replace brake fluid, except in an emergency. Use only fresh brake fluid from a sealed container. If you do add fluid, have the brake system serviced by your dealer as soon as possible.

NOTICE

Brake fluid can damage plastic and painted surfaces. Wipe up spills immediately and wash thoroughly.

Recommended brake fluid:

Honda DOT 4 Brake Fluid or equivalent

Final Drive Oil

Recommended final drive oil:

Hypoid gear oil SAE 80

Recommended Coolant

Pro Honda HP is a pre-mixed solution of antifreeze and distilled water.

Concentration:

50% antifreeze and 50% distilled water

A concentration of antifreeze below 40% will not provide proper corrosion and cold temperature protection.

A concentration of up to 60% will provide better protection in colder climates.

NOTICE

Using coolant not specified for aluminium engines or ordinary tap water can cause corrosion.

Tyres (Inspecting/Replacing)

Checking the Air Pressure

Visually inspect your tyres and use an air pressure gauge to measure the air pressure at least once a month or any time you think the tyres look low. Always check air pressure when your tyres are cold.

Inspecting for Damage

Inspect the tyres for cuts, slits, or cracks that exposes fabric or cords, or nails or other foreign objects embedded in the side of the tyre or the tread. Also inspect for the bumps or bulges in the side walls of the tyres.

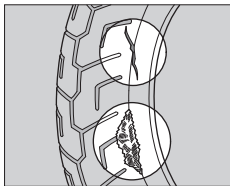

Inspecting for Abnormal Wear

Inspect the tyres for signs of abnormal wear on the contact surface.

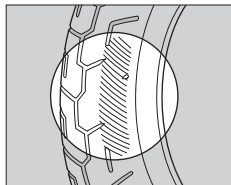

Inspecting Tread Depth

Inspect the tread wear indicators. If they become visible, replace the tyres immediately. For safe riding, you should replace the tyres when the minimum tread depth is reached.

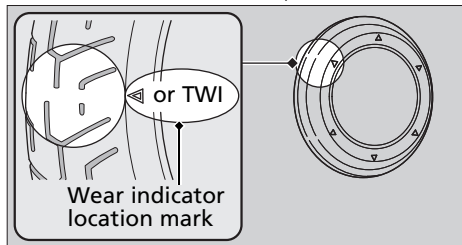

WARNING

Riding on tyres that are excessively worn or improperly inflated can cause a crash in which you can be seriously hurt or killed.

Follow all instructions in this owner's manual regarding tyre inflation and maintenance.

Germany

German law prohibits use of tyres whose tread depth is less than 1.6 mm.

Have your tyres replaced by your dealer. For recommended tyres, air pressure and minimum tread depth, see "Specifications."

➤ P. 126

Follow these guidelines whenever you replace tyres.

- Use the recommended tyres or equivalents of the same size, construction, speed rating, and load range.
- Have the wheel balanced with Honda Genuine balance weights or equivalents after the tyre is installed.
- Do not install a tube inside a tubeless tyre on this motorcycle. Excessive heat build-up can cause the tube to burst.
- Use only tubeless tyres on this motorcycle. The rims are designed for tubeless tyres, and during hard acceleration or braking, a tube-type tyre could slip on the rim and cause the tyre to rapidly deflate.

⚠ WARNING

Installing improper tyres on your motorcycle can adversely affect handling and stability, and can cause a crash in which you can be seriously hurt or killed.

Always use the size and type of tyres recommended in this owner's manual.

Air Cleaner

This motorcycle is equipped with a viscous type air cleaner element.

Air blow cleaning or any other cleaning can degrade the viscous element performance and cause the intake of dust.

Do not perform the maintenance.
Should be serviced by your dealer.

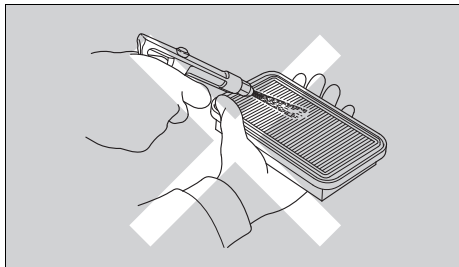

Tool kit

The tool kit is stored under the seat.  P. 47

You can perform some roadside repairs, minor adjustments and parts replacement with the tools contained in the kit.

- Spark plug wrench
- 8 × 12 mm Open end wrench
- 10 × 14 mm Open end wrench
- 12 × 17 mm Open end wrench
- 14 × 17 mm Open end wrench
- Standard/Phillips screwdriver
- Screwdriver grip
- 5 mm Hex wrench
- Helmet set wire

Seat

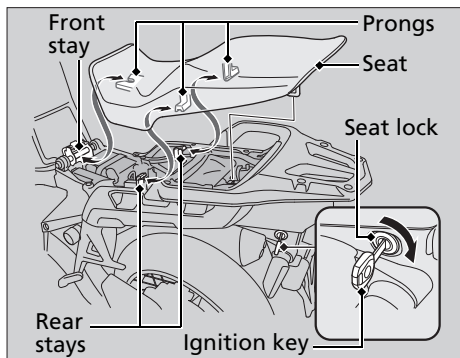

Removal

1. Insert the ignition key into the seat lock, and turn and hold the key clockwise to unlock the seat.
2. Pull the rear of the seat back and up.

Installation

1. Insert the front and rear prongs into the front and rear stays on the frame.
2. Push forward and down on the rear of the seat until it locks in place.

Make sure that the seat is locked securely in position to pull it up lightly.

The seat locks automatically when closed.

Take care not to lock your key in the underseat compartment.

Clip

The clips must be removed to remove the right rear cowl.

Removal

1. Press down on the centre pin to release the lock.
2. Pull the clip out of the hole.

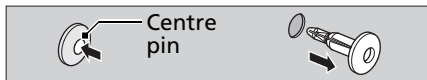

Installation

1. Push the bottom of the centre pin.

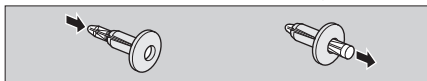

2. Insert the clip into the hole.
3. Press down on the centre pin to lock the clip.

Final Gear Cover

The final gear cover must be opened to drain the final gear oil.

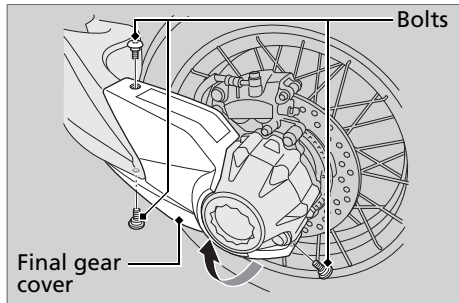

Removal

1. Remove the bolts.
2. Open the final gear cover.

Installation

Install the parts in the reverse order of removal.

Right Engine Heat Guard & Right Under Cowl

The right engine heat guard must be opened to service the coolant reserve tank or to check the engine number.

(VFR1200X)

The right under cowl must be removed to service the engine oil filter.

(VFR1200XD)

The right under cowl must be removed to service the engine oil filter and the clutch oil filter.

Removal

1. Remove the clip. ► P. 64
2. Remove the prongs from the grommets.
3. Remove the right engine heat guard.

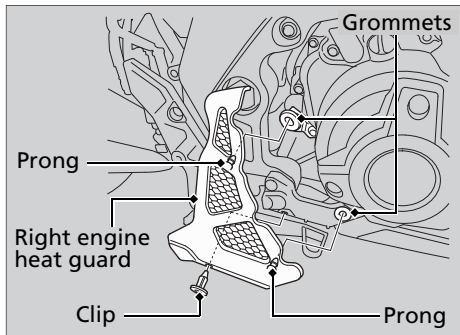

4. Remove the bolts.
5. Remove the prong from the grommet.
6. Remove the right under cowl.

(VFR1200X)

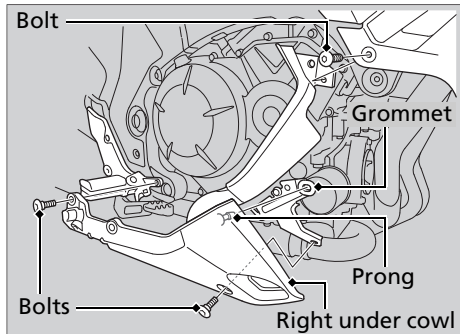

(VFR1200XD)

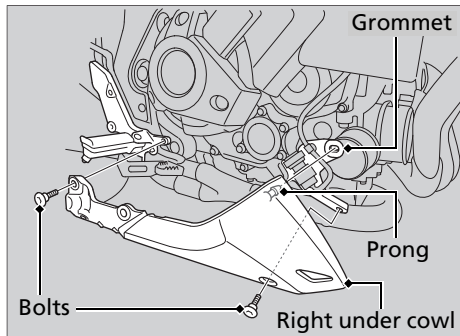

Installation

Install the parts in the reverse order of removal.

Battery

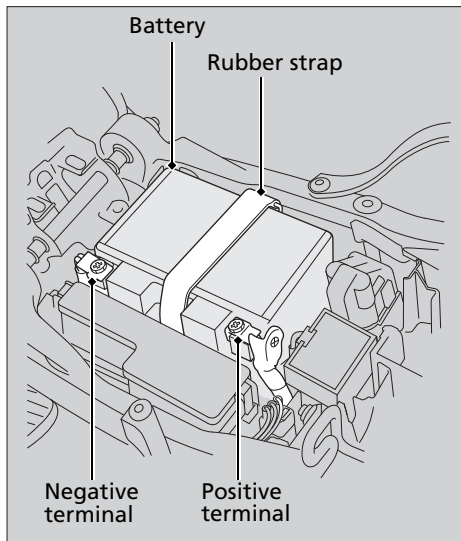

Removal

1. Remove the seat. ► P. 63
2. Unhook the rubber strap.
3. Disconnect the negative \ominus terminal from the battery.
4. Disconnect the positive \oplus terminal from the battery.
5. Remove the battery taking care not to drop the terminal nuts.

Installation

Install the parts in the reverse order of removal. Always connect the positive \oplus terminal first. Make sure that bolts and nuts are tight.

The clock will be reset 1:00 if the battery is disconnected.

For proper handling of the battery, see "Maintenance Fundamentals." ► P. 55
Battery Goes Dead ► P. 105

Checking the Engine Oil

1. If the engine is cold, idle the engine for 3 to 5 minutes.
2. Turn the ignition switch off, stop the engine and wait 2 to 3 minutes.
3. Place your motorcycle in an upright position on a firm, level surface.
4. Check that the oil level is between the upper and lower level marks in the oil inspection window.

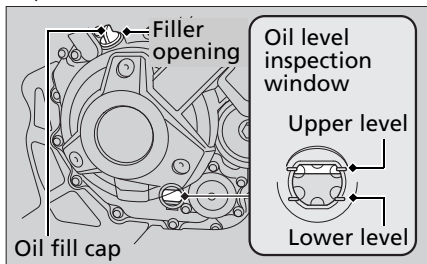

Adding Engine Oil

If the engine oil is below or near the lower level mark, add the recommended engine oil.

▶ P. 57

1. Add the recommended oil until it reaches the upper level mark.
 - ▶ Place your motorcycle in an upright position on a firm, level surface when checking the oil level.
 - ▶ Do not overfill above the upper level mark.
 - ▶ Make sure no foreign objects enter the oil filler opening.
 - ▶ Wipe up any spills immediately.
2. Securely reinstall the oil fill cap.

NOTICE

Overfilling with oil or operating with insufficient oil can cause damage to your engine. Do not mix different brands and grades of oil. They may affect lubrication and clutch operation.

For the recommended oil and oil selection guidelines, see “Maintenance Fundamentals.” ➤ P. 57

Changing Engine Oil & Filter

Changing the oil and filter requires special tools. We recommend that you have your motorcycle serviced by your dealer.

Use a new Honda Genuine oil filter or equivalent specified for your model.

NOTICE

Using the wrong oil filter can result in serious damage to the engine.

1. If the engine is cold, idle the engine for 3 to 5 minutes.
2. Turn the ignition switch off, stop the engine and wait for 2 to 3 minutes.
3. Park on a firm, level surface and lower the side stand.
4. Place a drain pan under the drain bolt.
5. Remove the oil fill cap, drain bolt, and sealing washer to drain the oil.

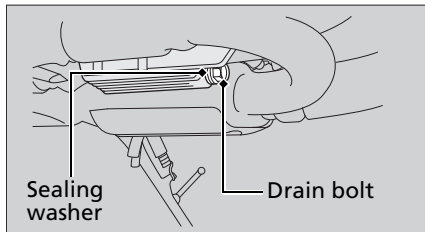

Engine Oil ► Changing Engine Oil & Filter

6. Remove the right engine heat guard and right under cowl. ► P. 65
7. Remove the oil filter with a filter wrench and let the remaining oil drain out. Make sure the prior seal is not stuck to the engine.
► Discard the oil and oil filter at an approved recycling centre.

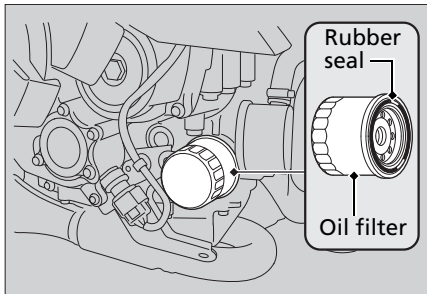

8. Apply a thin coat of engine oil to the rubber seal of a new oil filter.
9. Install a new oil filter and tighten.

Torque: 26 N·m (2.7 kgf·m, 19 lbf·ft).

10. Install a new sealing washer onto the drain bolt. Tighten the drain bolt.

Torque: 29 N·m (3.0 kgf·m, 21 lbf·ft).

11. Fill the crankcase with the recommended oil (► P. 57) and install the oil fill cap.

Required oil**VFR1200X****When changing oil & engine oil filter:**

3.3 litres (3.5 US qt, 2.9 Imp qt)

When changing oil only:

3.1 litres (3.3 US qt, 2.7 Imp qt)

VFR1200XD**When changing oil & engine oil filter:**

3.9 litres (4.1 US qt, 3.4 Imp qt)

When changing oil only:

3.6 litres (3.8 US qt, 3.2 Imp qt)

12. Check the oil level. ► P. 68
13. Check that there are no oil leaks.
14. Install the right engine heat guard and right under cowl.

Changing Clutch Oil Filter (VFR1200XD only)

Use a new Honda Genuine clutch oil filter or equivalent specified for your model.

NOTICE

Using the wrong clutch oil filter can result in serious damage to the transmission.

1. Follow the steps 1-7 of Changing Engine Oil & Filter. ► P. 69

2. Remove the clutch oil filter cover, clutch oil filter and spring by removing the clutch oil filter bolts A and B.
 - Discard the oil and clutch oil filter at an approved recycling centre.

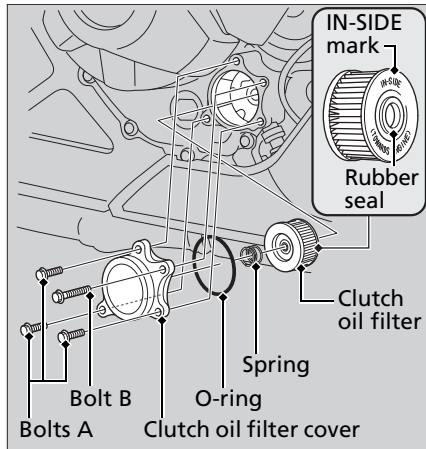

3. Install the new clutch oil filter with the rubber seal facing in, toward the engine. You will see "IN-SIDE" mark on the clutch oil filter body, near the seal.
4. Replace the O-ring and apply a thin coat of engine oil to the new O-ring when before installing it.
5. Install the spring and the clutch oil filter cover.
6. Install the clutch oil filter bolts A, B and tighten.
7. Apply a thin coat of engine oil to the rubber seal of a new engine oil filter.
 ► P. 70
8. Install a new engine oil filter and tighten.

Torque: 26 N·m (2.7 kgf·m, 19 lbf·ft).

9. Install a new sealing washer onto the drain bolt. Tighten the drain bolt.

Torque: 29 N·m (3.0 kgf·m, 21 lbf·ft).

10. Fill the crankcase with the recommended oil (► P. 57) and install the oil fill cap.

Required oil

When changing oil, engine oil filter & clutch oil filter:

engine oil filter:

4.0 litres (4.2 US qt, 3.5 Imp qt)

11. Check the oil level. ► P. 68
12. Check that there are no oil leaks.
13. Install the right engine heat guard and right under cowl.

Checking the Coolant

1. Place your motorcycle on a firm, level surface.
2. Hold your motorcycle in an upright position.
3. Check that the coolant level is between the UPPER and LOWER level marks in the reserve tank.

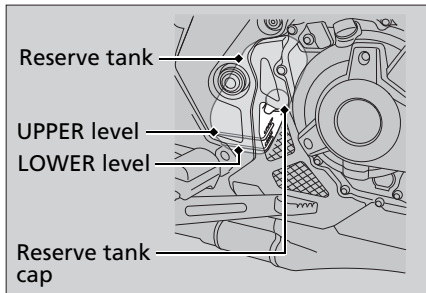

If the coolant level is dropping noticeably or the reserve tank is empty, you likely have a serious leak. Have your motorcycle inspected by your dealer.

Adding Coolant

1. If the coolant level is below the LOWER level, add the recommended coolant P. 58 until the level reaches the UPPER level mark.
Add fluid only from the reserve tank cap and do not remove radiator cap.
2. Remove the right engine heat guard. P. 65

3. Remove the reserve tank cap and add fluid while monitoring the coolant level.
 - Do not overfill above the UPPER level mark.
 - Make sure no foreign objects enter the reserve tank opening.
4. Securely reinstall the cap.
5. Reinstall the right engine heat guard.

WARNING

Removing the radiator cap while the engine is hot can cause the coolant to spray out, potentially scalding you.

Always let the engine and radiator cool down before removing the radiator cap.

Changing Coolant

Have your dealer change the coolant unless you have the proper tools and are mechanically qualified.

Checking Brake Fluid

1. Place your motorcycle in an upright position on a firm, level surface.
2. **Front** Check that the brake fluid reservoir is horizontal and that the fluid level is above the LOWER level mark.
3. **Rear** Check that the brake fluid reservoir is horizontal and that the fluid level is between the LOWER level and UPPER level marks.

If the brake fluid level in either reservoir is below the LOWER level mark or the brake lever and pedal freeplay becomes excessive, inspect the brake pads for wear. If the brake pads are not worn, you most likely have a leak. Have your motorcycle inspected by your dealer.

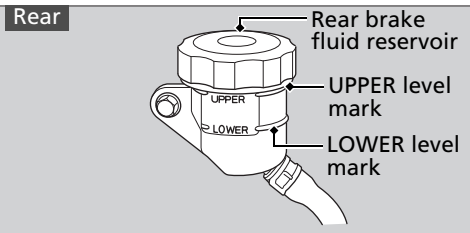
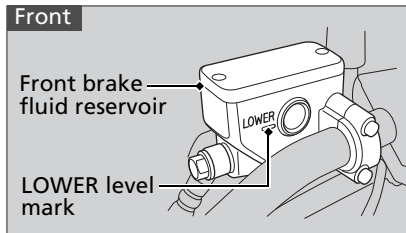

Inspecting the Brake Pads

Check the condition of the brake pad wear indicator wear indicators. The pads need to be replaced if a brake pad is worn to the wear indicator.

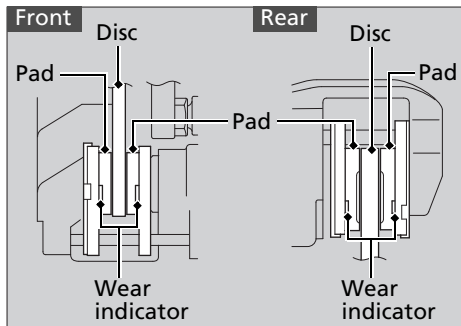

1. **Front** Inspect the brake pads from below the brake caliper.
 - Always inspect both left and right calipers.
2. **Rear** Inspect the brake pads from the rear left of the motorcycle.

If necessary have the pads replaced by your dealer.

Always replace both left and right brake pads at the same time.

Inspecting the Parking Brake (VFR1200XD only)

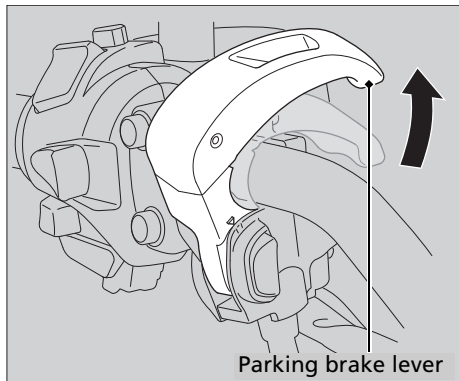

Place your motorcycle on a firm, level surface. Stop the engine and push your motorcycle while applying the parking brake lever to check the efficacy of the parking brake.

If the efficacy of the parking brake become weak, have the brake adjusted by your dealer.

Checking Clutch Fluid (VFR1200X only)

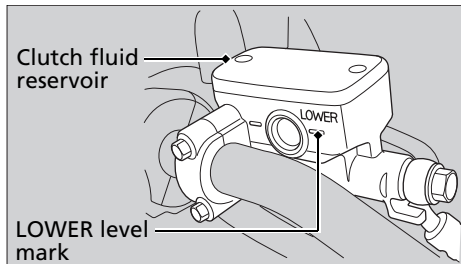

1. Place your motorcycle in an upright position on a firm, level surface.
2. Check that the clutch fluid reservoir cap is horizontal and that the fluid level is above the lower level mark.

If the fluid level is low or if you find fluid leaks, or deterioration or cracks in the hoses and fittings, have the clutch system serviced by your dealer.

Side Stand

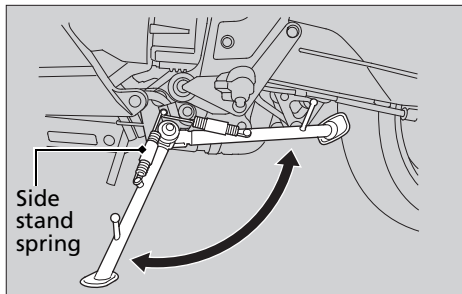

1. Check that the side stand operates smoothly. If the side stand is stiff or squeaky, clean the pivot area and lubricate the pivot bolt with clean grease.
2. Check the spring for damage or loss of tension.
3. **(VFR1200X)**
Sit on the motorcycle, put the transmission in Neutral, and raise the side stand.

(VFR1200XD)

Sit on the motorcycle and raise the side stand.

4. **(VFR1200X)**

Start the engine, pull the clutch lever in, and shift the transmission into gear.

(VFR1200XD)

Start the engine and press the D/S side of N-D switch to switch the transmission into D mode.

5. Lower the side stand all the way. The engine should stop as you lower the side stand. If the engine doesn't stop, have your motorcycle inspected by your dealer.

Changing Final Drive Oil

1. Place your motorcycle on the side stand on a level surface.
2. Open the final gear cover. ➤ P. 64
3. Place a drain pan under the drain bolt.
4. Remove the oil fill hole cap, drain bolt, and sealing washer to drain the oil.

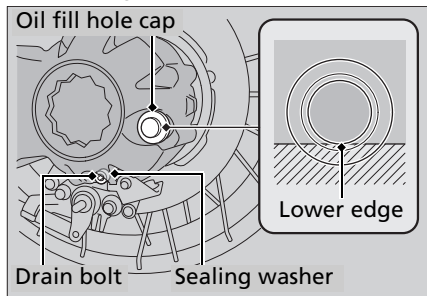

5. Install a new sealing washer onto the drain bolt. Tighten the drain bolt.

Torque: 12 N·m (1.2 kgf·m, 9 lbf·ft).

6. Fill the final gear with the recommended oil. ➤ P. 58

Required oil:

200 cm³ (6.8 US oz, 7.0 Imp oz)

7. Check the oil level. It should be flush with the lower edge of the oil fill hole.
8. Reinstall the oil fill hole cap and tighten.

Torque: 8 N·m (0.8 kgf·m, 5.9 lbf·ft).

9. Check that there are no oil leaks.
10. Close the final gear cover.

Checking the Throttle

With the engine off, check that the throttle rotates smoothly from fully closed to fully open in all steering positions and throttle freeplay is correct. If the throttle does not move smoothly, close automatically, or if the cable is damaged, have the motorcycle inspected by your dealer.

Freeplay at the throttle grip flange:

2 to 4 mm (0.08 to 0.16 in).

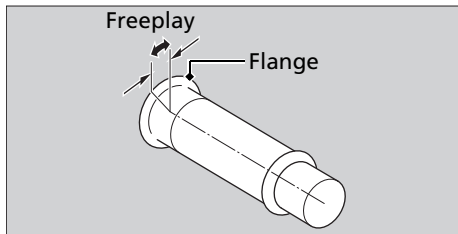

Adjusting the Throttle Freeplay

1. Slide the cable boot.
2. Loosen the lock nut.
3. Turn the adjuster until the freeplay is 2 to 4 mm (0.08 to 0.16 in).
4. Tighten the lock nut, return the cable boot, and inspect the throttle action again.

(VFR1200X)

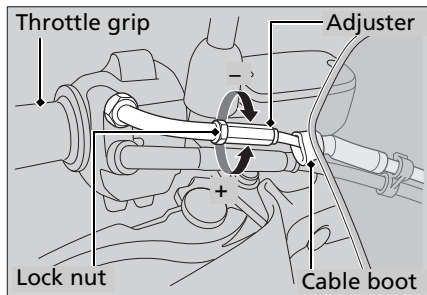

(VFR1200XD)

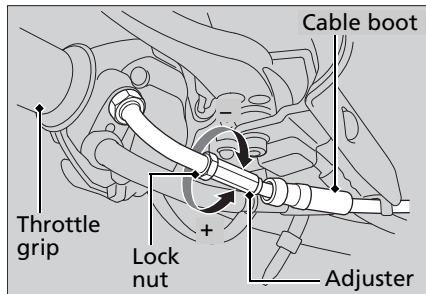

Adjusting the Clutch and Brake Levers

You can adjust the distances between the tip of the clutch lever and handle grip, and between the tip of the brake lever and handle grip.

Adjustment method

Turn the adjuster until the numbers align with the index mark while pushing the lever forward in the desired position.

After adjustment, check that the levers operate correctly before riding.

NOTICE

Do not turn the adjuster beyond its natural limit.

VFR1200XD is not equipped with clutch lever and clutch lever adjuster.

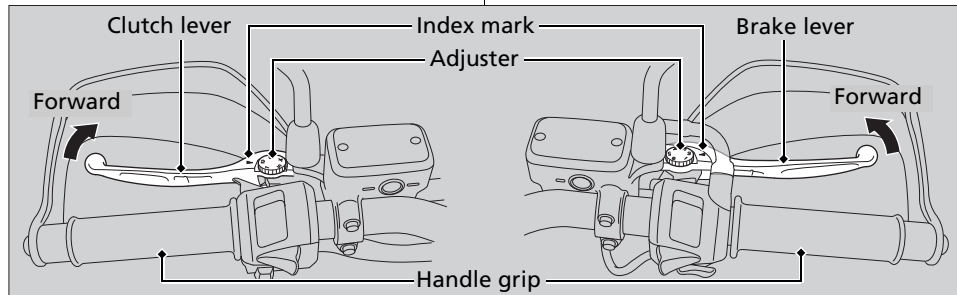

Adjusting the Front Suspension

Spring Preload

You can adjust the spring preload by the adjuster to suit the load or the road surface. Turn clockwise to increase spring preload (hard), or turn counterclockwise to decrease spring preload (soft). The standard position is 5th groove (**VFR1200X**)/4th groove (**VFR1200XD**) from the top aligning with the top surface of the fork bolts.

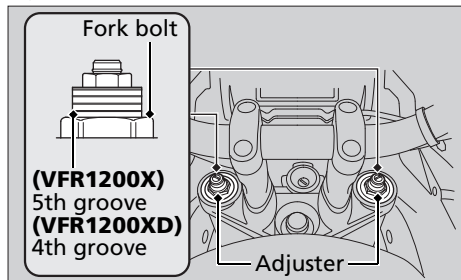

Rebound Damping

You can adjust the rebound damping by the adjuster to suit the load or the road surface. Turn clockwise to increase rebound damping (hard), or turn counterclockwise to decrease rebound damping (soft). The standard position is 7 clicks (**VFR1200X**)/6 clicks (**VFR1200XD**) from the maximum setting.

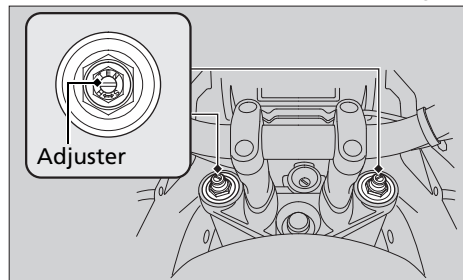

NOTICE

Do not turn the adjuster beyond its natural limits.
Adjust both left and right forks to the same spring preload and rebound damping.

Adjusting the Rear Suspension

Spring Preload

You can adjust the spring preload by the adjuster knob to suit the load or the road surface. Turn clockwise to increase spring preload (hard), or turn counterclockwise to decrease spring preload (soft). The standard position is 7 clicks (**VFR1200X**)/9 clicks (**VFR1200XD**) from the minimum setting.

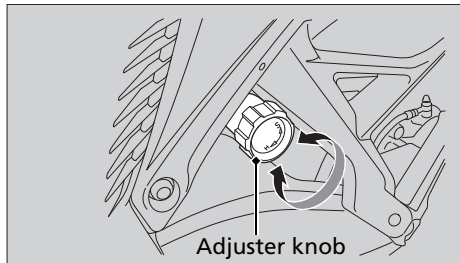

Rebound Damping

You can adjust the rebound damping by the adjuster to suit the load or the road surface. Turn clockwise to increase rebound damping (hard), or turn counterclockwise to decrease rebound damping (soft). The standard position is 1 $\frac{3}{8}$ turns (**VFR1200X**)/ $\frac{7}{8}$ turns (**VFR1200XD**) from the maximum setting.

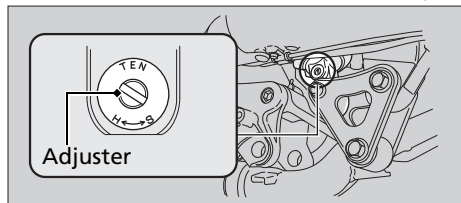

NOTICE

Do not turn the adjuster beyond its natural limits.

NOTICE

The rear shock absorber damper unit contains high pressure nitrogen gas. Do not attempt to disassemble, service, or improperly dispose of the damper. See your dealer.

Adjusting the Headlight Aim

You can adjust vertical aim of the headlight for proper alignment. Turn the knob in or out as necessary.

Obey local laws and regulations.

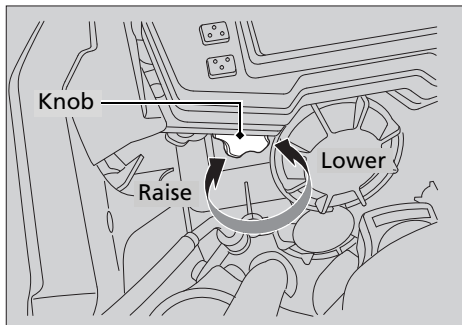

Adjusting the Brakelight Switch

Check the operation of the brakelight switch. Turn the adjusting nut in the direction A if the switch operates too late, or turn the nut in the direction B if the switch operates too soon.

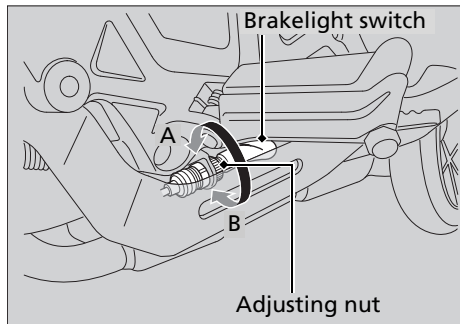

Adjusting the Windscreen Height

You can adjust the windscreen height 2 positions.

1. Remove the windscreen by removing the screws and the washers.

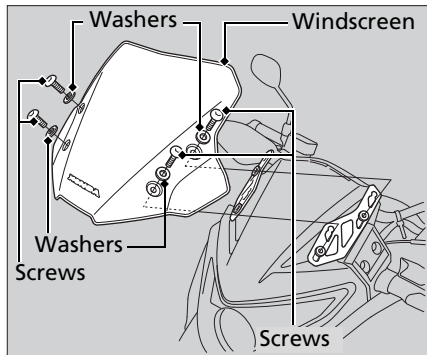

2. Remove the nuts.

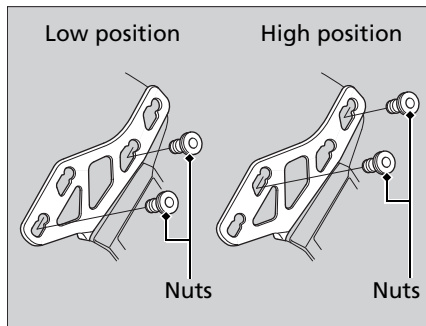

3. Set the all nuts to the low position holes or high position holes.
4. Install the windscreen.
5. Install and tighten the screws and washers.

Troubleshooting

Engine Will Not Start (HISS indicator stays on)	P. 91
Overheating (High coolant temperature indicator is on).....	P. 92
Warning Indicators On or Flashing	P. 93
Low Oil Pressure Indicator.....	P. 93
PGM-FI (Programmed Fuel Injection)	
Malfunction Indicator Lamp (MIL)	P. 93
ABS (Anti-lock Brake System) Indicator	P. 94
TCS (Traction Control System) Indicator	P. 95
Other Warning Indications	P. 96

If the “-” Indicator is Blinking in the Gear Position Window While Riding.....	P. 97
Tyre Puncture	P. 98
Electrical Trouble	P. 105
Battery Goes Dead	P. 105
Burned-out Light Bulb	P. 105
Blown Fuse	P. 109

Engine Will Not Start (HISS indicator stays on)

Starter Motor Operates But Engine Does Not Start

Check the following items:

- Check the correct engine starting sequence ➤ P. 38
- Check that there is petrol in the fuel tank
- Check if the PGM-FI malfunction indicator lamp (MIL) is on
 - ▶ If the indicator light is on, contact your dealer as soon as possible.
- Check if the HISS indicator stays on
 - ▶ Turn the ignition switch to the OFF position and remove the key. Reinsert the key and turn the ignition switch to the ON position. If the indicator still stays on, check the following:

Check if there is no another HISS key (including spare key) close to the ignition switch.

Check if there are no any metallic seals or stickers on the key.

If the HISS indicator still stays on, have your motorcycle inspected by your dealer.

Starter Motor Does Not Operate

Check the following items:

- Make sure engine stop switch is RUN  position ➤ P. 34, 37
- Check for a blown fuse ➤ P. 109
- Check for a loose battery connection or battery terminal corrosion ➤ P. 67
- Check the condition of the battery ➤ P. 105

If the problem continues, have your motorcycle inspected by your dealer.

Overheating (High coolant temperature indicator is on)

The engine is overheating when the following occurs:

- High coolant temperature indicator comes on
- Acceleration becomes sluggish
- If this occurs, pull safely to the side of the road and perform the following procedure. Extended fast idling may cause the high coolant temperature indicator comes on.

NOTICE

Continuing to ride with an overheated engine can cause serious damage to the engine.

1. Stop the engine using the ignition switch, and then turn the ignition switch to the ON position.

2. Check that the radiator fan is operating, and then turn the ignition switch to the OFF position.

If the fan is not operating:

Suspect a fault. Do not start the engine. Transport your motorcycle to your dealer.

If the fan is operating:

Allow the engine to cool with the ignition switch in the OFF position.

3. After the engine has cooled, inspect the radiator hose and check if there is a leak.

➔ P. 74

If there is a leak:

Do not start the engine. Transport your motorcycle to your dealer.

4. Check the coolant level in the reserve tank, and add coolant as necessary.

➔ P. 74

5. If 1–4 check normal, you may continue riding, but closely monitor the high coolant temperature indicator.

Low Oil Pressure Indicator

If the low oil pressure indicator comes on, pull safely to the side of the road and stop the engine.

NOTICE

Continuing to ride with low oil pressure can cause serious damage to the engine.

1. Check the engine oil level, and add oil as necessary. ➤ P. 68
2. Start the engine.
 - ▶ Only continue riding if the low oil pressure indicator goes off.

Rapid acceleration may momentarily cause the low oil pressure indicator to come on, especially if the oil is at or near the low level. If the low oil pressure indicator stays on when the oil level is at the proper level, stop the engine and contact your dealer.

If the engine oil level goes down rapidly, your motorcycle may have a leak or another serious problem. Have your motorcycle inspected by your dealer.

PGM-FI (Programmed Fuel Injection) Malfunction Indicator Lamp (MIL)

If the indicator comes on while riding, you may have a serious problem with the PGM-FI system. Reduce speed and have your motorcycle inspected by your dealer as soon as possible.

ABS (Anti-lock Brake System) Indicator

If the indicator operates in one of the following ways, you may have a serious problem with the brake system. Reduce your speed and have your motorcycle inspected by your dealer as soon as possible.

- Indicator comes on or starts flashing while riding.
- Indicator does not come on when the ignition switch is in the ON position.
- Indicator does not go off at speeds above 10 km/h (6 mph).

If the ABS indicator stays on, your brakes will continue to work as a conventional system, but without the anti-locking function.

The ABS indicator may flash if you turn the rear wheel while your motorcycle is lifted off the ground. In this case, turn the ignition switch off and then on again. The ABS indicator will go off after your speed reaches 10 km/h (6 mph).

TCS (Traction Control System) Indicator

If the indicator operates in one of the following ways, you may have a serious problem with the TCS (Traction Control System). Reduce your speed and have your motorcycle inspected by your dealer as soon as possible.

- Indicator comes on while riding.
- Indicator does not come on when the ignition switch is turned on.
- Indicator does not go off at speeds above 10 km/h (6 mph).

Even when the TCS indicator is on, your motorcycle will have normal riding ability without TCS function.

- When the indicator comes on while the TCS is in operation, you will have to close the throttle grip completely to regain normal riding ability.

The TCS indicator may come on if you turn the rear wheel while your motorcycle is lifted off the ground. In this case, turn the ignition switch off and on again. The TCS indicator will go off after your speed reaches 10 km/h (6 mph).

Fuel Gauge Failure Indication

If the fuel system has an error, all segments will blink as shown in the illustration.

If this occurs, see your dealer as soon as possible.

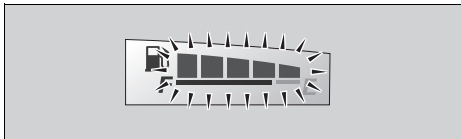

If the “-” Indicator is Blinking in the Gear Position Window While Riding

(VFR1200XD only)

If the “-” indicator is blinking while riding, you may have a serious problem with the Dual Clutch Transmission system.

Park your motorcycle in a safe place and have your motorcycle inspected by dealer immediately.

There is possibility for you to ride yourself to go to dealer if you try to follow the procedure below.

1. Turn the ignition switch to OFF.
2. Turn the ignition switch to ON and start the engine.

If you cannot start the engine:

Turn the ignition switch to OFF and move the motorcycle back and forth slightly (to disengage the gears).

Turn the ignition switch to ON again and start the engine.

If you still cannot start the engine:

Start the engine while applying the brake lever or pressing the brake pedal.

If you can shift from N to D mode:

Start the engine while applying the brake lever or pressing the brake pedal.

If you can't shift from N to D mode and the “-” indicator is blinking:

Damage is preventing you from riding. Have your motorcycle inspected by your dealer immediately.

Tyre Puncture

Repairing a puncture or removing a wheel requires special tools and technical expertise. We recommend you have this type of service performed by your dealer. After an emergency repair, always have the tyre inspected/replaced by your dealer.

Emergency Repair Using a Tyre Repair Kit

If your tyre has a minor puncture, you can make an emergency repair using a tubeless tyre repair kit.

Follow the instructions provided with the emergency tyre repair kit.

Riding your motorcycle with a temporary tyre repair is very risky. Do not exceed 50 km/h (30 mph). Have the tyre replaced by your dealer as soon as possible.

WARNING

Riding your motorcycle with a temporary tyre repair can be risky. If the temporary repair fails, you can crash and be seriously injured or killed.

If you must ride with a temporary tyre repair, ride slowly and carefully and do not exceed 50 km/h (30 mph) until the tyre is replaced.

Removing Wheels

Follow these procedures if you need to remove a wheel in order to repair a puncture.

When removing and installing the wheel, be careful not to damage the wheel speed sensor and pulser ring.

Front Wheel

Removal

1. Park on a firm, level surface.
2. Cover both sides of the front wheel and brake caliper with protective tape or cloth.
3. On the left side, remove the mounting bolts and remove the brake caliper.
4. On the right side, remove the mounting bolts and remove the brake caliper.
 - Support the brake caliper assembly so that it doesn't hang from the brake hose. Do not twist the brake hose.
 - Avoid getting grease, oil, or dirt on the disc or pad surfaces.
 - Do not pull the brake lever or push the brake pedal while the brake caliper is removed.
 - Take care to prevent the brake caliper from scratching the wheel during removal.

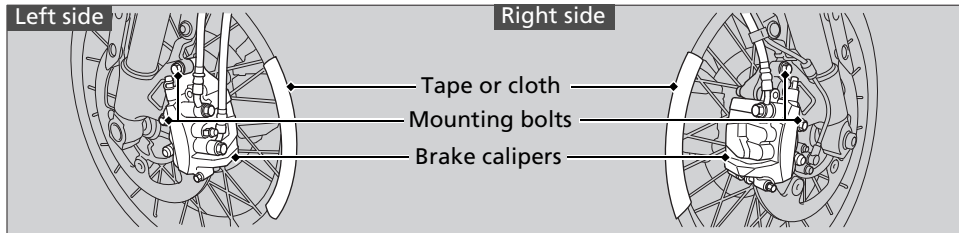

Tyre Puncture ► Removing Wheels

5. Remove the front axle bolt.
6. Loosen the right axle pinch bolts.
7. Support your motorcycle securely and raise the front wheel off the ground using a maintenance stand or a hoist.
8. Loosen the left axle pinch bolts.
9. On the left side, withdraw the front axle shaft, and remove the side collars and wheel.

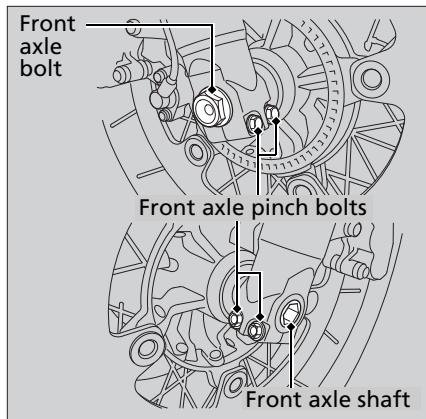

Installation

1. Attach the side collars to the wheel.
2. On the left side, place the wheel between the fork legs and insert the lightly greased front axle shaft to the end, through the left fork leg and wheel hub.
3. Align the end of the front axle shaft with the surface of the fork leg.

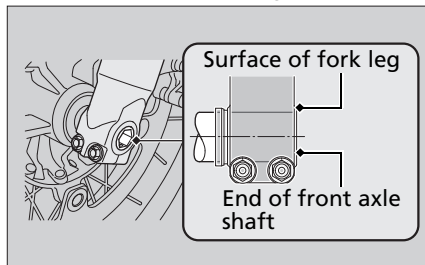

4. Tighten the left axle pinch bolts to hold the axle.
5. Tighten the axle bolt.

Torque: 59 N·m (6.0 kgf·m, 44 lbf·ft).

6. Loosen the left axle pinch bolts.
7. Tighten the right axle pinch bolts.

Torque: 22 N·m (2.2 kgf·m, 16 lbf·ft).

8. Install the right brake caliper and tighten the mounting bolts.

Torque: 31 N·m (3.2 kgf·m, 23 lbf·ft).

Tyre Puncture ► Removing Wheels

9. Install the left brake caliper and tighten the mounting bolts.

Torque: 31 N·m (3.2 kgf·m, 23 lbf·ft).

- Take care to prevent the brake caliper from scratching the wheel during installation.
- Use new mounting bolts when installing the brake caliper.

NOTICE

When installing the brake caliper into position on the fork leg, carefully fit the brake disc between the pads to avoid scratching them.

10. Lower the front wheel on the ground.
11. Apply the brake lever and brake pedal several times. Then, pump the fork several times.

12. Retighten the left axle pinch bolts.

Torque: 22 N·m (2.2 kgf·m, 16 lbf·ft).

13. Raise the front wheel off the ground again, and check that the wheel rotates freely after you release the brake.
14. Remove the protective tape or cloth.

If a torque wrench was not used for installation, see your dealer as soon as possible to verify proper assembly. Improper assembly may lead to loss of braking capacity.

I Rear Wheel

Removal

1. Support your motorcycle securely and raise the rear wheel off the ground using a maintenance stand or a hoist.
2. Loosen the muffler band bolt.
3. Remove the muffler stay bolt, nut and washers.

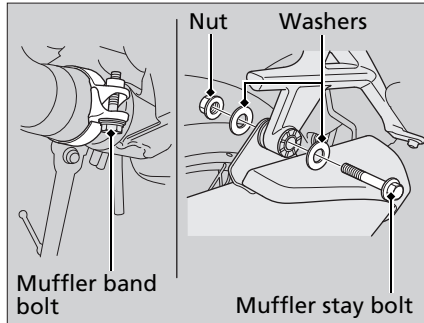

4. Move the muffler outward.
5. Remove the rear wheel nuts, and remove the rear wheel.

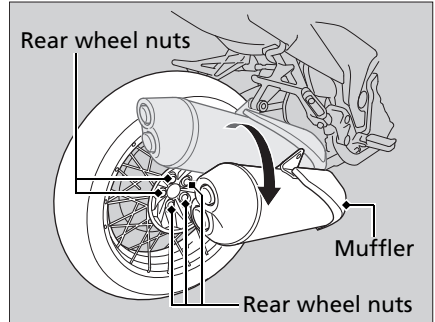

Installation

1. To install the rear wheel, reverse the removal procedure.
2. Install the rear wheel and tighten the rear wheel nuts equally.

Torque: 108 N·m (11 kgf·m, 80 lbf·ft).

3. Tighten the muffler band bolt.

Torque: 17 N·m (1.7 kgf·m, 13 lbf·ft).

4. Check that the wheel rotates freely.

If a torque wrench was not used for installation, see your dealer as soon as possible to verify proper assembly. Improper assembly may lead to loss of braking capacity.

Battery Goes Dead

Charge the battery using a motorcycle battery charger.

Remove the battery from the motorcycle while charging.

Do not use an automobile-type battery charger, as these can overheat a motorcycle battery and cause permanent damage.

If the battery does not recover after recharging, contact your dealer.

NOTICE

Jump starting using an automobile battery is not recommended, as this can damage your motorcycle's electrical system.

Burned-out Light Bulb

Follow the procedure below to replace a burned-out light bulb.

Turn the ignition switch to the OFF or LOCK position.

Allow the bulb to cool before replacing it.

Do not use bulbs other than those specified.

Check the replacement bulb for correct operation before riding.

For the light bulb wattage, see "Specifications." ➤ P. 127

Headlight Bulb

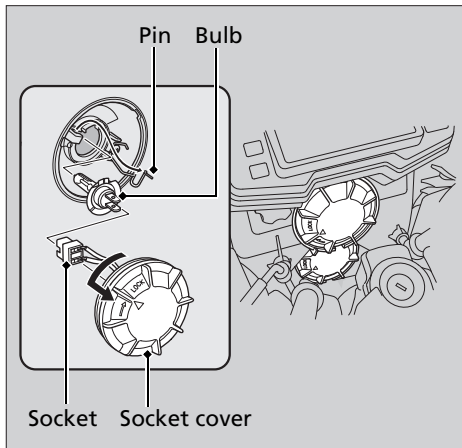

1. Remove the socket cover by turning it counterclockwise.
2. Pull the socket off the bulb without turning it.

3. Press the pin down and pull out the bulb without turning it.
4. Install a new bulb and parts in the reverse order of removal.

Do not touch the glass surface with your fingers. If you touch the bulb with your bare hands, clean it with a cloth moistened with alcohol.

Position Light Bulb

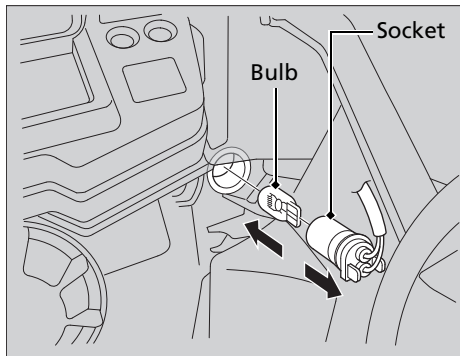

1. Pull the socket and remove it.
2. Pull out the bulb without turning.
3. Install a new bulb and parts in the reverse order of removal.

Brake/Tail Light

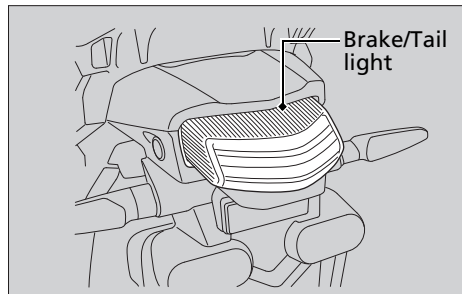

The brake and tail light uses several LEDs. If there is a LED which is not turned on, see your dealer for this service.

Front/Rear Turn Signal Light

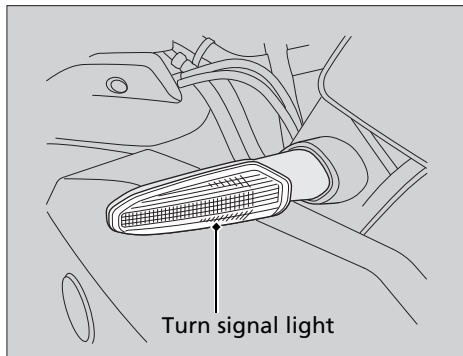

Front and rear turn signal light uses several LEDs.
If there is a LED which is not turned on, see your dealer for this service.

License Plate Light

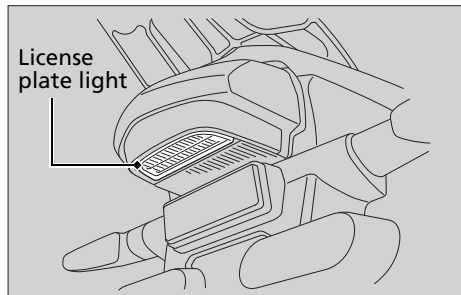

License plate light uses several LEDs.
If there is a LED which is not turned on, see your dealer for this service.

Blown Fuse

Before handling fuses, see “Inspecting and Replacing Fuses.” ► P. 56

■ Fuse Box Fuses

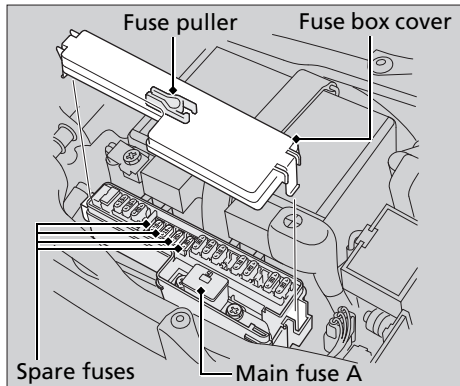

1. Remove the seat. ► P. 63
2. Remove the fuse box cover.
3. Pull the main fuse A and other fuses out one by one with the fuse puller in the fuse box cover and check for a blown fuse. Always replace a blown fuse with a spare of the same rating.
4. Reinstall the fuse box cover.
5. Reinstall the seat.

■ Fuse Holder Fuses

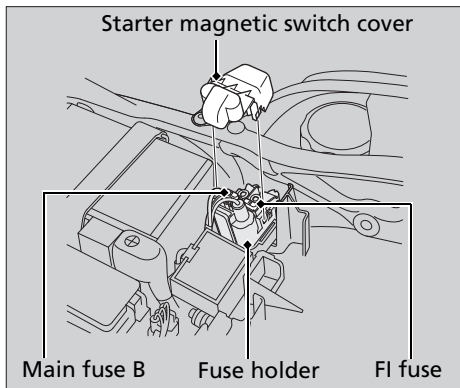

1. Remove the seat. ► P. 63
2. Remove the starter magnetic switch cover.

3. Pull the main fuse B and other fuse out one by one with the fuse puller and check for a blown fuse. Always replace a blown fuse with a spare of the same rating.
 - Spare fuses are provided in the fuse box.
 - A fuse puller is provided in the fuse box cover.
4. Reinstall parts in the reverse order of removal.

NOTICE

If a fuse fails repeatedly, you likely have an electrical problem. Have your motorcycle inspected by your dealer.

Information

Keys.....	P. 112
Instruments, Controls, & Other Features...P.	113
Fuels Containing Alcohol (Except Brazil)P.	116
Catalytic Converter	P. 117
Caring for Your Motorcycle.....P.	118
Storing Your Motorcycle	P. 121
Transporting Your Motorcycle	P. 122
You & the Environment.....P.	123
Serial Numbers	P. 124

Keys

Ignition key

The ignition key contains a special coded chip that is recognized by the immobilizer system (HISS) in order to start the engine. Handle the key carefully to prevent damaging the HISS components.

- Do not bend keys or subject them to undue stress.
- Avoid prolonged exposure to sunlight or high temperatures.
- Do not grind, drill or in any way alter their shape.
- Do not expose to strong magnetic objects.

If you lose all keys and the key number plate, the PGM-FI unit/ignition control module must be replaced by your dealer. To avoid this, keep a duplicate key.

If you lose a key, make another duplicate key immediately.

To make a duplicate key and register it with your HISS system, take the spare key, the key number plate, and the motorcycle to your dealer.

A metal key holder may cause damage to the area surrounding the ignition switch.

Instruments, Controls, & Other Features

Ignition Switch

The headlight is always on when the ignition switch is on. Leaving the ignition switch on with the engine stopped will drain the battery. Do not turn the key while riding.

Engine Stop Switch

Do not use the engine stop switch except in an emergency. Doing so when riding will cause the engine to suddenly turn off, making riding unsafe.

If you stop the engine using the engine stop switch, turn the ignition switch off. Failing to do so will drain the battery.

Odometer

The display locks 999,999 when the read-out exceeds 999,999.

Tripmeter

The tripmeter A, B returns to 0.0 when the read-out exceeds 99,999.9.

HISS

The Honda Ignition Security System (HISS) immobilizes the engine's ignition system if an improperly-coded key is used to try and start the engine. When the ignition switch is turned off, the HISS immobilizer system is always alert, even if the HISS indicator is not flashing. If the ignition switch is turned on with the engine stop switch in the RUN position, the HISS indicator turns on and goes off after a few seconds to indicate it is OK to start the engine.

❏ HISS Indicator Does Not Turn OFF P. 91

The HISS indicator starts flashing every 2 seconds for 24 hours after the ignition switch is turned off. To prevent or to restore the HISS indicator flashing:

Instruments, Controls, & Other Features

1. Turn the ignition switch on while pressing and holding the **TOTAL/TRIP** button (➔ P. 20, 30).
 - ▶ The HISS indicator flashes once.
2. Turn the ignition switch off.

EC Directive

This immobilizer system complies with R & TTE (Radio and Telecommunications Terminal Equipment and the mutual recognition of their conformity) Directive.



The declaration of conformity to R & TTE Directive is provided to the owner at the time of purchase. The declaration of conformity should be kept at a safe place. When the declaration of conformity is lost or is not provided, contact your dealer.

South Africa only



Singapore only



Brazil only



Agência Nacional de Telecomunicações

0542-08-3333



(01) 07898921465038

This equipment operates on a secondary basis and, consequently, must accept harmful interference, including from stations of the same kind, and may not cause harmful interference to systems operating on a primary basis.

Document Bag

The owner's manual, registration, and insurance information can be stored in the plastic document bag on the underside of the seat. ➤ P. 47

Ignition Cut-off System

A banking (lean angle) sensor automatically stops the engine and fuel pump if the motorcycle falls over. To reset the sensor, you must turn the ignition switch to OFF and back to the ON position before the engine can be restarted.

Fuels Containing Alcohol (Except Brazil)

Some conventional fuels blended with alcohol are available in some locales to help reduce emissions to meet clean air standards. If you plan to use blended fuel, check that it is unleaded and meets the minimum octane rating requirement.

The following fuel blends can be used in your motorcycle:

- Petrol containing ethanol (ethyl alcohol) 10% by volume.
 - ▶ Petrol containing ethanol may be marketed under the name Gasohol.

The use of petrol containing more than 10% ethanol may:

- Damage the painting of the fuel tank.
- Damage the rubber tubes of the fuel line.
- Cause corrosion of the fuel tank.
- Cause poor drivability.

NOTICE

Use of blended fuels containing higher than approved percentages can damage metal, rubber, plastic parts of your fuel system.

If you notice any undesirable operating symptoms or performance problems, try a different brand of petrol.

Catalytic Converter

This motorcycle is equipped with a three-way catalytic converter. The catalytic converter contains precious metals that serve as catalysts in high temperature chemical reactions that convert hydrocarbons (HC), carbon monoxide (CO), and oxides of nitrogen (NOx) in the exhaust gasses into safe compounds.

A defective catalytic converter contributes to air pollution and can impair your engine's performance. A replacement unit must be an original Honda part or equivalent.

Follow these guidelines to protect your motorcycle's catalytic converter.

- Always use unleaded petrol. Leaded petrol will damage the catalytic converter.
- Keep the engine in good running condition.
- Have your motorcycle serviced if your engine is misfiring, backfiring, stalling, or otherwise not running properly, stop riding and turn off the engine.

Caring for Your Motorcycle

Frequent cleaning and polishing is important to ensure the long life of your Honda. A clean motorcycle makes it easier to spot potential problems.

In particular, seawater and salts used to prevent ice on roads promote the formation of corrosion. Always wash your motorcycle thoroughly after riding on coastal or treated roads.

Washing

Allow the engine, muffler, brakes, and other high-temperature parts to cool before washing.

1. Rinse your motorcycle thoroughly using a garden hose to remove loose dirt.
2. If necessary, use a sponge or a soft towel with mild cleaner to remove road grime.
 - ▶ Clean the windscreen, headlight lens, panels, and other plastic components with extra care to avoid scratching them. Avoid

directing water into the air cleaner, muffler, and electrical parts.

3. Thoroughly rinse your motorcycle with plenty of clean water and dry with a soft, clean cloth.
4. After the motorcycle dries, lubricate any moving parts.
 - ▶ Make sure that no lubricant spills onto the brakes or tyres. Brake discs or pads contaminated with oil suffer greatly reduced braking effectiveness and can lead to a crash.
5. Apply a coat of wax to prevent corrosion.
 - ▶ Avoid products that contain harsh detergents or chemical solvents. These can damage the metal, paint, and plastic on your motorcycle.
 - ▶ Keep the wax clear of the tyres and brakes.
 - ▶ If your motorcycle has any matte painted parts, do not apply a coat of wax to the matte painted surface.

Washing Precautions

Follow these guidelines when washing:

- Do not use high-pressure washers:
 - ▶ High-pressure water cleaners can damage moving parts and electrical parts, rendering them inoperable.
- Do not direct water at the muffler:
 - ▶ Water in the muffler can prevent starting and causes rust in the muffler.
- Dry the brakes:
 - ▶ Water adversely affects braking effectiveness. After washing, apply the brakes intermittently at low speed to help dry them.
- Do not direct water under the seat:
 - ▶ Water in the under seat compartment can damage your documents and other belongings.
- Do not direct water at the air cleaner:
 - ▶ Water in the air cleaner can prevent the engine from starting.
- Do not direct water near the headlight:
 - ▶ Any condensation inside the headlight

should dissipate after a few minutes of running the engine.

- Do not use waxes containing compounds at the matte painted surface:
 - ▶ Using plenty of water, clean the matte painted surface with a soft cloth or sponge. Dry with a soft, clean cloth.
 - ▶ Use neutral detergent to clean matte painted surface.

Aluminium Components

Aluminium will corrode from contact with dirt, mud, or road salt. Clean aluminium parts regularly and follow these guidelines to avoid scratches:

- Do not use stiff brushes, steel wool, or cleaners containing abrasives.
- Avoid riding over or scraping against curbs.

Panels and Windscreen

Follow these guidelines to prevent scratches and blemishes:

- Wash gently using a soft sponge and plenty of water.
- To remove stubborn stains, use diluted detergent and rinse thoroughly with plenty of water.
- Avoid getting petrol, brake fluid, or detergents on the instruments, windscreen, panels, or headlight.

Exhaust Pipe and Muffler

The exhaust pipe and muffler are stainless steel but may become stained by mud or dust.

To remove mud or dust, use a wet sponge and a liquid kitchen abrasive, then rinse well with clean water. Dry with chamois or a soft towel. If necessary, remove heat stains by using a commercially available fine texture compound. Then rinse by the same manner as removing mud or dust.

NOTICE

Even though the exhaust is made of stainless steel, it can become stained. Remove all marks and blemishes as soon as they are noticed.

Storing Your Motorcycle

If you store your motorcycle outdoors, you should consider using a full-body motorcycle cover.

If you won't be riding for an extended period, follow these guidelines:

- Wash your motorcycle and wax all painted surfaces (except matte painted surfaces).
Coat chrome pieces with rust-inhibiting oil.
- Place your motorcycle on a maintenance stand and position a block so that both tyres are off the ground.
- After rain, remove the body cover and allow the motorcycle to dry.
- Remove the battery (➤ P. 67) to prevent discharge.
Charge the battery in a shaded, well-ventilated area.
 - ▶ If you leave the battery in place, disconnect the negative ⊖ terminal to prevent discharge.

After removing your motorcycle from storage, inspect all maintenance items required by the Maintenance Schedule.

Transporting Your Motorcycle

If your motorcycle needs to be transported, it should be carried on a motorcycle trailer or a flatbed truck or trailer that has a loading ramp or lifting platform, and motorcycle tie-down straps. Never try to tow your motorcycle with a wheel or wheels on the ground.

NOTICE

Towing your motorcycle can cause serious damage to the transmission.

You & the Environment

Owning and riding a motorcycle can be enjoyable, but you must do your part to protect the environment.

Choose Sensible Cleaners

Use a biodegradable detergent when you wash your motorcycle. Avoid aerosol spray cleaners that contain chlorofluorocarbons (CFCs) which damage the atmosphere's protective ozone layer.

Recycle Wastes

Put oil and other toxic wastes in approved containers and take them to a recycling centre. Call your local or state office of public works or environmental services to find a recycling centre in your area, and to get instructions on how to dispose of non-recyclable wastes. Do not place used engine oil in the trash, or pour it down a

drain or on the ground. Used oil, petrol, coolant, and cleaning solvents contain poisons that can hurt refuse workers and contaminate drinking water, lakes, rivers, and oceans.

Serial Numbers

The frame and engine serial numbers uniquely identify your motorcycle and are required in order to register your motorcycle. They may also be required when ordering replacement parts. The frame number is stamped on the right side of the steering head.

The engine number is stamped on the side of the crankcase. To check the engine number, remove the right engine heat guard. ➤ P. 65 You should record these numbers and keep them in a safe place.

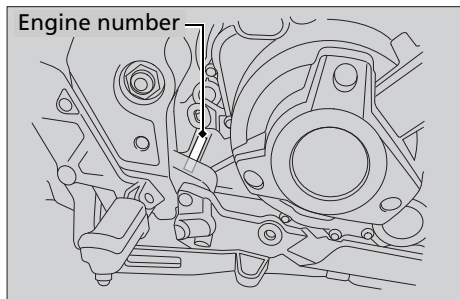
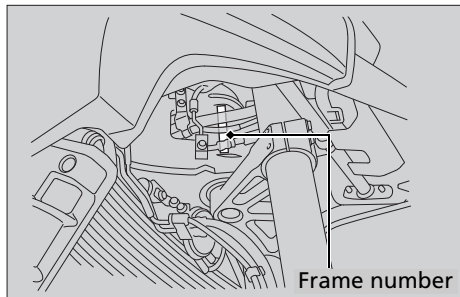

Specifications

■ Main Components

Type	SC70	
Overall length	2,285 mm (90.0 in)	
Overall width	915 mm (36.0 in)	
Overall height	1,335 mm (52.6 in)	
Wheelbase	1,595 mm (62.8 in)	
Minimum ground clearance	180 mm (7.1 in)	
Caster angle	28° 00'	
Trail	107 mm (4.2 in)	
Curb weight	VFR1200X	275 kg (606 lb)
	VFR1200XD	285 kg (628 lb)
Maximum weight capacity*1	194 kg (428 lb)	
Maximum luggage weight*2	18.5 kg (41 lb)	
	Rear carrier	10 kg (22 lb)
Passenger capacity	Rider and 1 passenger	
Minimum turning radius	2.7 m (8.9 ft)	
Displacement	1,237 cm ³ (75.45 cu-in)	
Bore x stroke	81.0 x 60.0 mm (3.19 x 2.36 in)	

*1 Including rider, passenger, all luggage, and accessories

*2 Includes the weight of the luggage and added accessories

Compression ratio	12.0:1	
Fuel	Unleaded petrol	
	Recommended: 95 RON or higher	
Tank capacity	21.5 litres (5.68 US gal, 4.73 Imp gal)	
Battery	YTZ14S	
	12V-11.2Ah (10 HR) / 11.8Ah (20HR)	
Gear ratios	VFR1200X	
	1st	2.600
	2nd	1.600
	3rd	1.260
	4th	1.076
	5th	0.961
	6th	0.897
	VFR1200XD	
	1st	2.250
	2nd	1.700
	3rd	1.304
	4th	1.107
5th	0.967	
6th	0.886	
Reduction ratios (primary / secondary / final)	VFR1200X 1.738 / 1.060 / 2.545	
	VFR1200XD 1.738 / 1.063 / 2.545	

Specifications

■ Service Data

Tyre size	Front	110/80R19M/C 59V
	Rear	150/70R17M/C 69V
Tyre type	Radial, tubeless	
Recommended Tyres	Front	PIRELLI SCORPION TRAIL E BRIDGESTONE BW-501 RADIAL F
	Rear	PIRELLI SCORPION TRAIL E BRIDGESTONE BW-502 RADIAL F
Tyre air pressure	Front	250 kPa (2.50 kgf/cm ² , 36 psi)
	Rear	290 kPa (2.90 kgf/cm ² , 42 psi)
Minimum tread depth	Front	1.5 mm (0.06 in)
	Rear	2.0 mm (0.08 in)
Spark plugs	(standard)	IMR8E-9HES (NGK) or VUH24ES (DENSO)
Spark plug gap	(non-adjustable)	0.80 to 0.90 mm (0.031 to 0.035 in)
Idle speed	1,150 ± 100 rpm	
Recommended engine oil	Honda 4-stroke motorcycle oil API Service Classification SG or higher, excluding oils marked as "Energy Conserving," SAE 10W-30, JASO T 903 standard MA	

VFR1200X

After draining 3.1 litres (3.3 US qt,
2.7 Imp qt)

After draining &
engine oil filter
change 3.3 litres (3.5 US qt,
2.9 Imp qt)

After disassembly 4.0 litres (4.2 US qt,
3.5 Imp qt)

VFR1200XD

After draining 3.6 litres (3.8 US qt,
3.2 Imp qt)

After draining &
engine oil filter
change 3.9 litres (4.1 US qt,
3.4 Imp qt)

After draining,
engine & clutch oil
filter change 4.0 litres (4.2 US qt,
3.5 Imp qt)

After disassembly 4.9 litres (5.2 US qt,
4.3 Imp qt)

Recommended
final drive oil Hypoid gear oil SAE 80

After draining 200 cm³ (6.8 US oz,
7.0 Imp oz)

After disassembly 220 cm³ (7.4 US oz,
7.7 Imp oz)

Recommended brake (clutch) fluid	Honda DOT 4 Brake Fluid
	VFR1200X
Cooling system capacity	3.56 litres (3.76 US qt, 3.13 Imp qt)
	VFR1200XD
	3.70 litres (3.91 US qt, 3.26 Imp qt)
Recommended coolant	Pro Honda HP Coolant

■ Bulbs

Headlight	12V-55W × 2
Brake/Tail light	LED
Front turn signal lights	LED
Rear turn signal lights	LED
Position light	12V-5W × 2
License plate light	LED

■ Fuses

Main fuse	A	50A
	B	30A
Other fuses	30A, 20A, 15A, 10A	

■ Torque Specifications

Engine oil drain bolt	29 N·m (3.0 kgf·m, 21 lbf·ft)
Oil filter	26 N·m (2.7 kgf·m, 19 lbf·ft)
Final drive oil fill hole cap	8 N·m (0.8 kgf·m, 5.9 lbf·ft)
Final drive oil drain bolt	12 N·m (1.2 kgf·m, 9 lbf·ft)
Front wheel axle bolt	59 N·m (6.0 kgf·m, 44 lbf·ft)
Front wheel brake caliper mounting bolts	31 N·m (3.2 kgf·m, 23 lbf·ft)
Front wheel axle pinch bolts	22 N·m (2.2 kgf·m, 16 lbf·ft)
Rear wheel nuts	108 N·m (11 kgf·m, 80 lbf·ft)
Muffler band bolt	17 N·m (1.7 kgf·m, 13 lbf·ft)

A

ABS (Anti-lock Brake System)	
Indicator	32, 94
Accessories	16
AT Mode	31, 42, 43, 44
AT/MT Switch.....	37

B

Battery	55, 67
Brakelight Switch	88

Brakes

Fluid	58, 76
Pad Wear	77
Parking Brake	78

Braking.....	12
--------------	----

Bulb

Brake/Tail Light.....	107
Front Turn Signal	108
Headlight	106
License Plate.....	108
Position Light.....	107
Rear Turn Signal	108

C

Caring for Your Motorcycle	118
Clutch	
Fluid	58, 79
Colour label.....	54
Combined ABS	13
Coolant.....	58, 74

D

D mode.....	31, 42, 43, 44
Digital Clock Adjustment	24

E

Electrical Trouble.....	105
Engine	
Number	124
Oil	57, 68
Oil Filter	69, 72
Overheats	92
Starting.....	38
Stop Switch	34, 37, 38, 39, 113
Stopping.....	113
Environment	123

Equipment	
Owner's Manual	115
Tool Kit	62
F	
Final Drive Oil.....	81
Flooded Engine	38
Frame Number	124
Fuel	
Gauge.....	21
Remaining.....	21
Fuels Containing Alcohol	116
Fuses	56, 109
G	
Gasohol.....	116
Gear position indicator.....	31
H	
Hazard Switch	34, 36
Headlight Aim.....	88
Headlight Dimmer Switch	34, 36
Helmet Holder.....	47
High Beam Indicator	33
High Coolant Temperature	
Indicator	32, 92
HISS Indicator	33, 91
Horn Button.....	34, 37
I	
Ignition Cut-off System	
Banking Sensor.....	115
Side Stand	80
Ignition key.....	112
Ignition Switch	35, 37, 38, 39
Image Labels.....	6
Indicators	32
Instruments.....	20
L	
Labels	6
Load Limits.....	17
Loading Guidelines	17
Low Oil Pressure Indicator	32, 93

M	
Maintenance	
Fundamentals.....	53
Importance.....	49
Safety.....	49
Schedule	50
Maximum Weight Limit	17
Modifications	16
N	
Neutral Indicator	33
O	
Odometer	113
Oil	
Engine.....	57, 68
Overheating	92
P	
Parking	14
Parking brake Indicator	32
Parts Location	18
Passing light control switch	34, 36
Petrol	46, 116
PGM-FI (Programmed Fuel Injection)	
malfunction indicator lamp (MIL).....	32, 93
Protective Apparel	11
R	
Recommended	
Coolant	58
Final Drive Oil.....	58
Fuel	46
Oil	57
Refuelling	46
Removal	
Clip.....	64
Final Gear Cover	64
Right Engine Heat Guard	65
Right Under Cowl	65
Repair Kit	98
Riding Precautions	12
S	
S mode	31, 42, 44
Safety Precautions	11

Serial Numbers.....	124
Shifting Gears.....	40
Side Stand.....	80
Side Stand Ignition Cut-off System.....	80
Specifications	125
Speedometer.....	21
Start Button.....	34, 37, 38, 39
Starting the Engine.....	38
Steering Lock.....	35
Stopping Engine	113
Storage	
Equipment.....	47
Owner's Manual	115
Storing Your Motorcycle	121
Switches.....	34
T	
Tachometer	20, 30
TCS (Traction Control System).....	15
TCS (Traction Control System)	
Indicator	33, 95
TCS (Traction Control System) OFF	
Indicator	33

TCS (Traction Control System) OFF	
Switch.....	34, 37
Throttle.....	82
Tool kit.....	62
Transporting Your Motorcycle	122
Tripmeter	113
Troubleshooting.....	90
Turn signal indicators.....	33
Tyres	
Air Pressure	59
Puncture.....	98
Replacing	59, 98
W	
Warning Indicators On.....	93
Washing Your Motorcycle	118
Weight Limit.....	17
Wheels	
Front removal	99
Rear removal	103
Windscreen	89