



Dolphin™ 75e

powered by Android 4.4

User's Guide

Disclaimer

Honeywell International Inc. ("HII") reserves the right to make changes in specifications and other information contained in this document without prior notice, and the reader should in all cases consult HII to determine whether any such changes have been made. The information in this publication does not represent a commitment on the part of HII.

HII shall not be liable for technical or editorial errors or omissions contained herein; nor for incidental or consequential damages resulting from the furnishing, performance, or use of this material. HII disclaims any and all responsibility and liability for the selection and use of software and/or hardware to achieve intended results.

This document contains proprietary information that is protected by copyright. All rights are reserved. No part of this document may be photocopied, reproduced, or translated into another language without the prior written consent of HII.

Web Address: www.honeywellaidc.com

Trademarks

Android, Google, Google Play and other marks are trademarks of Google Inc.

The Bluetooth trademarks are owned by Bluetooth SIG, Inc., U.S.A. and licensed to Honeywell.

Other product names mentioned in this manual may be trademarks or registered trademarks of their respective companies and are the property of their respective owners.

Patents

For patent information, please refer to www.hsmpats.com.

©2015 Honeywell International Inc. All rights reserved.

Table of Contents

Chapter 1 - Dolphin 75e Terminal Agency Information

Label Locations	1-1
Model Number and Serial Number	1-1
Approvals by Country	1-1
FCC Requirements	1-2
Dolphin RF Terminal—802.11a/b/g/n/ac, Bluetooth, and/or GSM	1-2
Canadian Compliance, Conformité à la réglementation canadienne	1-2
RF Exposure Information (SAR)	1-2
R&TTE Compliance Statement—802.11a/b/g/ac, Bluetooth	1-3
Honeywell Scanning & Mobility Product Environmental Information.....	1-3
USA, Canada NRTL Safety	1-3
LED Safety	1-3
Pacemakers, Hearing Aids and Other Electrically Powered Devices	1-3
Microwaves	1-4

Chapter 2 - Getting Started

Out of the Box	2-1
Memory Card Specifications	2-1
Initial Setup for Dolphin 75e Terminal	2-1
Install the Battery	2-1
Charge the Battery	2-2
Power On the Terminal	2-4
Unlock the Screen	2-4
Customize the Home Screen and Access Apps	2-5
Status Bar	2-5
Notification Panel	2-6
Common Status and Notification Icons	2-6
Search Bar	2-7
Personalize the Home Screen Panels and Favorites Tray	2-7
Apps and Widgets	2-8
Navigation/Function Buttons	2-8
Hotkeys	2-9
Virtual Keyboard	2-9
Using the Virtual Keyboard	2-9
Turning Power On/Off	2-9
Suspend Mode	2-9
Airplane Mode	2-10
Replacing the Battery	2-10
Resetting the Terminal	2-11
Hard Reset (Cold Boot)	2-11
Soft Reset (Warm Boot)	2-11
Connecting the Terminal to a Computer via a USB Connection	2-12

File Browser Power Tool	2-12
Browser Menu.....	2-12
\Honeywell	2-12
AutoInstall Settings.....	2-13
Additional Resources.....	2-13

Chapter 3 - Hardware Overview

Standard Configurations for the Dolphin 75e	3-1
Peripherals for the Dolphin 75e	3-1
Accessories for the Dolphin 75e.....	3-2
Holsters (Model HOLSTER-2 and 6000-HOLSTER)	3-2
Wrist Lanyard (Model SL-LANYARD-1).....	3-2
Stylus or Stylus and Tether Kit (Model 70e-Stylus or 70e-STYLUSTHR KIT).....	3-2
Stylus Battery Door Kits.....	3-2
Battery (Models 70e-BTSC and 70e-BTEC).....	3-2
Features of the Dolphin 75e	3-3
Front, Bottom, and Right Panels.....	3-3
Back, Top, and Left Panels.....	3-6
Feature Descriptions: Back, Top, and Left Panels	3-7
The I/O Connector	3-8
Battery	3-8
Replacement Battery Specifications	3-8
Charging Options.....	3-9
Charging Time	3-9
Important Charging Guidelines	3-10
Managing Battery Power	3-10
Storing Batteries	3-11
Guidelines for Battery Pack Use and Disposal	3-11
System Resets	3-12
Hardware Maintenance	3-12
Installing a Memory Card.....	3-12
Installation and/or Replacement	3-12

Chapter 4 - Using the Scan Image Engine

Overview.....	4-1
LED Safety	4-1
Image Engine Specifications	4-1
Field of View	4-1
Depth of Field	4-1
Supported Bar Code Symbologies	4-2
Decoding	4-2
Using the Scan Demo to Decode a Bar Code	4-2
Automatic Scanning.....	4-3
Continuous Scanning.....	4-3
Configuring the Scan Demo Application	4-4
Using the ScanTool Power Tool	4-5
Aiming Beam	4-6

Capturing Images	4-6
Taking an Image with the Imaging Demo	4-6
Using the IQ Image Demo to decode intelligent bar codes and capture images	4-7
Using the Signature Demo.....	4-8
Uploading Images.....	4-8

Chapter 5 - Using the Color Camera

Overview.....	5-1
Opening the Camera app and Adjusting the Settings	5-1
Adjusting the Camera/Video Settings.....	5-1
Taking a Picture.....	5-1
Taking a Panoramic Picture	5-2
Uploading Pictures and Videos	5-2

Chapter 6 - Settings

Overview.....	6-1
Wireless & Network Settings	6-1
Device Settings.....	6-1
Sound Settings	6-1
Display Settings.....	6-1
Honeywell Smart Sensors Settings	6-2
Storage Settings	6-2
Battery Settings	6-2
Apps Settings.....	6-2
Managing Apps.....	6-3
Personal Settings	6-4
Accounts & sync	6-4
Security.....	6-4
Language & input	6-6
Language.....	6-6
Spelling Correction	6-6
Personal Dictionary.....	6-6
Keyboard & Input Methods	6-6
Backup & reset	6-7
System.....	6-7
Date & Time.....	6-7
Accessibility	6-7
Developer options.....	6-7
About Phone.....	6-7

Chapter 7 - Communication

Wireless & Networks Settings	7-1
Connecting the Terminal to a Wireless Network	7-1

Wi-Fi Network Connections	7-2
Turning Wi-Fi Networking On or Off	7-2
Connecting to a Wi-Fi Network	7-2
Receiving Network Notifications	7-2
Adding a Wi-Fi Network	7-2
Advanced Wi-Fi Settings and Network Utilities	7-2
Advanced Wi-Fi Menu	7-2
Wi-Fi Radio Settings Power Tool	7-3
Wireless Manager Power Tool	7-3
Airplane Mode	7-4
Virtual Private Networks (VPN)	7-4
Adding a VPN	7-4
Connecting to a VPN	7-4
Disconnecting from a VPN	7-5
Ethernet Communication	7-5

Chapter 8 - Working with Bluetooth and NFC Technology

Bluetooth Technology	8-1
Turning the Bluetooth Radio On or Off	8-1
Pairing and Trusted Devices	8-1
Connecting to Other Bluetooth Devices	8-1
Configuring or Unpairing Bluetooth Devices	8-1
Making the Terminal Discoverable	8-1
Bluetooth Menu Options	8-2
Sharing Pictures and Video	8-2
Near Field Communication (NFC) Technology	8-3
Hardware Requirements	8-3
Security Recommendation	8-3
NFC Settings	8-3
Reading NFC Tags	8-4
Transferring screen content via NFC	8-4
Using the NFC Demos	8-4

Chapter 9 - Dolphin 70e Black HomeBase (Model 70e-HB)

Overview	9-1
Unpacking the HomeBase	9-1
Optional Equipment	9-1
Charging Overview	9-1
Communications	9-1
Convenient Storage	9-1
Capacity	9-2
Dimensions	9-2
Weight	9-2
Parts and Functions	9-3
Front Panel	9-3
Back Panel	9-4
Bottom Panel	9-4

Power	9-4
Connecting Power to the HomeBase	9-5
Charging the Main Battery.....	9-5
Charging a Spare Battery in the Auxiliary Battery Well	9-5
Communication.....	9-6
Requirements	9-6
Setting Up and Connecting the Dolphin Terminal to the HomeBase.....	9-6
Mounting the HomeBase	9-6
Optional DIN Rail Mount.....	9-6
Additional Hardware	9-6
Installing the DIN Rail	9-7

Chapter 10 - Dolphin 70e Black eBase (Model 70e-EHB)

Overview.....	10-1
Unpacking the eBase	10-1
Optional Equipment	10-1
Charging Overview	10-1
Convenient Storage.....	10-1
Capacity.....	10-2
Dimensions.....	10-2
Weight	10-2
Parts and Functions.....	10-3
Front Panel	10-3
Back Panel	10-4
Bottom Panel.....	10-5
Power	10-5
Connecting Power to the eBase	10-5
Charging the Main Battery.....	10-5
To Power a Terminal and Charge its Main Battery.....	10-5
Charging a Spare Battery in the Auxiliary Battery Well	10-6
Communication.....	10-6
Establishing Ethernet Communication.....	10-6
Establishing USB Communication.....	10-7
Mounting the eBase.....	10-8

Chapter 11 - Dolphin 70e Black Mobile Base (Model 70e-MB)

Overview.....	11-1
Charging Overview	11-1
Convenient Storage.....	11-1
Dimensions.....	11-1
Weight	11-1
Mobile Base Components	11-2
Adjustable Arm with Suction Cup Base for Windshield Mounting	11-2
Mounting the Mobile Base	11-3
Safety Precautions.....	11-3
Installation.....	11-3

Charging the Main Battery.....	11-4
To Power a Terminal and Charge its Main Battery.....	11-5
Removing the Cable.....	11-6

Chapter 12 - Dolphin 70e Black ChargeBase (Model 70e-CB)

Overview.....	12-1
Unpacking the ChargeBase.....	12-1
Charging Overview.....	12-1
Convenient Storage.....	12-1
Capacity.....	12-1
Dimensions.....	12-2
Weight.....	12-2
Parts and Functions.....	12-2
Front Panel.....	12-2
Dock LEDs.....	12-2
Back Panel.....	12-3
Power Supply Connector.....	12-3
Bottom Panel.....	12-3
Power.....	12-3
Connecting Power to the ChargeBase.....	12-4
Charging the Main Battery.....	12-4
To Power a Terminal and Charge its Main Battery.....	12-4
Mounting the ChargeBase.....	12-4
Optional DIN Rail Mount.....	12-5
Additional Hardware.....	12-5
Installing the DIN Rail.....	12-5

Chapter 13 - Dolphin 70e Black Net Base (Model 70e-NB)

Unpacking the Net Base.....	13-1
Optional Equipment.....	13-1
Charging Overview.....	13-1
Convenient Storage.....	13-1
Capacity.....	13-1
Dimensions.....	13-2
Weight.....	13-2
Parts and Functions.....	13-2
Front Panel.....	13-2
Bottom Panel.....	13-4
Power.....	13-4
Connecting Power to the Net Base.....	13-4
Charging the Main Battery.....	13-4
To Power a Terminal and Charge the Main Battery.....	13-4

Communication.....	13-5
Establishing Ethernet Communication.....	13-5
Bottom Panel.....	13-6
Optional DIN Rail Mount.....	13-6
Additional Hardware.....	13-6
Installing the DIN Rail.....	13-7

Chapter 14 - Customer Support

Product Service and Repair.....	14-1
Technical Assistance.....	14-1
Warranty Disclaimer: Proper Use of a Touch Screen Mobile Device.....	14-1
Limited Warranty.....	14-1
How to Extend Your Warranty.....	14-2

Dolphin 75e Terminal Agency Information

Dolphin 75e handheld computers meet or exceed the requirements of all applicable standards organizations for safe operation. However, as with any electrical equipment, the best way to ensure safe operation is to operate them according to the agency guidelines that follow. Read these guidelines carefully before using your Dolphin terminal.

This documentation is relevant for the following Dolphin models: 75eL00 and 75eL0N.

Caution: Read the [Guidelines for Battery Pack Use and Disposal](#) on page 3-16 and all cautionary markings on the battery, charging peripheral, or device using the battery before attempting to install, use, or charge the battery. Risk of fire and burns if improperly handled. Do not open, crush, heat above 60°C (140°F), or incinerate.



Caution: Any changes or modifications not expressly approved by the grantee of this device could void the user's authority to operate the equipment.

Mise en garde: Tout changement ou modification non expressément approuvées par le bénéficiaire de cet appareil peut annuler l'autorisation d'utiliser l'équipement.

Warning: To prevent possible hearing damage, do not listen at high volume levels for long periods.



For body worn operation, this device has been tested and meets the limits regarding human exposure to electromagnetic radiation set forth in related FCC, IC and EC rules, guidelines and standards for use with the following body worn accessories: HOLSTER-2 and 6000-HOLSTER. Use of other accessories may not ensure compliance with the mentioned rules.

Fonctionnement près du corps:

ce dispositif a été testé et s'avère conforme aux règles et lignes directrices des normes FCC, IC et EC, relatives aux limites d'une exposition humaine sécuritaire au rayonnement électromagnétique pour une utilisation près du corps des accessoires suivants: HOLSTER-2 et 6000-HOLSTER.

L'utilisation d'autres accessoires peut ne pas assurer la conformité avec les règles mentionnées.

Label Locations

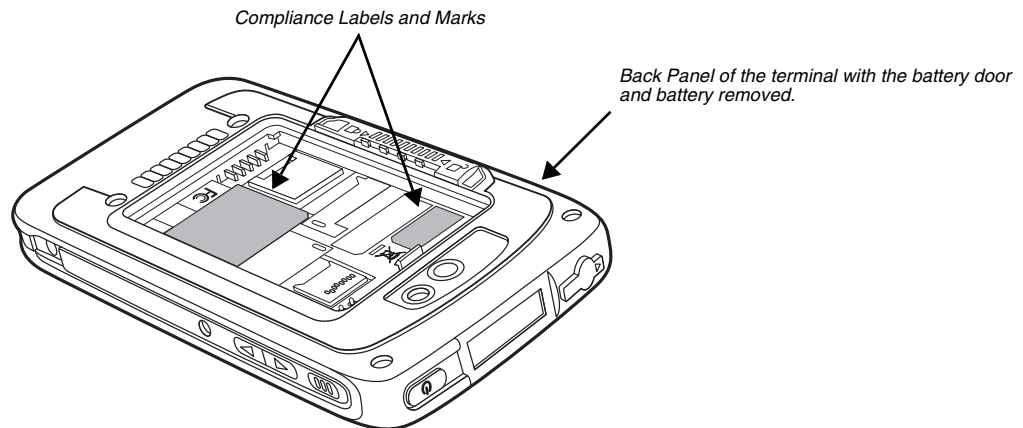

Model Number and Serial Number

The model (item) number and serial number for the terminal are located on labels affixed to the bottom of the battery well.

Approvals by Country

Refer to the *Honeywell Scanning & Mobility* compliance center at www.honeywellaidc.com/compliance to review and download any publicly available documentation pertaining to the certification of this product in a given country.

FCC Requirements

Dolphin RF Terminal—802.11a/b/g/n/ac, Bluetooth, and/or GSM

This device complies with Part 15 of the FCC Rules. Operation is subject to the following two conditions:

1. This device may not cause harmful interference.
2. This device must accept any interference received, including interference that may cause undesired operation.

This equipment has been tested and found to comply with the limits for a Class B digital device pursuant to Part 15 of the FCC Rules. These limits are designed to provide reasonable protection against harmful interference in a residential installation. This equipment generates, uses, and can radiate radio frequency energy and, if not installed and used in accordance with the instructions, may cause harmful interference to radio communications. However, there is no guarantee that interference will not occur in a particular installation. If this equipment does cause harmful interference to radio or television reception, which can be determined by turning the equipment off and on, the user is encouraged to try to correct the interference by one or more of the following measures:

- Reorient or relocate the receiving antenna.
- Increase the separation between the equipment and receiver.
- Connect the equipment into an outlet on a circuit different from that to which the receiver is connected.
- Consult the dealer or an experienced radio/TV technician for help.

If necessary, the user should consult the dealer or an experienced radio/television technician for additional suggestions. The user may find the following booklet helpful: "Something About Interference." This is available at FCC local regional offices. Our company is not responsible for any radio or television interference caused by unauthorized modifications of this equipment or the substitution or attachment of connecting cables and equipment other than those specified by our company. The correction is the responsibility of the user. Use only shielded data cables with this system.

Canadian Compliance, Conformité à la réglementation canadienne

This device complies with Industry Canada license-exempt RSS standard(s). Operation is subject to the following two conditions:

1. This device may not cause harmful interference.
2. This device must accept any interference received, including interference that may cause undesired operation.

5GHz band: Sub-band 5.150 - 5.250 GHz of the 5GHz LE-LAN (License Exempt Local Area Network Devices) supported in this device is permitted for indoor operation only.

Cet appareil est conforme aux normes RSS avec exemption de licence d'Industrie Canada. Son fonctionnement est assujéti aux conditions suivantes:

1. Cet appareil ne doit pas causer de brouillage préjudiciable.
2. Cet appareil doit pouvoir accepter tout brouillage reçu, y compris le brouillage pouvant causer un fonctionnement indésirable.

Bande 5 GHz: La bande inférieure de 5,150 à 5,250 GHz de la 5GHz LE-LAN (License Exempt Local Area Network Devices) pris en charge dans ce dispositif est autorisée pour une utilisation en intérieur uniquement.

RF Exposure Information (SAR)

This **device** meets the government's requirements for exposure to radio waves. This **device** is designed and manufactured not to exceed the emission limits for exposure to radio frequency (RF) energy set by the Federal Communications Commission of the U.S. Government.

The exposure standard for wireless devices employs a unit of measurement known as the Specific Absorption Rate, or SAR. The SAR limit set by the FCC is 1.6W/Kg and for Europe 2W/Kg. Although the SAR is determined at the highest certified power level, the actual SAR level of the **device** while operating can be well below the maximum value. This is because the **device** is designed to operate at multiple power levels so as to use only the power required to reach the network. In general, the closer you are to a wireless base station antenna, the lower the power output.

The highest reported SAR values for head, body-worn accessory and simultaneous transmission use conditions are: ____ W/kg (____ g), ____ W/kg (____ g) and ____ W/kg (____ g).

The highest reported CE SAR values for head, body-worn accessory and simultaneous transmission use conditions are: ____ W/kg (____ g), ____ W/kg (____ g), ____ W/kg (____ g).

While there may be differences between the SAR levels of various **devices** and at various positions, they all meet the government requirement.

The FCC has granted an Equipment Authorization for this **device** with all reported SAR levels evaluated as in compliance with the FCC RF exposure guidelines. SAR information on this **device** is on file with the FCC and can be found under the Display Grant section of www.fcc.gov/oet/ea/fccid after searching on FCC ID: HD5-75EL00 and HD5-75EL0N.

R&TTE Compliance Statement—802.11a/b/g/ac, Bluetooth

 The CE marking indicates compliance with the following directives:

- 1995/5/EC R&TTE
- 2011/65/EU RoHS (Recast)

In addition, this product complies to 2006/95/EC Low Voltage Directive when supplied with the recommended power supply. European Contact:

Hand Held Products Europe B.V.
Nijverheidsweg 9-13
5627 BT Eindhoven
The Netherlands

Honeywell shall not be liable for use of our product with equipment (i.e., power supplies, personal computers, etc.) that is not CE marked and does not comply with the Low Voltage Directive.

The equipment is intended for use throughout the European Community; PAN European Frequency Range: 2.400–2.4835 GHz.

Operating Frequency Ranges:

- 2400 - 2483.5 MHz, Wideband Data Transmission Systems (WLAN IEEE 802.11 b,g,n at 2.4 GHz);
- 5150 - 5350 MHz and 5470 - 5725 MHz, Wideband Data Transmission Systems (WLAN/RLAN IEEE 802.11 a,n,ac at 5 GHz);
- Operation on sub-band 5150 - 5350 MHz is permitted indoor only.

Honeywell Scanning & Mobility Product Environmental Information

Refer to www.honeywellaidc.com/environmental for the RoHS / REACH / WEEE information.

USA, Canada NRTL Safety

UL and C-UL listed: UL60950-1 2nd Edition, and CSA C22.2 No. 60950-1-07 2nd Edition.

LED Safety

LEDs have been tested and classified as “EXEMPT RISK GROUP” to the Standard: IEC 62471:2006.

Caution! Do not view directly with optical instruments.



Pacemakers, Hearing Aids and Other Electrically Powered Devices

Most manufacturers of medical devices adhere to the IEC 601-1-2 standard. This standard requires devices to operate properly in an EM Field with a strength of 3V/m over a frequency range of 26 to 1000MHz. The maximum allowable field strength emitted by the Dolphin terminal is 0.3V/m according to Subpart B of Part 1 of the FCC rules. Therefore, the RF from the Dolphin terminal has no effect on medical devices that meet the IEC specification.

Microwaves

The radio in the Dolphin RF terminal operates on the same frequency band as a microwave oven. Therefore, if you use a microwave within range of the Dolphin RF terminal you may notice performance degradation in your wireless network. However, both your microwave and your wireless network will continue to function.

Getting Started

Out of the Box

Verify that the carton contains the following items:

- Dolphin 75e handheld computer (terminal)
- 1 GB, 2 GB or 4 GB microSD™ Memory Card (Optional)
- 3.7V Li-ion rechargeable battery
- USB charge/communication cable
- Power adapter with regional plug adapters
- Quick start guide
- Compliance regulatory sheet

If you ordered accessories for your terminals, verify that they are also included with the order. Be sure to keep the original packaging in the event that the Dolphin terminal should need to be returned for service.

Memory Card Specifications

Honeywell recommends the use of Single Level Cell (SLC) industrial grade microSD or microSDHC™ memory cards with Dolphin terminals for maximum performance and durability. Contact a Honeywell sales representative for additional information on qualified memory card options.

Initial Setup for Dolphin 75e Terminal

Install the Battery

Before installing the main battery, read the [Guidelines for Battery Pack Use and Disposal](#) on page 3-11.

The terminal is shipped with the battery packaged separate from the unit. To install the battery, follow the installation steps illustrated. For information on how to remove the battery, see [Replacing the Battery](#) on page 2-10.



Ensure all components are dry prior to placing the battery in the terminal. Mating wet components may cause damage not covered by the warranty.

We recommend use of Honeywell Li-ion battery packs. Use of any non-Honeywell battery may result in damage not covered by the warranty.

Important: All battery and connector doors must be present, undamaged, and properly closed to maintain the environmental rating of the terminal.

Note: Standard battery and standard battery door shown.

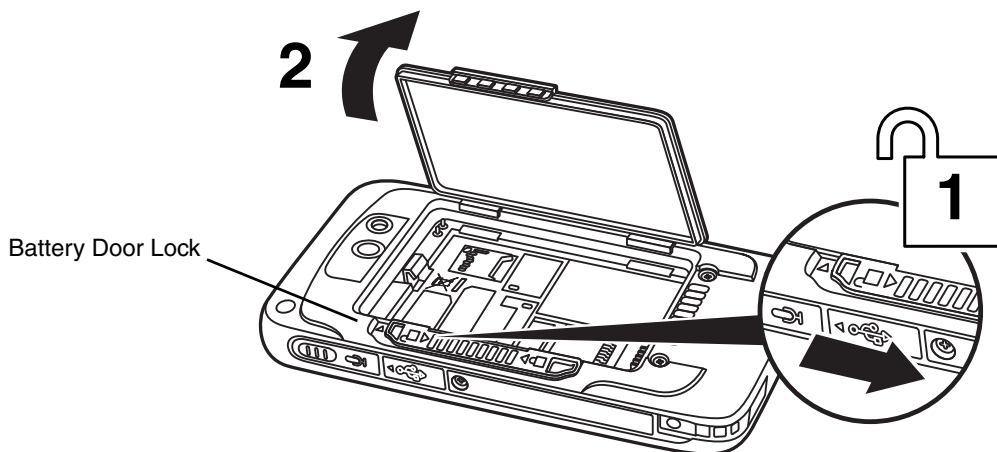

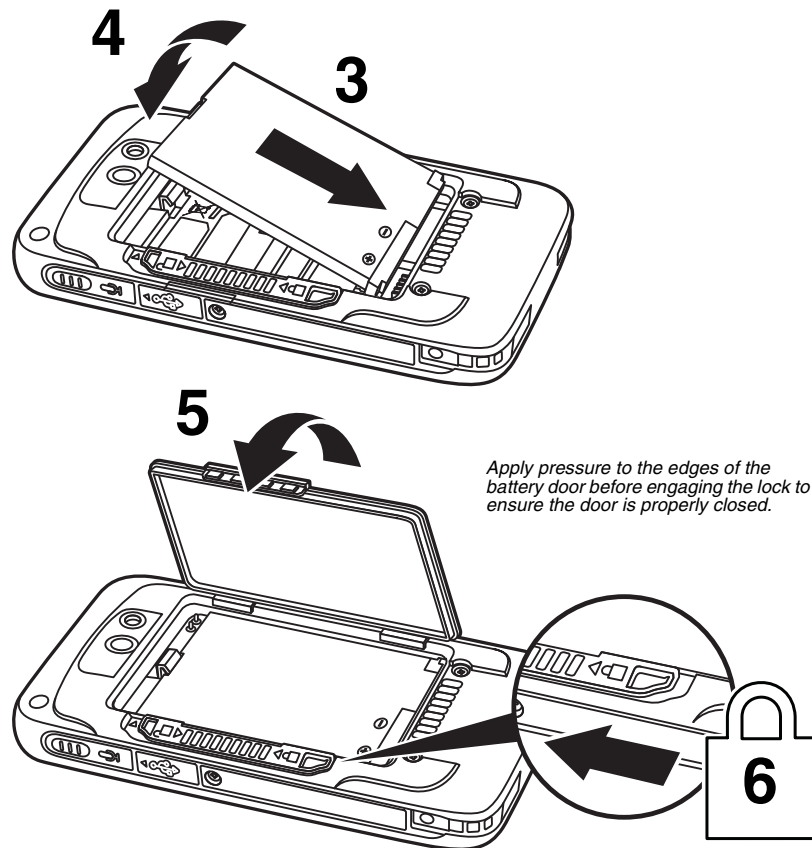

Charge the Battery

The power source for the Dolphin terminal is the 3.7V Li-ion rechargeable battery located under the battery door on the back panel of the device. See [Battery](#) on page 3-8 for additional information on battery storage, use, and disposal.

Important: Removing the battery from the terminal erases all non-persistent memory. Always place the terminal in Suspend mode before removing the battery. For information on how to remove the battery from the terminal, see [Replacing the Battery](#) on page 2-10.

Before Initial Use

Dolphin terminals ship with the battery significantly discharged of power. After installing the battery in the terminal, charge the battery with a Dolphin 75e compatible charging peripheral for a minimum of **4 hours** for the standard battery pack or **6 hours** for the extended battery pack. When using the 70e-USB Charge/Communication cable to charge from a 500mA USB port on a host device, charge the battery for a minimum of **6 hours** for the standard battery and **8 hours** for the extended battery.

Note: Inadequate source current may interfere with effective battery charging; see [Important Charging Guidelines](#) on page 3-10 for additional information.



We recommend use of Honeywell peripherals, power cables, and power adapters. Use of any non-Honeywell peripherals, cables, or power adapters may cause damage not covered by the warranty.

Dolphin 75e model terminals are designed for use with the following charging devices and cables: 70e-HB, 70e-CB, 70e-EHB, 70e-NB, 70e-MB, 70e-MC, and 70e-USB ADAPTERKIT. See pages [3-1](#) and [3-2](#) for additional information on peripherals and accessories.



Ensure all components are dry prior to mating terminals/batteries with peripheral devices. Mating wet components may cause damage not covered by the warranty.

Using the USB Charge/Communication Cable (Model 70e-USB ADAPTERKIT)

Dolphin 75e terminals ship with a USB Charge/Communication Cable and a power adapter with regional plug adapters. The USB Charge/Communication cable provides two options for charging the terminal. Use the cable in conjunction with the provided power supply adapter and plug adapter to charge the terminal from a power outlet (Option 1) or connect the cable to a high-power USB port to charge from a host device (Option 2).

Warning: The terminal shall only be connected to CTIA certified adapters, products that bear the USB-IF logo or products that have completed the USB-IF compliance program when using the micro USB port as a charging source.

Option 1: Charging from a power outlet

Use only a UL Listed power supply, which has been qualified by Honeywell with an output rated at 5VDC and 1A with the device.

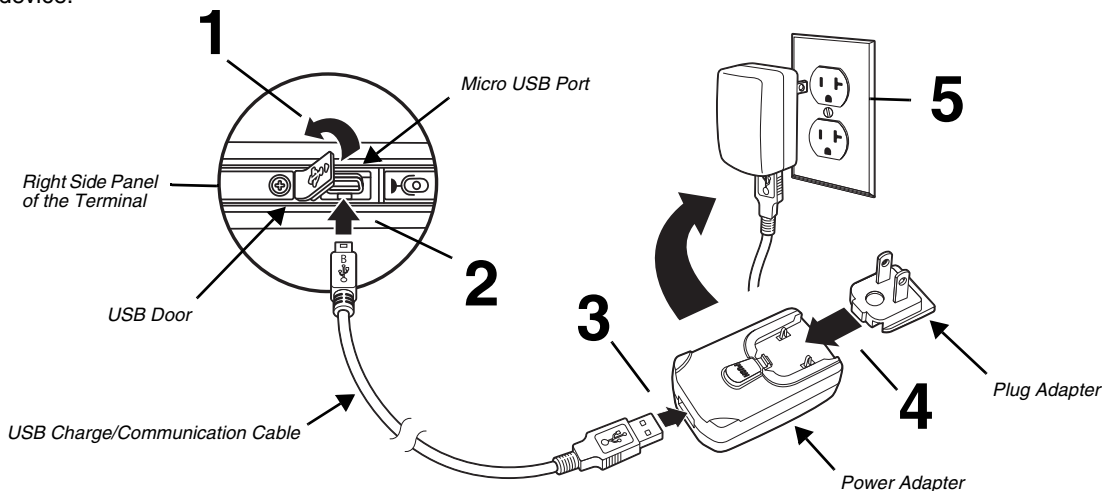

Option 2: Charging from a high power USB port on a host device (PC)

Charging the battery through a USB port takes more time than direct charging using the provided power supply. Inadequate source current may lengthen the charge time or prevent the battery from charging if the terminal is drawing more current than supplied by the USB port. The maximum current supplied by a USB Host can vary from 100mA to 500mA. **Do not attempt to charge the terminal from a 100mA source.** An active Dolphin terminal uses more current than supplied by a 100mA source causing the terminal to continue to draw power from the battery. See [Important Charging Guidelines](#) on page 3-10 for additional information.

Touch **All Apps** > **Settings** > **Battery** to verify the battery is charging.

*Note: Placing the terminal in **Suspend** mode while charging reduces the current draw of the terminal and shortens the charging time of the battery.*

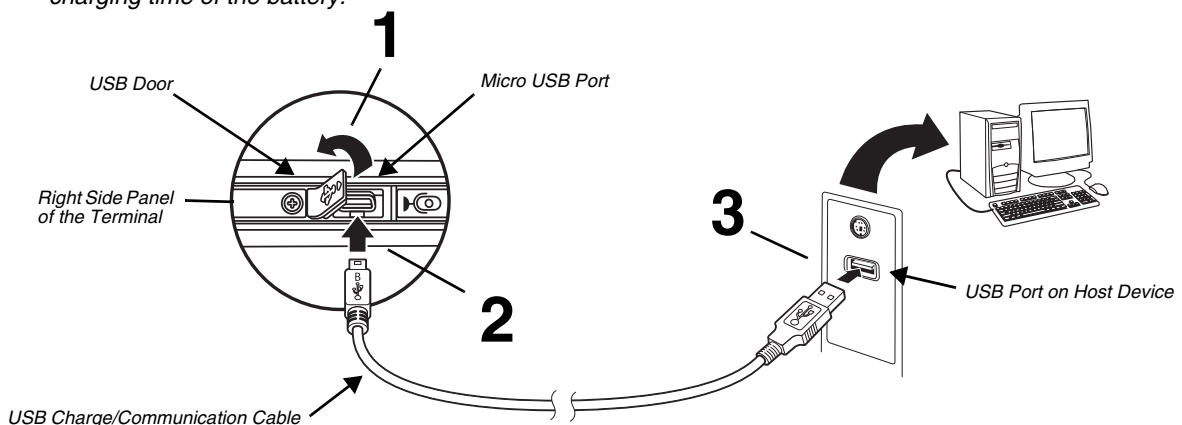

Power On the Terminal

To turn the terminal On, press and release the Power button . Do not press any buttons or attempt to remove the battery during the initial boot process.

The Welcome Screen



The first time you power up the Dolphin terminal, a Welcome screen appears after the boot process is finished. From the Welcome screen follow the prompts as the Setup Wizard guides you through:

- setting the default language for the terminal,
- setting up Wi-Fi network connections,
- setting the time, date, and time zone, and
- personalizing (naming) the terminal.

After the initial Setup Wizard is complete the Locked Screen displays.

Note: Once you complete the initial Setup Wizard, the Welcome screen no longer appears when you reboot the device. The Locked screen displays after the terminal completes the boot process.

Unlock the Screen

Drag the  to the edge of the screen or press the **Menu** button  to unlock the terminal and access the **Home** screen. See [Screen Security](#) on page 6-4 for information on customizing the screen lock/unlock security feature.

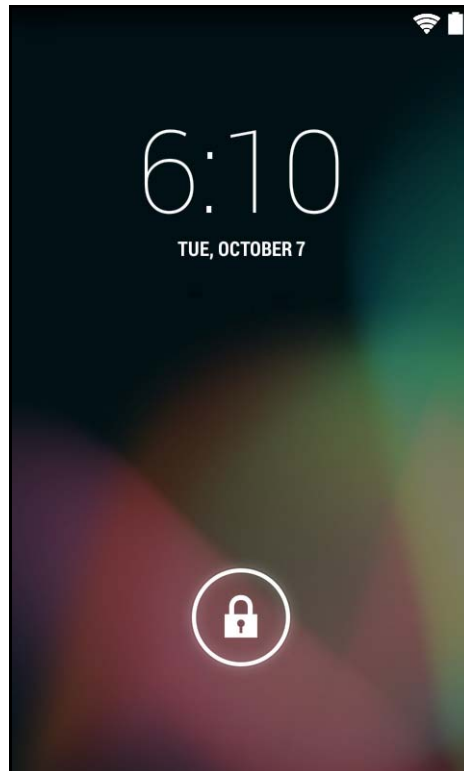

Customize the Home Screen and Access Apps

The Android™ operating system provides space for user customization and control with five **Home** Screen panels.

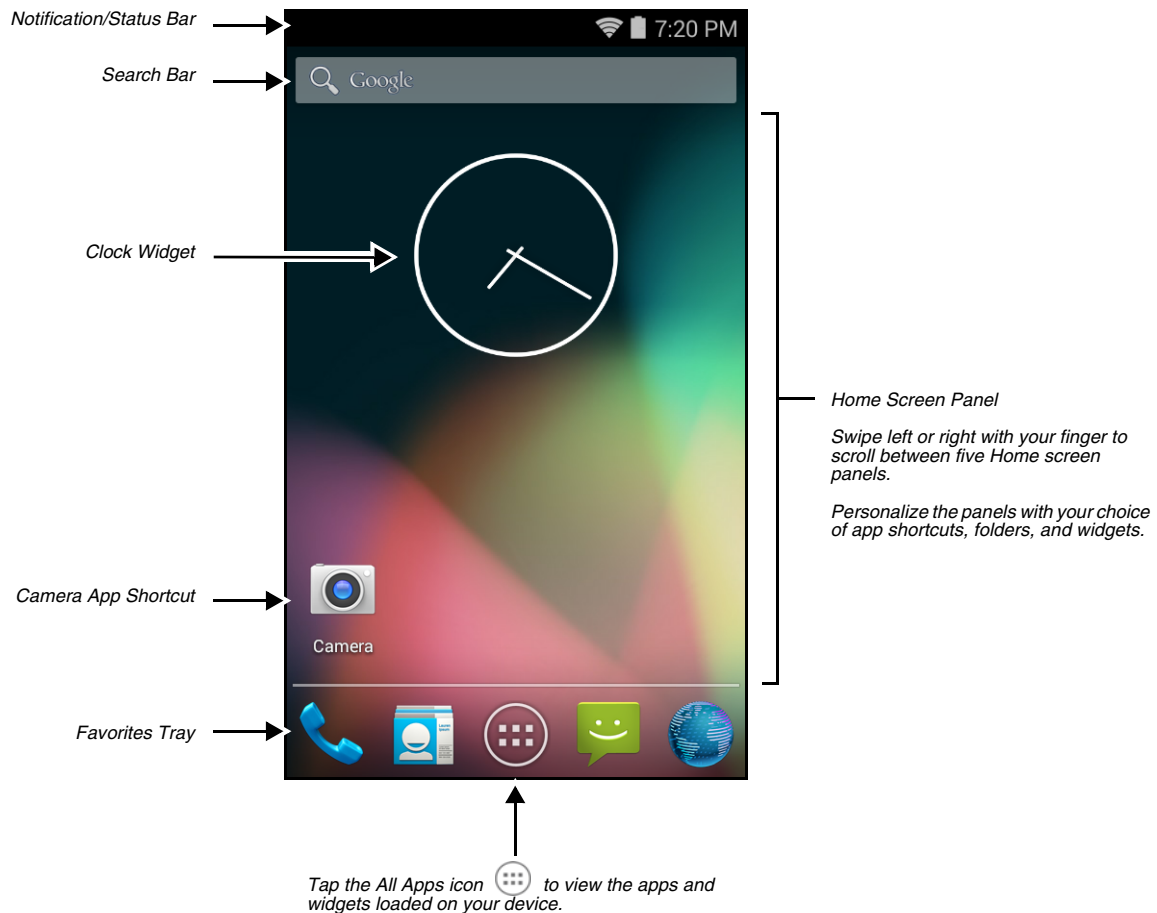

Note: You can return to the Home screen at any time, in any application by pressing the  button.

Status Bar

The status bar located at the top of the touch screen displays notifications (on the left), the status of various system functions (on the right), and the current time (on the far right).







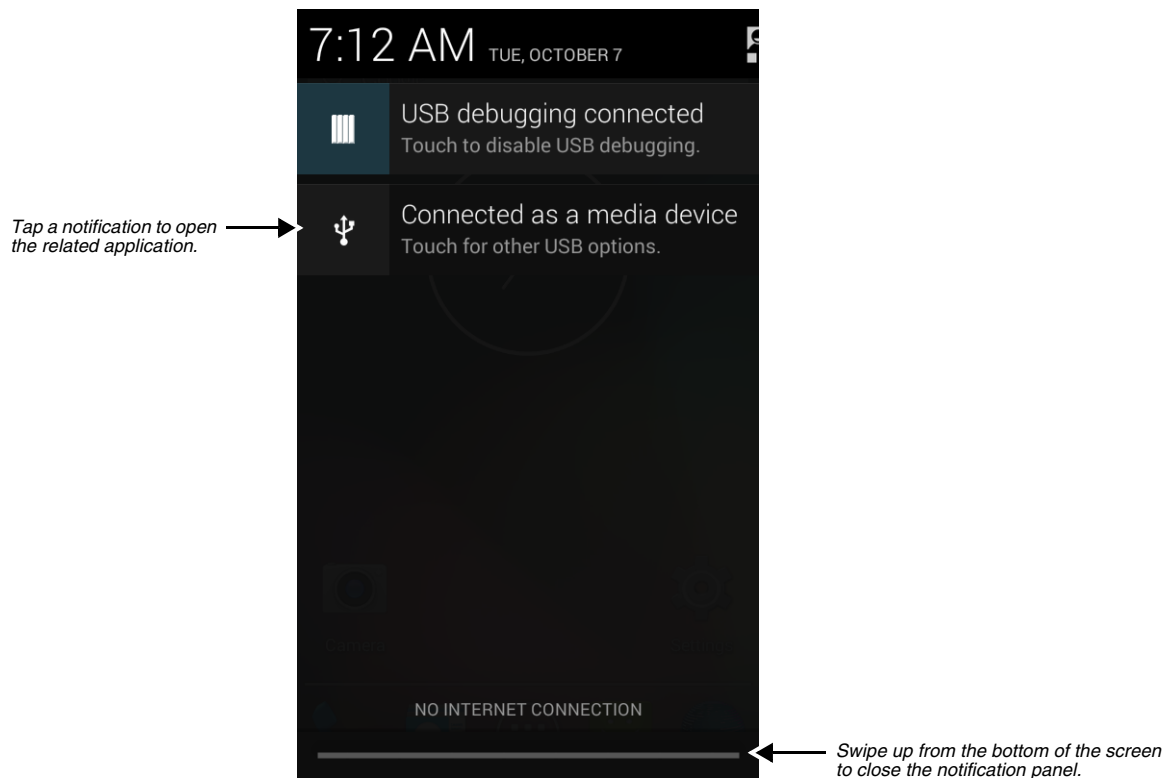

























Notification Panel

A plus sign icon  appears on the status bar when the quantity of notifications exceed the available space on the bar. To view all notifications, touch and hold the status bar, and then drag down.



Common Status and Notification Icons

Icon	Meaning	Icon	Meaning
<i>Note: Status and notification icons are hardware and software dependent. Some of the icons listed below may not be relevant for your Dolphin model.</i>			
	Open notification panel to see additional notifications		Sound is turned off
	Pending calendar event		Vibrate mode is turned on
	Pending alarm and Alarm is set		Battery charge is at 100%.
	New Hangouts™ message		Terminal is connected to external power and the battery is charging.
	New Gmail™ message		SD card or USB storage is full
	New text message or multimedia message		Bluetooth technology is turned on
	New E-mail		Terminal connected to a device with Bluetooth technology

Icon	Meaning	Icon	Meaning
	Error with text or multimedia message delivery		Bluetooth incoming file notification
	Terminal is connected to a computer using a USB cable		
	ABD active (USB debugging enabled)		
	Uploading data		Wi-Fi network connected and signal strength
	Downloading data		Ethernet status - disconnected
	Download finished		Ethernet status - connected
	Synchronizing data		Music player active
	Error with sync or sign-in		
	The terminal could not synchronize data with the computer		
	GPS is turned on		
	Receiving location data from GPS		

Search Bar

You can search for an item on the terminal or the Internet using **Google™ Search** at the top of any **Home** screen panel.

Touch inside the box to access the virtual keyboard for text entry.



To modify the search settings:

1. Touch inside the box then press the **Menu** button .
2. Touch **Settings** then select **Searchable items** or **Google Search**.

Personalize the Home Screen Panels and Favorites Tray

Streamline your work flow by customizing the **Home** screen panels and **Favorites** tray with your choice of app shortcuts, folders, and widgets.

To add an app shortcut:

1. Touch **All Apps** .
2. Select and hold the app icon you want to add. The terminal vibrates, and then switches to the home screen.
3. Drag and drop the icon into position on the **Home** screen or in an open spot on the **Favorites** tray.

Hints:

- To create a folder, drag and drop an app icon on top of another icon.
- To move a shortcut from the Favorites tray to the Home screen panel, touch and hold the item, and then drag and drop the icon onto the Home screen.

To add a widget:

1. Touch **All Apps** .
2. Select the **Widget** tab.
3. Touch and hold the widget you want to add. The terminal vibrates and switches to the Home screen.
4. Drag and drop the widget into the desired position.

To remove/delete an item:

1. Touch and hold the item.
2. Drag the item to the top of the screen where the word **Remove** is displayed.

To move an item:

1. Tap and hold the item.
2. When the unit vibrates, drag and drop the item in the new location.







Note: The next panel automatically opens if you drag the item to the edge of the touchscreen.



Apps and Widgets

Touch the **All Apps** icon  located at the bottom of any **Home** screen to see the all apps and widgets loaded on your terminal.

Navigation/Function Buttons

The Dolphin terminal has seven navigation/function buttons.

Button	Function
	Back Back to the previous screen.
	Menu Opens additional menu options.
	Scan Wakes the terminal from Suspend Mode . Triggers the scanner/imager in the following apps: IQ Image Demo , Imaging Demo and Scan Demo . Triggers the scanner/imager when ScanWedge is enabled. Refer to the <i>Dolphin Power Tools User's Guide</i> available for download at www.honeywellaidc.com .
	Recent Apps View and switch between recently used apps.
	Home Return to the Home screen.
	Right & Left Side Triggers the scanner/imager in the following apps: IQ Image Demo , Imaging Demo and Scan Demo . Triggers the scanner/imager when ScanWedge is enabled. Refer to the <i>Dolphin Power Tools User's Guide</i> available for download at www.honeywellaidc.com .

Button	Function
 Back	Back to the previous screen.
 Volume	Raises or lowers the volume of the active speaker.

Hotkeys

You can configure the **Scan** button and the **Left** and **Right** side buttons of the terminal to launch specific applications.

Touch **All Apps**  > **Power Tools**  > **Configure Hotkeys** . Touch the box next to the key being configured. Select the app you want assigned to the key from the associated menu.

Refer to [Features of the Dolphin 75e](#) on page 3-3 for button locations on the terminal.

Virtual Keyboard

The virtual keyboard appears when you open an application or select a field that requires text or numerical input. The content of the keyboard may vary depending on the application in use and the input field requirements.

Using the Virtual Keyboard

During text input, you may need to switch between keyboard modes to access additional character sets (e.g., function keys, symbols, and numbers). Each keyboard mode, includes navigation keys, which allow you to quickly switch between modes. Touch the **ABC** key to switch to the Qwerty Mode, the **?123** key to switch to the Numeric Mode. Touch and hold the **comma** “,” key to access the settings for input options or the **period** “.” key to access additional symbols (e.g., @, %, +, &).

See [Language & input](#) on page 6-6 for additional information on configuring keyboard & input methods.

Note: The content of the keyboard and the mode initially displayed may vary depending on the application in use and the input field requirements.

Turning Power On/Off

To turn the terminal **On**, press and release the **Power** button .

To turn the terminal **Off**:

1. Press and hold the **Power** button  until the **Options** menu displays.

*Note: If the **Show System Dialog** setting is turned off (see page 6-1), the **Options** menu does not display when you press and hold the Power button. The terminal automatically reboots when Power button is held for approximately 8 seconds.*

2. Touch **Power Off**.

You should always power off the terminal before removing the battery. For information on removing the battery, see [Replacing the Battery](#).

Suspend Mode

Suspend mode automatically turns the touch screen off and locks the terminal to save battery power when the terminal is inactive for a programmed period of time.

1. Press and release the **Power** button  to toggle the terminal in or out of **Suspend** mode.



*Note: If the **Power key** setting has been turned off (disabled), pressing and releasing the key has no effect. See [Display Settings](#) on page 6-1.*

2. Drag the  to the right or press the **Menu** button  to unlock the terminal.

To adjust the timeout limit, touch **All Apps**  > **Settings**  > **Display** > **Sleep**.

Airplane Mode

Turn On Airplane mode to disable all the terminal radios that transmit voice or data.

1. Press and hold the **Power** button  until the **Options** menu displays.
2. Touch **Airplane Mode** to toggle the mode on or off. When Airplane Mode is turned on,  shows on the status bar.

*Note: If the **Show System Dialog** setting is turned off (see page 6-1), the **Options** menu does not display when you press and hold the Power button. The terminal automatically reboots when Power button is held for approximately 8 seconds.*

*To enable Airplane mode when the **Show System Dialog** setting is off: touch  > **Settings** . Under the "Wireless & Networks" heading, select **More**. Check the box next to **Airplane Mode**.*

Replacing the Battery

Before replacing the battery, read the [Guidelines for Battery Pack Use and Disposal](#) on page 3-11.

For battery replacement part numbers, see [Replacement Battery Specifications](#) on page 3-8.



RISK OF EXPLOSION IF BATTERY IS REPLACED BY AN INCORRECT TYPE. The battery should be disposed of by a qualified re-cycler or hazardous materials handler. Do not incinerate the battery or dispose of the battery with general waste materials.

Ensure all components are dry prior to mating terminals/batteries with peripheral devices. Mating wet components may cause damage not covered by the warranty.

We recommend use of Honeywell Li-ion battery packs. Use of any non-Honeywell battery may result in damage not covered by the warranty.

The following illustrations depict a standard battery with a standard battery door; however, battery removal and installation procedures are the same for the extended battery and extended battery door.

To replace the battery:

1. Power Off the terminal.
2. Unlock and remove the battery door.

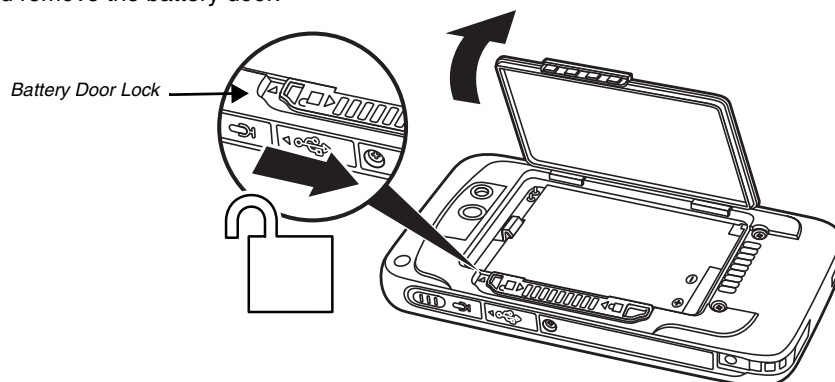

3. Pull the battery latch back and remove the battery.

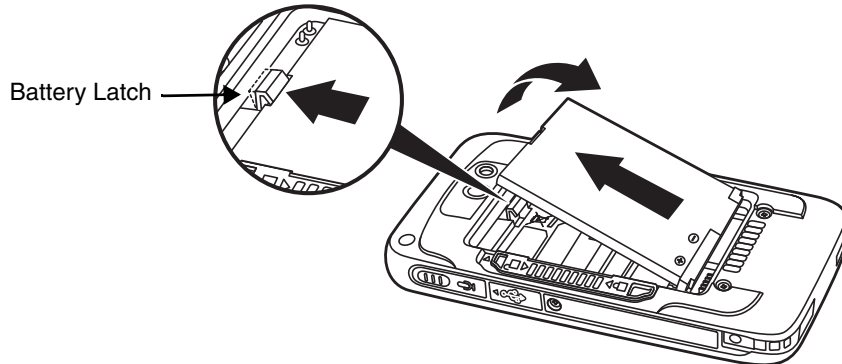

4. Insert the new battery and install the battery door.

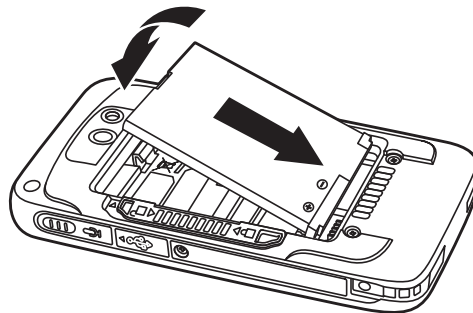

5. Apply pressure to the edges of the battery door to ensure the door is properly closed. Engage the door lock.
6. Press the **Power** button .

Important: All battery and connector doors must be present, undamaged, and properly closed to maintain the environmental rating of the terminal.

Resetting the Terminal

There are two three types of system resets: a **Hard Reset**, a **Soft Reset**, or a **Factory Reset**. The hard or soft reset preserves all data stored in the file system. Contact a Honeywell technical support representative for information on how to perform a **Factory Reset**. For contact information, see [Technical Assistance](#) on page 14-1.

Hard Reset (Cold Boot)

A hard reset reboots the device and closes any open applications running in RAM at the time of the reset.

1. Press and hold the **Power** button  until the **Options** menu displays.

*Note: If the **Show System Dialog** setting is turned off (see page 6-1), the **Options** menu does not display when you press and hold the Power button. The terminal automatically reboots when Power button is held for approximately 8 seconds.*

2. Touch **Reboot**.

Soft Reset (Warm Boot)

A Soft Reset (Warm Boot) re-boots the device and preserves any objects created in RAM. You would perform a soft reset when: the terminal fails to respond, after installing some software applications, or after making changes to certain system settings, such as network cards.

Press and hold the **Power** button  for approximately 8 seconds until the terminal starts to reboot. When the reset is complete, the **Lock** screen displays.

Connecting the Terminal to a Computer via a USB Connection

You can transfer files (e.g., pictures, music, and videos) between your computer and the terminal using the supplied USB Charge/Communication cable or a Dolphin 70e Black HomeBase with a standard USB cable.

Note: The terminal supports Hi-Speed USB communication (USB 2.0) with a maximum data transfer rate of 480 Mbps.

1. Connect the terminal to your computer using the USB Charge/Communication cable supplied.

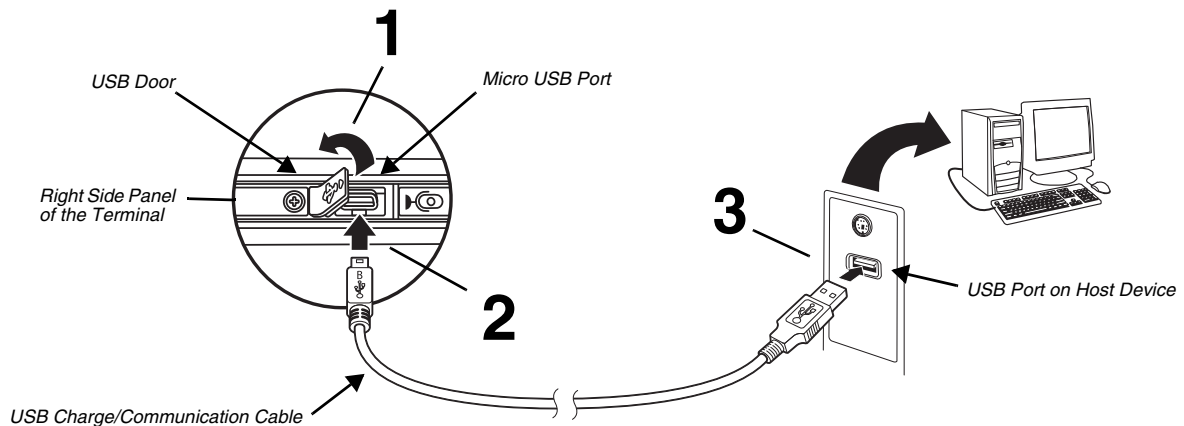

On the status bar, the following notification briefly appears to indicate the hardware connection has been established:

🔌 Connected as a media device

2. The computer views the terminal as an external USB storage drive. You can now copy, delete and/or move files or folders between the computer and the terminal or the microSD card installed in the terminal as you would with any other storage drive (e.g., cut and paste or drag and drop).
3. When you are finished transferring files, follow the proper procedure for your computer's operating system to safely remove the hardware (e.g., unmount or eject) before attempting to disconnect the terminal from the computer or turning off the USB storage setting. **Data corruption may occur if the proper removal processes are not followed.**

File Browser Power Tool

File Browser provides a graphical utility to browse the files stored on the terminal and the microSD card.

Touch **All Apps**  > **Power Tools**  > **File Browser**  to open the browser.

Touch a folder name or file name to open the folder or file.

Note: Due to system permissions, some files cannot be opened. Depending on the associated application(s), a choice of applications may be available to open the file.

Browser Menu

Press the **Menu** button  and touch **Home** to return to the root folder or **Close** to exit the File Browser.

Internal Storage

The **Internal storage\Honeywell** folder on the Dolphin terminal is semi-permanent storage on the terminal. By default, files in this folder are maintained after a reboot.

Upgrades for the Power Tools and other system software on the Dolphin terminal come in the form of zip files. When the zip files are placed in the **Internal storage\Honeywell\Autoinstall** folder on the Dolphin terminal, they are automatically installed after a **Hard Reset** (see page 2-11) if **AutoInstall** is enabled (see below). Upgrades are available from [Customer Support](#) (see page 14-1) or www.honeywellaidc.com.

Note: To copy the Power Tools upgrade files, an active USB connected session must be initiated between a host workstation (see page 2-12).

AutoInstall Settings

Touch **All Apps**  > **AutoInstall Settings** .

If **AutoInstall** is enabled, the **Internal storage\Honeywell\Autoinstall** folder on the Dolphin terminal is searched for zip files containing applications. Each zip file is compared to the applications presently installed on the Dolphin terminal:

- If the application is not installed, AutoInstall installs the application.
- If the application is already installed, AutoInstall checks to see if the zip file contains a newer version of the application and installs the newer version.
- If the application is already installed and there is not a newer version, AutoInstall ignores the installation file.

If **AutoInstall** is not enabled, the contents of the **Internal storage\Honeywell\Autoinstall** folder are ignored.

Additional Resources

Product Guides and Software Downloads	
Dolphin 75e powered by Android Network & Security Guide	Available for download from the Dolphin 75e product page at www.honeywellaidc.com .
Dolphin 75e Black powered by Android Quick Start Guides	
Dolphin Power Tools for devices powered by Android User's Guide	
Honeywell Software Development Kits (SDK)	
Honeywell Tools and Utilities	
Android OS	
Android Developer Web Site Detailed information on application development for Android devices.	http://developer.android.com

Hardware Overview

Standard Configurations for the Dolphin 75e

WLAN, WPAN & Camera

- Android 4.4
- Qualcomm APQ8074AB Processor
- 2GB RAM X 16GB Flash
- 3.7V Li-ion rechargeable standard or extended battery pack
- Dedicated imager capable of decoding standard 1D and 2D bar code symbologies
- 8.0 megapixel auto focus color camera
- 802.11a/b/g/n/ac and Bluetooth

WLAN, WPAN, NFC & Camera

- Android 4.4
- Qualcomm APQ8074AB Processor
- 2GB RAM X 16GB Flash
- 3.7V Li-ion rechargeable standard or extended battery pack
- Dedicated imager capable of decoding standard 1D and 2D bar code symbologies
- 8.0 megapixel auto focus color camera
- 802.11a/b/g/n/ac and Bluetooth
- Near Field Communication (NFC) support

Peripherals for the Dolphin 75e

Each of the following items is sold separately to enhance the capabilities of your Dolphin terminal. Dolphin 70e Black peripherals are compatible with Dolphin 75e terminals.

Dolphin 70e Black HomeBase (Model 70e-HB)

The HomeBase is a charging and communication cradle equipped with a USB host port that is Hi-Speed 2.0v compliant, which enables the terminal to interface with the majority of PC-based enterprise systems. This device also contains an auxiliary battery well that charges a spare Honeywell standard or extended battery pack.

For more information, see [Dolphin 70e Black HomeBase \(Model 70e-HB\)](#) on page 9-1.

Dolphin 70e Black eBase (Model 70e-EHB)

The Ethernet Base (eBase) enables a single Dolphin 75e terminal to communicate with a host device over an Ethernet network. In addition, the ebase is equipped with a USB host port that is Hi-Speed 2.0v compliant, which enables the terminal to interface with the majority of PC-based enterprise systems. This device also contains an auxiliary battery well that charges a spare Honeywell standard or extended battery pack.

For more information, see [Dolphin 70e Black eBase \(Model 70e-EHB\)](#) on page 10-1.

Dolphin 70e Black Mobile Base (Model 70e-MB)

The Mobile Base is a charging cradle designed specifically for in-premise and in-transit data collection applications. It features a flexible mounting bracket, an integrated speaker with volume control, and a cigarette lighter adapter to adapt it to your mobile environment.

For more information, see [Dolphin 70e Black Mobile Base \(Model 70e-MB\)](#) on page 11-1.

Dolphin 70e Black ChargeBase (Model 70e-CB)

The ChargeBase is a 4-slot charging cradle that holds, powers, and charges terminals.

For more information, see [Dolphin 70e Black ChargeBase \(Model 70e-CB\)](#) on page 12-1.

Dolphin 70e Black Net Base (Model 70e-NB)

The Net Base enables up to four Dolphin 75e terminals to communicate with a host device over an Ethernet network. In addition, the Net Base provides a second RJ45 Ethernet port for connection to an additional device such as a printer, workstation, eBase, or another Net Base.

For more information, see [Dolphin 70e Black Net Base \(Model 70e-NB\)](#) on page 13-1.

QuadCharger (Model COMMON-QC)

The QuadCharger is a compact 4-slot battery charging station designed for use with Dolphin 75e 3.7V Li-ion rechargeable batteries. For additional information on the common QuadCharger, visit the Dolphin 75e product page at www.honeywellaidc.com or contact your local sales representative.

Accessories for the Dolphin 75e

Each of the following items is sold separately to enhance your terminal's capabilities.

Note: When using accessories where the terminal is worn on the body, the terminal's touch panel must face away from the body.

Dolphin 75e Mobile Charger (Model 70e-MC)

The Mobile Charger is a charging cable that connects the terminal directly to a 12 Volt DC power source, such as a cigarette lighter port inside a vehicle, eliminating the need for a cradle. Intelligent battery technology on-board the terminal ensures proper charging. The Mobile Charger is an ideal low-cost charging solution for in-transit mobile applications.

USB Charge/Communication Cable Adapter Kit (Model 70e-USB ADAPTERKIT)

The Dolphin USB charge/communication cable adapter kit is an all-in-one solution for charging and communication. Use the 70e-USB cable in conjunction with the included power supply adapter and plug adapter to charge the terminal from a power outlet or connect the cable to a high-power USB port to charge from a host device. The 70e-USB cable also supports communication with a computer without the need for a cradle. See [Connecting the Terminal to a Computer via a USB Connection](#) on page 2-12.

Holsters (Model HOLSTER-2 and 6000-HOLSTER)

A holster provides convenient storage for the Dolphin 75e terminal in mobile environments. Long and short holster models with integrated belt clips and spare battery pouches are available.

Wrist Lanyard (Model SL-LANYARD-1)

The black wrist lanyard attaches to the bottom corner of the terminal providing additional security from accidental drop during terminal use.

Stylus or Stylus and Tether Kit (Model 70e-Stylus or 70e-STYLUSTHR KIT)

The stylus has a special tip for added accuracy and ease when operating the touch panel. The tether is a coiled, elastic cord, which secures the stylus to the terminal to prevent accidental loss. The stylus may be ordered with or without the tether.

Stylus Battery Door Kits

Battery doors with an integrated stylus slot are available with or without a stylus and tether. The stylus has a special tip for added accuracy and ease when operating the touch panel. The integrated slot in the battery door holds the stylus when not in use. The tether is a coiled, elastic cord, which secures the stylus to the terminal preventing accidental loss when the stylus is not properly stored in the slot. See [Important Battery and Battery Door Replacement Guidelines](#) on page 3-9 before ordering battery door kits for your terminal.

Battery (Models 70e-BTSC and 70e-BTEC)

The 3.7V Li-ion rechargeable battery provides the main power for the terminal. See [Battery](#) on page 3-8 for battery specifications, replacement part numbers, and guidelines for use and disposal.

Features of the Dolphin 75e

Front, Bottom, and Right Panels

For a description of each callout, see page 3-4.

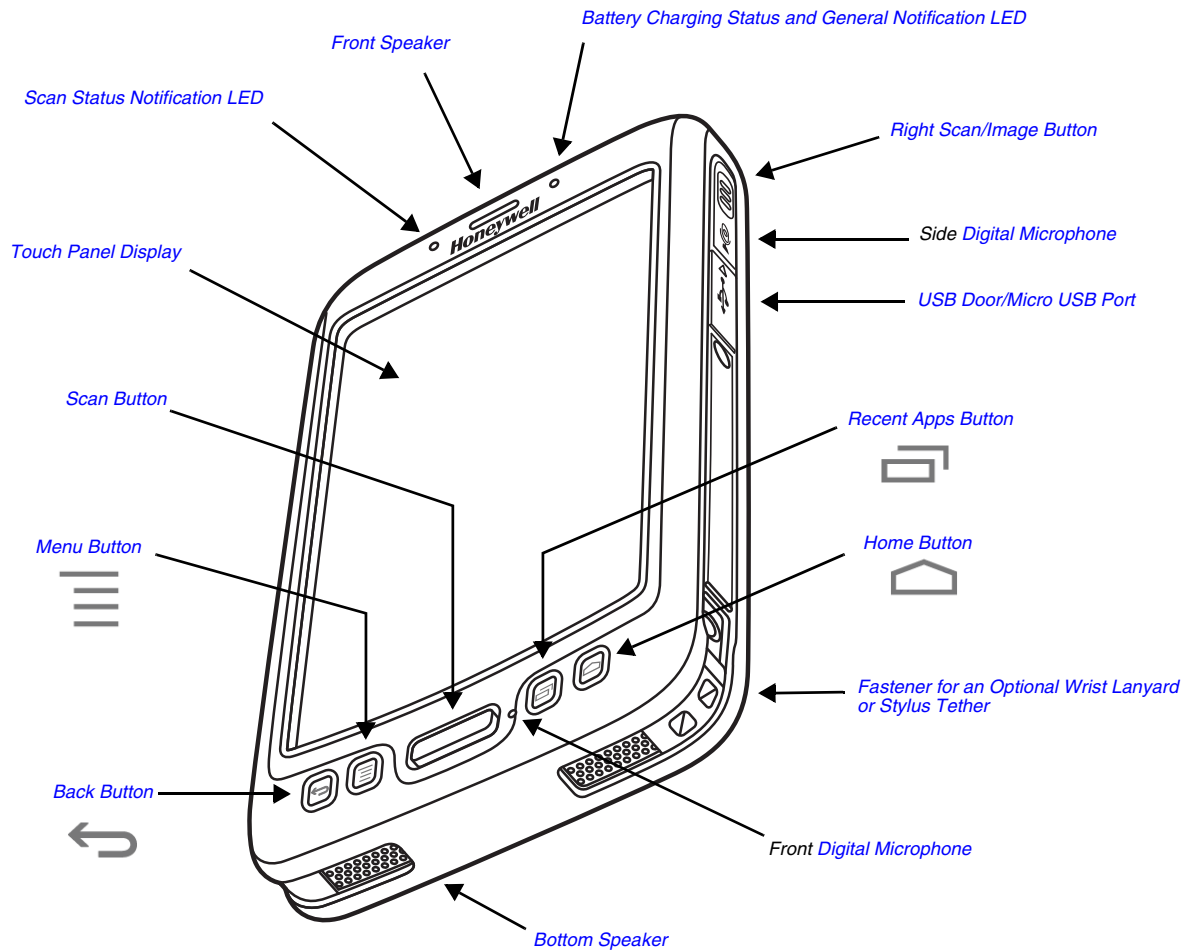

Important: Do not cover the side microphone with your hand when using the terminal for handset VoIP calls.

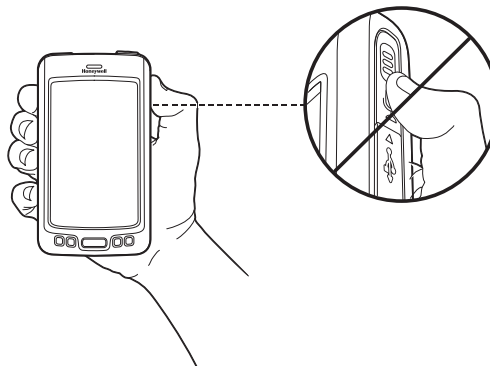

Feature Descriptions: Front, Bottom, and Right Panels

Back Button

By default, the Back button returns you to the previous screen.

Bottom Speaker

The integrated bottom speaker sounds audio signals as you scan bar code labels and enter data. The integrated speaker also supports playback of wave and MP3 files, software mixer, and speaker phone for VoIP audio.

Digital Microphone

The integrated dual array digital microphones, located on the side and front of the terminal provide audio input for handset VoIP calls when a headset is not plugged into the [Audio Jack](#), page 3-7. When a headset is plugged into the Audio Jack, the terminal defaults to the microphone on the headset. By default, the front microphone is also used for speaker phone calls, voice command audio input, and recording sound.

The digital microphones provide background noise cancellation for clear audio input.

Important: Do not cover the side microphone with your hand when using the terminal for handset VoIP calls.

Front Speaker

The front speaker is the receiver for handset VoIP calls.

Fastener for an Optional Wrist Lanyard or Stylus Tether

The fastener provides access for attaching an optional wrist lanyard or stylus tether.

Battery Charging Status and General Notification LED

The light emitting diode (LED) located above and to the right of the LCD display flashes and illuminates during resets and taking a picture. When the terminal is connected to an AC power source, the LED indicates charging activity. This LED can be programmed by various software applications.

Home Button

By default, the **Home** button returns you to the Home screen, see page 2-5.

Menu Button

Press the **Menu** button to access options relevant to the open application.

Right Scan/Image Button

By default, the right button triggers the scanner/imager. You can reassign the button to launch applications or execute commands; see [Hotkeys](#) on page 2-9.

Recent Apps Button

The **Recent Apps** button allows you to view and switch between recently used apps.

Scan Button

The Scan button is centrally located for easy access with the right or left hand. When pressed, the Scan button activates the scanner/imager when ScanWedge is enabled or a scanning/imaging demo app is open (e.g., IQ Image Demo, Scan Demo). The Scan button also functions as a system wake-up control if the terminal has entered Suspend Mode. You can reassign the button to launch applications or execute commands; see [Hotkeys](#) on page 2-9.

Touch Panel Display

The color 4.3 inch (liquid crystal display (LCD) touch panel is covered with an industrial, protective lens for greater durability. The wide video graphic array (WVGA) display resolution is 800 X 480. The touch panel can be activated with a finger or with the optional stylus.

The touch panel backlight illuminates when the screen is touched. To conserve battery power the touch screen dims then darkens automatically after a period of no activity. Press the **Power** button, and then drag the unlock icon to the right or press the **Menu** button to wake the terminal and access the last screen viewed. See [Display Settings](#) on page 6-1 for information on how to adjust sleep (timeout) settings.

USB Door/Micro USB Port

The Micro USB port is located under the protective USB door on the right side of the terminal. To access the micro USB port, gently lift the top edge of the door closest to the digital microphone.

The micro USB port in conjunction with the USB Charge/Communication Cable Adapter Kit powers the terminal, charges the main battery, and facilitates communication. The micro USB port supports low, full, and high-speed USB v2.0 client communication with a maximum rate of 480 Mbps.

For additional information, see [Using the USB Charge/Communication Cable \(Model 70e-USB ADAPTERKIT\)](#) on page 2-3 and [Connecting the Terminal to a Computer via a USB Connection](#) on page 2-12.

Scan Status Notification LED

The light emitting diode (LED) located above and to the left of the LCD display flashes and illuminates during scanning/imaging to provide scan status information.

Back, Top, and Left Panels

For a description of each callout, see page 3-7.

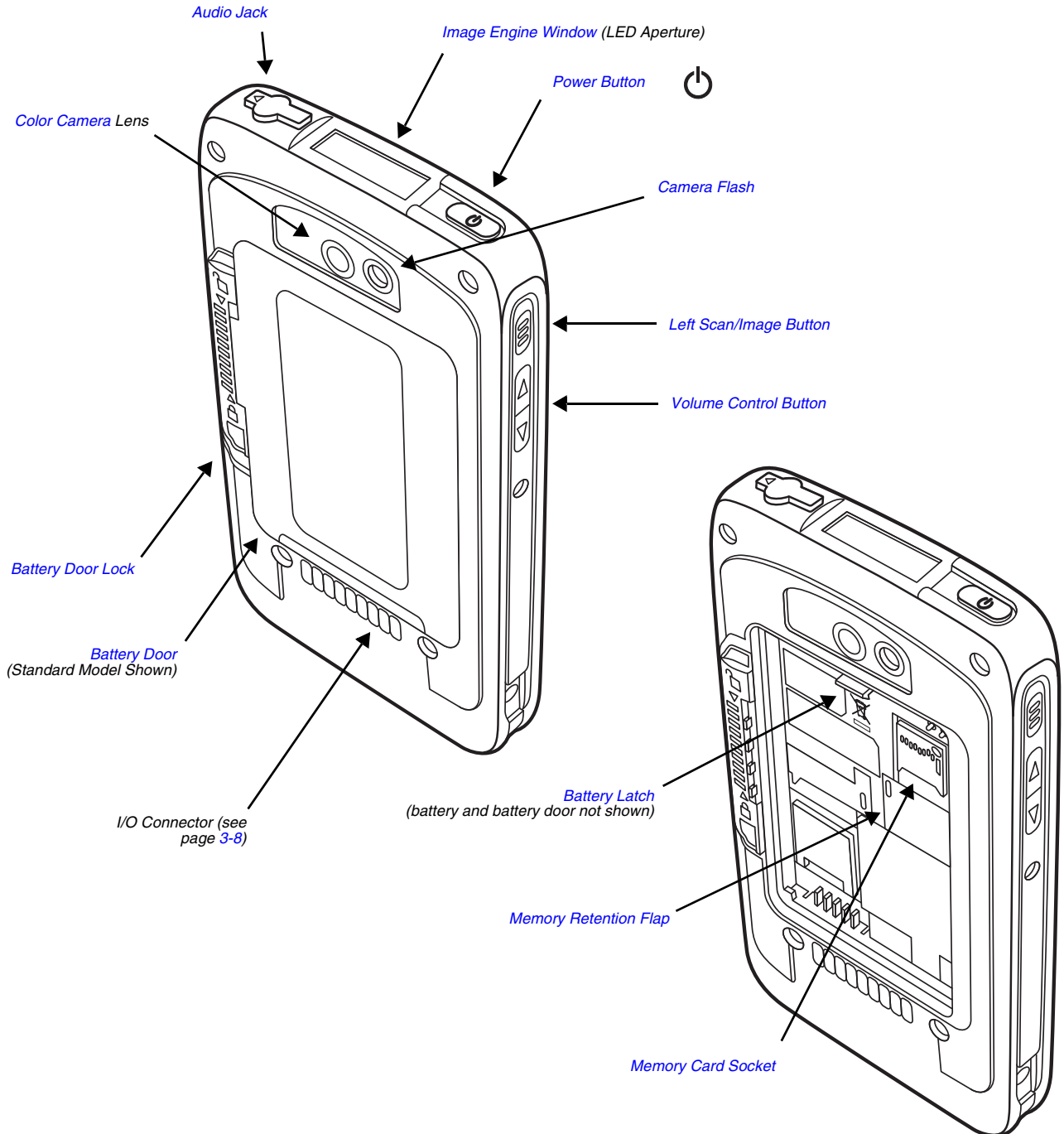

Feature Descriptions: Back, Top, and Left Panels

Audio Jack

The audio jack is located under the protective door on the top of the terminal. To access the jack gently lift the edge of the door marked with an arrow. The 3.5mm audio jack supports both speaker (stereo) and microphone (mono) headsets.

Battery

The 3.7V Li-ion rechargeable battery provides the main power for the terminal and is protected by the battery door. See [Battery](#) on page 3-8 for battery specifications, replacement part numbers, and guidelines for use and disposal.

Battery Door

The battery door protects the battery and any installed SIM and/or memory cards in the terminal's battery well. Proper installation of the battery door preserves the environmental rating of the terminal. Do not use the terminal without the battery door installed.

Battery Door Lock

The battery door lock secures the battery door to the terminal. Slide the lock down toward the IO contacts to release the lock for battery door removal and battery access. Slide the lock up toward the camera lens to secure the battery door closed and seal the battery in the terminal. Proper installation of the battery door preserves the environmental rating of the terminal.

Battery Latch

The battery latch secures the battery in the battery well. Pull the latch away from the battery to release and remove the battery from the terminal. For information on [Replacing the Battery](#), see page 2-10.

Color Camera

The 8.0-Megapixel Resolution color camera provides easy picture and video capture. The camera lens and camera flash are located on the back panel of the terminal.

Camera Flash

The camera flash is located on the back panel of the terminal. When used as a Camera Flash with the integrated color camera, the flash is controlled by the camera application.

Image Engine Window

The image engine reads and decodes linear, stacked linear (e.g., PDF417), and 2D matrix bar code symbologies. The LED aperture for the imaging engine's LED aimer is contained behind this window. For more details, see [Using the Scan Image Engine](#) on page 4-1.

Left Scan/Image Button

By default, the left button triggers the scanner/imager. You can reassign the button to launch applications or execute commands; see [Hotkeys](#) on page 2-9.

Memory Card Socket

The memory card socket provides the user with the option to expand the terminal's memory capacity using microSD or microSDHC memory interfaces. The expansion socket is located under the battery door and battery.

When the battery door and battery pack are properly installed, the card is sealed against moisture and particle intrusion, read/write data is stored securely, and the terminal's environmental rating is preserved; see [Installing a Memory Card](#) on page 3-12.

Memory Retention Flap

The memory card retention flap locks the memory card in the socket; see [Installing a Memory Card](#) on page 3-12.

Power Button

The **Power** button  located on the top of the terminal initiates multiple functions depending on the length of time the button is pressed.

- A quick press of the button toggles **Suspend Mode** On or Off. To modify this feature, see **Power Key** on page 6-2.
- Press and hold the button down for approximately 4 seconds to access the **Options** menu to **Power Off** the terminal, **Reboot** (Hard Reset) the terminal, enable **Airplane Mode**, set the **Volume** of the active speaker to On, Off, or Vibrate. To modify this feature, see **Show System Dialog** on page 6-2.
- Press and hold the button down for approximately 8 seconds to initiate a manual **Reboot** (Soft Reset) if the touch screen has stopped responding.

Volume Control Button

Press the top or bottom of the volume button to raise or lower the volume of the active speaker. Lower the volume all the way down to turn off the volume and enable vibration mode.

The I/O Connector

The I/O connector powers the terminal, charges the main battery, and facilitates communication. Dolphin 75e peripherals are designed to work exclusively with this connector. The I/O connector supports low, full, and high speed USB v2.0 communication with a maximum rate of 480 Mbps.

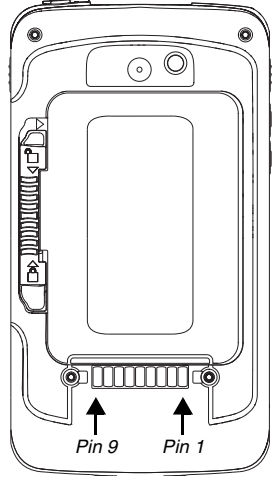
Pin	Signal	Description	Terminal Back Panel
1	VDC_IN	5V DC input for charging and operation	
2	VBUS_HOST	5V output for USB host and peripheral power	
3	USB_DM_HOST	USB D- for the host port	
4	USB_DP_HOST	USB D+ for the host port	
5	USBC_DET	Multipurpose pin to allow for detection of an unpowered SLED, determine SLED type, and to signal a HomeBase the docking of the terminal.	
6	GND	Ground connection	
7	USB_DN_DOCK	USB D- for the client port	
8	USB_DP_DOCK	USB D+ for the client port	
9	VBUS_DOCK	5V input for USB client (and charging)	

Note: Signals referenced are for a DTE device.

Battery

The primary power source for the Dolphin terminal is the 3.7V Li-ion rechargeable battery located under the battery door on the back panel of the device. Honeywell recommends, you keep the battery in the terminal charged at all times to help prevent data loss. Letting the battery become fully discharged causes the terminal to lose all data in RAM.

Note: All data in RAM is cleared when the battery is removed. Always power off the terminal before removing the battery to ensure any changes made are saved to the flash memory.

Replacement Battery Specifications

Dolphin 75e model terminals are designed for use with battery part numbers BAT-STANDARD-02 (Li-ion 3.7V, 6.179 watt hour) and BAT-EXTENDED-02 (Li-ion 3.7V, 12.358 watt hour) manufactured for Honeywell International Inc. See page 2-10 for battery replacement instructions.

Important Battery and Battery Door Replacement Guidelines

Follow the guidelines listed below when ordering batteries and/or battery doors.

- Size (e.g., standard or extended): The battery and battery door must be the same size.
- Type (e.g., locking or non-locking): The battery and battery door must match your terminal type. See details above. Replacement kit numbers 70e?
- Near Field Communication (NFC) requirements: Use only NFC compatible battery doors with NFC equipped Dolphin models identified with a letter N at the end of the model number (e.g., 75exxN).



We recommend use of Honeywell Li-ion battery packs. Use of any non-Honeywell battery may result in damage not covered by the warranty.

Important: All battery and connector doors must be present, undamaged, and properly closed to maintain the environmental rating of the terminal.

Charging Options

Dolphin 75e terminals ship with the battery significantly discharged of power. Before using a terminal for the first time, charge the battery with a Dolphin charging device for a minimum of **4 hours** for the standard battery and **6 hours** for the extended battery. When using the 70e-USB Charge/Communication cable to charge from a 500mA USB port on a host device, charge the battery for a minimum of **6 hours** for the standard battery and **8 hours** for the extended battery.

When the main battery is installed in the terminal, use one of the following:

- [Dolphin 70e Black HomeBase \(Model 70e-HB\)](#), see page 9-1
- [Dolphin 70e Black eBase \(Model 70e-EHB\)](#), see page 10-1
- [Dolphin 70e Black Mobile Base \(Model 70e-MB\)](#), see page 11-1
- [Dolphin 70e Black ChargeBase \(Model 70e-CB\)](#), see page 12-1
- [Dolphin 70e Black Net Base \(Model 70e-NB\)](#), see page 13-1
- Dolphin 70e USB Charge/Communication Cable (Model 70e-USB ADAPTERKIT) included with terminal, [see page 2-3](#)

When the main battery is not installed in the terminal:

- Place the battery pack in the [Auxiliary Battery Well](#) of the [Dolphin 70e Black HomeBase \(Model 70e-HB\)](#) or the [Dolphin 70e Black eBase \(Model 70e-EHB\)](#).
- Insert the battery in the QuadCharger (Model COMMON-QC), [see page 3-1](#).

Charging Time

Charging Peripheral/Accessory	Model: 70e-BTSC	Model: 70e-BTEC
	BAT-STANDARD-02	BAT-EXTENDED-02
HomeBase (Model 70e-HB)	4 hours	6 hours
eBase (Model 70e-EHB)	4 hours	6 hours
ChargeBase (Model 70e-CB)	4 hours	6 hours
Net Base (Model 70e-NB)	4 hours	6 hours
Mobile Base (Model 70e-MB)	4 hours	6 hours
Mobile Charger (Model 70e-MC)	4 hours	6 hours
USB Charge/Communication Cable with provided power supply (Model 70e-USB ADAPTERKIT)	4 hours	6 hours
USB Charge/Communication Cable (Model 70e-USB) connected to a workstation (PC) 500mA USB port	6 hours	8 hours
QuadCharger (Model COMMON-QC)	4 hours	6 hours

Important Charging Guidelines

Source Current Specifications

Battery charging times can be significantly lengthened or charging may not occur if the terminal is drawing more current than is supplied by the charging peripheral (e.g., HomeBase, eBase, Mobile Base, or ChargeBase), USB wall charger, or USB Host (e.g., workstation PC).

- The maximum current supplied through a charging peripheral is 2.0A.
- The maximum current supplied by the USB wall charger is 900mA.
- The maximum current supplied by a USB Host can vary from 100mA to 500mA.
Do not attempt to charge the terminal from a 100mA source. An active Dolphin terminal uses more current than supplied by a 100mA source causing the terminal to continue to draw power from the battery.

*Note: Placing the terminal in **Suspend** mode while charging reduces the current draw of the terminal and shortens the charging time of the battery.*

To verify the battery is charging, touch **All Apps**  > **Settings**  > **Battery**.

Charging a Severely Low or Completely Discharged Battery

Battery Charge Status	Symptom
Severely Low	Pressing the Power button does not wake the terminal from Suspend mode. The general notification LED may flash once when the Power button is pressed.
Completely Discharged	Pressing the Power button does not wake the device and the general notification LED remains off.

Use one of the following options to charge a severely low or completely discharged battery.

- Insert the battery into the auxiliary battery well of the HomeBase. When the auxiliary battery LED on the HomeBase turns green, the battery is fully charged.
- Dock the terminal into the charging well of a peripheral (e.g., HomeBase, eBase, Net Base or ChargeBase). The terminal starts to boot as soon as power is supplied by the base. To prevent the possible loss of unsaved data, do not remove the terminal from the base until the battery has sufficiently charged.

Touch  > **Settings**  > **Battery** to view detailed information on the status of the battery.

- Charge the terminal from a wall power outlet using the USB Charge/Communication Cable and power supply provided with your terminal. As the battery charges, the general notification LED cycles through green, red, amber and off. The LED continues to cycle until the battery reaches a safe charge threshold and the terminal begins to boot. The length of time before the battery reaches a safe charge threshold varies depending on the extent of the battery discharge. If the general notification LED does not start to cycle after approximately 5 seconds when power is applied, press the **Power** button once.
- Charge the terminal from a USB host device (PC) using the USB Charge/Communication Cable. As the battery charges, the general notification LED cycles through green, red, amber and off. The LED continues to cycle until the battery reaches a safe charge threshold and the terminal begins to boot. The length of time before the battery reaches a safe charge threshold varies depending on the extent of the initial battery discharge level and the current supplied by the USB charging source. If the general notification LED does not start to cycle after approximately 5 seconds when power is applied, press the **Power** button once.

Inadequate source current may interfere with effective battery charging; see [Important Charging Guidelines](#) on page 3-10 for additional information.

Managing Battery Power

Letting the battery become fully discharged causes the terminal to lose all data in RAM. Honeywell recommends, you keep a charged battery in the terminal at all times to help prevent data loss. Removing the battery from the terminal erases all non-persistent memory.

When the terminal is running on battery power (as opposed to external power), warnings are displayed when the battery reaches critical and low battery points.

Checking Battery Power and Monitoring Battery Power Use

Touch **All Apps** (⋮) > **Settings** (⚙️) > **Battery** to display information the battery status (charging or discharging), the level (percentage) of charge remaining on the battery, and a breakdown of battery usage statistics for any running apps and services.

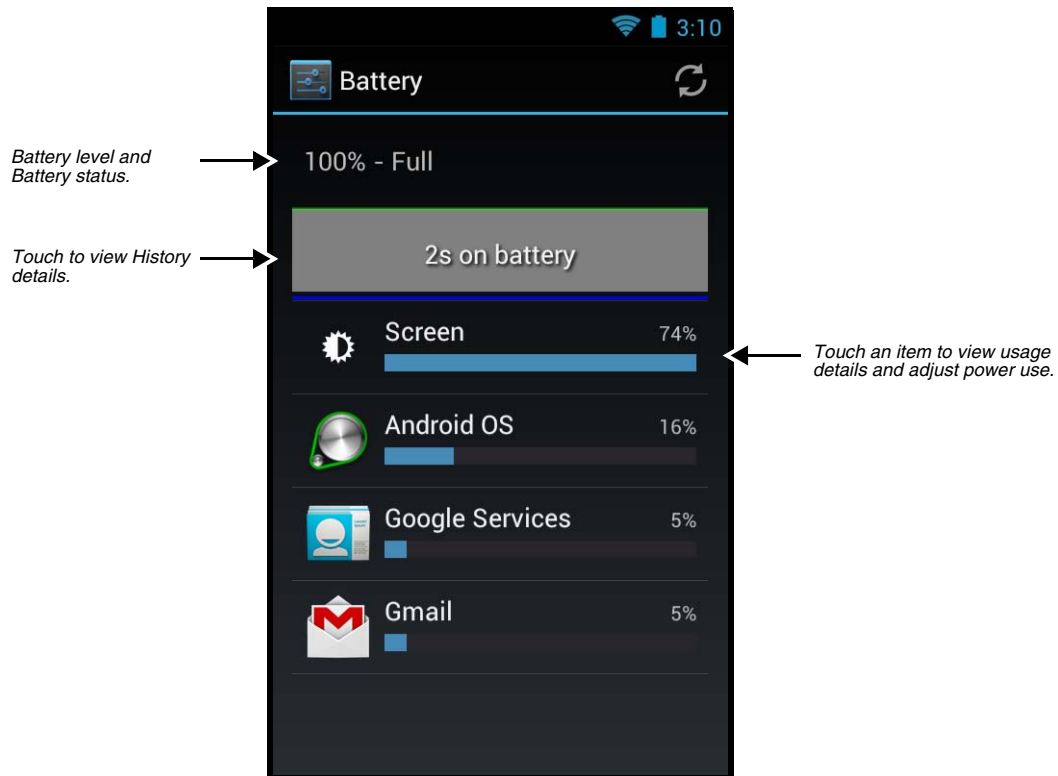

Storing Batteries

To maintain top performance from batteries, avoid storing batteries outside of the following temperature ranges:

- 14°F to 113°F (-10°C to +45°C) for short term storage of less than one month
- 32°F to 86°F (-0°C to +30°C) for long term storage

Do not store batteries in extremely high humidity. For prolonged storage, do not keep batteries stored in a charger that is connected to a power source.

Guidelines for Battery Pack Use and Disposal

The following are general guidelines for the safe use and disposal of batteries:

- Do not disassemble or open crush, bend or deform, puncture or shred.
- Do not modify or remanufacture, attempt to insert foreign objects into the battery, immerse or expose to water or other liquids, expose to fire, explosion or other hazard.
- Improper battery use may result in a fire, explosion or other hazard.
- We recommend use of Honeywell Li-ion battery packs. Use of any non-Honeywell battery may pose a personal hazard to the user.
- Only use the battery for the system for which it is specified. Do not use a battery in any other manner outside its intended use in Dolphin terminals and peripherals.
- Only use the battery with a charging system that has been qualified with the system per standard IEEE-Std-1725-2006. Use of an unqualified battery or charger may present a risk of fire, explosion, leakage, or other hazard.
- Replace the battery only with another battery that has been qualified with the system per this standard, IEEE-Std-1725-2006. Use of an unqualified battery may present a risk of fire, explosion, leakage or other hazard.
- Replace defective batteries immediately; using a defective battery could damage the Dolphin terminal.

- Never throw a used battery in the trash. Promptly dispose of used batteries in accordance with local regulations.
- Do not short-circuit a battery or throw it into a fire; it can explode and cause severe personal injury. Do not allow metallic conductive objects to contact battery terminals.
- If you observe that the Honeywell battery supplied is physically damaged, please send it to Honeywell International Inc. or an authorized service center for inspection, see [Product Service and Repair](#) on page 14-1.
- Battery usage by children should be supervised.
- Avoid dropping the terminal or battery. If the terminal or battery is dropped, especially on a hard surface, and the user suspects damage, send it to a Honeywell International Inc. or an authorized service center for inspection.
- If you are not sure the battery or charger is working properly, send it to Honeywell International Inc. or an authorized service center for inspection, see [Product Service and Repair](#) on page 14-1.
- Excessive discharge can degrade battery performance. Recharge the battery when your terminal indicates low battery power.
- Although your battery can be recharged many times, the battery life is limited. Replace it after the battery is unable to hold an adequate charge.
- The Dolphin 75e should only be connected via its microUSB connector to CTIA certified adapters, products that bear the USB-IF logo or products that have completed, the USB-IF compliance program.

System Resets

See [Resetting the Terminal](#) on page 2-11.

Hardware Maintenance

When needed, clean the image engine window and the touch screen with a clean, non-abrasive, lint-free cloth. The terminal can be cleaned with a damp cloth.

Important: All battery and connector doors must be present, undamaged, and properly closed to maintain the environmental rating of the terminal.

Installing a Memory Card

You can expand the terminal's memory capacity by installing a microSD or microSDHC card. Honeywell recommends the use of Single Level Cell (SLC) industrial grade microSD or microSDHC memory cards with Dolphin terminals for maximum performance and durability. Contact a Honeywell sales representative for additional information on qualified memory card options.

Note: Format memory card before initial use.

Installation and/or Replacement

To install a memory card:

1. **Power Off** the terminal.
2. Unlock and remove the battery door.

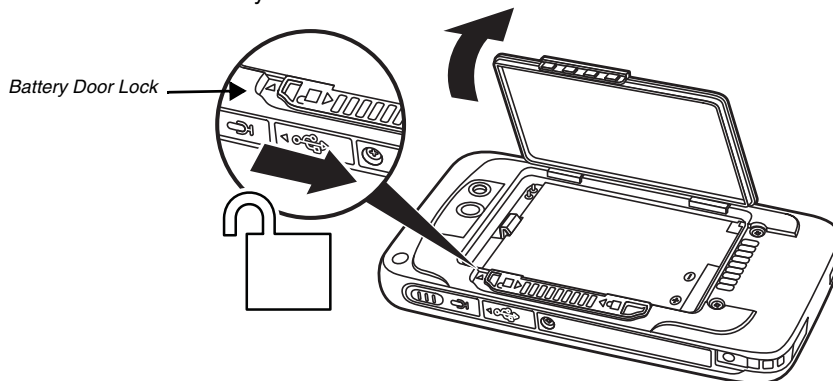

3. Pull the battery latch back and remove the battery.

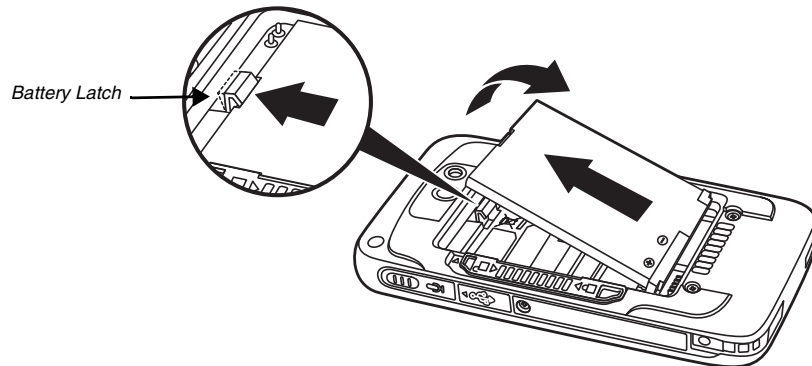

4. Lift the card retention flap, slide the memory card (contacts facing down) into the socket, and then close the retention flap.

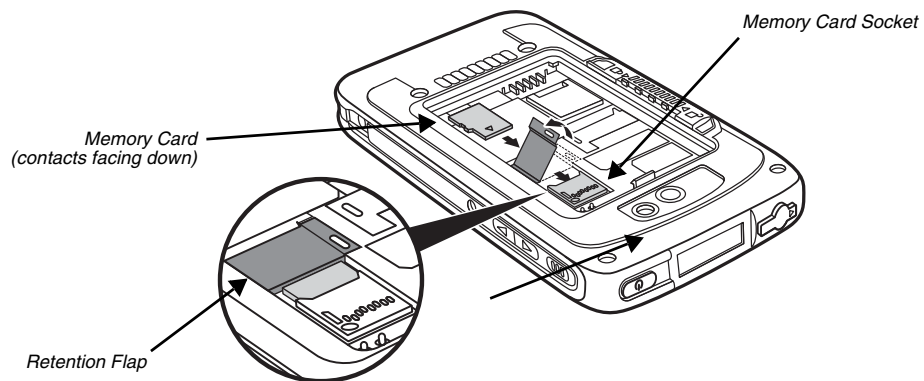

5. Install battery and battery door. Apply pressure to the edges of the battery door to ensure the door is properly closed, and then engage the door lock.

6. Press the **Power** button .

Using the Scan Image Engine

Overview

The Dolphin 75e terminal houses a compact image engine that instantly reads popular 1D and 2D bar codes and supports omni-directional aiming and decoding for greater flexibility in real-world settings. The image engine can also capture black and white digital images, such as signatures and pictures of damaged inventory.

With the latest CMOS-based technology, the engine works like a digital camera and enables black and white digital image capture, signature capture, and reading of OCR characters.

LED Safety

See [Canadian Compliance, Conformité à la réglementation canadienne](#) on page 1-2.

Image Engine Specifications

Field of View

Horizontal Field Angle (°) 21.9+/-0.5 degree

Vertical Field Angle (°) 15.9+/-0.5 degree

Depth of Field

The depth of field measurements used the following parameters:

- Distances are measured from the front of the engine.
- +23°C (+73°F), 0 lux
- Photographic quality codes

Symbology	Distance (in/cm) Near	Distance (in/cm) Far	Delta (in/cm)
3 mil C39/128	-	-	-
5 mil C39/128	2.25 (5.7)	4.35 (11.049)	2.1 (5.3)
7.5 mil C39/128	1.25 (3.2)	6.87 (17.4)	5.62 (14.3)
10 mil C39/128	0.67 (1.7)	9.93 (25.2)	9.26 (23.5)
15 mil C39/128	1.01 (2.6)	15.16 (38.5)	14.15 (35.94)
20 mil C39/128	1.80 (4.57)	18.56 (47.14)	16.76 (42.57)
100% 13 mil UPC	1.57 (3.9)	12.18 (30.9)	10.61 (26.9)
5 mil PDF417	-	-	-
6.7 mil PDF417	1.53 (3.8)	4.63 (11.7)	3.1 (7.8)
10 mil PDF417	1.38 (3.5)	7.34 (18.6)	5.96 (15.1)
5 mil microPDF	-	-	-
5 mil DataMatrix	-	-	-
10 mil DataMatrix	1.52 (3.8)	4.87 (12.3)	3.35 (8.5)
20 mil DataMatrix	1.07 (2.7)	9.66 (24.5)	8.59 (21.8)
10 mil QR	1.50 (3.8)	5.13 (13.0)	3.63 (9.2)
20 mil QR	2.48 (6.3)	9.66 (24.5)	7.18 (18.2)
32 mil Maxicode	1.56 (3.9)	13.19 (33.5)	11.63 (29.5)

Supported Bar Code Symbolologies



Symbology Type	Symbology Name
1D Symbolologies	Codabar Code 3 of 9 Code 11 Code 32 Pharmaceutical (PARAF) Code 93 Code 128 EAN with Add-On EAN with Extended Coupon Code EAN-8 EAN-13 GS1-128 GS1 Databar Interleaved 2 of 5 ISBT 128 Matrix 2 of 5 MSI Plessey Straight 2 of 5 IATA Straight 2 of 5 Industrial Telepen Trioptic Code UPC with Add On UPC-A UPC-E
2D Symbolologies	Aztec Codablock A Codablock F Data Matrix GS1 Databar MaxiCode Micro PDF PDF417 QR Code
Composite Codes	UPC/EAN UCC/EAN GS1 Databar
OCR	MICR E 13-B OCR-A OCR-B
Postal Codes	Postnet and most international 4-state codes Australian Post British Post Canadian Post China Post

Decoding

The terminal supports image decoding for use in various bar code reading and imaging applications. Full-area imaging provides omni-directional reading of linear and non-linear 1D and 2D bar codes, OCR, signature capture, and picture taking. When reading all bar code types using full-area imaging, a positive read can be obtained from many positions; see [Aiming Beam](#) on page 4-6. To achieve the best read, the aiming beam should be centered horizontally across the bar code.

Using the Scan Demo to Decode a Bar Code

The Scan Demo demonstrates the functionality of the integrated scan image engine in the terminal and is not intended as a functional business solution. Detailed information on how to create custom applications for your Dolphin terminal is provided in the *Software Development Kit (SDK)*, available for download at www.honeywellaidc.com.

1. Touch **All Apps**  > **Demos**  > **Scan Demo**  to open the Scan Demo application.
2. Point the Dolphin terminal at the bar code. For optimum performance, avoid reflections by scanning the bar code at a slight angle.
3. Touch and hold **Scan** or press and hold the **Scan** button. Center the aiming beam over the bar code; see [Aiming Beam](#) on page 4-6.

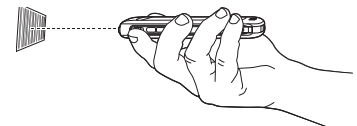

Note: By default, the left and right side buttons also trigger the scan/imager.

4. The bar code is decoded and the results appear on the screen.

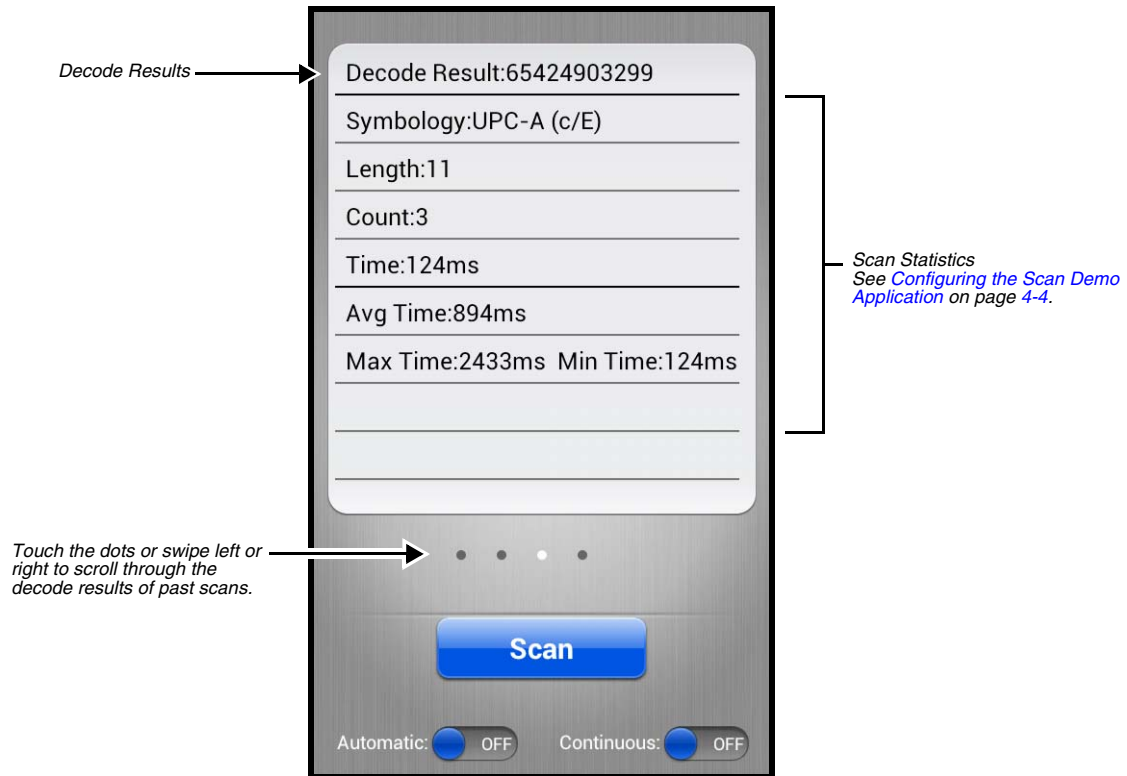

Automatic Scanning

Enable **Automatic** scanning mode to activate the imager for continuous scanning without requiring the operator to touch **Scan** for each bar code presented in the field of view of the imager. To configure the time interval between scan attempts, see **Auto Scan Delay** under [Configuring the Scan Demo Application](#) (page 4-4).



1. Slide the Automatic blue button to the **ON** position to enable the feature.
2. Touch **Scan** or press the **Scan** button to activate the imaging engine. Once activated, the imager automatically scans and decodes bar codes presented in the field of view.
3. Touch **Scan** or press the **Scan** button to deactivate the imager.
4. Slide the Automatic blue button to the **OFF** position to disable the feature.

Continuous Scanning

Enable **Continuous** scanning mode to activate the imager for continuous scanning only when the operator touches and holds **Scan** or presses and holds the **Scan** button. The time interval between scan attempts is minimal and not configurable.

1. Slide the Continuous blue button to the **ON** position to enable the feature.
2. Touch and hold **Scan** or press and hold the **Scan** button to activate the imaging engine. The imager scans and decodes bar codes presented in the terminal's field of view as long as Scan or the **Scan** button is pressed.
3. Release **Scan** or the **Scan** button to deactivate the imager.
4. Slide the Continuous blue button to the **OFF** position to disable the feature.

Configuring the Scan Demo Application

1. Open the **Scan Demo** application, and then press the **Menu** button .
2. Touch **Setting**  or **Symbology Setting** .

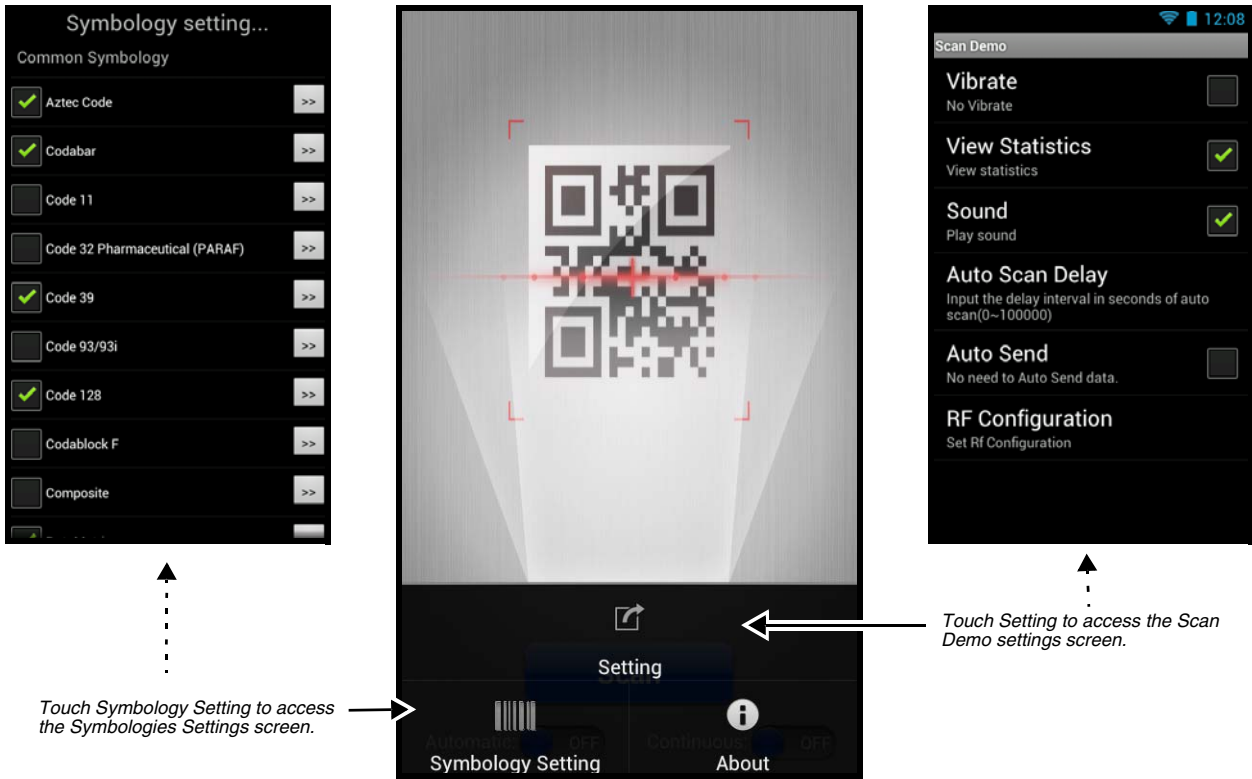

3. Modify the settings to meet your application needs, and then press the **Back** button  to return to the Scan Demo screen.

Settings

Touch the checkbox to enable or disable a feature.

- **Vibrate** - When checked, the terminal vibrates to indicate a successful bar code scan and decode.
- **View Statistics** - When checked, scan results displayed include the length of bar code, the number of scans completed, the number of milliseconds (ms) to decode the bar code, the average decode time of all the bar codes decoded, the shortest decode time of all bar codes decoded, and the longest decode time of all bar codes decoded.
- **Sound** - When checked, the terminal emits sound to indicate a successful or failed scan attempt.
- **Auto Scan Delay** - Program the number of seconds between scan attempts by tapping the menu arrow, and then entering the delay interval in second. The value should be greater than 0 and less than 100000. Touch **OK** to save.
- **Auto Send** - When checked, decoded data is sent to a designated server.
- **RF Configuration** - Touch to view and/or edit the Server IP address and the Port used for RF communication. When the **Back** button is pressed, the terminal attempts to establish communication.

Symbology Settings

Touch the box next to the symbology name to toggle the symbology on (enabled) or off (disabled). A green check mark indicates the symbology is enabled.

Note: Swipe up or down with your finger or stylus on the screen to scroll up or down the list of available symbologies.

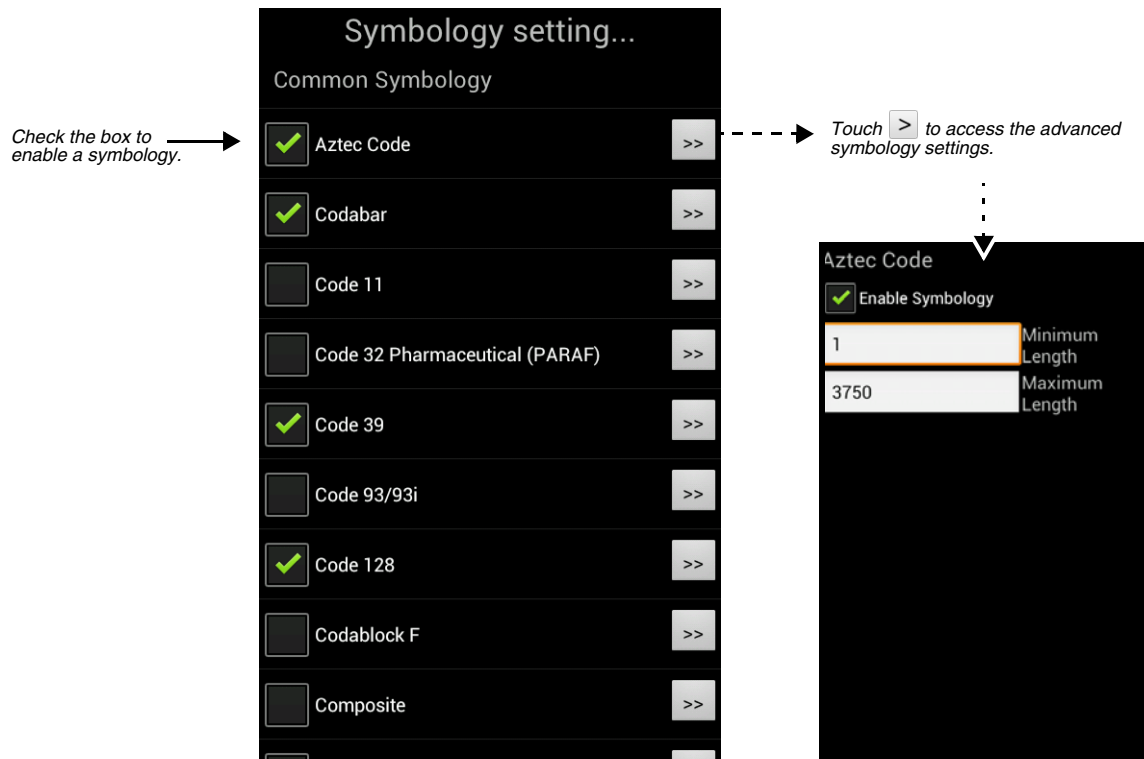

Using the ScanTool Power Tool

Note: Detailed information on the ScanTool Power Tool is provided in the Dolphin Power Tools for Mobile Devices Powered by Android™ User's Guide, available for download at www.honeywellaidc.com.

1. Touch **All Apps** > **Power Tools** > **ScanTool** .
2. Touch one of the Quick Start applications.

Quick Start Application	Description
Activity result	Scan and decode bar codes
Show result	Scan, decode, and view the results (i.e., bar code type and value)
Send via SMS	Scan, decode, and send the results via SMS
Send via MMS	Scan, decode, and send the results via MMS
Send via email	Scan, decode, and email the results
Send to application	Quick start an application by scanning a barcode
Settings	Modifies the imager symbology settings
About	Displays ScanTool version and copyright information

3. The device automatically scans and decodes the bar code when the application is selected.

Symbology Settings Menu

1. Touch **All Apps** > **Power Tools** > **ScanTool** > **Settings**.
2. Touch the box next to the symbology name to toggle the symbology on (enabled) or off (disabled). A green check mark indicates the symbology is enabled.

Note: Swipe up or down with your finger or stylus on the screen to scroll up or down the list of available symbologies.

3. Touch the arrow box to view and modify the advanced settings (e.g. suffix, prefix, minimum and maximum length) for the symbology.

Aiming Beam

The aiming beam is smaller when the terminal is held closer to the code and larger when it is farther from the code. Symbologies with smaller bars or elements (mil size) should be read closer to the unit whereas symbologies with larger bars or elements (mil size) should be read farther from the unit.

Linear Bar Code.



2D Matrix Symbol



Capturing Images

The image-capture process is an intuitive, split-second operation for experienced users. By following the basic guidelines, new users can easily develop their own technique and, with practice, quickly learn to adapt it to different application environments.

Image Preview: When the imaging process is initiated, the touch screen displays a preview of the object. This is a live video image of what the imager is currently viewing. The live video image has a slightly degraded appearance compared to the captured image. This is normal.



File Formats: File formats supported for image storage include JPEG (JPG) and Portable Network Graphics (PNG). The default file format for images is a grayscale JPG.

Compression: Digital images have a maximum image size of 832 x 640 pixels and may have up to a 256 grayscale image definition. The image quality and related file size are determined by the data compression method used by the software application used to take images. The average size of the image file is approximately 400–800K. However, the size of the image depends on the content of the image - the more complex the content, the larger the file size.

Taking an Image with the Imaging Demo

The Imaging Demo demonstrates the functionality of the integrated scan image engine in the terminal and is not intended as a functional business solution. Detailed information on how to create custom applications for your Dolphin terminal is provided in the *Software Development Kit (SDK)*, available for download at www.honeywellaidc.com.

To capture an image using the Imaging Demo application:

1. Touch **All Apps**  > **Demos**  . Swipe left to scroll to the **Imaging Demo**, and then touch  .

2. Point the Dolphin terminal at the object.

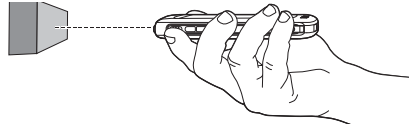

3. Adjust the terminal's position until the object appears on the touch screen the way you want it to appear in the image.

Note: Touch the  to toggle the targeting cross hair on the touchscreen on or off.

4. Touch  or press the **Scan** button to capture the image.

5. To save the captured image, press the **Menu** button.

6. Touch **File**, and then either select:

- **Save** to save the image to the default location (mnt/sdcard/honeywell/imagedemo)

OR

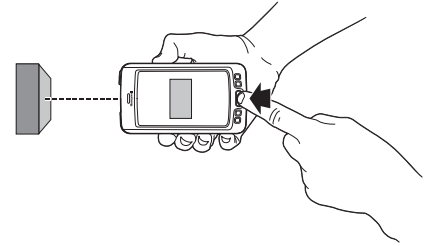

- **Save As** to select a different location to save the image.



Using the IQ Image Demo to decode intelligent bar codes and capture images

Decode an intelligent bar code, insert the data into predefined data fields, and capture an image of the bar code using the **IQ Image Demo**. The demo includes four format options: **Delivery**, **Postal**, **Embed**, and **No format**. Each format is designed to decode data from bar codes specifically coded to match the format of the option screen.

Note: The IQ Image Demo demonstrates the functionality of the integrated scan image engine in the terminal and is not intended as a functional business solution. Detailed information on how to create custom applications for your Dolphin terminal is provided in the Software Development Kit (SDK), available for download at www.honeywellaidc.com.

1. Touch **All Apps**  > **Demos** . Swipe right to scroll to the **IQ Image Demo**, then touch .

2. Touch one of the four format options: **Delivery**, **Postal**, **Embed**, or **No format**.

3. Point the Dolphin terminal at the intelligent bar code.

4. Touch **Scan** or press the **Scan** button.

5. The decode results (e.g., Tracking Number and Address embedded in the bar code) automatically populate the fields on the screen.

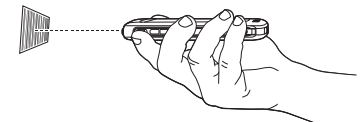

Note: You don't need to clear the field to take another scan, just activate the image engine again.

6. Press the **Menu** button, and then tap **File** to save an image of the scan or bar code. The file is saved in the mnt/sdcard/honeywell/iqdemo folder on the microSD card.

Configuring the IQ Image Demo Application

1. Open the **IQ Image Demo** application, and then touch one of the four configuration options (i.e., Delivery, Postal, Embed or No format).



2. Press the **Menu** button.

3. Touch **Setting**  to access and modify the following options:

- Select **Symbology** to configure the type of symbologies you want the IQ Imaging Demo to decode. Touch the symbology's checkbox to enable or disable the symbology. Press the back button to return to the IQ Imaging screen.
- Select **Image Type** to choose Binary or Grayscale.
- Select **Sound** to toggle audible feedback on or off for successful scans.

Using the Signature Demo

The Signature Demo captures a signature on the touch screen.

1. Touch **All Apps**  > **Demos**  . Swipe right to scroll to the **Signature Demo**, then touch  .
2. Using a finger or the optional stylus, sign the touch screen.

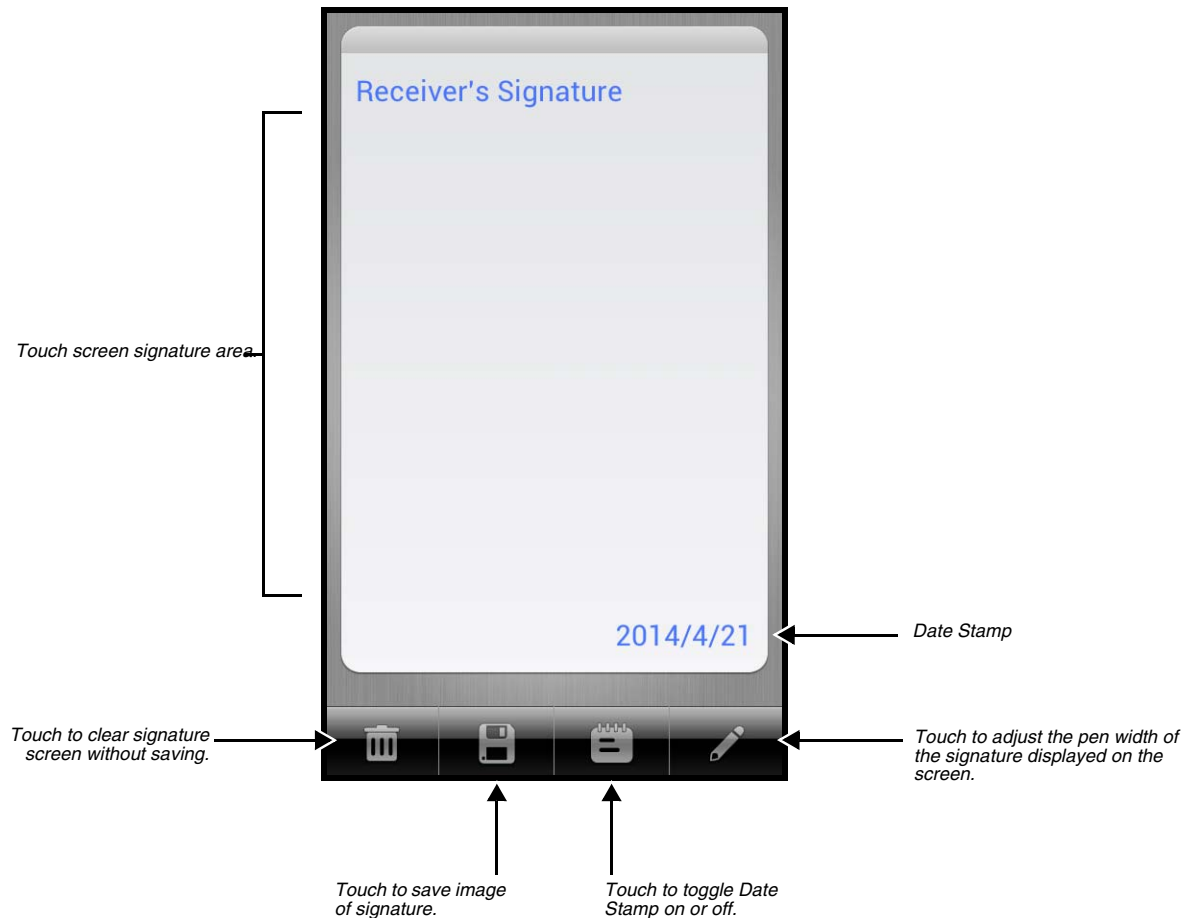

3. Touch  .
4. Enter a **name** for the of the image file you want to save, and then select the file type: **JPG** or **PNG**.
5. Touch **Save**. The signature image file is saved in the mnt/sdcard/honeywell/signaturedemo folder on the microSD card.

Uploading Images

Image files can be uploaded to a host workstation using a USB connection, [see page 2-12](#).

Using the Color Camera

Overview

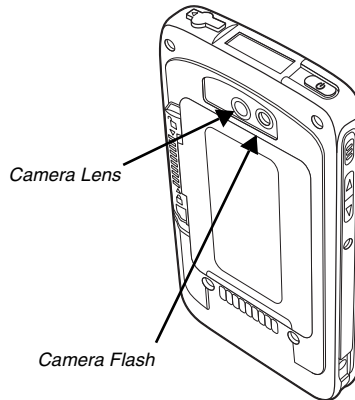

Dolphin 75e terminals are equipped with 8.0-Megapixel auto focus cameras to provide easy integration of color picture and video capture into business applications. The camera lens and camera flash are located on the back panel of the terminal.



Pictures and videos captured using the **Camera app** are stored on the microSD card in the DCIM folder under Camera (mnt\sdcard\DCIM\Camera). You can copy your pictures and videos to a computer (see page 2-12) or view, edit, and share your pictures and videos using the **Gallery app**.

Opening the Camera app and Adjusting the Settings

To open the **Camera app**, do one of the following:

- If the slider screen lock is activated, drag the lock icon  to the **Camera icon** .



OR

- Touch the **Camera**  icon on the **Home screen**.



If the Camera app does not initialize, verify ScanWedge is disabled.

Adjusting the Camera/Video Settings

The camera/video settings are adjustable from within the **Camera app**.

- Use the slider bar to adjust the zoom in (+) or out (-).
- Touch  to adjust: White balance, Flash, Exposure for pictures, and Time lapse interval for videos.
- Touch  then  to: set the Picture size (pixels), set the Focus mode, enable or disable storing the location in the picture/video file, or to restore the camera defaults.



Taking a Picture

1. Open the **Camera**  app (see page 5-1).
2. Verify  is selected.
3. Center the object you want to take a picture of on the live preview screen.
4. Touch  to capture the picture.

*Note: Touch the thumbnail preview to access options to share the picture. Select the picture again to open the **Gallery** app where you can edit or delete the picture by pressing the **Menu** button.*

6. Press the **Back** button  to close the app.





Taking a Panoramic Picture

1. Open the **Camera**  app (see page 5-1).
2. Touch  to switch to panorama mode.
3. Point the camera lens at the beginning of the scene you want capture.
4. Touch  to start capturing the picture. Slowly sweep the camera lens across the scene using the touchscreen preview as a guide.

*Note: Touch the thumbnail preview to access options to share the picture. Select the picture again to open the **Gallery** app where you can edit or delete the picture by pressing the **Menu** button.*

7. Press the **Back** button  to close the app.

Recording Video

1. Open the **Camera**  app (see page 5-1).
2. Touch  to switch to video mode.
3. Point the camera lens at the scene or object you want to capture in video.
4. To start capturing video, touch .
5. Use the slider bar to zoom in (+) or out (-) while recording.
6. To stop capturing video, touch .

*Note: Touch the thumbnail preview to access options to share the video. Select the video again to open the **Gallery** app where you can delete the video by pressing the **Menu** button and selecting **Delete**.*

7. Press the **Back** button  to close the app (see page 5-1).



Uploading Pictures and Videos

Picture and Video files can be uploaded to a computer using a USB connection. For additional information, [see page 2-12](#).

Settings

Overview

The Settings allows you to verify and/or alter system parameters to customized your terminal to meet your specific needs. Touch

All Apps  > **Settings**  or pull down the notification panel, and then touch the **Settings** icon  next to the date.

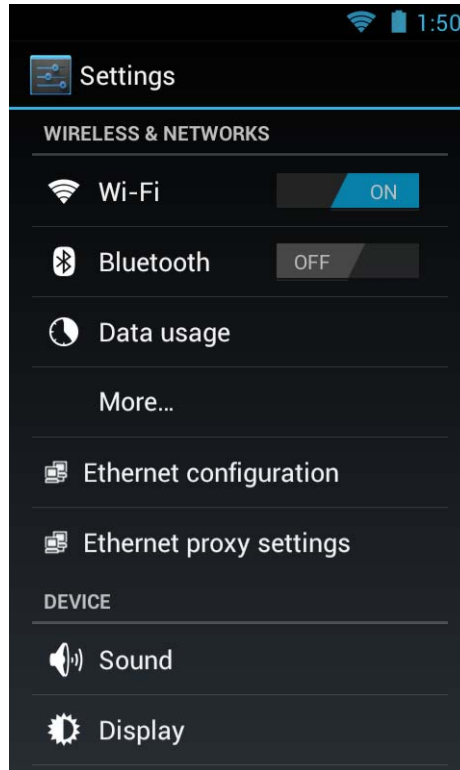

Wireless & Network Settings

See "Wireless & Networks Settings" on page 7-1 and [Establishing Ethernet Communication](#) on page 10-6.



Device Settings

Sound Settings

Touch **Sound** from the **Settings**  screen then select the configuration setting you want to modify.

- **Volumes** - Set the volume level used for music, videos, games, other media, ring tones, notifications, and alarms.
- **Silent Mode** - Turn silent mode on or off, enable vibration feedback, or mute audio output.
- **Ringtone & Notifications** - Set the phone ringtone, default sound for notifications, and turn vibration on or off for incoming calls.
- **System** - Set sound and vibration feedback during touch screen interaction.

Display Settings

Touch **Display** from the **Settings**  screen to set the touch screen **Brightness** level, **Wallpaper**, turn **Auto-rotate screen** on or off, adjust the touch screen **Sleep** settings, set the on screen **Font size**, and enable or disable some **Power** button  functions.



Auto-rotate screen

By default, the display automatically adjusts the orientation of the screen between landscape and portrait when the terminal is rotated. Touch the **Auto-rotate screen** checkbox to toggle the option on or off.



Sleep

The **Sleep** setting enables you to customize backlight functionality for the display. Select how many minutes or seconds you want to elapse before the backlight automatically turns off and the terminal enters **Suspend** mode (see page 2-9).

Show System Dialog

By default, the **Phone Options** menu displays when you press and hold the **Power** button . To disable access to the **Phone Options** menu using the **Power** button , uncheck the box next to **Show System dialog**.

Power Key

By default, the terminal can be placed into **Suspend** mode (see page 2-9) by briefly pressing the **Power** button . To disable entering **Suspend** mode using the **Power** button , uncheck the box next to **Power Key**.

Phone Options Menu

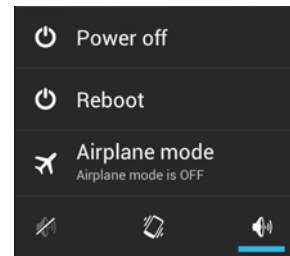

Unattended mode

By default, the Wi-Fi radio is turned off when the terminal enters **Suspend** mode to reduce battery use and increasing time between charge cycles. To keep the Wi-Fi radio on when the terminal enters **Suspend** mode, uncheck the box next to **Unattended mode**.

Honeywell Smart Sensors Settings

Touch **Honeywell Smart Sensor** from the **Settings**  screen to configure the integrated motion detection sensors for advanced power management.

- **Keep awake on motion** - When enabled, the terminal is prevented from entering **Suspend** mode when motion is detected. By default, this option is disabled.
- **Wake on motion** - When enabled, the terminal wakes from **Suspend** mode when motion is detected. By default, this option is disabled.
- **Face down suspend** - When enabled, the terminal enters **Suspend** mode when placed face down on a flat surface. By default, this option is disabled.

Storage Settings

Touch **Storage** from the **Settings**  screen to view use and space statistics for the internal storage on the terminal and the installed SD card. Two additional options: **Unmount SD card** for safe SD card removal and **Erase SD card** for erasing all data on the installed SD card are also available from the **Storage** screen.

Battery Settings



See "Managing Battery Power" on page 3-10.

Apps Settings

Touch **Apps** from the **Settings**  screen to view, evaluate, and modify how applications installed on the terminal or SD card utilize memory and storage resources.

Note: You can also reach the **Apps** screen from the Home screen by pressing the **Menu** button, and then selecting **Manage apps**.

Touch the tabs at the top of the **Apps** screen to view lists organized into four categories:

- **Downloaded**
Displays all apps downloaded to the terminal.
To sort the list, press the **Menu** button , and then touch **Sort by size** or **Sort by name**.
 - **On SD Card**
Displays only apps designed to be stored either on the SD card or on the internal storage of the terminal. A green checkmark indicates the app is stored on the SD card. Apps that prohibit movement do not appear on the list.
 - **Running**
Displays application processes and services running on the terminal and cached background processes. Touch **Show cached processes** or **Show running services** at the bottom of the screen to switch between the lists.
 - **All**
Displays all apps stored either on the SD card or on the internal storage of the terminal.
To sort the list, press the **Menu** button , and then touch **Sort by size** or **Sort by name**.
- Displayed at the bottom of each category screen is the memory or storage type, the amount of storage or memory used by the listed applications, and the amount of free space remaining.

Managing Apps

The **App info** screen contains detailed statistics on an app including the amount of storage or cache utilized, default launch settings, and access permissions granted to the app. Statistics useful when troubleshooting slow terminal performance, low memory issues, or an unresponsive application. The **App info** screen also provides access to perform the following actions:

- force stop the app,
- uninstall the app,
- move the app to either the SD card or phone (limited by app permissions),
- clear stored data,
- clear cache, or
- clear any Launch by default settings assigned to the app.

To access the **App info** screen, touch the app name on the list displayed under the **Downloaded** or **On SD Card** tab on the **Settings > Apps** screen.

Uninstall Applications

1. Press the **Menu** button  from the Home screen, and then touch **Manage apps**.
2. Touch the application you want to uninstall.
3. Touch **Uninstall**, and then **OK** to confirm.

Move Applications

1. Press the **Menu** button  from the Home screen, and then touch **Manage apps**.
2. Touch the **On SD Card** tab.
3. Touch the application you want to move.

Note: A green checkmark indicates an application is stored on the SD card.

4. Touch **Move to SD card** or **Move to phone** to move the application.

Note: Applications moved to the SD card still require the use of a minimal amount of internal storage on the terminal.

Stop Application Processes or Services



1. Press the **Menu** button  from the Home screen, and then touch **Manage apps**.
2. Touch the **Running** tab.
3. Touch the cached background process or running service you want to stop.
4. Touch **Stop**.

Personal Settings

Accounts & sync



Touch **Accounts & sync** from the **Settings** screen to add, remove, and manage exchange accounts (e.g., e-mail) and allow apps to automatically schedule and sync data.

To add an account:

1. Touch **All Apps**  > **Settings**  > **Accounts & Sync**.
2. Touch **Add account**.
3. Touch the type of account to add.
4. Follow the on-screen instructions to enter the required information for the account type selected. You may need to provide a user name and password, select security settings, and configure data sync preferences during the setup.
5. The account appears on the **Accounts & Sync** list when setup is complete. Depending on the settings you selected during the account configuration, your terminal may automatically start to sync account data (e.g., email, contacts, music and calendar).

Note: Touch the account name on the list to view **Data & Synchronization** settings.

To remove an account:

1. Touch **All Apps**  > **Settings**  > **Accounts & Sync**.
2. Touch the account to delete.
3. Press the **Menu** button , and then select **Remove account**.
4. Touch **Remove account** to confirm deletion.

Security

Touch **Security** from the **Settings**  menu to manage terminal security parameters (e.g., authorization for device administration, setup a screen lock, setup a SIM card PIN, enable/disable visible passwords, load security certificates, and setup a password to protect the terminal's credential storage).

Screen Security

The **Screen Lock** settings provide access to additional security features that enable you to prevent an unauthorized person from unlocking the touch screen and accessing the terminal. Select from five security options: **None**, **Slide**, **Pattern**, **PIN** or **Password**.

- To enable a screen lock:
Touch on **Pattern**, **PIN** or **Password** to access additional dialogue screens that step you through setting up or updating the security feature.
- To disable a screen lock:
Touch **Security** from the **Settings** screen. Select **Screen Lock**, and then enter your existing Pattern, PIN, or Password. Touch **Next** and then select **None** to remove the security setting.

Once you have established a screen lock, additional settings may appear under the **Screen Security** heading depending on the type of security you implemented. The additional settings allow you to adjust the time increment for the screen to **Automatically lock** after entering Suspend (sleep) mode and enable or disable **Vibration on touch** during security input.

The **Owner Info** setting allows you to designate custom text you want displayed on the lock screen. You can also disable owner information from displaying.

Encryption

You can encrypt all the data on your Dolphin terminal using the **Encrypt phone** option as an advanced security measure in case your device is ever lost or stolen. When the terminal is encrypted, you must enter a numeric PIN or password each time you turn the power on. The **Screen Lock** PIN or password you set up is the same PIN or password used for encryption security and cannot be set independently.

Warning: You cannot reverse encryption. The only way to revert back to an unencrypted state is to perform a factory reset, which erases all your data.

SIM card lock

Touch **Set up SIM card lock** to establish or modify a SIM card PIN so unauthorized individuals cannot use the terminal as a phone or modify data on the SIM card.

Passwords

Touch the **Make passwords visible** checkbox to toggle between hiding or showing passwords as you type.

Device Administration

The **Device administrators** screen lists all applications that have been given authorization to act as a device administrator, which is often required when you set up accounts that synchronize data between the terminal and an enterprise service. An enterprise service implements security policies on the terminal before allowing a connection (e.g. passwords and certificates). Touch **Device administrators** from the **Security** screen, and then touch the application name if you want to remove authorization for the app to act as a device administrator for the terminal.

Check the **Unknown sources** box to allow the installation of non-market applications. This setting is disabled by default.

Credential Storage

*Access options that help you manage your Wi-Fi network and/or Virtual Private Network (VPN) security certificates under the **Credential storage** heading at the bottom of the **Security** settings screen.*

Note: Android supports DER-encoded X.509 certificates saved with a .crt or .cer file extension and X.509 certificates saved in PKCS#12 key store files with a .p12 or .pfx file extension.

Trusted credentials

Touch **Trusted credentials** from the **Security** screen to view all the security credentials installed on the terminal. Tabs organize the certificates into two categories: **System** and **User**. Touch the certificate name to view additional details about the certificate.

To disable a system certificate or remove a user certificate:

1. Touch the certificate name from the **Trusted credentials System** or **User** list.
2. Scroll to the bottom of the Security certificate details screen.
3. Touch **Disable** or **Remove** depending on the type of certificate you are viewing.

Note: System certificates can be Enabled using the same method at a later date but User certificates are permanently deleted.



4. Select **OK**.

Install from SD Card

To install encrypted certificate from the SD card installed in the terminal:

1. Copy the certificate from the host device (computer) to the root directory of the SD card.

Note: Ensure your certificates are saved with the correct file extension. Android supports DER-encoded X.509 certificates saved with a .crt or .cer file extension and X.509 certificates saved in PKCS#12 key store files with a .p12 or .pfx file extension.

2. Touch **All Apps**  > **Settings**  > **Security** > **Credential Storage**.
3. Touch **Install from SD card**.
4. Touch the file name of the certificate to install and enter a password if required.
5. Touch **OK**.
6. Enter the name of the certificate, and then touch **OK**.

Note: Once an encrypted certificate is installed on the terminal, it is automatically deleted from the SD card.

Language & input

Touch **Language & input** from the **Settings** screen to access options to modify the default language for the display, change the automatic spelling correction settings, manage your personal dictionary, configure keyboard & input methods for text entry, manage speech settings for voice searches and text-to-speech output and set the mouse/trackpad pointer speed.

Language

Touch **All Apps**  > **Settings**  > **Language & input** > **Language**, and then select the language you want displayed on the touch screen.

Spelling Correction

Touch **All Apps**  > **Settings**  > **Language & input** > **Spelling correction** to turn the feature on or off.

Touch  to change the language settings when the feature is turned on.

Personal Dictionary

Touch **All Apps**  > **Settings**  > **Language & input** > **Personal Dictionary** to add, edit, or delete words from your personal dictionary.

Keyboard & Input Methods

The virtual keyboard appears when you open an application or select a field that requires text or numerical input. The content of the keyboard may vary depending on the selected default, the application in use, and the input field requirements.



To modify the default method for entering text, touch **All Apps**  > **Settings**  > **Language & input** > **Default**.

Touch  next to the keyboard name to adjust settings specific for the keyboard type (e.g., Keyboard Skin, Vibrate on Key Press, Sound on Key Press, Show Key Preview, Show Settings Key, and Input Language Preference).

To configure **Text-to-speech (TTS)** settings, touch **All Apps**  > **Settings**  > **Language & input** > **Text-to-speech output**. The settings screen provides access for you to:

- Select and configure the preferred engine used for speech synthesis when you want to hear text read aloud.
- Adjust the Speech rate of the synthesized voice.
- Listen to an example of speech synthesis based on the current settings.

Mouse/Trackpad

Touch **All Apps**  > **Settings**  > **Language & input** > **Pointer Speed** to adjust the sensitivity and speed of the touch screen response to your finger swipe.

Backup & reset

Touch **Backup & reset** from the **Settings** screen to access options for backing up and restoring your data, settings, and account information on the terminal. There are three options available under the **Backup & Restore** heading:

- **Back up my data** - Touch to enable or disable backing up your app data, Wi-Fi passwords, and other settings to Google servers. The **Backup account** and **Automatic restore** options are only selectable if this option is enabled.
- **Backup account** - Touch to configure and sign into the Google account used for backing up your terminal data.
- **Automatic restore** - Touch to enable or disable the automatic restoration of previous app settings and data from the backup server when you reinstalling an app.

System

Date & Time

Touch **Date & time** from the **Settings**  screen to access options to configure the date, time, time zone, time format, and date format displayed on the terminal. You can set the terminal to synchronize the date and time using a network connection by checking the **Automatic date & time** box or you can manually enter the values by touching **Set date**, **Set Time**, or **Select Time zone**.

*Note: If the Automatic option is checked, the **Set date**, **Select Time zone**, and **Set time** menu options are grayed out.*

To modify how the time is displayed on the screen, check the **Use 24-hour format** box to switch from a 12-hour cycle to a 24-hour cycle. In a 24-hour time cycle, 1:00 pm displays as 13:00 pm.

To change the date format displayed on the screen, touch **Select date format**, and then select a format from the list.

Accessibility

Touch **Accessibility** from the **Settings**  screen to configure features that make using the terminal easier for people with certain physical disabilities.

Services

When the **TalkBack** service app is enabled, spoken and vibration feedback help blind and vision-impaired users interact with the terminal. The spoken feedback includes descriptions of what you touch, select, and activate.

To enable or disable the **TalkBack** service app, select **TalkBack** on the Accessibility screen then touch the **ON/OFF** toggle box  in the upper right corner of the screen.

System

Under the **System** heading on the Accessibility screen, additional options are available to enable or disable Large Text, touch screen Auto-rotation, spoken passwords, or ending calls using the Power button . You can also set Touch & hold delay settings and permissions for Installing web scripts.

Developer options

Touch **Developer options** from the **Settings**  screen to access advanced settings used by Android application developers. For information on these settings, Android APIs, and development tools, refer to the Android developer web site at <http://developer.android.com>.

About Phone

The **About Phone** screen displays specific information about the terminal including: Model number, Android OS version, Baseband version, Kernel version, Build number, and RIL version.

Touch **System Updates** to view the last time the Android operating system was updated or to manually initiate an Android update.

Touch **Legal information** to view important information on Open source software licenses.

Touch **Status** to view following terminal information:

- battery status,
- remaining charge level of the battery,
- signal strength,
- service state,
- Wi-Fi MAC address,
- Bluetooth address, and
- serial number.

Note: The content of the About phone and Status screen are base on the terminal model type.

Communication

Wireless & Networks Settings

Under the **Wireless & Networks** heading on the **Settings** screen there are options for turning the onboard wireless radios in the terminal on or off and for configuring network connections.

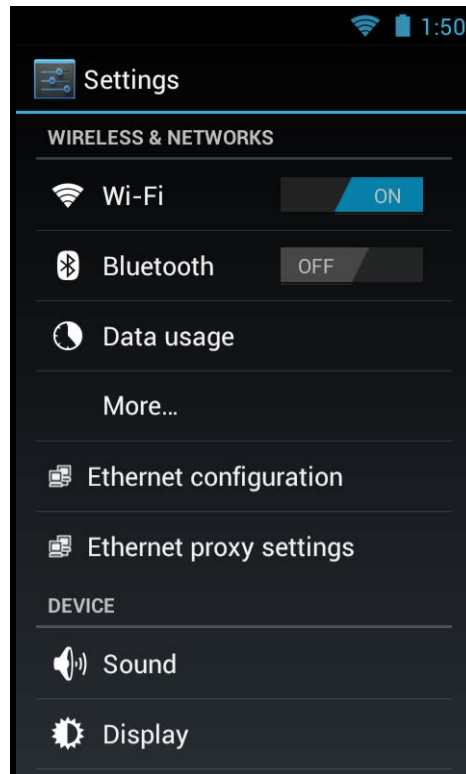

Connecting the Terminal to a Wireless Network

You connect the terminal to a wireless network through the on-board radios (802.11a/b/g/n and/or Bluetooth). Each radio has its own configuration utility and requires specific information about the wireless network to connect. A successful connection depends on your network infrastructure so you may need to consult your network administrator before attempting a connection.

WLAN (802.11a/b/g/n/ac)





The Dolphin 75e has a 802.11a/b/g/n/ac WLAN (Wireless Local Area Network) radio. The radio is interoperable with other 802.11a/b/g/n, Wi-Fi compliant products including access points (APs), workstations via PC card adapters, and other wireless portable devices.

Bluetooth



See "Working with Bluetooth and NFC Technology" on page 8-1.

Wi-Fi Network Connections

Turning Wi-Fi Networking On or Off

1. Touch **All Apps**  > **Settings** .
2. Touch the **Wi-Fi** OFF/ON toggle box to turn the radio  or .

Connecting to a Wi-Fi Network



1. Touch **All Apps**  > **Settings**  > **Wi-Fi**.
2. Verify the Wi-Fi is turned .
3. The terminal searches for available Wi-Fi access points within range of the device. If the terminal previously connected to a Wi-Fi network, it automatically reconnects to the same network.

To remove a Wi-Fi network the terminal previously connected to, touch the network name, and then touch **Forget**, to delete the stored network information.



4. Touch the network name you want to connect to from the available network list.
5. If the network is secured, a dialog box appears requesting information relevant to the network security protocol (e.g., password, key, or certificate). Enter the required information.
6. Touch **Connect**.

Receiving Network Notifications

If Wi-Fi networking is turned On, you can set the terminal to notify you when an open network is available.

1. Touch **All Apps**  > **Settings**  > **Wi-Fi**.
2. Press the **Menu** button , and then touch **Advanced**.
3. Touch the check box to toggle **Network notification** On (checked) or Off.

Adding a Wi-Fi Network

1. Touch **All Apps**  > **Settings**  > **Wi-Fi**.
2. Verify the **Wi-Fi** is turned .
3. Touch **Add Network** located at the bottom of the available Wi-Fi network list.
4. Enter the **Network SSID** (Wi-Fi network name).
5. For secure Wi-Fi network connections, touch **None** under **Security**, and then select the type of security protocol required from the pop-up menu (e.g., **WEP**, **WPA/WPA2 PSK** or **802.1xEAP**).
6. Enter any additional security information required by the type of security protocol selected.
7. Touch **Save**.



Advanced Wi-Fi Settings and Network Utilities

Advanced Wi-Fi Menu

The Advanced Wi-Fi menu provides access to set network notifications, modify Wi-Fi radio activity during Suspend mode, idle timeout settings, or view the terminal MAC address and IP address.

- **Network notification**
Turn on or off available Wi-Fi network notification.
- **Keep Wi-Fi on during sleep**
Set how the Wi-Fi radio reacts when the terminal enters sleep (Suspend) mode (i.e., Always, Only when plugged in, or Never).
- **Wi-Fi idle timeout.**
Adjust how long the Wi-Fi may be idle before the radio is automatically turned off (i.e., 1 minute, 3 minutes, 15 minutes (default), 30 minutes, 1 hour, or 3 hours)
- **MAC address**
- **IP address**

To access the advanced Wi-Fi menu settings:

1. Touch **All Apps**  > **Settings** .
2. Under **Wireless & Networks**, touch **Wi-Fi**.
3. Press the **Menu** button .
4. Select **Advanced**.

Wi-Fi Radio Settings Power Tool

The **Wi-Fi Radio Settings** network utility provides several options for advanced configuration of the Wi-Fi 802.11 radio in the terminal. Select from the five tabs at the bottom of the utility screen to access the following settings:

- **2.4GHz Channel**
Identify the channels to be used for 2.4GHz communication.
- **5GHz Channel**
Identify the channels to be used for 5GHz communication.
- **Roaming**
Enable/disable roaming, adjust the roaming threshold, define the AP Diff value (dBm), set the roaming scan period, or enable/disable Dynamic Frequency Selection (DFS) roaming.
- **Tx Rates**
Identify the Tx Rates (e.g., CCK, OFDM, DMN) to be used.
- **Other**
Modify power save options (i.e., Auto, Short Doze, Long Doze).
Enable/disable Wi-Fi Multimedia Extensions/Quality of Service (WMM/QoS).
Enable/disable Random AP selection and set the Random AP minimum RSSI value.
Specify the Beacon Loss Count.

Touch **All Apps**  > **Power Tools**  > **Wi-Fi Radio Settings** .

Note: Refer to the User's Guide for Dolphin Power Tools for Mobile Devices powered by Android for additional information. Product guides are available for download at www.honeywellaidc.com.

Wireless Manager Power Tool

The **Wireless Manager** network utility provides access to the **Wi-Fi Manager** where you can view and change the status of the terminal radios, scan and add networks, view current access point statistics, select your network firmware and set your hyper roaming preferences.

Touch **All Apps**  > **Power Tools**  > **Wireless Manager** .



*Note: When the **Wireless & Network** screen appears, an arrow  is displayed to the left of the highest priority wireless network connection. To change the priority, touch and hold on the text for the preferred connection, and then select **OK**.*

Touch the **ON/OFF** toggle box () next to the radio name to change the power status.

Touch **Wi-Fi** to access the **Wi-Fi Manager** and:

- Create a Wi-Fi favorites list.

- Scan and add networks.
- View general information on current and scanned access points.
- View detailed information on the current access point and roaming statistics.

Note: On the **Power Tools** screen, select **Connection Manager**  for direct access the manager without opening the **Wireless Manager** .

Note: Refer to the *User's Guide for Dolphin Power Tools for Mobile Devices powered by Android* for additional information. Product guides are available for download at www.honeywellaidc.com.

Airplane Mode

See "Airplane Mode" on page 2-10.

Virtual Private Networks (VPN)

To complete the VPN setup screens, you may need to ask your ISP or network administrator for the proxy server name, server type, port, type of Socks protocol used, and your user name and password if you do not already have the information.

Adding a VPN

1. Touch **All Apps**  > **Settings** .
2. Under **Wireless & Networks**, touch **More** > **VPN**.

Note: VPN connections require you to set a screen lock PIN or password before you can use credential storage. If you have not set either security option, select **OK** on the pop-up notification window, and then set a screen lock PIN or password. Once you complete the process, you are automatically directed back to the VPN screen.



3. Touch **Add VPN network**.
4. Enter the VPN **Name**, and then select the VPN **Type** you want to add. Complete the remaining data fields with the appropriate information for your network. The terminal supports the following protocol types:
 - PPTP
 - L2TP/IPSec PSK
 - L2TP/IPSec RSA
 - IPSec Xauth PSK
 - IPSec Xauth RSA
 - IPSec Hybrid RSA

5. Touch **Save**.

Note: To delete a VPN, touch and hold the network name on the **VPN** screen, and then touch **Delete network**.

To edit a VPN configuration, touch and hold the network name on the **VPN** screen, and then touch **Edit network**. Touch **Save** to retain your changes.

Connecting to a VPN

1. Touch **All Apps**  > **Settings** .
2. Under **Wireless & Networks**, touch **More** > **VPN**.
3. Touch the name of the VPN.
4. Enter any security credentials (e.g., password, user name, certificate information or server name) required by the VPN.
5. Touch **Connect**.

Note: When a VPN connection is established, a  shows in the status bar.

Disconnecting from a VPN

1. Drag the status bar down from the top of the touch screen to view the Notification panel.
2. Touch the VPN connection notification to disconnect.

Ethernet Communication

See "Establishing Ethernet Communication" on page 10-6.

Working with Bluetooth and NFC Technology

Bluetooth Technology

Turning the Bluetooth Radio On or Off

Bluetooth™ is a short-range wireless communications technology used to exchanged data between devices over a distance of approximately 26.2 feet (8 meters). Before you can connect or pair your terminal to another device using Bluetooth technology, you must first turn on the Bluetooth radio.

1. Touch **All Apps**  > **Settings** .
2. Touch the **Bluetooth** OFF/ON toggle box  to turn the radio on . Once the Bluetooth radio is activated, the terminal automatically starts searching for discoverable devices.



Note: System bar icons at the top of the touchscreen indicate the status of the Bluetooth radio.

Pairing and Trusted Devices

The terminal supports pairing with other devices using Bluetooth technology. Pairing happens during general connection setup. Paired devices are “trusted” devices. This means that there is unrestricted access to all services (including services that require authorization and authentication).

Connecting to Other Bluetooth Devices





To connect to other Bluetooth devices, you need to perform a device search, select a discovered device, and then connect to the selected device. Pairing happens as part of the connection process.

1. Make sure the Bluetooth device you are attempting to connect to is in range and set to be discoverable by other devices using Bluetooth technology.
2. Touch **All Apps**  > **Settings** . Verify the **Bluetooth** radio is activated .
3. Touch **Bluetooth**.
4. Touch **Search for Devices** to refresh the scan started when the Bluetooth radio was first activated.
5. Touch on the name of the device you want to connect to on **Available Devices** list.
6. The Bluetooth radio attempts to connect with the device. If the device has a specific passcode, enter it when prompted.

Note: When attempting to connect to a printer or headset with Bluetooth capabilities, the passcode may default to either 1234 or 0000. If there is no default, consult the device literature for the number.

7. When the devices are paired successfully, the device name is displayed under the “Paired Devices” heading on the Bluetooth settings screen.



Configuring or Unpairing Bluetooth Devices

1. Touch **All Apps**  > **Settings** . Verify the **Bluetooth** radio is activated .
2. Touch **Bluetooth**.
3. On the **Paired Devices** list touch the settings icon  next to name of the device you want to disconnect.
4. Touch **Rename**, **Unpair** or select a different profile from the **Profiles** list available for the paired device.

Making the Terminal Discoverable

By default, the Dolphin terminal is not discoverable, which means that the terminal will not be found by other Bluetooth devices.

To make the terminal discoverable:

1. Touch **All Apps**  > **Settings** .
2. Verify the **Bluetooth** radio is activated .
3. Touch **Bluetooth**.
4. Touch Dolphin 75e (default terminal name) at the top of the screen to make the device discoverable. The terminal starts a 2 minute count down during which time the terminal is temporarily discoverable by other devices using Bluetooth technology.

Bluetooth Menu Options

You can access additional configuration options from the **Bluetooth** screen by pressing the **Menu**







button .

- **Rename phone** changes the default Dolphin 75e terminal name to a custom name of your choice. Enter the new name, and then select **Rename**.
- **Visibility timeout** changes the default 2 minute visibility timeout increment. Select **5 minutes**, **1 hour** or **Never time out**.
- **Show received files** lists statistics on received files.

Sharing Pictures and Video

Before attempting to transfer files, make sure the receiving Bluetooth device is in range of the terminal and set to be discoverable by other devices. Depending on the operating system of the receiving device, you may also need to set the device to receive incoming beams.

1. Verify the Bluetooth radio is enabled. See [Turning the Bluetooth Radio On or Off](#) on page 8-1.

2. Touch **All Apps**  > **Gallery** .
3. Touch the album that contains the picture or video you want to share.
4. Select a picture or video from the thumbnail gallery, and then touch the share icon  in the upper right corner of the screen.
5. Press the **Menu** button then **Select item** to touch multiple pictures or videos you want to share.
6. Touch **Bluetooth**.
7. The **Bluetooth device picker** screen opens. Do one of the following:
 - Touch **Scan for devices**, and then touch the name of the receiving device from the available device list.
 - OR
 - Touch on the name of an already paired device from the Bluetooth device list.
8. A pop-up message notifies you the file is **Sending** and the upload notification icon  appears on the status bar.
9. Accept the file transfer on the receiving device. The acceptance procedure depends on the device's OS and security protocols.
10. If the device is another Android device, a Bluetooth incoming file notification icon  appears on the status bar. Drag down the **Notification panel**, and then touch on the **Bluetooth Incoming file notification**.
11. Touch **Accept** to allow the file transfer.
12. A pop-up message notifies you the device is downloading the file and the file location. The download notification icon  appears on the status bar.
13. Drag down the **Notification panel** on either device, to verify if the file transfer was complete.

Near Field Communication (NFC) Technology

NFC technology provides the ability for short-range, wireless data transfer between the terminal and NFC tags or other NFC enabled devices placed in close proximity to the back of the terminal.

Suspend mode and the screen lock temporarily turns the NFC radio off.

NFC equipped Dolphin 75e models support the following modes of operation:

- **NFC tag reader/writer mode**
The terminal reads and/or writes digital information from or to an NFC tag.
- **Peer-to-Peer (P2P) mode**
The terminal uses Android Beam and/or Bluetooth technology to transfer screen content (e.g., a picture, contact information, Web page url, or file) between NFC enabled devices.
- **NFC card emulation mode**
The terminal emulates an NFC card (smart card) that an external card reader can access. Terminal models equipped with NFC technology include the option to enable the embedded secure element (eSE) SmartMX™. Secure element implementation is commonly used for financial transactions or coupon and loyalty mobile marketing applications that require a secure memory and execution environment for the storage of personal information (e.g., account information and credentials) and/or running custom smart card applets.

Hardware Requirements



NFC functionality is hardware dependent and only available on Dolphin 75e models ending with the letter N (e.g., 70exxN). Use only NFC compatible replacement battery doors with NFC equipped Dolphin models.

Security Recommendation

NFC functionality is enabled by default on Dolphin 75e models ending with the letter N (e.g., 70exxN). The recommended setting for NFC functionality is disabled until the feature is required. Enabling NFC allows data exchanges between the terminal and other NFC devices or tags. For information on security guidelines and recommendations, see the Dolphin 75e powered by Android Network and Security Guide available for download at www.honeywellaidc.com.



NFC Settings

Enabling or Disabling NFC Functionality



1. Touch **All Apps**  > **Settings** .
2. Under **Wireless & Networks**, touch **More**.
3. Touch the box next to **NFC** to either enable (check) or disable (not checked) short-range wireless data exchange.

Enabling the Android Beam

Android Beam functionality is only available if NFC is enabled.

1. Touch **All Apps**  > **Settings** .
2. Under **Wireless & Networks**, touch **More**.
3. Verify the box next to **NFC** is checked (enabled).
4. Check the box next to **Android Beam**.

Enabling the Embedded Secure Element (eSE)

1. Touch **All Apps**  > **Settings** .
2. Under **Wireless & Networks**, touch **More**.
3. Verify the box next to **NFC** is checked (enabled).
4. Touch **Secure Element**.

5. Touch **Select SE** then choose the embedded secure element (eSE) **SmartMX**.

*Note: If you want to turn off a previously selected SE, select **None** from the **Select SE > Change SE** list. Card Emulation is enabled (checked) by default when an SE is selected.*

Reading NFC Tags

1. Verify **NFC** is enabled (see page 8-3).
2. Hold the NFC tag close to the back of the terminal. When an NFC tag is recognized, the terminal emits a sound and the tag data displays on the terminal screen.

Note: The terminal must be unlocked for NFC tag detection. If sound is muted, the terminal vibrates when an NFC tag is detected.

See page page 8-4 for information on [Using the NFC Demos](#).

Transferring screen content via NFC

1. Verify **NFC** is enabled (see page 8-3).
2. Verify **Android beam** is enabled on the sending terminal.
3. Open the item you want to share (e.g., contact, picture, or Web page).
4. Hold the terminals back to back. The sending terminal emits a sound, the screen image shrinks, and the message, "Touch to beam" displays.
5. Both terminals must be unlocked for NFC tag detection. If sound is muted, the terminal vibrates when an NFC tag is detected.
6. Touch the reduced screen image to initiate the transfer. The receiving terminal displays the transferred content.

Note: If an active network connection is present, Android Market™ opens if the item received requires an app not installed on the device.



Using the NFC Demos

Honeywell NFC Demos demonstrate the basic NFC capabilities of the terminal and are not intended as a functional business solution. Detailed information on how to create custom applications for your Dolphin terminal is provided in the *Software Development Kit (SDK)*, available for download at www.honeywellaidc.com.



Note: Honeywell NFC Demo are designed for use with NFC equipped Dolphin 75e models only. Before using the demos, you must enable NFC functionality on the terminal (see page 8-3).

NFC Tag Demo

The **NFC Tag Demo** demonstrates basic NFC tag reading and writing using the terminal. Three options are available under the demo: **Read a tag**, **Write a contact**, and **Write a message**. **Read a tag** demonstrates how the terminal reads and displays data from NFC tags placed in close proximity to the back of the terminal. **Write a contact** and **Write a message** demonstrates how you can write (save) data to a writable or rewritable NFC tag. The data is then displayed whenever the NFC tag is read.



Touch **All Apps**  > **Demos** . Swipe right to scroll to **NFC Demos**, and then touch  to open the demo.

To **Read a tag**:



1. Touch **NFC Tag Demo**  from inside the **NFC Demos**  app.
2. Touch **Read a tag** .
3. Hold the NFC tag close to the back of the terminal. An "NFC Tag Detected" notification displays on the screen with the raw data contained in the tag.

Note: The terminal must be unlocked for NFC tag detection.

To **Write a contact** on an NFC tag:

1. Touch **NFC Tag Demo**  from inside the **NFC Demos**  app.
2. Touch **Write a contact** .
3. Select a contact from your saved contacts list.
4. Hold the writable or rewritable NFC tag close to the back of the terminal. A “Write successful” popup message displays on the screen.



To **Write a message** on an NFC tag:

1. Touch **NFC Tag Demo**  from inside the **NFC Demos**  app.
2. Touch **Write a message** .
3. Input the message, and then select **Write**.
4. Hold the writable or rewritable NFC tag close to the back of the terminal. A “Write successful” popup message displays on the screen.

NFC Bluetooth

NFC Bluetooth demo demonstrates how NFC in conjunction with Bluetooth technology can facilitate the transfer of a file between two devices.

Note: The NFC Bluetooth Demo is for use with Dolphin 75e terminals only.

1. Verify **NFC** technology is enabled on both terminals.
2. Verify **Android beam** is enabled on the terminal sending the file.
3. Touch **NFC Bluetooth**  from inside the **NFC Demos**  app on the sending terminal.

Note: The NFC Bluetooth demo automatically enables Bluetooth technology on both terminals during the demo process.

4. Touch **Select**.
5. Choose to browse either the **Gallery**  or **Drive**  for the file.

Note: A Google account is required for Google Drive™ online storage service. Additional fees may apply.

6. Touch the file name or picture thumbnail to send.

Note: Once a file is selected, the NFC Bluetooth app screen displays a brief pop-up message to “Ensure devices are near for beaming.” You do not need to touch “Select” again if the picture or file appears on the screen.

7. Hold the terminals back to back. The sending terminal emits a sound, the screen image shrinks, and the message, “Touch to beam” displays.

Note: Both terminals must be unlocked to for NFC detection. If sound is muted, the terminal vibrates when an NFC tag is detected.

8. Touch the reduced screen image. The terminal automatically initiates a Bluetooth pairing. Once pairing is complete, the file is sent.

The file image and saved location are displayed on the receiving terminal screen when the transfer is successful. By default, the file is saved to the root Honeywell/nfcbtddemo folder of the microSD card.



9. Select the **Back** button  to exit the demo.

Note: The NFC Bluetooth demo automatically disables Bluetooth technology when the demo is closed.

NFC Beam Demo

NFC Beam Demo demonstrates how a file can be transmitted between two devices using the Android beam.

Note: The NFC Bluetooth Demo is for use with Dolphin 75e terminals only.

1. Verify **NFC** technology is enabled on both terminals.
2. Verify **Android beam** is enabled on the terminal sending the file.
3. Touch **NFC Beam Demo**  from inside the **NFC Demos**  app on the sending terminal.
4. Check the box next to the **test.txt** file.
5. Hold the terminals back to back. The sending terminal emits a sound, the demo screen image shrinks, and the message, "Touch to beam" displays.

Note: Both terminals must be unlocked for NFC detection. If sound is muted, the terminal vibrates when an NFC tag is detected.

6. Touch the reduced screen image to initiate file transfer.

A "File received" message is displayed on the receiving terminal when the transfer is successful. By default, the file is saved to the root Honeywell/nfcbeamdmo folder of the microSD card.

7. Select the **Back** button  to exit the demo.

Dolphin 70e Black HomeBase (Model 70e-HB)

Overview

The Dolphin 70e Black HomeBase (Model 70e-HB) is a charging and communication cradle that supports USB Hi-Speed 2.0v communication, which enables the terminal to interface with the majority of PC-based enterprise systems. The HomeBase also contains an auxiliary battery well that charges a spare Honeywell standard or extended battery.

The 70e-HB charger is designed for use with the following Dolphin models and batteries manufactured for Honeywell International Inc:

Dolphin Model	Battery Model No.	Battery Part No.	Battery Specification
Dolphin 75e	70e-BTSC	BAT-STANDARD-02	Li-ion 3.7V, 6.179 watt hour
	70e-BTEC	BAT-EXTENDED-02	Li-ion 3.7V, 12.358 watt hour



We recommend use of Honeywell peripherals, power cables, and power adapters. Use of any non-Honeywell peripherals, cables, or power adapters may cause damage not covered by the warranty.

Unpacking the HomeBase

Open the shipping box and inspect the package to see that the following standard items are included:

- One Dolphin HomeBase, model 70e-HB
- One power supply (see [Power](#) on page 9-4)
- One power cord

These items are needed to operate the HomeBase. If any items are missing or anything appears to be damaged, contact your Customer Account Representative. Keep the original packaging in case you need to return the HomeBase for service or to store the HomeBase while not in use.

Optional Equipment

A standard USB (Type A to B) cable is required when using the HomeBase for communication between the terminal and a host device.

Charging Overview

The base provides power to the intelligent battery charging system in all Dolphin terminals that senses when a full charge has been achieved and switches to a trickle charge to maintain the full charge. The base completes a full charge of the main battery installed in the terminal seated in the terminal well in 4 hours for the standard battery or 6 hours for the extended battery. The base completes a full charge of the battery pack in the [Auxiliary Battery Well](#) (see page 9-3) in 4 hours for the standard battery or 6 hours for the extended battery.

Note: Before attempting to use, charge, or replace the battery in the terminal, you should read the [Guidelines for Battery Pack Use and Disposal](#) on page 3-11.



We recommend use of Honeywell Li-ion battery packs. Use of any non-Honeywell battery may result in damage not covered by the warranty.

Communications

Reliable data communications at speeds of up to 480 Mbps can be transmitted by the base through the Hi-Speed USB port.

Note: These bases cannot be physically connected to each other - sometimes referred to as "daisy-chained".

Convenient Storage

The intelligent battery charging system makes this base a safe and convenient storage receptacle for your Dolphin terminal.

Capacity

The base holds one terminal and features an auxiliary battery well behind the terminal well that can charge a battery pack independently of the terminal well. This means that one base can charge two battery packs: the one installed in the terminal and a spare.



We recommend use of Honeywell peripherals, power cables, and power adapters. Use of any non-Honeywell peripherals, cables, or power adapters may cause damage not covered by the warranty.

Dimensions

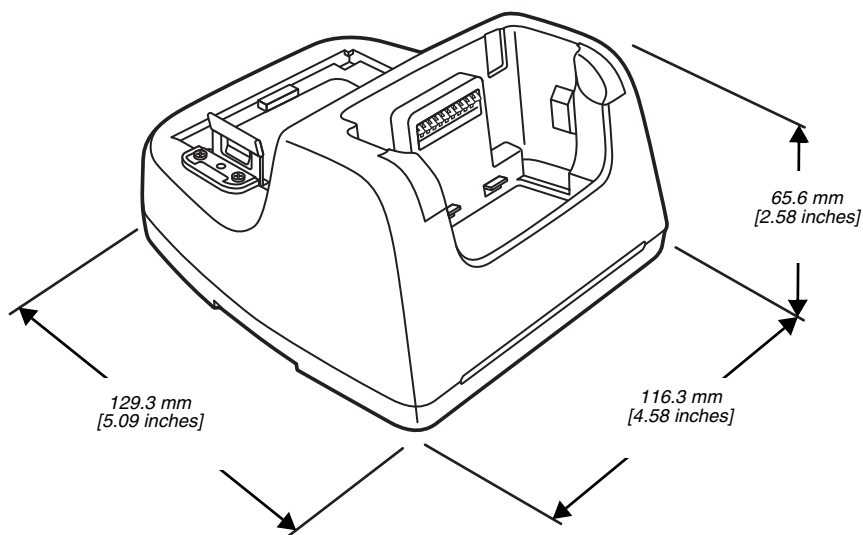

Weight

HomeBase weight: 303g [.668 lbs]

Note: Weight excludes packaging, cables and power supply.

Parts and Functions

Front Panel

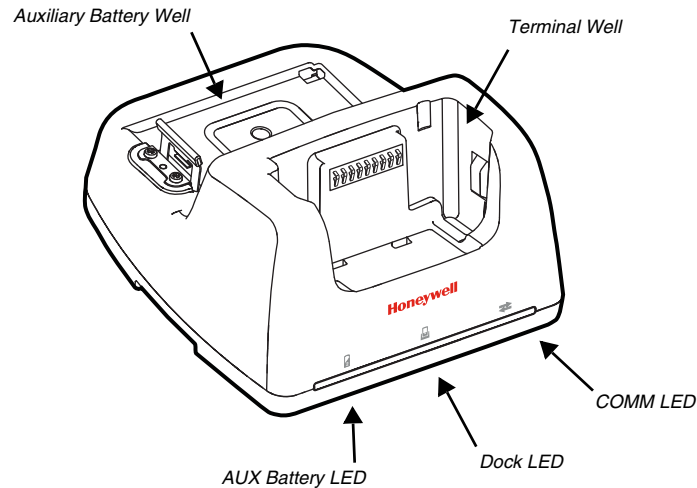

Terminal Well

Place the terminal in this well to communicate with a host device, power the terminal, and charge the installed battery pack. The base completely charges the main battery in a Dolphin terminal in 4 hours for the standard battery or 6 hours for the extended battery. See [page 9-6](#) for information on USB [Communication](#) between the host and terminal via the HomeBase.

Auxiliary Battery Well

See "Auxiliary Battery Well" on page 9-4

AUX Battery LED

Indicates status of the battery charging in the auxiliary battery well; see [Back Panel](#) on page 9-4.

This color	means...
Orange	The auxiliary battery is charging.
Green	The auxiliary battery has completed charging and is ready for use.

For information about charging a battery in the auxiliary battery well, see page 9-5.

Dock LED

Indicates if a terminal is docked properly in the base.

This color	means...
Blue	The terminal is properly seated in the base.

COMM LED

This is the communication LED. It indicates the status of data transfer between the Dolphin terminal and the host device.

This color	means...
Green	A USB Connection is established with the host workstation.

Back Panel

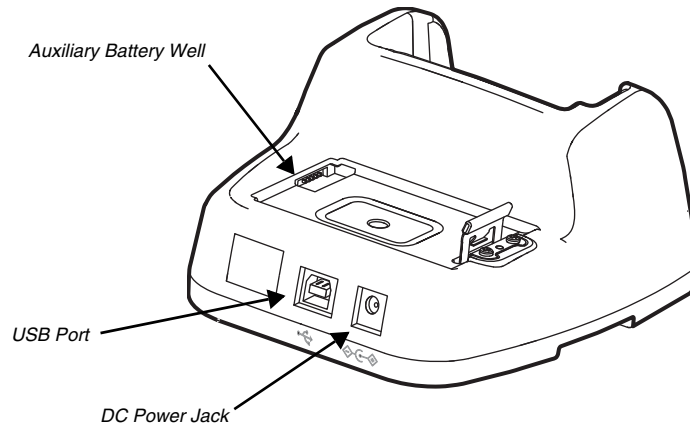

Auxiliary Battery Well

The base enables you to charge an additional battery pack independently of the terminal well in 4 hours for the standard battery or 6 hours for the extended battery. This feature ensures that you can always have a fully-charged battery for your terminal. See "Charging a Spare Battery in the Auxiliary Battery Well" on page 9-5

USB Port

This USB port is USB v2.0 Hi-Speed (480 Mbps) compliant. Using a USB cable, you can connect the base to a host device, such as a workstation. When the terminal is seated in the terminal well, it is connected to the host device via the base. See [Communication](#) on page 9-6.

DC Power Jack

See [Power](#) on page 9-4.

Bottom Panel

For details on how to mount the HomeBase, see [Mounting the HomeBase](#) on page 9-6.

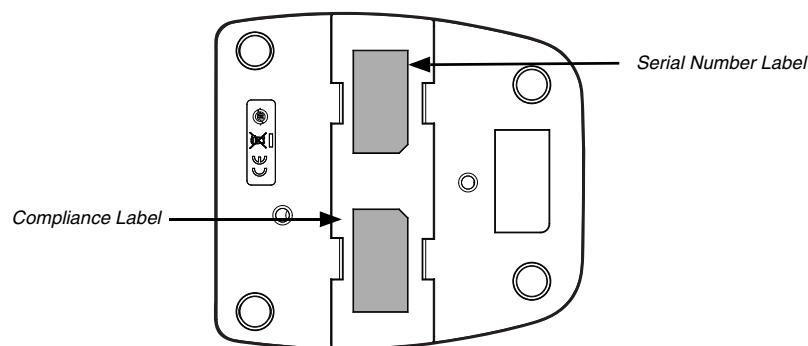

Power

The base requires 12 Volts DC input for communications, battery charging, and power output to the terminal. The power adapter included with the base, converts the voltage from the AC power source to 12 Volts DC. **Use only a UL listed power supply, which has been qualified by Honeywell with output rated at 12VDC and 3 amps with the device.** The operating temperature range is -10° to 50°C (14° to 122°F). Honeywell recommends that you leave the base connected to its power source at all times, so that it is always ready to use.



We recommend use of Honeywell peripherals, power cables, and power adapters. Use of any non-Honeywell peripherals, cables, or power adapters may cause damage not covered by the warranty.

Connecting Power to the HomeBase

1. Plug the A/C power cord into the power adapter.
2. Plug the power cable into the power connector on the back of the HomeBase.
3. Plug the A/C power cord into a grounded power source.
4. The base is now powered.

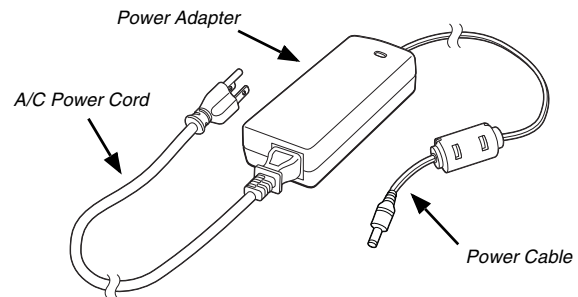

Charging the Main Battery

The base provides power to the Dolphin terminal and allows the charging of the terminal's battery. The intelligent battery charging system incorporated into all Dolphin terminals prevents overcharging, which means that Dolphin terminals may be stored in the base indefinitely without damage to the terminals, battery, or the base. When the terminal is docked, the base completes a full charge in 4 hours for the standard battery or 6 hours for the extended battery.



For more information about Honeywell battery packs and how to check battery power levels in your terminal, refer to [Battery](#) (page 3-8).

To Power a Terminal and Charge its Main Battery



Ensure all components are dry prior to mating terminals/batteries with peripheral devices. Mating wet components may cause damage not covered by the warranty.

1. Install the battery pack in the terminal; see [Install the Battery](#) on page 2-1.
2. Slide the terminal into the terminal well. The Dock LED illuminates blue. Battery charging begins immediately if required by the Dolphin terminal.

Note: When the terminal is docked, the Battery Icon changes from  to  indicating the terminal is running on external power. Battery charging occurs in the background. When the Dolphin is removed from the base, the battery icon indicates the charge level of the battery, see [Common Status and Notification Icons](#) on page 2-6.

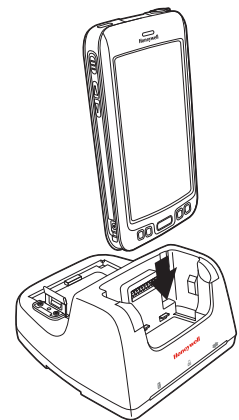

We recommend use of Honeywell Li-Ion battery packs. Use of any non-Honeywell battery may result in damage not covered by the warranty.

Charging a Spare Battery in the Auxiliary Battery Well

The auxiliary battery well located on the back of the base charges a spare battery independently of the terminal well. The Aux Battery LED on the front panel indicates the status of the battery in this well. Charge time is 4 hours for the standard battery pack or 6 hours for the extended battery pack; see [Auxiliary Battery Well](#) on page 9-4.

1. Insert the battery at an angle.

Note: Align the battery contacts with the contacts inside the auxiliary battery well.

2. Snap the battery into place with a hinging motion. The Aux Battery LED lights orange during charging.
3. Use the AUX Battery LED to monitor the charging progress. The LED changes to green when the auxiliary battery has completed charging and is ready for use.

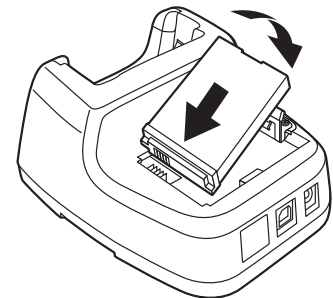

Communication

Dolphin terminals support USB communications out of the box. The base also supports USB communications via the USB port located on the back. The base acts as a USB device by interfacing the USB signals of the Dolphin terminal to the USB of the host workstation. Using a standard USB cable, the base's USB interface allows the Dolphin terminal to communicate with a workstation.

Requirements

- A base powered by a power cable and power adapter cable
- A standard USB (Type A to B) communication cable
- A work station running Windows 98 Second Edition, Windows Me, Windows 2000, Windows NT (4.0 SP6 or higher), Windows XP, Windows Vista, or Windows 7.

Setting Up and Connecting the Dolphin Terminal to the HomeBase

1. Connect power to the HomeBase (see [Power](#) on page 9-4).
2. Plug the USB communication cable into the USB port on the back of the base.

Note: The Dolphin terminal should always be removed from the HomeBase when connecting or disconnecting the USB cable.

3. Connect the other end of the USB cable to the host workstation.
4. Insert the Dolphin terminal into the terminal well of the base. The Dock LED illuminates blue.
5. Touch **Turn on USB storage** when the **USB Mass Storage** screen opens.
6. The computer views the terminal as an external USB storage drive. You can copy, delete and/or move files or folders between the computer and the installed microSD card as you would with any other storage drive (e.g., cut and paste or drag and drop).
7. When you are finished transferring files, touch **Turn off USB storage**.

Note: This base cannot be daisy-chained.

Mounting the HomeBase

Set the base on a dry, stable surface, such as a desktop or workbench near an electrical outlet. The user should be able to view and operate the Dolphin terminal while it is in the base. When choosing a mounting location, bear in mind that the location must allow users' easy access to the Auxiliary Battery Well and the back panel of the HomeBase where the USB port and the power jack are located.

Optional DIN Rail Mount

A DIN rail (7.5 X 35 mm) may be installed on the bottom of the base to provide the optional security of mounting the base to a flat horizontal surface with hardware.

Additional Hardware

- DIN Rail, Qty. 1
- 3/16 in. dia x 5/8 in. long pan head screw, Qty. 2
- 1/2 in. OD x 7/32 in. ID x 3/64 in. thick washer, Qty. 4
- 3/16 in. dia nut, Qty. 2

Note: The items listed are for reference only. Final hardware selection is dependent on the material type and thickness of the mounting surface.

Installing the DIN Rail

1. Slide the DIN rail into the slot along the bottom panel of the base.

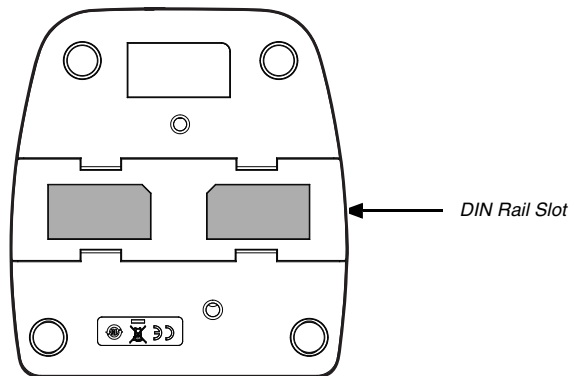

2. Use the appropriate hardware to secure the DIN rail to the desk or flat surface.

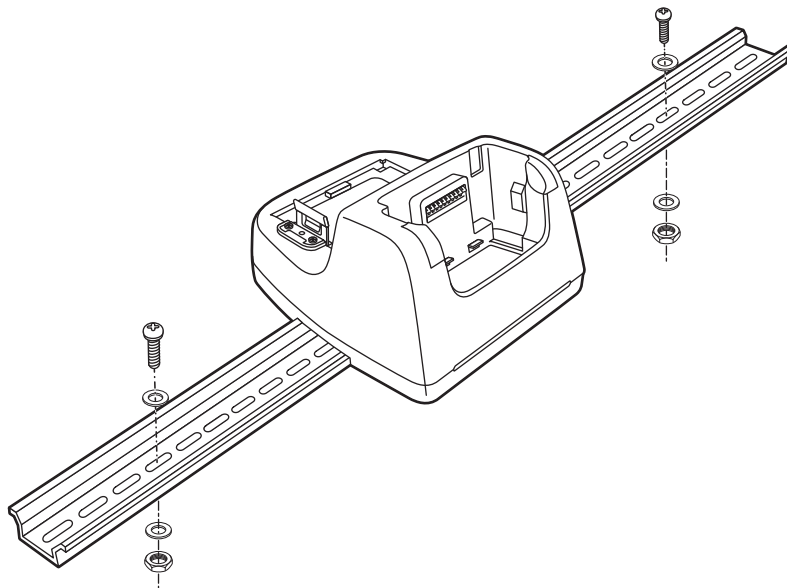

Dolphin 70e Black eBase (Model 70e-EHB)

Overview

The Ethernet Base (eBase) enables a single Dolphin 75e computer to communicate with a host device over an Ethernet network.

The 70e-EHB charger is designed for use with the following Dolphin models and batteries, manufactured for Honeywell International Inc:

Dolphin Model	Battery Model No.	Battery Part No.	Battery Specification
Dolphin 75e	70e-BTSC	BAT-STANDARD-02	Li-ion 3.7V, 6.179 watt hour
	70e-BTEC	BAT-EXTENDED-02	Li-ion 3.7V, 12.358 watt hour



We recommend use of Honeywell peripherals, power cables, and power adapters. Use of any non-Honeywell peripherals, cables, or power adapters may cause damage not covered by the warranty.

Unpacking the eBase

Open the shipping box and inspect the package to see that the following standard items are included:

- One Dolphin eBase Ethernet cradle, model 70e-EHB
- One power supply (see [Power](#) on page 10-5)
- One power cord

These items are needed to set up and operate the eBase. If any items are missing or anything appears to be damaged, contact your Customer Account Representative. Keep the original packaging in case you need to return the eBase for service or to store the eBase while not in use.

Optional Equipment

- A standard USB (Type A to B) cable is required when using the eBase for USB communication between the terminal and a host device.
- A standard CAT-5 Ethernet network cable is required when using the eBase for communication between the terminal and a host device over an Ethernet network.

Charging Overview

The base provides power to the intelligent battery charging system in all Dolphin terminals that senses when a full charge has been achieved and switches to a trickle charge to maintain the full charge. The base completes a full charge of the main battery pack installed in the terminal seated in the terminal well in 4 hours for the standard battery or 6 hours for the extended battery. The base completes a full charge of the battery pack in the [Auxiliary Battery Well](#) (see page 10-3) in 4 hours for the standard battery or 6 hours for the extended battery.

Note: Before attempting to use, charge, or replace the battery in the terminal, you should read the [Guidelines for Battery Pack Use and Disposal](#) on page 3-11.



We recommend use of Honeywell Li-ion battery packs. Use of any non-Honeywell battery may result in damage not covered by the warranty.

Convenient Storage

The intelligent battery charging system makes this base a safe and convenient storage receptacle for your Dolphin terminal.

Capacity

The base holds one terminal and features an auxiliary battery well behind the terminal well that can charge a battery pack independently of the terminal well. This means that one base can charge two battery packs: the one installed in the terminal and a spare.

Dimensions

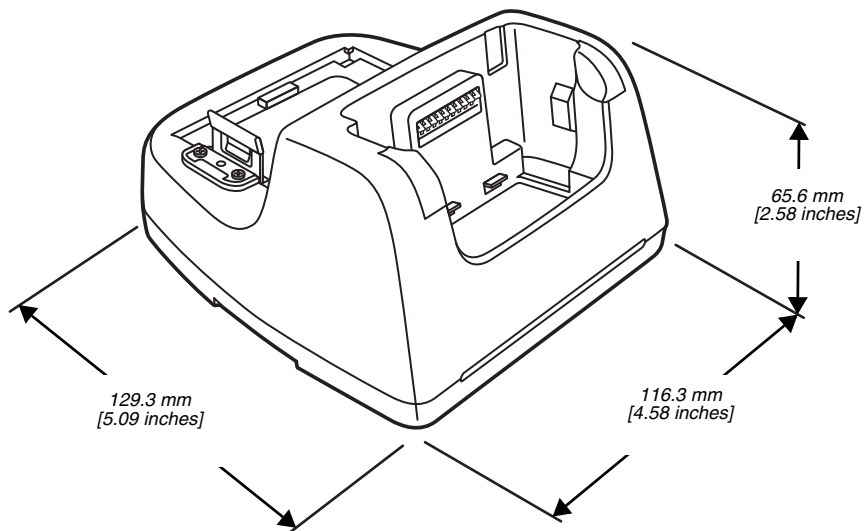

Weight

eBase weight: 310g [.683 lbs]

Note: Weight excludes packaging, cables and power supply.

Parts and Functions

Front Panel

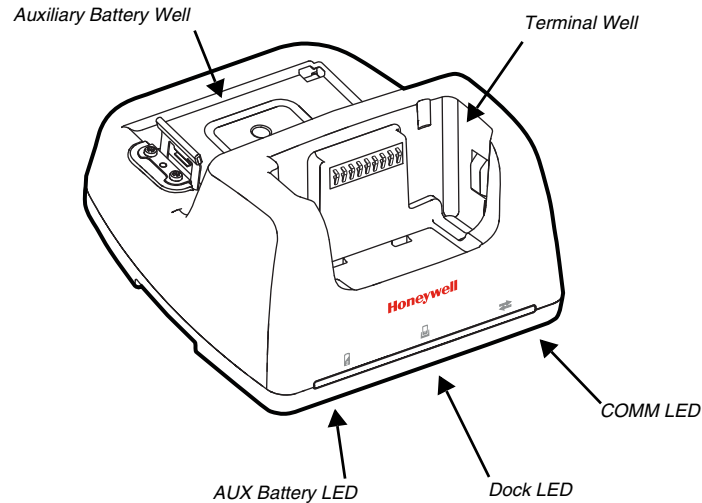

Terminal Well

Place the terminal in this well to communicate with a host device, power the terminal, and charge the installed battery pack. The eBase completely charges the main battery in a Dolphin terminal in 4 hours for the standard battery or 6 hours for the extended battery.

Auxiliary Battery Well

See "Auxiliary Battery Well" on page 10-4

AUX Battery LED

Indicates status of the battery charging in the auxiliary battery well; see [Back Panel](#) on page 10-4.

This color	means...
Orange	The auxiliary battery is charging.
Green	The auxiliary battery has completed charging and is ready for use.

For information about charging a battery in the auxiliary battery well, see page 10-6.

Dock LED

Indicates if a terminal is docked properly in the base.

This color	means...
Blue	The terminal is properly seated in the base.

COMM LED ⇄

Indicates the status of the connection and data transfer between the Dolphin terminal and the host device.

This color	means...
Green	A USB Connection is established with the host workstation.

Note: Ethernet activity is indicated by RJ45 integrated LED on the back panel of the base.

Back Panel

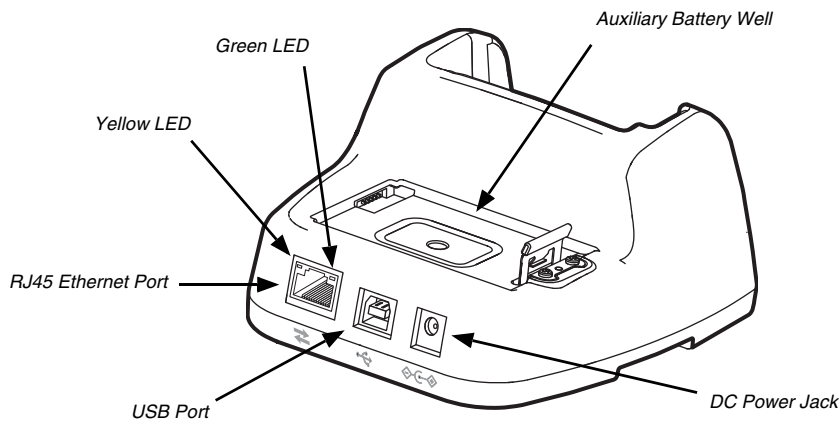

Auxiliary Battery Well

The eBase enables you to charge an additional battery pack independently of the terminal well in 4 hours for the standard battery or 6 hours for the extended battery. This feature ensures that you can always have a fully charged battery for your terminal.

USB Port

This USB port is USB v2.0 Hi-Speed (480 Mbps) compliant. Using a USB cable, you can connect the base to a host device, such as a workstation (PC). When the terminal is seated in the terminal well, it is connected to the host device via the base.

RJ45 Ethernet Port

Use a standard CAT-5 Ethernet cable; you can connect the ebase to an Ethernet-compliant device to facilitate Ethernet communication to and from the terminal. The RJ45 connector includes integrated LEDs that provide Ethernet communication status and speed information.

Status	Yellow LED	Green LED
No Ethernet Link	Off	Off
10Mbps Ethernet Connection Established	Off	On
100Mbps Ethernet Connection Established	On	On
Data transfer in progress	Connection Speed Dependent (see above)	Flashing

DC Power Jack

See [Power](#).

Bottom Panel

For details on how to mount the eBase, see [Mounting the eBase](#) on page 10-8.

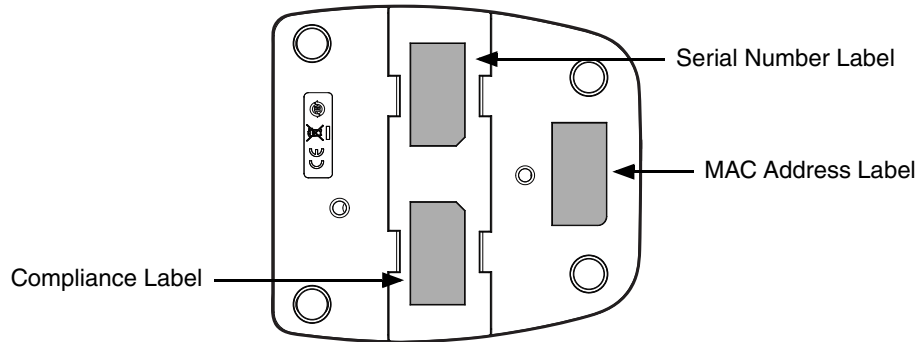

Power

The base requires 12 Volts DC input for communications, battery charging, and power output to the terminal; the power adapter included with the base converts the voltage from the AC power source to 12 Volts DC. **Use only a UL listed power supply, which has been qualified by Honeywell with output rated at 12VDC and 3 amps with the device.** The operating temperature range is -10° to 50°C (14° to 122°F). Honeywell recommends that you leave the eBase connected to its power source at all times, so that it is always ready to use.



We recommend use of Honeywell peripherals, power cables, and power adapters. Use of any non-Honeywell peripherals, cables, or power adapters may cause damage not covered by the warranty.

Connecting Power to the eBase

1. Plug the A/C power cord into the power adapter.
2. Plug the power cable into the power connector on the back of the eBase.
3. Plug the A/C power cord into a grounded power source.

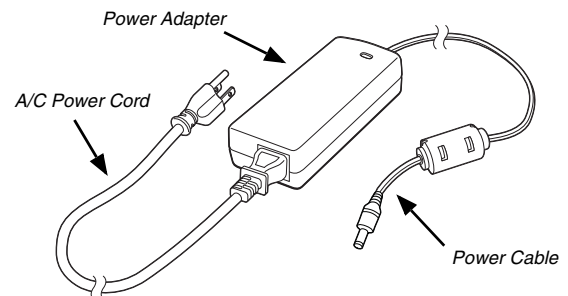

Charging the Main Battery

The base provides power to the Dolphin terminal and allows the charging of the terminal's battery. The intelligent battery charging system incorporated into all Dolphin terminals prevents overcharging, which means that Dolphin terminals may be stored in the base indefinitely without damage to the terminals, battery packs, or the base. When the terminal is docked, the base completes a full charge in 4 hours for the standard battery or 6 hours for the extended battery.

For more information about Honeywell battery packs and how to check battery power levels in your terminal, refer to [Battery](#) (page 3-8).



To Power a Terminal and Charge its Main Battery

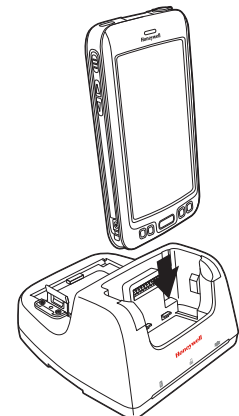

Ensure all components are dry prior to mating terminals/batteries with peripheral devices. Mating wet components may cause damage not covered by the warranty.



1. Install the battery pack in the terminal; see page 2-1.
2. Slide the terminal into the terminal well. The Dock LED illuminates blue. Battery charging begins immediately if required by the Dolphin terminal.

Note: When the terminal is docked, the Battery Icon changes from  to  indicating the terminal is running on external power. Battery charging occurs in the background. When the Dolphin is removed from the base, the battery icon indicates the charge level of the battery, see [Common Status and Notification Icons](#) on page 2-6.



We recommend use of Honeywell Li-Ion battery packs. Use of any non-Honeywell battery may result in damage not covered by the warranty.

Charging a Spare Battery in the Auxiliary Battery Well

The auxiliary battery well located on the back of the base charges a spare battery independently of the terminal well. The Aux Battery LED on the front panel indicates the status of the battery in this well. Charge time is 4 hours for the standard battery pack or 6 hours for the extended battery pack; see [Auxiliary Battery Well](#) on page 10-4.

1. Insert the battery at an angle.

Note: Align the battery contacts with the contacts inside the auxiliary battery well.

2. Snap the battery into place with a hinging motion. The Aux Battery LED lights orange during charging.
3. Use the AUX Battery LED to monitor the charging progress. The LED lights green when the auxiliary battery has completed charging and is ready for use.

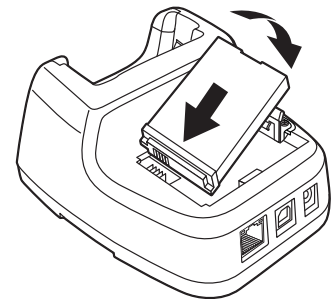





Communication

Establishing Ethernet Communication

Connecting the Dolphin Terminal to the eBase

By default, the Dolphin terminal is configured to obtain IP addresses automatically via DHCP server. This means that in most cases you would simply plug-and-play the unit.



1. Connect power to the eBase (see [Power](#) on page 10-5).
2. Plug the CAT-5 Ethernet cable into the RJ45 connector on the back of the eBase.
3. Plug the Ethernet cable into the network.
4. Insert the Dolphin into the terminal well. The Dock LED on the base illuminates blue.
5. Touch **All Apps**  > **Settings**  > **Ethernet configuration**.
6. Check the box to **Turn on Ethernet**. When an Ethernet connection is established the status icon changes from  to  at the top of the screen.

Troubleshooting

If the items on the Ethernet configuration screen are grayed out and not accessible, verify the base has power, the Ethernet cable is undamaged and properly installed to the base, there is an active network signal over the Ethernet cable, and the terminal is properly docked in the base.



Ethernet Configuration Settings

Instead of using the default DHCP assigned IP address, the Dolphin terminal can be configured to use a statically assigned IP address.

1. Touch **All Apps**  > **Settings**  > **Ethernet configuration**.
2. Select **Ethernet configuration**, again.
3. Select **Static IP** under Connection Type, and then input the **IP address** and any additional information based on your network configuration.
4. Touch **Save**.

Ethernet Proxy Settings

To set up a proxy to use when accessing your network with Ethernet:

1. Touch **All Apps**  > **Settings**  > **Ethernet proxy settings**.
2. Input the **Proxy host name** and **Proxy port**. If required, designate when to bypass the proxy.
3. Select **Done**.

Displaying the eBase and Terminal IP Address

Once the Dolphin terminal has been successfully connected to the network through eBase, the terminal uses the eBase IP address. The IP address can be used by any application on the Dolphin terminal.

Touch **All Apps**  > **Settings**  > **About Phone** > **Status** to view the assigned IP Address.

Establishing USB Communication

Dolphin terminals support USB communications out of the box. The base also supports USB communications via the USB port located on the back. The base acts as a USB device by interfacing the USB signals of the Dolphin terminal to the USB of the host workstation. Using a standard USB cable, the base's USB interface allows the Dolphin terminal to communicate with a workstation.

Requirements

- A base powered by a power cable and power adapter cable
- A standard USB (Type A to B) communication cable
- A work station running Windows 98 Second Edition, Windows Me, Windows 2000, Windows NT (4.0 SP6 or higher), Windows XP, Windows Vista, or Windows 7.

Setting Up and Connecting the Dolphin Terminal to an eBase

1. Connect power to the HomeBase (see [Power](#) on page 10-5).
2. Plug the USB communication cable into the USB port on the back of the base.

Note: The Dolphin terminal should always be removed from the HomeBase when connecting or disconnecting the USB cable.

3. Connect the other end of the USB cable to the host workstation.
4. Insert the Dolphin terminal into the terminal well of the base. The Dock LED illuminates blue.
5. Touch **Turn on USB storage** when the **USB Mass Storage** screen opens.
6. The computer views the terminal as an external USB storage drive. You can copy, delete and/or move files or folders between the computer and the installed microSD card as you would with any other storage drive (e.g., cut and paste or drag and drop).
7. When you are finished transferring files, touch **Turn off USB storage**.

Note: This base cannot be daisy-chained.

Mounting the eBase

Set the base on a dry, stable surface, such as a desktop or workbench near an electrical outlet. Be sure to provide enough workspace with good lighting for the user to view and operate the Dolphin terminal while it is in the base. When choosing a mounting location, bear in mind that the location must allow users' easy access to the Auxiliary Battery Well and the back panel of the eBase where the USB port, Ethernet port, and power jack are located.

Optional DIN Rail Mount

A DIN rail (7.5 X 35 mm) may be installed on the bottom of the base to provide the optional security of mounting the base to a flat horizontal surface with hardware.

Additional Hardware

- DIN Rail, Qty. 1
- 3/16 in. dia x 5/8 in. long pan head screw, Qty. 2
- 1/2 in. OD x 7/32 in. ID x 3/64 in. thick washer, Qty. 4
- 3/16 in. dia nut, Qty. 2

Note: The items listed above are for reference only. Final hardware selection is dependent on the material type and thickness of the mounting surface.

Installing the DIN Rail

1. Slide the DIN rail into the slot along the bottom panel of the base.

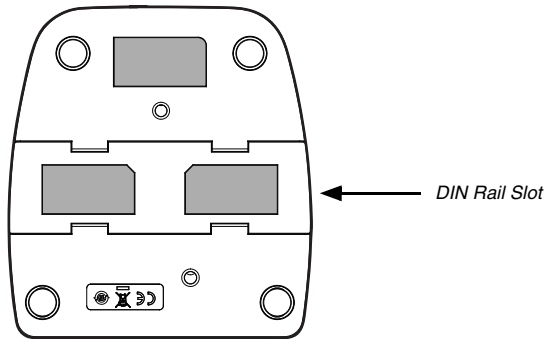

2. Use the appropriate hardware to secure the DIN rail to the desk or flat surface.

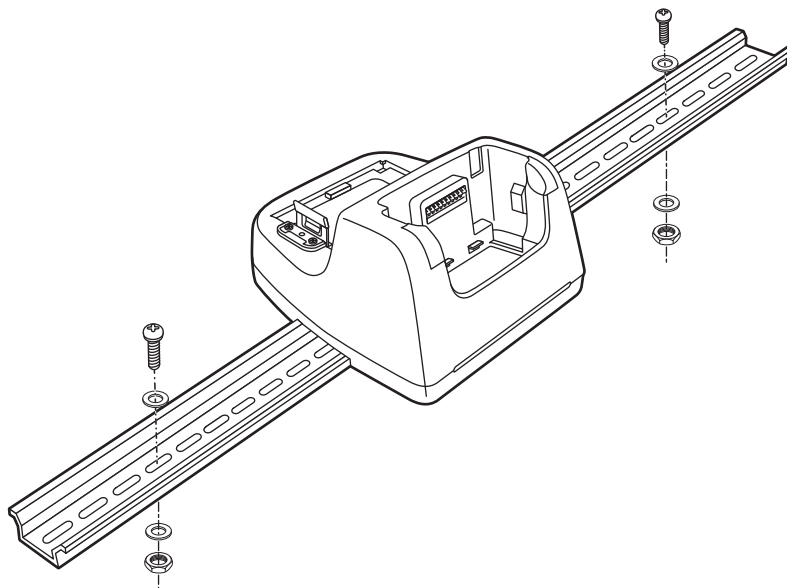

Dolphin 70e Black Mobile Base (Model 70e-MB)

Overview

The Dolphin Mobile Base charging cradle is designed specifically for in-premise and in-transit data collection applications. The base features a mounting bracket and a cigarette lighter adapter to adapt it to your environment.

The 70e-MB charger is designed for use with the following Dolphin models and batteries manufactured for Honeywell International Inc:

Dolphin Model	Battery Model No.	Battery Part No.	Battery Specification
Dolphin 75e	70e-BTSC	BAT-STANDARD-02	Li-ion 3.7V, 6.179 watt hour
	70e-BTEC	BAT-EXTENDED-02	Li-ion 3.7V, 12.358 watt hour



We recommend use of Honeywell peripherals, power cables, and power adapters. Use of any non-Honeywell peripherals, cables, or power adapters may cause damage not covered by the warranty.

Charging Overview

The base provides power to the intelligent battery charging system in all terminals that senses when a full charge has been achieved and switches to a trickle charge to maintain the full charge. The base completes a full charge of the main battery in 4 hours for the standard battery pack or 6 hours for the extended battery pack.

Note: Before attempting to use, charge, or replace the battery in the terminal, you should read the [Guidelines for Battery Pack Use and Disposal](#) on page 3-11.



We recommend use of Honeywell Li-Ion battery packs. Use of any non-Honeywell battery may result in damage not covered by the warranty.

Convenient Storage

Intelligent battery charging makes the base a safe and convenient storage receptacle for your Dolphin terminal.

Dimensions

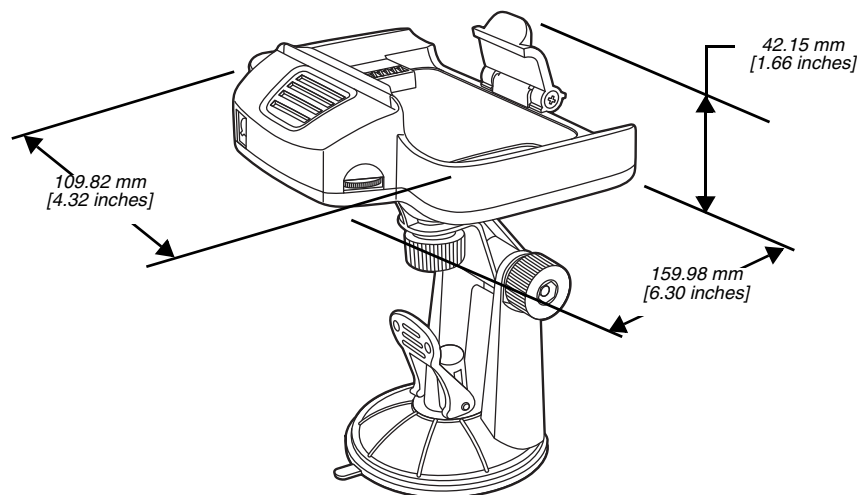

Weight

Mobile Base and adjustable arm weight: 270g [.595 lbs]

Mobile Base Components

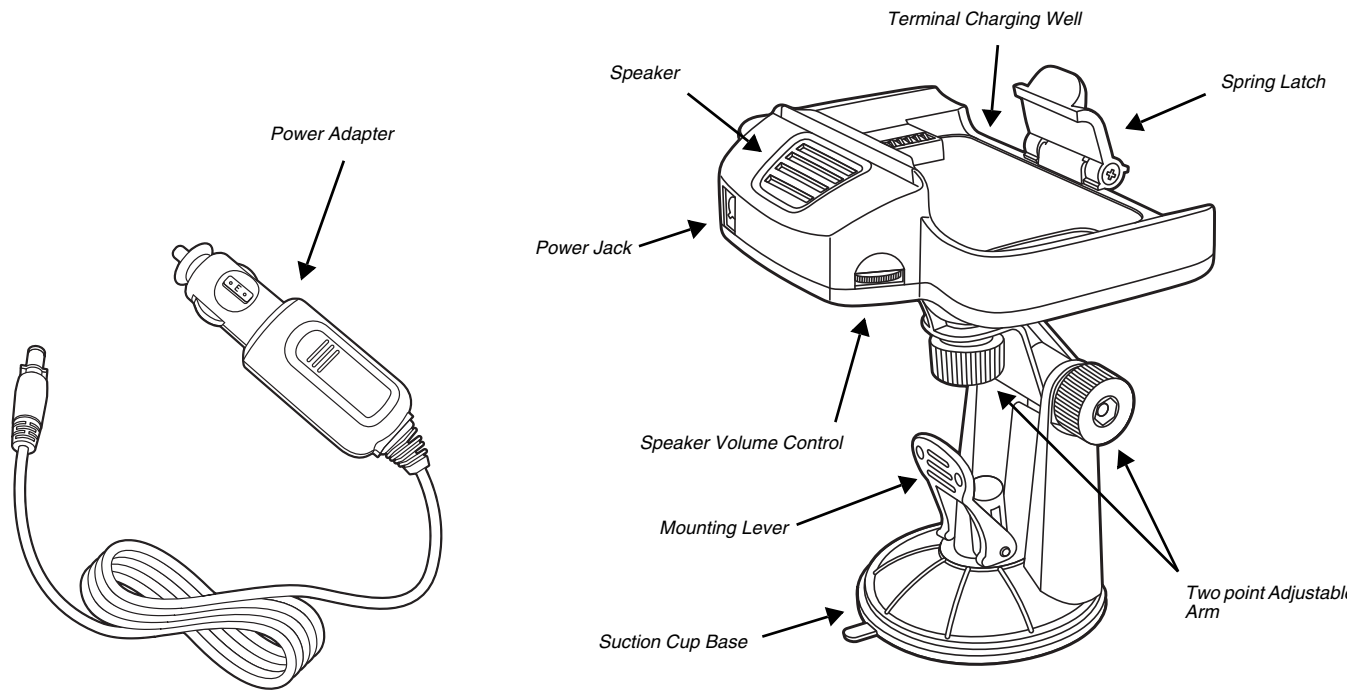

Adjustable Arm with Suction Cup Base for Windshield Mounting

The Mobile Base includes a two point adjustable arm with a suction cup base for fixed mount locations (e.g., a car windshield).

Power Adapter

The mobile base is provided with a power adapter cable that can be connected to a vehicle cigarette lighter outlet.

UL listed power supply

Input: 10V - 30VDC, 0.43A(30V) - 1.28A(10V)

Output: 4.75V - 5.25VDC, 0 - 2A



Verify that the power source is always within the specified range and observe correct input voltage polarity. An improper input voltage range or reverse polarity could damage the power conversion circuitry.

Speaker and Volume Control Dial

The integrated speaker amplifies the Dolphin terminal's audio signals and the speaker volume is adjusted using the dial located on the side of the base.

Spring Latch

The spring latch secures the terminal in the Mobile Base charging well.

Terminal Charging Well

Place the terminal in this well to charge the battery.

Mounting the Mobile Base

Safety Precautions

Honeywell is not responsible for any damages caused to you, your vehicle, or other individuals due to the installation of the Dolphin Mobile mount. Follow these safety precautions when mounting the mobile base:



Do not mount the base in a location where it prevents safe operation of the vehicle and/or impedes the vehicle operator's field of view.



Do not mount the base in a location where the connectors on the bottom panel of the base are not easily accessible. Be sure to leave enough room for unrestricted cable connections.



The Mobile base is intended for use in an enclosed space protected from the elements. Do not mount the Mobile base on external vehicle surfaces.



Do not install the Mobile base in an air bag deployment zone. Honeywell assumes no responsibility of liability for injury or death because of car crashes and/or air bag deployment.

Installation

1. Push the suction cup base firmly to the windshield.

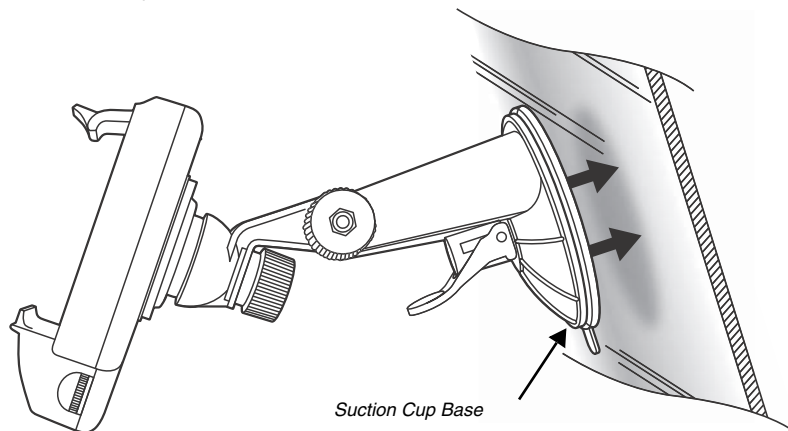

2. Flip the mounting lever down to secure the suction cup.

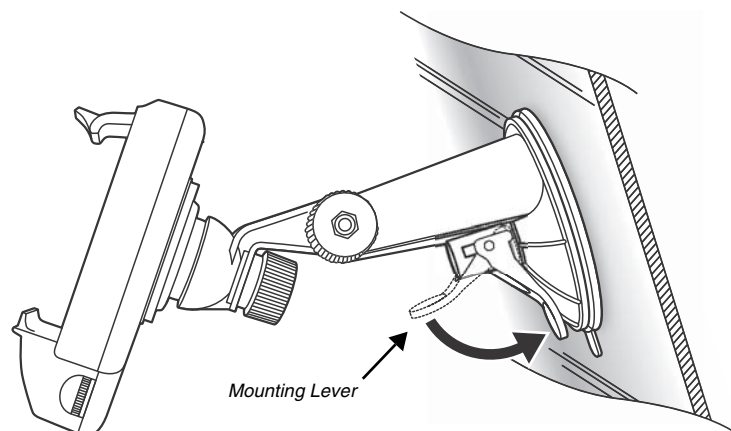

3. To adjust the angle of the bracket arm, twist the thumb screws counterclockwise to loosen the locks. Reposition the angle of the arm, and then twist the knobs clockwise to lock the arm into position.

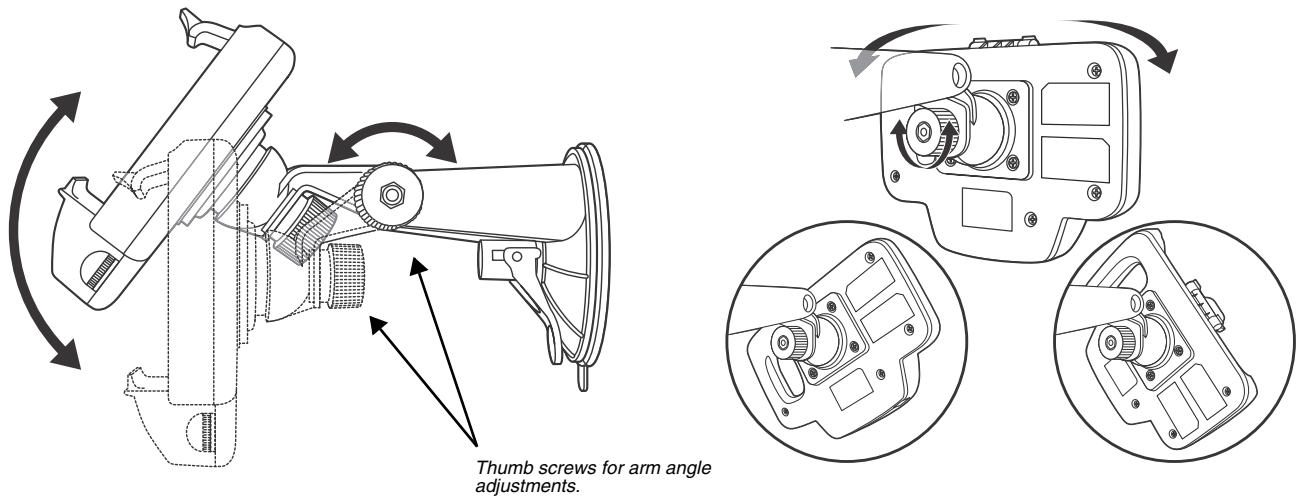

4. Insert the power cable connector into the power jack on the Mobile Base.
5. Twist the cable connector 90° clockwise to engage the cable lock.

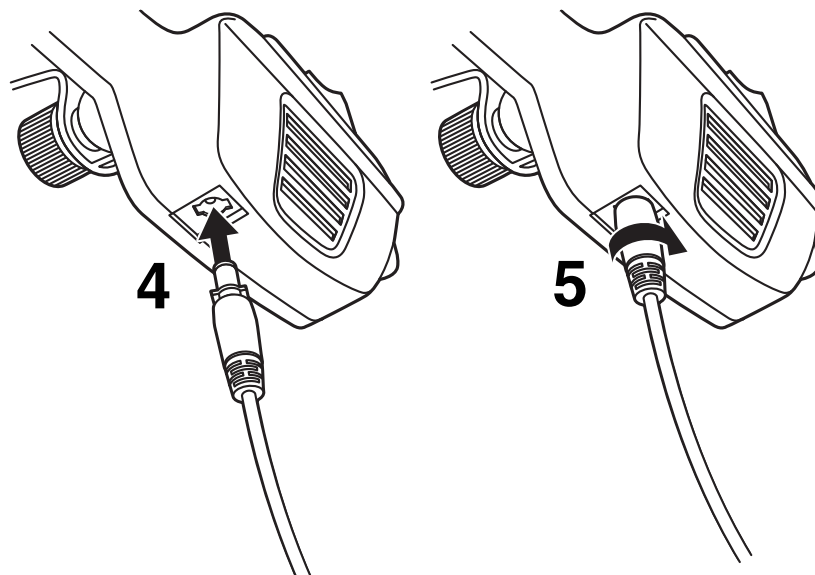

6. Plug the power adapter into the vehicle power outlet (e.g., cigarette lighter outlet)

Charging the Main Battery

The mobile base provides power to the Dolphin and allows charging of the main batteries in the terminal. The main battery charges in 4 hours for the standard battery or 6 hours for the extended battery. The intelligent battery charging system incorporated into all Dolphin terminals prevents overcharging, which means that terminal may be seated in the base indefinitely without damage to the terminal, battery pack, or the base.

For more information about Honeywell battery packs and how to check battery power levels in your terminal, refer to [Battery](#) (page 3-8).

To Power a Terminal and Charge its Main Battery



Ensure all components are dry prior to mating terminals/batteries with peripheral devices. Mating wet components may cause damage not covered by the warranty.



We recommend use of Honeywell Li-Ion battery packs. Use of any non-Honeywell battery may result in damage not covered by the warranty.

1. Install the main battery in the terminal; see [Install the Battery](#) on page 2-1.
2. Mount the Mobile base and install the power cable; see [Mounting the Mobile Base](#) on page 11-3.
3. Pull the spring latch back and insert the Dolphin 75e into the terminal well. Charging begins immediately if required by the Dolphin terminal.

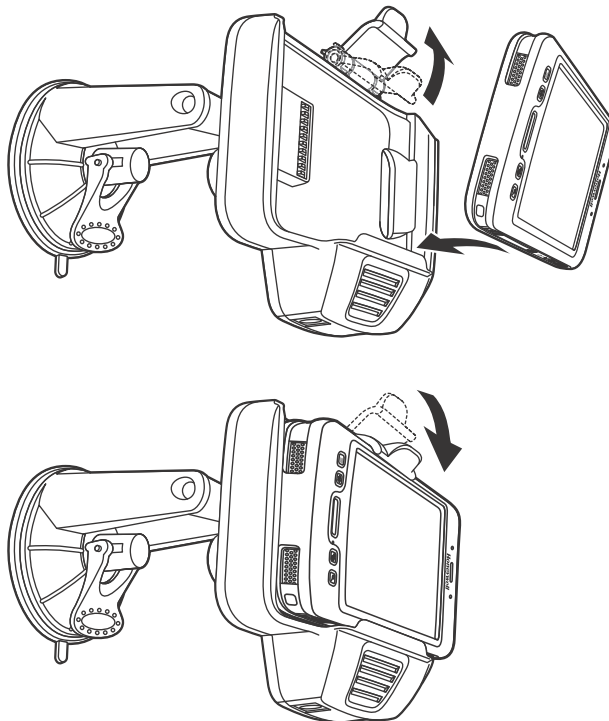

Note: Align the contacts on the back panel of the terminal with the charging contacts on the Mobile Base.

Removing the Cable



Attempting to remove the cable without disengaging the lock may result in damage to the base and power cable not covered by the warranty.

1. Twist the cable 90° counterclockwise to disengage the cable lock.
2. Remove the cable from the power jack.

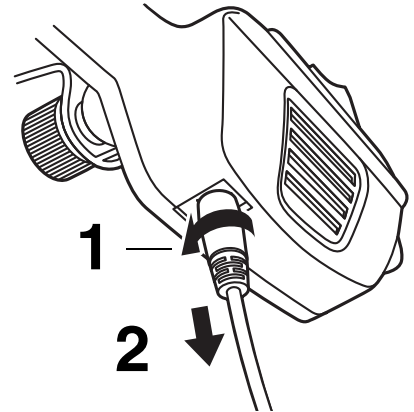

Dolphin 70e Black ChargeBase (Model 70e-CB)

Overview

The Dolphin 70e Black ChargeBase is a 4-slot charging cradle that can power four Dolphin terminals, and charge their main batteries in 4 hours for the standard battery or 6 hours for the extended battery.

The 70e-CB charger is designed for use with the following Dolphin models and batteries manufactured for Honeywell International Inc:

Dolphin Model	Battery Model No.	Battery Part No.	Battery Specification
Dolphin 75e	70e-BTSC	BAT-STANDARD-02	Li-ion 3.7V, 6.179 watt hour
	70e-BTEC	BAT-EXTENDED-02	Li-ion 3.7V, 12.358 watt hour



We recommend use of Honeywell peripherals, power cables, and power adapters. Use of any non-Honeywell peripherals, cables, or power adapters may cause damage not covered by the warranty.

Unpacking the ChargeBase

Open the shipping box and inspect the package to see that the following standard items are included:

- One Dolphin ChargeBase, model 70e-CB
- One power supply (see [Power](#) on page 12-3)
- One power cord

These items are needed to operate the ChargeBase. If any items are missing or anything appears to be damaged, contact your Customer Account Representative. Keep the original packaging in case you need to return the ChargeBase for service or to store the ChargeBase while not in use.

Charging Overview

The base supplies power to the intelligent battery charging system in all Dolphin terminals, which senses when a full charge has been achieved and switches to a trickle charge to maintain the full charge. As battery packs charge, the charging circuitry follows the two-step charging process (CC-CV) that is recommended for the battery type. The process monitors changes in temperature, current, and voltage. The main battery of each terminal charges in 4 hours for the standard battery or 6 hours for the extended battery.

Note: Before attempting to use, charge, or replace the battery in the terminal, you should read the [Guidelines for Battery Pack Use and Disposal](#) on page 3-11.



We recommend use of Honeywell Li-ion battery packs. Use of any non-Honeywell battery may result in damage not covered by the warranty.

Convenient Storage

The intelligent battery charging system makes this base a safe and convenient storage receptacle for your Dolphin terminal.

Capacity

The base holds up to four Dolphin terminals. Each charging well charges each terminal independently of the other wells.

Dimensions

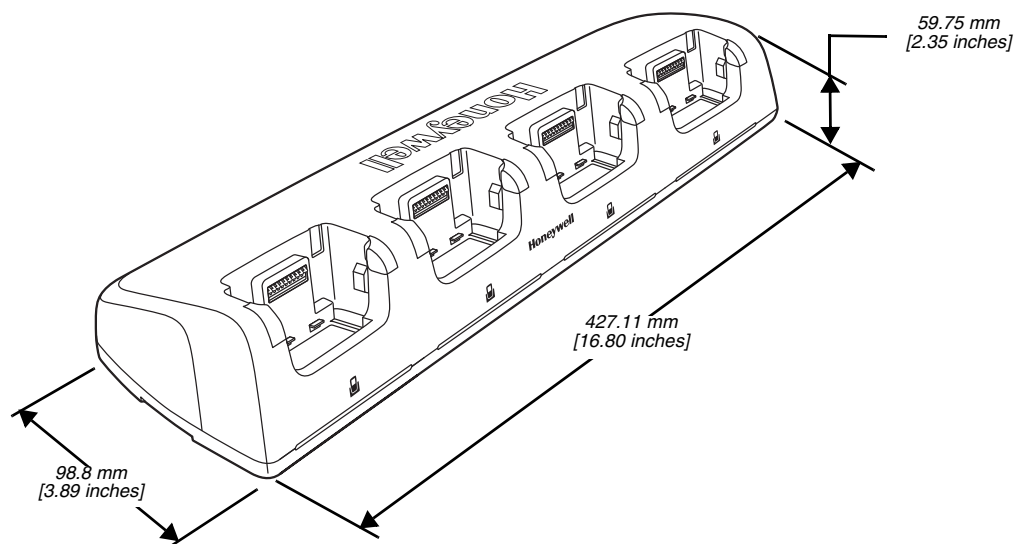

Weight

ChargeBase weight: 674g [1.49 lbs.]

Note: Weight excludes packaging, cables and power supply.

Parts and Functions

Front Panel

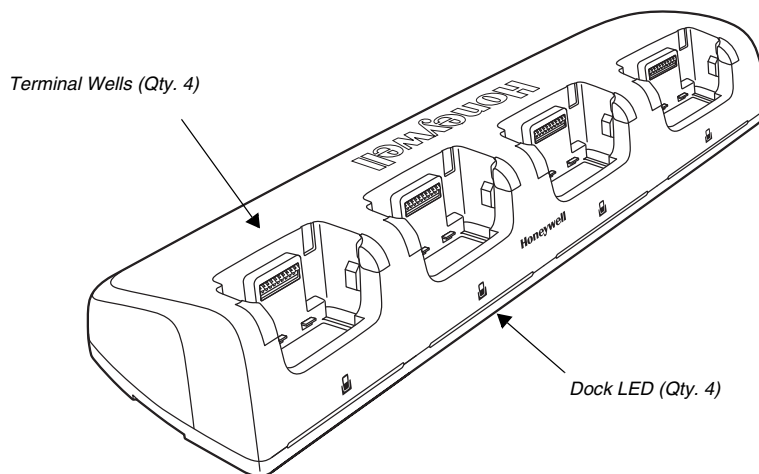

Terminal Wells

The base contains four terminal wells, which offer independent battery charging for each docked terminal.

Dock LEDs

The Dock LED indicates if the terminal is properly seated in the charging well. Each well has a dedicated Dock LED, which illuminates blue when a terminal is properly seated in the charging well.

Back Panel

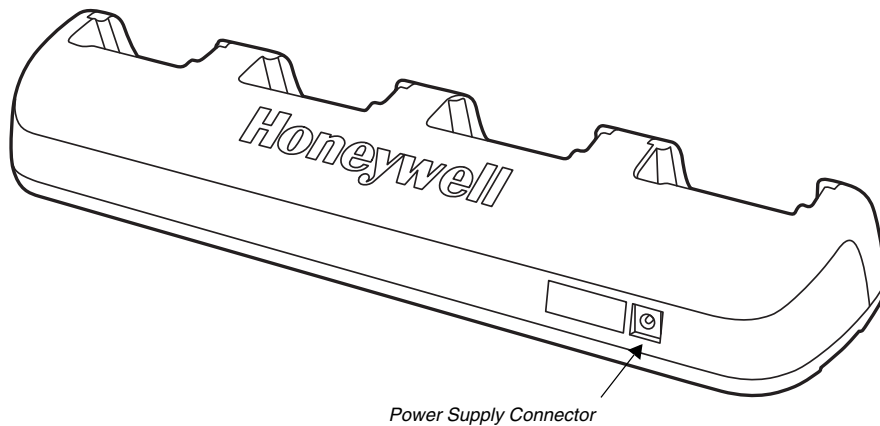

Power Supply Connector

This connector receives input from the power adapter. Plug the power connector cable from the power adapter into this connector.

Bottom Panel

For details on how to mount the base, see [Mounting the ChargeBase](#) on page 12-4.

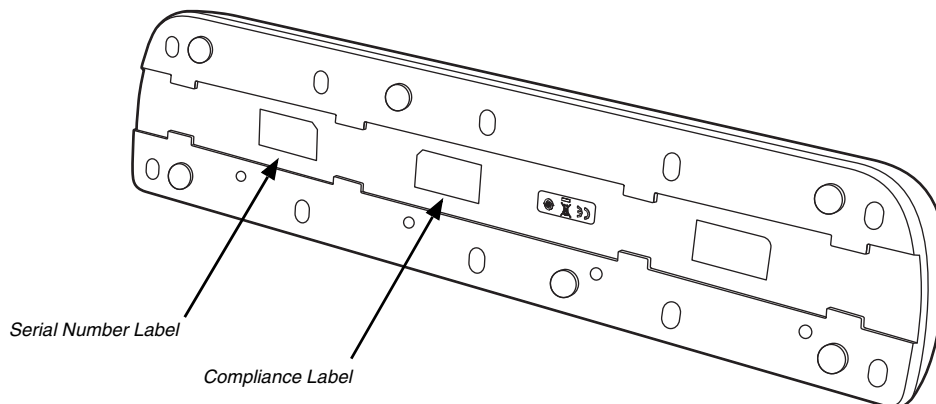

Power

The terminal requires 12 Volts DC input for battery charging and power output to the terminal. The power adapter included with the base, converts the voltage from the AC power source to 12 volts DC. **Use only a UL Listed power supply, which has been qualified by Honeywell with output rated at 12VDC and 5 amps with the device.** The operating temperature range is -10° to 50°C (14° to 122°F).

Honeywell recommends that you leave the ChargeBase connected to its power source at all times, so that it is always ready to use.



We recommend use of Honeywell peripherals, power cables, and power adapters. Use of any non-Honeywell peripherals, cables, or power adapters may cause damage not covered by the warranty.

Connecting Power to the ChargeBase

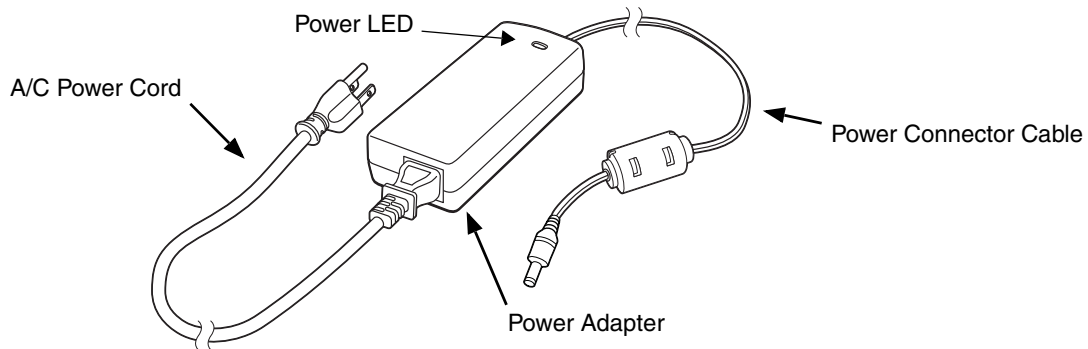

1. Plug the A/C power cord into the power adapter.
2. Plug the power cable into the power connector on the back of the ChargeBase.
3. Plug the A/C power cord into a grounded power source.
4. The base is ready to begin charging terminals.

Charging the Main Battery

The base provides power to the Dolphin terminals and allows charging of the batteries in the terminals. The battery of each terminal charges in 4 hours for the standard battery or 6 hours for the extended battery. The intelligent battery charging system incorporated into all Dolphin terminals prevents overcharging, which means that Dolphin terminals may be seated in the base indefinitely without damage to the terminals, batteries, or the base.



For more information about Honeywell battery packs and how to check battery power level in your terminal, refer to [Battery](#) (page 3-8).

To Power a Terminal and Charge its Main Battery



Ensure all components are dry prior to mating terminals/batteries with peripheral devices. Mating wet components may cause damage not covered by the warranty.

1. Install the battery in the terminal, see [Install the Battery](#) on page 2-1.
2. Insert the Dolphin terminal into one of the four terminal wells. The Dock LED for the well illuminates blue. Charging begins immediately if required by the Dolphin terminal.

Note: When the terminal is docked, the Battery Icon changes from  to  indicating the terminal is running on external power. Battery charging occurs in the background. When the Dolphin is removed from the base, the battery icon indicates the charge level of the battery, see [Common Status and Notification Icons](#) on page 2-6.



We recommend use of Honeywell Li-ion battery packs. Use of any non-Honeywell battery may result in damage not covered by the warranty.

Mounting the ChargeBase

Set the base on a dry, stable surface, such as a desktop or workbench near an electrical outlet. Be sure to provide enough workspace with good lighting for the user to view and operate the Dolphin terminal while it is in the base. When choosing a location, keep in mind that the mounting location must allow users to see the LEDs and provide easy access to the terminal wells and the power jack.

Bottom Panel

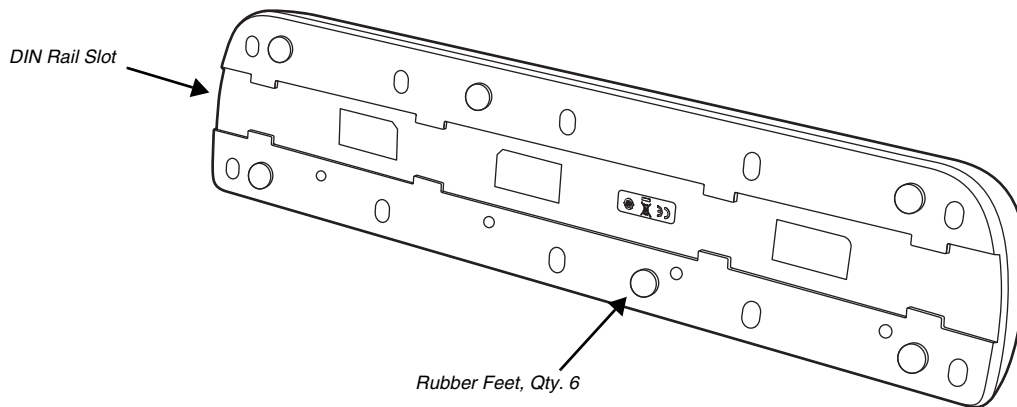

Optional DIN Rail Mount

A DIN rail (7.5 X 35 mm) may be installed on the bottom of the base to provide the optional security of mounting the base to a flat horizontal surface with hardware.

Additional Hardware

- DIN Rail, Qty. 1
- 3/16 in. dia x 5/8 in. long pan head screw, Qty. 2
- 1/2 in. OD x 7/32 in. ID x 3/64 in. thick washer, Qty. 4
- 3/16 in. dia nut, Qty. 2

Note: The items listed above are for reference only. Final hardware selection is dependent on the material type and thickness of the mounting surface.

Installing the DIN Rail

1. Slide the DIN Rail into the DIN Rail slot on the bottom panel of the base.

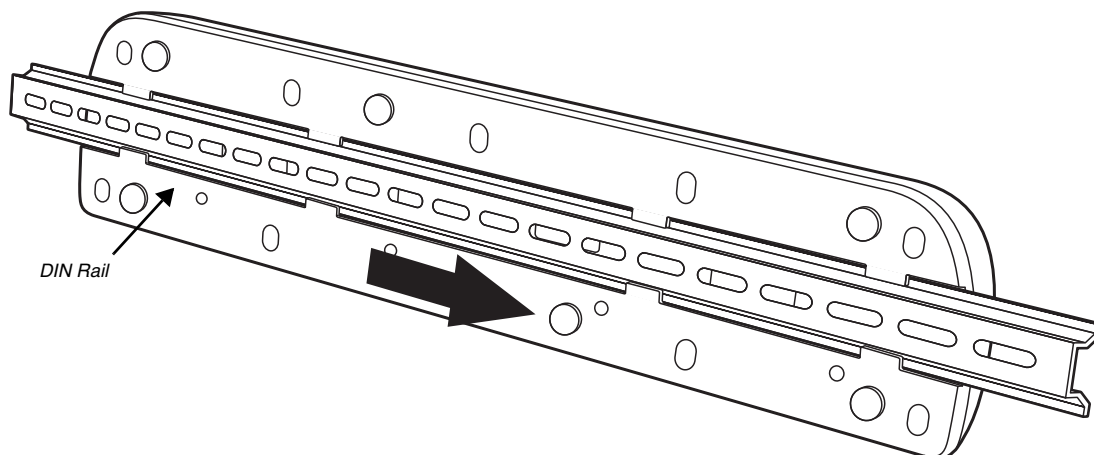

2. Turn the base and DIN Rail right side up.
3. Use the appropriate hardware to secure the DIN Rail to a stable, flat horizontal surface.

Dolphin 70e Black Net Base (Model 70e-NB)

Overview

The Net Base enables up to four Dolphin 75e handheld computers to communicate with a host device over an Ethernet network. In addition, the Net Base provides a second RJ45 Ethernet port for connection to an additional device such as a printer, workstation, Net Base, or another Net Base.

The 70e-NB charger is designed for use with the following Dolphin models and batteries manufactured for Honeywell International Inc:

Dolphin Model	Battery Model No.	Battery Part No.	Battery Specification
Dolphin 75e	70e-BTSC	BAT-STANDARD-02	Li-ion 3.7V, 6.179 watt hour
	70e-BTEC	BAT-EXTENDED-02	Li-ion 3.7V, 12.358 watt hour



We recommend use of Honeywell peripherals, power cables, and power adapters. Use of any non-Honeywell peripherals, cables, or power adapters may cause damage not covered by the warranty.

Unpacking the Net Base

Open the shipping box and inspect the package to see that the following standard items are included:

- One Dolphin Net Base Ethernet cradle, model 70e-NB
- One power supply (see [Power](#) on page 13-4)
- One power cord

These items are needed to set up and operate the Net Base. If any items are missing or anything appears to be damaged, contact your Customer Account Representative. Keep the original packaging in case you need to return the Net Base for service or to store the Net Base while not in use.

Optional Equipment

A standard CAT-5 Ethernet network cable is required when using the Net Base for communication between the terminal(s) and a host device over an Ethernet network.

Charging Overview

The base supplies power to the intelligent battery charging system in all Dolphin terminals, which senses when a full charge has been achieved and switches to a trickle charge to maintain the full charge. As battery packs charge, the charging circuitry follows the two-step charging process (CC-CV) that is recommended for the battery type. The process monitors changes in temperature, current, and voltage. The main battery of each terminal charges in 4 hours for the standard battery or 6 hours for the extended battery.

Note: Before attempting to use, charge, or replace the battery in the terminal, you should read the [Guidelines for Battery Pack Use and Disposal](#) on page 3-11.



We recommend use of Honeywell Li-ion battery packs. Use of any non-Honeywell battery may result in damage not covered by the warranty.

Convenient Storage

The intelligent battery charging system makes this base a safe and convenient storage receptacle for your Dolphin terminal.

Capacity

The base holds up to four Dolphin terminals. Each charging well charges each terminal independently of the other wells.

Dimensions

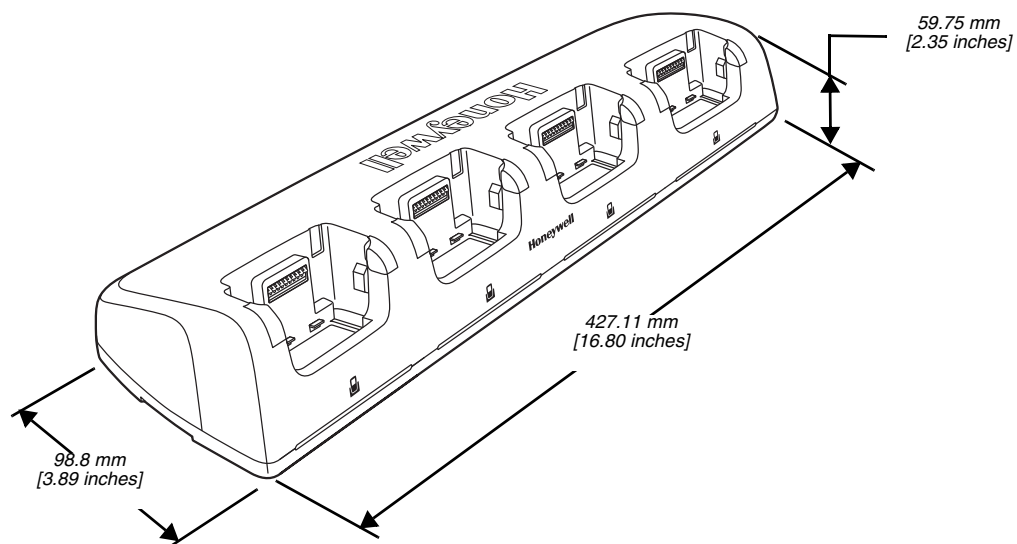

Weight

Net Base weight: 694g [1.53 lbs.]

Note: Weight excludes packaging, cables and power supply.

Parts and Functions

Front Panel

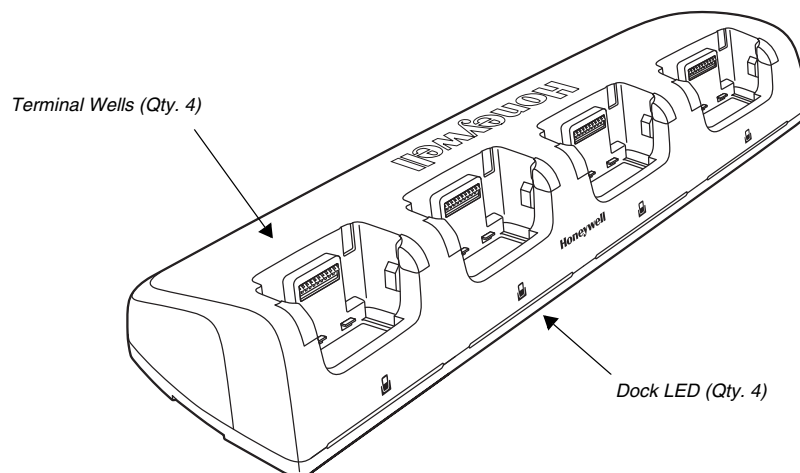

Terminal Wells

The base contains four terminal wells, which offer independent battery charging for each docked terminal.

DOCK LEDs

The Dock LED indicates if the terminal is properly seated in the charging well. Each well has a dedicated Dock LED, which illuminates blue when a terminal is properly seated in the charging well.

Back Panel

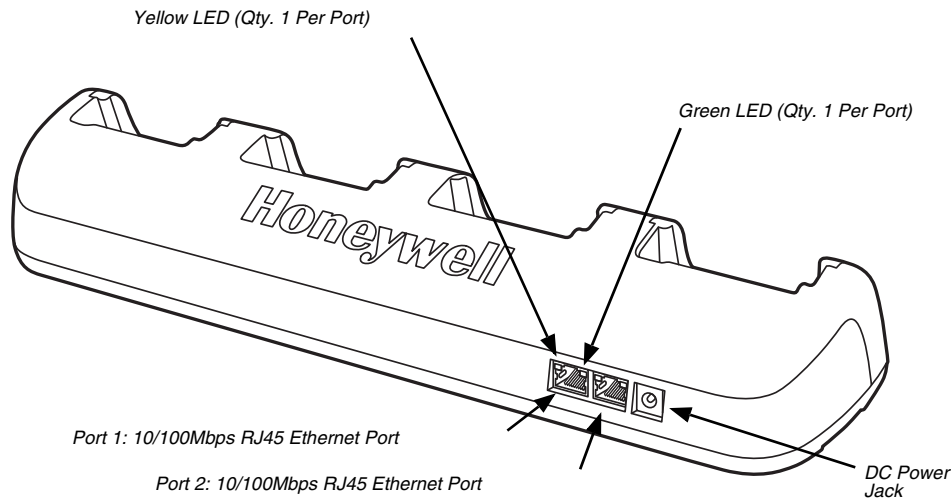

RJ45 Ethernet Ports

The Net Base contains two RJ45 Ethernet ports. You can connect the Net Base to an Ethernet-compliant device to facilitate Ethernet communication to and from the terminal by plugging a standard CAT-5 Ethernet cable into one of the two Ethernet ports provided. The second RJ45 Ethernet port can be used for connection to an additional device such as a printer, workstation, eBase, or another Net Base.

Note: The Net Base does not use a Spanning Tree Protocol (STP). When both RJ45 Ethernet ports are used, do not connect both Net Base interfaces to the same layer 2 LAN.

Each Ethernet port has a dedicated green and yellow status LED.

Status	Yellow LED	Green LED
No Ethernet Link	Off	Off
10Mbps Ethernet Connection Established	Off	On
100Mbps Ethernet Connection Established	On	On
Data transfer in progress	Connection Speed Dependent (see above)	Flashing

Note: The terminal and Ethernet link must be set up properly to allow the terminal to communicate to other devices and/or the Internet. For more information, see [Establishing Ethernet Communication](#) on page 13-5.

DC Power Jack

This connector receives input from the power adapter. Plug the power connector cable from the power adapter into this connector, see [Power](#).

Bottom Panel

For details on how to mount the base, see [Mounting the Net Base](#) on page 13-6.

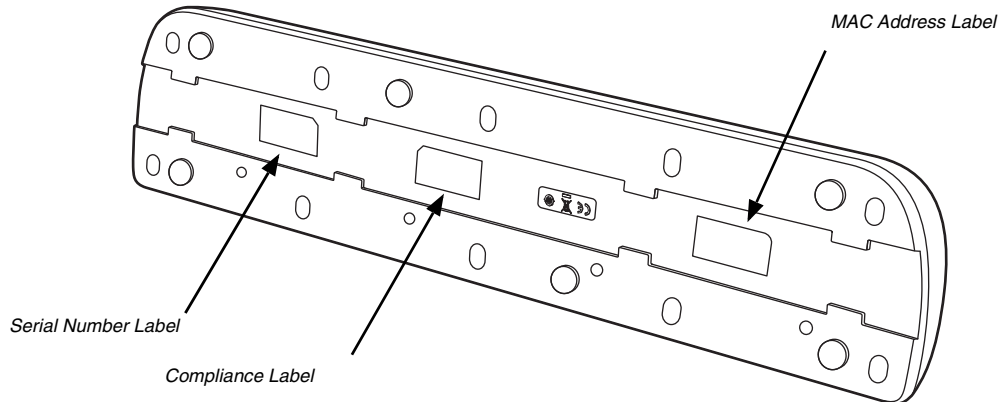

Power

The terminal requires 12 Volts DC input for battery charging and power output to the terminal. The power adapter included with the base, converts the voltage from the AC power source to 12 volts DC. **Use only a UL Listed power supply, which has been qualified by Honeywell with output rated at 12VDC and 5 amps with the device.** The operating temperature range is -10° to 50°C (14° to 122°F).

Honeywell recommends that you leave the Net Base connected to its power source at all times, so that it is always ready to use.



We recommend use of Honeywell peripherals, power cables, and power adapters. Use of any non-Honeywell peripherals, cables, or power adapters may cause damage not covered by the warranty.

Connecting Power to the Net Base

1. Plug the A/C power cord into the power adapter.
2. Plug the power cable into the power connector on the back of the Net Base.
3. Plug the A/C power cord into a grounded power source.
4. The base is ready to begin charging terminals.

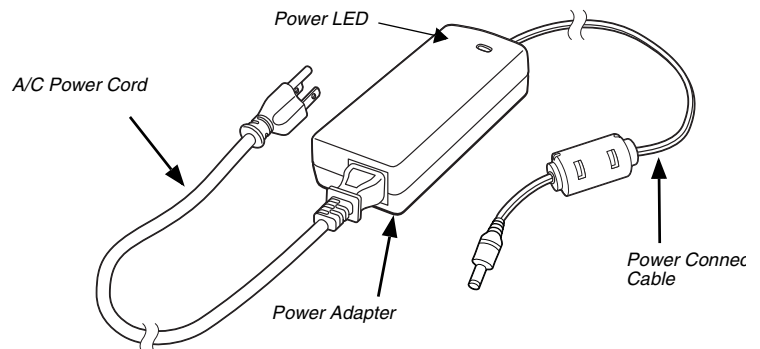

Charging the Main Battery

The base provides power to the Dolphin terminals and allows charging of the batteries in the terminals. The battery of each terminal charges in 4 hours for the standard battery or 6 hours for the extended battery. The intelligent battery charging system incorporated into all Dolphin terminals prevents overcharging, which means that Dolphin terminals may be stored in the base indefinitely without damage to the terminals, battery packs, or the base.



For more information about Honeywell battery packs and how to check battery power levels in your terminal, refer to [Battery](#) (page 3-8).

To Power a Terminal and Charge the Main Battery



Ensure all components are dry prior to mating terminals/batteries with peripheral devices. Mating wet components may cause damage not covered by the warranty.

1. Install the battery in the terminal, see page 2-1.
2. Slide the Dolphin terminal into one of the four terminal wells. The Dock LED for the well illuminates blue. Charging begins immediately if required by the Dolphin terminal.

Note: When the terminal is docked, the Battery Icon changes from  to  indicating the terminal is running on external power. Battery charging occurs in the background. When the Dolphin is removed from the base, the battery icon indicates the charge level of the battery, see [Common Status and Notification Icons](#) on page 2-6.







We recommend use of Honeywell Li-ion battery packs. Use of any non-Honeywell battery may result in damage not covered by the warranty.

Communication

Establishing Ethernet Communication

Connecting the Dolphin Terminal to the Net Base

By default, the Dolphin terminal is configured to obtain IP addresses automatically via DHCP server. This means that in most cases you would simply plug-and-play the unit.



1. Connect power to the Net Base (see [Power](#) on page 13-4).
2. Plug the CAT-5 Ethernet cable into the RJ45 connector on the back of the Net Base.
3. Plug the Ethernet cable into the network.
4. Insert the Dolphin into the terminal well. The Dock LED for the well illuminates blue.
5. Touch **All Apps**  > **Settings**  > **Ethernet configuration**.
6. Check the box to **Turn on Ethernet**. When an Ethernet connection is established the status icon changes from  to  at the top of the screen.

Troubleshooting

If the items on the Ethernet configuration screen are grayed out and not accessible, verify the base has power, the Ethernet cable is undamaged and properly installed to the base, there is an active network signal over the Ethernet cable, and the terminal is properly docked in the base.



Ethernet Configuration Settings

Instead of using the default DHCP assigned IP address, the Dolphin terminal can be configured to use a statically assigned IP address.

1. Touch **All Apps**  > **Settings**  > **Ethernet configuration**.
2. Select **Ethernet configuration**, again.
3. Select **Static IP** under “Connection Type”, then input the **IP address** and any additional information based on your network configuration.
4. Touch **Save**.

Ethernet Proxy Settings

To set up a proxy to use when accessing your network with Ethernet:

1. Touch **All Apps**  > **Settings**  > **Ethernet proxy settings**.
2. Input the **Proxy host name** and **Proxy port**. If required, designate when to bypass the proxy.
3. Select **Done**.

Displaying the Net Base and Terminal IP Address

Once the Dolphin terminal has been successfully connected to the network through Net Base, the terminal uses the Net Base IP address. The IP address can be used by any application on the Dolphin terminal.

Touch **All Apps**  > **Settings**  > **About Phone** > **Status** to view the assigned IP Address.

Mounting the Net Base

Set the Net Base on a dry, stable surface, such as a desktop or workbench near an electrical outlet. Be sure to provide enough workspace with good lighting for the user to view and operate the Dolphin terminal while it is in the Net Base. When choosing a location, bear in mind that the mounting location must allow users to see the LEDs and provide easy access to the terminal wells, the Ethernet ports, and the power jack.

Bottom Panel

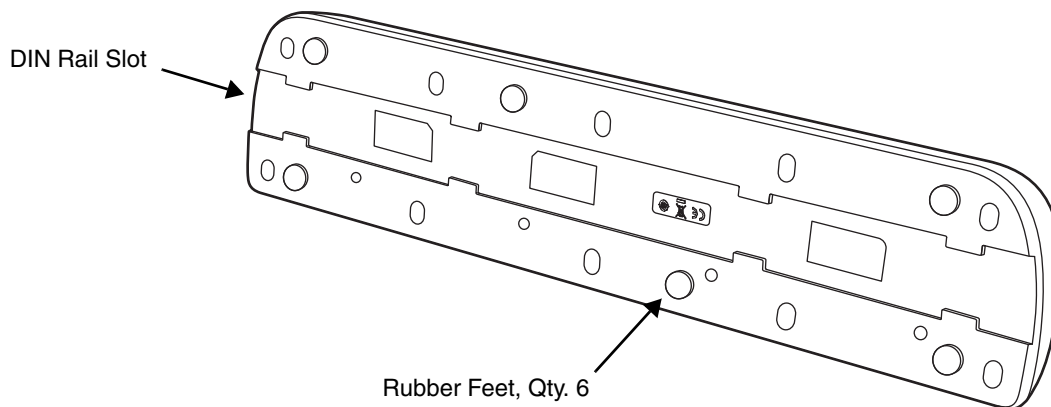

Optional DIN Rail Mount

A DIN rail (7.5 X 35 mm) may be installed on the bottom of the base to provide the optional security of mounting the base to a flat horizontal surface with hardware.

Additional Hardware

- DIN Rail, Qty. 1
- 3/16 in. dia x 5/8 in. long pan head screw, Qty. 2
- 1/2 in. OD x 7/32 in. ID x 3/64 in. thick washer, Qty. 4
- 3/16 in. dia nut, Qty. 2

Note: The items listed above are for reference only. Final hardware selection is dependent on the material type and thickness of the mounting surface.

Installing the DIN Rail

1. Slide the DIN Rail into the DIN Rail slot on the bottom panel of the base.

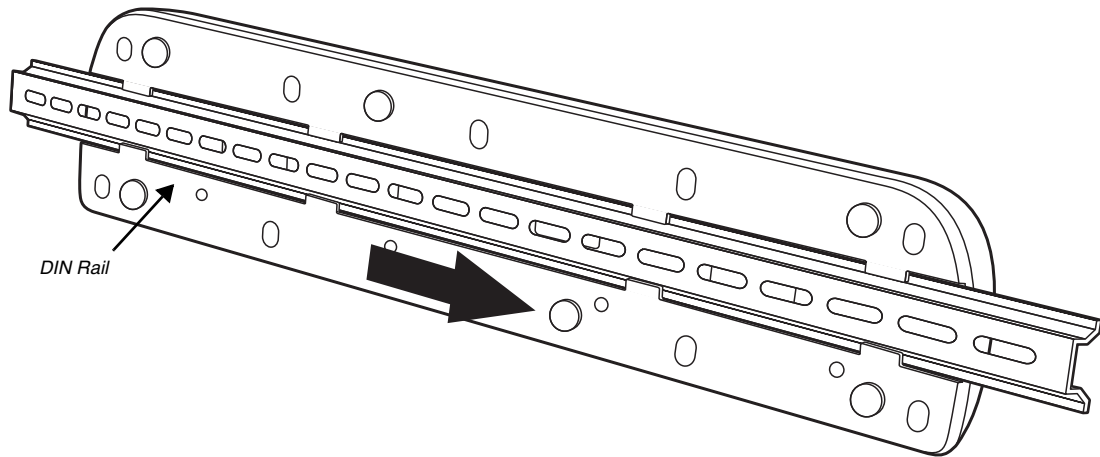

2. Turn the base and DIN Rail right side up.
3. Use the appropriate hardware to secure the DIN Rail to a stable, flat horizontal surface.

Customer Support

Product Service and Repair

Honeywell International Inc. provides service for all of its products through service centers throughout the world. To obtain warranty or non-warranty service, please visit www.honeywellaidc.com, and select **Support > Contact Service and Repair** to see your region's instructions on how to obtain a Return Material Authorization number (RMA #). You should do this prior to returning the product.

For ongoing and future product quality improvement initiatives, the terminal comes equipped with an embedded device lifetime counter function. Honeywell may use the lifetime counter data for future statistical reliability analysis as well as ongoing quality, repair and service purposes.

Technical Assistance

If you need assistance installing or troubleshooting your device, please contact us by using one of the methods below:

Knowledge Base: www.hsmknowledgebase.com

Our Knowledge Base provides thousands of immediate solutions. If the Knowledge Base cannot help, our Technical Support Portal (see below) provides an easy way to report your problem or ask your question.

Technical Support Portal: www.hsmsupportportal.com

The Technical Support Portal not only allows you to report your problem, but it also provides immediate solutions to your technical issues by searching our Knowledge Base. With the Portal, you can submit and track your questions online and send and receive attachments.

Web form: www.hsmcontactsupport.com

You can contact our technical support team directly by filling out our online support form. Enter your contact details and the description of the question/problem.

Telephone: www.honeywellaidc.com/locations

For our latest contact information, please check our website at the link above.

Warranty Disclaimer: Proper Use of a Touch Screen Mobile Device

If your device has a touch screen display, please note that a touch screen responds best to a light touch from the pad of your finger or a Honeywell approved stylus. Using excessive force or a metallic object when pressing on the touch-screen may cause damage to the tempered glass surface and may not be covered by the product's warranty.

Limited Warranty

Honeywell International Inc. ("HII") warrants its products and optional accessories to be free from defects in materials and workmanship and to conform to HII's published specifications applicable to the products purchased at the time of shipment. This warranty does not cover any HII product which is (i) improperly installed or used; (ii) damaged by accident or negligence, including failure to follow the proper maintenance, service, and cleaning schedule; or (iii) damaged as a result of (A) modification or alteration by the purchaser or other party, (B) excessive voltage or current supplied to or drawn from the interface connections, (C) static electricity or electro-static discharge, (D) operation under conditions beyond the specified operating parameters, or (E) repair or service of the product by anyone other than HII or its authorized representatives.

This warranty shall extend from the time of shipment for the duration published by HII for the product at the time of purchase ("Warranty Period"). Any defective product must be returned (at purchaser's expense) during the Warranty Period to HII factory or authorized service center for inspection. No product will be accepted by HII without a Return Materials Authorization, which may be obtained by contacting HII. In the event that the product is returned to HII or its authorized service center within the Warranty Period and HII determines to its satisfaction that the product is defective due to defects in materials or workmanship, HII, at its sole option, will either repair or replace the product without charge, except for return shipping to HII.

EXCEPT AS MAY BE OTHERWISE PROVIDED BY APPLICABLE LAW, THE FOREGOING WARRANTY IS IN LIEU OF ALL OTHER COVENANTS OR WARRANTIES, EITHER EXPRESSED OR IMPLIED, ORAL OR WRITTEN, INCLUDING, WITHOUT LIMITATION, ANY IMPLIED WARRANTIES OF MERCHANTABILITY OR FITNESS FOR A PARTICULAR PURPOSE, OR NON-INFRINGEMENT.

HII'S RESPONSIBILITY AND PURCHASER'S EXCLUSIVE REMEDY UNDER THIS WARRANTY IS LIMITED TO THE REPAIR OR REPLACEMENT OF THE DEFECTIVE PRODUCT WITH NEW OR REFURBISHED PARTS. IN NO EVENT SHALL HII BE LIABLE FOR INDIRECT, INCIDENTAL, OR CONSEQUENTIAL DAMAGES, AND, IN NO EVENT, SHALL ANY LIABILITY OF HII ARISING IN CONNECTION WITH ANY PRODUCT SOLD HEREUNDER (WHETHER SUCH LIABILITY ARISES FROM A CLAIM BASED ON CONTRACT, WARRANTY, TORT, OR OTHERWISE) EXCEED THE ACTUAL AMOUNT PAID TO HII FOR THE PRODUCT. THESE LIMITATIONS ON LIABILITY SHALL REMAIN IN FULL FORCE AND EFFECT EVEN WHEN HII MAY HAVE BEEN ADVISED OF THE POSSIBILITY OF SUCH INJURIES, LOSSES, OR DAMAGES. SOME STATES, PROVINCES, OR COUNTRIES DO NOT ALLOW THE EXCLUSION OR LIMITATIONS OF INCIDENTAL OR CONSEQUENTIAL DAMAGES, SO THE ABOVE LIMITATION OR EXCLUSION MAY NOT APPLY TO YOU.

All provisions of this Limited Warranty are separate and severable, which means that if any provision is held invalid and unenforceable, such determination shall not affect the validity of enforceability of the other provisions hereof. Use of any peripherals not provided by the manufacturer may result in damage not covered by this warranty. This includes but is not limited to: cables, power supplies, cradles, and docking stations. HII extends these warranties only to the first end-users of the products. These warranties are non-transferable.

The limited duration of the warranty for the Dolphin 75e is as follows:

- The duration of the limited warranty for terminals with an integrated imager is one year.
- The duration of the limited warranty for touch screens is one year.
- The duration of the limited warranty for the Dolphin 70e Black HomeBase, Dolphin 70e Black eBase, Dolphin 70e Black Mobile Base, Dolphin 70e Black ChargeBase, Dolphin 70e Black Net Base and the Common QuadCharger is one year.
- The duration of the limited warranty for batteries is one year.
Use of any battery from a source other than Honeywell may result in damage not covered by the warranty. Batteries returned to Honeywell International Inc. in a reduced state may or not be replaced under this warranty. Battery life will be greatly increased when following the battery instructions in this user's guide.

How to Extend Your Warranty

Honeywell International Inc. offers a variety of service plans on our hardware products. These agreements offer continued coverage for your equipment after the initial warranty expires. For more information, contact your Sales Representative, Customer Account Representative, or Product Service Marketing Manager from Honeywell International Inc., or your Authorized Reseller.

Honeywell Scanning & Mobility

9680 Old Bailes Road

Fort Mill, SC 29707

www.honeywellaidc.com